

# 1.8V - 5.5V Input, 3.3V Output, High Efficiency DC/DC Converter

This document helps the user create a design-in a Stellaris® ARM® Cortex™-M3 MCU into a system requiring a wide-input voltage range and is concerned about maintaining high efficiency and long battery life. This particular design allows for an input voltage between 1.8 V to 5.5 V.

### Contents

1	Introduction .....	2
	1.1 Features .....	2
2	Requirements .....	2
3	Description of Power Solution .....	3
	3.1 Power Supply Option 1: TPS63031 .....	4
	3.2 Power Supply Option 2: TPS63001 .....	6
4	Inductor Selection .....	11
5	Capacitor Selection .....	12
	5.1 Input Capacitor .....	12
	5.2 Bypass Capacitor (TPS6303x only) .....	12
	5.3 Output Capacitor .....	12
6	General Layout Considerations .....	12
7	References .....	13

### List of Figures

1	TPS63030EVM-417 Schematic .....	4
2	Turn ON into Load, $V_{IN} = 2.2\text{ V}$ .....	5
3	Output Ripple, $V_{IN} = 2.2\text{ V}$ .....	5
4	PMP4778 Reference Design Schematic .....	6
5	Startup .....	7
6	Startup .....	7
7	Startup .....	7
8	Startup .....	7
9	Startup .....	7
10	Startup .....	7
11	Output Ripple Voltage .....	8
12	Output Ripple Voltage .....	8
13	Output Ripple Voltage .....	8
14	Load Transient .....	8
15	Load Transient .....	9
16	Load Transient .....	9
17	Switching Node Waveform .....	9
18	Switching Node Waveform .....	9
19	Switching Node Waveform .....	10
20	Efficiency vs Output Current .....	10

Cortex is a trademark of Texas Instruments.  
Stellaris, ARM are registered trademarks of Texas Instruments.

### List of Tables

1	Stellaris® ARM® Cortex™-M3 MCU Family Power Requirements .....	2
2	List of Materials TPS63030EVM-417 .....	5
3	List of Materials PMP4778 .....	6
4	TPS6303x List of Inductors .....	11
5	TPS6300x List of Inductors .....	11
6	Related Documents .....	13

## 1 Introduction

This reference design is for the Stellaris® ARM® Cortex™-M3 MCU family and accounts for voltage and current requirements, given below. The microcontrollers require only a single voltage supply, so no sequencing is needed. The operating input voltage for this reference design is between 1.8 V and 5.5 V, thus allowing users operating from a battery supply to benefit from the complete battery capacity. This design is optimized for wide-input voltage range, a small solution size and low component count.

For more information and other reference designs, see the [Reference section](#) at the end of this document or visit [www.ti.com/processorpower](http://www.ti.com/processorpower).

### 1.1 Features

- 1.8-V to 5.5-V input voltage range
- Fixed 3.3-V output eliminates need for external voltage-setting resistors
- The TPS63001 is capable of driving up to 800 mA when operating in boost mode
- The TPS63031 is capable of driving up to 500 mA when operating in boost mode
- High efficiency (up to 94%)
- Low quiescent current (less than 50  $\mu$ A)
- Small QFN packages: 2.5 mm x 2.5 mm (TPS63031) or 3 mm x 3 mm (TPS63001)

## 2 Requirements

The power requirements for each Stellaris® ARM® Cortex™-M3 MCU family are listed below.

For more information and other reference designs, visit [www.ti.com/processorpower](http://www.ti.com/processorpower).

**Table 1. Stellaris® ARM® Cortex™-M3 MCU Family Power Requirements<sup>(1)</sup>**

DEVICE FAMILY	PIN NAME(S)	VOLTAGE (V)	I <sub>MAX</sub> (mA)	TOLERANCE	SEQUENCING ORDER	TIMING DELAY	COMMENTS
LM3S100 series LM3S300 series LM3S600 series LM3S800 series LM3S1000 series LM3S2000 series LM3S3000 series LM3S5000 series	VDD	3.3	170	±10%	–	–	Internal regulator supplies power to device core
LM3S6000 series LM3S8000 series	VDD	3.3	225	±10%	–	–	Internal regulator supplies power to device core
LM3S9000 series	VDD	3.3	150	±10%	–	–	Internal regulator supplies power to device core
LM3S2B93 LM3S2B2793 LM3S5B91 LM3S5791	VDD	3.3	100	±10%	–	–	Internal regulator supplies power to device core

<sup>(1)</sup> The I<sub>MAX</sub> currents listed are "worst case" expected values.

### 3 Description of Power Solution

Using a buck-boost topology for battery driven applications enables users to fully benefit from the available charge given from the chemistry.

The described TPS630xx devices belong to a fully integrated family of converters, which regulate automatically the preset output voltage over the entire input voltage range of 1.8 V - 5.5 V.

For a fixed 3.3-V output, the converter operates in step-down mode for the time, where the input voltage is greater than 3.3 V. Once the input voltage undercuts the required 3.3-V, the converter automatically transitions into boost mode without the need of any external control signals or circuitry.

The buck-boost converter is based on a fixed frequency pulse-width-modulation (PWM) controller using synchronous rectification to obtain maximum efficiency. At low load currents the converter enters a Power Save mode to maintain high efficiency over a wide load current range. The Power Save mode can be disabled using the PS/SYNC pin, forcing the converter to operate at a fixed switching frequency.

During shutdown, the load is disconnected from the battery.

If the power budget of the TPS63001 is needed, but solution size is critical, see the TPS63011 with the available WCSP package.

### 3.1 Power Supply Option 1: TPS63031

TPS63031 supports 500 mA when operating in boost mode ( $V_{in} > 2.4V$ ) and greater 800 mA when working in step-down mode ( $V_{in} = 3.6 V$  to  $5.5 V$ ). The overall solution size, the entire efficiency as well as the provided power budget make the converter an ideal fit for portable, battery driven applications. For a more detailed description of the device characteristics as well as functionality, see to the device data sheet.

The device can be evaluated by itself using the evaluation module TPS63030EVM-417. The EVM contains by default the adjustable device TPS63030. In order to evaluate the 3.3 V version, replace the device U1 on the PCB with TPS63031. Furthermore, R1 must be replaced with a 0- $\Omega$  resistor; the R2 position remains open.

The following description as well as the results are taken from the TPS63030EVM-417 Users Guide.

#### 3.1.1 Schematic

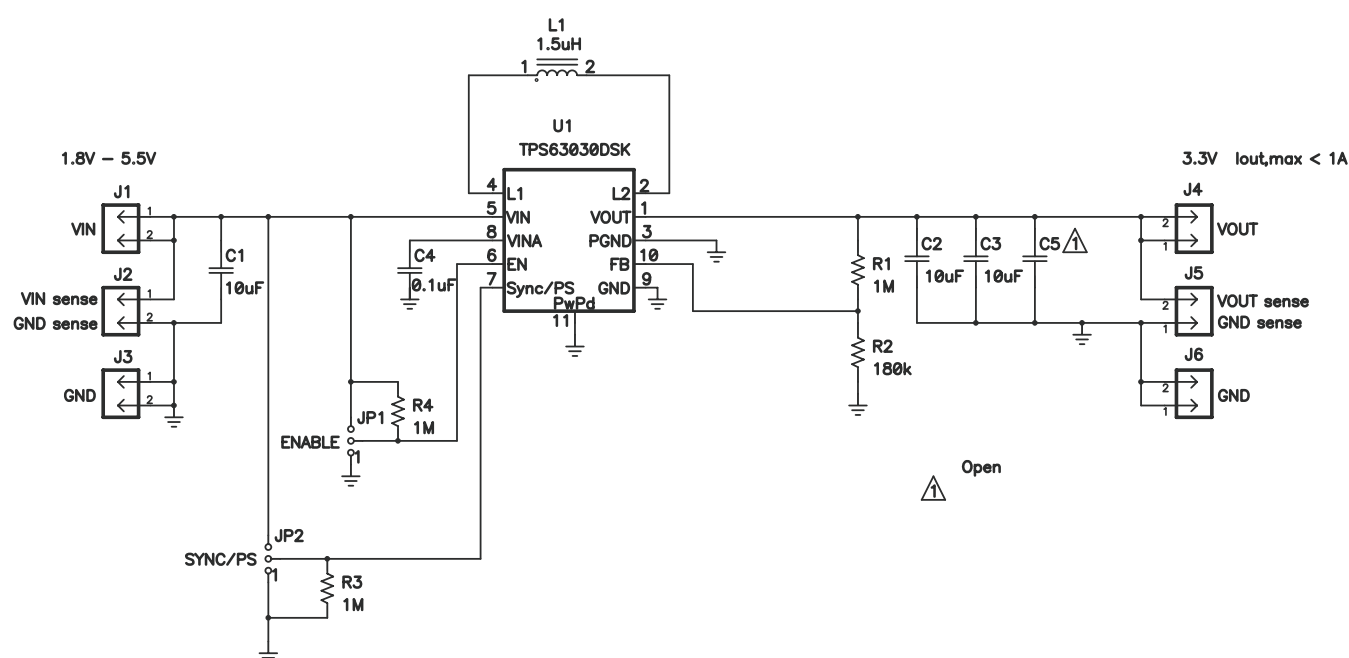

Figure 1. TPS63030EVM-417 Schematic

### 3.1.2 List of Materials TPS63030EVM-417

**Table 2. List of Materials TPS63030EVM-417**

QTY	REF DES	VALUE	DESCRIPTION	SIZE	PART NUMBER	MFR
3	C1, C2, C3	10 $\mu$ F	Capacitor, ceramic, 6.3-V, X7R, 10%	0603	GRM188R60J106ME84D	Murata
1	C4	0.1 $\mu$ F	Capacitor, ceramic, 6.3-V, X7R, 10%	0603	GRM188R70J104KA01B	Murata
0	C5	Open	Capacitor, ceramic, 6.3-V, X7R, 10%	0603	GRM188R60J106ME84D	Murata
1	L1	1.5 $\mu$ H	Inductor, SMT, 1.3-A, 110-m $\Omega$	0.118 x 0.118	LPS3015-152MLB	Coilcraft
3	R1, R3, R4	1 M $\Omega$	Resistor, chip, 1/16-W, 1%	0603	Std	Std
1	R2	180 k $\Omega$	Resistor, chip, 1/16-W, 1%	0603	Std	Std
1	U1		IC, dc/dc converter	DSK	TPS63030DSK	TI

### 3.1.3 Test Results TPS63031

Following results are all based on the TPS63030EVM-417 settings and just represent an example of the functionality and performance.

Figure 2 represents the device behavior during the start-up phase. Figure 3 demonstrates the small output ripple at a typical load of 150 mA.

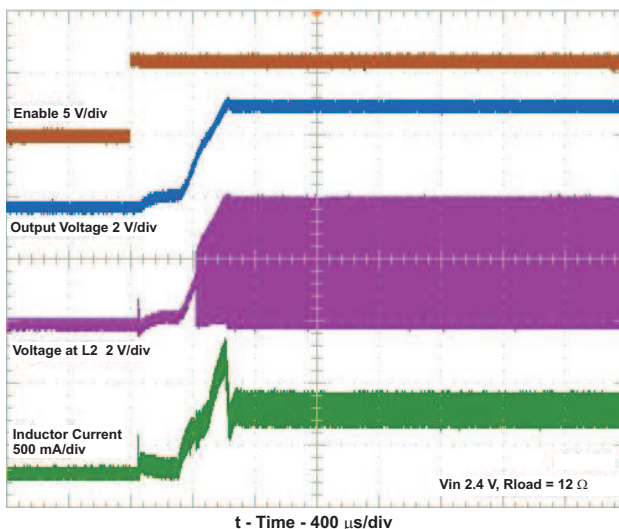
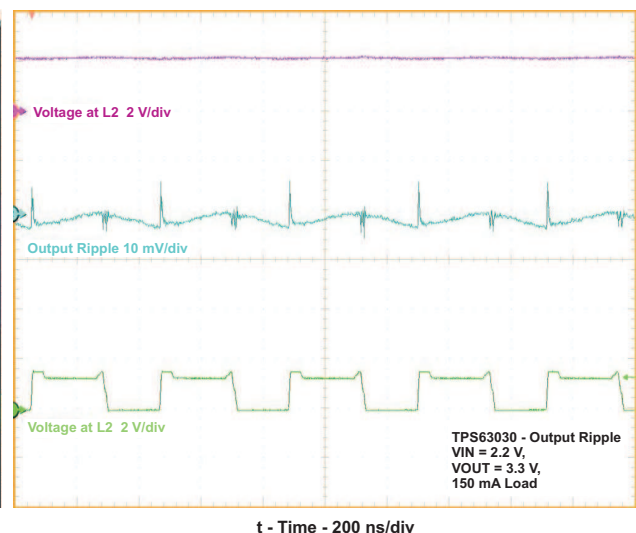
**Figure 2. Turn ON into Load,  $V_{IN} = 2.2$  V**

**Figure 3. Output Ripple,  $V_{IN} = 2.2$  V**

### 3.2 Power Supply Option 2: TPS63001

TPS63001 supports 800 mA when operating in boost mode ( $V_{in} > 2.4$  V) and greater 1200 mA when working in step-down mode ( $V_{in} = 3.6$  V to 5.5 V). The overall solution size, the entire efficiency as well as the provided power budget make the converter an ideal fit for portable, battery driven applications. For a more detailed description of the device characteristics as well as functionality, see the device data sheet.

The device can be evaluated by itself using the evaluation module TPS63000EVM-148. The EVM contains by default the adjustable device TPS63000. In order to evaluate the 3.3 V version, replace the device U1 on the PCB with TPS63001. Furthermore, R1 must be replaced with a 0- $\Omega$  resistor; the R2 position remains open.

The following description as well as the results are taken from the TPS63000EVM-148 Users Guide.

#### 3.2.1 Schematic

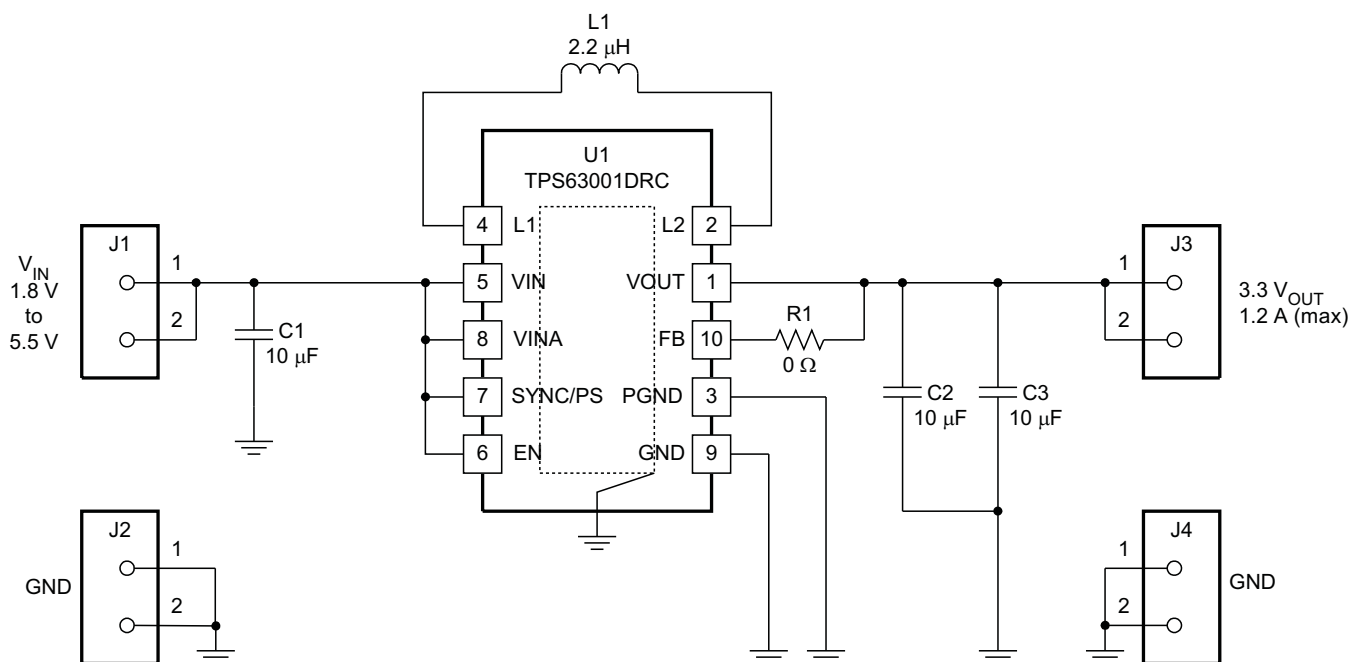

UDG-09083

**Figure 4. PMP4778 Reference Design Schematic**

#### 3.2.2 List of Materials PMP4778

**Table 3. List of Materials PMP4778**

REF DES	QTY	VALUE	DESCRIPTION	SIZE	PART NUMBER	MFR
C1, C2, C3	3	10 $\mu$ F	Capacitor, ceramic, 6.3V, X5R, 20%	0603	C1608X5R0J106M	TDK
L1	1	2.2 $\mu$ H	Inductor, SMT, 1.5A, 110 m $\Omega$	0.116" x 0.116"	LPS3015-222ML	Coilcraft
R1	1	0 $\Omega$	Resistor, chip, 1/16W, 1%	0603	Std	Std
U1	1		IC, buck-boost converter	QFN-10	TPS63001DRC	TI

### 3.2.3 Test Results TPS63001

The input and output startup waveforms are shown in Figure 5 through Figure 10. The output ripple voltages are shown in Figure 11 through Figure 13. Figure 14 through Figure 16 shows the transient responses. The switching node waveforms are shown in Figure 17 through Figure 19. The efficiency versus the output current is shown in Figure 20.

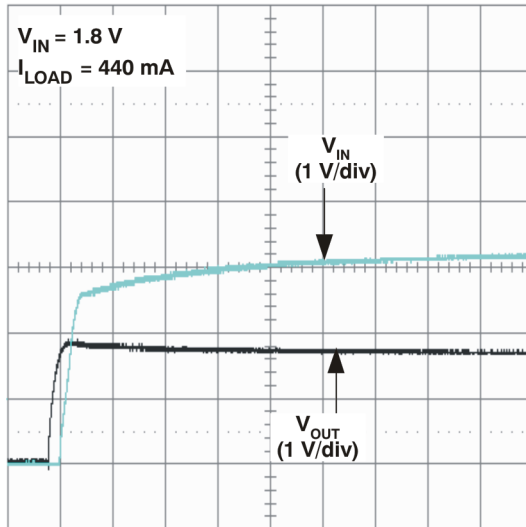

t – Time – 1 ms/div  
 Figure 5. Startup

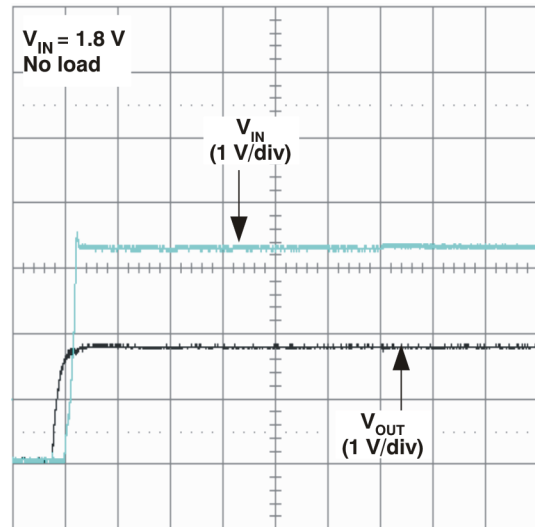

t – Time – 1 ms/div  
 Figure 6. Startup

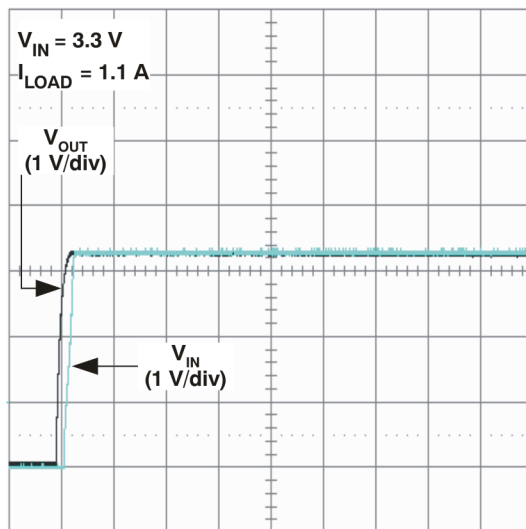

t – Time – 1 ms/div  
 Figure 7. Startup

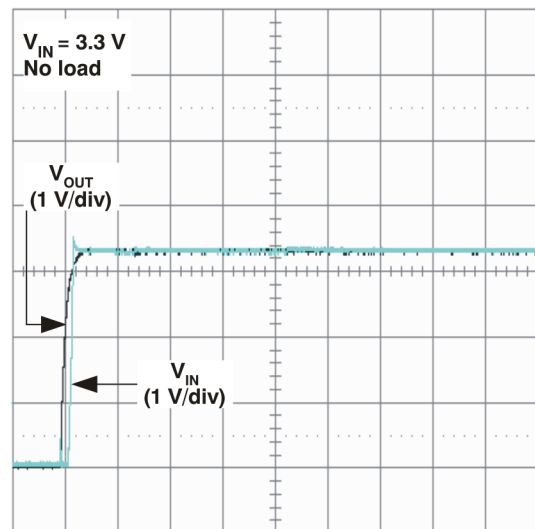

t – Time – 1 ms/div  
 Figure 8. Startup

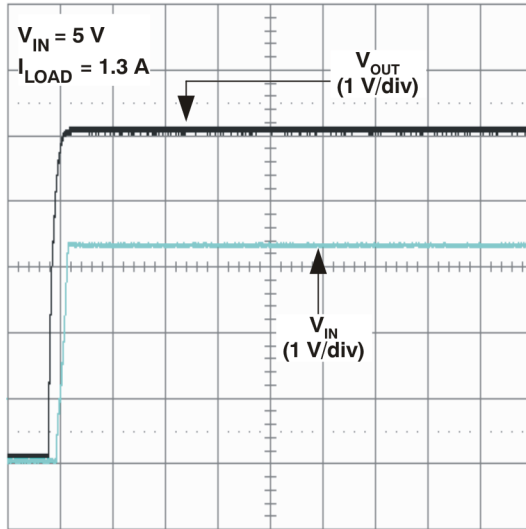

t – Time – 1 ms/div  
Figure 9. Startup

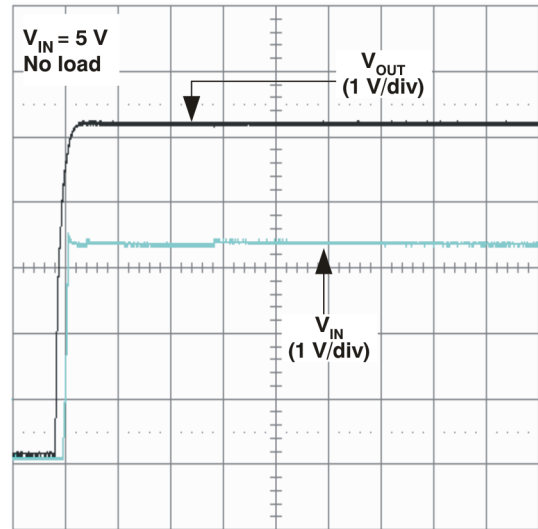
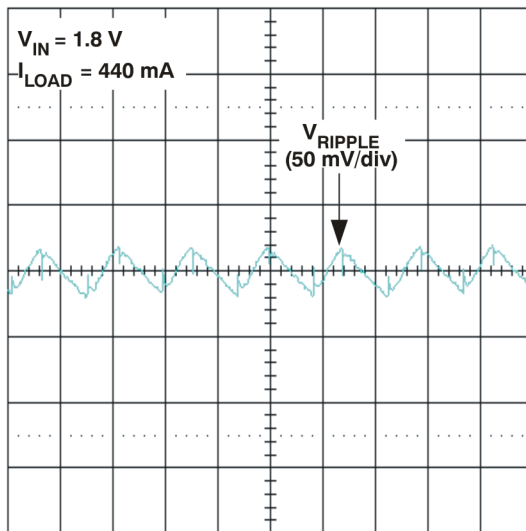
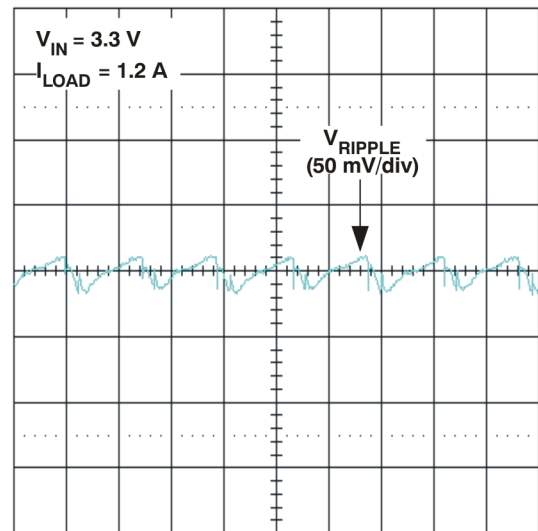

Figure 10. Startup



t – Time – 0.5 us/div  
Figure 11. Output Ripple Voltage



t – Time – 0.5 us/div  
Figure 12. Output Ripple Voltage



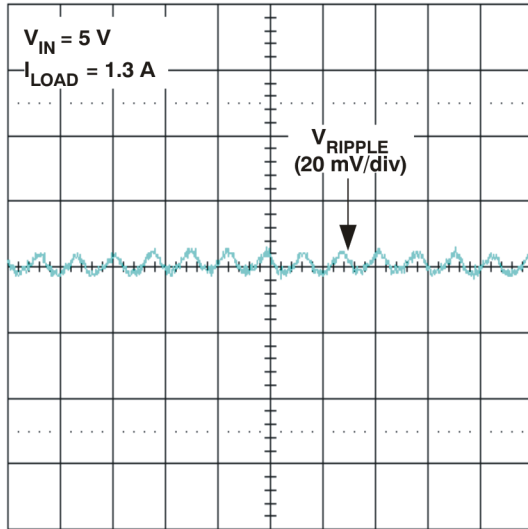

t – Time – 1 us/div

Figure 13. Output Ripple Voltage

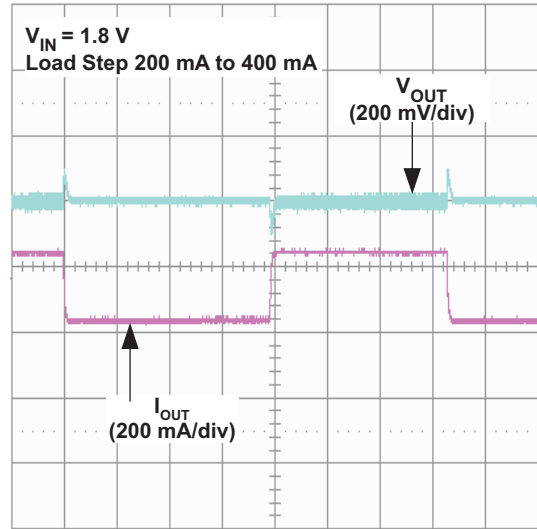

t – Time – 2 ms/div

Figure 14. Load Transient

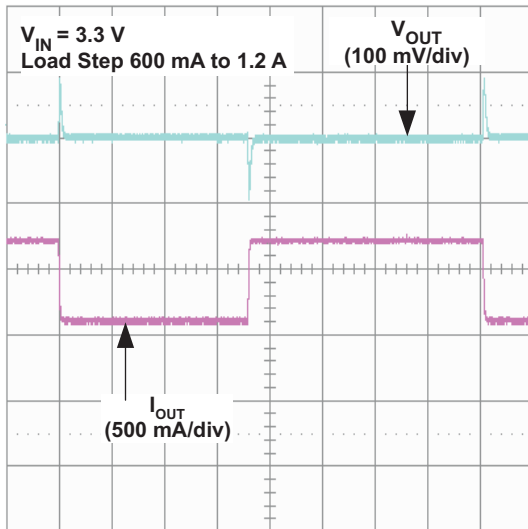

t – Time – 2 ms/div

Figure 15. Load Transient

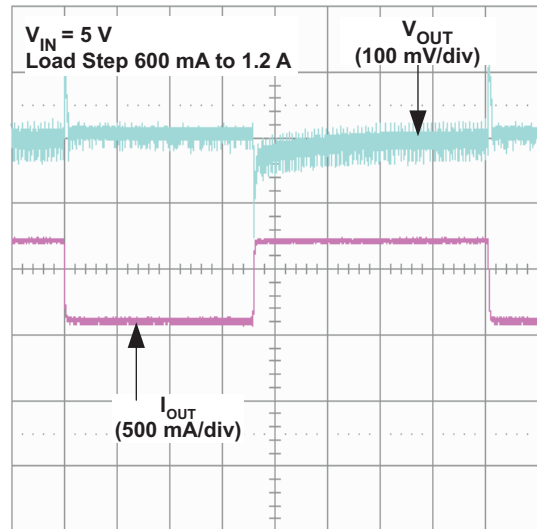

t – Time – 2 ms/div

Figure 16. Load Transient

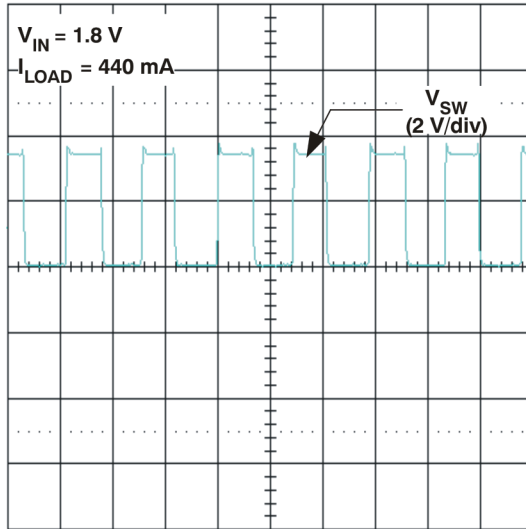

Figure 17. Switching Node Waveform

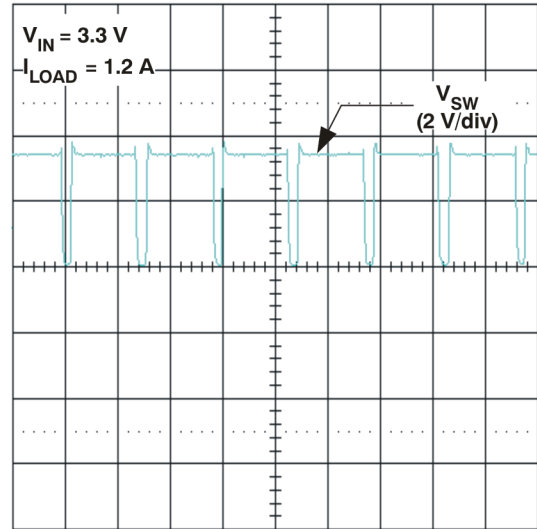

Figure 18. Switching Node Waveform

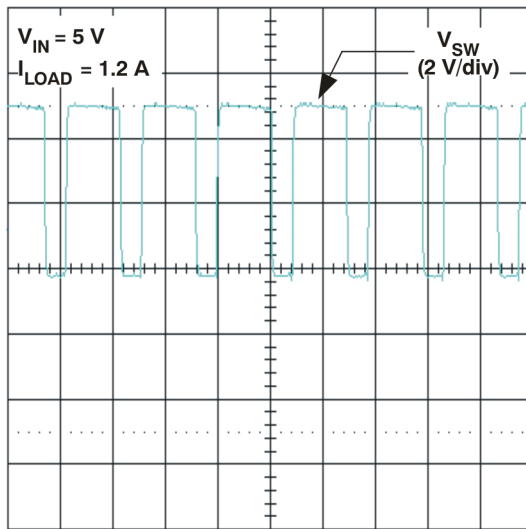

Figure 19. Switching Node Waveform

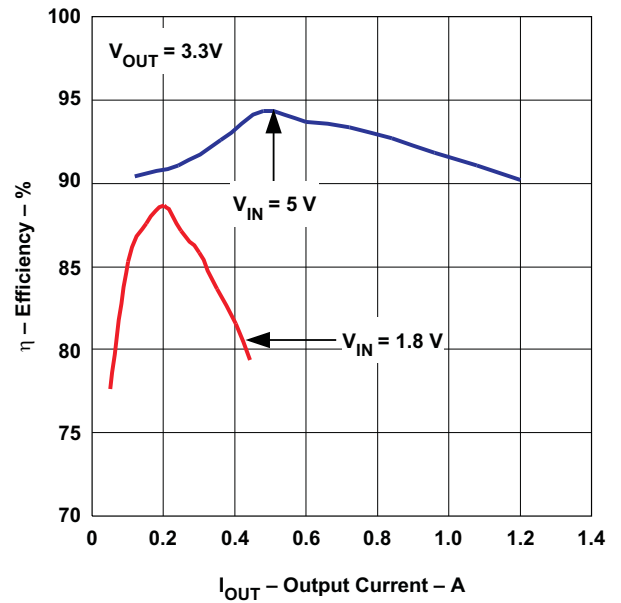

Figure 20. Efficiency vs Output Current

## 4 Inductor Selection

[Table 4](#) lists inductor series from different suppliers that have been used with TPS6303x converters.

[Table 5](#) lists inductor series from different suppliers that have been used with TPS6300x converters.

**Table 4. TPS6303x List of Inductors**

VENDOR	INDUCTOR SERIES
Coilcraft	LP3015
	EPL3010
Murata	LQH3NP
Taiyo Yuden	NR3015

**Table 5. TPS6300x List of Inductors**

VENDOR	INDUCTOR SERIES
Coilcraft	LP3015
	LP4012
Murata	LQH3NP
Taiyo Yuden	NR3015
TDK	VLF3215
	VLF4012

For a more detailed description of how to configure the inductor based on the individual needs, see the related device data sheets.

## 5 Capacitor Selection

### 5.1 Input Capacitor

A minimum effective value of 4.7  $\mu\text{F}$  for input capacitor is recommended to improve transient behavior of the regulator and EMI behavior of the total power supply circuit. A ceramic capacitor placed as close as possible to the VIN and PGND pins of the device is recommended.

### 5.2 Bypass Capacitor (TPS6303x only)

To make sure that the internal control circuits are supplied with a stable low noise supply voltage, a capacitor can be connected between VINA and GND. Using a ceramic capacitor with a value of 0.1  $\mu\text{F}$  is recommended. The value of this capacitor should not be higher than 0.22  $\mu\text{F}$ .

### 5.3 Output Capacitor

For the output capacitor, it is recommended to use small ceramic capacitors placed as close as possible to the VOUT and PGND pins of the device. If, for any reason, the application requires the use of large capacitors which can not be placed close to the device, using a smaller ceramic capacitor in parallel to the large one is recommended. This small capacitor should be placed as close as possible to the VOUT and PGND pins of the device.

To get an estimate of the recommended minimum output capacitance, [Equation 1](#) can be used.

$$C_{\text{OUT}} = 5 \times L \times \frac{\mu\text{F}}{\mu\text{H}} \quad (1)$$

A capacitor with a value in the range of the calculated minimum should be used. This is required to maintain control loop stability. There are no additional requirements regarding minimum ESR. There is also no upper limit for the output capacitance value. Larger capacitors will cause lower output voltage ripple as well as lower output voltage drop during load transients.

## 6 General Layout Considerations

The following guidelines shall be understood as applicable to power designs as such and are not specific to the power solution outlined in this document.

As for all switching power supplies, the layout is an important step in the design. A proper function of the device demands careful attention to PCB layout. It is essential to take good care of the board layout to get the specified performance. In case the layout is not well done, the regulator could show poor line and/or load regulation and stability issues, as well as EMI problems. It is critical to provide a low-inductance, low-impedance ground path. Therefore, use wide and short traces for the main current paths. The input capacitor, inductor, and output capacitor should be placed physically as close as possible to the device terminals. The most important reason aside keeping the noise at a low level is the fail safe operation of the solution. Any distance added between the components will increase the value of the parasitics, which could result into greater voltage levels inside the device than the chip actually would be able to withstand. In other words, keeping the external components connected closely will prevent the device from failures through parasitics.

Connect the GND terminal of the device to the thermal-pad land of the PCB and use this pad as a star point. Use a common power-GND node and a different node for the signal GND to minimize the effects of ground noise. Connect these ground nodes together to the thermal-pad land (star point) underneath the device. Keep the common path to the GND terminal, which returns the small signal components and the high current of the output capacitors, as short as possible to avoid ground noise.

## 7 References

**Table 6. Related Documents**

DEVICE NUMBER	TI LITERATURE NUMBER	DESCRIPTION
<b>DATA SHEETS</b>		
TPS63001	<a href="#">SLVS520</a>	High Efficient Single Inductor Buck-Boost Converter with 1.8-A Switch
TPS63031	<a href="#">SLVS696</a>	High Efficient Single Inductor Buck-Boost Converter with 1-A Switch
<b>EVM USER'S GUIDES</b>		
TPS63000EVM-148	<a href="#">SLVU156</a>	Using the TPS63000EVM
TPS63030EVM-417	<a href="#">SLVU275</a>	Using the TPS63030EVM

## IMPORTANT NOTICE

Texas Instruments Incorporated and its subsidiaries (TI) reserve the right to make corrections, modifications, enhancements, improvements, and other changes to its products and services at any time and to discontinue any product or service without notice. Customers should obtain the latest relevant information before placing orders and should verify that such information is current and complete. All products are sold subject to TI's terms and conditions of sale supplied at the time of order acknowledgment.

TI warrants performance of its hardware products to the specifications applicable at the time of sale in accordance with TI's standard warranty. Testing and other quality control techniques are used to the extent TI deems necessary to support this warranty. Except where mandated by government requirements, testing of all parameters of each product is not necessarily performed.

TI assumes no liability for applications assistance or customer product design. Customers are responsible for their products and applications using TI components. To minimize the risks associated with customer products and applications, customers should provide adequate design and operating safeguards.

TI does not warrant or represent that any license, either express or implied, is granted under any TI patent right, copyright, mask work right, or other TI intellectual property right relating to any combination, machine, or process in which TI products or services are used. Information published by TI regarding third-party products or services does not constitute a license from TI to use such products or services or a warranty or endorsement thereof. Use of such information may require a license from a third party under the patents or other intellectual property of the third party, or a license from TI under the patents or other intellectual property of TI.

Reproduction of TI information in TI data books or data sheets is permissible only if reproduction is without alteration and is accompanied by all associated warranties, conditions, limitations, and notices. Reproduction of this information with alteration is an unfair and deceptive business practice. TI is not responsible or liable for such altered documentation. Information of third parties may be subject to additional restrictions.

Resale of TI products or services with statements different from or beyond the parameters stated by TI for that product or service voids all express and any implied warranties for the associated TI product or service and is an unfair and deceptive business practice. TI is not responsible or liable for any such statements.

TI products are not authorized for use in safety-critical applications (such as life support) where a failure of the TI product would reasonably be expected to cause severe personal injury or death, unless officers of the parties have executed an agreement specifically governing such use. Buyers represent that they have all necessary expertise in the safety and regulatory ramifications of their applications, and acknowledge and agree that they are solely responsible for all legal, regulatory and safety-related requirements concerning their products and any use of TI products in such safety-critical applications, notwithstanding any applications-related information or support that may be provided by TI. Further, Buyers must fully indemnify TI and its representatives against any damages arising out of the use of TI products in such safety-critical applications.

TI products are neither designed nor intended for use in military/aerospace applications or environments unless the TI products are specifically designated by TI as military-grade or "enhanced plastic." Only products designated by TI as military-grade meet military specifications. Buyers acknowledge and agree that any such use of TI products which TI has not designated as military-grade is solely at the Buyer's risk, and that they are solely responsible for compliance with all legal and regulatory requirements in connection with such use.

TI products are neither designed nor intended for use in automotive applications or environments unless the specific TI products are designated by TI as compliant with ISO/TS 16949 requirements. Buyers acknowledge and agree that, if they use any non-designated products in automotive applications, TI will not be responsible for any failure to meet such requirements.

Following are URLs where you can obtain information on other Texas Instruments products and application solutions:

<b>Products</b>		<b>Applications</b>	
Amplifiers	<a href="http://amplifier.ti.com">amplifier.ti.com</a>	Audio	<a href="http://www.ti.com/audio">www.ti.com/audio</a>
Data Converters	<a href="http://dataconverter.ti.com">dataconverter.ti.com</a>	Automotive	<a href="http://www.ti.com/automotive">www.ti.com/automotive</a>
DLP® Products	<a href="http://www.dlp.com">www.dlp.com</a>	Communications and Telecom	<a href="http://www.ti.com/communications">www.ti.com/communications</a>
DSP	<a href="http://dsp.ti.com">dsp.ti.com</a>	Computers and Peripherals	<a href="http://www.ti.com/computers">www.ti.com/computers</a>
Clocks and Timers	<a href="http://www.ti.com/clocks">www.ti.com/clocks</a>	Consumer Electronics	<a href="http://www.ti.com/consumer-apps">www.ti.com/consumer-apps</a>
Interface	<a href="http://interface.ti.com">interface.ti.com</a>	Energy	<a href="http://www.ti.com/energy">www.ti.com/energy</a>
Logic	<a href="http://logic.ti.com">logic.ti.com</a>	Industrial	<a href="http://www.ti.com/industrial">www.ti.com/industrial</a>
Power Mgmt	<a href="http://power.ti.com">power.ti.com</a>	Medical	<a href="http://www.ti.com/medical">www.ti.com/medical</a>
Microcontrollers	<a href="http://microcontroller.ti.com">microcontroller.ti.com</a>	Security	<a href="http://www.ti.com/security">www.ti.com/security</a>
RFID	<a href="http://www.ti-rfid.com">www.ti-rfid.com</a>	Space, Avionics & Defense	<a href="http://www.ti.com/space-avionics-defense">www.ti.com/space-avionics-defense</a>
RF/IF and ZigBee® Solutions	<a href="http://www.ti.com/lprf">www.ti.com/lprf</a>	Video and Imaging	<a href="http://www.ti.com/video">www.ti.com/video</a>
		Wireless	<a href="http://www.ti.com/wireless-apps">www.ti.com/wireless-apps</a>

Mailing Address: Texas Instruments, Post Office Box 655303, Dallas, Texas 75265  
Copyright © 2010, Texas Instruments Incorporated