

## FEATURES

- 5-Ω Switch Connection Between Two Ports
- TTL-Compatible Control Input Levels
- Latch-Up Performance Exceeds 100 mA Per JESD 78, Class II
- ESD Protection Exceeds JESD 22
  - 2000-V Human-Body Model (A114-A)
  - 200-V Machine Model (A115-A)

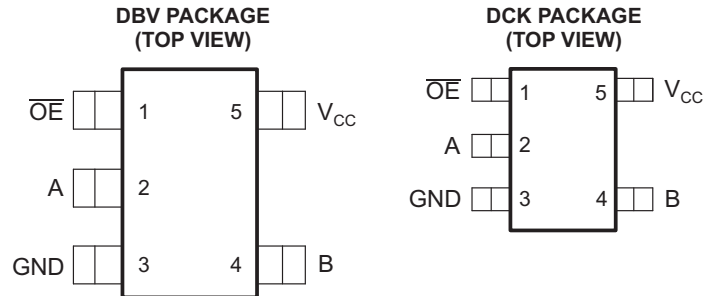

See mechanical drawings for dimensions.

## DESCRIPTION/ORDERING INFORMATION

The SN74CBTD1G125 features a single high-speed line switch. The switch is disabled when the output-enable ( $\overline{OE}$ ) input is high. A diode to  $V_{CC}$  is integrated on the chip to allow for level shifting from 5-V signals at the device inputs to 3.3-V signals at the device outputs.

### ORDERING INFORMATION

$T_A$	PACKAGE <sup>(1)</sup>		ORDERABLE PART NUMBER	TOP-SIDE MARKING <sup>(2)</sup>
–40°C to 85°C	SOT (SOT-23) – DBV	Reel of 3000	SN74CBTD1G125DBVR	P25_
		Reel of 250	SN74CBTD1G125DBVT	
	SOT (SC-70) – DCK	Reel of 3000	SN74CBTD1G125DCKR	PM_
		Reel of 250	SN74CBTD1G125DCKT	

(1) Package drawings, standard packing quantities, thermal data, symbolization, and PCB design guidelines are available at [www.ti.com/sc/package](http://www.ti.com/sc/package).

(2) The actual top-side marking has one additional character that designates the assembly/test site.

### FUNCTION TABLE

INPUT $\overline{OE}$	FUNCTION
L	A port = B port
H	Disconnect

### LOGIC DIAGRAM (POSITIVE LOGIC)

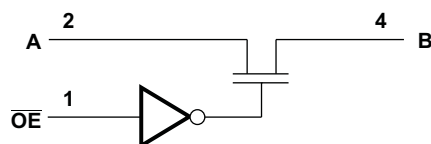

Please be aware that an important notice concerning availability, standard warranty, and use in critical applications of Texas Instruments semiconductor products and disclaimers thereto appears at the end of this data sheet.

# SN74CBTD1G125

## SINGLE FET BUS SWITCH

### WITH LEVEL SHIFTING

SCDS063L–JULY 1998–REVISED JUNE 2006

### Absolute Maximum Ratings<sup>(1)</sup>

over operating free-air temperature range (unless otherwise noted)

		MIN	MAX	UNIT
V <sub>CC</sub>	Supply voltage range	–0.5	7	V
V <sub>I</sub>	Input voltage range <sup>(2)</sup>	–0.5	7	V
Continuous channel current			128	mA
I <sub>IK</sub>	Input clamp current	V <sub>I/O</sub> < 0		–50 mA
θ <sub>JA</sub>	Package thermal impedance <sup>(3)</sup>	DBV package		206 °C/W
		DCK package		252 °C/W
T <sub>stg</sub>	Storage temperature range	–65	150	°C

- (1) Stresses beyond those listed under "absolute maximum ratings" may cause permanent damage to the device. These are stress ratings only, and functional operation of the device at these or any other conditions beyond those indicated under "recommended operating conditions" is not implied. Exposure to absolute-maximum-rated conditions for extended periods may affect device reliability.
- (2) The input and output negative-voltage ratings may be exceeded if the input and output clamp-current ratings are observed.
- (3) The package thermal impedance is calculated in accordance with JESD 51-7.

### Recommended Operating Conditions<sup>(1)</sup>

		MIN	MAX	UNIT
V <sub>CC</sub>	Supply voltage	4.5	5.5	V
V <sub>IH</sub>	High-level control input voltage <sup>(2)</sup>	2		V
V <sub>IL</sub>	Low-level control input voltage		0.8	V
T <sub>A</sub>	Operating free-air temperature	–40	85	°C

- (1) All unused control inputs of the device must be held at V<sub>CC</sub> or GND to ensure proper device operation. Refer to the TI application report, *Implications of Slow or Floating CMOS Inputs*, literature number SCBA004.
- (2) In applications with fast edge rates, multiple outputs switching, and operating at high frequencies, the output may have little or no level-shifting effect.

### Electrical Characteristics

over recommended operating free-air temperature range (unless otherwise noted)

PARAMETER		TEST CONDITIONS		MIN	TYP <sup>(1)</sup>	MAX	UNIT
V <sub>IK</sub>		V <sub>CC</sub> = 4.5 V,	I <sub>I</sub> = –18 mA			–1.2	V
V <sub>OH</sub>		See <a href="#">Figure 2</a>					
I <sub>I</sub>		V <sub>CC</sub> = 5.5 V,	V <sub>I</sub> = 5.5 V or GND			±1	μA
I <sub>CC</sub>		V <sub>CC</sub> = 5.5 V,	I <sub>O</sub> = 0, V <sub>I</sub> = V <sub>CC</sub> or GND			1.5	mA
ΔI <sub>CC</sub> <sup>(2)</sup>	Control input	V <sub>CC</sub> = 5.5 V,	One input at 3.4 V, Other inputs at V <sub>CC</sub> or GND			2.5	mA
C <sub>i</sub>	Control input	V <sub>I</sub> = 3 V or 0				2	pF
C <sub>i(OFF)</sub>		V <sub>O</sub> = 3 V or 0,	$\overline{OE}$ = V <sub>CC</sub>			3.5	pF
r <sub>on</sub> <sup>(3)</sup>		V <sub>CC</sub> = 4.5 V	V <sub>I</sub> = 0	I <sub>I</sub> = 64 mA	5	7	Ω
				I <sub>I</sub> = 30 mA	5	7	
			V <sub>I</sub> = 2.4 V,	I <sub>I</sub> = 15 mA	35	50	

- (1) All typical values are at V<sub>CC</sub> = 5 V, T<sub>A</sub> = 25°C.
- (2) This is the increase in supply current for each input that is at the specified TTL voltage level, rather than V<sub>CC</sub> or GND.
- (3) Measured by the voltage drop between the A and the B terminals at the indicated current through the switch. On-state resistance is determined by the lower voltage of the two (A or B) terminals.

## Switching Characteristics

over recommended operating free-air temperature range,  $C_L = 50$  pF (unless otherwise noted) (see [Figure 1](#))

PARAMETER	FROM (INPUT)	TO (OUTPUT)	MIN MAX		UNIT
$t_{pd}^{(1)}$	A or B	B or A		0.25	ns
$t_{en}$	$\overline{OE}$	A or B	2	5.9	ns
$t_{dis}$	$\overline{OE}$	A or B	1	4.7	ns

- (1) The propagation delay is the calculated RC time constant of the typical on-state resistance of the switch and the specified load capacitance, when driven by an ideal voltage source (zero output impedance).

**PARAMETER MEASUREMENT INFORMATION**

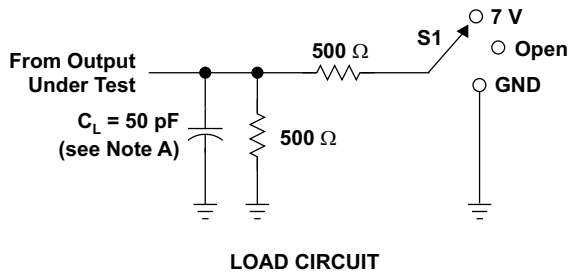

TEST	S1
$t_{pd}$	Open
$t_{PLZ}/t_{PZL}$	7 V
$t_{PHZ}/t_{PZH}$	Open

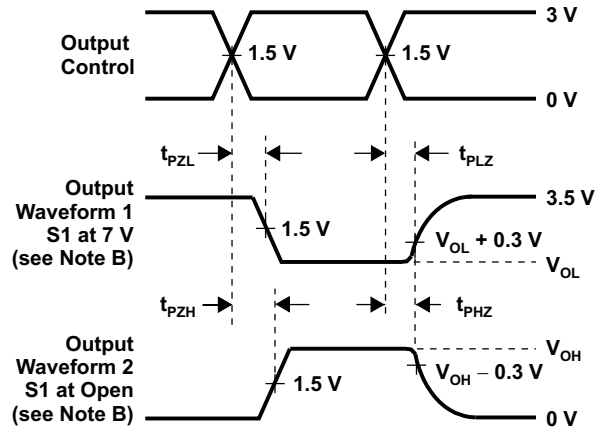
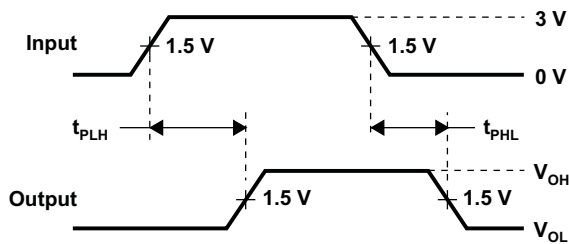

- NOTES: A.  $C_L$  includes probe and jig capacitance.  
B. Waveform 1 is for an output with internal conditions such that the output is low except when disabled by the output control. Waveform 2 is for an output with internal conditions such that the output is high except when disabled by the output control.  
C. All input pulses are supplied by generators having the following characteristics: PRR  $\leq$  10 MHz,  $Z_O = 50 \Omega$ ,  $t_r \leq 2.5$  ns,  $t_f \leq 2.5$  ns.  
D. The outputs are measured one at a time with one transition per measurement.  
E.  $t_{PLZ}$  and  $t_{PHZ}$  are the same as  $t_{dis}$ .  
F.  $t_{PZL}$  and  $t_{PZH}$  are the same as  $t_{en}$ .  
G.  $t_{PLH}$  and  $t_{PHL}$  are the same as  $t_{pd}$ .

**Figure 1. Load Circuit and Voltage Waveforms**

**TYPICAL CHARACTERISTICS**

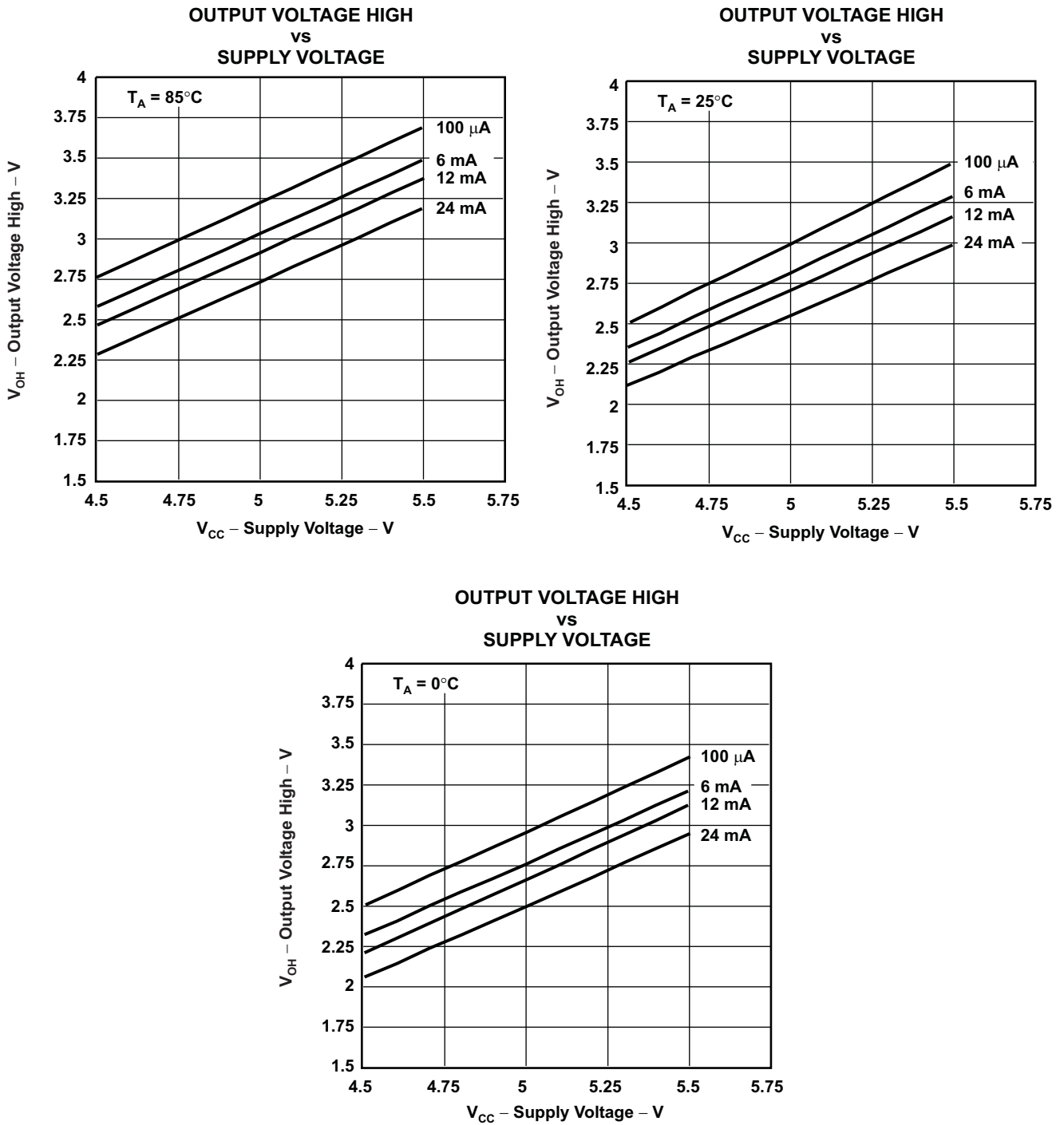

**Figure 2.  $V_{OH}$  Values**

## PACKAGING INFORMATION

Orderable Device	Status (1)	Package Type	Package Drawing	Pins	Package Qty	Eco Plan (2)	Lead finish/ Ball material (6)	MSL Peak Temp (3)	Op Temp (°C)	Device Marking (4/5)	Samples
74CBTD1G125DCKRG4	NRND	SC70	DCK	5	3000	RoHS & Green	NIPDAU	Level-1-260C-UNLIM	-40 to 85	(PMJ, PMR)	
SN74CBTD1G125DBVR	ACTIVE	SOT-23	DBV	5	3000	RoHS & Green	NIPDAU   SN	Level-1-260C-UNLIM	-40 to 85	(P25J, P25R)	Samples
SN74CBTD1G125DBVT	NRND	SOT-23	DBV	5	250	RoHS & Green	NIPDAU   SN	Level-1-260C-UNLIM	-40 to 85	(P25J, P25R)	
SN74CBTD1G125DCKR	NRND	SC70	DCK	5	3000	RoHS & Green	NIPDAU   SN	Level-1-260C-UNLIM	-40 to 85	(PMJ, PMR)	
SN74CBTD1G125DCKT	NRND	SC70	DCK	5	250	RoHS & Green	NIPDAU   SN	Level-1-260C-UNLIM	-40 to 85	(PMJ, PMR)	

(1) The marketing status values are defined as follows:

**ACTIVE:** Product device recommended for new designs.

**LIFEBUY:** TI has announced that the device will be discontinued, and a lifetime-buy period is in effect.

**NRND:** Not recommended for new designs. Device is in production to support existing customers, but TI does not recommend using this part in a new design.

**PREVIEW:** Device has been announced but is not in production. Samples may or may not be available.

**OBSELETE:** TI has discontinued the production of the device.

(2) **RoHS:** TI defines "RoHS" to mean semiconductor products that are compliant with the current EU RoHS requirements for all 10 RoHS substances, including the requirement that RoHS substance do not exceed 0.1% by weight in homogeneous materials. Where designed to be soldered at high temperatures, "RoHS" products are suitable for use in specified lead-free processes. TI may reference these types of products as "Pb-Free".

**RoHS Exempt:** TI defines "RoHS Exempt" to mean products that contain lead but are compliant with EU RoHS pursuant to a specific EU RoHS exemption.

**Green:** TI defines "Green" to mean the content of Chlorine (Cl) and Bromine (Br) based flame retardants meet JS709B low halogen requirements of <=1000ppm threshold. Antimony trioxide based flame retardants must also meet the <=1000ppm threshold requirement.

(3) MSL, Peak Temp. - The Moisture Sensitivity Level rating according to the JEDEC industry standard classifications, and peak solder temperature.

(4) There may be additional marking, which relates to the logo, the lot trace code information, or the environmental category on the device.

(5) Multiple Device Markings will be inside parentheses. Only one Device Marking contained in parentheses and separated by a "-" will appear on a device. If a line is indented then it is a continuation of the previous line and the two combined represent the entire Device Marking for that device.

(6) Lead finish/Ball material - Orderable Devices may have multiple material finish options. Finish options are separated by a vertical ruled line. Lead finish/Ball material values may wrap to two lines if the finish value exceeds the maximum column width.

**Important Information and Disclaimer:** The information provided on this page represents TI's knowledge and belief as of the date that it is provided. TI bases its knowledge and belief on information provided by third parties, and makes no representation or warranty as to the accuracy of such information. Efforts are underway to better integrate information from third parties. TI has taken and continues to take reasonable steps to provide representative and accurate information but may not have conducted destructive testing or chemical analysis on incoming materials and chemicals. TI and TI suppliers consider certain information to be proprietary, and thus CAS numbers and other limited information may not be available for release.

In no event shall TI's liability arising out of such information exceed the total purchase price of the TI part(s) at issue in this document sold by TI to Customer on an annual basis.

## TAPE AND REEL INFORMATION



### QUADRANT ASSIGNMENTS FOR PIN 1 ORIENTATION IN TAPE



\*All dimensions are nominal

Device	Package Type	Package Drawing	Pins	SPQ	Reel Diameter (mm)	Reel Width W1 (mm)	A0 (mm)	B0 (mm)	K0 (mm)	P1 (mm)	W (mm)	Pin1 Quadrant
SN74CBTD1G125DBVR	SOT-23	DBV	5	3000	178.0	9.0	3.3	3.2	1.4	4.0	8.0	Q3
SN74CBTD1G125DBVR	SOT-23	DBV	5	3000	180.0	8.4	3.23	3.17	1.37	4.0	8.0	Q3
SN74CBTD1G125DBVT	SOT-23	DBV	5	250	178.0	9.0	3.3	3.2	1.4	4.0	8.0	Q3
SN74CBTD1G125DBVT	SOT-23	DBV	5	250	180.0	8.4	3.23	3.17	1.37	4.0	8.0	Q3
SN74CBTD1G125DCKR	SC70	DCK	5	3000	180.0	8.4	2.47	2.3	1.25	4.0	8.0	Q3
SN74CBTD1G125DCKR	SC70	DCK	5	3000	178.0	9.0	2.4	2.5	1.2	4.0	8.0	Q3
SN74CBTD1G125DCKT	SC70	DCK	5	250	178.0	9.0	2.4	2.5	1.2	4.0	8.0	Q3
SN74CBTD1G125DCKT	SC70	DCK	5	250	180.0	8.4	2.47	2.3	1.25	4.0	8.0	Q3



**TAPE AND REEL BOX DIMENSIONS**

\*All dimensions are nominal

Device	Package Type	Package Drawing	Pins	SPQ	Length (mm)	Width (mm)	Height (mm)
SN74CBTD1G125DBVR	SOT-23	DBV	5	3000	180.0	180.0	18.0
SN74CBTD1G125DBVR	SOT-23	DBV	5	3000	202.0	201.0	28.0
SN74CBTD1G125DBVT	SOT-23	DBV	5	250	180.0	180.0	18.0
SN74CBTD1G125DBVT	SOT-23	DBV	5	250	202.0	201.0	28.0
SN74CBTD1G125DCKR	SC70	DCK	5	3000	202.0	201.0	28.0
SN74CBTD1G125DCKR	SC70	DCK	5	3000	180.0	180.0	18.0
SN74CBTD1G125DCKT	SC70	DCK	5	250	180.0	180.0	18.0
SN74CBTD1G125DCKT	SC70	DCK	5	250	202.0	201.0	28.0



# EXAMPLE BOARD LAYOUT

DBV0005A

SOT-23 - 1.45 mm max height

SMALL OUTLINE TRANSISTOR



LAND PATTERN EXAMPLE  
EXPOSED METAL SHOWN  
SCALE:15X



SOLDER MASK DETAILS

4214839/K 08/2024

NOTES: (continued)

- 6. Publication IPC-7351 may have alternate designs.
- 7. Solder mask tolerances between and around signal pads can vary based on board fabrication site.

# EXAMPLE STENCIL DESIGN

DBV0005A

SOT-23 - 1.45 mm max height

SMALL OUTLINE TRANSISTOR



SOLDER PASTE EXAMPLE  
BASED ON 0.125 mm THICK STENCIL  
SCALE:15X

4214839/K 08/2024

NOTES: (continued)

8. Laser cutting apertures with trapezoidal walls and rounded corners may offer better paste release. IPC-7525 may have alternate design recommendations.
9. Board assembly site may have different recommendations for stencil design.



# EXAMPLE BOARD LAYOUT

DCK0005A

SOT - 1.1 max height

SMALL OUTLINE TRANSISTOR

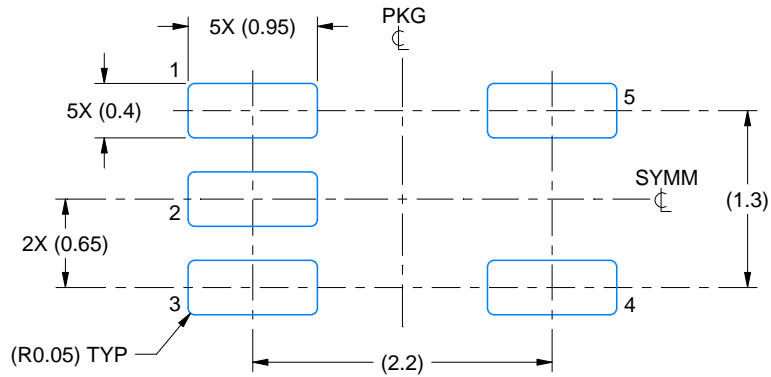

LAND PATTERN EXAMPLE  
EXPOSED METAL SHOWN  
SCALE:18X

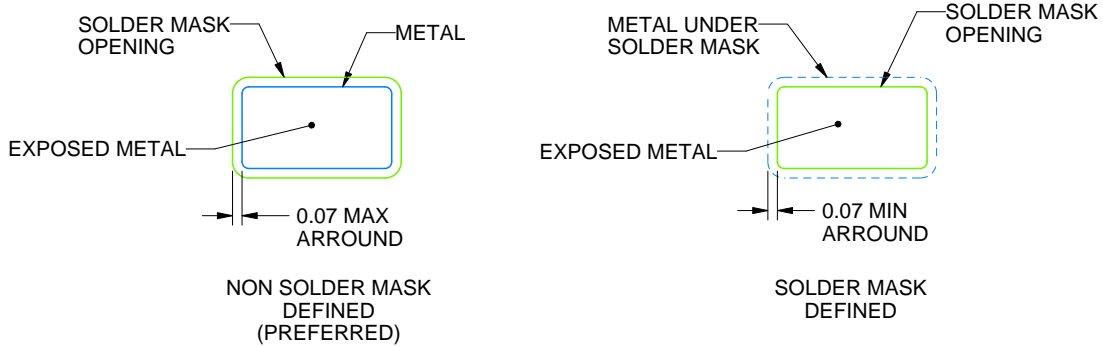

SOLDER MASK DETAILS

4214834/E 06/2024

NOTES: (continued)

- 7. Publication IPC-7351 may have alternate designs.
- 8. Solder mask tolerances between and around signal pads can vary based on board fabrication site.

# EXAMPLE STENCIL DESIGN

DCK0005A

SOT - 1.1 max height

SMALL OUTLINE TRANSISTOR

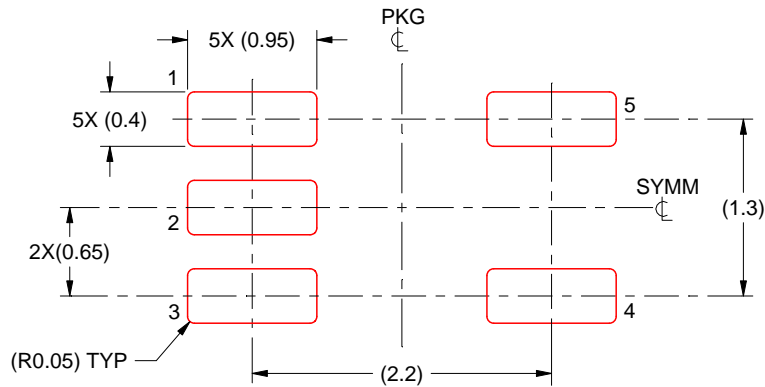

SOLDER PASTE EXAMPLE  
BASED ON 0.125 THICK STENCIL  
SCALE: 18X

4214834/E 06/2024

NOTES: (continued)

9. Laser cutting apertures with trapezoidal walls and rounded corners may offer better paste release. IPC-7525 may have alternate design recommendations.
10. Board assembly site may have different recommendations for stencil design.

## IMPORTANT NOTICE AND DISCLAIMER

TI PROVIDES TECHNICAL AND RELIABILITY DATA (INCLUDING DATA SHEETS), DESIGN RESOURCES (INCLUDING REFERENCE DESIGNS), APPLICATION OR OTHER DESIGN ADVICE, WEB TOOLS, SAFETY INFORMATION, AND OTHER RESOURCES "AS IS" AND WITH ALL FAULTS, AND DISCLAIMS ALL WARRANTIES, EXPRESS AND IMPLIED, INCLUDING WITHOUT LIMITATION ANY IMPLIED WARRANTIES OF MERCHANTABILITY, FITNESS FOR A PARTICULAR PURPOSE OR NON-INFRINGEMENT OF THIRD PARTY INTELLECTUAL PROPERTY RIGHTS.

These resources are intended for skilled developers designing with TI products. You are solely responsible for (1) selecting the appropriate TI products for your application, (2) designing, validating and testing your application, and (3) ensuring your application meets applicable standards, and any other safety, security, regulatory or other requirements.

These resources are subject to change without notice. TI grants you permission to use these resources only for development of an application that uses the TI products described in the resource. Other reproduction and display of these resources is prohibited. No license is granted to any other TI intellectual property right or to any third party intellectual property right. TI disclaims responsibility for, and you will fully indemnify TI and its representatives against, any claims, damages, costs, losses, and liabilities arising out of your use of these resources.

TI's products are provided subject to [TI's Terms of Sale](#) or other applicable terms available either on [ti.com](https://www.ti.com) or provided in conjunction with such TI products. TI's provision of these resources does not expand or otherwise alter TI's applicable warranties or warranty disclaimers for TI products.

TI objects to and rejects any additional or different terms you may have proposed.

Mailing Address: Texas Instruments, Post Office Box 655303, Dallas, Texas 75265  
Copyright © 2024, Texas Instruments Incorporated