

FAMILY OF NANOPOWER PUSH-PULL OUTPUT COMPARATORS

FEATURES

- Qualified for Automotive Applications
- ESD Protection Exceeds 2000 V Per MIL-STD-883, Method 3015; Exceeds 200 V Using Machine Model (C = 200 pF, R = 0)
- Low Supply Current . . . 560 nA/Per Channel
- Input Common-Mode Range Exceeds the Rails . . . -0.1 V to $V_{CC} + 5$ V
- Supply Voltage Range . . . 2.7 V to 16 V
- Reverse Battery Protection Up to 18 V
- Push-Pull CMOS Output Stage
- Specified Temperature Range
 - -40°C to 125°C – Automotive Grade
- Ultrasmall Packaging
 - 5-Pin SOT-23 (TLV3701)
- Universal Op-Amp EVM (Reference SLOU060 for more information)

APPLICATIONS

- Low Power Automotive Electronics
- Security Detection Systems

DESCRIPTION

The TLV370x is Texas Instruments' first family of nanopower comparators with only 560 nA per channel supply current, which make this device ideal for low power applications.

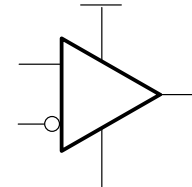

SUPPLY CURRENT vs SUPPLY VOLTAGE

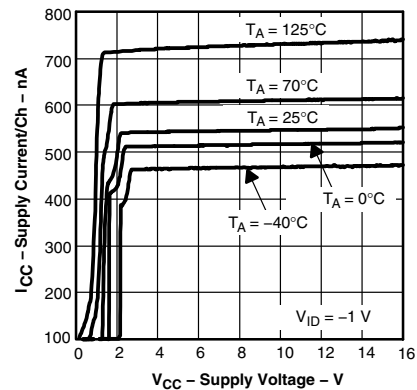

high side voltage sense circuit

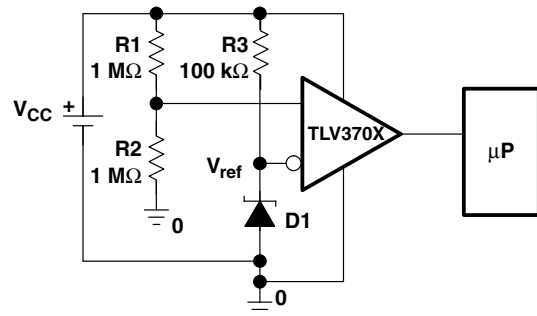

Please be aware that an important notice concerning availability, standard warranty, and use in critical applications of Texas Instruments semiconductor products and disclaimers thereto appears at the end of this data sheet.

DESCRIPTION (continued)

The TLV370x has a minimum operating supply voltage of 2.7 V over the extended automotive temperature range ($T_A = -40^{\circ}\text{C}$ to 125°C), while having an input common-mode range of -0.1 to $V_{CC} + 5$ V. The low supply current makes it an ideal choice for low power applications where quiescent current is the primary concern. Reverse battery protection guards the amplifier from an over-current condition due to improper battery installation. For harsh environments, the inputs can be taken 5 V above the positive supply rail without damage to the device.

Devices are available in SOIC with the singles in the small SOT-23 package. Other package options may be made available upon request.

A SELECTION OF OUTPUT COMPARATORST

DEVICE	V _{CC} (V)	V _{IO} (μV)	I _{CC/Ch} (μA)	I _B (pA)	t _{PLH} (μs)	t _{PHL} (μs)	t _f (μs)	t _r (μs)	RAIL-TO-RAIL	OUTPUT STAGE
TLV370x	2.5 – 16	250	0.56	80	56	83	22	8		PP
TLV340x	2.5 – 16	250	0.47	80	55	30	5	–		OD
TLC3702/4	3 – 16	1200	9	5	1.1	0.65	0.5	0.125	–	PP
TLC393/339	3 – 16	1400	11	5	1.1	0.55	0.22	–	–	OD
TLC372/4	3 – 16	1000	75	5	0.65	0.65	–	–	–	OD

† All specifications are typical values measured at 5 V.

TLV3701 AVAILABLE OPTIONST

T _A	V _{IOmax} AT 25°C	PACKAGED DEVICES‡		
		SMALL OUTLINE (D)	SOT-23 (DBV)¶	SYMBOL
-40°C to 125°C	5000 μV	TLV3701QDRQ1§	TLV3701QDBVRQ1	VBCQ

† For the most current package and ordering information, see the Package Option Addendum at the end of this document, or see the TI web site at <http://www.ti.com>.

‡ Package drawings, thermal data, and symbolization are available at <http://www.ti.com/packaging>.

§ Product Preview

¶ This package is only available taped and reeled with standard quantities of 3000 pieces per reel.

TLV3702 AVAILABLE OPTIONS

T _A	V _{IOmax} AT 25°C	PACKAGED DEVICES	
		SMALL OUTLINE (D)	SYMBOL
-40°C to 125°C	5000 μV	TLV3702QDRQ1	3702Q1

TLV3704 AVAILABLE OPTIONS

T _A	V _{IOmax} AT 25°C	PACKAGED DEVICES
		SMALL OUTLINE (D)
-40°C to 125°C	5000 μV	TLV3704QDRQ1†

† Product Preview

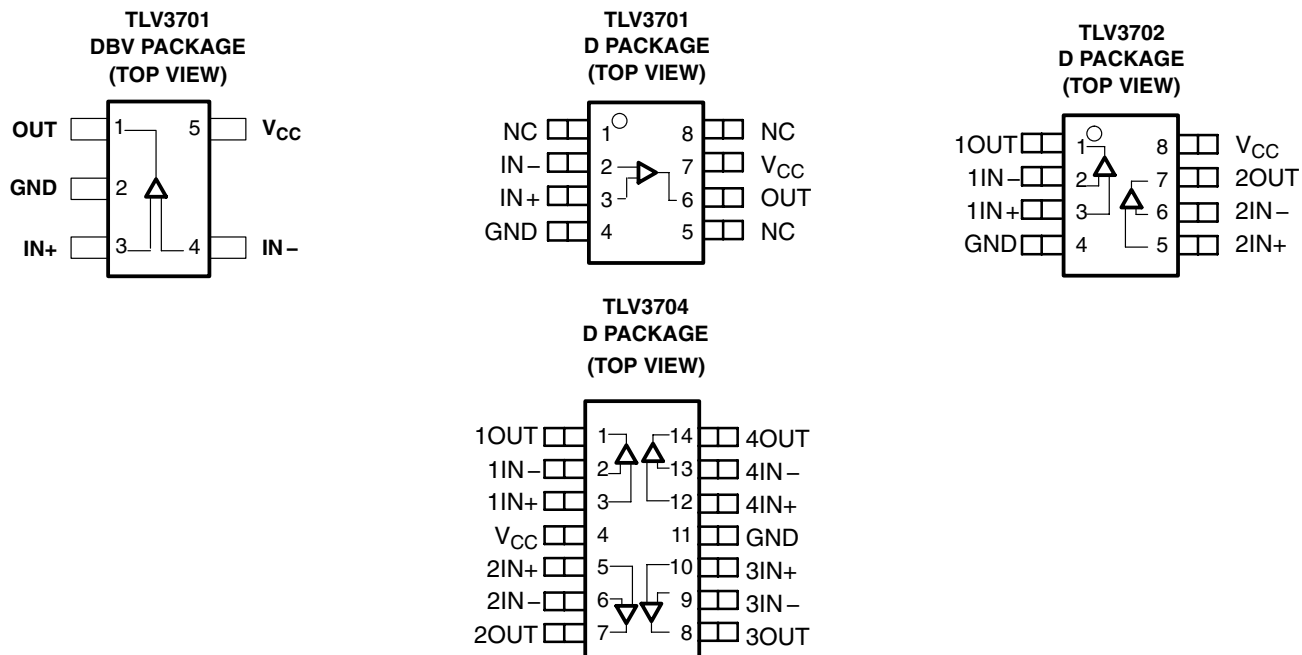

absolute maximum ratings over operating free-air temperature range (unless otherwise noted)[†]

Supply voltage, V _{CC} (see Note 1)	17 V
Differential input voltage, V _{ID}	±20 V
Input voltage range, V _I (see Notes 1 and 2)	-0.3 V to V _{CC} + 5 V
Input current range, I _I	±10 mA
Output current range, I _O	±10 mA
Continuous total power dissipation	See Dissipation Rating Table
Operating free-air temperature range, T _A : Q suffix	-40°C to 125°C
Maximum junction temperature, T _J	150°C
Storage temperature range, T _{stg}	-65°C to 150°C
Lead temperature 1,6 mm (1/16 inch) from case for 10 seconds	260°C

[†] Stresses beyond those listed under “absolute maximum ratings” may cause permanent damage to the device. These are stress ratings only, and functional operation of the device at these or any other conditions beyond those indicated under “recommended operating conditions” is not implied. Exposure to absolute-maximum-rated conditions for extended periods may affect device reliability.

- NOTES: 1. All voltage values, except differential voltages, are with respect to GND.
 2. Input voltage range is limited to 20 V max or V_{CC} + 5 V, whichever is smaller.

DISSIPATION RATING TABLE

PACKAGE	θ _{JC} (°C/W)	θ _{JA} (°C/W)	T _A ≤ 25°C POWER RATING	T _A = 125°C POWER RATING
D (8)	38.3	176	710 mW	142 mW
D (14)	26.9	122.6	1022 mW	204.4 mW
DBV (5)	55	324.1	385 mW	77.1 mW

recommended operating conditions

		MIN	MAX	UNIT
Supply voltage, V_{CC}	Single supply	2.7	16	V
	Split supply	± 1.35	± 8	
Common-mode input voltage range, V_{ICR}		-0.1	$V_{CC}+5$	V
Operating free-air temperature, T_A		-40	125	$^{\circ}\text{C}$

electrical characteristics at specified operating free-air temperature, $V_{CC} = 2.7\text{ V}, 5\text{ V}, 15\text{ V}$ (unless otherwise noted)

dc performance

PARAMETER	TEST CONDITIONS	T_A^{\dagger}	MIN	TYP	MAX	UNIT
V_{IO} Input offset voltage	$V_{IC} = V_{CC}/2, R_S = 50\ \Omega$	25 $^{\circ}\text{C}$		250	5000	μV
		Full range			7000	
α_{VIO} Offset voltage drift		25 $^{\circ}\text{C}$		3		$\mu\text{V}/^{\circ}\text{C}$
CMRR Common-mode rejection ratio	$V_{IC} = 0\text{ to }2.7\text{ V}, R_S = 50\ \Omega$	25 $^{\circ}\text{C}$	55	72		dB
		Full range	50			
	$V_{IC} = 0\text{ to }5\text{ V}, R_S = 50\ \Omega$	25 $^{\circ}\text{C}$	60	76		
		Full range	55			
$V_{IC} = 0\text{ to }15\text{ V}, R_S = 50\ \Omega$	25 $^{\circ}\text{C}$	65	88			
	Full range	60				
A_{VD} Large-signal differential voltage amplification		25 $^{\circ}\text{C}$		1000		V/mV

\dagger Full range is -40 $^{\circ}\text{C}$ to 125 $^{\circ}\text{C}$ for Q suffix.

input/output characteristics

PARAMETER	TEST CONDITIONS	T_A^{\dagger}	MIN	TYP	MAX	UNIT
I_{IO} Input offset current	$V_{IC} = V_{CC}/2, R_S = 50\ \Omega$	25 $^{\circ}\text{C}$		20	100	pA
		Full range			1000	
I_{IB} Input bias current		25 $^{\circ}\text{C}$		80	250	pA
		Full range			2000	
$r_{i(d)}$ Differential input resistance		25 $^{\circ}\text{C}$		300		M Ω
V_{OH} High-level output voltage	$V_{IC} = V_{CC}/2, I_{OH} = 2\ \mu\text{A}, V_{ID} = 1\text{ V}$	25 $^{\circ}\text{C}$		$V_{CC}-0.08$		mV
	$V_{IC} = V_{CC}/2, I_{OH} = -50\ \mu\text{A}, V_{ID} = 1\text{ V}$	25 $^{\circ}\text{C}$		$V_{CC}-320$		
		Full range		$V_{CC}-450$		
V_{OL} Low-level output voltage	$V_{IC} = V_{CC}/2, I_{OH} = 2\ \mu\text{A}, V_{ID} = -1\text{ V}$	25 $^{\circ}\text{C}$		8		mV
		25 $^{\circ}\text{C}$		80	200	
	Full range				300	

\dagger Full range is -40 $^{\circ}\text{C}$ to 125 $^{\circ}\text{C}$ for Q suffix.

electrical characteristics at specified operating free-air temperature, $V_{CC} = 2.7\text{ V}, 5\text{ V}, 15\text{ V}$ (unless otherwise noted) (continued)

power supply

PARAMETER		TEST CONDITIONS		T_A^\dagger	MIN	TYP	MAX	UNIT
I_{CC}	Supply current (per channel)	Output state high		25°C		560	800	nA
				Full range			1200	
PSRR	Power supply rejection ratio	$V_{IC} = V_{CC}/2\text{ V}$, No load	$V_{CC} = 2.7\text{ V to }5\text{ V}$	25°C	75	100	dB	
				Full range	70			
			$V_{CC} = 5\text{ V to }15\text{ V}$	25°C	85	105		
				Full range	80			

† Full range is -40°C to 125°C for Q suffix.

switching characteristics at recommended operating conditions, $V_{CC} = 2.7\text{ V}, 5\text{ V}, 15\text{ V}$, $T_A = 25^\circ\text{C}$ (unless otherwise noted)

PARAMETER		TEST CONDITIONS		MIN	TYP	MAX	UNIT
$t_{(PLH)}$	Propagation response time, low-to-high-level output (see Note 3)	$f = 1\text{ kHz}$, $V_{STEP} = 100\text{ mV}$, $C_L = 10\text{ pF}$, $V_{CC} = 2.7\text{ V}$, $V_{IC} = V_{CC}/2$	Overdrive = 2 mV		240		μs
			Overdrive = 10 mV		64	150†	
			Overdrive = 50 mV		36		
			Overdrive = 2 mV		167		
$t_{(PHL)}$	Propagation response time, high-to-low-level output (see Note 3)	$f = 1\text{ kHz}$, $V_{STEP} = 100\text{ mV}$, $C_L = 10\text{ pF}$, $V_{CC} = 2.7\text{ V}$, $V_{IC} = V_{CC}/2$	Overdrive = 10 mV		67	150†	
			Overdrive = 50 mV		37		
			Overdrive = 2 mV				
t_r	Rise time	$C_L = 10\text{ pF}$, $V_{CC} = 2.7\text{ V}$			7	μs	
t_f	Fall time	$C_L = 10\text{ pF}$, $V_{CC} = 2.7\text{ V}$			9	μs	

NOTE 3: The response time specified is the interval between the input step function and the instant when the output crosses 1.4 V. Propagation responses are longer at higher supply voltages, refer to Figures 11–16 for further details.

† This limit applies to the TLV3701-Q1 only.

TYPICAL CHARACTERISTICS

Table of Graphs

			FIGURE
	Input bias/offset current	vs Free-air temperature	1
V_{OL}	Low-level output voltage	vs Low-level output current	2, 4, 6
V_{OH}	High-level output voltage	vs High-level output current	3, 5, 7
I_{CC}	Supply current	vs Supply voltage	8
		vs Free-air temperature	9
	Output fall time/rise time	vs Supply voltage	10
	Low-to-high level output response for various input overdrives		11, 13, 15
	High-to-low level output response for various input overdrives		12, 14, 16

TYPICAL CHARACTERISTICS

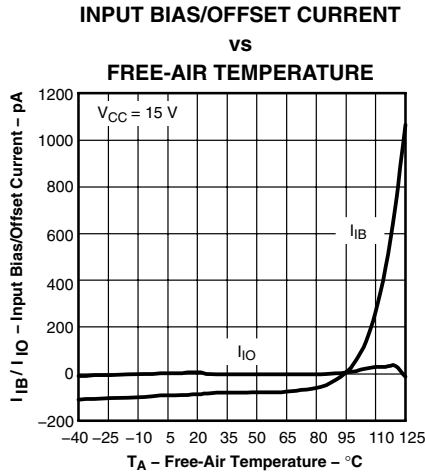

Figure 1

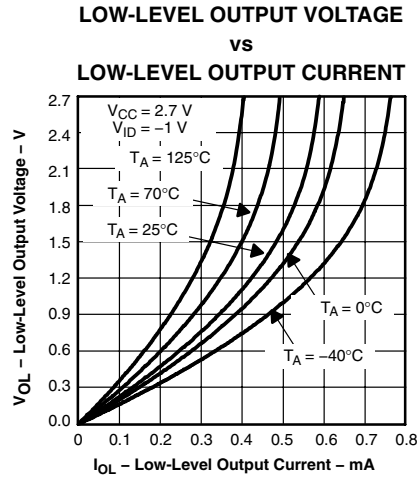

Figure 2

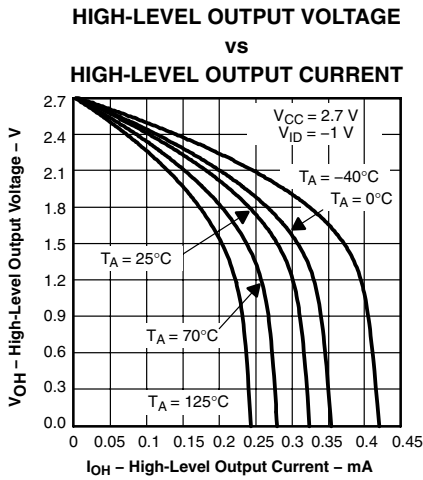

Figure 3

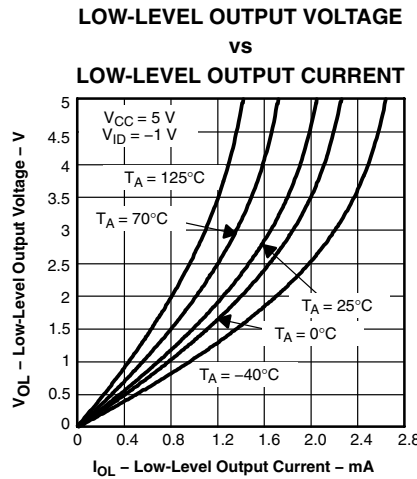

Figure 4

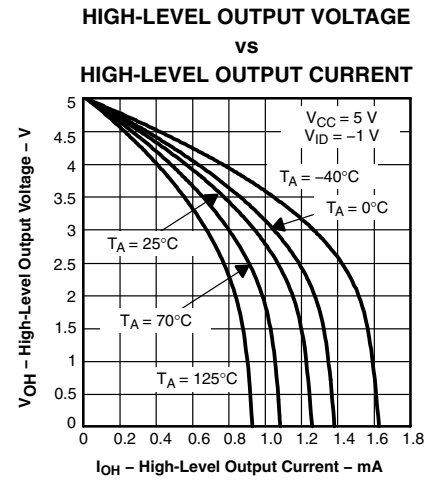

Figure 5

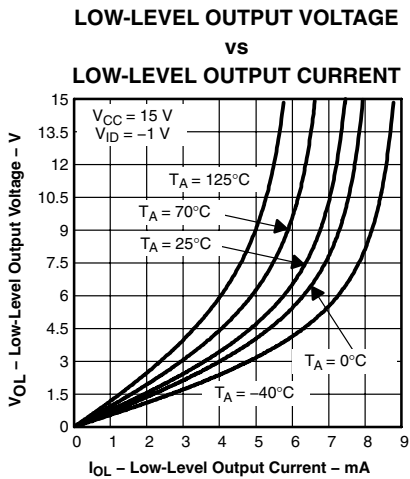

Figure 6

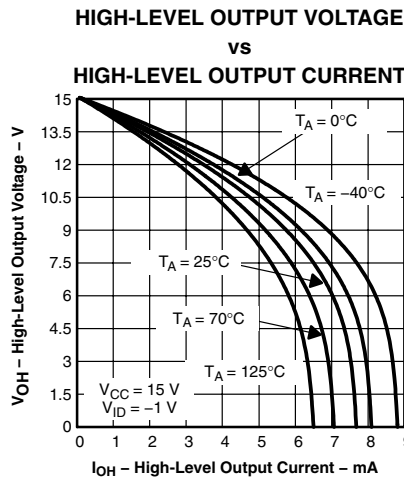

Figure 7

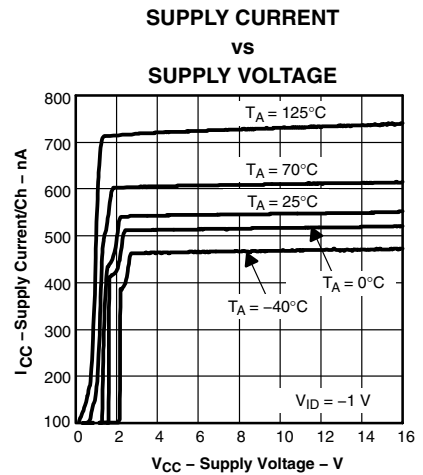

Figure 8

TYPICAL CHARACTERISTICS

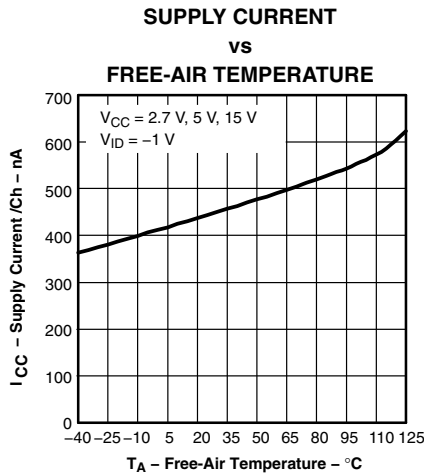

Figure 9

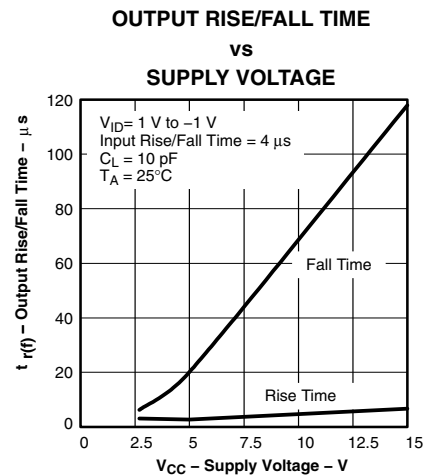

Figure 10

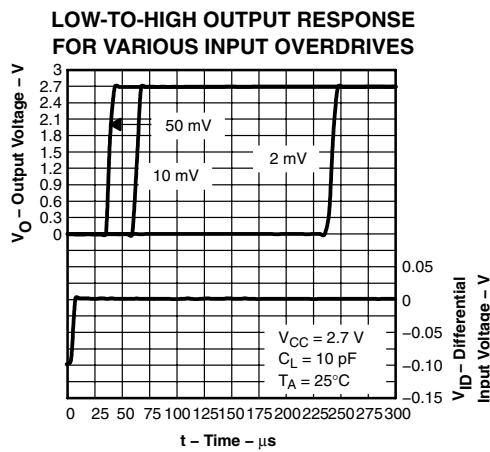

Figure 11

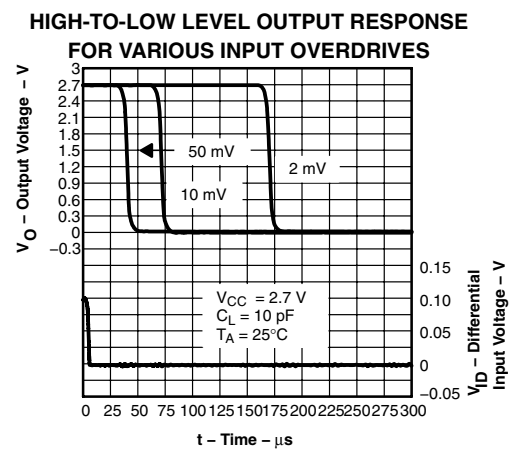

Figure 12

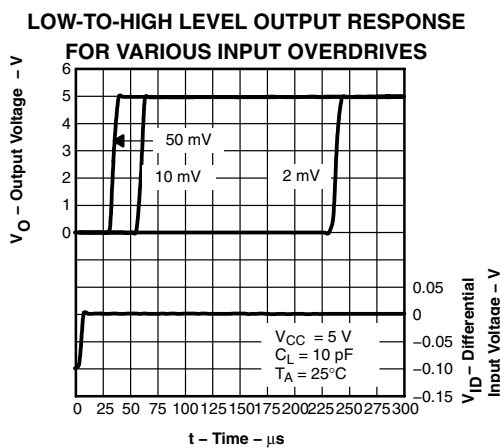

Figure 13

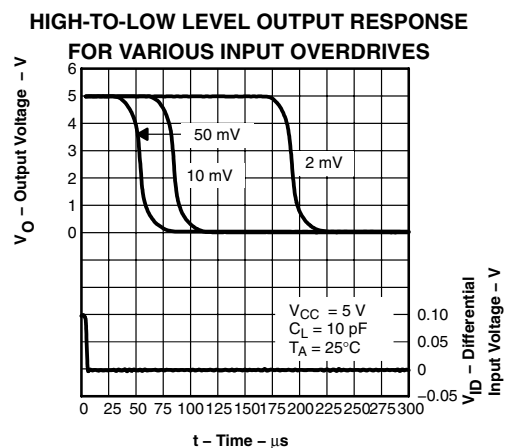

Figure 14

TYPICAL CHARACTERISTICS

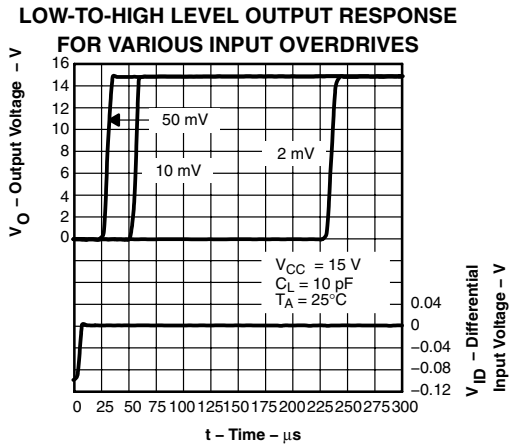

Figure 15

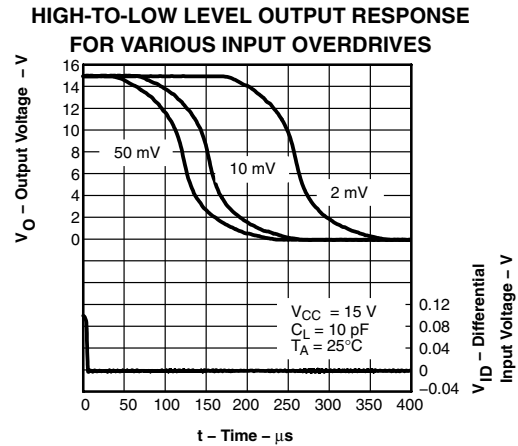

Figure 16

PACKAGING INFORMATION

Orderable Device	Status (1)	Package Type	Package Drawing	Pins	Package Qty	Eco Plan (2)	Lead finish/ Ball material (6)	MSL Peak Temp (3)	Op Temp (°C)	Device Marking (4/5)	Samples
TLV3701QDBVRG4Q1	ACTIVE	SOT-23	DBV	5	3000	RoHS & Green	NIPDAU	Level-1-260C-UNLIM	-40 to 125	VBCQ	Samples
TLV3701QDBVRQ1	ACTIVE	SOT-23	DBV	5	3000	RoHS & Green	Call TI NIPDAU	Level-1-260C-UNLIM	-40 to 125	VBCQ	Samples
TLV3702QDRG4Q1	ACTIVE	SOIC	D	8	2500	RoHS & Green	NIPDAU	Level-1-260C-UNLIM	-40 to 125	3702Q1	Samples
TLV3702QDRQ1	ACTIVE	SOIC	D	8	2500	RoHS & Green	NIPDAU	Level-1-260C-UNLIM	-40 to 125	3702Q1	Samples

(1) The marketing status values are defined as follows:

ACTIVE: Product device recommended for new designs.

LIFEBUY: TI has announced that the device will be discontinued, and a lifetime-buy period is in effect.

NRND: Not recommended for new designs. Device is in production to support existing customers, but TI does not recommend using this part in a new design.

PREVIEW: Device has been announced but is not in production. Samples may or may not be available.

OBSELETE: TI has discontinued the production of the device.

(2) **RoHS:** TI defines "RoHS" to mean semiconductor products that are compliant with the current EU RoHS requirements for all 10 RoHS substances, including the requirement that RoHS substance do not exceed 0.1% by weight in homogeneous materials. Where designed to be soldered at high temperatures, "RoHS" products are suitable for use in specified lead-free processes. TI may reference these types of products as "Pb-Free".

RoHS Exempt: TI defines "RoHS Exempt" to mean products that contain lead but are compliant with EU RoHS pursuant to a specific EU RoHS exemption.

Green: TI defines "Green" to mean the content of Chlorine (Cl) and Bromine (Br) based flame retardants meet JS709B low halogen requirements of <=1000ppm threshold. Antimony trioxide based flame retardants must also meet the <=1000ppm threshold requirement.

(3) MSL, Peak Temp. - The Moisture Sensitivity Level rating according to the JEDEC industry standard classifications, and peak solder temperature.

(4) There may be additional marking, which relates to the logo, the lot trace code information, or the environmental category on the device.

(5) Multiple Device Markings will be inside parentheses. Only one Device Marking contained in parentheses and separated by a "-" will appear on a device. If a line is indented then it is a continuation of the previous line and the two combined represent the entire Device Marking for that device.

(6) Lead finish/Ball material - Orderable Devices may have multiple material finish options. Finish options are separated by a vertical ruled line. Lead finish/Ball material values may wrap to two lines if the finish value exceeds the maximum column width.

Important Information and Disclaimer:The information provided on this page represents TI's knowledge and belief as of the date that it is provided. TI bases its knowledge and belief on information provided by third parties, and makes no representation or warranty as to the accuracy of such information. Efforts are underway to better integrate information from third parties. TI has taken and

continues to take reasonable steps to provide representative and accurate information but may not have conducted destructive testing or chemical analysis on incoming materials and chemicals. TI and TI suppliers consider certain information to be proprietary, and thus CAS numbers and other limited information may not be available for release.

In no event shall TI's liability arising out of such information exceed the total purchase price of the TI part(s) at issue in this document sold by TI to Customer on an annual basis.

OTHER QUALIFIED VERSIONS OF TLV3701-Q1, TLV3702-Q1 :

- Catalog : [TLV3701](#), [TLV3702](#)
- Enhanced Product : [TLV3701-EP](#)

NOTE: Qualified Version Definitions:

- Catalog - TI's standard catalog product
- Enhanced Product - Supports Defense, Aerospace and Medical Applications

TAPE AND REEL INFORMATION

QUADRANT ASSIGNMENTS FOR PIN 1 ORIENTATION IN TAPE

*All dimensions are nominal

Device	Package Type	Package Drawing	Pins	SPQ	Reel Diameter (mm)	Reel Width W1 (mm)	A0 (mm)	B0 (mm)	K0 (mm)	P1 (mm)	W (mm)	Pin1 Quadrant
TLV3701QDBVRG4Q1	SOT-23	DBV	5	3000	180.0	9.0	3.15	3.2	1.4	4.0	8.0	Q3
TLV3701QDBVRQ1	SOT-23	DBV	5	3000	180.0	9.0	3.15	3.2	1.4	4.0	8.0	Q3
TLV3702QDRG4Q1	SOIC	D	8	2500	330.0	12.5	6.4	5.2	2.1	8.0	12.0	Q1
TLV3702QDRQ1	SOIC	D	8	2500	330.0	12.5	6.4	5.2	2.1	8.0	12.0	Q1

TAPE AND REEL BOX DIMENSIONS



*All dimensions are nominal

Device	Package Type	Package Drawing	Pins	SPQ	Length (mm)	Width (mm)	Height (mm)
TLV3701QDBVRG4Q1	SOT-23	DBV	5	3000	182.0	182.0	20.0
TLV3701QDBVRQ1	SOT-23	DBV	5	3000	182.0	182.0	20.0
TLV3702QDRG4Q1	SOIC	D	8	2500	340.5	338.1	20.6
TLV3702QDRQ1	SOIC	D	8	2500	340.5	338.1	20.6



D0008A

PACKAGE OUTLINE

SOIC - 1.75 mm max height

SMALL OUTLINE INTEGRATED CIRCUIT



4214825/C 02/2019

NOTES:

1. Linear dimensions are in inches [millimeters]. Dimensions in parenthesis are for reference only. Controlling dimensions are in inches. Dimensioning and tolerancing per ASME Y14.5M.
2. This drawing is subject to change without notice.
3. This dimension does not include mold flash, protrusions, or gate burrs. Mold flash, protrusions, or gate burrs shall not exceed $.006$ [0.15] per side.
4. This dimension does not include interlead flash.
5. Reference JEDEC registration MS-012, variation AA.

EXAMPLE BOARD LAYOUT

D0008A

SOIC - 1.75 mm max height

SMALL OUTLINE INTEGRATED CIRCUIT



LAND PATTERN EXAMPLE
 EXPOSED METAL SHOWN
 SCALE:8X



SOLDER MASK DETAILS

4214825/C 02/2019

NOTES: (continued)

- 6. Publication IPC-7351 may have alternate designs.
- 7. Solder mask tolerances between and around signal pads can vary based on board fabrication site.

EXAMPLE STENCIL DESIGN

D0008A

SOIC - 1.75 mm max height

SMALL OUTLINE INTEGRATED CIRCUIT



SOLDER PASTE EXAMPLE
BASED ON .005 INCH [0.125 MM] THICK STENCIL
SCALE:8X

4214825/C 02/2019

NOTES: (continued)

8. Laser cutting apertures with trapezoidal walls and rounded corners may offer better paste release. IPC-7525 may have alternate design recommendations.
9. Board assembly site may have different recommendations for stencil design.

DBV0005A



PACKAGE OUTLINE

SOT-23 - 1.45 mm max height

SMALL OUTLINE TRANSISTOR



4214839/K 08/2024

NOTES:

1. All linear dimensions are in millimeters. Any dimensions in parenthesis are for reference only. Dimensioning and tolerancing per ASME Y14.5M.
2. This drawing is subject to change without notice.
3. Reference JEDEC MO-178.
4. Body dimensions do not include mold flash, protrusions, or gate burrs. Mold flash, protrusions, or gate burrs shall not exceed 0.25 mm per side.
5. Support pin may differ or may not be present.

EXAMPLE BOARD LAYOUT

DBV0005A

SOT-23 - 1.45 mm max height

SMALL OUTLINE TRANSISTOR



LAND PATTERN EXAMPLE
EXPOSED METAL SHOWN
SCALE:15X



SOLDER MASK DETAILS

4214839/K 08/2024

NOTES: (continued)

- 6. Publication IPC-7351 may have alternate designs.
- 7. Solder mask tolerances between and around signal pads can vary based on board fabrication site.

EXAMPLE STENCIL DESIGN

DBV0005A

SOT-23 - 1.45 mm max height

SMALL OUTLINE TRANSISTOR



SOLDER PASTE EXAMPLE
BASED ON 0.125 mm THICK STENCIL
SCALE:15X

4214839/K 08/2024

NOTES: (continued)

8. Laser cutting apertures with trapezoidal walls and rounded corners may offer better paste release. IPC-7525 may have alternate design recommendations.
9. Board assembly site may have different recommendations for stencil design.

IMPORTANT NOTICE AND DISCLAIMER

TI PROVIDES TECHNICAL AND RELIABILITY DATA (INCLUDING DATA SHEETS), DESIGN RESOURCES (INCLUDING REFERENCE DESIGNS), APPLICATION OR OTHER DESIGN ADVICE, WEB TOOLS, SAFETY INFORMATION, AND OTHER RESOURCES "AS IS" AND WITH ALL FAULTS, AND DISCLAIMS ALL WARRANTIES, EXPRESS AND IMPLIED, INCLUDING WITHOUT LIMITATION ANY IMPLIED WARRANTIES OF MERCHANTABILITY, FITNESS FOR A PARTICULAR PURPOSE OR NON-INFRINGEMENT OF THIRD PARTY INTELLECTUAL PROPERTY RIGHTS.

These resources are intended for skilled developers designing with TI products. You are solely responsible for (1) selecting the appropriate TI products for your application, (2) designing, validating and testing your application, and (3) ensuring your application meets applicable standards, and any other safety, security, regulatory or other requirements.

These resources are subject to change without notice. TI grants you permission to use these resources only for development of an application that uses the TI products described in the resource. Other reproduction and display of these resources is prohibited. No license is granted to any other TI intellectual property right or to any third party intellectual property right. TI disclaims responsibility for, and you will fully indemnify TI and its representatives against, any claims, damages, costs, losses, and liabilities arising out of your use of these resources.

TI's products are provided subject to [TI's Terms of Sale](#) or other applicable terms available either on [ti.com](https://www.ti.com) or provided in conjunction with such TI products. TI's provision of these resources does not expand or otherwise alter TI's applicable warranties or warranty disclaimers for TI products.

TI objects to and rejects any additional or different terms you may have proposed.

Mailing Address: Texas Instruments, Post Office Box 655303, Dallas, Texas 75265
Copyright © 2024, Texas Instruments Incorporated