

STEREO AUDIO CODEC WITH USB INTERFACE, SINGLE-ENDED ANALOG INPUT/OUTPUT, AND S/PDIF

Check for Samples: [PCM2903B](#)

FEATURES

- **On-Chip USB Interface:**
 - With Full-Speed Transceivers
 - Fully Compliant with USB 2.0 Specification
 - Certified by USB-IF
 - Partially Programmable Descriptors ⁽¹⁾
 - USB Adaptive Mode for Playback
 - USB Asynchronous Mode for Record
 - Self-Powered
- 16-Bit Delta-Sigma ADC and DAC
- **Sampling Rates:**
 - DAC: 32, 44.1, 48 kHz
 - ADC: 8, 11.025, 16, 22.05, 32, 44.1, 48 kHz
- On-Chip Clock Generator With Single 12-MHz Clock Source
- S/PDIF Input/Output
- **Single Power Supply:**
 - 3.3 V Typical
- **Stereo ADC:**
 - Analog Performance at $V_{CC} = V_{CCP1} = V_{CCP2} = V_{CCX} = V_{DD} = 3.3\text{ V}$:
 - THD+N = 0.01%
 - SNR = 89 dB
 - Dynamic Range = 89 dB
 - Decimation Digital Filter:
 - Passband Ripple = $\pm 0.05\text{ dB}$
 - Stop-Band Attenuation = -65 dB
 - Single-Ended Voltage Input
 - Antialiasing Filter Included
 - Digital HPF Included

- **Stereo DAC:**
 - Analog Performance at $V_{CC} = V_{CCP1} = V_{CCP2} = V_{CCX} = V_{DD} = 3.3\text{ V}$:
 - THD+N = 0.005%
 - SNR = 96 dB
 - Dynamic Range = 93 dB
 - Oversampling Digital Filter:
 - Passband Ripple = $\pm 0.1\text{ dB}$
 - Stop-Band Attenuation = -43 dB
 - Single-Ended Voltage Output
 - Analog LPF Included
- **Multifunctions:**
 - Human Interface Device (HID) Function:
 - Volume and and Mute Controls
 - Suspend Flag Function
- 28-Pin SSOP Package

APPLICATIONS

- USB Audio Speaker
- USB Headset
- USB Monitor
- USB Audio Interface Box

DESCRIPTION

The PCM2903B is Texas Instruments' single-chip, USB, stereo audio codec with a USB-compliant full-speed protocol controller and S/PDIF. The USB protocol controller requires no software code, but the USB descriptors can be modified in some areas (for example, vendor ID and/or product ID). The PCM2903B employs SpAct™ architecture, TI's unique system that recovers the audio clock from USB packet data. On-chip analog PLLs with SpAct enable playback and record with low clock jitter as well as independent playback and record sampling rates.

(1) The descriptor can be modified by changing a mask.



Please be aware that an important notice concerning availability, standard warranty, and use in critical applications of Texas Instruments semiconductor products and disclaimers thereto appears at the end of this data sheet.

SpAct is a trademark of Texas Instruments.

System Two, Audio Precision are trademarks of Audio Precision, Inc.

All other trademarks are the property of their respective owners.



This integrated circuit can be damaged by ESD. Texas Instruments recommends that all integrated circuits be handled with appropriate precautions. Failure to observe proper handling and installation procedures can cause damage.

ESD damage can range from subtle performance degradation to complete device failure. Precision integrated circuits may be more susceptible to damage because very small parametric changes could cause the device not to meet its published specifications.

PACKAGE/ORDERING INFORMATION⁽¹⁾

PRODUCT	PACKAGE-LEAD	PACKAGE DESIGNATOR	SPECIFIED TEMPERATURE RANGE	PACKAGE MARKING	ORDERING NUMBER	TRANSPORT MEDIA, QUANTITY
PCM2903BDB	SSOP-28	DB	–25°C to 85°C	PCM2903B	PCM2903BDB	Rails, 47
					PCM2903BDBR	Tape and Reel, 2000

(1) For the most current package and ordering information, see the Package Option Addendum at the end of this document, or see the TI website at www.ti.com.

ABSOLUTE MAXIMUM RATINGS⁽¹⁾

Over operating free-air temperature range (unless otherwise noted).

PARAMETER		PCM2903B	UNIT
Supply voltage, V_{CC} , V_{CCP1} , V_{CCP2} , V_{CCX} , V_{DD}		–0.3 to 4	V
Supply voltage differences, V_{CC} , V_{CCP1} , V_{CCP2} , V_{CCX} , V_{DD}		±0.1	V
Ground voltage differences, AGND, AGNDP, AGNDX, DGND, DGNDU		±0.1	V
Digital input voltage	SEL0, SEL1, DIN	–0.3 to 6.5	V
	D+, D–, HID0, HID1, HID2, XTI, XTO, DOUT, \overline{SSPN}	–0.3 to $(V_{DD} + 0.3) < 4$	V
Analog input voltage V_{INL} , V_{INR} , V_{COM} , V_{OUTR} , V_{OUTL}		–0.3 to $(V_{CC} + 0.3) < 4$	V
Input current (any pins except supplies)		±10	mA
Ambient temperature under bias		–40 to +125	°C
Storage temperature, T_{stg}		–55 to +150	°C
Junction temperature T_J		+150	°C
Lead temperature (soldering, 5s)		+260	°C
Package temperature (IR reflow, peak)		+250	°C

(1) Stresses beyond those listed under *Absolute Maximum Ratings* may cause permanent damage to the device. These are stress ratings only, and functional operation of the device at these or any other conditions beyond those indicated under is not implied. Exposure to absolute-maximum-rated conditions for extended periods may affect device reliability.

ELECTRICAL CHARACTERISTICS

All specifications at $T_A = +25^\circ\text{C}$, $V_{\text{CC}} = V_{\text{CCP1}} = V_{\text{CCP2}} = V_{\text{CCX}} = V_{\text{DD}} = 3.3\text{ V}$, $f_S = 44.1\text{ kHz}$, $f_{\text{IN}} = 1\text{ kHz}$, 16-bit data, unless otherwise noted.

PARAMETER		TEST CONDITIONS	PCM2903B			UNIT
			MIN	TYP	MAX	
DIGITAL INPUT/OUTPUT						
Host interface		Apply USB Revision 2.0, full speed				
Audio data format		USB isochronous data format				
INPUT LOGIC						
V_{IH}	High-level input voltage	D+, D–			V_{DD}	VDC
		XTI, HID0, HID1, and HID2		$0.7 V_{\text{DD}}$	V_{DD}	
		SEL0, SEL1		2	5.25	
		DIN		$0.7 V_{\text{DD}}$	5.25	
V_{IL}	Low-level input voltage	D+, D–			0.8	VDC
		XTI, HID0, HID1, and HID2			$0.3 V_{\text{DD}}$	
		SEL0, SEL1			0.8	
		DIN			$0.3 V_{\text{DD}}$	
I_{IH}	High-level input current	D+, D–, XTI, SEL0, SEL1	$V_{\text{IN}} = 3.3\text{ V}$		± 10	μA
		HID0, HID1, and HID2	$V_{\text{IN}} = 3.3\text{ V}$	50	80	
		DIN	$V_{\text{IN}} = 3.3\text{ V}$	65	100	
I_{IL}	Low-level input current	D+, D–, XTI, SEL0, SEL1	$V_{\text{IN}} = 0\text{ V}$		± 10	μA
		HID0, HID1, and HID2	$V_{\text{IN}} = 0\text{ V}$		± 10	
		DIN	$V_{\text{IN}} = 0\text{ V}$		± 10	
OUTPUT LOGIC						
V_{OH}	High-level output voltage	D+, D–		2.8		VDC
		DOUT	$I_{\text{OH}} = -4\text{ mA}$	2.8		
		$\overline{\text{SSPND}}$	$I_{\text{OH}} = -2\text{ mA}$	2.8		
V_{OL}	Low-level output voltage	D+, D–			0.3	VDC
		DOUT	$I_{\text{OL}} = 4\text{ mA}$		0.5	
		$\overline{\text{SSPND}}$	$I_{\text{OL}} = 2\text{ mA}$		0.5	
CLOCK FREQUENCY						
Input clock frequency, XTI			11.994	12	12.006	MHz

ELECTRICAL CHARACTERISTICS (continued)

All specifications at $T_A = +25^\circ\text{C}$, $V_{\text{CC}} = V_{\text{CCP1}} = V_{\text{CCP2}} = V_{\text{CCX}} = V_{\text{DD}} = 3.3\text{ V}$, $f_S = 44.1\text{ kHz}$, $f_{\text{IN}} = 1\text{ kHz}$, 16-bit data, unless otherwise noted.

PARAMETER	TEST CONDITIONS	PCM2903B			UNIT
		MIN	TYP	MAX	
ADC CHARACTERISTICS					
Resolution			8, 16		Bits
Audio data channel			1, 2		Channel
ADC Clock Frequency					
f_S Sampling frequencies			8, 11.025, 16, 22.05, 32, 44.1, 48		kHz
ADC DC Accuracy					
Gain mismatch, channel-to-channel			± 1	± 5	% of FSR
Gain error			± 2	± 10	% of FSR
Bipolar zero error			± 0		% of FSR
ADC Dynamic Performance⁽¹⁾					
THD+N Total harmonic distortion plus noise	$V_{\text{IN}} = -1\text{ dB}$		0.01	0.02	%
	$V_{\text{IN}} = -60\text{ dB}$		5		%
Dynamic range	A-weighted	81	89		dB
SNR Signal-to-noise ratio	A-weighted	81	89		dB
Channel separation		80	85		dB
Analog Input					
Input voltage			$0.6 V_{\text{CC}}$		V_{PP}
Center voltage			$0.5 V_{\text{CC}}$		V
Input impedance			30		k Ω
Antialiasing filter frequency response	-3 dB		150		kHz
	$f_{\text{IN}} = 20\text{ kHz}$		-0.08		dB
ADC Digital Filter Performance					
Passband			$0.454 f_S$		Hz
Stop band		$0.583 f_S$			Hz
Passband ripple			± 0.05		dB
Stop-band attenuation		-65			dB
t_d Delay time			$17.4/f_S$		s
HPF frequency response	-3 dB		$0.078 f_S/1000$		Hz

(1) $f_{\text{IN}} = 1\text{ kHz}$, using a System Two™ audio measurement system by Audio Precision™ in RMS mode with a 20-kHz LPF and 400-Hz HPF in the calculation.

ELECTRICAL CHARACTERISTICS (continued)

All specifications at $T_A = +25^\circ\text{C}$, $V_{\text{CC}} = V_{\text{CCP1}} = V_{\text{CCP2}} = V_{\text{CCX}} = V_{\text{DD}} = 3.3\text{ V}$, $f_S = 44.1\text{ kHz}$, $f_{\text{IN}} = 1\text{ kHz}$, 16-bit data, unless otherwise noted.

PARAMETER	TEST CONDITIONS	PCM2903B			UNIT
		MIN	TYP	MAX	
DAC CHARACTERISTICS					
Resolution			8, 16		Bits
Audio data channel			1, 2		Channel
DAC Clock Frequency					
f_S Sampling frequencies			32, 44.1, 48		kHz
DAC DC Accuracy					
Gain mismatch channel-to-channel			± 1	± 5	% of FSR
Gain error			± 2	± 10	% of FSR
Bipolar zero error			± 2		% of FSR
DAC Dynamic Performance⁽²⁾					
THD+N Total harmonic distortion plus noise	$V_{\text{OUT}} = 0\text{ dB}$		0.005	0.016	%
	$V_{\text{OUT}} = -60\text{ dB}$		3		%
Dynamic range	EIAJ, A-weighted	87	93		dB
SNR Signal-to-noise ratio	EIAJ, A-weighted	90	96		dB
Channel separation		86	92		dB
Analog Output					
V_O Output voltage			$0.6 V_{\text{CC}}$		V_{PP}
Center voltage			$0.5 V_{\text{CC}}$		V
Load impedance	AC coupling	10			k Ω
LPF frequency response	-3 dB		250		kHz
	$f = 20\text{ kHz}$		-0.03		dB
DAC Digital Filter Performance					
Passband				$0.445 f_S$	Hz
Stop band		$0.555 f_S$			Hz
Passband ripple				± 0.1	dB
Stop-band attenuation		-43			dB
t_d Delay time			$14.3/f_S$		s
POWER-SUPPLY REQUIREMENTS					
V_{DD} , V_{CC} , V_{CCP1} , V_{CCP2} , V_{CCX} Voltage range		3	3.3	3.6	VDC
Supply current	ADC, DAC operation		54	70	mA
	Suspend mode ⁽³⁾		250		μA
P_D Power dissipation	ADC, DAC operation		178	252	mW
	Suspend mode ⁽³⁾		0.83		mW
TEMPERATURE RANGE					
Operating temperature range		-25		+85	$^\circ\text{C}$
θ_{JA} Thermal resistance			100		$^\circ\text{C/W}$

(2) $f_{\text{OUT}} = 1\text{ kHz}$, using a System Two audio measurement system by Audio Precision in RMS mode with a 20-kHz LPF and 400-Hz HPF.

(3) Under USB suspend state.

PIN ASSIGNMENTS

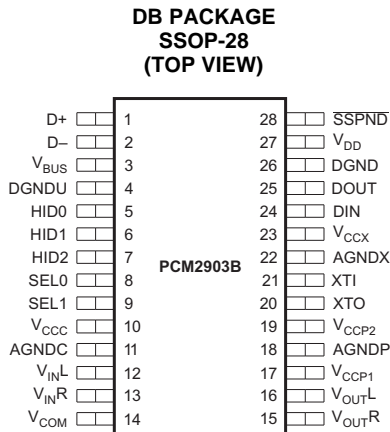

P0007-07

Table 1. TERMINAL FUNCTIONS

TERMINAL		I/O	DESCRIPTION
NAME	NO.		
AGNDC	11	–	Analog ground for codec
AGNDP	18	–	Analog ground for PLL
AGNDX	22	–	Analog ground for oscillator
D–	2	I/O	USB differential input/output minus ⁽¹⁾
D+	1	I/O	USB differential input/output plus ⁽¹⁾
DGND	26	–	Digital ground
DGNDU	4	–	Digital ground for USB transceiver
DIN	24	I	S/PDIF input ⁽²⁾
DOUT	25	O	S/PDIF output
HID0	5	I	HID key state input (mute), active-high ⁽³⁾
HID1	6	I	HID key state input (volume up), active-high ⁽³⁾
HID2	7	I	HID key state input (volume down), active-high ⁽³⁾
SEL0	8	I	Must be set to high ⁽⁴⁾
SEL1	9	I	Connected to the USB port of V _{BUS} ⁽⁴⁾
SSPND	28	O	Suspend flag, active-low (Low: suspend, High: operational)
V _{BUS}	3	–	Must be connected to V _{DD}
V _{CCC}	10	–	Analog power supply for codec ⁽⁵⁾
V _{CCP1}	17	–	Analog power supply for PLL ⁽⁵⁾
V _{CCP2}	19	–	Analog power supply for PLL ⁽⁵⁾
V _{CCX}	23	–	Analog power supply for oscillator ⁽⁵⁾
V _{COM}	14	–	Common for ADC/DAC (V _{CCC} /2) ⁽⁵⁾
V _{DD}	27	–	Digital power supply ⁽⁵⁾
V _{INL}	12	I	ADC analog input for L-channel
V _{INR}	13	I	ADC analog input for R-channel
V _{OUTL}	16	O	DAC analog output for L-channel
V _{OUTR}	15	O	DAC analog output for R-channel
XTI	21	I	Crystal oscillator input ⁽⁶⁾

(1) LV-TTL level.

(2) 3.3-V CMOS-level input with internal pulldown, 5-V tolerant.

(3) 3.3-V CMOS-level input with internal pulldown. This pin informs the PC of serviceable control signals such as mute, volume up, or volume down, which have no direct connection with the internal DAC or ADC. See the [Interface #3](#) and [End-Points](#) sections.

(4) TTL Schmitt trigger, 5-V tolerant.

(5) Connect a decoupling capacitor to GND.

(6) 3.3-V CMOS-level input.

Table 1. TERMINAL FUNCTIONS (continued)

TERMINAL		I/O	DESCRIPTION
NAME	NO.		
XTO	20	O	Crystal oscillator output

FUNCTIONAL BLOCK DIAGRAM

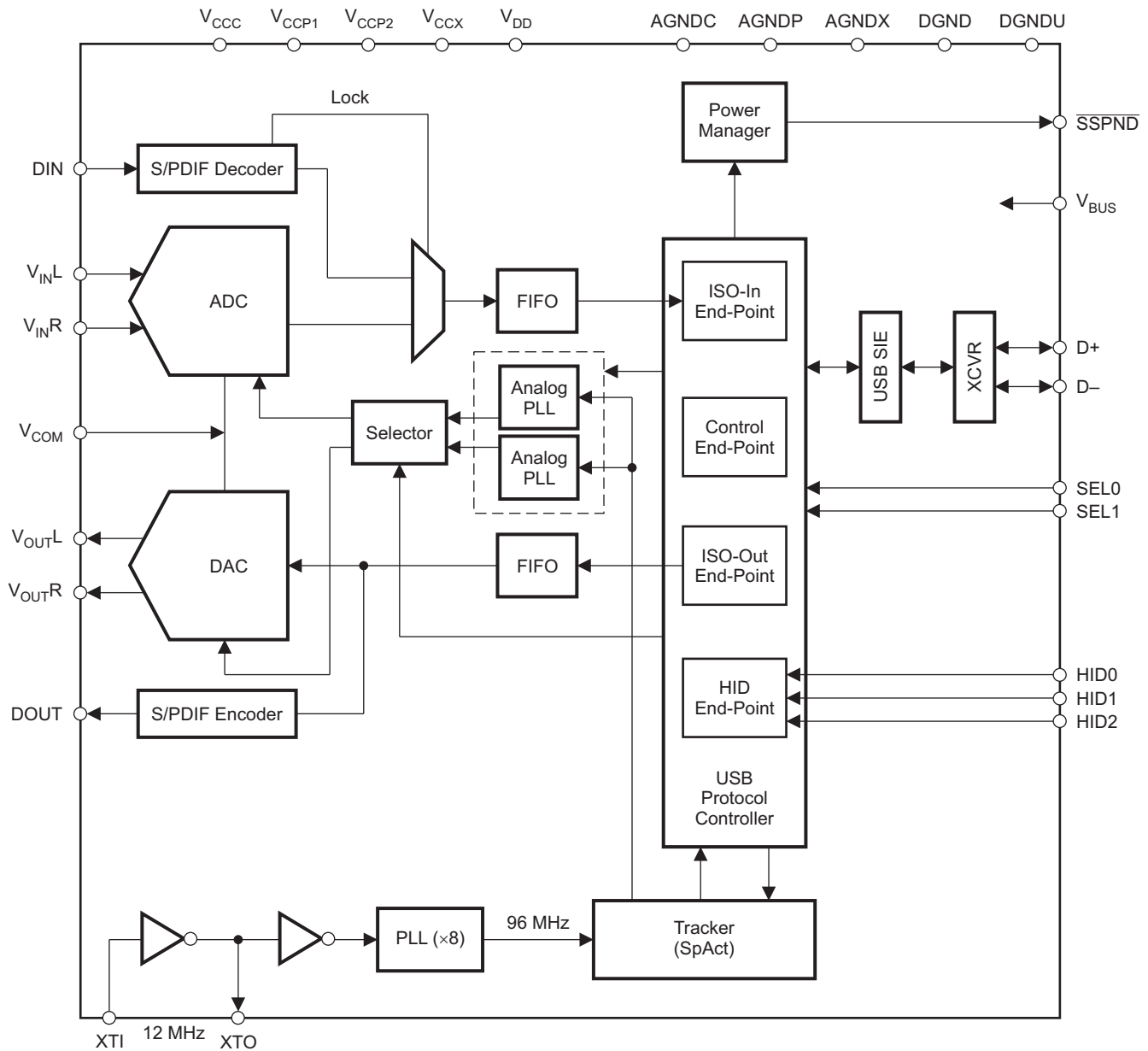

B0239-02

BLOCK DIAGRAM OF ANALOG FRONT-END (RIGHT CHANNEL)

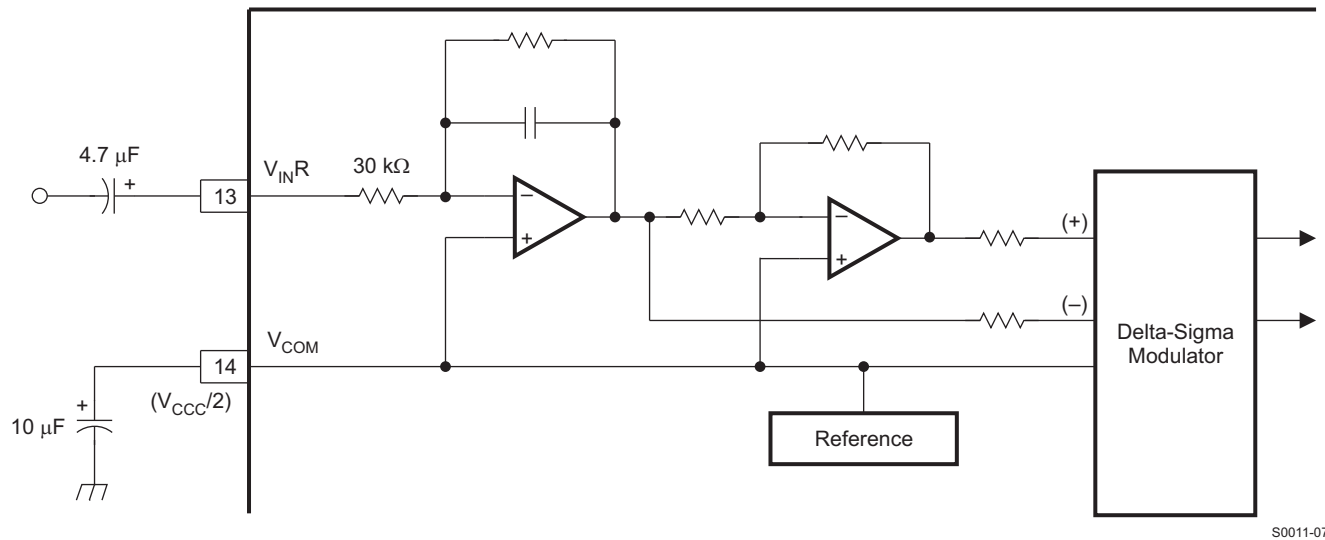

TYPICAL CHARACTERISTICS: ADC

All specifications at $T_A = +25^\circ\text{C}$, $V_{DD} = V_{CCC} = V_{CCP1} = V_{CCP2} = V_{CCX} = 3.3\text{ V}$, $f_s = 44.1\text{ kHz}$, $f_{IN} = 1\text{ kHz}$, 16-bit data, unless otherwise noted.

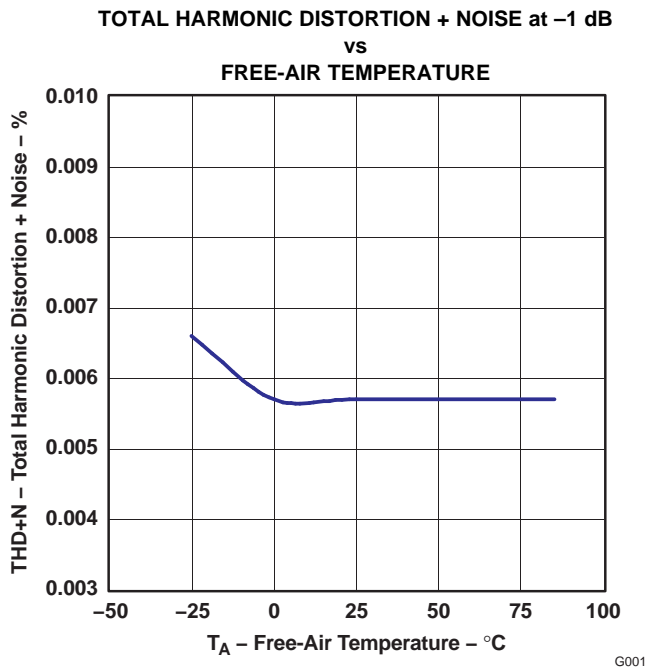

Figure 1.

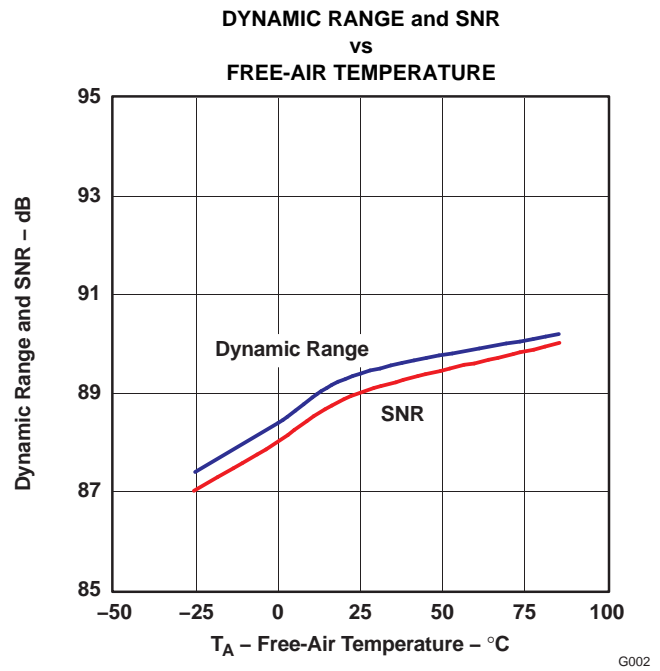

Figure 2.

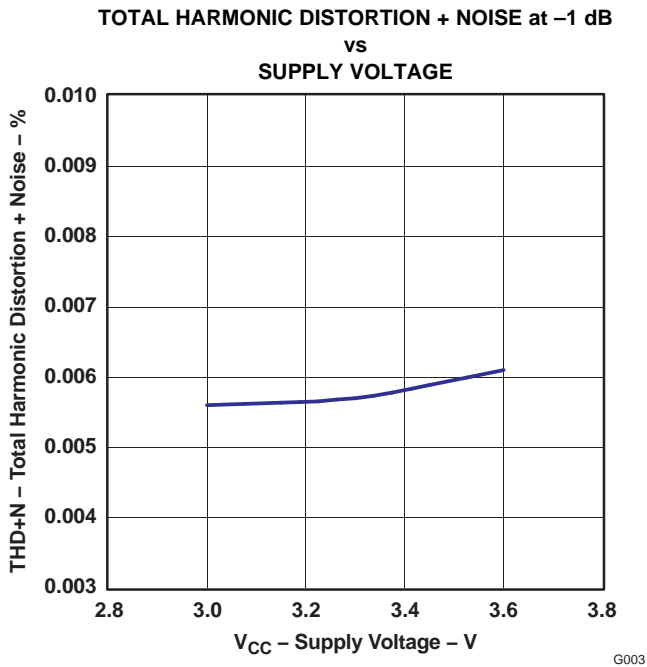

Figure 3.

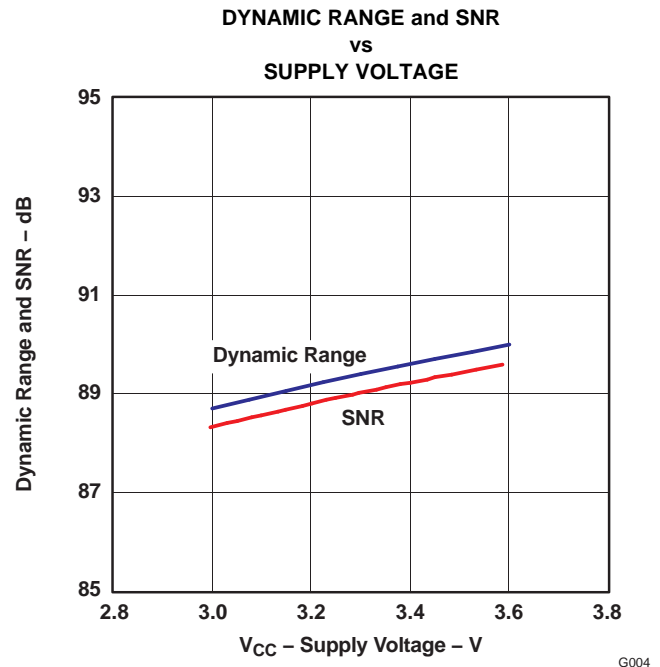

Figure 4.

TYPICAL CHARACTERISTICS: ADC (continued)

All specifications at $T_A = +25^\circ\text{C}$, $V_{DD} = V_{CC} = V_{CCP1} = V_{CCP2} = V_{CCX} = 3.3\text{ V}$, $f_s = 44.1\text{ kHz}$, $f_{IN} = 1\text{ kHz}$, 16-bit data, unless otherwise noted.

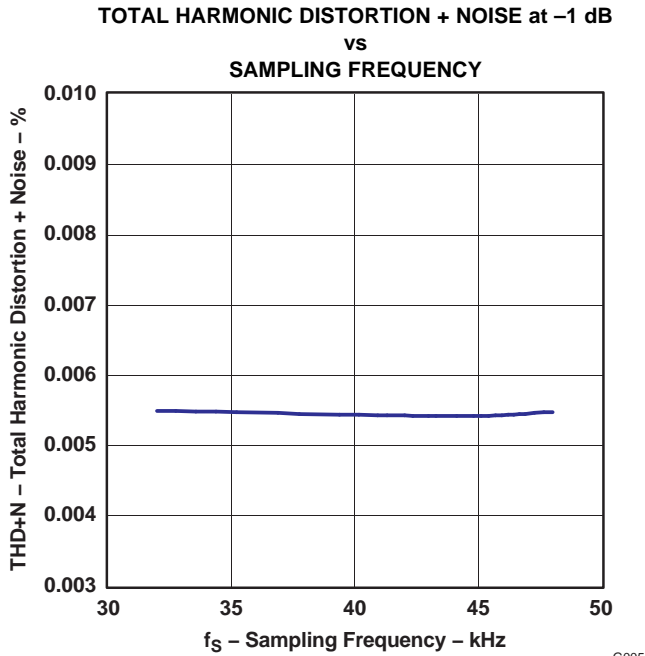

Figure 5.

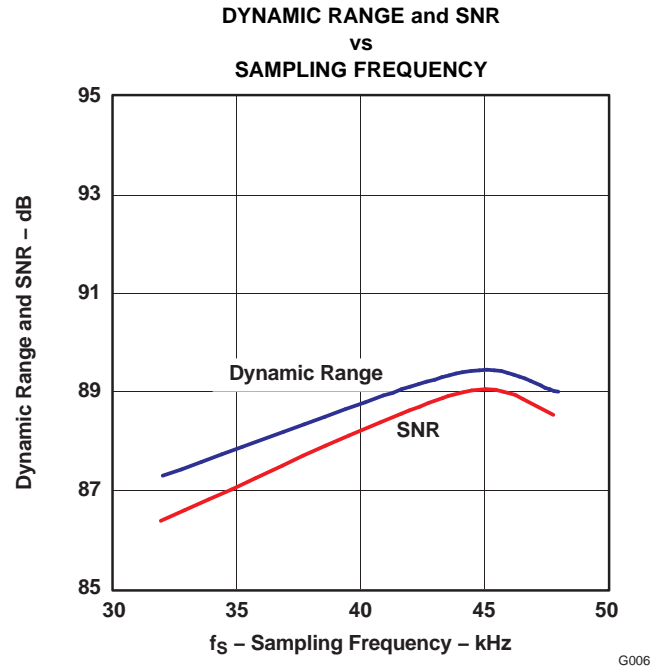

Figure 6.

TYPICAL CHARACTERISTICS: DAC

All specifications at $T_A = +25^\circ\text{C}$, $V_{DD} = V_{CC} = V_{CCP1} = V_{CCP2} = V_{CCX} = 3.3\text{ V}$, $f_s = 44.1\text{ kHz}$, $f_{IN} = 1\text{ kHz}$, 16-bit data, unless otherwise noted.

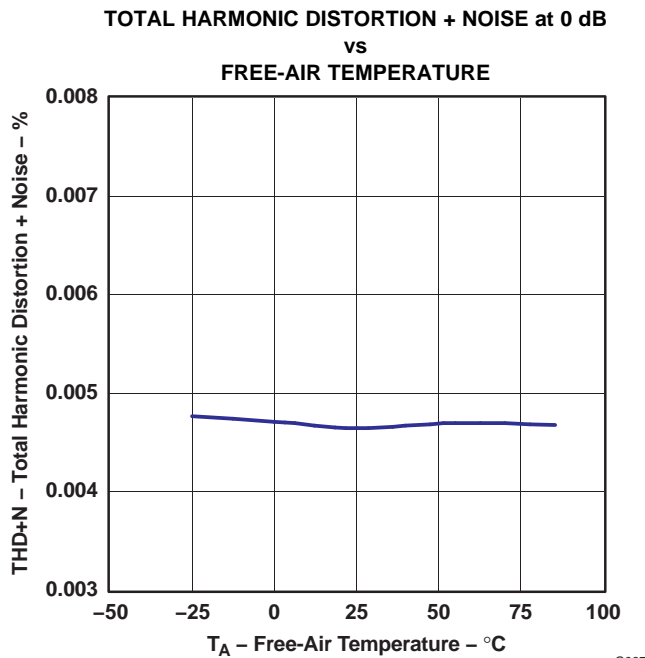

Figure 7.

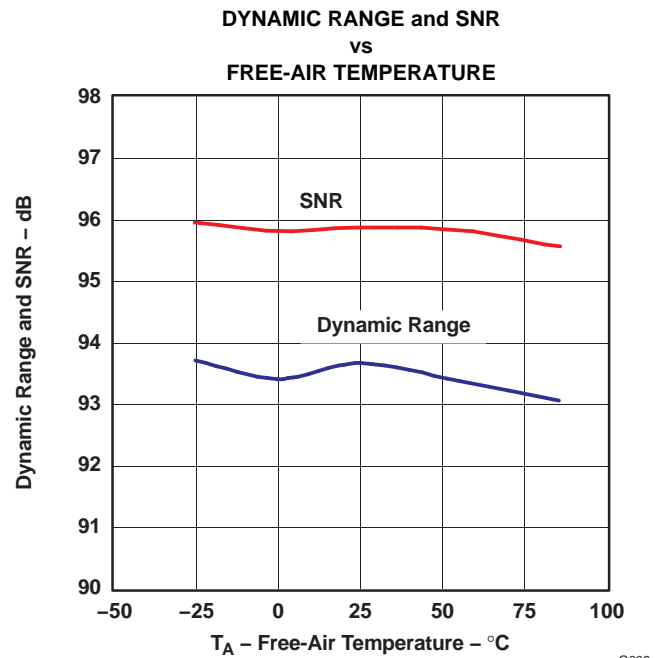

Figure 8.

TYPICAL CHARACTERISTICS: DAC (continued)

All specifications at $T_A = +25^\circ\text{C}$, $V_{DD} = V_{CCC} = V_{CCP1} = V_{CCP2} = V_{CCx} = 3.3\text{ V}$, $f_s = 44.1\text{ kHz}$, $f_{IN} = 1\text{ kHz}$, 16-bit data, unless otherwise noted.

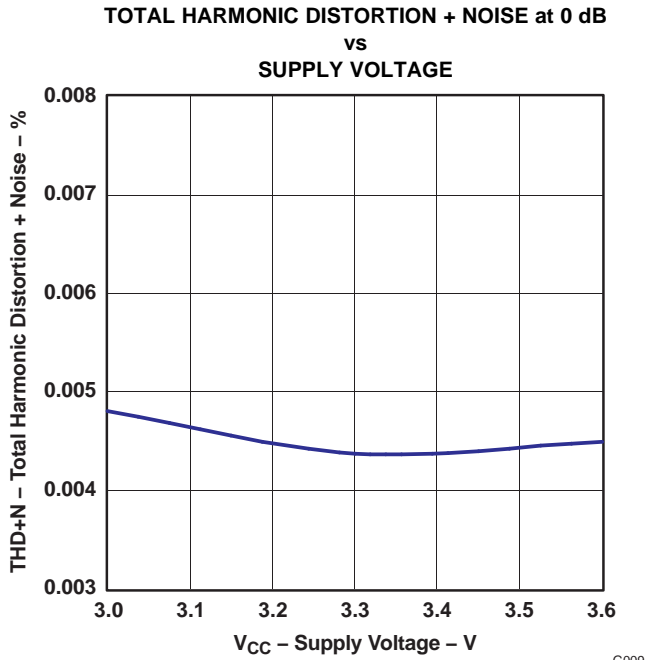

Figure 9.

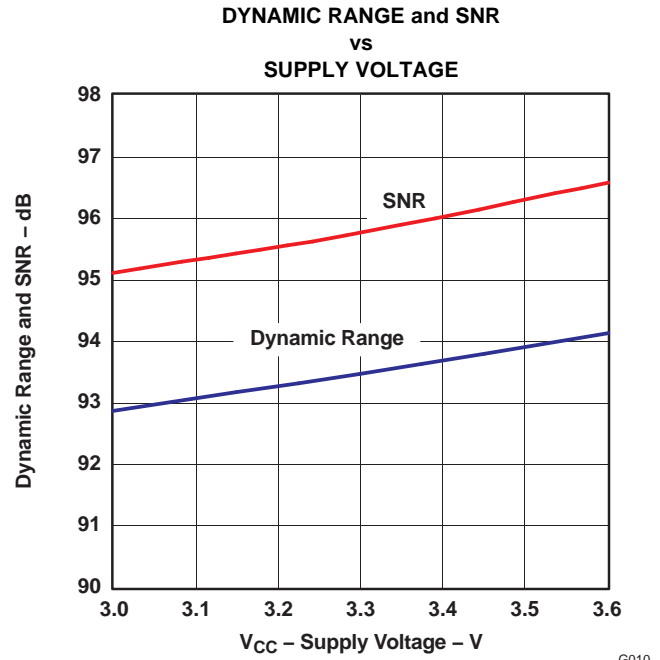

Figure 10.

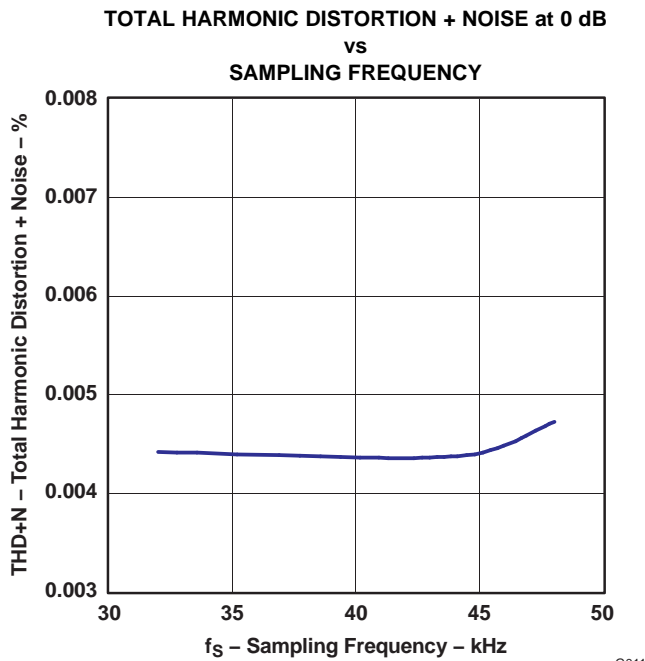

Figure 11.

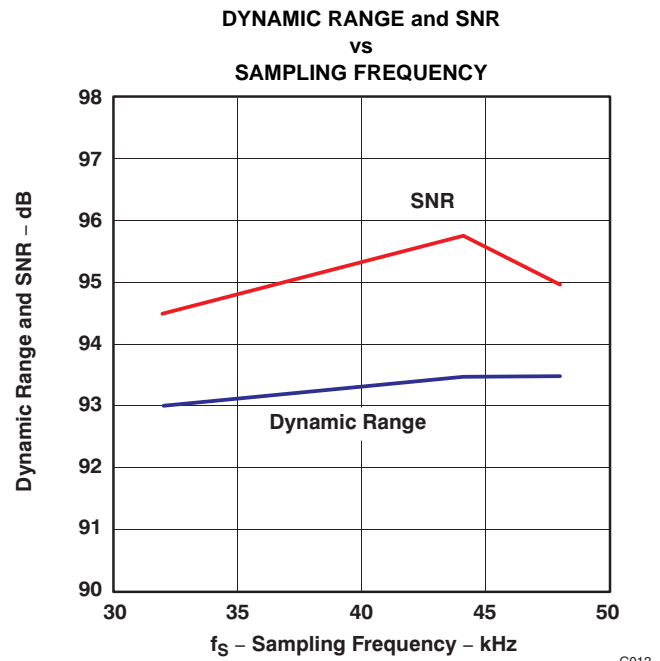

Figure 12.

TYPICAL CHARACTERISTICS: ADC OUTPUT SPECTRUM

All specifications at $T_A = +25^\circ\text{C}$, $V_{DD} = V_{CCC} = V_{CCP1} = V_{CCP2} = V_{CCX} = 3.3\text{ V}$, $f_s = 44.1\text{ kHz}$, $f_{IN} = 1\text{ kHz}$, 16-bit data, unless otherwise noted.

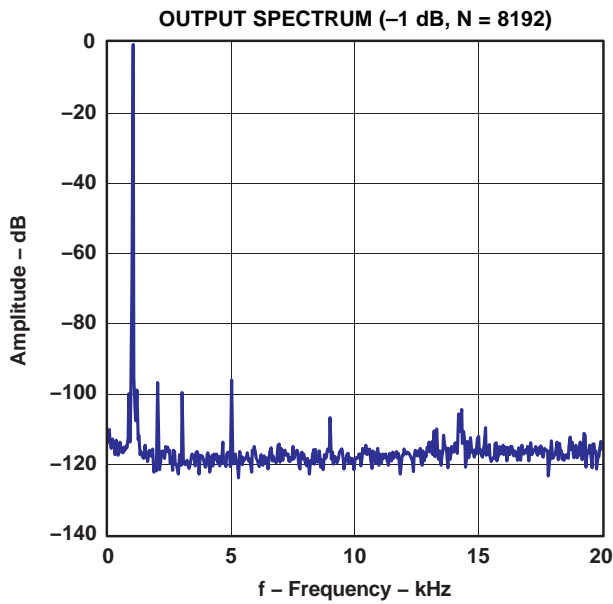

Figure 13.

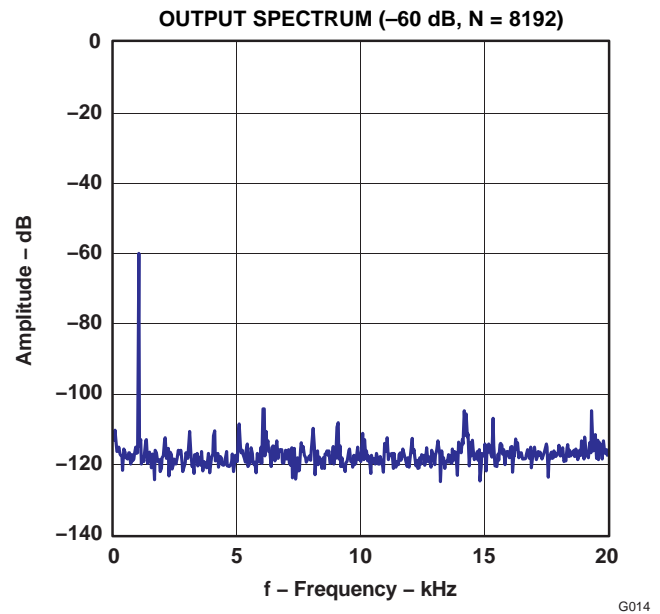

Figure 14.

TYPICAL CHARACTERISTICS: DAC OUTPUT SPECTRUM

All specifications at $T_A = +25^\circ\text{C}$, $V_{DD} = V_{CCC} = V_{CCP1} = V_{CCP2} = V_{CCX} = 3.3\text{ V}$, $f_s = 44.1\text{ kHz}$, $f_{IN} = 1\text{ kHz}$, 16-bit data, unless otherwise noted.

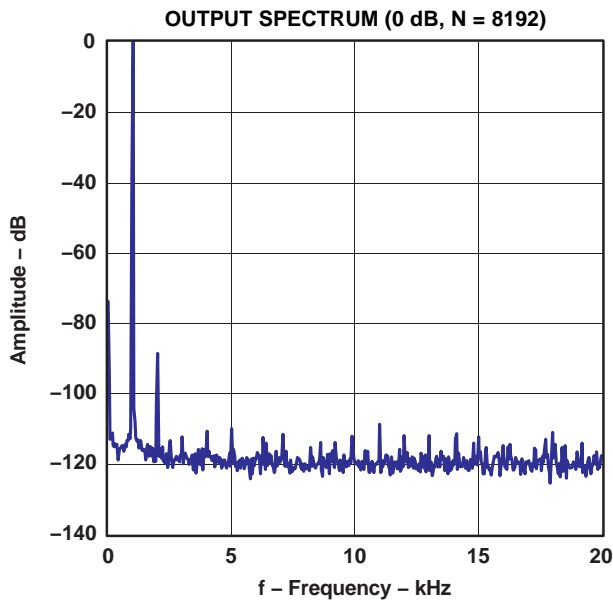

Figure 15.

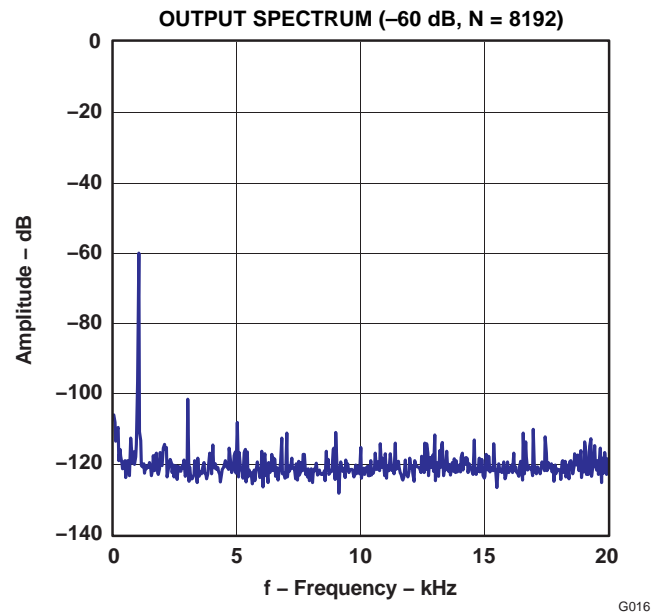

Figure 16.

TYPICAL CHARACTERISTICS: SUPPLY CURRENT

All specifications at $T_A = +25^\circ\text{C}$, $V_{DD} = V_{CCC} = V_{CCP1} = V_{CCP2} = V_{CCX} = 3.3\text{ V}$, $f_s = 44.1\text{ kHz}$, $f_{IN} = 1\text{ kHz}$, 16-bit data, unless otherwise noted.

OPERATIONAL and SUSPEND SUPPLY CURRENT vs SUPPLY VOLTAGE

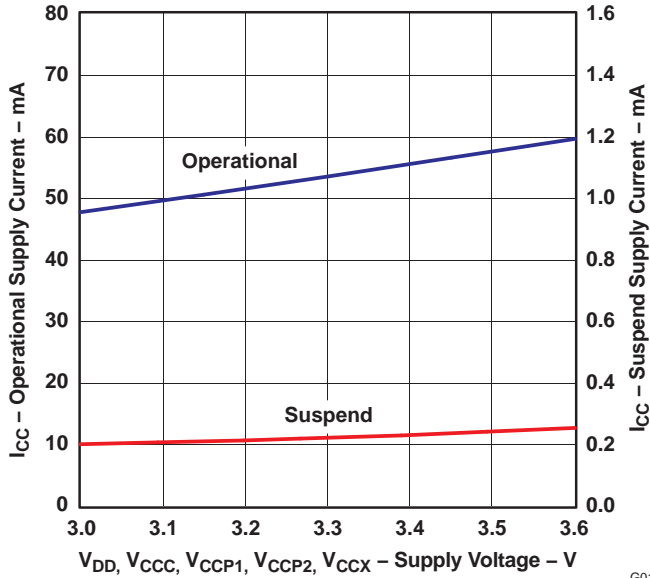

Figure 17.

G017

OPERATIONAL SUPPLY CURRENT vs SAMPLING FREQUENCY

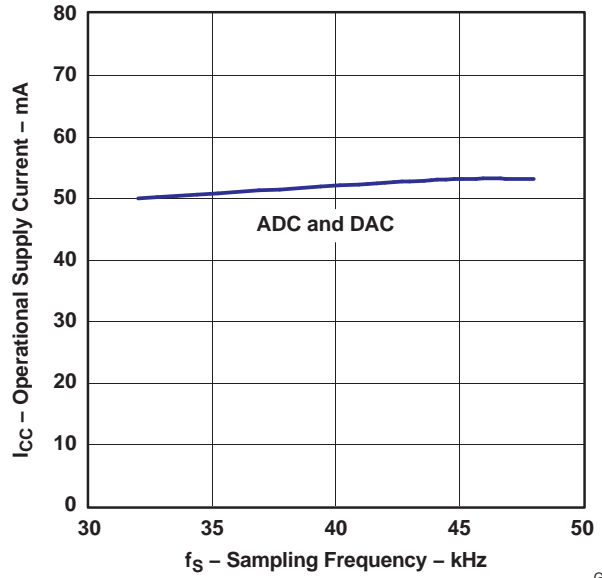

Figure 18.

G018

TYPICAL CHARACTERISTICS: ADC DIGITAL DECIMATION FILTER FREQUENCY RESPONSE

All specifications at $T_A = +25^\circ\text{C}$, $V_{DD} = V_{CCC} = V_{CCP1} = V_{CCP2} = V_{CCX} = 3.3\text{ V}$, $f_s = 44.1\text{ kHz}$, $f_{IN} = 1\text{ kHz}$, 16-bit data, unless otherwise noted.

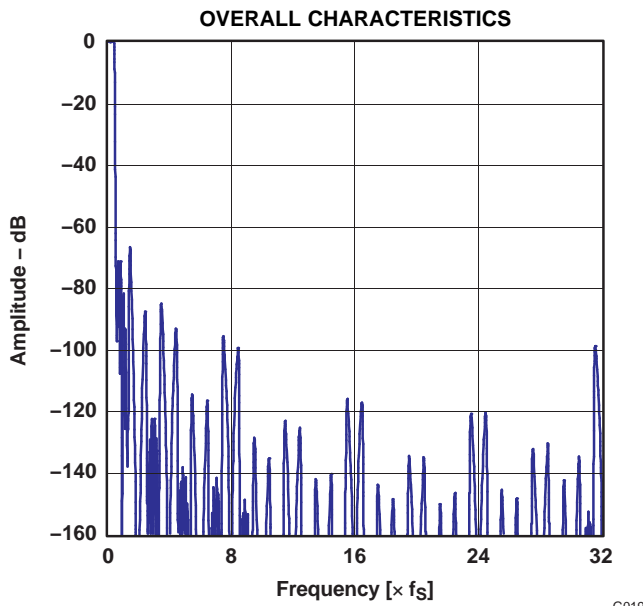

Figure 19.

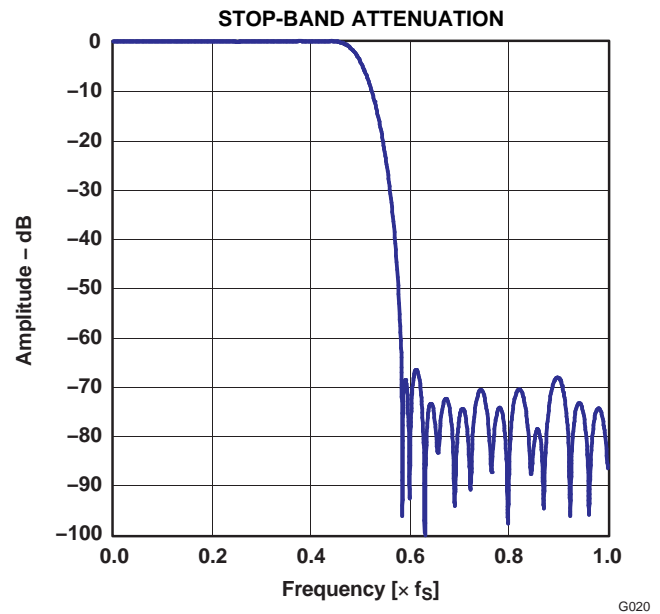

Figure 20.

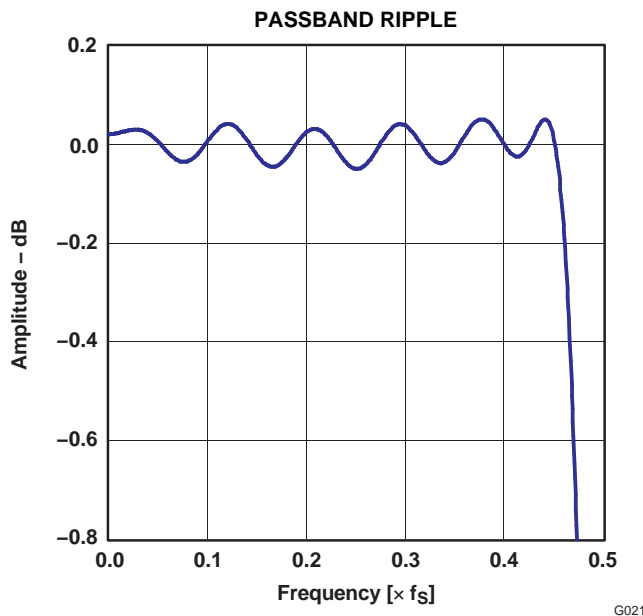

Figure 21.

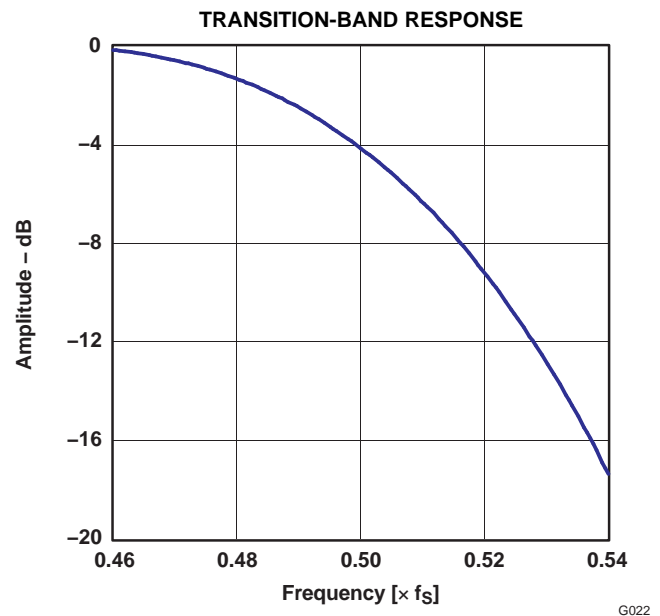

Figure 22.

TYPICAL CHARACTERISTICS: ADC DIGITAL HIGH-PASS FILTER FREQUENCY RESPONSE

All specifications at $T_A = +25^\circ\text{C}$, $V_{DD} = V_{CCC} = V_{CCP1} = V_{CCP2} = V_{CCX} = 3.3\text{ V}$, $f_s = 44.1\text{ kHz}$, $f_{IN} = 1\text{ kHz}$, 16-bit data, unless otherwise noted.

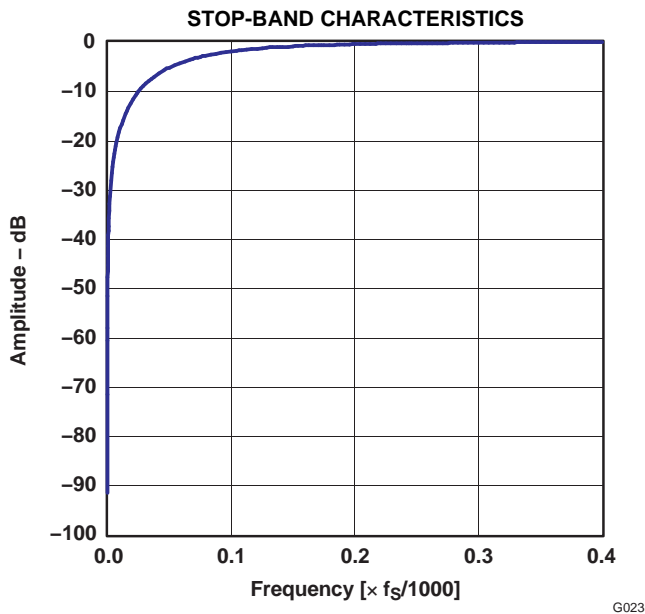

Figure 23.

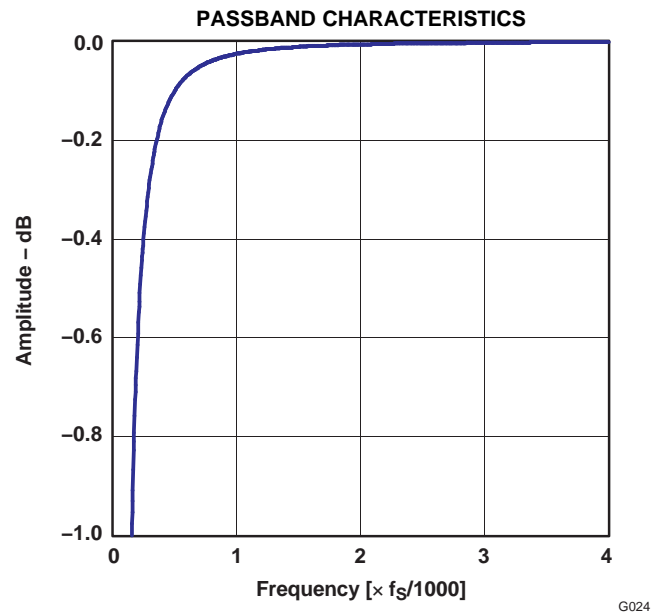

Figure 24.

TYPICAL CHARACTERISTICS: ADC ANALOG ANTIALIASING FILTER FREQUENCY RESPONSE

All specifications at $T_A = +25^\circ\text{C}$, $V_{DD} = V_{CCC} = V_{CCP1} = V_{CCP2} = V_{CCX} = 3.3\text{ V}$, $f_s = 44.1\text{ kHz}$, $f_{IN} = 1\text{ kHz}$, 16-bit data, unless otherwise noted.

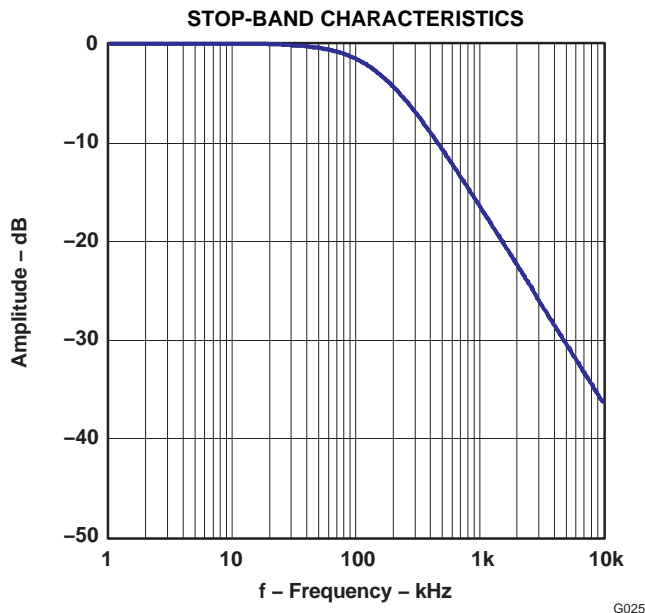

Figure 25.

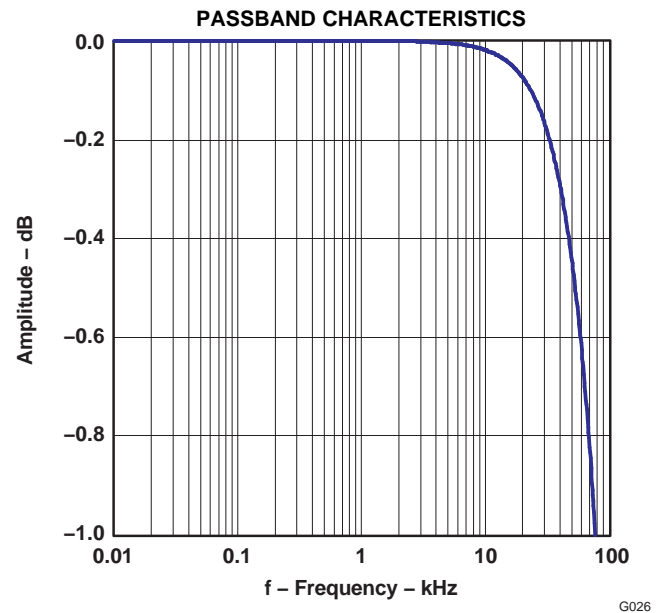

Figure 26.

TYPICAL CHARACTERISTICS: DAC DIGITAL INTERPOLATION FILTER FREQUENCY RESPONSE

All specifications at $T_A = +25^\circ\text{C}$, $V_{DD} = V_{CC} = V_{CCP1} = V_{CCP2} = V_{CCx} = 3.3\text{ V}$, $f_s = 44.1\text{ kHz}$, $f_{IN} = 1\text{ kHz}$, 16-bit data, unless otherwise noted.

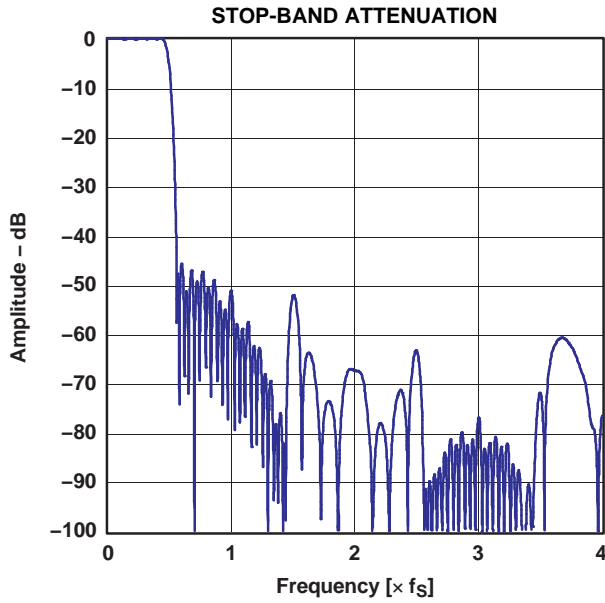

Figure 27.

G027

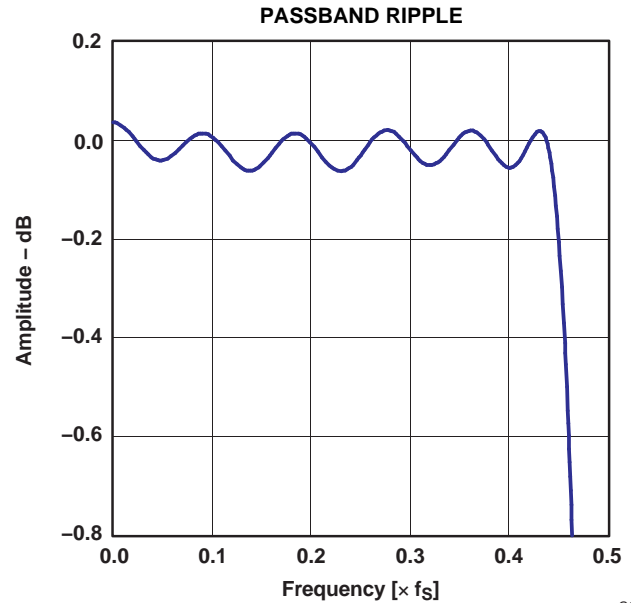

Figure 28.

G028

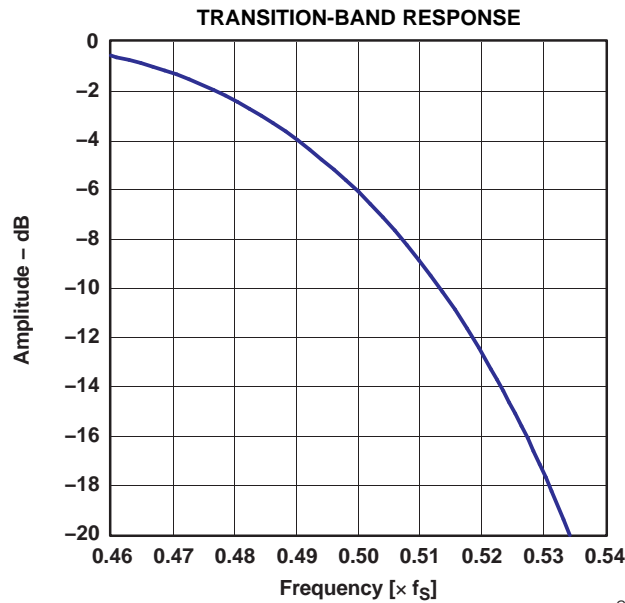

Figure 29.

G029

TYPICAL CHARACTERISTICS: DAC ANALOG FIR FILTER FREQUENCY RESPONSE

All specifications at $T_A = +25^\circ\text{C}$, $V_{DD} = V_{CCC} = V_{CCP1} = V_{CCP2} = V_{CCx} = 3.3\text{ V}$, $f_s = 44.1\text{ kHz}$, $f_{IN} = 1\text{ kHz}$, 16-bit data, unless otherwise noted.

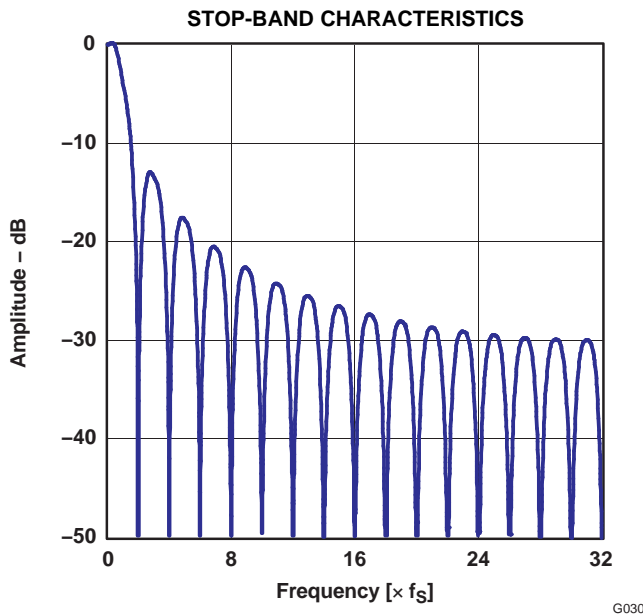

Figure 30.

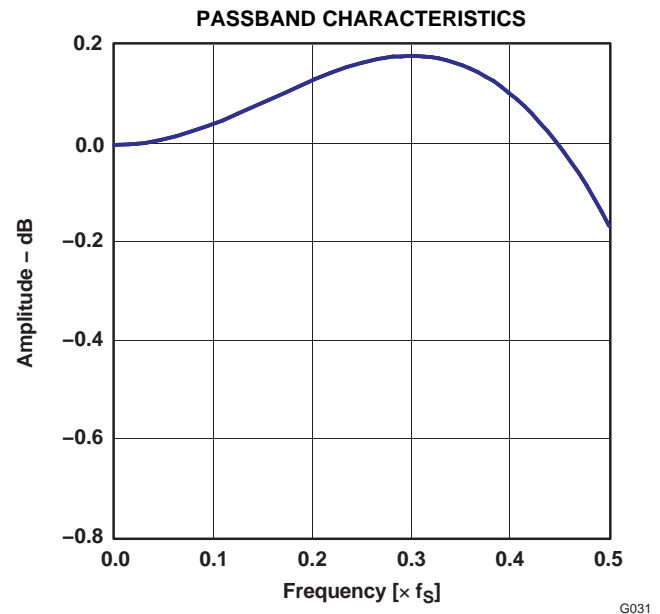

Figure 31.

TYPICAL CHARACTERISTICS: DAC ANALOG LOW-PASS FILTER FREQUENCY RESPONSE

All specifications at $T_A = +25^\circ\text{C}$, $V_{DD} = V_{CCC} = V_{CCP1} = V_{CCP2} = V_{CCx} = 3.3\text{ V}$, $f_s = 44.1\text{ kHz}$, $f_{IN} = 1\text{ kHz}$, 16-bit data, unless otherwise noted.

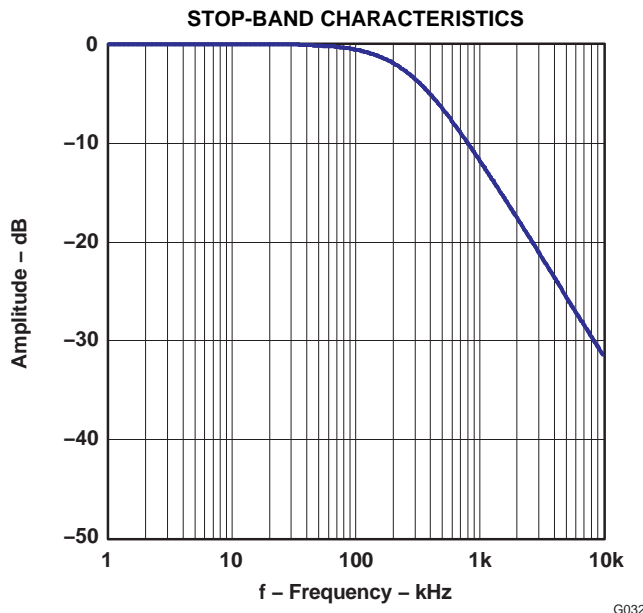

Figure 32.

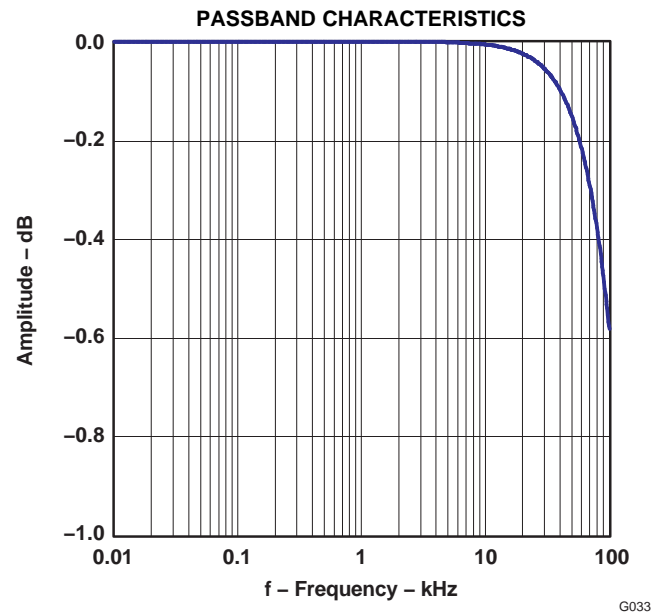

Figure 33.

DETAILED DESCRIPTION

USB INTERFACE

Control data and audio data are transferred to the PCM2903B via D+ (pin 1) and D– (pin 2). All data to/from the PCM2903B are transferred at full speed. The device descriptor contains the information described in [Table 2](#). The device descriptor can be modified on request; contact a Texas Instruments representative for details.

Table 2. Device Descriptor

USB revision	2.0 compliant
Device class	0x00 (device-defined interface level)
Device subclass	0x00 (not specified)
Device protocol	0x00 (not specified)
Max packet size for end-point 0	8 bytes
Vendor ID	0x08BB (default value, can be modified)
Product ID	0x29B3 (default value, can be modified)
Device release number	1.0 (0x0100)
Number of configurations	1
Vendor strings	String #1 (see Table 4)
Product strings	String #2 (see Table 4)
Serial number	Not supported

The configuration descriptor contains the information described in [Table 3](#). The configuration descriptor can be modified on request; contact a Texas Instruments representative for details.

Table 3. Configuration Descriptor

Interface	Four interfaces
Power attribute	0xC0 (Self-powered, no remote wakeup)
Maximum power	0x0A (20 mA. Default value, can be modified)

The string descriptor contains the information described in [Table 4](#). The string descriptor can be modified on request; contact a Texas Instruments representative for details.

Table 4. String Descriptor

#0	0x0409
#1	Burr-Brown from TI (default value, can be modified)
#2	USB Audio CODEC (default value, can be modified)

DEVICE CONFIGURATON

Figure 34 illustrates the USB audio function topology. The PCM2903B has four interfaces. Each interface consists of alternative settings.

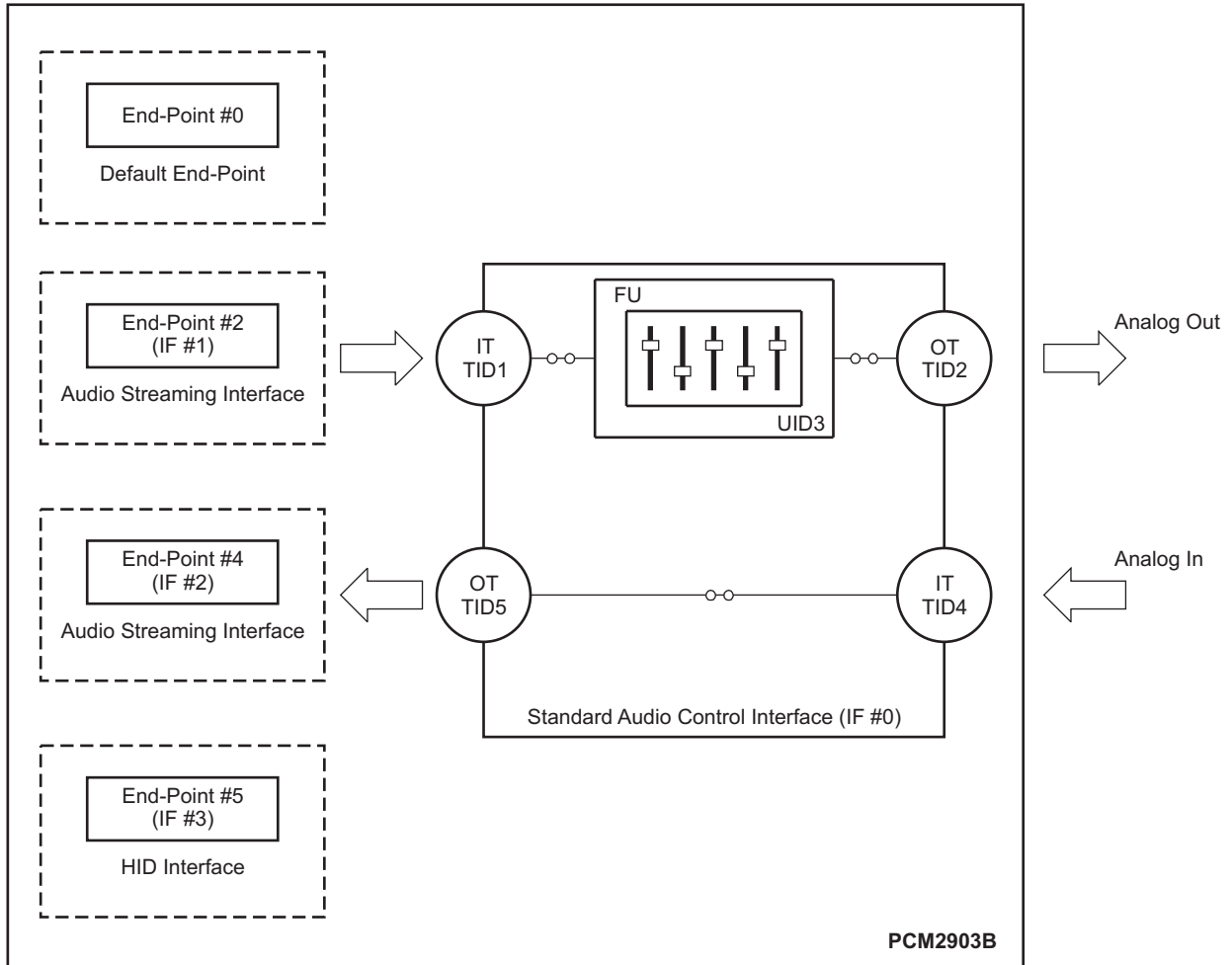

M0024-04

Figure 34. USB Audio Function Topology

Interface #0

Interface #0 is the control interface. Alternative setting #0 is the only possible setting for interface #0. Alternative setting #0 describes the standard audio control interface. The audio control interface consists of a single terminal. The PCM2903B has the following five terminals:

- Input terminal (IT #1) for isochronous-out stream
- Output terminal (OT #2) for audio analog output
- Feature unit (FU #3) for DAC digital attenuator
- Input terminal (IT #4) for audio analog input
- Output terminal (OT #5) for isochronous-in stream

Input terminal #1 is defined as *USB stream* (terminal type 0x0101). Input terminal #1 can accept two-channel audio streams consisting of left and right channels. Output terminal #2 is defined as a *speaker* (terminal type 0x0301). Input terminal #4 is defined as a *microphone* (terminal type 0x0201). Output terminal #5 is defined as a *USB stream* (terminal type 0x0101). Output terminal #5 can generate two-channel audio streams composed of left and right channel data. Feature unit #3 supports the following sound control features:

- Volume control
- Mute control

The built-in digital volume controller can be manipulated by an audio class specific request from 0 dB to –64 dB in 1-dB steps. Changes are made by incrementing or decrementing by one step (1 dB) for every $1/f_s$ time interval until the volume level has reached the requested value. Each channel can be set for different values. The master volume control is not supported. A request to the master volume is stalled and ignored. The built-in digital mute controller can be manipulated by audio class-specific request. A master mute control request is acceptable. A request to an individual channel is stalled and ignored.

Interface #1

Interface #1 is the audio streaming data-out interface. Interface #1 has the five alternative settings described in [Table 5](#). Alternative setting #0 is the zero-bandwidth setting.

Table 5. Interface #1 Alternative Settings

ALTERNATIVE SETTING	DATA FORMAT			TRANSFER MODE	SAMPLING RATE (kHz)
00	Zero bandwidth				
01	16-bit	Stereo	Twos complement (PCM)	Adaptive	32, 44.1, 48
02	16-bit	Mono	Twos complement (PCM)	Adaptive	32, 44.1, 48
03	8-bit	Stereo	Twos complement (PCM)	Adaptive	32, 44.1, 48
04	8-bit	Mono	Twos complement (PCM)	Adaptive	32, 44.1, 48

Interface #2

Interface #2 is the audio streaming data-in interface. Interface #2 has the 19 alternative settings described in [Table 6](#). Alternative setting #0 is the zero-bandwidth setting. All other alternative settings are operational settings.

Table 6. Interface #2 Alternative Settings

ALTERNATIVE SETTING	DATA FORMAT			TRANSFER MODE	SAMPLING RATE (kHz)
00	Zero bandwidth				
01	16-bit	Stereo	Twos complement (PCM)	Asynchronous	48
02	16-bit	Mono	Twos complement (PCM)	Asynchronous	48
03	16-bit	Stereo	Twos complement (PCM)	Asynchronous	44.1
04	16-bit	Mono	Twos complement (PCM)	Asynchronous	44.1
05	16-bit	Stereo	Twos complement (PCM)	Asynchronous	32
06	16-bit	Mono	Twos complement (PCM)	Asynchronous	32
07	16-bit	Stereo	Twos complement (PCM)	Asynchronous	22.05
08	16-bit	Mono	Twos complement (PCM)	Asynchronous	22.05
09	16-bit	Stereo	Twos complement (PCM)	Asynchronous	16
0A	16-bit	Mono	Twos complement (PCM)	Asynchronous	16
0B	8-bit	Stereo	Twos complement (PCM)	Asynchronous	16
0C	8-bit	Mono	Twos complement (PCM)	Asynchronous	16
0D	8-bit	Stereo	Twos complement (PCM)	Asynchronous	8
0E	8-bit	Mono	Twos complement (PCM)	Asynchronous	8
0F	16-bit	Stereo	Twos complement (PCM)	Synchronous	11.025
10	16-bit	Mono	Twos complement (PCM)	Synchronous	11.025
11	8-bit	Stereo	Twos complement (PCM)	Synchronous	11.025
12	8-bit	Mono	Twos complement (PCM)	Synchronous	11.025

Interface #3

Interface #3 is the interrupt data-in interface. Alternative setting #0 is the only possible setting for interface #3. Interface #3 consists of the HID consumer control device and reports the status of these three key parameters:

- Mute (0xE209)
- Volume up (0xE909)
- Volume down (0xEA09)

End-Points

The PCM2903B has the following four end-points:

- Control end-point (EP #0)
- Isochronous-out audio data stream end-point (EP #2)
- Isochronous-in audio data stream end-point (EP #4)
- HID end-point (EP #5)

The control end-point is a default end-point. The control end-point is used to control all functions of the PCM2903B by the standard USB request and an USB audio class specific request from the host. The isochronous-out audio data stream end-point is an audio sink end-point, which receives the PCM audio data. The isochronous-out audio data stream end-point accepts the adaptive transfer mode. The isochronous-in audio data stream end-point is an audio source end-point that transmits the PCM audio data. The isochronous-in audio data stream end-point uses asynchronous transfer mode. The HID end-point is an interrupt-in end-point. HID end-point reports HID0, HID1, and HID2 pin status every 32 ms.

The human interface device (HID) pins are defined as consumer control devices. The HID function is designed as an independent end-point from both isochronous-in and -out end-points. Therefore, the result obtained from the HID operation depends on the host software. Typically, the HID function is used as the primary audio-out device.

Clock and Reset

The PCM2903B requires a 12-MHz (± 500 ppm) clock for the USB and audio function, which can be generated by a built-in crystal oscillator with a 12-MHz crystal resonator or supplied by an external clock. The 12-MHz crystal resonator must be connected to XTI (pin 21) and XTO (pin 20) with one high (1-M Ω) resistor and two small capacitors, the capacitance of which depends on the load capacitance of the crystal resonator. If the external clock is used, the clock must be supplied to XTI, and XTO must be open.

The PCM2903B has an internal power-on reset circuit, which triggers automatically when V_{DD} (pin 27) exceeds 2.5 V typical (2.7 V to 2.2 V). Approximately 700 μ s is required until internal reset release.

Digital Audio Interface

The PCM2903B employs both S/PDIF input and output. Isochronous-out data from the host are encoded to the S/PDIF output and the DAC analog output. Input data are selected as either S/PDIF or ADC analog input. When the device detects an S/PDIF input and successfully locks on the received data, the isochronous-in transfer data source is automatically selected from S/PDIF itself; otherwise, the data source selected is the ADC analog input.

This feature is a customer option. It is the responsibility of the user to implement this feature.

Supported Input/Output Data

The following data formats are accepted by the S/PDIF input and output. All other data formats are unable to use S/PDIF.

- 48-kHz 16-bit stereo
- 44.1-kHz 16-bit stereo
- 32-kHz 16-bit stereo

Any mismatch of the sampling rate between the input S/PDIF signal and the host command is not acceptable. Any mismatch of the data format between the input S/PDIF signal and the host command may cause unexpected results, with the following exceptions:

- Recording in monaural format from stereo data input at the same data rate
- Recording in 8-bit format from 16-bit data input at the same data rate

A combination of these two conditions is not acceptable.

For playback, all possible data-rate sources are converted to 16-bit stereo format at the same source data rate.

Channel Status Information

The channel status information is fixed as consumer application, PCM mode, copyright, and digital/digital converter. All other bits are fixed as 0's except for the sample frequency, which is set automatically according to the data received through the USB.

Copyright Management

Isochronous-in data are affected by the serial copy management system (SCMS). When the control bit indicates that the received digital audio data are original, the input digital audio data are transferred to the host. If the data are indicated as first generation or higher, the transferred data are routed to the analog input.

Digital audio data output is always encoded as original with SCMS control.

INTERFACE SEQUENCE

Power On, Attach, and Playback Sequence

The PCM2903B is ready for setup when the reset sequence has finished and the USB bus is attached. In order to perform certain reset sequences defined in the USB specification, V_{DD} , V_{CC0} , V_{CCP1} , V_{CCP2} , and V_{CCX} must rise up within 10 ms / 3.3 V. After connection has been established by setup, the PCM2903B is ready to accept USB audio data. While waiting, the audio data (idle state) and analog output are set to bipolar zero (BPZ).

When receiving the audio data, the PCM2903B stores the first audio packet, which contained 1-ms audio data, into the internal storage buffer. The PCM2903B starts playing the audio data when detecting the next start of frame (SOF) packet, as illustrated in Figure 35 and Figure 36.

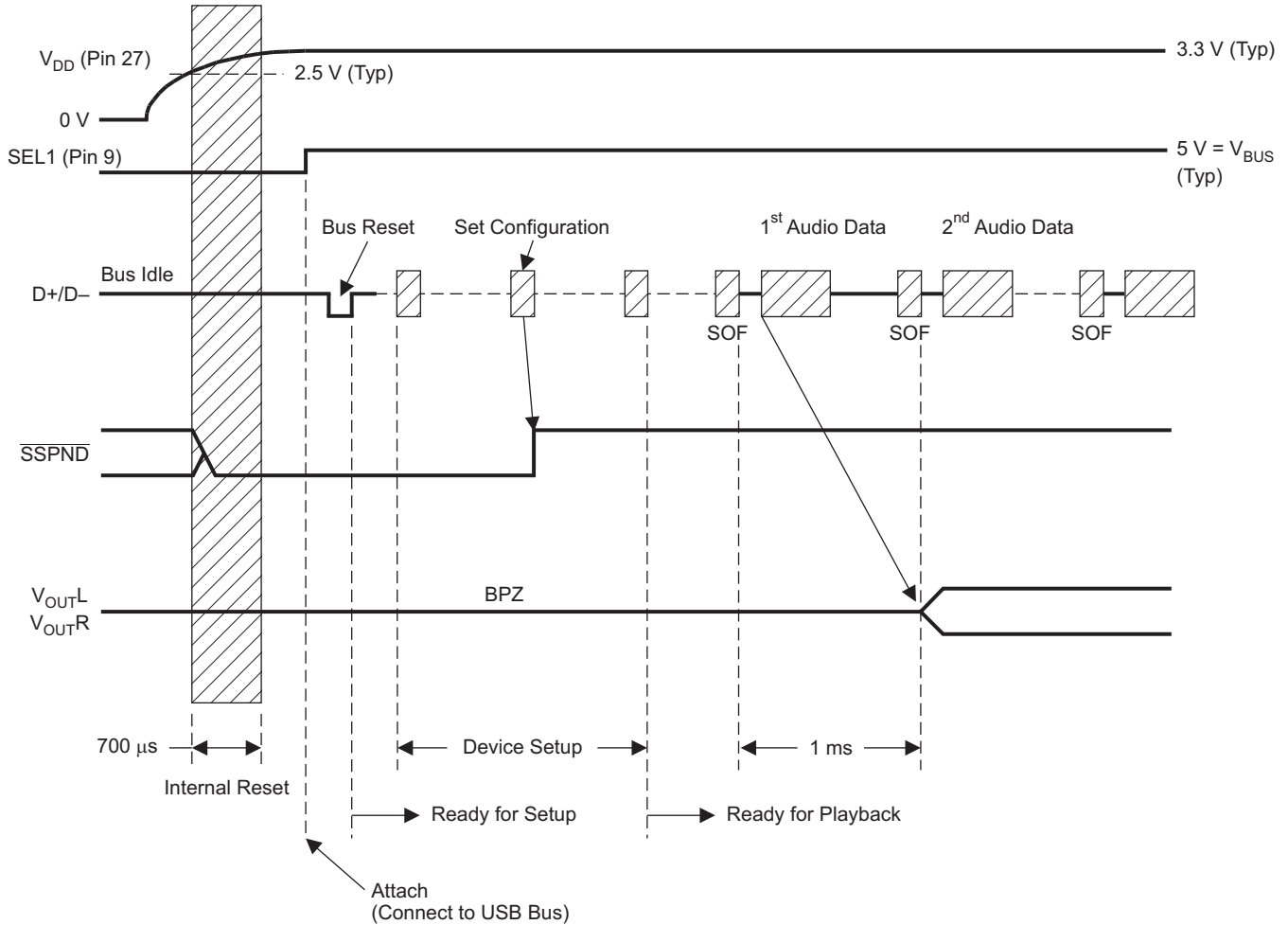

T0055-03

Figure 35. Attach After Power On

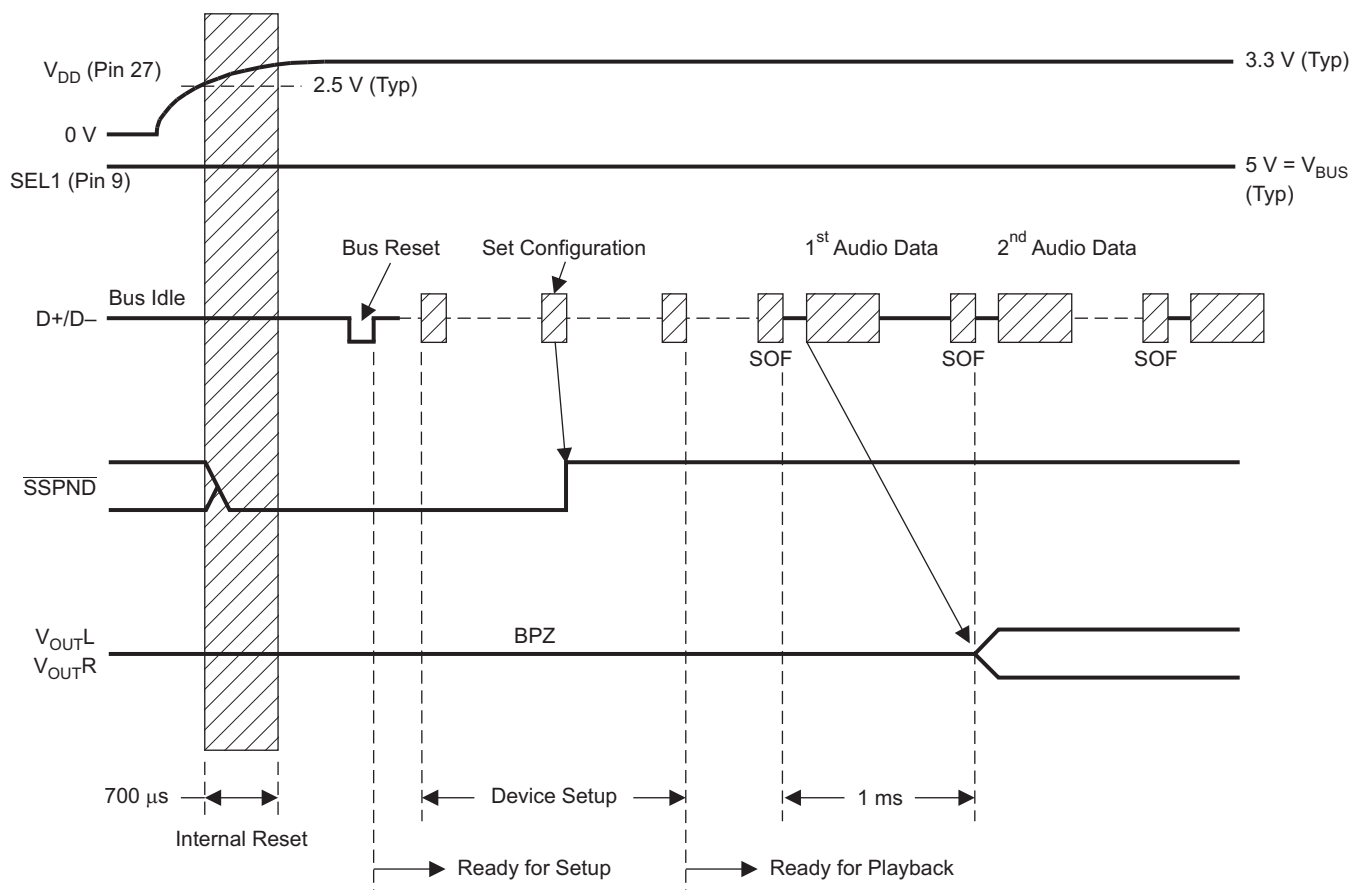

T0273-01

Figure 36. Power-On Under Attach

Play, Stop, and Detach Sequence

When the host finishes or aborts the playback, the PCM2903B stops playing after the last audio data have played, as shown in Figure 37.

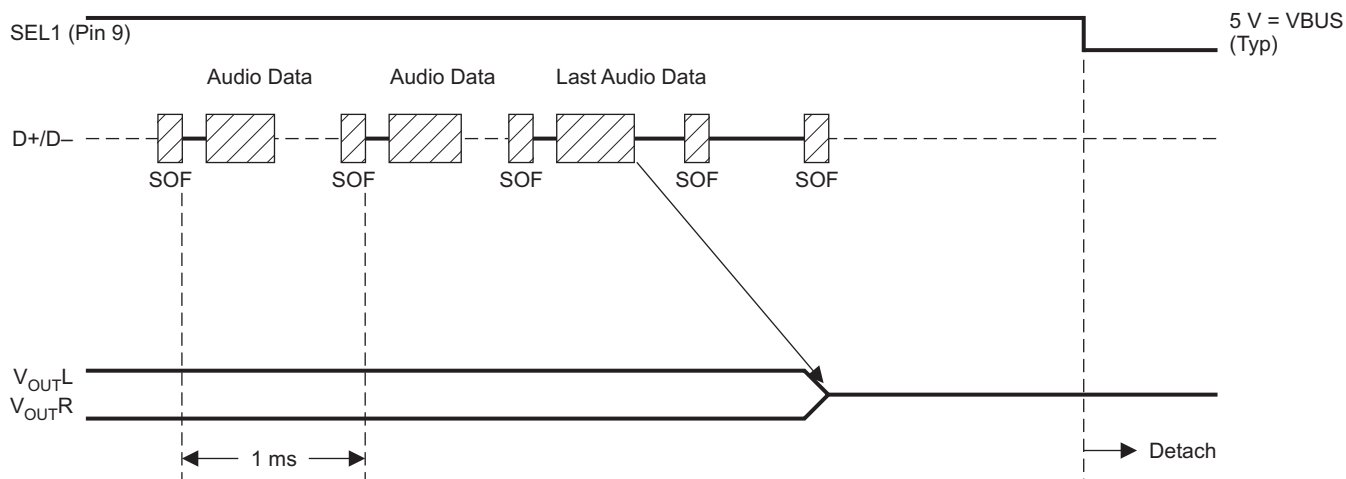

T0056-03

Figure 37. Play, Stop, and Detach Sequence

Record Sequence

The PCM2903B starts the audio capture into the internal memory after receiving the SET_INTERFACE command, as shown in Figure 38.

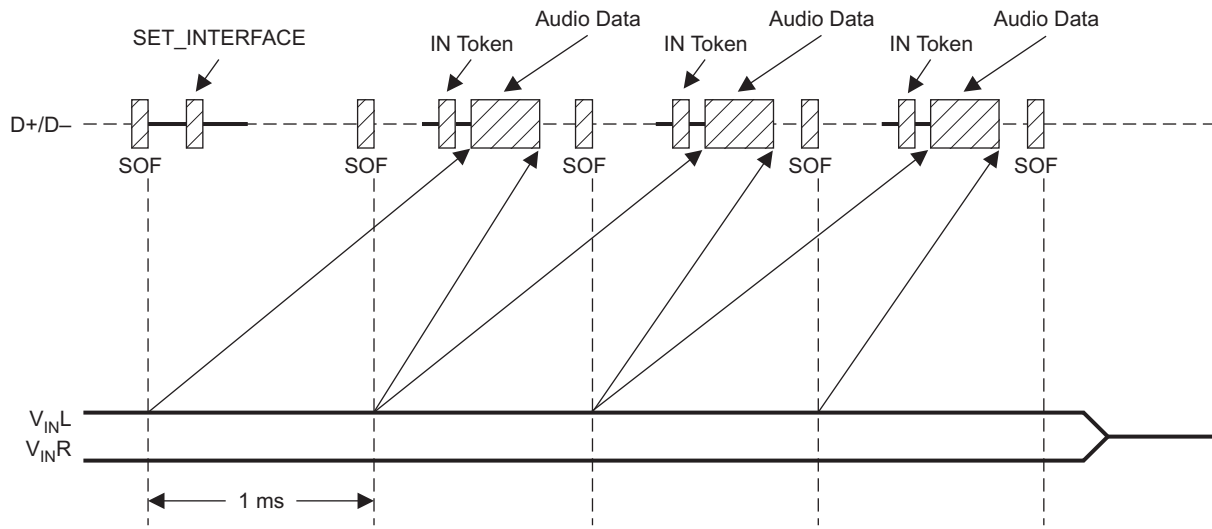

T0259-01

Figure 38. Record Sequence

Suspend and Resume Sequence

The PCM2903B enters the suspend state after it detects a constant idle state on the USB bus (approximately 5 ms), as shown in Figure 39. While the PCM2903B enters the suspend state, the SSPND flag (pin 28) is asserted. The PCM2903B wakes up immediately after detecting a non-idle state on the USB bus.

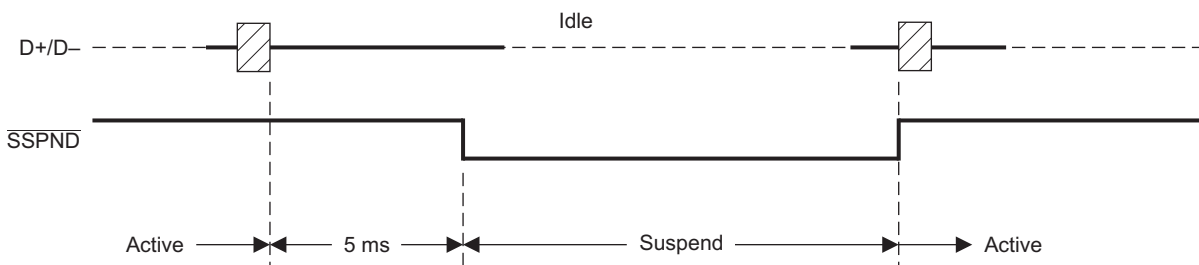

T0057-02

Figure 39. Suspend and Resume Sequence

APPLICATION INFORMATION

TYPICAL CIRCUIT CONNECTION

Figure 40 illustrates a typical circuit connection for a simple application. The circuit illustrated is for information only. The entire board design should be considered to meet the USB specification as a USB-compliant product.

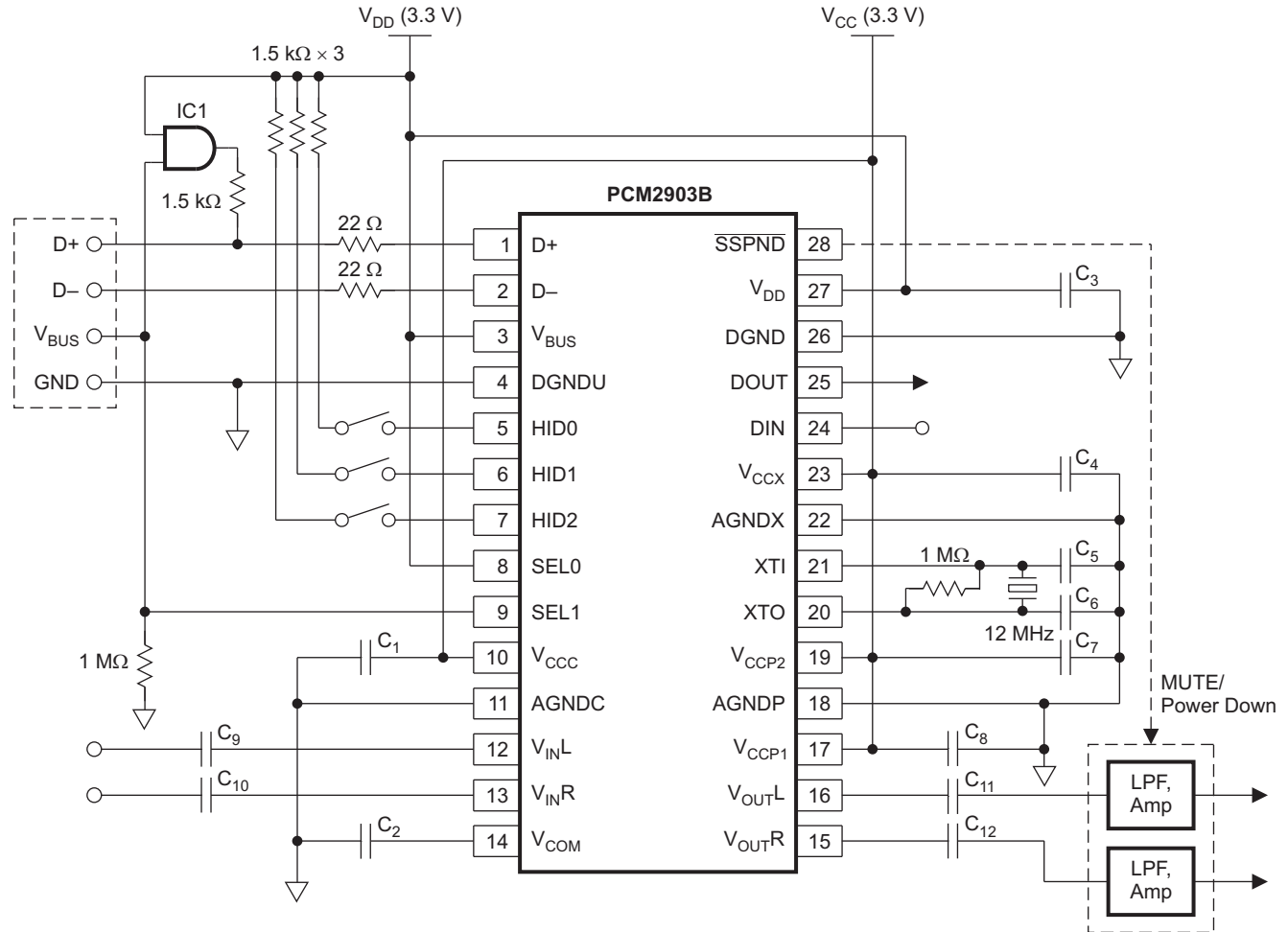

S0312-02

NOTE: IC1 must be driven by V_{DD} with a 5-V tolerant input.

$C_1, C_2, C_3, C_4, C_7, C_8$: 10 μ F

C_5, C_6 : 10 pF to 33 pF (depending on crystal resonator)

$C_9, C_{10}, C_{11}, C_{12}$: The capacitance may vary depending on design.

Figure 40. Self-Powered Configuration

Operating Environment

For current information on the PCM2903B operating environment, see the *Updated Operating Environments for PCM270X, PCM290X Applications* application report, [SLAA374](#).

PACKAGING INFORMATION

Orderable Device	Status (1)	Package Type	Package Drawing	Pins	Package Qty	Eco Plan (2)	Lead finish/ Ball material (6)	MSL Peak Temp (3)	Op Temp (°C)	Device Marking (4/5)	Samples
PCM2903BDB	NRND	SSOP	DB	28	50	RoHS & Green	Call TI NIPDAU	Level-1-260C-UNLIM	-25 to 85	PCM2903B	
PCM2903BDBR	NRND	SSOP	DB	28	2000	RoHS & Green	Call TI NIPDAU	Level-1-260C-UNLIM	-25 to 85	PCM2903B	

(1) The marketing status values are defined as follows:

ACTIVE: Product device recommended for new designs.

LIFEBUY: TI has announced that the device will be discontinued, and a lifetime-buy period is in effect.

NRND: Not recommended for new designs. Device is in production to support existing customers, but TI does not recommend using this part in a new design.

PREVIEW: Device has been announced but is not in production. Samples may or may not be available.

OBSELETE: TI has discontinued the production of the device.

(2) **RoHS:** TI defines "RoHS" to mean semiconductor products that are compliant with the current EU RoHS requirements for all 10 RoHS substances, including the requirement that RoHS substance do not exceed 0.1% by weight in homogeneous materials. Where designed to be soldered at high temperatures, "RoHS" products are suitable for use in specified lead-free processes. TI may reference these types of products as "Pb-Free".

RoHS Exempt: TI defines "RoHS Exempt" to mean products that contain lead but are compliant with EU RoHS pursuant to a specific EU RoHS exemption.

Green: TI defines "Green" to mean the content of Chlorine (Cl) and Bromine (Br) based flame retardants meet JS709B low halogen requirements of <=1000ppm threshold. Antimony trioxide based flame retardants must also meet the <=1000ppm threshold requirement.

(3) MSL, Peak Temp. - The Moisture Sensitivity Level rating according to the JEDEC industry standard classifications, and peak solder temperature.

(4) There may be additional marking, which relates to the logo, the lot trace code information, or the environmental category on the device.

(5) Multiple Device Markings will be inside parentheses. Only one Device Marking contained in parentheses and separated by a "~" will appear on a device. If a line is indented then it is a continuation of the previous line and the two combined represent the entire Device Marking for that device.

(6) Lead finish/Ball material - Orderable Devices may have multiple material finish options. Finish options are separated by a vertical ruled line. Lead finish/Ball material values may wrap to two lines if the finish value exceeds the maximum column width.

Important Information and Disclaimer:The information provided on this page represents TI's knowledge and belief as of the date that it is provided. TI bases its knowledge and belief on information provided by third parties, and makes no representation or warranty as to the accuracy of such information. Efforts are underway to better integrate information from third parties. TI has taken and continues to take reasonable steps to provide representative and accurate information but may not have conducted destructive testing or chemical analysis on incoming materials and chemicals. TI and TI suppliers consider certain information to be proprietary, and thus CAS numbers and other limited information may not be available for release.

In no event shall TI's liability arising out of such information exceed the total purchase price of the TI part(s) at issue in this document sold by TI to Customer on an annual basis.

TAPE AND REEL INFORMATION

QUADRANT ASSIGNMENTS FOR PIN 1 ORIENTATION IN TAPE



*All dimensions are nominal

Device	Package Type	Package Drawing	Pins	SPQ	Reel Diameter (mm)	Reel Width W1 (mm)	A0 (mm)	B0 (mm)	K0 (mm)	P1 (mm)	W (mm)	Pin1 Quadrant
PCM2903BDBR	SSOP	DB	28	2000	330.0	16.4	8.2	10.5	2.5	12.0	16.0	Q1

TAPE AND REEL BOX DIMENSIONS

*All dimensions are nominal

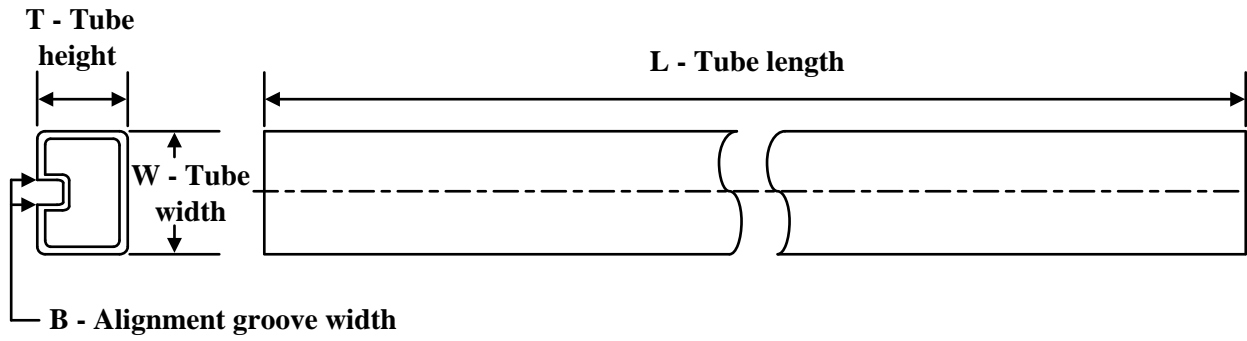
Device	Package Type	Package Drawing	Pins	SPQ	Length (mm)	Width (mm)	Height (mm)
PCM2903BDBR	SSOP	DB	28	2000	356.0	356.0	35.0

TUBE

*All dimensions are nominal

Device	Package Name	Package Type	Pins	SPQ	L (mm)	W (mm)	T (μm)	B (mm)
PCM2903BDB	DB	SSOP	28	50	530	10.5	4000	4.1
PCM2903BDB	DB	SSOP	28	50	530	10.5	4000	4.1

DB0028A



PACKAGE OUTLINE

SSOP - 2 mm max height

SMALL OUTLINE PACKAGE

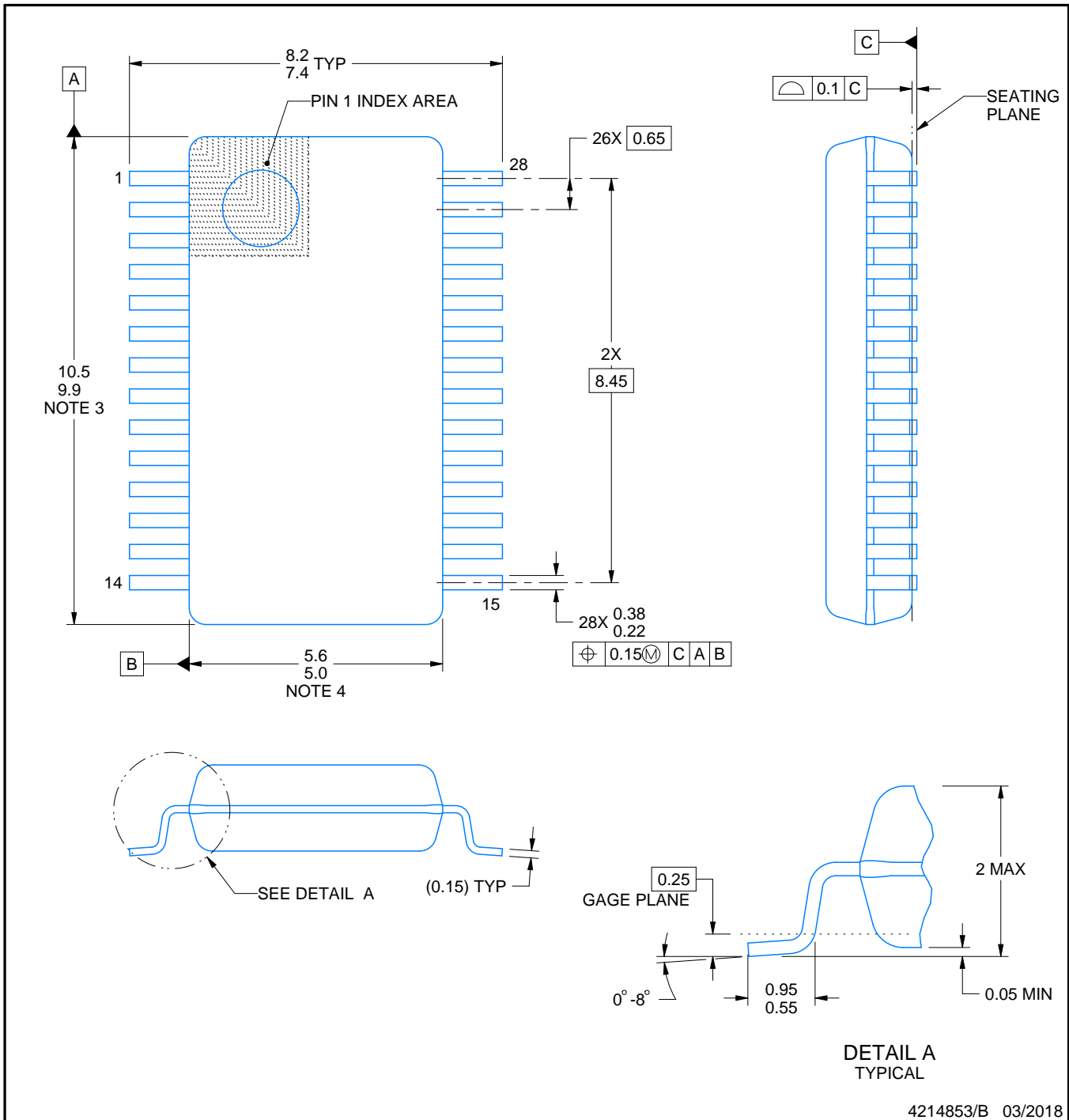

4214853/B 03/2018

NOTES:

1. All linear dimensions are in millimeters. Any dimensions in parenthesis are for reference only. Dimensioning and tolerancing per ASME Y14.5M.
2. This drawing is subject to change without notice.
3. This dimension does not include mold flash, protrusions, or gate burrs. Mold flash, protrusions, or gate burrs shall not exceed 0.15 mm per side.
4. This dimension does not include interlead flash. Interlead flash shall not exceed 0.25 mm per side.
5. Reference JEDEC registration MO-150.

EXAMPLE BOARD LAYOUT

DB0028A

SSOP - 2 mm max height

SMALL OUTLINE PACKAGE

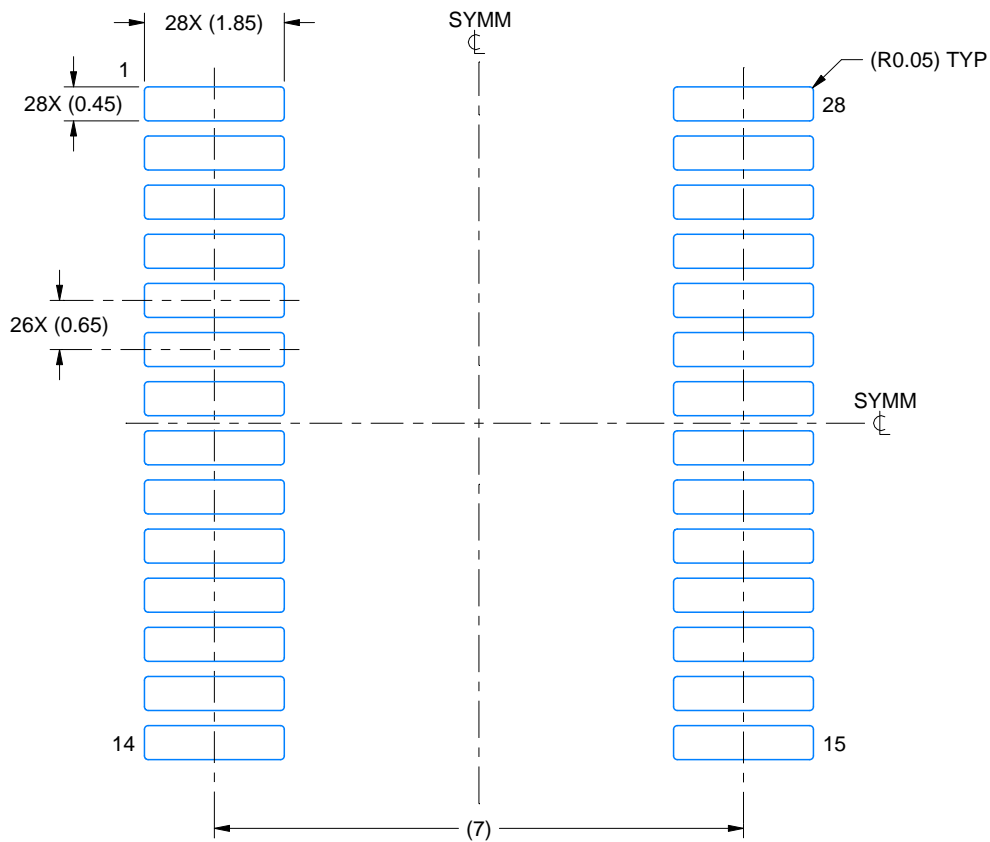

LAND PATTERN EXAMPLE
EXPOSED METAL SHOWN
SCALE: 10X



4214853/B 03/2018

NOTES: (continued)

- 6. Publication IPC-7351 may have alternate designs.
- 7. Solder mask tolerances between and around signal pads can vary based on board fabrication site.

EXAMPLE STENCIL DESIGN

DB0028A

SSOP - 2 mm max height

SMALL OUTLINE PACKAGE

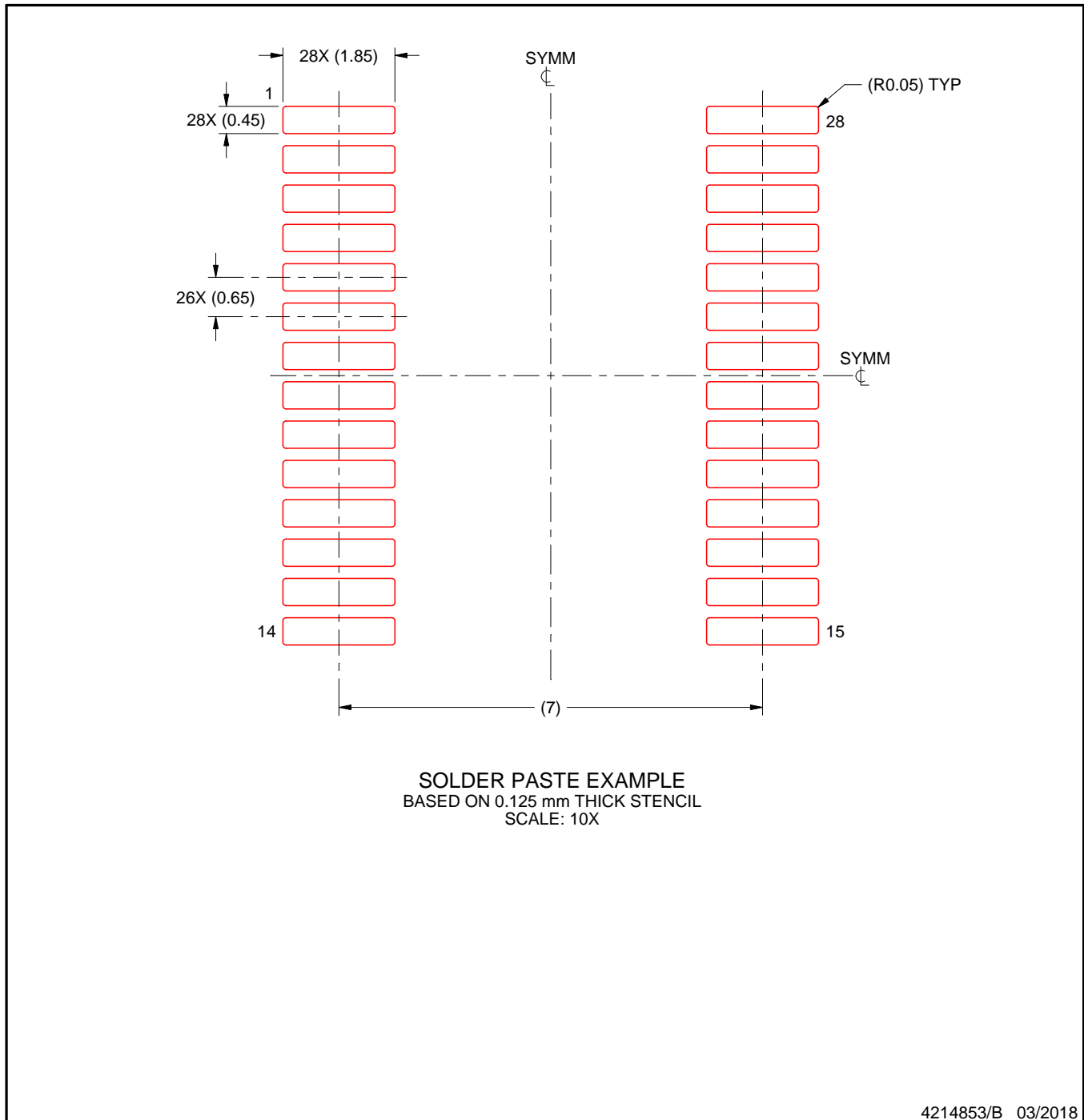

NOTES: (continued)

8. Laser cutting apertures with trapezoidal walls and rounded corners may offer better paste release. IPC-7525 may have alternate design recommendations.
9. Board assembly site may have different recommendations for stencil design.

IMPORTANT NOTICE AND DISCLAIMER

TI PROVIDES TECHNICAL AND RELIABILITY DATA (INCLUDING DATA SHEETS), DESIGN RESOURCES (INCLUDING REFERENCE DESIGNS), APPLICATION OR OTHER DESIGN ADVICE, WEB TOOLS, SAFETY INFORMATION, AND OTHER RESOURCES "AS IS" AND WITH ALL FAULTS, AND DISCLAIMS ALL WARRANTIES, EXPRESS AND IMPLIED, INCLUDING WITHOUT LIMITATION ANY IMPLIED WARRANTIES OF MERCHANTABILITY, FITNESS FOR A PARTICULAR PURPOSE OR NON-INFRINGEMENT OF THIRD PARTY INTELLECTUAL PROPERTY RIGHTS.

These resources are intended for skilled developers designing with TI products. You are solely responsible for (1) selecting the appropriate TI products for your application, (2) designing, validating and testing your application, and (3) ensuring your application meets applicable standards, and any other safety, security, regulatory or other requirements.

These resources are subject to change without notice. TI grants you permission to use these resources only for development of an application that uses the TI products described in the resource. Other reproduction and display of these resources is prohibited. No license is granted to any other TI intellectual property right or to any third party intellectual property right. TI disclaims responsibility for, and you will fully indemnify TI and its representatives against, any claims, damages, costs, losses, and liabilities arising out of your use of these resources.

TI's products are provided subject to [TI's Terms of Sale](#) or other applicable terms available either on [ti.com](https://www.ti.com) or provided in conjunction with such TI products. TI's provision of these resources does not expand or otherwise alter TI's applicable warranties or warranty disclaimers for TI products.

TI objects to and rejects any additional or different terms you may have proposed.

Mailing Address: Texas Instruments, Post Office Box 655303, Dallas, Texas 75265

Copyright © 2025, Texas Instruments Incorporated