

## TLE207x, TLE207xA Excalibur 低噪声高速精密运算放大器

### 1 特性

- 低失调电压：±300μV 典型值 (TLE2071A)
- 低噪声：1kHz 时为 17nV/√Hz
- 低偏置电流：±15pA
- 更宽的电源轨将动态信号范围增加至 ±19V
- 放大器以最高达到电源轨的差分输入工作
- 高带宽：10MHz GBW，单位增益稳定
- 提供最大本底噪声 17nV/√Hz

### 2 应用

- 交流充电（桩）站
- 交流驱动器功率级模块
- 电表
- 数字万用表 (DMM)
- 飞行控制单元
- 示波器和数字转换器

### 3 说明

TLE207x 和 TLE207xA 系列是高压放大器系列，可提供出色的直流精度和交流性能。这包括低本底噪声和高压摆率，因此 TLE207x 和 TLE207xA 系列是灵活的高性能放大器。TLE207x 和 TLE207xA 器件非常适合以下应用：

1. 高速数据采集
2. 低功率音频处理
3. 便携式和电池供电类器件

TLE207x 和 TLE207xA 采用标准封装 PDIP 和 SOIC。TLE207xM 和 TLE207xAM 器件采用原始设计，具有 JFET 输入晶体管和片上齐纳调零以补偿失调电压。TLE207xM、TLE207xAM 采用 CDIP、LCCC 和 CFP 封装。更多有关封装的信息，请参阅 节 10

#### 器件信息

器件型号 <sup>(1)</sup>	通道数	封装	封装尺寸 <sup>(2)</sup>
TLE2071	单通道	D (SOIC, 8)	4.9mm × 6mm
		FK (LCCC, 20)	8.89mm × 8.89mm
		JG (CDIP, 8)	9.58mm × 7.62mm
		P (PDIP, 8)	9.59mm × 7.94mm
		U (CDP, 10)	6.86mm × 22.4mm
TLE2072	双通道	D (SOIC, 8)	4.9mm × 6mm
		FK (LCCC, 20)	8.89mm × 8.89mm
		JG (CDIP, 8)	9.58mm × 7.62mm
		P (PDIP, 8)	9.59mm × 7.94mm
		U (CDP, 10)	6.86mm × 22.4mm
TLE2074	四通道	DW (SOIC, 14)	10.3mm × 10.3mm
		FK (LCCC, 20)	8.89mm × 8.89mm
		J (CDIP, 14)	19.6mm × 7.9mm
		N (PDIP, 14)	19.3mm × 7.94mm

(1) 如需了解所有可用封装，请参阅数据表末尾的可订购产品附录。

(2) 封装尺寸（长 × 宽）为标称值，并包括引脚（如适用）。

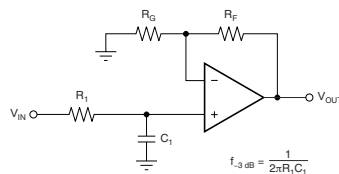

$$\frac{V_{OUT}}{V_{IN}} = \left(1 + \frac{R_F}{R_G}\right) \left(\frac{1}{1 + sR_1C_1}\right)$$

### TLE207X 和 TLE207XA 应用于单极低通滤波器



## 内容

<b>1 特性</b> .....	1	6.23 TLE2072M 电气特性.....	28
<b>2 应用</b> .....	1	6.24 TLE2072M 工作特性 5V.....	29
<b>3 说明</b> .....	1	6.25 TLE2072M 电气特性.....	30
<b>4 TLE207X 可用选项</b> .....	3	6.26 TLE2072M 工作特性.....	31
<b>5 引脚配置和功能</b> .....	4	6.27 TLE2074C 电气特性.....	32
<b>6 规格</b> .....	7	6.28 TLE2074C 工作特性.....	33
6.1 绝对最大额定值.....	7	6.29 TLE2074C 电气特性.....	34
6.2 建议运行条件.....	8	6.30 TLE2074C 工作特性.....	35
6.3 TLE2071C 电气特性.....	8	6.31 TLE2074I 电气特性.....	36
6.4 TLE2071C 工作特性.....	9	6.32 TLE2074I 工作特性.....	37
6.5 TLE2071C 电气特性.....	9	6.33 TLE2074I 电气特性.....	38
6.6 TLE2071C 工作特性.....	10	6.34 TLE2074I 工作特性.....	39
6.7 TLE2071I 电气特性.....	12	6.35 TLE2074M 电气特性.....	40
6.8 TLE2071I 工作特性.....	13	6.36 TLE2074M 工作特性.....	41
6.9 TLE2071I 电气特性.....	14	6.37 TLE2074M 电气特性.....	42
6.10 TLE2071I 工作特性.....	15	6.38 TLE2074M 工作特性.....	43
6.11 TLE2071M 电气特性.....	16	6.39 典型特性.....	44
6.12 TLE2071M 工作特性.....	17	<b>7 应用和实施</b> .....	47
6.13 TLE2071M 电气特性.....	18	7.1 应用信息.....	47
6.14 TLE2071M 工作特性.....	19	<b>8 器件和文档支持</b> .....	48
6.15 TLE2072C 电气特性.....	20	8.1 接收文档更新通知.....	48
6.16 TLE2072C 工作特性.....	21	8.2 支持资源.....	48
6.17 TLE2072C 电气特性.....	22	8.3 商标.....	48
6.18 TLE2072C 工作特性 15V.....	23	8.4 静电放电警告.....	48
6.19 TLE2072I 电气特性.....	24	8.5 术语表.....	48
6.20 TLE2072I 工作特性.....	25	<b>9 修订历史记录</b> .....	48
6.21 TLE2072I 电气特性.....	26	<b>10 机械、封装和可订购信息</b> .....	49
6.22 TLE2072I 工作特性.....	27		

## 4 TLE207X 可用选项

表 4-1. TLE2071 可用选项

T <sub>A</sub>	在 25°C 时的 V <sub>IO</sub> 最大值	封装器件				
		小外形 (D) <sup>(1)</sup>	芯片载体 (FK)	陶瓷 DIP (JG)	塑料 DIP (P)	陶瓷扁平封装 (U)
0°C 至 70°C	2mV	TLE2071ACD	—	—	TLE2071ACP	—
	4mV	TLE2071CD	—	—	TLE2071CP	—
-40°C 至 85°C	2mV	TLE2071AID	—	—	TLE2071AIP	—
	4mV	TLE2071ID	—	—	TLE2071IP	—
-55°C 至 125°C	2mV	—	TLE2071AMFK	TLE2071AMJG	—	TLE2071AMU
	4mV	—	TLE2071MFK	TLE2071MJG	—	TLE2071MU

(1) D 封装可采用带卷形式供货。向器件类型添加了 R 后缀 (例如 TLE2071ACDR)。

表 4-2. TLE2072 可用选项

T <sub>A</sub>	在 25°C 时的 V <sub>IO</sub> 最大值	封装器件				
		小外形 (D) <sup>(1)</sup>	芯片载体 (FK)	陶瓷 DIP (JG)	塑料 DIP (P)	陶瓷扁平封装 (U)
0°C 至 70°C	3.5mV	TLE2072ACD	—	—	TLE2072ACP	—
	6mV	TLE2072CD	—	—	TLE2072CP	—
-40°C 至 85°C	3.5mV	TLE2072AID	—	—	TLE2072AIP	—
	6mV	TLE2072ID	—	—	TLE2072IP	—
-55°C 至 125°C	3.5mV	—	TLE2072AMFK	TLE2072AMJG	—	TLE2072AMU
	6mV	—	TLE2072MFK	TLE2072MJG	—	TLE2072MU

(1) D 封装可采用带卷形式供货。向器件类型添加了 R 后缀 (例如 TLE2072ACDR)。

表 4-3. TLE2074 可用选项

T <sub>A</sub>	在 25°C 时的 V <sub>IO</sub> 最大值	封装器件				
		小外形封装 (DW) <sup>(1)</sup>	芯片载体 (FK)	陶瓷 DIP (J)	塑料 DIP (N)	陶瓷扁平封装 (W)
0°C 至 70°C	3mV	TLE2074ACDW	—	—	TLE2074ACN	—
	5mV	TLE2074CDW	—	—	TLE2074CN	—
-40°C 至 85°C	3mV	TLE2074AIDW	—	—	TLE2074AIN	—
	5mV	TLE2074IDW	—	—	TLE2074IN	—
-55°C 至 125°C	3mV	—	TLE2074AMFK	TLE2074AMJ	—	TLE2074AMW
	5mV	—	TLE2074MFK	TLE2074MJ	—	TLE2074MW

(1) DW 封装可采用带卷形式供货。向器件类型添加了 R 后缀 (例如 TLE2074ACDWR)。



图 4-1. 符号

## 5 引脚配置和功能



图 5-1. TLE2071 和 TLE2071A D、或 P 封装  
 (顶视图)

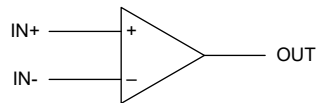

图 5-2. TLE2071 和 TLE2071A JG 封装  
 (顶视图)

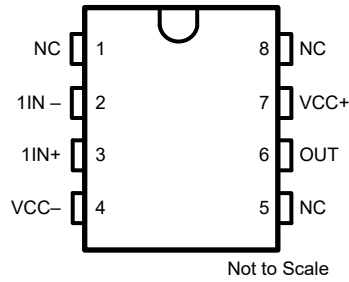

图 5-3. TLE2072 和 TLE2072A D、或 P 封装  
 (顶视图)

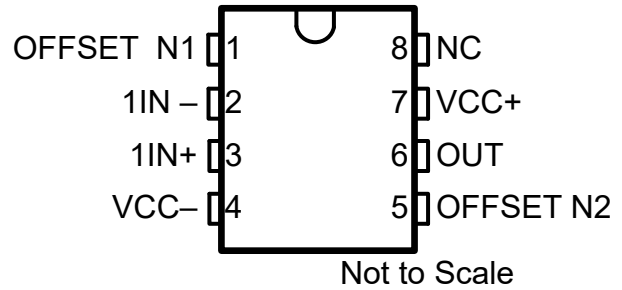

图 5-4. TLE2074 和 TLE2074A J、N 或 W 封装  
 (顶视图)

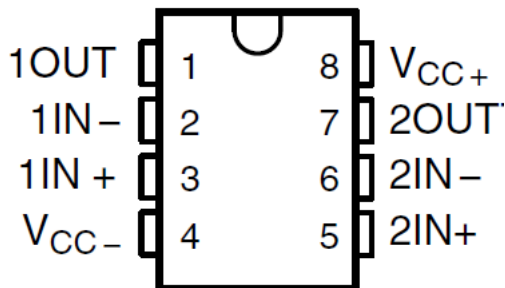

图 5-5. TLE2074 和 TLE2074A DW 封装 (顶视图)

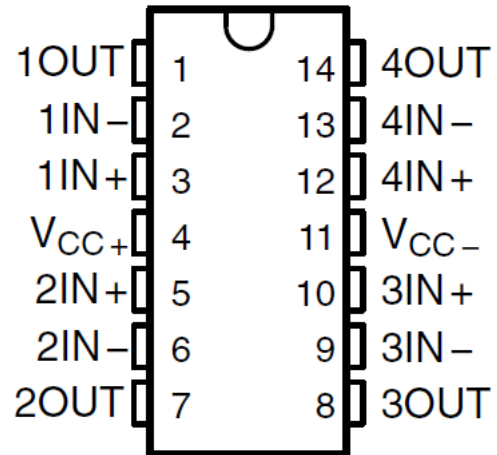

图 5-6. TLE2071M 和 TLE2071AM FK 封装 (顶视图)

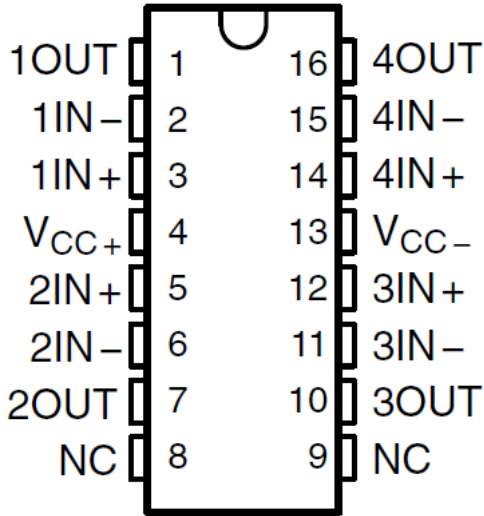

图 5-7. TLE2072M 和 TLE2072AM FK 封装 (顶视图)

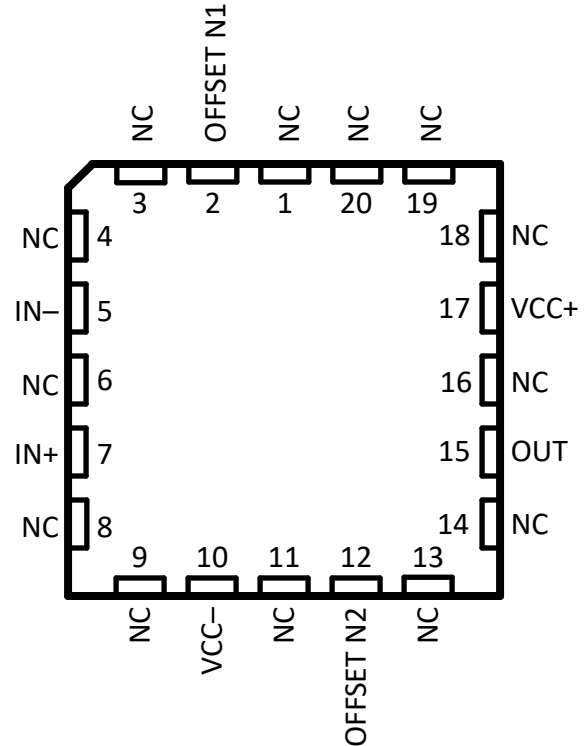

图 5-8. TLE2074M 和 TLE2074AM FK 封装 (顶视图)

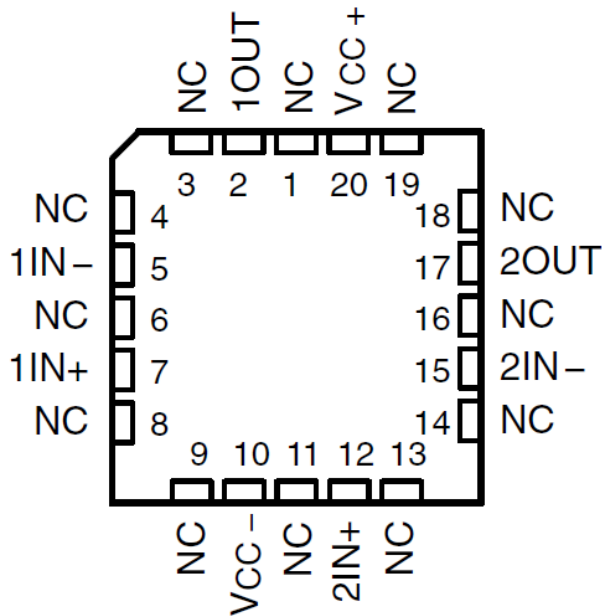

图 5-9. TLE2071 和 TLE2071A U 封装  
 ( 顶视图 )

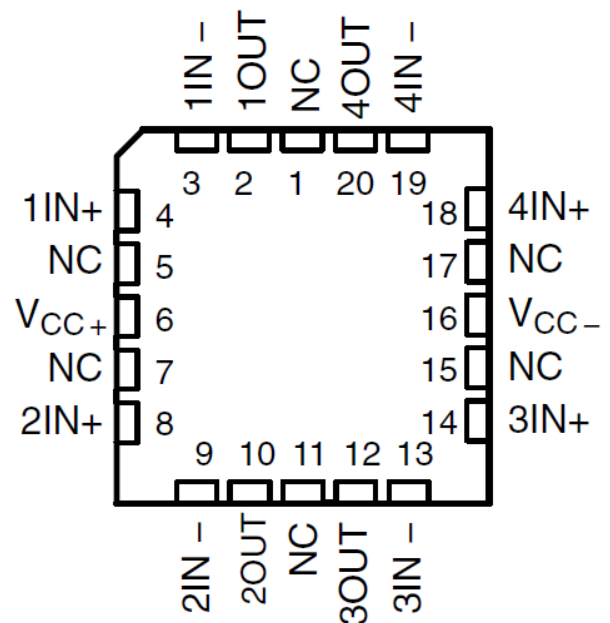

图 5-10. TLE2072 和 TLE2072A U 封装  
 ( 顶视图 )

## 6 规格

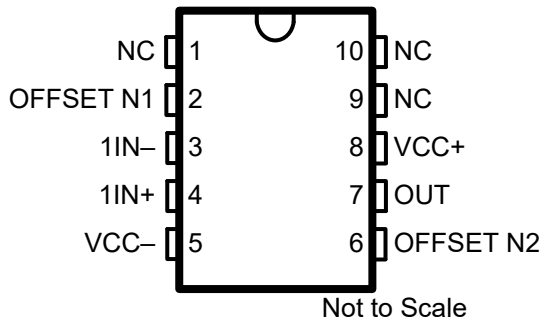
### 6.1 绝对最大额定值

在自然通风条件下的工作温度范围内测得 (除非另有说明) <sup>(1)</sup>

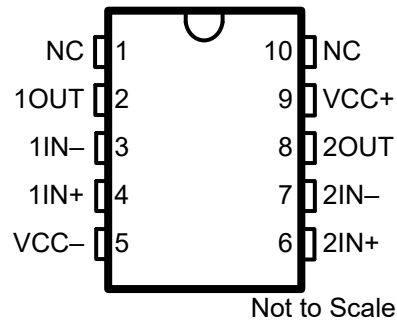
		最小值	最大值	单位	
V <sub>CC+</sub>	电源电压 V <sub>S</sub> = (V+) - (V-)	0	38	V	
V <sub>ID</sub>	差分输入电压范围 <sup>(2)</sup>	V <sub>S</sub> + 0.2			
V <sub>I</sub>	共模电压输入范围	(V-) - 0.5V, (V+) + 0.5V			
I <sub>I</sub>	输入电流 (每个输入端)	±1		mA	
I <sub>O</sub>	输出电流 (每个输出)	持续		mA	
短路电流的持续时间 (≤ 25°C) <sup>(3)</sup>		无限			
θ <sub>JA</sub>	封装热阻抗 <sup>(4) (5)</sup>	D 封装	97.1	°C/W	
		DW 封装	57.3		
		N 封装	79.7		
		P 封装	84.6		
θ <sub>JC</sub>	封装热阻抗 <sup>(4) (5)</sup>	FK 封装	5.6	°C/W	
		J 封装	15.1		
		JG 封装	14.5		
		U 封装	14.7		
		W 封装	10		
T <sub>A</sub>	自然通风条件下的工作温度范围	C 后缀	0	70	°C/W
		I 后缀	-40	85	
		M 后缀	-55	125	
T <sub>stg</sub>	贮存温度	-65	150	°C	
	60 秒内的外壳温度	FK 封装	260	°C	
	10 秒内距离外壳 1.6mm (1/16 英寸) 的引线温度:	DW 或 N 封装	260	°C	
	60 秒内距离外壳 1.6mm (1/16 英寸) 的引线温度:	J、JG、U 或 W 封装	300	°C	

- (1) 应力超出绝对最大额定值下列出的值可能会对器件造成永久损坏。这些仅为应力额定值, 对于在应力额定值下或者在任一其他超过建议运行条件中所标出的额定值的器件的功能运行情况, 在此并未说明。长时间处于绝对最大额定条件下可能会影响器件的可靠性。
- (2) 差分电压是指同相输入端相对于反相输入端的电压。
- (3) 输出端可能短路至任一电源。必须限制温度和/或电源电压, 以确认不超过最大功耗率。
- (4) 最大功耗是与 T<sub>J(max)</sub>、θ<sub>JA</sub> 和 T<sub>A</sub> 相关的函数。在任何允许的环境温度下, 允许的最大功率耗散为 P<sub>D</sub> = (T<sub>J(max)</sub> - T<sub>A</sub>) / θ<sub>JA</sub>。在 150°C 的绝对最大 T<sub>J</sub> 下运行可能会影响可靠性。
- (5) 封装热阻抗根据 JESD 51-7 (塑料) 和 MIL-STD-883 方法 1012 (陶瓷) 计算。

## 6.2 建议运行条件

在自然通风条件下的工作温度范围内测得 (除非另有说明)

		C 后缀		I 后缀		M 后缀		单位	
		最小值	最大值	最小值	最大值	最小值	最大值		
$V_{CC\pm}$	电源电压	$\pm 2.25$	$\pm 19$	$\pm 2.25$	$\pm 19$	$\pm 2.25$	$\pm 19$	V	
$V_{IC}$	共模输入电压	$V_{CC\pm} = \pm 5V$	-0.9	5	-0.8	5	-0.8	5	V
		$V_{CC\pm} = \pm 15V$	-10.9	15	-10.8	15	-10.8	15	
$T_A$	自然通风条件下的工作温度	0	70	-40	85	-55	125	$^{\circ}C$	

## 6.3 TLE2071C 电气特性

在指定自然通风温度下,  $V_{CC\pm} = \pm 5V$  (除非另有说明)

参数		测试条件		$T_A$ (1)	TLE2071C			TLE2071AC			单位
					最小值	典型值	最大值	最小值	典型值	最大值	
$V_{IO}$	输入偏移电压	$V_{IC} = 0$ , $R_S = 50 \Omega$	$V_O = 0$	25 $^{\circ}C$	0.34		4	0.3		2	mV
				完整范围			6			4	
$a_{VIO}$	输入失调电压的温度系数	$V_{IC} = 0$	$V_O = 0$	完整范围	3.2		29	3.2		29	$\mu V/^{\circ}C$
$I_{IO}$	输入失调电流			25 $^{\circ}C$	完整范围	5		100	5		100
		1.4				1.4					
$I_{IB}$	输入偏置电流	完整范围	完整范围	15		175	15		175	pA	
				5		5					
$V_{ICR}$	共模输入电压范围	$R_S = 50 \Omega$		25 $^{\circ}C$	5 到 -1	5 到 -1.9		5 到 -1	5 到 -1.9	V	
				完整范围	5 到 -0.9		5 到 -0.9				
$V_{OM+}$	最大正峰值输出电压摆幅	$I_O = -200 \mu A$		25 $^{\circ}C$	3.8	4.985		3.8	4.985	V	
				25 $^{\circ}C$	3.5	4.925		3.5	4.925	V	
				25 $^{\circ}C$	1.5	4.5		1.5	4.5	V	
$V_{OM-}$	最大负峰值输出电压摆幅	$I_O = 200 \mu A$		25 $^{\circ}C$	-3.5	-4.985		-3.5	-4.985	V	
				25 $^{\circ}C$	-3.7	-4.925		-3.7	-4.925	V	
				25 $^{\circ}C$	-1.5	-4.5		-1.5	-4.5	V	
$A_{VD}$	大信号差分电压放大			$R_L = 600 \Omega$	25 $^{\circ}C$	80	91	80	91	dB	
				$R_L = 2k \Omega$	25 $^{\circ}C$	90	100	90	100		
				$R_L = 10k \Omega$	25 $^{\circ}C$	95	106	95	106		
$r_i$	输入电阻	$V_{IC} = 0$	共模	25 $^{\circ}C$	100		100		$M \Omega$		
			差分	25 $^{\circ}C$	6		6		$T \Omega$		
$C_i$	输入电容	$V_{IC} = 0$	共模	25 $^{\circ}C$	1		1		pF		
			差分	25 $^{\circ}C$	9		9				
$Z_o$	开环输出阻抗	$I_O = 0A$		25 $^{\circ}C$	请参阅图 6-15		请参阅图 6-15		$\Omega$		
CMRR	共模抑制比	$V_{IC} = V_{ICRmin}$ , $V_O = 0$	$R_S = 50 \Omega$	25 $^{\circ}C$	85		85		dB		



### 6.3 TLE2071C 电气特性 (续)

在指定自然通风温度下,  $V_{CC\pm} = \pm 5V$  (除非另有说明)

参数		测试条件		$T_A$ (1)	TLE2071C			TLE2071AC			单位
					最小值	典型值	最大值	最小值	典型值	最大值	
$k_{SVR}$	电源电压抑制比 ( $\Delta V_{CC\pm} / \Delta V_{IO}$ )	$V_{CC\pm} = \pm 5V$ 至 $\pm 15V$		25°C	82	99		82	99		dB
		$V_O = 0$	$R_S = 50 \Omega$	完整范围	80			80			
$I_{CC}$	电源电流 (每通道)	$V_O = 0$	无负载	25°C	1.35	2.48	2.92	1.35	2.48	2.92	mA
$I_{OS}$	短路输出电流			25°C	±65			±65			mA

(1) 完整范围为 0°C 至 70°C。

### 6.4 TLE2071C 工作特性

在指定自然通风温度下,  $V_{CC\pm} = \pm 5V$

参数		测试条件		$T_A$	TLE2071C			TLE2071AC			单位
					最小值	典型值	最大值	最小值	典型值	最大值	
SR	压摆率	$V_{O(PP)} = \pm 2.3V$ , $A_{VD} = -1$ , $C_L = 20pF$	$R_L = 2k \Omega$	25°C	32			32			V/μs
$t_s$	趋稳时间	$A_{VD} = -1$ , 2V 阶跃	至 10mV	25°C	0.25			0.25			μs
			至 1mV		0.4			0.4			
$V_n$	等效输入噪声电压	$R_S = 20 \Omega$	$f = 10Hz$	25°C	48			48			nV/√Hz
			$f = 10kHz$		4.4			4.4			
$V_{N(PP)}$	峰值间等效输入噪声电压		$f = 0.1Hz$ 至 10Hz		2.77			2.77			μV <sub>PP</sub>
$I_n$	等效输入噪声电流	$V_{IC} = 0$	$f = 1kHz$	25°C	60			60			fA/√Hz
THD + N	总谐波失真 + 噪声	$V_O = 3V_{RMS}$ , $G=1$ , $f = 1kHz$ , $R_L = 10k$		25°C	0.0032			0.0032			%
				25°C	90			90			dB
$B_1$	单位增益带宽			25°C	10.6			10.6			MHz
$B_{OM}$	最大输出摆幅带宽		$A_{VD} = -1$ , $C_L = 25pF$	25°C	300			300			kHz
$\phi_m$	单位增益下的相位裕度	$V_I = 10mV$ , $C_L = 25pF$	$R_L = 2k \Omega$	25°C	56°			56°			

### 6.5 TLE2071C 电气特性

在指定自然通风温度下,  $V_{CC\pm} = \pm 15V$  (除非另有说明)

参数		测试条件		$T_A$ (1)	TLE2071C			TLE2071AC			单位
					最小值	典型值	最大值	最小值	典型值	最大值	
$V_{IO}$	输入偏移电压	$V_{IC} = 0$ , $R_S = 50 \Omega$	$V_O = 0$	25°C	0.49		4	0.47		2	mV
				完整范围			6		4		
$a_{VIO}$	输入失调电压的温度系数			完整范围	3.2		29	3.2		29	μV/°C
$I_{IO}$	输入失调电流	$V_{IC} = 0$	$V_O = 0$	25°C	6		100	6		100	pA
				完整范围			1.4		1.4	nA	
$I_{IB}$	输入偏置电流			25°C	20		175	20		175	pA
				完整范围			5		5	nA	

## 6.5 TLE2071C 电气特性 (续)

在指定自然通风温度下,  $V_{CC\pm} = \pm 15V$  (除非另有说明)

参数		测试条件		$T_A$ <sup>(1)</sup>	TLE2071C			TLE2071AC			单位
					最小值	典型值	最大值	最小值	典型值	最大值	
$V_{ICR}$	共模输入	$R_S = 50 \Omega$		25°C	15 到 -11	15 到 -11.9		15 到 -11	15 到 -11.9	V	
				完整范围	15 到 -10.9		15 到 -10.9				
$V_{OM+}$	最大正峰值输出电压摆幅	$I_O = -200mA$		25°C	13.8	14.985		13.8	14.985	V	
		$I_O = -2mA$		25°C	13.5	14.925		13.5	14.925		
		$I_O = -20mA$		25°C	11.5	14.5		11.5	14.5		
$V_{OM-}$	最大负峰值输出电压摆幅	$I_O = 200mA$		25°C	-13.8	-14.985		-13.8	-14.985	V	
		$I_O = 2mA$		25°C	-13.5	-14.925		-13.5	-14.925		
		$I_O = 20mA$		25°C	-11.5	-14.5		-11.5	-14.5		
$A_{VD}$	大信号差分电压放大			$R_L = 600 \Omega$	25°C	80	96		80	96	dB
				$R_L = 2k \Omega$	25°C	90	109		90	109	
				$R_L = 10k \Omega$	25°C	95	118		95	118	
$r_i$	输入电阻	$V_{IC} = 0$		共模	25°C	100		100		$M \Omega$	
				差分	25°C	6		6		$T \Omega$	
$c_i$	输入电容	$V_{IC} = 0$		共模	25°C	1		1		pF	
				差分	25°C	9		9			
$z_o$	开环输出阻抗	$I_O = 0A$		25°C	请参阅 图 6-15			请参阅 图 6-15			$\Omega$
CMRR	共模抑制比	$V_{IC} = V_{ICRmin}$ , $V_O = 0$	$R_S = 50 \Omega$	25°C	98			98			dB
$k_{SVR}$	电源电压抑制比 ( $\Delta V_{CC\pm} / \Delta V_{IO}$ )	$V_{CC\pm} = \pm 5V$ 至 $\pm 15V$ , $V_O = 0$ , $R_S = 50 \Omega$		25°C	82	99		82	99	dB	
$I_{CC}$	电源电流 (每通道)	$V_O = 0$	无负载	25°C	1.35	2.48	2.92	1.35	2.48	2.92	mA
$I_{OS}$	短路输出电流			25°C	$\pm 65$			$\pm 65$			mA

(1) 完整范围为 0°C 至 70°C。

## 6.6 TLE2071C 工作特性

在指定自然通风温度下,  $V_{CC\pm} = \pm 15V$

参数		测试条件		$T_A$	TLE2071C			TLE2071AC			单位
					最小值	典型值	最大值	最小值	典型值	最大值	
SR	压摆率	$V_{O(PP)} = 10V$ , $R_L = 2k \Omega$ , $A_{VD} = -1$ , $C_L = 20pF$		25°C	32			32			$V / \mu s$
$t_s$	趋稳时间	$A_{VD} = -1$ , 10V 阶跃	至 10mV	25°C	0.4			0.4			$\mu s$
			至 1mV		1.5			1.5			
$V_n$	等效输入噪声电压	$R_S = 20 \Omega$	$f = 10Hz$	25°C	48			48			$nV \sqrt{Hz}$
			$f = 10kHz$		4.4			4.4			
$V_{N(PP)}$	峰值间等效输入噪声电压		$f = 1.0Hz$ 至 10kHz	25°C	2.77			2.77			$\mu V_{pp}$
$I_n$	等效输入噪声电流		$f = 1kHz$	25°C	60			60			$fA / \sqrt{Hz}$

在指定自然通风温度下， $V_{CC\pm} = \pm 15V$

参数		测试条件		$T_A$	TLE2071C			TLE2071AC			单位
					最小值	典型值	最大值	最小值	典型值	最大值	
THD+ N	总谐波失真 + 噪声	$V_{OUT} = 3V_{RMS}$ , $G = 1$ , $f = 1kHz$ , $R_L = 10k$		25°C	0.0032			0.0032			%
					90			90			dB
$B_1$	单位增益带宽			25°C	10.6			10.6			MHz
$B_{OM}$	最大输出摆幅带宽		$A_{VD} = -1$ , $C_L = 25pF$	25°C	300			300			kHz
$\phi_m$	单位增益下的相位裕度	$V_I = 10mV$ , $C_L = 25pF$	$R_L = 2k\Omega$	25°C	57°			57°			

## 6.7 TLE2071I 电气特性

在指定自然通风温度下， $V_{CC\pm} = \pm 5V$  (除非另有说明)

参数		测试条件		$T_A$ (1)	TLE2071I			TLE2071AI			单位
					最小值	典型值	最大值	最小值	典型值	最大值	
$V_{IO}$	输入偏移电压	$V_{IC} = 0$ , $R_S = 50\ \Omega$	$V_O = 0$	25°C	0.34	4	0.3	2	mV		
				完整范围	7.6		5.6				
$a_{VIO}$	输入失调电压的温度系数	$V_{IC} = 0$	$V_O = 0$	完整范围	3.2	29	3.2	29	$\mu V/^\circ C$		
$I_{IO}$	输入失调电流			25°C	完整范围	5	100	5	100	pA	
		5	5			nA					
$I_{IB}$	输入偏置电流	$V_{IC} = 0$	$V_O = 0$	25°C	15	175	15	175	pA		
				完整范围	10		10		nA		
$V_{ICR}$	共模输入电压范围	$R_S = 50\ \Omega$		25°C	5 到 -1	5 到 -1.9	5 到 -1	5 到 -1.9	V		
				完整范围	5 到 -0.8	5 到 -0.8					
$V_{OM+}$	最大正峰值输出电压摆幅	$I_O = -200mA$		25°C	3.8	4.985	3.8	4.985	V		
				25°C	3.5	4.925	3.5	4.925			
				25°C	1.5	4.5	1.5	4.5			
$V_{OM-}$	最大负峰值输出电压摆幅	$I_O = 200mA$		25°C	-3.8	-4.985	-3.8	-4.985	V		
				25°C	-3.5	-4.925	-3.5	-4.925			
				25°C	-1.5	-4.5	-1.5	-4.5			
$A_{VD}$	大信号差分电压放大			$R_L = 600\ \Omega$	25°C	80	91	80	91	dB	
				$R_L = 2k\ \Omega$	25°C	90	100	90	100		
				$R_L = 10k\ \Omega$	25°C	95	106	95	106		
$r_i$	输入电阻	$V_{IC} = 0$	共模	25°C	100		100		$M\ \Omega$		
			差分		6		6		$T\ \Omega$		
$c_i$	输入电容	$V_{IC} = 0$	共模	25°C	1		1		pF		
			差分	25°C	9		9				
$Z_o$	开环输出阻抗	$I_O = 0A$		25°C	请参阅 图 6-15			请参阅 图 6-15			$\Omega$
CMRR	共模抑制比	$V_{IC} = V_{ICRmin}$ $V_O = 0$	$R_S = 50\ \Omega$	25°C	85			85			dB
$k_{SVR}$	电源电压抑制比 ( $\Delta V_{CC\pm} / \Delta V_{IO}$ )	$V_{CC\pm} = \pm 5V$ 至 $\pm 15V$ , $V_O = 0$ , $R_S = 50\ \Omega$		25°C	82	99	82	99	dB		
$I_{CC}$	电源电流	$V_O = 0$	无负载	25°C	1.35	2.48	2.92	1.35	2.48	2.92	mA
$I_{OS}$	短路输出电流			25°C	$\pm 65$			$\pm 65$			mA

(1) 完整范围为 -40°C 至 85°C。

## 6.8 TLE2071I 工作特性

在指定自然通风温度下,  $V_{CC\pm} = \pm 5V$

参数		测试条件		$T_A$	TLE2071I			TLE2071AI			单位
					最小值	典型值	最大值	最小值	典型值	最大值	
SR	压摆率	$V_{O(PP)} = \pm 2.3V$ , $A_{VD} = -1$ , $C_L = 20pF$	$R_L = 2k\Omega$	25°C		32		32		V/ $\mu s$	
$t_s$	趋稳时间	$A_{VD} = -1$ , 2V 阶跃	1mV 至 10mV	25°C		0.25		0.25		$\mu s$	
			1mV 至 10mV			0.4		0.4			
$V_n$	等效输入噪声电压	$R_S = 20\Omega$	f = 10Hz	25°C		48		48		nV/ $\sqrt{Hz}$	
			f = 10kHz			4.4		4.4			
$V_{N(PP)}$	峰值间等效输入噪声电压		f = 0.1Hz 至 10Hz	25°C		2.77		2.77		$\mu V_{PP}$	
$I_n$	等效输入噪声电流	$V_{IC} = 0$	f = 1kHz	25°C		60		60		fA/ $\sqrt{Hz}$	
THD+ N	总谐波失真 + 噪声	$V_{OUT} = 3V_{RMS}$ , $G = 1$ , f = 1kHz, $R_L = 10k$		25°C		0.0032		0.0032		%	
						90		90		dB	
$B_1$	单位增益带宽			25°C		10.6		10.6		MHz	
$B_{OM}$	最大输出摆幅带宽		$A_{VD} = -1$ , $C_L = 25pF$	25°C		300		300		kHz	
$\phi_m$	单位增益下的相位裕度	$V_I = 10mV$ , $C_L = 25pF$	$R_L = 2k\Omega$	25°C		56°		56°			

## 6.9 TLE2071I 电气特性

在指定自然通风温度下， $V_{CC\pm} = \pm 15V$  (除非另有说明)

参数		测试条件		$T_A$ (1)	TLE2071I			TLE2071AI			单位	
					最小值	典型值	最大值	最小值	典型值	最大值		
$V_{IO}$	输入偏移电压	$V_{IC} = 0$ , $R_S = 50 \Omega$	$V_O = 0$	25°C	0.49		4	0.47		2	mV	
				完整范围			7.6		5.6			
$a_{VIO}$	输入失调电压的温度系数			完整范围	3.2		29	3.2		29	$\mu V/^\circ C$	
$I_{IO}$	输入失调电流	$V_{IC} = 0$	$V_O = 0$	25°C	6		100	6		100	pA	
				完整范围			5		5			
$I_{IB}$	输入偏置电流			25°C	20		175	20		175	pA	
				完整范围			10		10			
$V_{ICR}$	共模输入电压范围	$R_S = 50 \Omega$		25°C	15 到 -11	15 到 -11.9		15 到 -11	15 到 -11.9		V	
				完整范围	15 到 -10.8		15 到 -10.8					
$V_{OM+}$	最大正峰值输出电压摆幅			$I_O = -200mA$	25°C	13.8	14.985	13.8	14.985		V	
				$I_O = -2mA$	25°C	13.5	14.925	13.5	14.925			
				$I_O = -20mA$	25°C	11.5	14.5	11.5	14.5			
$V_{OM-}$	最大负峰值输出电压摆幅			$I_O = 200mA$	25°C	-13.8	-14.985	-13.8	-14.985		V	
				$I_O = 2mA$	25°C	-13.5	-14.925	-13.5	-14.925			
				$I_O = 20mA$	25°C	-11.5	-14.5	-11.5	-14.5			
$A_{VD}$	大信号差分电压放大			$R_L = 600 \Omega$	25°C	80	96	80	96		dB	
				$R_L = 2k \Omega$	25°C	90	109	90	109			
				$R_L = 10k \Omega$	25°C	95	118	95	118			
$r_i$	输入电阻	$V_{IC} = 0$		共模	25°C		100		100		$M \Omega$	
				差分	25°C		6		6	$T \Omega$		
$c_i$	输入电容	$V_{IC} = 0$		共模	25°C		1		1		pF	
				差分	25°C		9		9			
$Z_o$	开环输出阻抗			$I_O = 0A$	25°C	请参阅 图 6-15		请参阅 图 6-15			$\Omega$	
$CMRR$	共模抑制比	$V_{IC} = V_{ICRmin}$ , $V_O = 0$ , $R_S = 50 \Omega$		25°C	80		98	80		98	dB	
				完整范围	79		79					
$k_{SVR}$	电源电压抑制比 ( $\Delta V_{CC\pm} / \Delta V_{IO}$ )	$V_{CC\pm} = \pm 5V$ 至 $\pm 15V$		25°C	82		99	82		99	dB	
				$V_O = 0$	$R_S = 50 \Omega$	完整范围	80		80			
$I_{CC}$	电源电流	$V_O = 0$		无负载	25°C	1.35	2.48	2.92	1.35	2.48	2.92	mA
$I_{OS}$	短路输出电流				25°C	$\pm 65$		$\pm 65$			mA	

(1) 完整范围为 - 40°C 至 85°C。

## 6.10 TLE2071I 工作特性

在指定自然通风温度下， $V_{CC\pm} = \pm 15V$

参数		测试条件		$T_A$	TLE2071I			TLE2071AI			单位
					最小值	典型值	最大值	最小值	典型值	最大值	
SR	压摆率	$V_{O(PP)} = \pm 10V$ , $A_{VD} = -1$ , $C_L = 20pF$	$R_L = 2k\Omega$	25°C		32			32		V/μs
$t_s$	趋稳时间	$A_{VD} = -1$ , 2V 阶跃	至 10mV	25°C		0.25			0.25		μs
			至 1mV			0.4			0.4		
$V_n$	等效输入噪声电压	$R_S = 20\Omega$	f = 10Hz	25°C		48			48		nV/√Hz
			f = 10kHz			4.4			4.4		
$V_{N(PP)}$	峰值间等效输入噪声电压		f = 0.1Hz 至 10Hz			2.77			2.77		μV <sub>PP</sub>
$I_n$	等效输入噪声电流	$V_{IC} = 0$	f = 1kHz	25°C		60			60		fA/√Hz
THD + N	总谐波失真 + 噪声	$V_{OUT} = 3V_{RMS}$ , $G = 1$ , f = 1kHz, $R_L = 10k$		25°C		0.0032			0.0032		%
				25°C		90			90		dB
$B_1$	单位增益带宽			25°C		10.6			10.6		MHz
$B_{OM}$	最大输出摆幅带宽		$A_{VD} = -1$ , $C_L = 25pF$	25°C		300			300		kHz
$\phi_m$	单位增益下的相位裕度	$V_I = 10mV$ , $C_L = 25pF$	$R_L = 2k\Omega$	25°C		56°			56°		

## 6.11 TLE2071M 电气特性

在指定自然通风温度下， $V_{CC\pm} = \pm 5V$  (除非另有说明)

参数		测试条件		$T_A$ (1)	TLE2071M			TLE2071AM			单位
					最小值	典型值	最大值	最小值	典型值	最大值	
$V_{IO}$	输入偏移电压	$V_{IC} = 0$ , $R_S = 50\ \Omega$	$V_O = 0$	25°C	0.34	4		0.3	4	mV	
				完整范围				7.2			
$a_{VIO}$	输入失调电压的温度系数			完整范围	3.2	29(2)		3.2	29(2)	$\mu V/^\circ C$	
$I_{IO}$	输入失调电流	$V_{IC} = 0$	$V_O = 0$	25°C	5	100		5	100	pA	
				完整范围				20	20		
$I_{IB}$	输入偏置电流			25°C	15	175		15	175	pA	
				完整范围				60	60		
$V_{ICR}$	共模输入电压范围	$R_S = 50\ \Omega$		25°C	5 到 -1	5 到 -1.9		5 到 -1	5 到 -1.9	V	
				完整范围	5 到 -0.8		5 到 -0.8				
$V_{OM+}$	最大正峰值输出电压摆幅	$I_O = -200mA$		25°C	3.8	4.1		3.8	4.1	V	
				完整范围	3.6		3.6				
		$I_O = -2mA$	25°C	3.5	3.9		3.5	3.9			
			完整范围	3.3		3.3					
		$I_O = -20mA$	25°C	1.5	2.3		1.5	2.3			
			完整范围	1.4		1.4					
$V_{OM-}$	最大负峰值输出电压摆幅	$I_O = 200mA$		25°C	-3.8	-4.2		-3.8	-4.2	V	
				完整范围	-3.6		-3.6				
		$I_O = 2mA$	25°C	-3.5	-4.1		-3.5	-4.1			
			完整范围	-3.3		-3.3					
		$I_O = 20mA$	25°C	-1.5	-2.4		-1.5	-2.4			
			完整范围	-1.4		-1.4					
$A_{VD}$	大信号差分电压放大	$V_O = \pm 2.3V$	$R_L = 600\ \Omega$	25°C	80	91		80	91	dB	
				完整范围	78		78				
			$R_L = 2k\ \Omega$	25°C	90	100		90	100		
				完整范围	88		88				
			$R_L = 10k\ \Omega$	25°C	95	106		95	106		
				完整范围	93		93				
$r_i$	输入电阻	$V_{IC} = 0$		25°C	$10^{12}$			$10^{12}$	$\Omega$		
$c_i$	输入电容	$V_{IC} = 0$	共模	25°C	11			11	pF		
			差分	25°C	2.5			2.5			
$Z_o$	开环输出阻抗	$f = 1MHz$		25°C	80			80	$\Omega$		
CMRR	共模抑制比	$V_{IC} = V_{ICRmin}$ , $V_O = 0$	$R_S = 50\ \Omega$	25°C	70	89		70	89	dB	
				完整范围	68		68				
$K_{SVR}$	电源电压抑制比 ( $\Delta V_{CC\pm}/\Delta V_{IO}$ )	$V_{CC\pm} = \pm 5V$ 至 $\pm 15V$		25°C	82	99		82	99	dB	
		$V_O = 0$	$R_S = 50\ \Omega$	完整范围	80		80				
$I_{CC}$	电源电流	$V_O = 0$	无负载	25°C	1.35	1.6	2.2	1.35	1.6	2.2	mA
				完整范围			2.2		2.2		



## 6.11 TLE2071M 电气特性 (续)

在指定自然通风温度下,  $V_{CC\pm} = \pm 5V$  (除非另有说明)

参数		测试条件		$T_A$ (1)	TLE2071M			TLE2071AM			单位
					最小值	典型值	最大值	最小值	典型值	最大值	
$I_{OS}$	短路输出电流	$V_O = 0$	$V_{ID} = 1V$	25°C	-35			-35			mA
			$V_{ID} = -1V$		45			45			

(1) 完整范围为 - 55°C 至 125°C。

(2) 对于符合 MIL-PRF-38535 标准 B 级的产品, 此参数未经量产测试。

## 6.12 TLE2071M 工作特性

在指定自然通风温度下,  $V_{CC\pm} = \pm 5V$

参数		测试条件		$T_A$ (1)	TLE2071M			TLE2071AM			单位
					最小值	典型值	最大值	最小值	典型值	最大值	
SR+	正压摆率	$V_{O(PP)} = \pm 2.3V$ $A_{VD} = -1$	$R_L = 2k\Omega$	25°C	35			35			V/μs
				完整范围	20 (2)			20 (2)			
SR-	负压摆率	$C_L = 100pF$		25°C	38			38			V/μs
				完整范围	20 (2)			20 (2)			
$t_s$	趋稳时间	$A_{VD} = -1$ , 2V 阶跃, $R_L = 1k\Omega$ , $C_L = 100pF$	至 10mV	25°C	0.25			0.25			μs
			至 1mV		0.4			0.4			
$V_n$	等效输入噪声电压	$R_S = 20\Omega$		25°C	f = 10Hz	48	85 (2)	48	85 (2)	nV/√Hz	
					f = 10kHz	12	17 (2)	12	17 (2)		
$V_{N(PP)}$	峰值间等效输入噪声电压			25°C	f = 10Hz 至 10kHz	6			μV		
					f = 0.1Hz 至 10Hz	0.6					
$I_n$	等效输入噪声电流	$V_{IC} = 0$	f = 10kHz	25°C	2.8			2.8			fA/√Hz
THD + N	总谐波失真 + 噪声	$V_{O(PP)} = 5V$ , f = 1kHz, $R_S = 25\Omega$	$A_{VD} = 10$ , $R_L = 2k\Omega$	25°C	0.013%			0.013%			
$B_1$	单位增益带宽	$V_I = 10mV$ , $C_L = 25pF$	$R_L = 2k\Omega$	25°C	9.4			9.4			MHz
$B_{OM}$	最大输出摆幅带宽	$V_{O(PP)} = 4V$ $R_L = 2k\Omega$	$A_{VD} = -1$ , $C_L = 25pF$	25°C	2.8			2.8			MHz
$\phi_m$	单位增益下的相位裕度	$V_I = 10mV$ , $C_L = 25pF$	$R_L = 2k\Omega$	25°C	56°			56°			

(1) 完整范围为 - 55°C 至 125°C。

(2) 对于符合 MIL-PRF-38535 标准 B 级的产品, 此参数未经量产测试。

### 6.13 TLE2071M 电气特性

在指定自然通风温度下， $V_{CC\pm} = \pm 15V$  (除非另有说明)

参数		测试条件		$T_A$ <sup>(2)</sup>	TLE2071M			TLE2071AM			单位
					最小值	典型值	最大值	最小值	典型值	最大值	
$V_{IO}$	输入偏移电压	$V_{IC} = 0$ , $R_S = 50\ \Omega$	$V_O = 0$	25°C	0.49	4		0.47	2	mV	
				完整范围		9.2		7.2			
$a_{VIO}$	输入失调电压的温度系数			完整范围	3.2	29 <sup>(1)</sup>		3.2	29 <sup>(1)</sup>	$\mu V/^\circ C$	
$I_{IO}$	输入失调电流	$V_{IC} = 0$	$V_O = 0$	25°C	6	100		6	100	pA	
				完整范围		20		20			
$I_{IB}$	输入偏置电流			25°C	20	175		20	175	pA	
				完整范围		60		60			
$V_{ICR}$	共模输入电压范围	$R_S = 50\ \Omega$		25°C	15 到 -11	15 到 -11.9		15 到 -11	15 到 -11.9	V	
				完整范围	15 到 -10.9		15 到 -10.9				
$V_{OM+}$	最大正峰值输出电压摆幅	$I_O = -200mA$		25°C	13.8	14.1		13.8	14.1	V	
				完整范围	13.6		13.6				
		$I_O = -2mA$	25°C	13.5	13.9		13.5	13.9			
			完整范围	13.3		13.3					
		$I_O = -20mA$	25°C	11.5	12.3		11.5	12.3			
			完整范围	11.4		11.4					
$V_{OM-}$	最大负峰值输出电压摆幅	$I_O = 200mA$		25°C	-13.8	-14.2		-13.8	-14.2	V	
				完整范围	-13.6		-13.6				
		$I_O = 2mA$	25°C	-13.5	-14		-13.5	-14			
			完整范围	-13.3		-13.3					
		$I_O = 20mA$	25°C	-11.5	-12.4		-11.5	-12.4			
			完整范围	-11.4		-11.4					
$A_{VD}$	大信号差分电压放大	$V_O = \pm 10V$	$R_L = 600\ \Omega$	25°C	80	96		80	96	dB	
				完整范围	78		78				
			$R_L = 2k\ \Omega$	25°C	90	109		90	109		
				完整范围	88		88				
			$R_L = 10k\ \Omega$	25°C	95	118		95	118		
				完整范围	93		93				
$r_i$	输入电阻	$V_{IC} = 0$		25°C	$10^{12}$			$10^{12}$	$\Omega$		
$c_i$	输入电容	$V_{IC} = 0$	共模	25°C	7.5			7.5	pF		
			差分	25°C	2.5			2.5			
$Z_o$	开环输出阻抗	$f = 1MHz$		25°C	80			80	$\Omega$		
CMRR	共模抑制比	$V_{IC} = V_{ICRmin}$ , $V_O = 0$	$R_S = 50\ \Omega$	25°C	80	98		80	98	dB	
				完整范围	78		78				
$k_{SVR}$	电源电压抑制比 ( $\Delta V_{CC\pm} / \Delta V_{IO}$ )	$V_{CC\pm} = \pm 5V$ 至 $\pm 15V$		25°C	82	99		82	99	dB	
		$V_O = 0$	$R_S = 50\ \Omega$	完整范围	80		80				
$I_{CC}$	电源电流	$V_O = 0$	无负载	25°C	1.35	1.7	2.2	1.35	1.7	2.2	mA
				完整范围			2.2		2.2		

### 6.13 TLE2071M 电气特性 (续)

在指定自然通风温度下,  $V_{CC\pm} = \pm 15V$  (除非另有说明)

参数		测试条件		$T_A^{(2)}$	TLE2071M			TLE2071AM			单位
					最小值	典型值	最大值	最小值	典型值	最大值	
$I_{OS}$	短路输出电流	$V_O = 0$	$V_{ID} = 1V$	25°C	-30	-45		-30	-45		mA
			$V_{ID} = -1V$		30	48		30	48		

(1) 对于符合 MIL-PRF-38535 标准 B 级的产品, 此参数未经量产测试。

(2) 完整范围为 - 55°C 至 125°C。

### 6.14 TLE2071M 工作特性

在指定自然通风温度下,  $V_{CC\pm} = \pm 15V$

参数		测试条件		$T_A^{(2)}$	TLE2071M			TLE2071AM			单位
					最小值	典型值	最大值	最小值	典型值	最大值	
SR+	正压摆率	$V_{O(PP)} = 10V$ , $R_L = 2k\Omega$	$A_{VD} = -1$ , $C_L = 100pF$	25°C	30	40		30	40		V/μs
				完整范围	22			22			
SR-	负压摆率	$R_L = 2k\Omega$	$A_{VD} = -1$ , $C_L = 100pF$	25°C	30	45		30	45		V/μs
				完整范围	22			22			
$t_s$	趋稳时间	$A_{VD} = -1$ , 10V 阶跃, $R_L = 1k\Omega$ , $C_L = 100pF$	至 10mV	25°C	0.4		0.4				μs
			至 1mV		1.5		1.5				
$V_n$	等效输入噪声电压	$R_S = 20\Omega$	$f = 10Hz$ $f = 10kHz$	25°C	48	85 <sup>(1)</sup>		48	85 <sup>(1)</sup>		nV/√Hz
					12	17 <sup>(1)</sup>		12	17 <sup>(1)</sup>		
$V_{N(PP)}$	峰值间等效输入噪声电压	$R_S = 20\Omega$	$f = 10Hz$ 至 10kHz	25°C	6		6				μV
			$f = 0.1Hz$ 至 10Hz		0.6		0.6				
$I_n$	等效输入噪声电流	$V_{IC} = 0$	$f = 10kHz$	25°C	2.8		2.8				fA/√Hz
THD + N	总谐波失真 + 噪声	$V_{O(PP)} = 20V$ , $f = 1kHz$ , $R_S = 25\Omega$	$A_{VD} = 10$ , $R_L = 2k\Omega$	25°C	0.008%		0.008%				
$B_1$	单位增益带宽	$V_I = 10mV$ , $C_L = 25pF$	$R_L = 2k\Omega$	25°C	8 <sup>(1)</sup>	10		8 <sup>(1)</sup>	10		MHz
$B_{OM}$	最大输出摆幅带宽	$V_{O(PP)} = 20V$ , $R_L = 2k\Omega$	$A_{VD} = -1$ , $C_L = 25pF$	25°C	478 <sup>(1)</sup>	637		478 <sup>(1)</sup>	637		kHz
$\phi_m$	单位增益下的相位裕度	$V_I = 10mV$ , $C_L = 25pF$	$R_L = 2k\Omega$	25°C	57°		57°				

(1) 对于符合 MIL-PRF-38535 标准 B 级的产品, 此参数未经量产测试。

(2) 完整范围为 - 55°C 至 125°C。

## 6.15 TLE2072C 电气特性

在指定自然通风温度下， $V_{CC\pm} = \pm 5V$  (除非另有说明)

参数		测试条件		$T_A$ (1)	TLE2072C			TLE2072AC			单位
					最小值	典型值	最大值	最小值	典型值	最大值	
$V_{IO}$	输入偏移电压	$V_{IC} = 0$ , $R_S = 50\ \Omega$	$V_O = 0$	25°C	0.9	6	0.65	3.5		mV	
				完整范围		7.8		5.3			
$a_{VIO}$	输入失调电压的温度系数			完整范围	2.3	25	2.3	25		$\mu V/^\circ C$	
$I_{IO}$	输入失调电流	$V_{IC} = 0$	$V_O = 0$	25°C	5	100	5	100		pA	
				完整范围		1.4		1.4		nA	
$I_{IB}$	输入偏置电流			25°C	15	175	15	175		pA	
				完整范围		5		5		nA	
$V_{ICR}$	共模输入电压范围	$R_S = 50\ \Omega$		25°C	5 到 -1	5 到 -1.9	5 到 -1	5 到 -1.9		V	
				完整范围	5 到 -0.9		5 到 -0.9				
$V_{OM+}$	最大正峰值输出电压摆幅			$I_I = -200mA$	25°C	3.8	4.985	3.8	4.985	V	
				$I_O = -2mA$	25°C	3.5	4.925	3.5	4.925		
				$I_O = -20mA$	25°C	1.5	4.5	1.5	4.5		
$V_{OM-}$	最大负峰值输出电压摆幅			$I_O = 200mA$	25°C	-3.8	-4.985	-3.8	-4.985	V	
				$I_O = 2mA$	25°C	-3.5	-4.925	-3.5	-4.925		
				$I_O = 20mA$	25°C	-1.5	-4.5	-1.5	-4.5		
$A_{VD}$	大信号差分电压放大			$R_L = 600\ \Omega$	25°C	80	91	80	91	dB	
				$R_L = 2k\ \Omega$	25°C	90	100	90	100		
				$R_L = 10k\ \Omega$	25°C	95	106	95	106		
$r_i$	输入电阻	$V_{IC} = 0$		共模	25°C	100	100	100		$M\ \Omega$	
				差分	25°C	6	6	6		$T\ \Omega$	
$c_i$	输入电容	$V_{IC} = 0$		共模	25°C	1	1	1		pF	
				差分	25°C	9	9	9			
$Z_o$	开环输出阻抗	$I_O = 0A$		25°C	请参阅 图 6-15		请参阅 图 6-15			$\Omega$	
CMRR	共模抑制比	$V_{IC} = V_{ICRmin}$ , $V_O = 0$	$R_S = 50\ \Omega$	25°C	89		89			dB	
$k_{SVR}$	电源电压抑制比 ( $\Delta V_{CC\pm} / \Delta V_{IO}$ )	$V_{CC\pm} = \pm 5V$ 至 $\pm 15V$		25°C	82	99	82	99	dB		
		$V_O = 0$	$R_S = 50\ \Omega$	完整范围	80		80				
$I_{CC}$	电源电流 (每通道)	$V_O = 0$	无负载	25°C	1.35	2.4	2.8	1.35	2.4	2.8	mA
$a_x$	串扰衰减	$V_{IC} = 0$	$R_L = 2k\ \Omega$	25°C	120		120			dB	
$I_{OS}$	短路输出电流			25°C	$\pm 65$		$\pm 65$			mA	

(1) 完整范围为 0°C 至 70°C。

## 6.16 TLE2072C 工作特性

在指定自然通风温度下， $V_{CC\pm} = 5V$

参数		测试条件		$T_A$	TLE2072C			TLE2072AC			单位
					最小值	典型值	最大值	最小值	典型值	最大值	
SR	压摆率	$V_{O(PP)} = \pm 2.3V$ , $A_{VD} = -1$ , $C_L = 20pF$	$R_L = 2k\Omega$	25°C	32			32			V/μs
$t_s$	趋稳时间	$A_{VD} = -1$ , 2V阶跃	至 10mV	25°C	0.25			0.25			μs
			至 1mV		0.4			0.4			
$V_n$	等效输入噪声电压	$R_S = 20\Omega$	f = 10Hz	25°C	48			48			nV/√Hz
			f = 10kHz		4.4			4.4			
$V_{N(PP)}$	峰值间等效输入噪声电压		f = 0.1Hz至 10Hz		2.77			2.77			μV <sub>PP</sub>
$I_n$	等效输入噪声电流	$V_{IC} = 0$	f = 1kHz	25°C	60			60			fA/√Hz
				25°C	0.0032			0.0032			%
THD + N	总谐波失真 + 噪声	$V_{OUT} = 3V_{RMS}$ , $G = 1$ , f = 1kHz, $R_L = 10k$		25°C	90			90			dB
$B_1$	单位增益带宽			25°C	10.6			10.6			MHz
$B_{OM}$	最大输出摆幅带宽		$A_{VD} = -1$ , $C_L = 25pF$	25°C	300			300			kHz
$\phi_m$	单位增益下的相位裕度	$V_I = 10mV$ , $C_L = 25pF$	$R_L = 2k\Omega$	25°C	56°			56°			

## 6.17 TLE2072C 电气特性

在指定自然通风温度下， $V_{CC\pm} = \pm 15V$  (除非另有说明)

参数		测试条件		$T_A$ (1)	TLE2072C			TLE2072AC			单位
					最小值	典型值	最大值	最小值	典型值	最大值	
$V_{IO}$	输入偏移电压	$V_{IC} = 0$ , $R_S = 50 \Omega$	$V_O = 0$	25°C	1.1		6	0.7		3.5	mV
				完整范围						5.3	
$a_{VIO}$	输入失调电压的温度系数			完整范围	2.4		25	2.4		25	$\mu V/^\circ C$
$I_{IO}$	输入失调电流	$V_{IC} = 0$	$V_O = 0$	25°C	6		100	6		100	pA
				完整范围						1.4	
$I_{IB}$	输入偏置电流			25°C	20		175	20		175	pA
				完整范围						5	
$V_{ICR}$	共模输入电压范围	$R_S = 50 \Omega$		25°C	15 到 -11	15 到 -11.9		15 到 -11	15 到 -11.9		V
				完整范围	15 到 -10.9		15 到 -10.9				
$V_{OM+}$	最大正峰值输出电压摆幅			$I_O = -200mA$	25°C	13.8	14.985	13.8	14.985		V
				$I_O = -2mA$	25°C	13.5	14.925	13.5	14.925		
				$I_O = -20mA$	25°C	11.5	14.5	11.5	14.5		
$V_{OM-}$	最大负峰值输出电压摆幅			$I_O = 200mA$	25°C	-13.8	-14.98 5	-13.8	-14.98 5		V
				$I_O = 2mA$	25°C	-13.5	-14.92 5	-13.5	-14.92 5		
				$I_O = 20mA$	25°C	-11.5	-14.5	-11.5	-14.5		
$A_{VD}$	大信号差分电压放大			$R_L = 600 \Omega$	25°C	80	96	80	96		dB
				$R_L = 2k \Omega$	25°C	90	109	90	109		
				$R_L = 10k \Omega$	25°C	95	118	95	118		
$r_i$	输入电阻	$V_{IC} = 0$	共模	25°C	100			100			$M \Omega$
				差分	25°C	6			6		
$C_i$	输入电容	$V_{IC} = 0$	共模	25°C	1			1			pF
				差分	25°C	9			9		
$Z_o$	开环输出阻抗	$I_O = 0A$		25°C	请参阅 图 6-15			请参阅 图 6-15			$\Omega$
CMRR	共模抑制比	$V_{IC} = V_{ICRmin}$ , $V_O = 0$	$R_S = 50 \Omega$	25°C	98			98			dB
$K_{SVR}$	电源电压抑制比 ( $\Delta V_{CC\pm} / \Delta V_{IO}$ )	$V_{CC\pm} = \pm 5V$ 至 $\pm 15V$ , $V_O = 0$ , $R_S = 50 \Omega$		25°C	82	99		82	99		dB
$I_{CC}$	电源电流 (每通道)	$V_O = 0$	无负载	25°C	1.35	2.4	2.8	1.35	2.4	2.8	mA
$a_x$	串扰衰减	$V_{IC} = 0$	$R_L = 2k \Omega$	25°C	120			120			dB
$I_{OS}$	短路输出电流			25°C	$\pm 65$			$\pm 65$			mA

## 6.18 TLE2072C 工作特性 15V

在指定自然通风温度下， $V_{CC\pm} = \pm 15V$

参数		测试条件		$T_A$	TLE2072C			TLE2072AC			单位
					最小值	典型值	最大值	最小值	典型值	最大值	
SR	压摆率	$V_{O(PP)} = 10V$ , $R_L = 2k\Omega$ , $A_{VD} = -1$ , $C_L = 20pF$		25°C		32		32		$V/\mu s$	
$t_s$	趋稳时间	$A_{VD} = -1$ , 10V 阶跃	至 10mV	25°C		0.4		0.4		$\mu s$	
			至 1mV			1.5		1.5			
$V_n$	等效输入噪声电压	$R_S = 20\Omega$	f = 10Hz	25°C		48		48		$nV/\sqrt{Hz}$	
			f = 10kHz			4.4		4.4			
$V_{N(PP)}$	峰值间等效输入噪声电压		f = 1.0Hz 至 10kHz	25°C		2.77		2.77		$\mu V_{pp}$	
$I_n$	等效输入噪声电流	$V_{IC} = 0$	f = 1kHz	25°C		60		60		$fA/\sqrt{Hz}$	
THD+N	总谐波失真 + 噪声	$V_{OUT} = 3V_{RMS}$ , $G = 1$ , f = 1kHz, $R_L = 10k$		25°C		0.0032		0.0032		%	
						90		90		dB	
$B_1$	单位增益带宽			25°C		10.6		10.6		MHz	
$B_{OM}$	最大输出摆幅带宽		$A_{VD} = -1$ , $C_L = 25pF$	25°C		300		300		kHz	
$\phi_m$	单位增益下的相位裕度	$V_I = 10mV$ , $C_L = 25pF$	$R_L = 2k\Omega$	25°C		57°		57°			

## 6.19 TLE2072I 电气特性

在指定自然通风温度下， $V_{CC\pm} = \pm 5V$  (除非另有说明)

参数		测试条件		$T_A$ (1)	TLE2072I			TLE2072AI			单位
					最小值	典型值	最大值	最小值	典型值	最大值	
$V_{IO}$	输入偏移电压	$V_{IC} = 0$ , $R_S = 50\ \Omega$	$V_O = 0$	25°C	0.9	6	0.65	3.5	mV		
				完整范围	9.1		6.4				
$a_{VIO}$	输入失调电压的温度系数			完整范围	2.4	25	2.4	25	$\mu V/^\circ C$		
$I_{IO}$	输入失调电流	$V_{IC} = 0$	$V_O = 0$	25°C	5	100	5	100	pA		
				完整范围	5		5		nA		
$I_{IB}$	输入偏置电流			25°C	15	175	15	175	pA		
				完整范围	10		10		nA		
$V_{ICR}$	共模输入电压范围	$R_S = 50\ \Omega$		25°C	5 到 -1	5 到 -1.9	5 到 -1	5 到 -1.9	V		
				完整范围	5 到 -0.8	5 到 -0.8					
$V_{OM+}$	最大正峰值输出电压摆幅			$I_O = -200\ \mu A$	25°C	3.8	4.985	3.8	4.985	V	
				$I_O = -2mA$	25°C	3.5	4.925	3.5	4.925	V	
				$I_O = -20mA$	25°C	1.5	4.5	1.5	4.5	V	
$V_{OM-}$	最大负峰值输出电压摆幅			$I_O = 200\ \mu A$	25°C	-3.5	-4.985	-3.5	-4.985	V	
				$I_O = 2mA$	25°C	-3.7	-4.925	-3.7	-4.925	V	
				$I_O = 20mA$	25°C	-1.5	-4.5	-1.5	-4.5	V	
$A_{VD}$	大信号差分电压放大			$R_L = 600\ \Omega$	25°C	80	91	80	91	dB	
				$R_L = 2k\ \Omega$	25°C	90	100	90	100		
				$R_L = 10k\ \Omega$	25°C	95	106	95	106		
$r_i$	输入电阻	$V_{IC} = 0$		共模	25°C	100		100		$M\ \Omega$	
				差分	25°C	6		6		$T\ \Omega$	
$c_i$	输入电容	$V_{IC} = 0$		共模	25°C	1		1		pF	
				差分	25°C	9		9			
$z_o$	开环输出阻抗	$I_O = 0A$		25°C	请参阅 图 6-15			请参阅 图 6-15			$\Omega$
CMRR	共模抑制比	$V_{IC} = V_{ICRmin}$ , $V_O = 0$	$R_S = 50\ \Omega$	25°C	85			85			dB
$k_{SVR}$	电源电压抑制比 ( $\Delta V_{CC\pm} / \Delta V_{IO}$ )	$V_{CC\pm} = \pm 5V$ 至 $\pm 15V$		25°C	82	99	82	99	dB		
		$V_O = 0$	$R_S = 50\ \Omega$	完整范围	80		80				
$I_{CC}$	电源电流 (每通道)	$V_O = 0$	无负载	25°C	1.35	2.4	2.8	1.35	2.4	2.8	mA
$a_x$	串扰衰减	$V_{IC} = 0$	$R_L = 2k\ \Omega$	25°C	120			120			dB
$I_{OS}$	短路输出电流			25°C	$\pm 65$			$\pm 65$			mA

(1) 完整范围为 -40°C 至 85°C。



## 6.20 TLE2072I 工作特性

在指定自然通风温度下， $V_{CC\pm} = \pm 5V$

参数		测试条件		$T_A$	TLE2072I			TLE2072AI			单位
					最小值	典型值	最大值	最小值	典型值	最大值	
SR	压摆率	$V_{O(PP)} = \pm 2.3V$ , $A_{VD} = -1$ , $C_L = 20pF$	$R_L = 2k\Omega$	25°C	32			32			V/μs
$t_s$	趋稳时间	$A_{VD} = -1$ , 2V 阶跃	至 10mV	25°C	0.25			0.25			μs
			至 1mV		0.4			0.4			
$V_n$	等效输入噪声电压	$R_S = 20\Omega$	f = 10Hz	25°C	48			48			nV/√Hz
			f = 10kHz		4.4			4.4			
$V_{N(PP)}$	峰值间等效输入噪声电压		f = 0.1Hz 至 10Hz		2.77			2.77			μV <sub>PP</sub>
$I_n$	等效输入噪声电流	$V_{IC} = 0$	f = 1kHz	25°C	60			60			fA/√Hz
				25°C	90			90			dB
THD + N	总谐波失真 + 噪声	$V_O = 3V_{RMS}$ , G = 1, f = 1kHz, $R_L = 10k$		25°C	0.0032			0.0032			%
				25°C	90			90			dB
$B_1$	单位增益带宽			25°C	10.6			10.6			MHz
$B_{OM}$	最大输出摆幅带宽		$A_{VD} = -1$ , $C_L = 25pF$	25°C	300			300			kHz
$\phi_m$	单位增益下的相位裕度	$V_I = 10mV$ , $C_L = 25pF$	$R_L = 2k\Omega$	25°C	56°			56°			

## 6.21 TLE2072I 电气特性

在指定自然通风温度下， $V_{CC\pm} = \pm 15V$  (除非另有说明)

参数		测试条件		$T_A$ (1)	TLE2072I			TLE2072AI			单位
					最小值	典型值	最大值	最小值	典型值	最大值	
$V_{IO}$	输入偏移电压	$V_{IC} = 0$	$V_O = 0$	25°C	1.1	6	0.7	3.5	mV		
				完整范围	9.1		6.4				
$a_{VIO}$	输入失调电压的温度系数	$R_S = 50\ \Omega$		完整范围	2.4	25	2.4	25	$\mu V/^\circ C$		
$I_{IO}$	输入失调电流	$V_{IC} = 0$	$V_O = 0$	25°C	6	100	6	100	pA		
				完整范围	5		5				
$I_{IB}$	输入偏置电流	$V_{IC} = 0$	$V_O = 0$	25°C	20	175	20	175	pA		
				完整范围	10		10				
$V_{ICR}$	共模输入电压范围	$R_S = 50\ \Omega$		25°C	15 到 -11	15 到 -11.9	15 到 -11	15 到 -11.9	V		
				完整范围	15 到 -10.8	15 到 -10.8					
$V_{OM+}$	最大正峰值输出电压摆幅			$I_O = -200mA$	25°C	13.8	14.985	13.8	14.985	V	
				$I_O = -2mA$	25°C	13.5	14.925	13.5	14.925		
				$I_O = -20mA$	25°C	11.5	14.5	11.5	14.5		
$V_{OM-}$	最大负峰值输出电压摆幅			$I_O = 200mA$	25°C	-13.8	-14.985	-13.8	-14.985	V	
				$I_O = 2mA$	25°C	-13.5	-14.925	-13.5	-14.925		
				$I_O = 20mA$	25°C	-11.5	-14.5	-11.5	-14.5		
$A_{VD}$	大信号差分电压放大			$R_L = 600\ \Omega$	25°C	80	96	80	96	dB	
				$R_L = 2k\ \Omega$	25°C	90	109	90	109		
				$R_L = 10k\ \Omega$	25°C	95	118	95	118		
$r_i$	输入电阻	$V_{IC} = 0$	共模	25°C	100		100		$M\ \Omega$		
			差分	25°C	6		6		$T\ \Omega$		
$C_i$	输入电容	$V_{IC} = 0$	共模	25°C	7.5		7.5		pF		
			差分	25°C	2.5		2.5				
$Z_o$	开环输出阻抗	$I_O = 0A$		25°C	请参阅图 6-15			请参阅图 6-15			$\Omega$
CMRR	共模抑制比	$V_{IC} = V_{ICRmin}$ , $V_O = 0$	$R_S = 50\ \Omega$	25°C	98			98			dB
$K_{SVR}$	电源电压抑制比 ( $\Delta V_{CC\pm} / \Delta V_{IO}$ )	$V_{CC\pm} = \pm 5V$ 至 $\pm 15V$ , $V_O = 0$ , $R_S = 50\ \Omega$		25°C	82	99	82	99	dB		
$I_{CC}$	电源电流 (每通道)	$V_O = 0$	无负载	25°C	1.35	2.4	2.8	1.35	2.4	2.8	mA
$a_x$	串扰衰减	$V_{IC} = 0$	$R_L = 2k\ \Omega$	25°C	120			120			dB
$I_{OS}$	短路输出电流			25°C	$\pm 65$			$\pm 65$			mA

(1) 完整范围为 -40°C 至 85°C。

## 6.22 TLE2072I 工作特性

在指定自然通风温度下， $V_{CC\pm} = \pm 15V$

参数		测试条件		$T_A$	TLE2072I			TLE2072AI			单位
					最小值	典型值	最大值	最小值	典型值	最大值	
SR	压摆率	$V_{O(PP)} = 10V$ , $R_L = 2k\Omega$ , $A_{VD} = -1$ , $C_L = 20pF$		25°C	32			32			V/μs
$t_s$	趋稳时间	$A_{VD} = -1$ , 10V 阶跃	至 10mV	25°C	0.4			0.4			μs
			至 1mV		1.5			1.5			
$V_n$	等效输入噪声电压	$R_S = 20\Omega$	f = 10Hz	25°C	48			48			nV√Hz
			f = 10kHz		4.4			4.4			
$V_{N(PP)}$	峰值间等效输入噪声电压		f = 1.0Hz 至 10kHz	25°C	2.77			2.77			μVpp
$I_n$	等效输入噪声电流	$V_{IC} = 0$	f = 1kHz	25°C	60			60			fA/√Hz
THD+N	总谐波失真 + 噪声	$V_O = 3V_{RMS}$ , G = 1, f = 1kHz, $R_L = 10k$		25°C	0.0032			0.0032			%
					90			90			dB
$B_1$	单位增益带宽			25°C	10.6			10.6			MHz
$B_{OM}$	最大输出摆幅带宽		$A_{VD} = -1$ , $C_L = 25pF$	25°C	300			300			kHz
$\phi_m$	单位增益下的相位裕度	$V_I = 10mV$ , $C_L = 25pF$	$R_L = 2k\Omega$	25°C	57°			57°			

## 6.23 TLE2072M 电气特性

在指定自然通风温度下， $V_{CC\pm} = \pm 5V$

参数		测试条件		$T_A$ <sup>(2)</sup>	TLE2072M			TLE2072AM			单位
					最小值	典型值	最大值	最小值	典型值	最大值	
$V_{IO}$	输入偏移电压	$V_{IC} = 0$ , $R_S = 50\ \Omega$	$V_O = 0$	25°C	0.9	6	0.65	3.5	mV		
				完整范围	10.5			8			
$a_{VIO}$	输入失调电压的温度系数			完整范围	2.3	25 <sup>(1)</sup>	2.3	25 <sup>(1)</sup>	$\mu V/^\circ C$		
$I_{IO}$	输入失调电流	$V_{IC} = 0$	$V_O = 0$	25°C	5	100	5	100	pA		
				完整范围	20			20			
$I_{IB}$	输入偏置电流			25°C	15	175	15	175	pA		
				完整范围	60			60			
$V_{ICR}$	共模输入电压范围	$R_S = 50\ \Omega$		25°C	5 到 -1	5 到 -1.9	5 到 -1	5 到 -1.9	V		
				完整范围	5 到 -0.8	5 到 -0.8					
$V_{OM+}$	最大正峰值输出电压摆幅			25°C	3.8	4.1	3.8	4.1	V		
				完整范围	3.6			3.6			
				25°C	3.5	3.9	3.5	3.9			
				完整范围	3.3			3.3			
				25°C	1.5	2.3	1.5	2.3			
				完整范围	1.4			1.4			
$V_{OM-}$	最大负峰值输出电压摆幅			25°C	-3.8	-4.2	-3.8	-4.2	V		
				完整范围	-3.6			-3.6			
				25°C	-3.5	-4.1	-3.5	-4.1			
				完整范围	-3.3			-3.3			
				25°C	-1.5	-2.4	-1.5	-2.4			
				完整范围	-1.4			-1.4			
$A_{VD}$	大信号差分电压放大	$V_O = \pm 2.3V$	$R_L = 600\ \Omega$	25°C	80	91	80	91	dB		
				完整范围	78			78			
			$R_L = 2k\ \Omega$	25°C	90	100	90	100			
				完整范围	88			88			
			$R_L = 10k\ \Omega$	25°C	95	106	95	106			
				完整范围	93			93			
$r_i$	输入电阻	$V_{IC} = 0$		25°C	$10^{12}$			$\Omega$			
$c_i$	输入电容	$V_{IC} = 0$	共模	25°C	11			pF			
			差分	25°C	2.5						
$Z_o$	开环输出阻抗	$f = 1MHz$		25°C	80			$\Omega$			
CMRR	共模抑制比	$V_{IC} = V_{ICRmin}$ , $V_O = 0$	$R_S = 50\ \Omega$	25°C	70	89	70	89	dB		
				完整范围	68			68			
$k_{SVR}$	电源电压抑制比 ( $\Delta V_{CC\pm} / \Delta V_{IO}$ )	$V_{CC\pm} = \pm 5V$ 至 $\pm 15V$		完整范围	80			dB			
		$V_O = 0$	$R_S = 50\ \Omega$								
$I_{CC}$	电源电流 (每通道)	$V_O = 0$	无负载	25°C	2.7	2.9	3.6	2.7	2.9	3.6	mA
				完整范围	3.6			3.6			

## 6.23 TLE2072M 电气特性 (续)

在指定自然通风温度下,  $V_{CC\pm} = \pm 5V$

参数		测试条件		$T_A^{(2)}$	TLE2072M			TLE2072AM			单位
					最小值	典型值	最大值	最小值	典型值	最大值	
$a_x$	串扰衰减	$V_{IC} = 0$	$R_L = 2k\Omega$	25°C	120			120			dB
$I_{OS}$	短路输出电流	$V_O = 0$	$V_{ID} = 1V$	25°C	-35			-35			mA
			$V_{ID} = -1V$		45			45			

(1) 对于符合 MIL-PRF-38535 标准 B 级的产品, 此参数未经量产测试。

(2) 完整范围为 - 55°C 至 125°C。

## 6.24 TLE2072M 工作特性 5V

在指定自然通风温度下,  $V_{CC\pm} = \pm 5V$

参数		测试条件		$T_A^{(2)}$	TLE2072M			TLE2072AM			单位
					最小值	典型值	最大值	最小值	典型值	最大值	
SR+	正压摆率	$V_{O(PP)} = \pm 2.3V$ ,	$R_L = 2k\Omega$	25°C	35			35			V/μs
				完整范围	18 <sup>(1)</sup>			18 <sup>(1)</sup>			
SR-	负压摆率	$A_{VD} = -1$ , $C_L = 100pF$	$R_L = 2k\Omega$	25°C	38			38			V/μs
				完整范围	18 <sup>(1)</sup>			18 <sup>(1)</sup>			
$t_s$	趋稳时间	$A_{VD} = -1$ , 2V 阶跃, $R_L = 1k\Omega$ , $C_L = 100pF$	至 10mV	25°C	0.25			0.25			μs
			至 1mV		0.4			0.4			
$V_n$	等效输入噪声电压	$R_S = 20\Omega$	$f = 10Hz$ $f = 10kHz$	25°C	48	85 <sup>(1)</sup>	48	85 <sup>(1)</sup>	12	17 <sup>(1)</sup>	nV/√Hz
					6	6	0.6	0.6			
$V_{N(PP)}$	峰值间等效输入噪声电压	$R_S = 20\Omega$	f = 10Hz 至 10kHz	25°C	6			6			μV
			f = 0.1Hz 至 10Hz		0.6			0.6			
$I_n$	等效输入噪声电流	$V_{IC} = 0$	$f = 10kHz$	25°C	2.8			2.8			fA/√Hz
THD + N	总谐波失真 + 噪声	$V_{O(PP)} = 5V$ , $f = 1kHz$ , $R_S = 25\Omega$	$A_{VD} = 10$ , $R_L = 2k\Omega$	25°C	0.013%			0.013%			
$B_1$	单位增益带宽	$V_I = 10mV$ , $C_L = 25pF$	$R_L = 2k\Omega$	25°C	9.4			9.4			MHz
$B_{OM}$	最大输出摆幅带宽	$V_{O(PP)} = 4V$ , $R_L = 2k\Omega$	$A_{VD} = -1$ , $C_L = 25pF$	25°C	2.8			2.8			MHz
$\phi_m$	单位增益下的相位裕度	$V_I = 10mV$ , $C_L = 25pF$	$R_L = 2k\Omega$	25°C	56°			56°			

(1) 对于符合 MIL-PRF-38535 标准 B 级的产品, 此参数未经量产测试。

(2) 完整范围为 - 55°C 至 125°C。

## 6.25 TLE2072M 电气特性

在指定自然通风温度下， $V_{CC\pm} = \pm 15V$  (除非另有说明)

参数		测试条件		$T_A$ <sup>(2)</sup>	TLE2072M			TLE2072AM			单位
					最小值	典型值	最大值	最小值	典型值	最大值	
$V_{IO}$	输入偏移电压	$V_{IC} = 0$ , $R_S = 50\ \Omega$	$V_O = 0$	25°C	1.1	6	0.7	3.5	mV		
				完整范围	10.5			8			
$a_{VIO}$	输入失调电压的温度系数			完整范围	2.4	25 <sup>(1)</sup>	2.4	25 <sup>(1)</sup>	$\mu V/^\circ C$		
$I_{IO}$	输入失调电流	$V_{IC} = 0$	$V_O = 0$	25°C	6	100	6	100	pA		
				完整范围	20			20			
$I_{IB}$	输入偏置电流			25°C	20	175	20	175	pA		
				完整范围	60			60			
$V_{ICR}$	共模输入电压范围	$R_S = 50\ \Omega$		25°C	15 到 -11	15 到 -11.9	15 到 -11	15 到 -11.9	V		
				完整范围	15 到 -10.8	15 到 -10.8					
$V_{OM+}$	最大正峰值输出电压摆幅	$I_O = -200mA$		25°C	13.8	14.1	13.8	14.1	V		
				完整范围	13.6			13.6			
		$I_O = -2mA$	25°C	13.5	13.9	13.5	13.9				
			完整范围	13.3			13.3				
$I_O = -20mA$	25°C	11.5	12.3	11.5	12.3						
	完整范围	11.4			11.4						
$V_{OM-}$	最大负峰值输出电压摆幅	$I_O = 200mA$		25°C	-13.8	-14.2	-13.8	-14.2	V		
				完整范围	-13.6			-13.6			
		$I_O = 2mA$	25°C	-13.5	-14	-13.5	-14				
			完整范围	-13.3			-13.3				
$I_O = 20mA$	25°C	-11.5	-12.4	-11.5	-12.4						
	完整范围	-11.4			-11.4						
$A_{VD}$	大信号差分电压放大	$V_O = \pm 10V$	$R_L = 600\ \Omega$	25°C	80	96	80	96	dB		
				完整范围	78			78			
			$R_L = 2k\ \Omega$	25°C	90	109	90	109			
				完整范围	89			89			
			$R_L = 10k\ \Omega$	25°C	95	118	95	118			
				完整范围	93			93			
$r_i$	输入电阻	$V_{IC} = 0$		25°C	$10^{12}$			$\Omega$			
$c_i$	输入电容	$V_{IC} = 0$	共模	25°C	7.5			pF			
			差分	25°C	2.5						
$Z_o$	开环输出阻抗	$f = 1MHz$		25°C	80			$\Omega$			
CMRR	共模抑制比	$V_{IC} = V_{ICRmin}$ , $V_O = 0$	$R_S = 50\ \Omega$	25°C	80	98	80	98	dB		
				完整范围	78			78			
$k_{SVR}$	电源电压抑制比 ( $\Delta V_{CC\pm} / \Delta V_{IO}$ )	$V_{CC\pm} = \pm 5V$ 至 $\pm 15V$		25°C	82	99	82	99	dB		
		$V_O = 0$	$R_S = 50\ \Omega$	完整范围	80			80			
$I_{CC}$	电源电流 (每通道)	$V_O = 0$	无负载	25°C	2.7	3.1	3.6	2.7	3.1	3.6	mA
				完整范围	3.6			3.6			

## 6.25 TLE2072M 电气特性 (续)

在指定自然通风温度下,  $V_{CC\pm} = \pm 15V$  (除非另有说明)

参数		测试条件		$T_A^{(2)}$	TLE2072M			TLE2072AM			单位
					最小值	典型值	最大值	最小值	典型值	最大值	
$a_x$	串扰衰减	$V_{IC} = 0$	$R_L = 2k\Omega$	25°C		120			120		dB
$I_{OS}$	短路输出电流	$V_O = 0$		25°C	-30	-45		-30	-45		mA
					30	48		30	48		

(1) 对于符合 MIL-PRF-38535 标准 B 级的产品, 此参数未经量产测试。

(2) 完整范围为 - 55°C 至 125°C。

## 6.26 TLE2072M 工作特性

在指定自然通风温度下,  $V_{CC\pm} = \pm 15V$

参数		测试条件		$T_A^{(2)}$	TLE2072M			TLE2072AM			单位
					最小值	典型值	最大值	最小值	典型值	最大值	
SR+	正压摆率	$V_{O(PP)} = 10V$ , $R_L = 2k\Omega$	$A_{VD} = -1$ , $C_L = 100pF$	25°C	28	40		28	40		V/μs
				完整范围	20			20			
SR-	负压摆率			25°C	30	45		30	45		V/μs
				完整范围	20			20			
$t_s$	趋稳时间	$A_{VD} = -1$ , 10V 阶跃, $R_L = 1k\Omega$ , $C_L = 100pF$	至 10mV	25°C	0.4		0.4			μs	
			至 1mV		1.5		1.5				
$V_n$	等效输入噪声电压	$R_S = 20\Omega$		25°C	f = 10Hz	48	85 <sup>(1)</sup>	48	85 <sup>(1)</sup>	nV/√Hz	
					f = 10kHz	12	17 <sup>(1)</sup>	12	17 <sup>(1)</sup>		
$V_{N(PP)}$	峰值间等效输入噪声电压			25°C	f = 10Hz 至 10kHz	6		6		μV	
					f = 0.1Hz 至 10Hz	0.6		0.6			
$I_n$	等效输入噪声电流	$V_{IC} = 0$	f = 10kHz	25°C	2.8		2.8		fA/√Hz		
THD + N	总谐波失真 + 噪声	$V_{O(PP)} = 20V$ , f = 1kHz, $R_S = 25\Omega$	$A_{VD} = 10$ , $R_L = 2k\Omega$	25°C	0.008%		0.008%				
$B_1$	单位增益带宽	$V_I = 10mV$ , $C_L = 25pF$	$R_L = 2k\Omega$	25°C	8 <sup>(1)</sup>	10	8 <sup>(1)</sup>	10	MHz		
$B_{OM}$	最大输出摆幅带宽	$V_{O(PP)} = 20V$ , $R_L = 2k\Omega$	$A_{VD} = -1$ , $C_L = 25pF$	25°C	478 <sup>(1)</sup>	637	478 <sup>(1)</sup>	637	kHz		
$\phi_m$	单位增益下的相位裕度	$V_I = 10mV$ , $C_L = 25pF$	$R_L = 2k\Omega$	25°C	57°		57°				

(1) 对于符合 MIL-PRF-38535 标准 B 级的产品, 此参数未经量产测试。

(2) 完整范围为 - 55°C 至 125°C。

## 6.27 TLE2074C 电气特性

在指定自然通风温度下， $V_{CC\pm} = \pm 5V$  (除非另有说明)

参数		测试条件		$T_A$ (1)	TLE2074C			TLE2074AC			单位
					最小值	典型值	最大值	最小值	典型值	最大值	
$V_{IO}$	输入偏移电压	$V_{IC} = 0$ , $R_S = 50\ \Omega$	$V_O = 0$	25°C	-1.6	5	-0.5	3	mV		
				完整范围	7.1		5.1				
$a_{VIO}$	输入失调电压的温度系数			完整范围	10.1	30	10.1	30	$\frac{\mu V}{^\circ C}$		
$I_{IO}$	输入失调电流	$V_{IC} = 0$	$V_O = 0$	25°C	15	100	15	100	pA		
				完整范围	1400		1400				
$I_{IB}$	输入偏置电流	$V_{IC} = 0$	$V_O = 0$	25°C	20	175	20	175	pA		
				完整范围	5000		5000				
$V_{ICR}$	共模输入电压范围	$R_S = 50\ \Omega$		25°C	5 到 -1	5 到 -1.9	5 到 -1	5 到 -1.9	V		
				完整范围	5 到 -0.9	5 到 -0.9					
$V_{OM+}$	最大正峰值输出电压摆幅			25°C	3.8	4.985	3.8	4.985	V		
				25°C	3.5	4.925	3.5	4.925			
				25°C	1.5	4.5	1.5	4.5			
$V_{OM-}$	最大负峰值输出电压摆幅			25°C	-3.5	-4.985	-3.5	-4.985	V		
				25°C	-3.7	-4.925	-3.7	-4.925			
				25°C	-1.5	-4.5	-1.5	-4.5			
$A_{VD}$	大信号差分电压放大			25°C	80	91	80	91	dB		
				25°C	90	100	90	100			
				25°C	95	106	95	106			
$r_i$	输入电阻	$V_{IC} = 0$	共模	100		100		$M\ \Omega$			
			差分	6		6					
$c_i$	输入电容	$V_{IC} = 0$	共模	1		1		pF			
			差分	9		9					
$z_o$	开环输出阻抗	$I_O = 0A$		25°C	请参阅 图 6-15		请参阅 图 6-15		$\Omega$		
CMRR	共模抑制比	$V_{IC} = V_{ICRmin}$ , $V_O = 0$	$R_S = 50\ \Omega$	25°C	85		85		dB		
$k_{SVR}$	电源电压抑制比 ( $\Delta V_{CC\pm}/\Delta V_{IO}$ )	$V_{CC\pm} = \pm 5V$ 至 $\pm 15V$		25°C	82	99	82	99	dB		
		$V_O = 0$	$R_S = 50\ \Omega$	完整范围	80		80				
$I_{CC}$	电源电流 (每个放大器)	$V_O = 0$	无负载	25°C	1.35	2.4	2.8	1.35	2.4	2.8	mA
	串扰衰减	$V_{IC} = 0$	$R_L = 2k\ \Omega$	25°C	120		120		dB		
$I_{OS}$	短路输出电流			25°C	$\pm 65$		$\pm 65$		mA		

(1) 完整范围为 0°C 至 70°C。



## 6.28 TLE2074C 工作特性

在指定自然通风温度下,  $V_{CC\pm} = \pm 5V$

参数		测试条件		$T_A$	TLE2074C			TLE2074AC			单位
					最小值	典型值	最大值	最小值	典型值	最大值	
SR	压摆率	$V_{O(PP)} = \pm 2.3V$ , $A_{VD} = -1$ , $C_L = 20pF$	$R_L = 2k\Omega$	25°C	32			32			V/μs
$t_s$	趋稳时间	$A_{VD} = -1$ , 2V 阶跃	至 10mV	25°C	0.25			0.25			μs
			至 1mV		0.4			0.4			
$V_n$	等效输入噪声电压	$R_S = 20\Omega$	f = 10Hz	25°C	48			48			nV/√Hz
			f = 10kHz		4.4			4.4			
$V_{N(PP)}$	峰值间等效输入噪声电压		f = 0.1Hz 至 10Hz		2.77			2.77			μV <sub>PP</sub>
$I_n$	等效输入噪声电流	$V_{IC} = 0$	f = 1kHz	25°C	60			60			fA/√Hz
THD + N	总谐波失真 + 噪声	$V_{OUT} = 3V_{RMS}$ , $G = 1$ , f = 1kHz, $R_L = 10k$		25°C	0.0032			0.0032			%
				25°C	90			90			dB
$B_1$	单位增益带宽			25°C	10.6			10.6			MHz
$B_{OM}$	最大输出摆幅带宽	$A_{VD} = -1$	$C_L = 25pF$	25°C	300			300			kHz
$\phi_m$	单位增益下的相位裕度	$V_I = 10mV$ , $C_L = 25pF$	$R_L = 2k\Omega$	25°C	56°			56°			

## 6.29 TLE2074C 电气特性

在指定自然通风温度下， $V_{CC\pm} = \pm 15V$  (除非另有说明)

参数		测试条件		$T_A$ <sup>(1)</sup>	TLE2074C			TLE2074AC			单位
					最小值	典型值	最大值	最小值	典型值	最大值	
$V_{IO}$	输入偏移电压	$V_{IC} = 0$ , $R_S = 50 \Omega$	$V_O = 0$	25°C	-1.6	5	-0.5	3	mV		
				完整范围	7.1		5.1				
$a_{VIO}$	输入失调电压的温度系数	$V_{IC} = 0$	$V_O = 0$	完整范围	10.1	30	10.1	30	$\mu V/^\circ C$		
$I_{IO}$	输入失调电流			25°C	15	100	15	100	pA		
		完整范围	1400		1400						
$I_{IB}$	输入偏置电流	25°C	25	175	25	175	pA				
			完整范围	5000		5000					
$V_{ICR}$	共模输入电压范围	$R_S = 50 \Omega$		25°C	15 到 -11	15 到 -11.9	15 到 -11	15 到 -11.9	V		
				完整范围	15 到 -10.9	15 到 -10.9					
$V_{OM+}$	最大正峰值输出电压摆幅	$I_O = -200mA$		25°C	13.8	14.98 5	13.8	14.98 5	V		
				25°C	13.5	14.92 5	13.5	14.92 5			
				25°C	11.5	14.5	11.5	14.5			
$V_{OM-}$	最大负峰值输出电压摆幅	$I_O = 200mA$		25°C	-13.8	-14.9 85	-13.8	-14.9 85	V		
				25°C	-13.5	-14.9 25	-13.5	-14.9 25			
				25°C	-11.5	-14.5	-11.5	-14.5			
$A_{VD}$	大信号差分电压放大			$R_L = 600 \Omega$	25°C	80	96	80	96	dB	
				$R_L = 2k \Omega$	25°C	90	109	90	109		
				$R_L = 10k \Omega$	25°C	95	118	95	118		
$r_i$	输入电阻	$V_{IC} = 0$	共模	25°C	100		100		M $\Omega$		
			差分	25°C	6		6		T $\Omega$		
$C_i$	输入电容	$V_{IC} = 0$	共模	25°C	7.5		7.5		pF		
			差分	25°C	2.5		2.5				
$Z_o$	开环输出阻抗	$I_O = 0A$		25°C	请参阅 图 6-15		请参阅 图 6-15		$\Omega$		
CMRR	共模抑制比	$V_{IC} = V_{ICRmin}$ , $V_O = 0$	$R_S = 50 \Omega$	25°C	98		98		dB		
$k_{SVR}$	电源电压抑制比 ( $\Delta V_{CC\pm} / \Delta V_{IO}$ )	$V_{CC\pm} = \pm 5V$ 至 $\pm 15V$		25°C	82	99	82	99	dB		
$I_{CC}$	电源电流 (每个放大器)	$V_O = 0$	无负载	25°C	1.35	2.4	2.8	1.35	2.4	2.8	mA
	串扰衰减	$V_{IC} = 0$	$R_L = 2k \Omega$	25°C	120		120		dB		
$I_{OS}$	短路输出电流			25°C	$\pm 65$		$\pm 65$		mA		

(1) 完整范围为 0°C 至 70°C。

### 6.30 TLE2074C 工作特性

在指定自然通风温度下， $V_{CC\pm} = \pm 15V$

参数		测试条件		$T_A$	TLE2074C			TLE2074AC			单位
					最小值	典型值	最大值	最小值	典型值	最大值	
SR	压摆率	$V_{O(PP)} = 10V$ , $R_L = 2k\Omega$ , $A_{VD} = -1$ , $C_L = 20pF$		25°C	32			32			V/μs
$t_s$	趋稳时间	$A_{VD} = -1$ , 10V 阶跃	至 10mV	25°C	0.4			0.4			μs
			至 1mV		1.5			1.5			
$V_n$	等效输入噪声电压	$R_S = 20\Omega$	f = 10Hz	25°C	48			48			nV/√Hz
			f = 10kHz		4.4			4.4			
$V_{N(PP)}$	峰值间等效输入噪声电压		f = 1.0Hz 至 10kHz	25°C	2.77			2.77			μVpp
$I_n$	等效输入噪声电流	$V_{IC} = 0$	f = 1kHz	25°C	60			60			fA/√Hz
THD + N	总谐波失真 + 噪声	$V_{OUT} = 3V_{RMS}$ , G = 1, f = 1kHz, $R_L = 10k$		25°C	0.0032			0.0032			%
					90			90			dB
$B_1$	单位增益带宽			25°C	10.6			10.6			MHz
$B_{OM}$	最大输出摆幅带宽		$A_{VD} = -1$ , $C_L = 25pF$	25°C	300			300			kHz
$\phi_m$	单位增益下的相位裕度	$V_I = 10mV$ , $C_L = 25pF$	$R_L = 2k\Omega$	25°C	57°			57°			

### 6.31 TLE2074I 电气特性

在指定自然通风温度下， $V_{CC\pm} = \pm 5V$  (除非另有说明)

参数	测试条件	$T_A$ (1)	TLE2074I			TLE2074AI			单位		
			最小值	典型值	最大值	最小值	典型值	最大值			
$V_{IO}$	输入偏移电压	$V_{IC} = 0$ $R_S = 50 \Omega$	$V_O = 0$	25°C	-1.6	5	-0.5	3	mV		
				完整范围		9		7			
$a_{VIO}$	输入失调电压的温度系数			完整范围	10.1	30	10.1	30	$\frac{\mu V}{^\circ C}$		
$I_{IO}$	输入失调电流	$V_{IC} = 0$	$V_O = 0$	25°C	15	100	15	100	pA		
				完整范围		5		5	nA		
$I_{IB}$	输入偏置电流	$V_{IC} = 0$	$V_O = 0$	25°C	20	175	20	175	pA		
				完整范围		10		10	nA		
$V_{ICR}$	共模输入电压范围	$R_S = 50 \Omega$		25°C	5 到 -1	5 到 -1.9	5 到 -1	5 到 -1.9	V		
				完整范围	5 到 -0.8		5 到 -0.8				
$V_{OM+}$	最大正峰值输出电压摆幅			25°C	3.8	4.985	3.8	4.985	V		
				25°C	3.5	4.925	3.5	4.925			
				25°C	1.5	4.5	1.5	4.5			
$V_{OM-}$	最大负峰值输出电压摆幅			25°C	-3.5	-4.985	-3.5	-4.985	V		
				25°C	-3.7	-4.925	-3.7	-4.925			
				25°C	-1.5	-4.5	-1.5	-4.5			
$A_{VD}$	大信号差分电压放大			25°C	80	91	80	91	dB		
				25°C	90	100	90	100			
				25°C	95	106	95	106			
$r_i$	输入电阻	$V_{IC} = 0$	共模	25°C	100		100	M $\Omega$			
			差分	25°C	6		6	T $\Omega$			
$C_i$	输入电容	$V_{IC} = 0$	共模	25°C	1		1	pF			
			差分	25°C	9		9				
$Z_o$	开环输出阻抗	$I_O = 0A$		25°C	请参阅 图 6-15		请参阅 图 6-15		$\Omega$		
CMRR	共模抑制比	$V_{IC} = V_{ICRmin}$ , $V_O = 0$	$R_S = 50 \Omega$	25°C	85		85		dB		
$k_{SVR}$	电源电压抑制比 ( $\Delta V_{CC\pm}/\Delta V_{IO}$ )	$V_{CC\pm} = \pm 5V$ 至 $\pm 15V$		25°C	82	99	82	99	dB		
		$V_O = 0$	$R_S = 50 \Omega$	完整范围	80		80				
$I_{CC}$	电源电流 (每个放大器)	$V_O = 0$	无负载	25°C	1.35	2.4	2.8	1.35	2.4	2.8	mA
	串扰衰减	$V_{IC} = 0$	$R_L = 2k \Omega$	25°C	120		120		dB		
$I_{OS}$	短路输出电流			25°C	$\pm 65$		$\pm 65$		mA		

(1) 完整范围为 -40°C 至 85°C。

## 6.32 TLE2074I 工作特性

在指定自然通风温度下,  $V_{CC\pm} = \pm 5V$

参数		测试条件		$T_A$	TLE2074I			TLE2074AI			单位
					最小值	典型值	最大值	最小值	典型值	最大值	
SR	压摆率	$V_{O(PP)} = \pm 2.3V$ , $A_{VD} = -1$ , $C_L = 20pF$	$R_L = 2k\Omega$	25°C	32			32			V/μs
$t_s$	趋稳时间	$A_{VD} = -1$ , 2V 阶跃	至 10mV	25°C	0.25			0.25			μs
			至 1mV		0.4			0.4			
$V_n$	等效输入噪声电压	$R_S = 20\Omega$	f = 10Hz	25°C	48			48			nV/√Hz
			f = 10kHz		4.4			4.4			
$V_{N(PP)}$	峰值间等效输入噪声电压		f = 0.1Hz 至 10Hz		2.77			2.77			μV <sub>PP</sub>
$I_n$	等效输入噪声电流	$V_{IC} = 0$	f = 1kHz	25°C	60			60			fA/√Hz
				25°C	90			90			dB
THD + N	总谐波失真 + 噪声	$V_O = 3V_{RMS}$ , $G = 1$ , f = 1kHz	$R_L = 10k$	25°C	0.0032			0.0032			%
				25°C	90			90			dB
$B_1$	单位增益带宽			25°C	10.6			10.6			MHz
$B_{OM}$	最大输出摆幅带宽		$A_{VD} = -1$ , $C_L = 25pF$	25°C	300			300			kHz
$\phi_m$	单位增益下的相位裕度	$V_I = 10mV$ , $C_L = 25pF$	$R_L = 2k\Omega$	25°C	56°			56°			

### 6.33 TLE2074I 电气特性

在指定自然通风温度下， $V_{CC\pm} = \pm 15V$  (除非另有说明)

参数		测试条件		$T_A$ <sup>(1)</sup>	TLE2074I			TLE2074AI			单位	
					最小值	典型值	最大值	最小值	典型值	最大值		
$V_{IO}$	输入偏移电压	$V_{IC} = 0$ , $R_D = 50 \Omega$	$V_O = 0$	25°C	-1.6		5	-0.5		3	mV	
				完整范围						7		
$a_{VIO}$	输入失调电压的温度系数			完整范围	10.1		30	10.1		30	$\mu V/^\circ C$	
$I_{IO}$	输入失调电流	$V_{IC} = 0$	$V_O = 0$	25°C	15		100	15		100	pA	
				完整范围						5		5
$I_{IB}$	输入偏置电流			25°C	25		175	25		175	pA	
				完整范围						10		10
$V_{ICR}$	共模输入电压范围	$R_S = 50 \Omega$		25°C	15 到 -11	15 到 -11.9		15 到 -11	15 到 -11.9		V	
				完整范围	15 到 -10.8			15 到 -10.8				
$V_{OM+}$	最大正峰值输出电压摆幅			$I_O = -200mA$	25°C	13.8	14.98 5	13.8	14.98 5		V	
				$I_O = -2mA$	25°C	13.5	14.92 5	13.5	14.92 5			
				$I_O = -20mA$	25°C	11.5	14.5	11.5	14.5			
$V_{OM-}$	最大负峰值输出电压摆幅			$I_O = 200mA$	25°C	-13.8	-14.98 5	-13.8	-14.98 5		V	
				$I_O = 2mA$	25°C	-13.5	-14.92 5	-13.5	-14.92 5			
				$I_O = 20mA$	25°C	-11.5	-14.5	-11.5	-14.5			
$A_{VD}$	大信号差分电压放大			$R_L = 600 \Omega$	25°C	80	96	80	96		dB	
				$R_L = 2k \Omega$	25°C	90	109	90	109			
				$R_L = 10k \Omega$	25°C	95	118	95	118			
$r_i$	输入电阻	$V_{IC} = 0$		共模	25°C		100		100		$M \Omega$	
				差分	25°C		6		6		$T \Omega$	
$C_i$	输入电容	$V_{IC} = 0$		共模	25°C		1		1		pF	
				差分	25°C		9		9			
$Z_o$	开环输出阻抗			$I_O = 0A$	25°C	请参阅 图 6-15			请参阅 图 6-15		$\Omega$	
CMRR	共模抑制比	$V_{IC} = V_{ICRmin}$ , $V_O = 0$	$R_S = 50 \Omega$		25°C	98			98		dB	
$k_{SVR}$	电源电压抑制比 ( $\Delta V_{CC\pm} / \Delta V_{IO}$ )	$V_{CC\pm} = \pm 5V$ 至 $\pm 15V$ , $V_O = 0$ , $R_S = 50 \Omega$			25°C	82	99	82	99		dB	
$I_{CC}$	电源电流 (每个放大器)	$V_O = 0$	无负载		25°C	1.35	2.4	2.8	1.35	2.4	2.8	mA
	串扰衰减	$V_{IC} = 0$	$R_L = 2k \Omega$		25°C	120			120		dB	
$I_{OS}$	短路输出电流				25°C	$\pm 65$			$\pm 65$		mA	

(1) 完整范围为 -40°C 至 85°C。

### 6.34 TLE2074I 工作特性

在指定自然通风温度下， $V_{CC\pm} = \pm 15V$

参数	测试条件	$T_A$	TLE2074I			TLE2074AI			单位	
			最小值	典型值	最大值	最小值	典型值	最大值		
SR	压摆率	$V_{O(PP)} = 10V$ , $R_L = 2k\Omega$ , $A_{VD} = -1$ , $C_L = 20pF$	25°C	32			32			V/μs
$t_s$	趋稳时间	$A_{VD} = -1$ , 10V 阶跃	25°C	至 10mV			0.4			μs
				至 1mV			1.5			
$V_n$	等效输入噪声电压	$R_S = 20\Omega$	25°C	f = 10Hz			48			nV/√Hz
				f = 10kHz			4.4			
$V_{N(PP)}$	峰值间等效输入噪声电压		25°C	f = 1.0Hz 至 10kHz			2.77			μVpp
$I_n$	等效输入噪声电流	$V_{IC} = 0$	25°C	f = 1kHz			60			fA/√Hz
THD+N	总谐波失真 + 噪声	$V_O = 3V_{RMS}$ , G = 1	25°C	$R_L = 10k\Omega = 1kHz$			0.0032			%
							90			dB
$B_1$	单位增益带宽		25°C	10.6			10.6			MHz
$B_{OM}$	最大输出摆幅带宽		25°C	$A_{VD} = -1$ , $C_L = 25pF$			300			kHz
$\phi_m$	单位增益下的相位裕度	$V_I = 10mV$ , $C_L = 25pF$	25°C	$R_L = 2k\Omega$			57°			

### 6.35 TLE2074M 电气特性

在指定自然通风温度下， $V_{CC\pm} = \pm 5V$  (除非另有说明)

参数		测试条件		$T_A$ <sup>(2)</sup>	TLE2074M			TLE2074AM			单位
					最小值	典型值	最大值	最小值	典型值	最大值	
$V_{IO}$	输入偏移电压	$V_{IC} = 0$ , $R_S = 50 \Omega$	$V_O = 0$	25°C	-1.6	5	-0.5	3	mV		
				完整范围	10.5		8.5				
$a_{VIO}$	输入失调电压的温度系数			完整范围	10.1	30 <sup>(1)</sup>	10.1	30 <sup>(1)</sup>	$\frac{\mu V}{^\circ C}$		
$I_{IO}$	输入失调电流	$V_{IC} = 0$	$V_O = 0$	25°C	15	100	15	100	pA		
				完整范围	20		20		nA		
$I_{IB}$	输入偏置电流			25°C	20	175	20	175	pA		
				完整范围	60		60		nA		
$V_{ICR}$	共模输入电压范围	$R_S = 50 \Omega$		25°C	5 到 -1	5 到 -1.9	5 到 -1	5 到 -1.9	V		
				完整范围	5 到 -0.8	5 到 -0.8					
$V_{OM+}$	最大正峰值输出电压摆幅			25°C	3.8	4.1	3.8	4.1	V		
				完整范围	3.6		3.6				
				25°C	3.5	3.9	3.5	3.9			
				完整范围	3.3		3.3				
				25°C	1.5	2.3	1.5	2.3			
				完整范围	1.4		1.4				
$V_{OM-}$	最大负峰值输出电压摆幅			25°C	-3.8	-4.2	-3.8	-4.2	V		
				完整范围	-3.6		-3.6				
				25°C	-3.5	-4.1	-3.5	-4.1			
				完整范围	-3.3		-3.3				
				25°C	-1.5	-2.4	-1.5	-2.4			
				完整范围	-1.4		-1.4				
$A_{VD}$	大信号差分电压放大	$V_O = \pm 2.3V$	$R_L = 600 \Omega$	25°C	80	91	80	91	dB		
				完整范围	78		78				
				25°C	90	100	90	100			
				完整范围	88		88				
				25°C	95	106	95	106			
				完整范围	93		93				
$r_i$	输入电阻	$V_{IC} = 0$		25°C	$10^{12}$		$10^{12}$		$\Omega$		
$c_i$	输入电容	共模	$V_{IC} = 0$	25°C	11		11		pF		
				25°C	2.5		2.5				
$Z_o$	开环输出阻抗			25°C	80		80		$\Omega$		
CMRR	共模抑制比	$V_{IC} = V_{ICRmin}$ , $V_O = 0$	$R_S = 50 \Omega$	25°C	70	89	70	89	dB		
				完整范围	68		68				
$K_{SVR}$	电源电压抑制比 ( $\Delta V_{CC\pm} / \Delta V_{IO}$ )	$V_{CC\pm} = \pm 5V$ 至 $\pm 15V$ $V_O = 0$	$R_S = 50 \Omega$	25°C	82	99	82	99	dB		
				完整范围	80		80				



### 6.35 TLE2074M 电气特性 (续)

在指定自然通风温度下,  $V_{CC\pm} = \pm 5V$  (除非另有说明)

参数		测试条件		$T_A^{(2)}$	TLE2074M			TLE2074AM			单位
					最小值	典型值	最大值	最小值	典型值	最大值	
$I_{CC}$	电源电流 (每个放大器)	$V_O = 0$	无负载	25°C	5.2	6.3	7.5	5.2	6.3	7.5	mA
				完整范围	7.5			7.5			
	串扰衰减	$V_{IC} = 0$	$R_L = 2k\Omega$	25°C	120			120			dB
$I_{OS}$	短路输出电流	$V_O = 0$	$V_{ID} = 1V$	25°C	-35			-35			mA
			$V_{ID} = -1V$		45			45			

### 6.36 TLE2074M 工作特性

在指定自然通风温度下,  $V_{CC\pm} = \pm 5V$

参数		测试条件		$T_A^{(1)}$	TLE2074M			TLE2074AM			单位
					最小值	典型值	最大值	最小值	典型值	最大值	
SR+	正压摆率	$V_{O(PP)} = \pm 2.3V$ ,	$R_L = 2k\Omega$	25°C	35			35			V/ $\mu s$
				完整范围	18 <sup>(2)</sup>			18 <sup>(2)</sup>			
SR-	负压摆率	$A_{VD} = -1$ , $C_L = 100pF$	$R_L = 2k\Omega$	25°C	38			38			V/ $\mu s$
				完整范围	18 <sup>(2)</sup>			18 <sup>(2)</sup>			
$t_s$	趋稳时间	$A_{VD} = -1$ , 2V 阶跃, $R_L = 1k\Omega$ , $C_L = 100pF$	至 10mV	25°C	0.25			0.25			$\mu s$
			至 1mV		0.4			0.4			
$V_n$	等效输入噪声电压	$R_S = 20\Omega$	f = 10Hz	25°C	48	85 <sup>(2)</sup>	48	85 <sup>(2)</sup>	nV/ $\sqrt{Hz}$		
			f = 10kHz		12	17 <sup>(2)</sup>	12	17 <sup>(2)</sup>			
$V_{N(PP)}$	峰值间等效输入噪声电压	$R_S = 20\Omega$	f = 10Hz 至 10kHz	25°C	6			6			$\mu V$
			f = 0.1Hz 至 10Hz		0.6			0.6			
$I_n$	等效输入噪声电流	$V_{IC} = 0$	f = 10kHz	25°C	2.8			2.8			fA/ $\sqrt{Hz}$
THD + N	总谐波失真 + 噪声	$V_{O(PP)} = 5V$ , f = 1kHz, $R_S = 25\Omega$	$A_{VD} = 10$ , $R_L = 2k\Omega$	25°C	0.013%			0.013%			
$B_1$	单位增益带宽	$V_I = 10mV$ , $C_L = 25pF$	$R_L = 2k\Omega$	25°C	9.4			9.4			MHz
$B_{OM}$	最大输出摆幅带宽	$V_{O(PP)} = 4V$ , $R_L = 2k\Omega$	$A_{VD} = -1$ , $C_L = 25pF$	25°C	2.8			2.8			MHz
$\phi_m$	单位增益下的相位裕度	$V_I = 10mV$ , $C_L = 25pF$	$R_L = 2k\Omega$	25°C	56°			56°			

(1) 完整范围为 -55°C 至 125°C。

(2) 对于符合 MIL-PRF-38535 标准 B 级的产品, 此参数未经量产测试。

### 6.37 TLE2074M 电气特性

在指定自然通风温度下， $V_{CC\pm} = \pm 15V$  (除非另有说明)

参数		测试条件		$T_A$ (1)	TLE2074M			TLE2074AM			单位
					最小值	典型值	最大值	最小值	典型值	最大值	
$V_{IO}$	输入偏移电压	$V_{IC} = 0$ , $R_S = 50 \Omega$	$V_O = 0$	25°C	-1.6	5	-0.5	3	mV		
				完整范围	10.5		8.5				
$a_{VIO}$	输入失调电压的温度系数			完整范围	10.1	30 <sup>(2)</sup>	10.1	30 <sup>(2)</sup>	$\frac{\mu}{V/^\circ C}$		
$I_{IO}$	输入失调电流	$V_{IC} = 0$	$V_O = 0$	25°C	15	100	15	100	pA		
				完整范围	20		20		nA		
$I_{IB}$	输入偏置电流	$V_{IC} = 0$	$V_O = 0$	25°C	25	175	25	175	pA		
				完整范围	60		60		nA		
$V_{ICR}$	共模输入电压范围	$R_S = 50 \Omega$		25°C	15 到 -11	15 到 -11.9	15 到 -11	15 到 -11.9	V		
				完整范围	15 到 -10.8	15 到 -10.8					
$V_{OM+}$	最大正峰值输出电压摆幅			25°C	13.8	14.1	13.8	14.1	V		
				完整范围	13.6		13.6				
				25°C	13.5	13.9	13.5	13.9			
				完整范围	13.3		13.3				
				25°C	11.5	12.3	11.5	12.3			
				完整范围	11.4		11.4				
$V_{OM-}$	最大负峰值输出电压摆幅			25°C	-13.8	-14.2	-13.8	-14.2	V		
				完整范围	-13.6		-13.6				
				25°C	-13.5	-14	-13.5	-14			
				完整范围	-13.3		-13.3				
				25°C	-11.5	-12.4	-11.5	-12.4			
				完整范围	-11.4		-11.4				
$A_{VD}$	大信号差分电压放大	$V_O = \pm 10V$	$R_L = 600 \Omega$	25°C	80	96	80	96	dB		
				完整范围	78		78				
			$R_L = 2k \Omega$	25°C	90	109	90	109			
				完整范围	88		88				
			$R_L = 10k \Omega$	25°C	95	118	95	118			
				完整范围	93		93				
$r_i$	输入电阻	$V_{IC} = 0$		25°C	10 <sup>12</sup>		10 <sup>12</sup>		$\Omega$		
$C_i$	输入电容	共模	$V_{IC} = 0$	25°C	7.5		7.5		pF		
				25°C	2.5		2.5				
$Z_o$	开环输出阻抗	$f = 1MHz$		25°C	80		80		$\Omega$		
CMRR	共模抑制比	$V_{IC} = V_{ICRmin}$ , $V_O = 0$	$R_S = 50 \Omega$	25°C	80	98	80	98	dB		
				完整范围	78		78				
$K_{SVR}$	电源电压抑制比 ( $\Delta V_{CC\pm} / \Delta V_{IO}$ )	$V_{CC\pm} = \pm 5V$ 至 $\pm 15V$ $V_O = 0$	$R_S = 50 \Omega$	25°C	82	99	82	99	dB		
				完整范围	80		80				

### 6.37 TLE2074M 电气特性 (续)

在指定自然通风温度下,  $V_{CC\pm} = \pm 15V$  (除非另有说明)

参数		测试条件		$T_A$ (1)	TLE2074M			TLE2074AM			单位
					最小值	典型值	最大值	最小值	典型值	最大值	
$I_{CC}$	电源电流 (4个放大器)	$V_O = 0$	无负载	25°C	5.2	6.5	7.5	5.2	6.5	7.5	mA
				完整范围			7.5			7.5	
	串扰衰减	$V_{IC} = 0$	$R_L = 2k\Omega$	25°C	120			120			dB
$I_{OS}$	短路输出电流	$V_O = 0$	$V_{ID} = 1V$	25°C	-30	-45		-30	-45		mA
			$V_{ID} = -1V$		30	48		30	48		

(1) 完整范围为 -55°C 至 125°C。

(2) 对于符合 MIL-PRF-38535 标准 B 级的产品, 此参数未经量产测试。

### 6.38 TLE2074M 工作特性

在指定自然通风温度下,  $V_{CC\pm} = \pm 15V$

参数		测试条件		$T_A$ (1)	TLE2074M			TLE2074AM			单位
					最小值	典型值	最大值	最小值	典型值	最大值	
SR+	正压摆率	$V_{O(PP)} = 10V$ , $R_L = 2k\Omega$	$A_{VD} = -1$ , $C_L = 100pF$	25°C	25	40		25	40		V/ $\mu s$
				完整范围	17			17			
SR-	负压摆率	$R_L = 2k\Omega$	$A_{VD} = -1$ , $C_L = 100pF$	25°C	30	45		30	45		V/ $\mu s$
				完整范围	20			20			
$t_s$	趋稳时间	$A_{VD} = -1$ , 10V 阶跃, $R_L = 1k\Omega$ , $C_L = 100pF$	至 10mV	25°C	0.4			0.4			$\mu s$
			至 1mV		1.5			1.5			
$V_n$	等效输入噪声电压	$R_S = 20\Omega$	$f = 10Hz$ $f = 10kHz$	25°C	48	85 (2)		48	85 (2)		nV/ $\sqrt{Hz}$
					12	17 (2)		12	17 (2)		
$V_{N(PP)}$	峰值间等效输入噪声电压	$R_S = 20\Omega$	$f = 10Hz$ 至 10kHz	25°C	6			6			$\mu V$
			$f = 0Hz$ 至 10Hz		0.6			0.6			
$I_n$	等效输入噪声电流	$V_{IC} = 0$	$f = 10kHz$	25°C	2.8			2.8			fA/ $\sqrt{Hz}$
THD + N	总谐波失真 + 噪声	$V_{O(PP)} = 20V$ , $f = 1kHz$ , $R_S = 25\Omega$	$A_{VD} = 10$ , $R_L = 2k\Omega$	25°C	0.008%			0.008%			
$B_1$	单位增益带宽	$V_I = 10mV$ , $C_L = 25pF$	$R_L = 2k\Omega$	25°C	8 (2)	10		8 (2)	10		MHz
$B_{OM}$	最大输出摆幅带宽	$V_{O(PP)} = 20V$ , $R_L = 2k\Omega$	$A_{VD} = -1$ , $C_L = 25pF$	25°C	478 (2)	637		478 (2)	637		kHz
$\phi_m$	单位增益下的相位裕度	$V_I = 10mV$ , $C_L = 25pF$	$R_L = 2k\Omega$	25°C	57°			57°			

(1) 完整范围为 -55°C 至 125°C。

(2) 对于符合 MIL-PRF-38535 标准 B 级的产品, 此参数未经量产测试。

### 6.39 典型特性



图 6-1. TLE2071 输入失调电压的分布



图 6-2. TLE2072 输入失调电压的分布

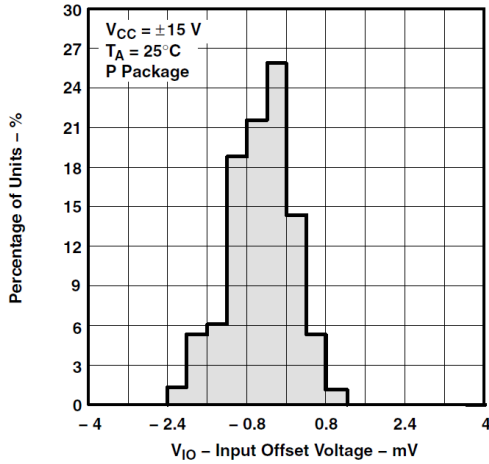

图 6-3. TLE2074 输入失调电压的分布

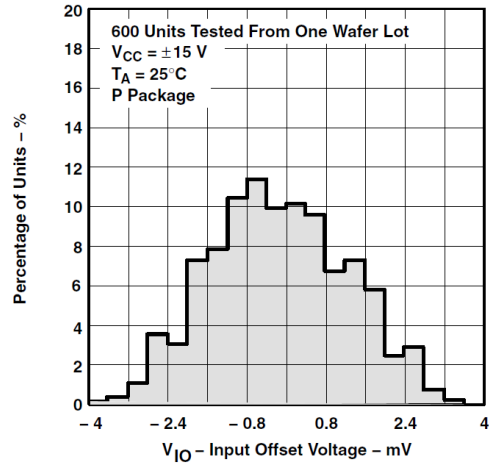

图 6-4. TLE2071 输入失调电压温度系数的分布

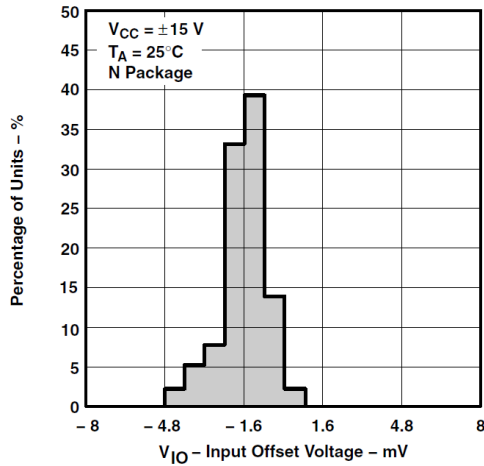

图 6-5. TLE2072 输入失调电压温度系数的分布

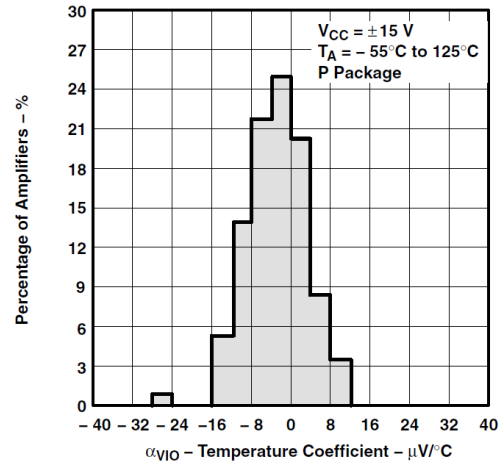

图 6-6. TLE2074 输入失调电压温度系数的分布

6.39 典型特性 (续)

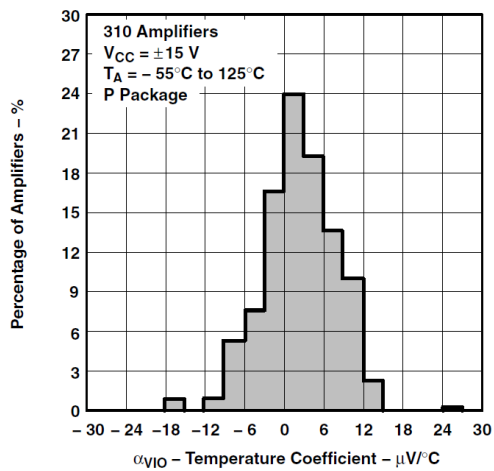

图 6-7. 输入偏置电流和输入偏移电流与自然通风温度间的关系

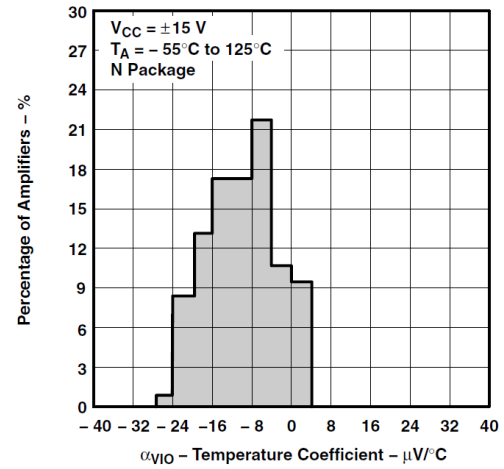

图 6-8. 输入偏置电流和输入偏移电流与自然通风温度间的关系

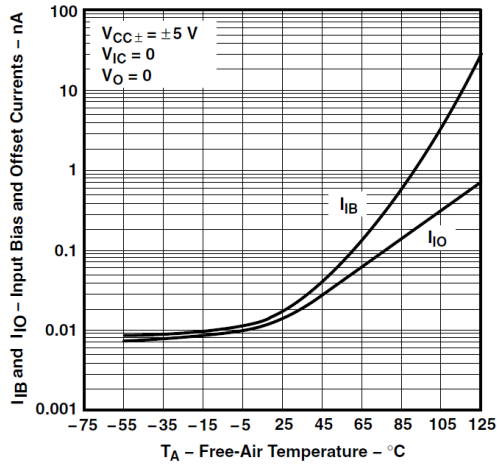

图 6-9. 输入偏置电流与总电源电压间的关系

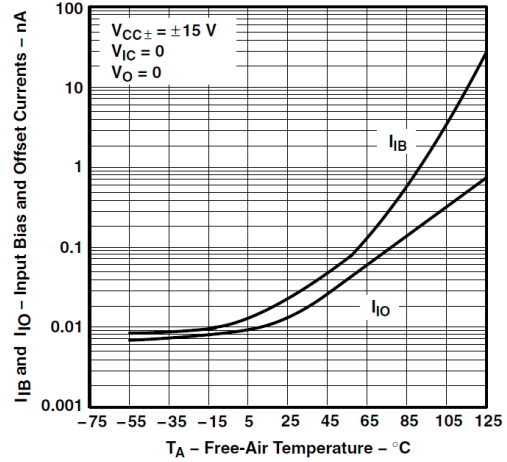

图 6-10. 相位裕度与负载电容间的关系

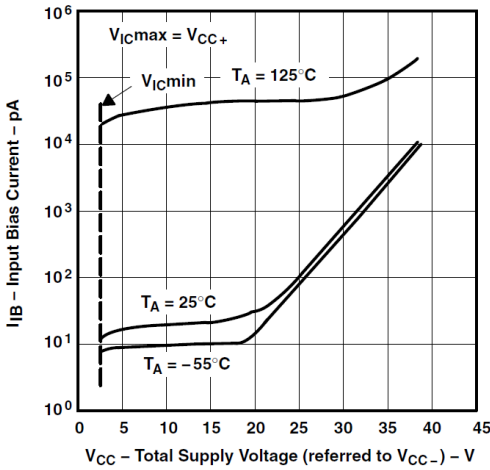

图 6-11. 同相大信号脉冲响应

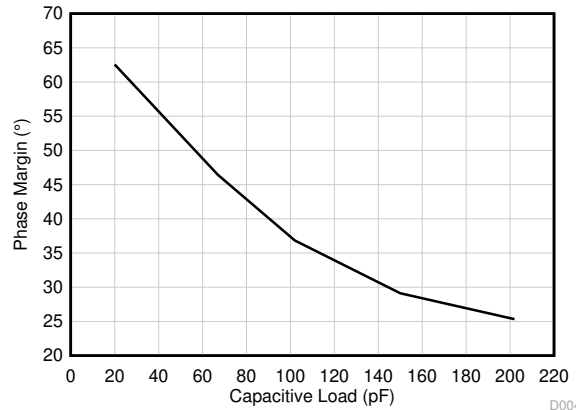

图 6-12. 同相大信号脉冲响应

### 6.39 典型特性 (续)

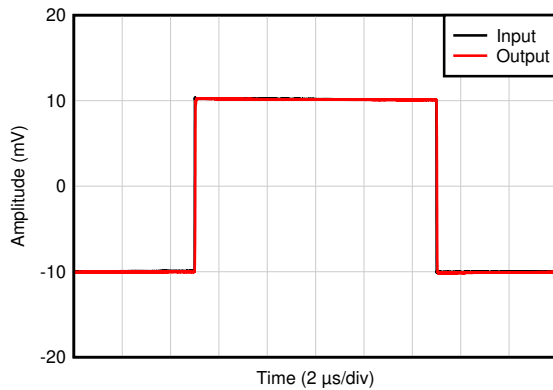

图 6-13. 小信号脉冲响应

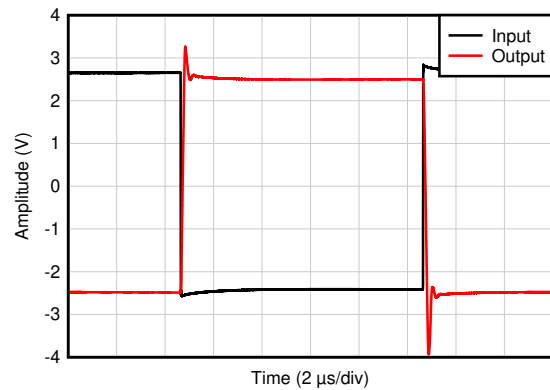

图 6-14. 小信号脉冲响应

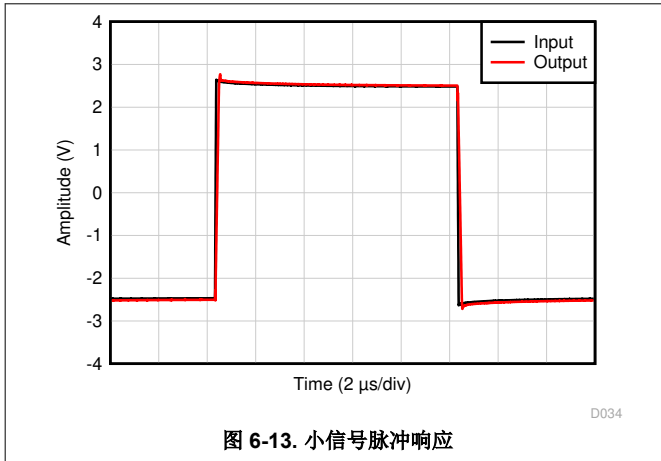

图 6-15. 开环输出阻抗与频率间的关系

## 7 应用和实例

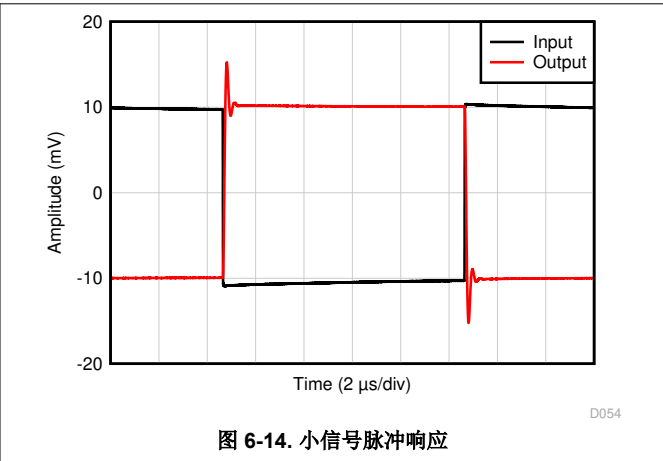
### 备注

以下应用部分中的信息不属于 TI 元件规格，TI 不担保其准确性和完整性。TI 的客户负责确定元件是否适合其用途，以及验证和测试其设计实现以确认系统功能。

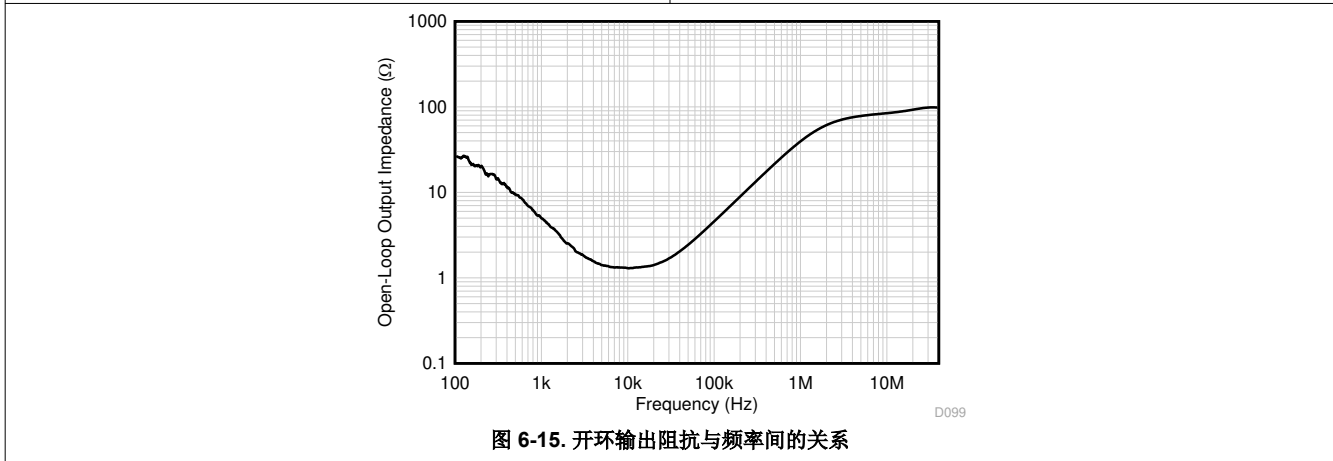
### 7.1 应用信息

#### 7.1.1 输入特性

指定了 TLE207x、TLE207xA 和 TLE207xB 的最小和最大输入电压，如果任一输入端超过该电压，可能会导致器件故障。由于极高的输入阻抗和由此产生的低偏置电流要求，TLE207x、TLE207xA 和 TLE207xB 非常适合低电平信号处理；然而，印刷电路板和插座上的漏电流很容易超过偏置电流要求并导致系统性能下降。在输入端周围添加防护环被认为是良好的做法（请参见图 7-1）。在与共模输入相同的电压电平下，可以从低阻抗源驱动这些防护装置。



图 7-1. 使用防护环

## 8 器件和文档支持

TI 提供广泛的开发工具。下面列出了用于评估器件性能、生成代码和开发解决方案的工具和软件。

### 8.1 接收文档更新通知

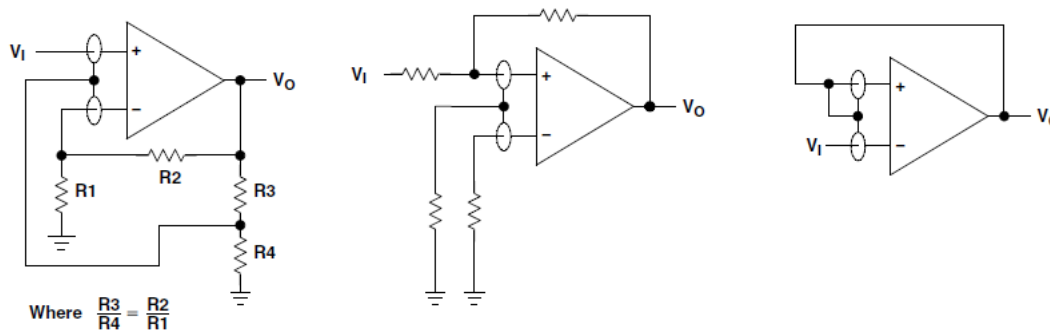
要接收文档更新通知，请导航至 [ti.com](http://ti.com) 上的器件产品文件夹。点击 [通知](#) 进行注册，即可每周接收产品信息更改摘要。有关更改的详细信息，请查看任何已修订文档中包含的修订历史记录。

### 8.2 支持资源

[TI E2E™ 中文支持论坛](#) 是工程师的重要参考资料，可直接从专家处获得快速、经过验证的解答和设计帮助。搜索现有解答或提出自己的问题，获得所需的快速设计帮助。

链接的内容由各个贡献者“按原样”提供。这些内容并不构成 TI 技术规范，并且不一定反映 TI 的观点；请参阅 TI 的 [使用条款](#)。

### 8.3 商标

TI E2E™ is a trademark of Texas Instruments.

所有商标均为其各自所有者的财产。

### 8.4 静电放电警告



静电放电 (ESD) 会损坏这个集成电路。德州仪器 (TI) 建议通过适当的预防措施处理所有集成电路。如果不遵守正确的处理和安装程序，可能会损坏集成电路。

ESD 的损坏小至导致微小的性能降级，大至整个器件故障。精密的集成电路可能更容易受到损坏，这是因为非常细微的参数更改都可能会导致器件与其发布的规格不相符。

### 8.5 术语表

[TI 术语表](#) 本术语表列出并解释了术语、首字母缩略词和定义。

## 9 修订历史记录

注：以前版本的页码可能与当前版本的页码不同

Changes from Revision C (February 1997) to Revision D (January 2025)	Page
• 删除了“微调片上失调电压，可提高直流性能”	1
• 删除了“直接升级至 TL05x、TL07x 和 TL08x 运算放大器”	1
• 将低偏置电流从 $\pm 1\text{pA}$ 更改至 $\pm 15\text{pA}$	1
• 删除了流入和流出 VCC 的总电流	7
• 更改了电源电压值	7
• 更改了共模输入电压输入范围	7
• 将最小值从 -19V 更改为 0V	7
• 将最大正峰值输出电压摆幅典型值从 4.1V 更改为 4.985V	8
• 将最大正峰值输出电压摆幅典型值从 3.9V 更改为 4.925V	8
• 将最大正峰值输出电压摆幅典型值从 2.3V 更改为 4.5V	8
• 删除了 $I_{OS}$ CMRR 中的完整范围值	8
• 将最大负峰值输出电压摆幅典型值从 -4.2V 更改为 -4.985V	8
• 将最大负峰值输出电压摆幅典型值从 -4.1V 更改为 -4.925V	8
• 将最大负峰值输出电压摆幅典型值从 -2.4V 更改为 -4.5V	8
• 删除了 $A_{VD}$ 中的完整范围值	8
• 将差分 and 共模的输入电阻分隔值更改为 $100\text{M}\Omega$ 和 $6\text{T}\Omega$	8
• 将输入电容从 $11\text{pF}$ 更改为 $1\text{pF}$ ，从 $2.9\text{pF}$ 更改为 $9\text{pF}$	8
• 将 CMRR 典型值从 89dB 更改为 85dB	8



• 将电源电流值从 1.6mA 更改为 2.48mA，从 2.2mA 更改为 2.92mA。.....	8
• 将短路输出电流从 - 35mA 更改为 ±65mA。.....	8
• 将 EC 规格表中的压摆率典型值从 35V/μs 更改为 32V/μs。.....	9
• 在 EC 规格表中合并了正负压摆率。.....	9
• 删除了 EC 规格表中等效输入噪声电压的最大值和 10kHz 典型值的最大值，从 12nV/√Hz 更新为 4.4nV/√Hz。.....	9
• 在 EC 规格表中，将峰值间等效输入噪声电压从 0.6 μV <sub>PP</sub> 更改为 2.77 μV <sub>PP</sub> 。.....	9
• 在 EC 规格表中，将 1KHz 下的等效输入噪声电流从 2.8fA/√Hz 更改为 60fA/√Hz。.....	9
• 在 EC 规格表中，将 THD + N 值从 0.013% 更改为 0.0032% 和 90dB。.....	9
• 在 EC 规格表中，将单位增益带宽典型值从 9.4MHz 更改为 10.6MHz。.....	9
• 在 EC 规格表中，将最大输出摆幅带宽从 2.8Mhz 更改为 300KHz。.....	9
• 将 200 μA 时的 V <sub>OM+</sub> 值从 14.1V 更改为 14.985V，2mA 时从 13.9V 更改为 14.925V，20mA 时从 12.3V 更改为 14.5V。.....	9
• 将 200 μA 时的 V <sub>OM-</sub> 值从 - 14.2V 更改为 - 14.985V，2mA 时从 - 14V 更改为 - 14.925V，20mA 时从 - 12.4V 更改为 - 14.5V。.....	9
• 删除了 CMRR 的完整范围。.....	9
• 将输入电容差分模式从 2.5pF 更改为 9pF.....	9
• 将输入电容共模从 7.5pF 更改为 1pF.....	9
• 将电源电流典型值从 1.7mA 更改为 2.48mA.....	9
• 将电源电流最大值从 2.2mA 更改为 2.92mA.....	9
• 将短路输出电流典型值更改为 ±65mA.....	9
• 更新了相位裕度与负载电容间的关系图.....	44
• 更新了同相大信号脉冲响应图.....	44
• 更新了小信号脉冲响应图.....	44
• 更新了开环输出阻抗与频率间的关系图.....	44
• 删除了 <i>典型特性</i> 部分中的几个图表。.....	44

## 10 机械、封装和可订购信息

以下页面包含机械、封装和可订购信息。这些信息是指定器件可用的最新数据。数据如有变更，恕不另行通知，且不会对此文档进行修订。有关此数据表的浏览器版本，请查阅左侧的导航栏。

**PACKAGING INFORMATION**

Orderable part number	Status (1)	Material type (2)	Package   Pins	Package qty   Carrier	RoHS (3)	Lead finish/ Ball material (4)	MSL rating/ Peak reflow (5)	Op temp (°C)	Part marking (6)
<a href="#">5962-9460201Q2A</a>	Active	Production	LCCC (FK)   20	55   TUBE	No	SNPB	N/A for Pkg Type	-55 to 125	5962- 9460201Q2A TLE2071 MFKB
<a href="#">5962-9460201QPA</a>	Active	Production	CDIP (JG)   8	50   TUBE	No	SNPB	N/A for Pkg Type	-55 to 125	9460201QPA TLE2071M
<a href="#">5962-9460202Q2A</a>	Active	Production	LCCC (FK)   20	55   TUBE	No	SNPB	N/A for Pkg Type	-55 to 125	5962- 9460202Q2A TLE2072 MFKB
<a href="#">5962-9460202QHA</a>	Active	Production	CFP (U)   10	25   TUBE	No	SNPB	N/A for Pkg Type	-55 to 125	9460202QHA TLE2072M
<a href="#">5962-9460202QPA</a>	Active	Production	CDIP (JG)   8	50   TUBE	No	SNPB	N/A for Pkg Type	-55 to 125	9460202QPA TLE2072M
<a href="#">5962-9460203Q2A</a>	Active	Production	LCCC (FK)   20	55   TUBE	No	SNPB	N/A for Pkg Type	-55 to 125	5962- 9460203Q2A TLE2074 MFKB
<a href="#">5962-9460203QCA</a>	Active	Production	CDIP (J)   14	25   TUBE	No	SNPB	N/A for Pkg Type	-55 to 125	5962-9460203QC A TLE2074MJB
<a href="#">5962-9460204Q2A</a>	Active	Production	LCCC (FK)   20	55   TUBE	No	SNPB	N/A for Pkg Type	-55 to 125	5962 9460204Q2A TLE2071 AMFKB
<a href="#">5962-9460204QHA</a>	Active	Production	CFP (U)   10	25   TUBE	No	SNPB	N/A for Pkg Type	-55 to 125	9460204QHA TLE2071AM
<a href="#">5962-9460204QPA</a>	Active	Production	CDIP (JG)   8	50   TUBE	No	SNPB	N/A for Pkg Type	-55 to 125	9460204QPA TLE2071AM
<a href="#">5962-9460205Q2A</a>	Active	Production	LCCC (FK)   20	55   TUBE	No	SNPB	N/A for Pkg Type	-55 to 125	5962- 9460205Q2A TLE2072 AMFKB
<a href="#">5962-9460205QHA</a>	Active	Production	CFP (U)   10	25   TUBE	No	SNPB	N/A for Pkg Type	-55 to 125	9460205QHA TLE2072AM

Orderable part number	Status (1)	Material type (2)	Package   Pins	Package qty   Carrier	RoHS (3)	Lead finish/ Ball material (4)	MSL rating/ Peak reflow (5)	Op temp (°C)	Part marking (6)
<a href="#">5962-9460205QPA</a>	Active	Production	CDIP (JG)   8	50   TUBE	No	SNPB	N/A for Pkg Type	-55 to 125	9460205QPA TLE2072AM
<a href="#">5962-9460206Q2A</a>	Active	Production	LCCC (FK)   20	55   TUBE	No	SNPB	N/A for Pkg Type	-55 to 125	5962- 9460206Q2A TLE2074 AMFKB
<a href="#">5962-9460206QCA</a>	Active	Production	CDIP (J)   14	25   TUBE	No	SNPB	N/A for Pkg Type	-55 to 125	5962-9460206QC A TLE2074AMJB
<a href="#">5962-9460206QDA</a>	Active	Production	CFP (W)   14	25   TUBE	No	SNPB	N/A for Pkg Type	-55 to 125	5962-9460206QD A TLE2074AMWB
<a href="#">TLE2071ACD</a>	Obsolete	Production	SOIC (D)   8	-	-	Call TI	Call TI	0 to 70	2071AC
<a href="#">TLE2071ACDR</a>	Active	Production	SOIC (D)   8	2500   LARGE T&R	Yes	NIPDAU	Level-1-260C-UNLIM	-40 to 85	2071AC
<a href="#">TLE2071ACDR.A</a>	Active	Production	SOIC (D)   8	2500   LARGE T&R	Yes	NIPDAU	Level-1-260C-UNLIM	-40 to 85	2071AC
<a href="#">TLE2071ACP</a>	Active	Production	PDIP (P)   8	50   TUBE	Yes	NIPDAU	N/A for Pkg Type	-40 to 85	TLE2071AC
<a href="#">TLE2071ACP.A</a>	Active	Production	PDIP (P)   8	50   TUBE	Yes	NIPDAU	N/A for Pkg Type	-40 to 85	TLE2071AC
<a href="#">TLE2071AID</a>	Obsolete	Production	SOIC (D)   8	-	-	Call TI	Call TI	-40 to 85	2071AI
<a href="#">TLE2071AIDR</a>	Active	Production	SOIC (D)   8	2500   LARGE T&R	Yes	NIPDAU	Level-1-260C-UNLIM	-40 to 85	2071AI
<a href="#">TLE2071AIDR.A</a>	Active	Production	SOIC (D)   8	2500   LARGE T&R	Yes	NIPDAU	Level-1-260C-UNLIM	-40 to 85	2071AI
<a href="#">TLE2071AIP</a>	Active	Production	PDIP (P)   8	50   TUBE	Yes	NIPDAU	N/A for Pkg Type	-40 to 85	TLE2071AI
<a href="#">TLE2071AIP.A</a>	Active	Production	PDIP (P)   8	50   TUBE	Yes	NIPDAU	N/A for Pkg Type	-40 to 85	TLE2071AI
<a href="#">TLE2071AMFKB</a>	Active	Production	LCCC (FK)   20	55   TUBE	No	SNPB	N/A for Pkg Type	-55 to 125	5962 9460204Q2A TLE2071 AMFKB
<a href="#">TLE2071AMFKB.A</a>	Active	Production	LCCC (FK)   20	55   TUBE	No	SNPB	N/A for Pkg Type	-55 to 125	5962 9460204Q2A TLE2071 AMFKB
<a href="#">TLE2071AMJG</a>	Active	Production	CDIP (JG)   8	50   TUBE	No	SNPB	N/A for Pkg Type	-55 to 125	TLE2071 AMJG
<a href="#">TLE2071AMJG.A</a>	Active	Production	CDIP (JG)   8	50   TUBE	No	SNPB	N/A for Pkg Type	-55 to 125	TLE2071 AMJG

Orderable part number	Status (1)	Material type (2)	Package   Pins	Package qty   Carrier	RoHS (3)	Lead finish/ Ball material (4)	MSL rating/ Peak reflow (5)	Op temp (°C)	Part marking (6)
<a href="#">TLE2071AMJGB</a>	Active	Production	CDIP (JG)   8	50   TUBE	No	SNPB	N/A for Pkg Type	-55 to 125	9460204QPA TLE2071AM
TLE2071AMJGB.A	Active	Production	CDIP (JG)   8	50   TUBE	No	SNPB	N/A for Pkg Type	-55 to 125	9460204QPA TLE2071AM
<a href="#">TLE2071AMUB</a>	Active	Production	CFP (U)   10	25   TUBE	No	SNPB	N/A for Pkg Type	-55 to 125	9460204QHA TLE2071AM
TLE2071AMUB.A	Active	Production	CFP (U)   10	25   TUBE	No	SNPB	N/A for Pkg Type	-55 to 125	9460204QHA TLE2071AM
<a href="#">TLE2071CD</a>	Obsolete	Production	SOIC (D)   8	-	-	Call TI	Call TI	0 to 70	2071C
<a href="#">TLE2071CP</a>	Active	Production	PDIP (P)   8	50   TUBE	Yes	NIPDAU	N/A for Pkg Type	-40 to 85	TLE2071CP
TLE2071CP.A	Active	Production	PDIP (P)   8	50   TUBE	Yes	NIPDAU	N/A for Pkg Type	-40 to 85	TLE2071CP
TLE2071CPE4	Active	Production	PDIP (P)   8	50   TUBE	-	Call TI	Call TI	-40 to 85	
<a href="#">TLE2071ID</a>	Obsolete	Production	SOIC (D)   8	-	-	Call TI	Call TI	-40 to 85	2071I
<a href="#">TLE2071IDR</a>	Active	Production	SOIC (D)   8	2500   LARGE T&R	Yes	NIPDAU	Level-1-260C-UNLIM	-40 to 85	2071I
TLE2071IDR.A	Active	Production	SOIC (D)   8	2500   LARGE T&R	Yes	NIPDAU	Level-1-260C-UNLIM	-40 to 85	2071I
<a href="#">TLE2071IP</a>	Active	Production	PDIP (P)   8	50   TUBE	Yes	NIPDAU	N/A for Pkg Type	-40 to 85	TLE2071IP
TLE2071IP.A	Active	Production	PDIP (P)   8	50   TUBE	Yes	NIPDAU	N/A for Pkg Type	-40 to 85	TLE2071IP
<a href="#">TLE2071MFKB</a>	Active	Production	LCCC (FK)   20	55   TUBE	No	SNPB	N/A for Pkg Type	-55 to 125	5962- 9460201Q2A TLE2071 MFKB
TLE2071MFKB.A	Active	Production	LCCC (FK)   20	55   TUBE	No	SNPB	N/A for Pkg Type	-55 to 125	5962- 9460201Q2A TLE2071 MFKB
<a href="#">TLE2071MJG</a>	Active	Production	CDIP (JG)   8	50   TUBE	No	SNPB	N/A for Pkg Type	-55 to 125	TLE2071MJG
TLE2071MJG.A	Active	Production	CDIP (JG)   8	50   TUBE	No	SNPB	N/A for Pkg Type	-55 to 125	TLE2071MJG
<a href="#">TLE2071MJGB</a>	Active	Production	CDIP (JG)   8	50   TUBE	No	SNPB	N/A for Pkg Type	-55 to 125	9460201QPA TLE2071M
TLE2071MJGB.A	Active	Production	CDIP (JG)   8	50   TUBE	No	SNPB	N/A for Pkg Type	-55 to 125	9460201QPA TLE2071M
<a href="#">TLE2072ACD</a>	Obsolete	Production	SOIC (D)   8	-	-	Call TI	Call TI	0 to 70	2072AC
<a href="#">TLE2072ACP</a>	Active	Production	PDIP (P)   8	50   TUBE	Yes	NIPDAU	N/A for Pkg Type	-40 to 85	TLE2072AC
TLE2072ACP.A	Active	Production	PDIP (P)   8	50   TUBE	Yes	NIPDAU	N/A for Pkg Type	-40 to 85	TLE2072AC

Orderable part number	Status (1)	Material type (2)	Package   Pins	Package qty   Carrier	RoHS (3)	Lead finish/ Ball material (4)	MSL rating/ Peak reflow (5)	Op temp (°C)	Part marking (6)
TLE2072ACPE4	Active	Production	PDIP (P)   8	50   TUBE	-	Call TI	Call TI	-40 to 85	
<a href="#">TLE2072AID</a>	Obsolete	Production	SOIC (D)   8	-	-	Call TI	Call TI	-40 to 85	2072AI
<a href="#">TLE2072AIDR</a>	Active	Production	SOIC (D)   8	2500   LARGE T&R	Yes	NIPDAU	Level-1-260C-UNLIM	-40 to 85	2072AI
TLE2072AIDR.A	Active	Production	SOIC (D)   8	2500   LARGE T&R	Yes	NIPDAU	Level-1-260C-UNLIM	-40 to 85	2072AI
<a href="#">TLE2072AIP</a>	Active	Production	PDIP (P)   8	50   TUBE	Yes	NIPDAU	N/A for Pkg Type	-40 to 85	TLE2072AI
TLE2072AIP.A	Active	Production	PDIP (P)   8	50   TUBE	Yes	NIPDAU	N/A for Pkg Type	-40 to 85	TLE2072AI
<a href="#">TLE2072AMFKB</a>	Active	Production	LCCC (FK)   20	55   TUBE	No	SNPB	N/A for Pkg Type	-55 to 125	5962- 9460205Q2A TLE2072 AMFKB
TLE2072AMFKB.A	Active	Production	LCCC (FK)   20	55   TUBE	No	SNPB	N/A for Pkg Type	-55 to 125	5962- 9460205Q2A TLE2072 AMFKB
<a href="#">TLE2072AMJG</a>	Active	Production	CDIP (JG)   8	50   TUBE	No	SNPB	N/A for Pkg Type	-55 to 125	TLE2072 AMJG
TLE2072AMJG.A	Active	Production	CDIP (JG)   8	50   TUBE	No	SNPB	N/A for Pkg Type	-55 to 125	TLE2072 AMJG
<a href="#">TLE2072AMJGB</a>	Active	Production	CDIP (JG)   8	50   TUBE	No	SNPB	N/A for Pkg Type	-55 to 125	9460205QPA TLE2072AM
TLE2072AMJGB.A	Active	Production	CDIP (JG)   8	50   TUBE	No	SNPB	N/A for Pkg Type	-55 to 125	9460205QPA TLE2072AM
<a href="#">TLE2072AMUB</a>	Active	Production	CFP (U)   10	25   TUBE	No	SNPB	N/A for Pkg Type	-55 to 125	9460205QHA TLE2072AM
TLE2072AMUB.A	Active	Production	CFP (U)   10	25   TUBE	No	SNPB	N/A for Pkg Type	-55 to 125	9460205QHA TLE2072AM
<a href="#">TLE2072CD</a>	Obsolete	Production	SOIC (D)   8	-	-	Call TI	Call TI	-	2072C
<a href="#">TLE2072CDR</a>	Active	Production	SOIC (D)   8	2500   LARGE T&R	Yes	NIPDAU	Level-1-260C-UNLIM	-	2072C
TLE2072CDR.A	Active	Production	SOIC (D)   8	2500   LARGE T&R	Yes	NIPDAU	Level-1-260C-UNLIM	-40 to 85	2072C
<a href="#">TLE2072CP</a>	Active	Production	PDIP (P)   8	50   TUBE	Yes	NIPDAU	N/A for Pkg Type	-	TLE2072CP
TLE2072CP.A	Active	Production	PDIP (P)   8	50   TUBE	Yes	NIPDAU	N/A for Pkg Type	-40 to 85	TLE2072CP
<a href="#">TLE2072ID</a>	Obsolete	Production	SOIC (D)   8	-	-	Call TI	Call TI	-	2072I
<a href="#">TLE2072IDR</a>	Active	Production	SOIC (D)   8	2500   LARGE T&R	Yes	NIPDAU	Level-1-260C-UNLIM	-40 to 85	2072I
TLE2072IDR.A	Active	Production	SOIC (D)   8	2500   LARGE T&R	Yes	NIPDAU	Level-1-260C-UNLIM	-40 to 85	2072I

Orderable part number	Status (1)	Material type (2)	Package   Pins	Package qty   Carrier	RoHS (3)	Lead finish/ Ball material (4)	MSL rating/ Peak reflow (5)	Op temp (°C)	Part marking (6)
TLE2072IDRG4	Active	Production	SOIC (D)   8	2500   LARGE T&R	-	Call TI	Call TI	-40 to 85	
<a href="#">TLE2072IP</a>	Active	Production	PDIP (P)   8	50   TUBE	Yes	NIPDAU	N/A for Pkg Type	-	TLE2072IP
TLE2072IP.A	Active	Production	PDIP (P)   8	50   TUBE	Yes	NIPDAU	N/A for Pkg Type	-40 to 85	TLE2072IP
<a href="#">TLE2072MFKB</a>	Active	Production	LCCC (FK)   20	55   TUBE	No	SNPB	N/A for Pkg Type	-55 to 125	5962- 9460202Q2A TLE2072 MFKB
TLE2072MFKB.A	Active	Production	LCCC (FK)   20	55   TUBE	No	SNPB	N/A for Pkg Type	-55 to 125	5962- 9460202Q2A TLE2072 MFKB
<a href="#">TLE2072MJG</a>	Active	Production	CDIP (JG)   8	50   TUBE	No	SNPB	N/A for Pkg Type	-55 to 125	TLE2072MJG
TLE2072MJG.A	Active	Production	CDIP (JG)   8	50   TUBE	No	SNPB	N/A for Pkg Type	-55 to 125	TLE2072MJG
<a href="#">TLE2072MJGB</a>	Active	Production	CDIP (JG)   8	50   TUBE	No	SNPB	N/A for Pkg Type	-55 to 125	9460202QPA TLE2072M
TLE2072MJGB.A	Active	Production	CDIP (JG)   8	50   TUBE	No	SNPB	N/A for Pkg Type	-55 to 125	9460202QPA TLE2072M
<a href="#">TLE2072MUB</a>	Active	Production	CFP (U)   10	25   TUBE	No	SNPB	N/A for Pkg Type	-55 to 125	9460202QHA TLE2072M
TLE2072MUB.A	Active	Production	CFP (U)   10	25   TUBE	No	SNPB	N/A for Pkg Type	-55 to 125	9460202QHA TLE2072M
<a href="#">TLE2074ACDW</a>	Active	Production	SOIC (DW)   16	40   TUBE	Yes	NIPDAU	Level-1-260C-UNLIM	0 to 70	TLE2074AC
TLE2074ACDW.A	Active	Production	SOIC (DW)   16	40   TUBE	Yes	NIPDAU	Level-1-260C-UNLIM	0 to 70	TLE2074AC
<a href="#">TLE2074ACN</a>	Active	Production	PDIP (N)   14	25   TUBE	Yes	NIPDAU	N/A for Pkg Type	-	TLE2074ACN
TLE2074ACN.A	Active	Production	PDIP (N)   14	25   TUBE	Yes	NIPDAU	N/A for Pkg Type	-40 to 85	TLE2074ACN
TLE2074ACNE4	Active	Production	PDIP (N)   14	25   TUBE	-	Call TI	Call TI	See TLE2074ACN	
<a href="#">TLE2074AIDW</a>	Active	Production	SOIC (DW)   16	40   TUBE	Yes	NIPDAU	Level-1-260C-UNLIM	-40 to 85	TLE2074AI
TLE2074AIDW.A	Active	Production	SOIC (DW)   16	40   TUBE	Yes	NIPDAU	Level-1-260C-UNLIM	-40 to 85	TLE2074AI
<a href="#">TLE2074AIN</a>	Active	Production	PDIP (N)   14	25   TUBE	Yes	NIPDAU	N/A for Pkg Type	-	TLE2074AIN
TLE2074AIN.A	Active	Production	PDIP (N)   14	25   TUBE	Yes	NIPDAU	N/A for Pkg Type	-40 to 85	TLE2074AIN
TLE2074AINE4	Active	Production	PDIP (N)   14	25   TUBE	-	Call TI	Call TI	See TLE2074AIN	

Orderable part number	Status (1)	Material type (2)	Package   Pins	Package qty   Carrier	RoHS (3)	Lead finish/ Ball material (4)	MSL rating/ Peak reflow (5)	Op temp (°C)	Part marking (6)
<a href="#">TLE2074AMFKB</a>	Active	Production	LCCC (FK)   20	55   TUBE	No	SNPB	N/A for Pkg Type	-55 to 125	5962-9460206Q2A TLE2074 AMFKB
TLE2074AMFKB.A	Active	Production	LCCC (FK)   20	55   TUBE	No	SNPB	N/A for Pkg Type	-55 to 125	5962-9460206Q2A TLE2074 AMFKB
<a href="#">TLE2074AMJ</a>	Active	Production	CDIP (J)   14	25   TUBE	No	SNPB	N/A for Pkg Type	-55 to 125	TLE2074AMJ
TLE2074AMJ.A	Active	Production	CDIP (J)   14	25   TUBE	No	SNPB	N/A for Pkg Type	-55 to 125	TLE2074AMJ
<a href="#">TLE2074AMJB</a>	Active	Production	CDIP (J)   14	25   TUBE	No	SNPB	N/A for Pkg Type	-55 to 125	5962-9460206QC A TLE2074AMJB
TLE2074AMJB.A	Active	Production	CDIP (J)   14	25   TUBE	No	SNPB	N/A for Pkg Type	-55 to 125	5962-9460206QC A TLE2074AMJB
<a href="#">TLE2074AMWB</a>	Active	Production	CFP (W)   14	25   TUBE	No	SNPB	N/A for Pkg Type	-55 to 125	5962-9460206QD A TLE2074AMWB
TLE2074AMWB.A	Active	Production	CFP (W)   14	25   TUBE	No	SNPB	N/A for Pkg Type	-55 to 125	5962-9460206QD A TLE2074AMWB
<a href="#">TLE2074CDW</a>	Active	Production	SOIC (DW)   16	40   TUBE	Yes	NIPDAU	Level-1-260C-UNLIM	0 to 70	TLE2074C
TLE2074CDW.A	Active	Production	SOIC (DW)   16	40   TUBE	Yes	NIPDAU	Level-1-260C-UNLIM	0 to 70	TLE2074C
<a href="#">TLE2074CDWR</a>	Active	Production	SOIC (DW)   16	2000   LARGE T&R	Yes	NIPDAU	Level-1-260C-UNLIM	-	TLE2074C
TLE2074CDWR.A	Active	Production	SOIC (DW)   16	2000   LARGE T&R	Yes	NIPDAU	Level-1-260C-UNLIM	-40 to 85	TLE2074C
<a href="#">TLE2074CN</a>	Active	Production	PDIP (N)   14	25   TUBE	Yes	NIPDAU	N/A for Pkg Type	-	TLE2074CN
TLE2074CN.A	Active	Production	PDIP (N)   14	25   TUBE	Yes	NIPDAU	N/A for Pkg Type	-40 to 85	TLE2074CN
<a href="#">TLE2074IDW</a>	Active	Production	SOIC (DW)   16	40   TUBE	Yes	NIPDAU	Level-1-260C-UNLIM	-40 to 85	TLE2074I
TLE2074IDW.A	Active	Production	SOIC (DW)   16	40   TUBE	Yes	NIPDAU	Level-1-260C-UNLIM	-40 to 85	TLE2074I
TLE2074IDWG4	Active	Production	SOIC (DW)   16	40   TUBE	-	Call TI	Call TI	-40 to 85	
<a href="#">TLE2074IDWR</a>	Active	Production	SOIC (DW)   16	2000   LARGE T&R	Yes	NIPDAU	Level-1-260C-UNLIM	-	TLE2074I
TLE2074IDWR.A	Active	Production	SOIC (DW)   16	2000   LARGE T&R	Yes	NIPDAU	Level-1-260C-UNLIM	-40 to 85	TLE2074I
<a href="#">TLE2074IN</a>	Active	Production	PDIP (N)   14	25   TUBE	Yes	NIPDAU	N/A for Pkg Type	-	TLE2074IN

Orderable part number	Status (1)	Material type (2)	Package   Pins	Package qty   Carrier	RoHS (3)	Lead finish/ Ball material (4)	MSL rating/ Peak reflow (5)	Op temp (°C)	Part marking (6)
TLE2074IN.A	Active	Production	PDIP (N)   14	25   TUBE	Yes	NIPDAU	N/A for Pkg Type	-40 to 85	TLE2074IN
<a href="#">TLE2074MFKB</a>	Active	Production	LCCC (FK)   20	55   TUBE	No	SNPB	N/A for Pkg Type	-55 to 125	5962-9460203Q2A TLE2074 MFKB
TLE2074MFKB.A	Active	Production	LCCC (FK)   20	55   TUBE	No	SNPB	N/A for Pkg Type	-55 to 125	5962-9460203Q2A TLE2074 MFKB
<a href="#">TLE2074MJ</a>	Active	Production	CDIP (J)   14	25   TUBE	No	SNPB	N/A for Pkg Type	-55 to 125	TLE2074MJ
TLE2074MJ.A	Active	Production	CDIP (J)   14	25   TUBE	No	SNPB	N/A for Pkg Type	-55 to 125	TLE2074MJ
<a href="#">TLE2074MJB</a>	Active	Production	CDIP (J)   14	25   TUBE	No	SNPB	N/A for Pkg Type	-55 to 125	5962-9460203QC A TLE2074MJB
TLE2074MJB.A	Active	Production	CDIP (J)   14	25   TUBE	No	SNPB	N/A for Pkg Type	-55 to 125	5962-9460203QC A TLE2074MJB

(1) **Status:** For more details on status, see our [product life cycle](#).

(2) **Material type:** When designated, preproduction parts are prototypes/experimental devices, and are not yet approved or released for full production. Testing and final process, including without limitation quality assurance, reliability performance testing, and/or process qualification, may not yet be complete, and this item is subject to further changes or possible discontinuation. If available for ordering, purchases will be subject to an additional waiver at checkout, and are intended for early internal evaluation purposes only. These items are sold without warranties of any kind.

(3) **RoHS values:** Yes, No, RoHS Exempt. See the [TI RoHS Statement](#) for additional information and value definition.

(4) **Lead finish/Ball material:** Parts may have multiple material finish options. Finish options are separated by a vertical ruled line. Lead finish/Ball material values may wrap to two lines if the finish value exceeds the maximum column width.

(5) **MSL rating/Peak reflow:** The moisture sensitivity level ratings and peak solder (reflow) temperatures. In the event that a part has multiple moisture sensitivity ratings, only the lowest level per JEDEC standards is shown. Refer to the shipping label for the actual reflow temperature that will be used to mount the part to the printed circuit board.

(6) **Part marking:** There may be an additional marking, which relates to the logo, the lot trace code information, or the environmental category of the part.



Multiple part markings will be inside parentheses. Only one part marking contained in parentheses and separated by a "~" will appear on a part. If a line is indented then it is a continuation of the previous line and the two combined represent the entire part marking for that device.

**Important Information and Disclaimer:** The information provided on this page represents TI's knowledge and belief as of the date that it is provided. TI bases its knowledge and belief on information provided by third parties, and makes no representation or warranty as to the accuracy of such information. Efforts are underway to better integrate information from third parties. TI has taken and continues to take reasonable steps to provide representative and accurate information but may not have conducted destructive testing or chemical analysis on incoming materials and chemicals. TI and TI suppliers consider certain information to be proprietary, and thus CAS numbers and other limited information may not be available for release.

In no event shall TI's liability arising out of such information exceed the total purchase price of the TI part(s) at issue in this document sold by TI to Customer on an annual basis.

**OTHER QUALIFIED VERSIONS OF TLE2071, TLE2071A, TLE2071AM, TLE2071M, TLE2072, TLE2072A, TLE2072AM, TLE2072M, TLE2074, TLE2074A, TLE2074AM, TLE2074M :**

- Catalog : [TLE2071A](#), [TLE2071](#), [TLE2072A](#), [TLE2072](#), [TLE2074A](#), [TLE2074](#)
- Automotive : [TLE2071A-Q1](#), [TLE2071A-Q1](#), [TLE2072A-Q1](#), [TLE2072A-Q1](#)
- Military : [TLE2071M](#), [TLE2071AM](#), [TLE2072M](#), [TLE2072AM](#), [TLE2074M](#), [TLE2074AM](#)

NOTE: Qualified Version Definitions:

- Catalog - TI's standard catalog product
- Automotive - Q100 devices qualified for high-reliability automotive applications targeting zero defects
- Military - QML certified for Military and Defense Applications

## TAPE AND REEL INFORMATION



### QUADRANT ASSIGNMENTS FOR PIN 1 ORIENTATION IN TAPE



\*All dimensions are nominal

Device	Package Type	Package Drawing	Pins	SPQ	Reel Diameter (mm)	Reel Width W1 (mm)	A0 (mm)	B0 (mm)	K0 (mm)	P1 (mm)	W (mm)	Pin1 Quadrant
TLE2071ACDR	SOIC	D	8	2500	330.0	12.4	6.4	5.2	2.1	8.0	12.0	Q1
TLE2071ACDR	SOIC	D	8	2500	330.0	12.4	6.4	5.2	2.1	8.0	12.0	Q1
TLE2071AIDR	SOIC	D	8	2500	330.0	12.4	6.4	5.2	2.1	8.0	12.0	Q1
TLE2071AIDR	SOIC	D	8	2500	330.0	12.4	6.4	5.2	2.1	8.0	12.0	Q1
TLE2071IDR	SOIC	D	8	2500	330.0	12.4	6.4	5.2	2.1	8.0	12.0	Q1
TLE2071IDR	SOIC	D	8	2500	330.0	12.4	6.4	5.2	2.1	8.0	12.0	Q1
TLE2072AIDR	SOIC	D	8	2500	330.0	12.4	6.4	5.2	2.1	8.0	12.0	Q1
TLE2072AIDR	SOIC	D	8	2500	330.0	12.4	6.4	5.2	2.1	8.0	12.0	Q1
TLE2072CDR	SOIC	D	8	2500	330.0	12.4	6.4	5.2	2.1	8.0	12.0	Q1
TLE2072CDR	SOIC	D	8	2500	330.0	12.4	6.4	5.2	2.1	8.0	12.0	Q1
TLE2072IDR	SOIC	D	8	2500	330.0	12.4	6.4	5.2	2.1	8.0	12.0	Q1
TLE2072IDR	SOIC	D	8	2500	330.0	12.4	6.4	5.2	2.1	8.0	12.0	Q1
TLE2074CDWR	SOIC	DW	16	2000	330.0	16.4	10.75	10.7	2.7	12.0	16.0	Q1
TLE2074IDWR	SOIC	DW	16	2000	330.0	16.4	10.75	10.7	2.7	12.0	16.0	Q1

**TAPE AND REEL BOX DIMENSIONS**

\*All dimensions are nominal

Device	Package Type	Package Drawing	Pins	SPQ	Length (mm)	Width (mm)	Height (mm)
TLE2071ACDR	SOIC	D	8	2500	353.0	353.0	32.0
TLE2071ACDR	SOIC	D	8	2500	353.0	353.0	32.0
TLE2071AIDR	SOIC	D	8	2500	353.0	353.0	32.0
TLE2071AIDR	SOIC	D	8	2500	353.0	353.0	32.0
TLE2071IDR	SOIC	D	8	2500	353.0	353.0	32.0
TLE2071IDR	SOIC	D	8	2500	353.0	353.0	32.0
TLE2072AIDR	SOIC	D	8	2500	353.0	353.0	32.0
TLE2072AIDR	SOIC	D	8	2500	353.0	353.0	32.0
TLE2072CDR	SOIC	D	8	2500	353.0	353.0	32.0
TLE2072CDR	SOIC	D	8	2500	353.0	353.0	32.0
TLE2072IDR	SOIC	D	8	2500	353.0	353.0	32.0
TLE2072IDR	SOIC	D	8	2500	353.0	353.0	32.0
TLE2074CDWR	SOIC	DW	16	2000	350.0	350.0	43.0
TLE2074IDWR	SOIC	DW	16	2000	350.0	350.0	43.0

**TUBE**

\*All dimensions are nominal

Device	Package Name	Package Type	Pins	SPQ	L (mm)	W (mm)	T (µm)	B (mm)
5962-9460201Q2A	FK	LCCC	20	55	506.98	12.06	2030	NA
5962-9460202Q2A	FK	LCCC	20	55	506.98	12.06	2030	NA
5962-9460202QHA	U	CFP	10	25	506.98	26.16	6220	NA
5962-9460203Q2A	FK	LCCC	20	55	506.98	12.06	2030	NA
5962-9460204Q2A	FK	LCCC	20	55	506.98	12.06	2030	NA
5962-9460204QHA	U	CFP	10	25	506.98	26.16	6220	NA
5962-9460205Q2A	FK	LCCC	20	55	506.98	12.06	2030	NA
5962-9460205QHA	U	CFP	10	25	506.98	26.16	6220	NA
5962-9460206Q2A	FK	LCCC	20	55	506.98	12.06	2030	NA
5962-9460206QDA	W	CFP	14	25	506.98	26.16	6220	NA
TLE2071ACP	P	PDIP	8	50	506	13.97	11230	4.32
TLE2071ACP.A	P	PDIP	8	50	506	13.97	11230	4.32
TLE2071AIP	P	PDIP	8	50	506	13.97	11230	4.32
TLE2071AIP.A	P	PDIP	8	50	506	13.97	11230	4.32
TLE2071AMFKB	FK	LCCC	20	55	506.98	12.06	2030	NA
TLE2071AMFKB.A	FK	LCCC	20	55	506.98	12.06	2030	NA
TLE2071AMUB	U	CFP	10	25	506.98	26.16	6220	NA
TLE2071AMUB.A	U	CFP	10	25	506.98	26.16	6220	NA
TLE2071CP	P	PDIP	8	50	506	13.97	11230	4.32
TLE2071CP.A	P	PDIP	8	50	506	13.97	11230	4.32
TLE2071IP	P	PDIP	8	50	506	13.97	11230	4.32
TLE2071IP.A	P	PDIP	8	50	506	13.97	11230	4.32
TLE2071MFKB	FK	LCCC	20	55	506.98	12.06	2030	NA
TLE2071MFKB.A	FK	LCCC	20	55	506.98	12.06	2030	NA
TLE2072ACP	P	PDIP	8	50	506	13.97	11230	4.32
TLE2072ACP.A	P	PDIP	8	50	506	13.97	11230	4.32
TLE2072AIP	P	PDIP	8	50	506	13.97	11230	4.32
TLE2072AIP.A	P	PDIP	8	50	506	13.97	11230	4.32
TLE2072AMFKB	FK	LCCC	20	55	506.98	12.06	2030	NA

Device	Package Name	Package Type	Pins	SPQ	L (mm)	W (mm)	T (µm)	B (mm)
TLE2072AMFKB.A	FK	LCCC	20	55	506.98	12.06	2030	NA
TLE2072AMUB	U	CFP	10	25	506.98	26.16	6220	NA
TLE2072AMUB.A	U	CFP	10	25	506.98	26.16	6220	NA
TLE2072CP	P	PDIP	8	50	506	13.97	11230	4.32
TLE2072CP.A	P	PDIP	8	50	506	13.97	11230	4.32
TLE2072IP	P	PDIP	8	50	506	13.97	11230	4.32
TLE2072IP.A	P	PDIP	8	50	506	13.97	11230	4.32
TLE2072MFKB	FK	LCCC	20	55	506.98	12.06	2030	NA
TLE2072MFKB.A	FK	LCCC	20	55	506.98	12.06	2030	NA
TLE2072MUB	U	CFP	10	25	506.98	26.16	6220	NA
TLE2072MUB.A	U	CFP	10	25	506.98	26.16	6220	NA
TLE2074ACDW	DW	SOIC	16	40	506.98	12.7	4826	6.6
TLE2074ACDW.A	DW	SOIC	16	40	506.98	12.7	4826	6.6
TLE2074ACN	N	PDIP	14	25	506	13.97	11230	4.32
TLE2074ACN.A	N	PDIP	14	25	506	13.97	11230	4.32
TLE2074AIDW	DW	SOIC	16	40	506.98	12.7	4826	6.6
TLE2074AIDW.A	DW	SOIC	16	40	506.98	12.7	4826	6.6
TLE2074AIN	N	PDIP	14	25	506	13.97	11230	4.32
TLE2074AIN.A	N	PDIP	14	25	506	13.97	11230	4.32
TLE2074AMFKB	FK	LCCC	20	55	506.98	12.06	2030	NA
TLE2074AMFKB.A	FK	LCCC	20	55	506.98	12.06	2030	NA
TLE2074AMWB	W	CFP	14	25	506.98	26.16	6220	NA
TLE2074AMWB.A	W	CFP	14	25	506.98	26.16	6220	NA
TLE2074CDW	DW	SOIC	16	40	506.98	12.7	4826	6.6
TLE2074CDW.A	DW	SOIC	16	40	506.98	12.7	4826	6.6
TLE2074CN	N	PDIP	14	25	506	13.97	11230	4.32
TLE2074CN.A	N	PDIP	14	25	506	13.97	11230	4.32
TLE2074IDW	DW	SOIC	16	40	506.98	12.7	4826	6.6
TLE2074IDW.A	DW	SOIC	16	40	506.98	12.7	4826	6.6
TLE2074IN	N	PDIP	14	25	506	13.97	11230	4.32
TLE2074IN.A	N	PDIP	14	25	506	13.97	11230	4.32
TLE2074MFKB	FK	LCCC	20	55	506.98	12.06	2030	NA
TLE2074MFKB.A	FK	LCCC	20	55	506.98	12.06	2030	NA

# PACKAGE OUTLINE

## JG0008A

### CDIP - 5.08 mm max height

CERAMIC DUAL IN-LINE PACKAGE



#### NOTES:

1. All linear dimensions are in millimeters. Any dimensions in parenthesis are for reference only. Dimensioning and tolerancing per ASME Y14.5M.
2. This drawing is subject to change without notice.
3. This package can be hermetically sealed with a ceramic lid using glass frit.
4. Index point is provided on cap for terminal identification.
5. Falls within MIL STD 1835 GDIP1-T8

# EXAMPLE BOARD LAYOUT

JG0008A

CDIP - 5.08 mm max height

CERAMIC DUAL IN-LINE PACKAGE

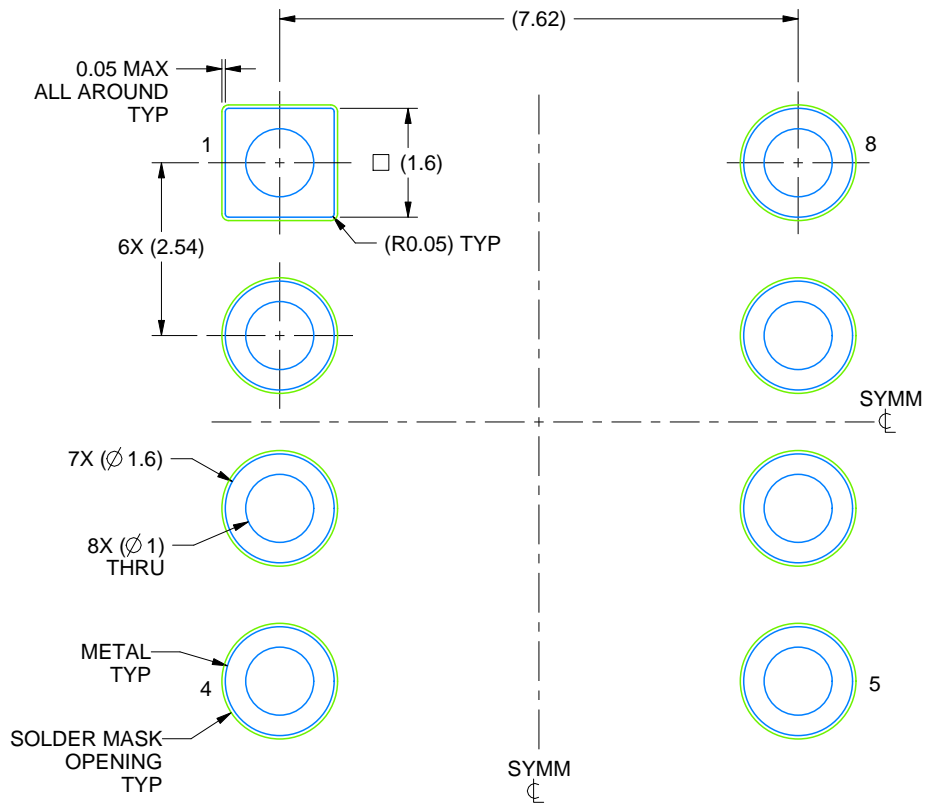

LAND PATTERN EXAMPLE  
NON SOLDER MASK DEFINED  
SCALE: 9X

4230036/A 09/2023





W (R-GDFP-F14)

CERAMIC DUAL FLATPACK



- NOTES:
- A. All linear dimensions are in inches (millimeters).
  - B. This drawing is subject to change without notice.
  - C. This package can be hermetically sealed with a ceramic lid using glass frit.
  - D. Index point is provided on cap for terminal identification only.
  - E. Falls within MIL STD 1835 GDFP1-F14

## GENERIC PACKAGE VIEW

**DW 16**

**SOIC - 2.65 mm max height**

7.5 x 10.3, 1.27 mm pitch

SMALL OUTLINE INTEGRATED CIRCUIT

This image is a representation of the package family, actual package may vary.  
Refer to the product data sheet for package details.

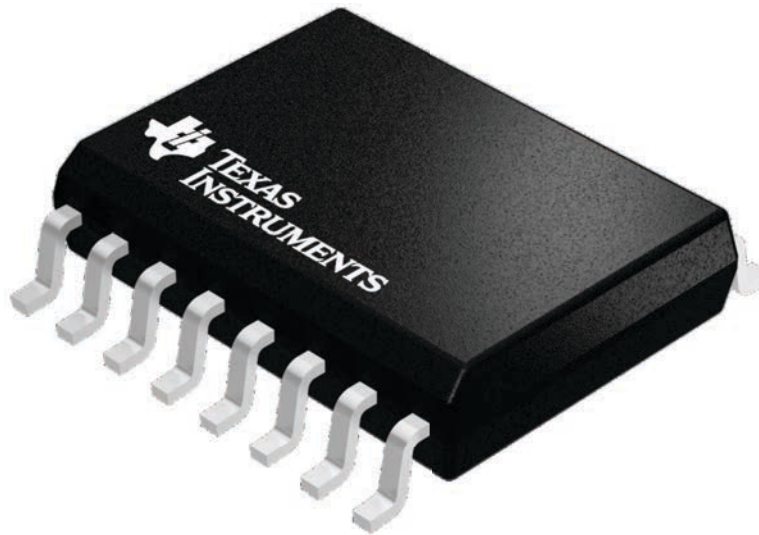

4224780/A



DW0016A

# PACKAGE OUTLINE

SOIC - 2.65 mm max height

SOIC

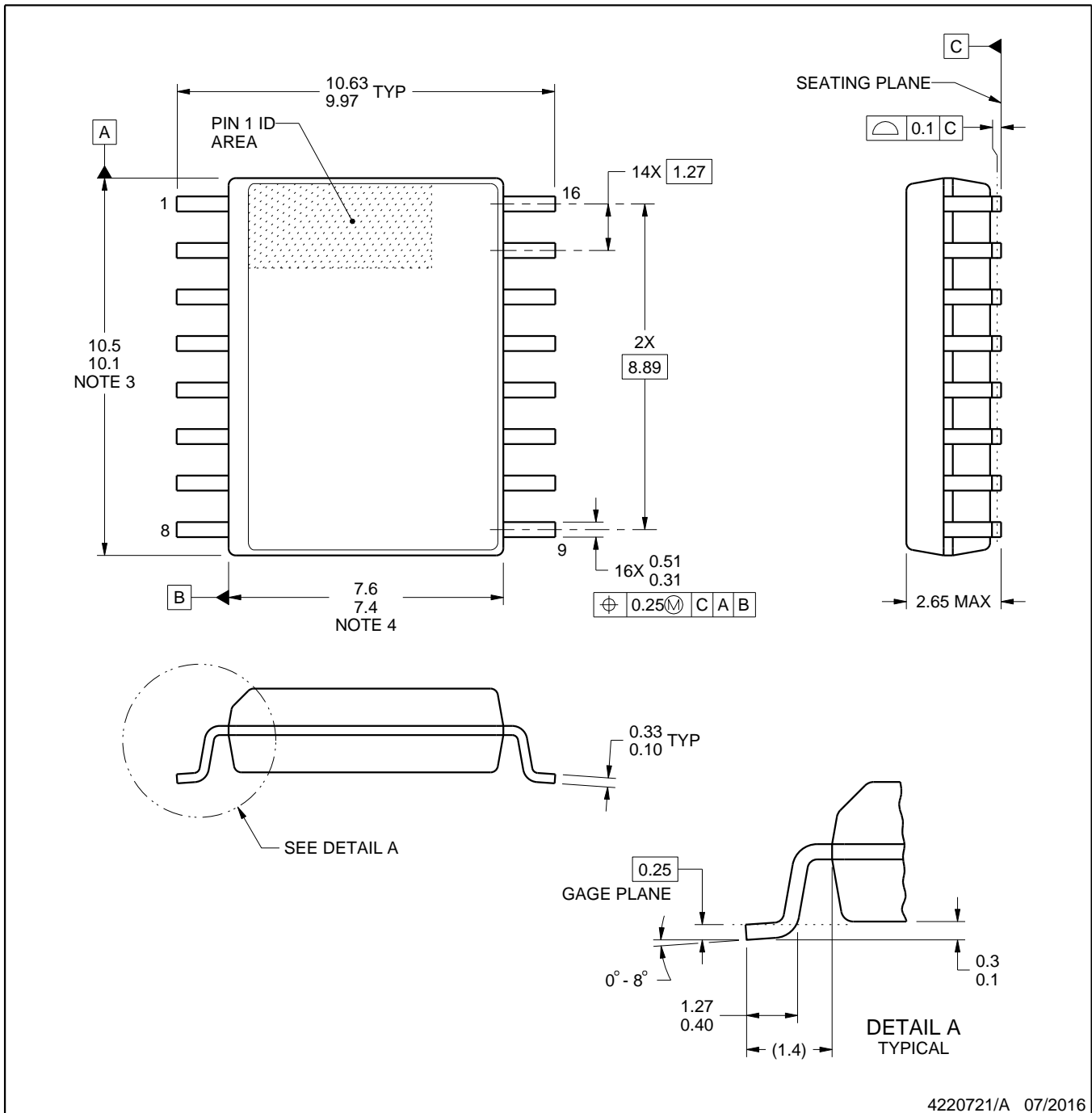

4220721/A 07/2016

NOTES:

1. All linear dimensions are in millimeters. Dimensions in parenthesis are for reference only. Dimensioning and tolerancing per ASME Y14.5M.
2. This drawing is subject to change without notice.
3. This dimension does not include mold flash, protrusions, or gate burrs. Mold flash, protrusions, or gate burrs shall not exceed 0.15 mm, per side.
4. This dimension does not include interlead flash. Interlead flash shall not exceed 0.25 mm, per side.
5. Reference JEDEC registration MS-013.

# EXAMPLE BOARD LAYOUT

DW0016A

SOIC - 2.65 mm max height

SOIC

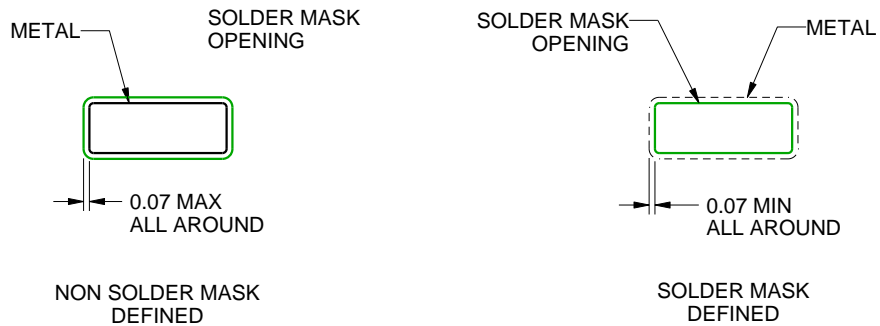

## SOLDER MASK DETAILS

4220721/A 07/2016

NOTES: (continued)

6. Publication IPC-7351 may have alternate designs.

7. Solder mask tolerances between and around signal pads can vary based on board fabrication site.

# EXAMPLE STENCIL DESIGN

DW0016A

SOIC - 2.65 mm max height

SOIC



SOLDER PASTE EXAMPLE  
BASED ON 0.125 mm THICK STENCIL  
SCALE:7X

4220721/A 07/2016

NOTES: (continued)

8. Laser cutting apertures with trapezoidal walls and rounded corners may offer better paste release. IPC-7525 may have alternate design recommendations.
9. Board assembly site may have different recommendations for stencil design.

## GENERIC PACKAGE VIEW

**FK 20**

**LCCC - 2.03 mm max height**

8.89 x 8.89, 1.27 mm pitch

LEADLESS CERAMIC CHIP CARRIER

This image is a representation of the package family, actual package may vary.  
Refer to the product data sheet for package details.



4229370VA\

J 14

**GENERIC PACKAGE VIEW**  
**CDIP - 5.08 mm max height**  
CERAMIC DUAL IN LINE PACKAGE



Images above are just a representation of the package family, actual package may vary.  
Refer to the product data sheet for package details.

4040083-5/G

J0014A



# PACKAGE OUTLINE

CDIP - 5.08 mm max height

CERAMIC DUAL IN LINE PACKAGE



4214771/A 05/2017

**NOTES:**

1. All controlling linear dimensions are in inches. Dimensions in brackets are in millimeters. Any dimension in brackets or parenthesis are for reference only. Dimensioning and tolerancing per ASME Y14.5M.
2. This drawing is subject to change without notice.
3. This package is hermetically sealed with a ceramic lid using glass frit.
4. Index point is provided on cap for terminal identification only and on press ceramic glass frit seal only.
5. Falls within MIL-STD-1835 and GDIP1-T14.



# EXAMPLE BOARD LAYOUT

J0014A

CDIP - 5.08 mm max height

CERAMIC DUAL IN LINE PACKAGE



LAND PATTERN EXAMPLE  
NON-SOLDER MASK DEFINED  
SCALE: 5X



4214771/A 05/2017



D0008A

# PACKAGE OUTLINE

SOIC - 1.75 mm max height

SMALL OUTLINE INTEGRATED CIRCUIT



4214825/C 02/2019

### NOTES:

1. Linear dimensions are in inches [millimeters]. Dimensions in parenthesis are for reference only. Controlling dimensions are in inches. Dimensioning and tolerancing per ASME Y14.5M.
2. This drawing is subject to change without notice.
3. This dimension does not include mold flash, protrusions, or gate burrs. Mold flash, protrusions, or gate burrs shall not exceed  $.006$  [0.15] per side.
4. This dimension does not include interlead flash.
5. Reference JEDEC registration MS-012, variation AA.

# EXAMPLE BOARD LAYOUT

D0008A

SOIC - 1.75 mm max height

SMALL OUTLINE INTEGRATED CIRCUIT



LAND PATTERN EXAMPLE  
 EXPOSED METAL SHOWN  
 SCALE:8X



SOLDER MASK DETAILS

4214825/C 02/2019

NOTES: (continued)

- 6. Publication IPC-7351 may have alternate designs.
- 7. Solder mask tolerances between and around signal pads can vary based on board fabrication site.

# EXAMPLE STENCIL DESIGN

D0008A

SOIC - 1.75 mm max height

SMALL OUTLINE INTEGRATED CIRCUIT



SOLDER PASTE EXAMPLE  
BASED ON .005 INCH [0.125 MM] THICK STENCIL  
SCALE:8X

4214825/C 02/2019

NOTES: (continued)

8. Laser cutting apertures with trapezoidal walls and rounded corners may offer better paste release. IPC-7525 may have alternate design recommendations.
9. Board assembly site may have different recommendations for stencil design.

P (R-PDIP-T8)

PLASTIC DUAL-IN-LINE PACKAGE



- NOTES:
- A. All linear dimensions are in inches (millimeters).
  - B. This drawing is subject to change without notice.
  - C. Falls within JEDEC MS-001 variation BA.

N (R-PDIP-T\*\*)

PLASTIC DUAL-IN-LINE PACKAGE

16 PINS SHOWN



- NOTES:
- A. All linear dimensions are in inches (millimeters).
  - B. This drawing is subject to change without notice.
  - Falls within JEDEC MS-001, except 18 and 20 pin minimum body length (Dim A).
  - The 20 pin end lead shoulder width is a vendor option, either half or full width.

## 重要通知和免责声明

TI“按原样”提供技术和可靠性数据（包括数据表）、设计资源（包括参考设计）、应用或其他设计建议、网络工具、安全信息和其他资源，不保证没有瑕疵且不做任何明示或暗示的担保，包括但不限于对适销性、与某特定用途的适用性或不侵犯任何第三方知识产权的暗示担保。

这些资源可供使用 TI 产品进行设计的熟练开发人员使用。您将自行承担以下全部责任：(1) 针对您的应用选择合适的 TI 产品，(2) 设计、验证并测试您的应用，(3) 确保您的应用满足相应标准以及任何其他安全、安保法规或其他要求。

这些资源如有变更，恕不另行通知。TI 授权您仅可将这些资源用于研发本资源所述的 TI 产品的相关应用。严禁以其他方式对这些资源进行复制或展示。您无权使用任何其他 TI 知识产权或任何第三方知识产权。对于因您对这些资源的使用而对 TI 及其代表造成的任何索赔、损害、成本、损失和债务，您将全额赔偿，TI 对此概不负责。

TI 提供的产品受 [TI 销售条款](#)、[TI 通用质量指南](#) 或 [ti.com](#) 上其他适用条款或 TI 产品随附的其他适用条款的约束。TI 提供这些资源并不会扩展或以其他方式更改 TI 针对 TI 产品发布的适用的担保或担保免责声明。除非德州仪器 (TI) 明确将某产品指定为定制产品或客户特定产品，否则其产品均为按确定价格收入目录的标准通用器件。

TI 反对并拒绝您可能提出的任何其他或不同的条款。

版权所有 © 2026，德州仪器 (TI) 公司

最后更新日期：2025 年 10 月