

采用空间增强型塑料的 TPS7H1210-SEP -16.5-V、1A 负线性稳压器

1 特性

- 提供供应商项目图，VID V62/21616
- 电离辐射总剂量 (TID) 为 30krad(Si)
 - 每个晶圆批次的 TID RLAT (辐射批次验收测试) : 20krad (Si)
- 确定了单粒子效应 (SEE)
 - 单粒子锁定 (SEL)、单粒子烧毁 (SEB) 和单粒子栅穿 (SEGR) 对于线性能量传递 (LET) 的抗扰度 = 43MeV-cm²/mg
 - 单粒子功能中断 (SEFI) 和单粒子瞬变 (SET) 对于 LET 的额定值 = 43MeV-cm²/mg
- 低噪声: 13.7 μ V_{RMS} 典型值 (10Hz 至 100kHz)
- 高电源抑制比, PSRR ($V_{IN} = -6V$ 、 $V_{OUT} = -5V$ 、 $I_{OUT} = 1A$ 下的典型值) :
 - 100Hz 时为 61dB
 - 100 kHz 时为 61dB
 - 1 MHz 时为 41dB
- 输入电压范围: -3 V 至 -16.5 V
- 可调输出: -1.2 V 至 -15.5 V
- 输出电流高达 1A
- 与电容值 $\geq 10 \mu F$ 的陶瓷电容一起工作时保持稳定
- 内置电流限制和热关断保护
- 增强型航天塑料 (SEP)
 - 受控基线
 - 金键合线
 - NiPdAu 铅涂层
 - 一个组装和测试基地
 - 一个制造基地
 - 军用级 (-55°C 到 125°C) 温度范围
 - 延长了产品生命周期
 - 延长了产品变更通知 (PCN)
 - 产品可追溯性
 - 采用增强型模塑化合物实现低释气

2 应用

- 支持近地轨道 (LEO) 航天应用
- 卫星电力系统 (EPS)
- 模拟电路电源
 - 数据转换器: ADC 和 DAC (模数转换器和数模转换器)
 - 运算放大器
 - 图像传感器
- 后置直流/直流转换器稳压和纹波滤除
- 用于空间受限区域的耐辐射超洁净模拟电源

3 说明

TPS7H1210-SEP 是一款低噪音、高 PSRR 负电压线性稳压器，可提供最大 1A 的负载。

该稳压器装有一个 CMOS 逻辑电平兼容使能引脚 (EN)，此引脚允许用户定制电源管理方案。其他特性包括内置电流值限制和热关断以在故障情况下保护此器件和系统。

由于在设计中主要使用双极技术，TPS7H1210-SEP 器件适合于高准确度、低噪声应用，在此类应用中，为了获得更高的系统性能，清洁的电压轨很关键。因此，它非常适合为运算放大器、ADC、DAC 和其他高性能模拟电路供电。

此外，TPS7H1210-SEP 器件适用于后置直流/直流转换器稳压。通过滤除直流/直流开关转换所固有的输出电压纹波，可确保在敏感器件和射频应用中尽可能提高系统性能。

器件信息

器件型号 ⁽¹⁾	等级	封装 ⁽²⁾
TPS7H1210MRGWSEP	特征值为 20krad(Si) RLAT、30krad(Si)	VQFN (20) 5.00mm × 5.00mm 质量 = 83.6mg
TPS7H1210EVM	评估板	EVM

(1) 如需了解所有可用封装，请参阅数据表末尾的可订购产品附录。

(2) 尺寸和质量为标称值。

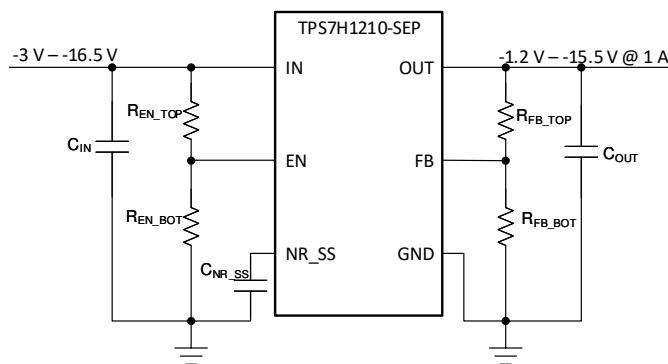

典型应用原理图



Table of Contents

1 特性	1	8.1 Application Information.....	15
2 应用	1	8.2 Typical Application.....	18
3 说明	1	8.3 Do's and Don' ts.....	19
4 Revision History	2	9 Power Supply Recommendations	20
5 Pin Configuration and Functions	3	10 Layout	20
6 Specifications	4	10.1 Layout Guidelines.....	20
6.1 Absolute Maximum Ratings.....	4	10.2 Layout Example.....	21
6.2 ESD Ratings.....	4	10.3 Thermal Performance.....	21
6.3 Recommended Operating Conditions.....	5	11 Device and Documentation Support	22
6.4 Thermal Information.....	5	11.1 Device Support.....	22
6.5 Electrical Characteristics.....	6	11.2 Documentation Support.....	22
6.6 Typical Characteristics.....	7	11.3 接收文档更新通知.....	22
7 Detailed Description	12	11.4 支持资源.....	22
7.1 Overview.....	12	11.5 Trademarks.....	22
7.2 Functional Block Diagram.....	12	11.6 Electrostatic Discharge Caution.....	22
7.3 Feature Description.....	12	11.7 术语表.....	22
7.4 Device Functional Modes.....	14	12 Mechanical, Packaging, and Orderable Information	22
8 Application and Implementation	15		

4 Revision History

注：以前版本的页码可能与当前版本的页码不同

DATE	REVISION	NOTES
November 2021	*	Initial Release

5 Pin Configuration and Functions



图 5-1. RGW Package, 20-Pin VQFN (Top View)

表 5-1. Pin Functions

PIN		I/O ⁽¹⁾	DESCRIPTION
NAME	NO.		
EN	13	I	Enable. This dual-polarity pin turns the regulator on when $ V_{EN} \geq 2$ V. The EN pin can be connected to IN if not used. If V_{EN} is negative polarity, then keep $ V_{EN} \leq V_{IN} $.
FB	3	I	Feedback. This pin is the input to the control-loop error amplifier. It is used to set the output voltage of the device and is normally equal to V_{REF} (– 1.182 V, typical) during operation.
GND	7	—	Ground.
IN	15, 16	I	Input supply. It is recommended to connect a 10- μ F capacitor from IN to GND (as close to the device as possible).
NC	2, 4 – 6, 8 – 12, 17 – 19	—	No connect. This pin is not internally connected. It is recommended to connect these pins to GND to prevent charge buildup; however, these pins can also be left open or tied to any voltage between GND and V_{IN} .
NR_SS	14	—	Noise reduction and soft start. A capacitor connected from this pin to GND controls the soft-start function and allows RMS noise to be reduced to very low levels. TI recommends connecting a 100-nF capacitor from NR_SS to GND (as close to the device as possible) to filter the noise generated by the internal band gap and maximize AC performance.
OUT	1, 20	O	Output of the regulator. A capacitor greater than or equal to 10 μ F must be tied from this pin to ground to ensure stability. TI recommends connecting a 47- μ F ceramic capacitor from OUT to GND (as close to the device as possible) to maximize AC performance.
Thermal Pad	—	—	Connect the thermal pad to a large-area ground plane. The thermal pad is not internally grounded and it must be externally tied to GND for proper operation.

(1) I = Input, O = Output, — = Other

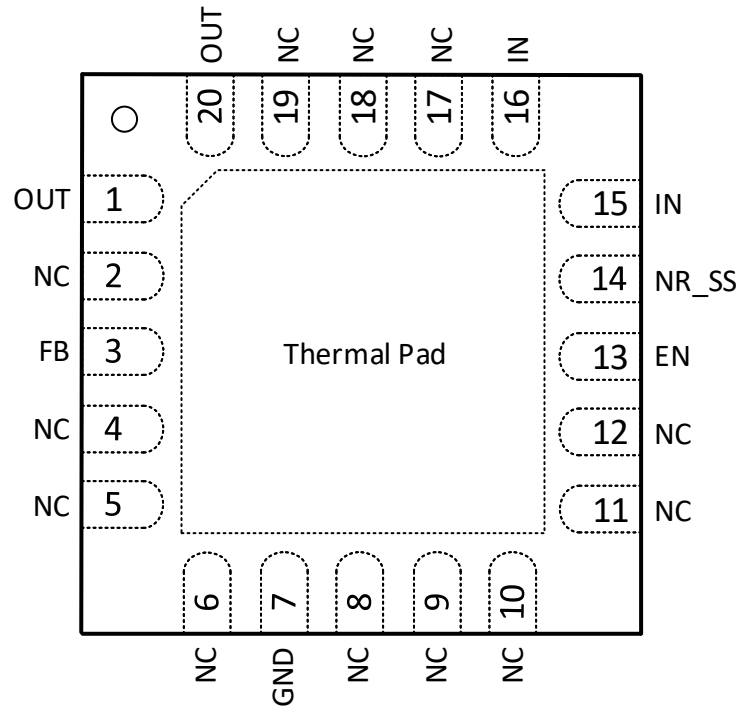
6 Specifications

6.1 Absolute Maximum Ratings

over operating free-air temperature range (unless otherwise noted)⁽¹⁾

		MIN	MAX	UNIT
Input voltage	IN to GND	- 35	0.3	V
	FB to GND	- 2	0.3	V
	FB to IN	- 0.3	35	V
	EN to GND	- 35	10	V
	NR_SS to IN	- 0.3	35	V
	NR_SS to GND	- 2	0.3	V
Output voltage	OUT to GND	- 33	0.3	V
	OUT to IN	- 0.3	35	V
Output current	Peak output	Internally limited		
Operating virtual junction temperature	T _J	- 55	150	°C
Storage temperature	T _{stg}	- 65	150	°C

- (1) Operation outside the Absolute Maximum Ratings may cause permanent device damage. Absolute Maximum Ratings do not imply functional operation of the device at these or any other conditions beyond those listed under Recommended Operating Conditions. If used outside the Recommended Operating Conditions but within the Absolute Maximum Ratings, the device may not be fully functional, and this may affect device reliability, functionality, performance, and shorten the device lifetime.

6.2 ESD Ratings

			VALUE	UNIT
V _(ESD)	Electrostatic discharge	Human body model (HBM), per ANSI/ESDA/JEDEC JS-001, all pins ⁽¹⁾	±1000	V
		Charged device model (CDM), per JEDEC specification JESD22-C101, all pins ⁽²⁾	±500	

- (1) JEDEC document JEP155 states that 500-V HBM allows safe manufacturing with a standard ESD control process.
 (2) JEDEC document JEP157 states that 250-V CDM allows safe manufacturing with a standard ESD control process.

6.3 Recommended Operating Conditions

over operating free-air temperature range (unless otherwise noted)

		MIN	NOM	MAX	UNIT
Input voltage	IN	- 16.5		- 3	V
	EN	V_{IN}		10	
Output voltage	OUT ⁽¹⁾	- 15.5		V_{REF}	V
Output current	OUT ⁽²⁾	0		1	A
R_{FB_BOT} ⁽³⁾	R_{FB_BOT} is the lower feedback resistor			240	k Ω
Input capacitance	C_{IN}	10			μ F
Output capacitance	C_{OUT}	10	47		μ F
C_{NR_SS}	Noise reduction and soft start capacitor		100		nF
Operating junction temperature	T_J	- 55		125	$^{\circ}$ C

- (1) The minimum dropout voltage must also be met.
 (2) To ensure stability at no load conditions, a current from the feedback resistive network greater than or equal to 5 μ A is required.
 (3) This condition helps ensure stability at no load.

6.4 Thermal Information

THERMAL METRIC ⁽¹⁾		TPS7H1210-SEP	UNIT
		RQW (VQFN)	
		20 PINS	
$R_{\theta JA}$	Junction-to-ambient thermal resistance	32.7	$^{\circ}$ C/W
$R_{\theta JC(top)}$	Junction-to-case (top) thermal resistance	24	$^{\circ}$ C/W
$R_{\theta JB}$	Junction-to-board thermal resistance	11.8	$^{\circ}$ C/W
Ψ_{JT}	Junction-to-top characterization parameter	0.3	$^{\circ}$ C/W
Ψ_{JB}	Junction-to-board characterization parameter	11.7	$^{\circ}$ C/W
$R_{\theta JC(bot)}$	Junction-to-case (bottom) thermal resistance	3.6	$^{\circ}$ C/W

- (1) For more information about traditional and new thermal metrics, see the [Semiconductor and IC Package Thermal Metrics](#) application report.

6.5 Electrical Characteristics

Over $|V_{IN}| = 3\text{ V}$, $I_{OUT} = 1\text{ mA}$, $C_{IN} = 20\text{ }\mu\text{F}$, $C_{OUT} = 20\text{ }\mu\text{F}$, $C_{NR_SS} = 0\text{ nF}$, FB tied to OUT, EN tied to IN, over operating temperature range ($T_J = -55^\circ\text{C}$ to 125°C), unless otherwise noted.⁽¹⁾

PARAMETER		TEST CONDITIONS	MIN	TYP	MAX	UNIT
POWER SUPPLIES AND CURRENTS						
V_{UVLO}	Undervoltage lockout threshold			-2		V
$ V_{DO} $	Dropout voltage	$V_{IN} = -4.6\text{ V}$, $V_{OUT(\text{set})} = -5\text{ V}$, $ V_{DO} = V_{IN} - V_{OUT(\text{measured})} $, $C_{IN} = 30\text{ }\mu\text{F}$	$I_{OUT} = 0.5\text{ A}$	224	325	mV
			$I_{OUT} = 1\text{ A}$	363	500	
			$I_{OUT} = 1\text{ A}$, $T_J = 25^\circ\text{C}$	363	450	
I_{CL}	Current limit	$V_{IN} = -6\text{ V}$, $V_{OUT(\text{SET})} = -5\text{ V}$, $V_{OUT(\text{forced})} = -4.5\text{ V}$		2.9		A
I_Q	Quiescent current	$V_{EN} = 3\text{ V}$, $I_{OUT} = 0\text{ A}$		210	350	μA
I_{GND}	Ground current ⁽²⁾	$V_{EN} = 3\text{ V}$, $I_{OUT} = 0.5\text{ A}$		5	10	mA
$ I_{SHDN} $	Shutdown current	$V_{EN} = 0.4\text{ V}$		1	3	μA
		$V_{EN} = -0.4\text{ V}$		1	3	
$I_{FB(\text{LKG})}$	Feedback leakage current ⁽³⁾			14	75	nA
ACCURACY						
V_{REF}	Reference voltage	$V_{FB} = V_{REF}$	1.199	1.182	1.164	V
V_{ACC}	Output voltage accuracy	$ V_{IN} = 3\text{ V}$, $1\text{ mA} \leq I_{OUT} \leq 1\text{ A}$	-2%	$\pm 1\%$	2%	
		$ V_{IN} = 16.5\text{ V}$, $1\text{ mA} \leq I_{OUT} \leq 100\text{ mA}$	-2%	$\pm 1\%$	2%	
		$ V_{IN} = 16.5\text{ V}$, $ V_{OUT} = 15.5\text{ V}$, $I_{OUT} = 1\text{ A}$	-2%	$\pm 1\%$	2%	
$\Delta V_{OUT} / \Delta V_{IN}$	Line regulation	$3\text{ V} \leq V_{IN} \leq 16.5\text{ V}$		-0.007%		V_{OUT}/V
$\Delta V_{OUT} / \Delta I_{OUT}$	Load regulation	$1\text{ mA} \leq I_{OUT} \leq 1\text{ A}$		-0.5%		V_{OUT}/A
ENABLE						
$V_{EN(+HI)}$	Enable turn-on (positive logic)		2		10	V
$V_{EN(-HI)}$	Enable turn-on (negative logic)	$V_{IN} = -16.5\text{ V}$	V_{IN}		-2	
$V_{EN(+LO)}$	Enable turn-off (positive logic)		0		0.4	
$V_{EN(-LO)}$	Enable turn-off (negative logic)		-0.4		0	
$ I_{EN} $	Enable current	$V_{IN} = V_{EN} = -3\text{ V}$		0.48	1	μA
		$V_{IN} = V_{EN} = -16.5\text{ V}$		0.51	1	
		$V_{IN} = -16.5\text{ V}$, $V_{EN} = 10\text{ V}$		0.5	1	
$T_{SD(\text{enter})}$	Thermal shutdown enter temperature			178		$^\circ\text{C}$
$T_{SD(\text{exit})}$	Thermal shutdown exit temperature			152		
NOISE AND PSRR						
PSRR	Power-supply rejection ratio	$V_{IN} = -6\text{ V}$, $V_{OUT} = -5\text{ V}$, $C_{OUT} = 50.11\text{ }\mu\text{F}$, $I_{OUT} = 1\text{ A}$, $C_{NR_SS} = 100\text{ nF}$ ⁽⁴⁾	$f = 100\text{ Hz}$		61	dB
			$f = 100\text{ kHz}$		61	
			$f = 1\text{ MHz}$		41	
V_N	Output noise rms voltage (bandwidth from 10 Hz to 100 kHz)	$V_{IN} = -3\text{ V}$, $V_{OUT(\text{nom})} = V_{REF}$, $C_{IN} = 11.1\text{ }\mu\text{F}$, $C_{OUT} = 50.11\text{ }\mu\text{F}$, $C_{NR_SS} = 100\text{ nF}$, $I_{OUT} = 1\text{ A}$		13.7		μV_{RMS}

- (1) At operating conditions, $V_{IN} \leq 0\text{ V}$, $V_{OUT(\text{nom})} \leq V_{REF} \leq 0\text{ V}$; at regulation, $V_{IN} \leq V_{OUT(\text{nom})} - |V_{DO}|$; $I_{OUT} > 0$ flows from OUT to IN.
- (2) $I_{GND} = I_{IN} - I_{OUT}$
- (3) $I_{FB} > 0$ flows into the device.
- (4) C_{IN} is removed as part of PSRR testing. During normal operation, follow the recommended operating condition of $C_{IN} \geq 10\text{ }\mu\text{F}$.

6.6 Typical Characteristics

Over $|V_{IN}| = 3\text{ V}$, $I_{OUT} = 1\text{ mA}$, $C_{IN} = 20\text{ }\mu\text{F}$, $C_{OUT} = 20\text{ }\mu\text{F}$, $C_{NR_SS} = 0\text{ nF}$, FB tied to OUT, EN tied to IN, $T_A = 25^\circ\text{C}$, unless otherwise noted.



图 6-1. Reference Voltage vs Input Voltage Across Temperature



$I_{FB} > 0$ flows into the device

图 6-2. Feedback Leakage Current vs Temperature Across Input Voltage

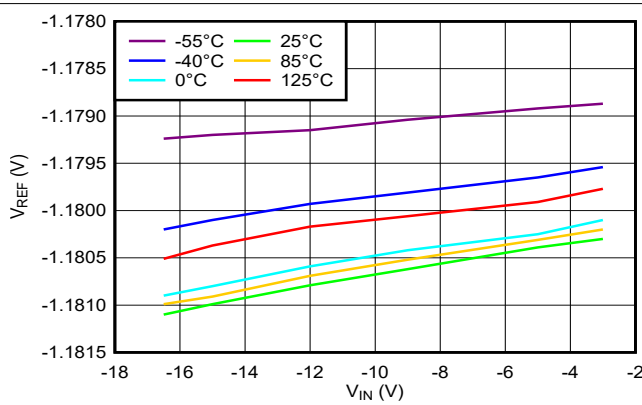
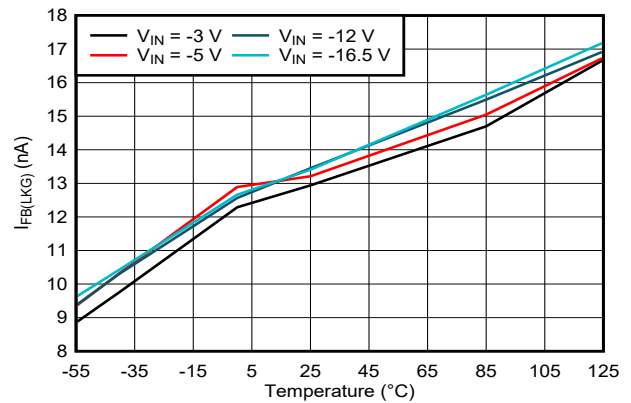

图 6-3. Ground Current vs Input Voltage Across Output Current



$I_{OUT} = 500\text{ mA}$

图 6-4. Ground Current vs Input Voltage Across Temperature

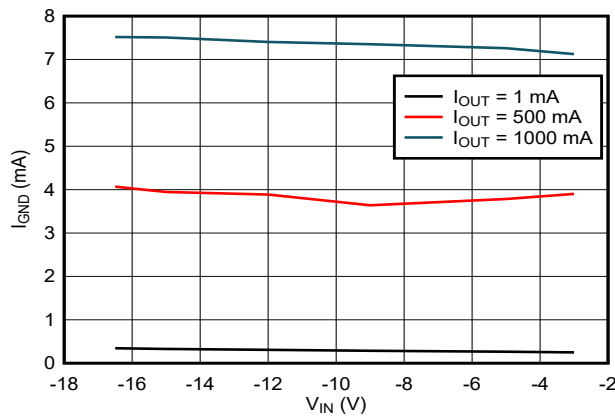
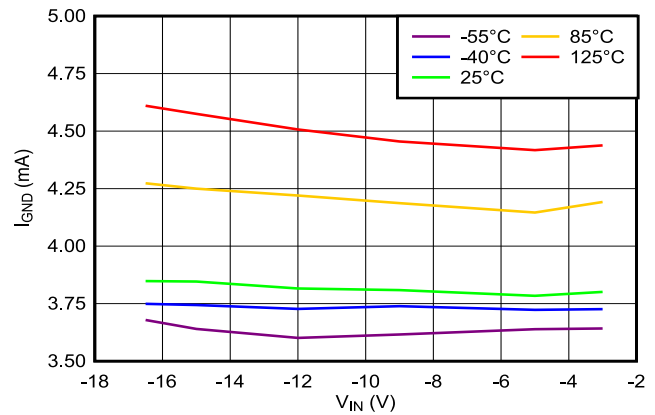

图 6-5. Ground Current vs Output Current Across Temperature



图 6-6. Enable Current vs Enable Voltage Across Temperature

6.6 Typical Characteristics (continued)

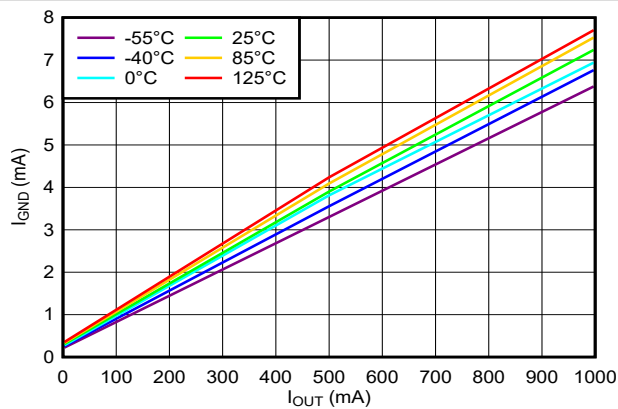
Over $|V_{IN}| = 3\text{ V}$, $I_{OUT} = 1\text{ mA}$, $C_{IN} = 20\text{ }\mu\text{F}$, $C_{OUT} = 20\text{ }\mu\text{F}$, $C_{NR_SS} = 0\text{ nF}$, FB tied to OUT, EN tied to IN, $T_A = 25^\circ\text{C}$, unless otherwise noted.

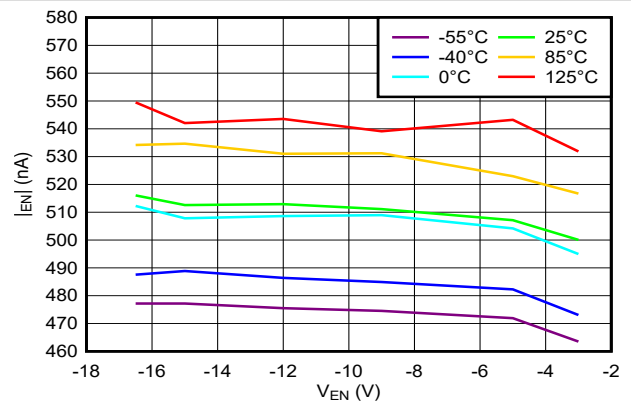
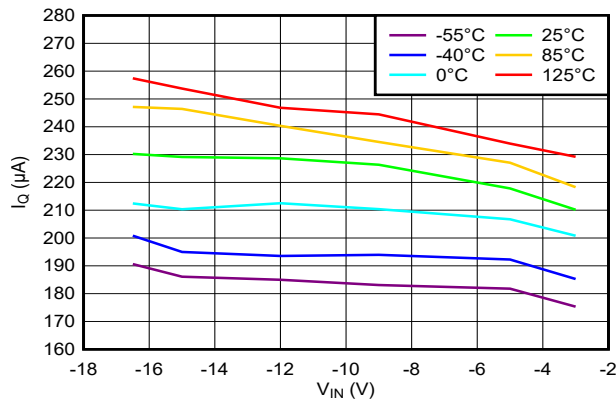

$I_{OUT} = 0\text{ mA}$

图 6-7. Quiescent Current vs Input Voltage Across Temperature

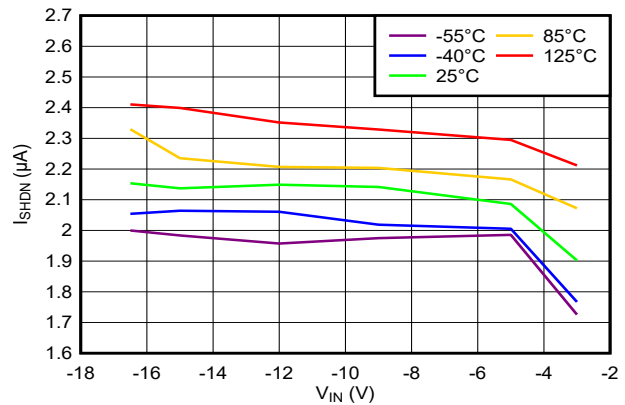

$V_{EN} = 0.4\text{ V}$

图 6-8. Shutdown Current vs Input Voltage Across Temperature

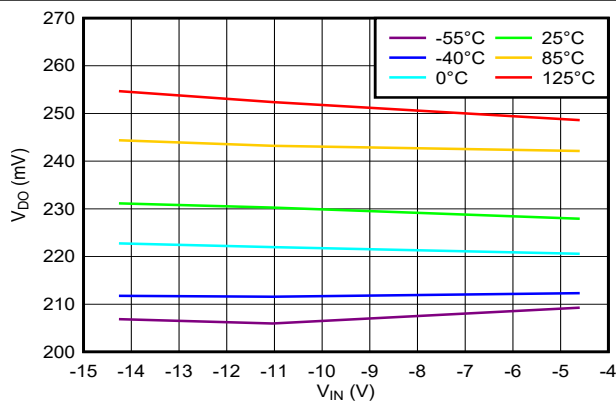

$I_{OUT} = 500\text{ mA}$ $C_{IN} = 30\text{ }\mu\text{F}$

图 6-9. Dropout Voltage vs Input Voltage Across Temperature

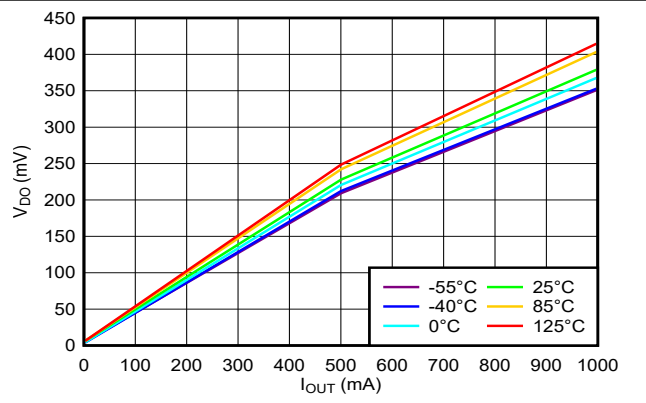

$V_{IN} = -4.6\text{ V}$ $V_{OUT(SET)} = -5\text{ V}$ $C_{IN} = 30\text{ }\mu\text{F}$

图 6-10. Dropout Voltage vs Output Current Across Temperature

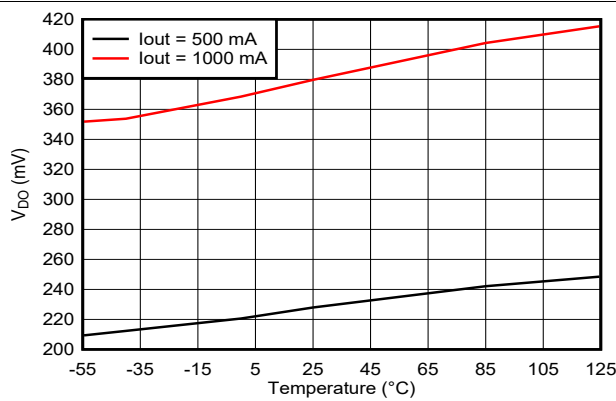

$V_{IN} = -4.6\text{ V}$ $V_{OUT(SET)} = -5\text{ V}$ $C_{IN} = 30\text{ }\mu\text{F}$

图 6-11. Dropout Voltage vs Temperature Across Output Current



图 6-12. Enable Threshold Voltage vs Temperature

6.6 Typical Characteristics (continued)

Over $|V_{IN}| = 3\text{ V}$, $I_{OUT} = 1\text{ mA}$, $C_{IN} = 20\text{ }\mu\text{F}$, $C_{OUT} = 20\text{ }\mu\text{F}$, $C_{NR_SS} = 0\text{ nF}$, FB tied to OUT, EN tied to IN, $T_A = 25^\circ\text{C}$, unless otherwise noted.

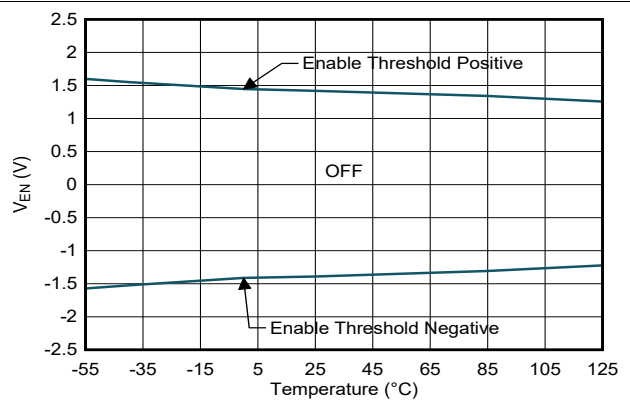
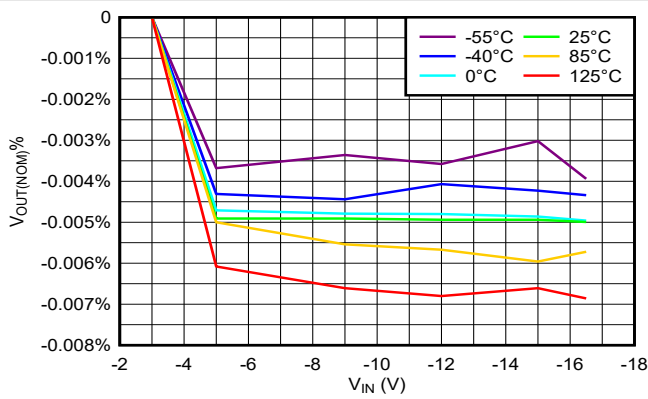

Each individual curve is normalized to 0% at $V_{IN} = -3\text{ V}$

图 6-13. Line Regulation vs Input Voltage Across Temperature

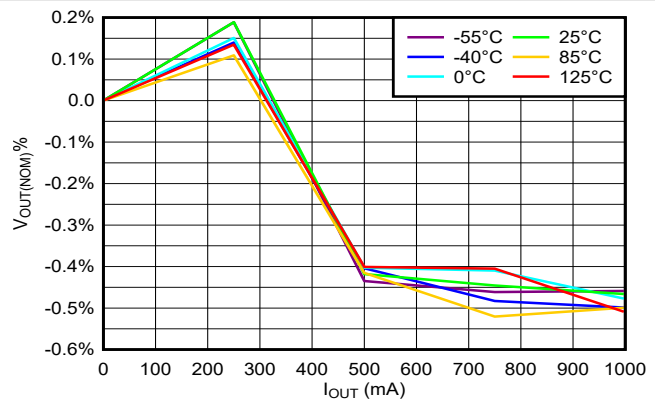

Each individual curve is normalized to 0% at $I_{OUT} = 0\text{ mA}$

图 6-14. Load Regulation vs Output Current Across Temperature

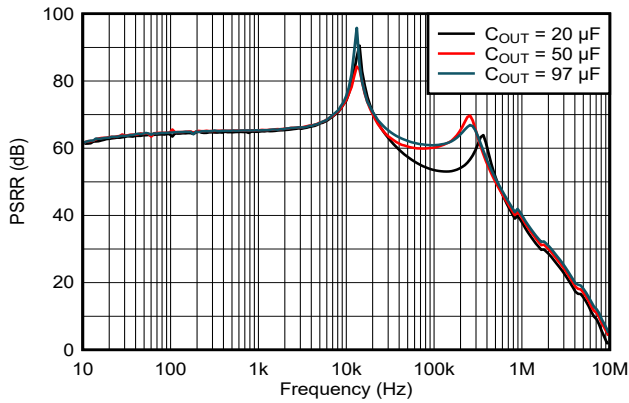

$C_{NR_SS} = 100\text{ nF}$ $I_{OUT} = 1\text{ A}$ $C_{IN} = 0\text{ }\mu\text{F(A)}$
All curves have 100-nF and 10-nF capacitor on V_{OUT}

图 6-15. Power-Supply Rejection Ratio vs Frequency Across C_{OUT}

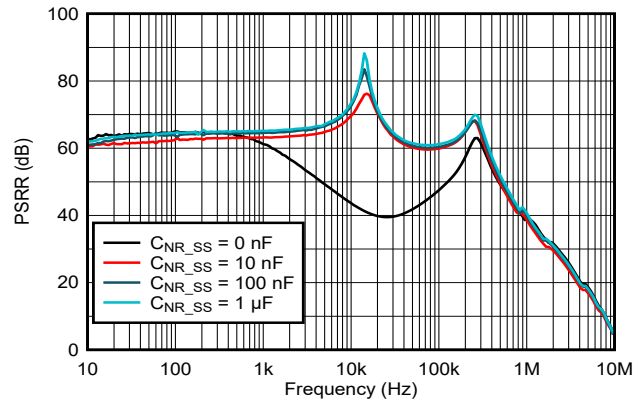

$C_{OUT} = 50.11\text{ }\mu\text{F}$ $I_{OUT} = 1\text{ A}$ $C_{IN} = 0\text{ }\mu\text{F(A)}$

图 6-16. Power-Supply Rejection Ratio vs Frequency Across C_{NR_SS}

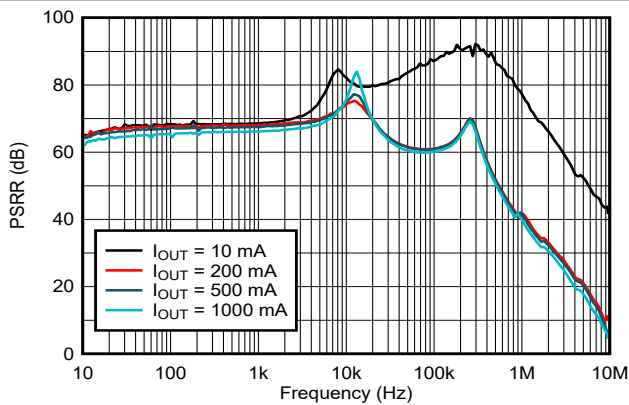

$C_{OUT} = 50.11\text{ }\mu\text{F}$ $C_{NR_SS} = 100\text{ nF}$ $C_{IN} = 0\text{ }\mu\text{F(A)}$

图 6-17. Power-Supply Rejection Ratio vs Frequency Across Output Current

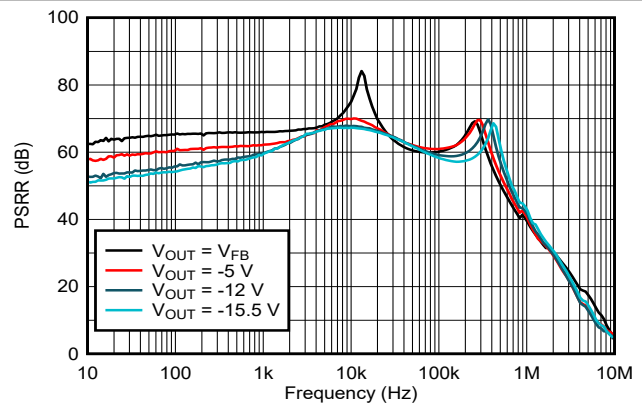

$C_{OUT} = 50.11\text{ }\mu\text{F}$ $C_{NR_SS} = 100\text{ nF}$ $C_{IN} = 0\text{ }\mu\text{F(A)}$
 $I_{OUT} = 1\text{ A}$ $|V_{IN}| = |V_{OUT} + 1\text{ V}|$, 3-V minimum

图 6-18. Power-Supply Rejection Ratio vs Frequency Across Output Voltage

6.6 Typical Characteristics (continued)

Over $|V_{IN}| = 3\text{ V}$, $I_{OUT} = 1\text{ mA}$, $C_{IN} = 20\text{ }\mu\text{F}$, $C_{OUT} = 20\text{ }\mu\text{F}$, $C_{NR_SS} = 0\text{ nF}$, FB tied to OUT, EN tied to IN, $T_A = 25^\circ\text{C}$, unless otherwise noted.

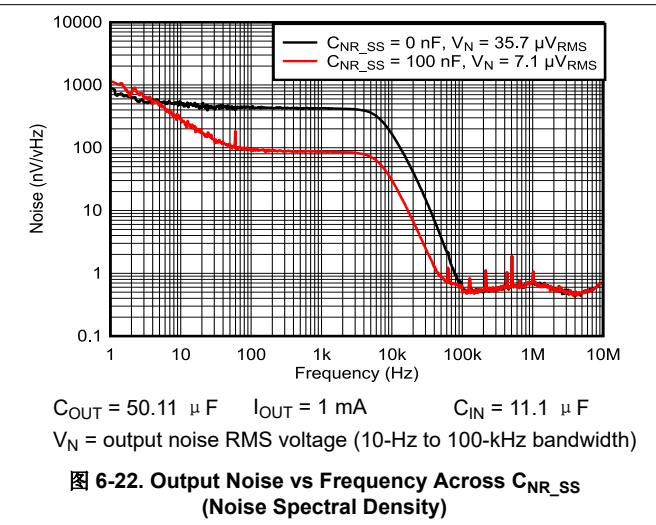
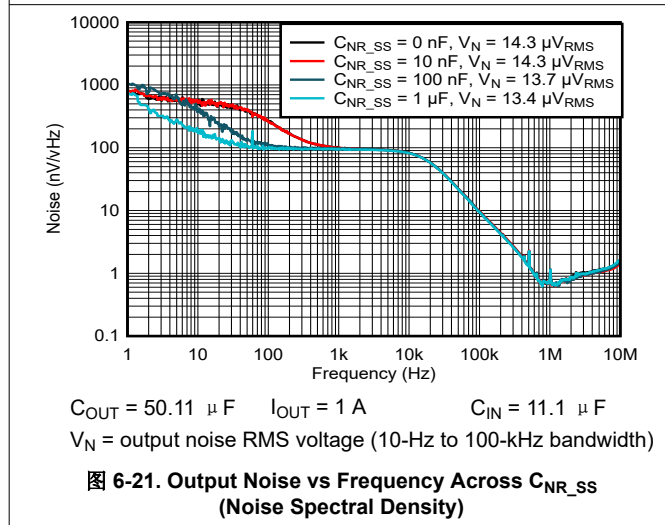
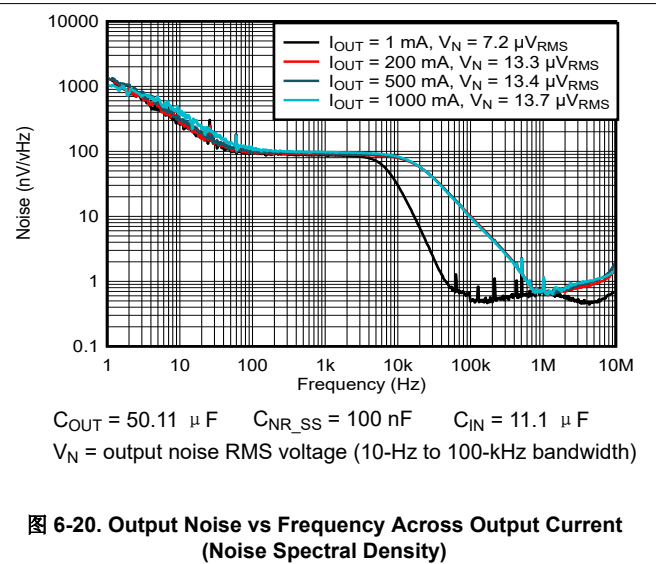
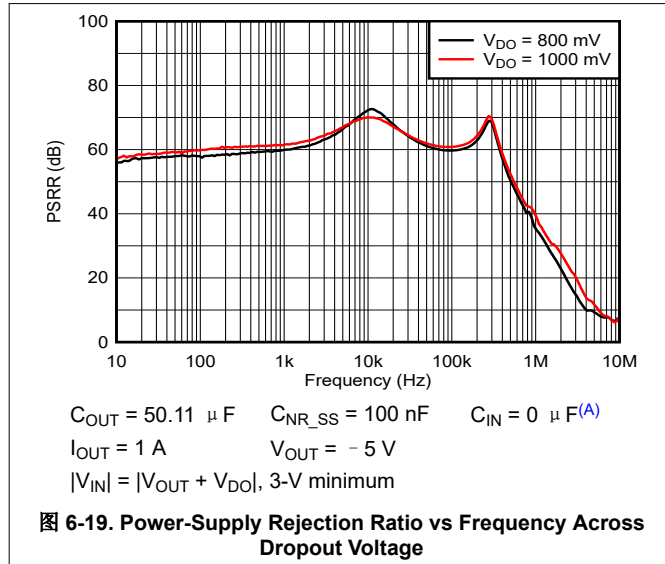

6.6 Typical Characteristics (continued)

Over $|V_{IN}| = 3\text{ V}$, $I_{OUT} = 1\text{ mA}$, $C_{IN} = 20\text{ }\mu\text{F}$, $C_{OUT} = 20\text{ }\mu\text{F}$, $C_{NR_SS} = 0\text{ nF}$, FB tied to OUT, EN tied to IN, $T_A = 25^\circ\text{C}$, unless otherwise noted.

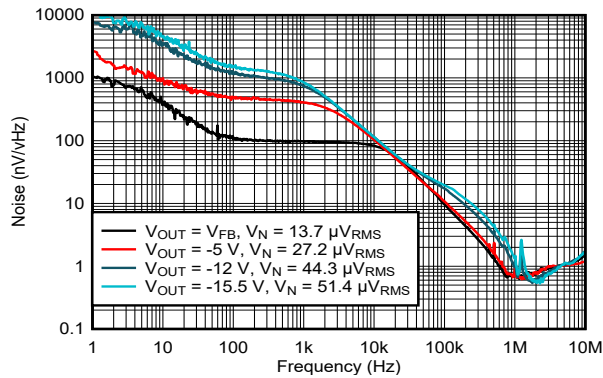

$C_{OUT} = 50.11\text{ }\mu\text{F}$ $I_{OUT} = 1\text{ A}$ $C_{IN} = 11.1\text{ }\mu\text{F}$
 $|V_{IN}| = |V_{OUT} + V_{DOL}|$, 3-V minimum
 V_N = output noise RMS voltage (10-Hz to 100-kHz bandwidth)

图 6-23. Output Noise vs Frequency Across Output Voltage (Noise Spectral Density)

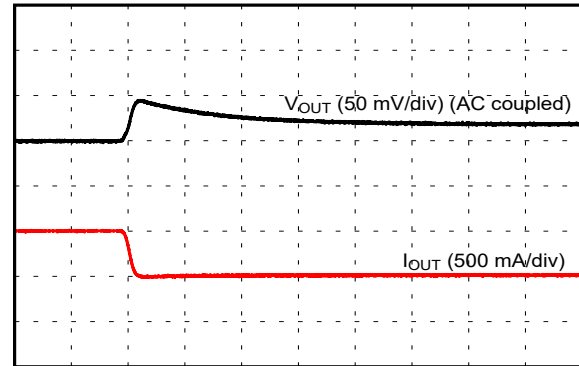

Time (100 $\mu\text{s/div}$)

$V_{IN} = -15\text{ V}$ $V_{OUT} = -12\text{ V}$ $I_{OUT(\text{slew})} = 1\text{ A} / 10\text{ }\mu\text{s}$
 $C_{IN} = 11.1\text{ }\mu\text{F}$ $C_{OUT} = 50\text{ }\mu\text{F}$ $C_{NR_SS} = 100\text{ nF}$

图 6-24. Load Step: 1 mA to 500 mA

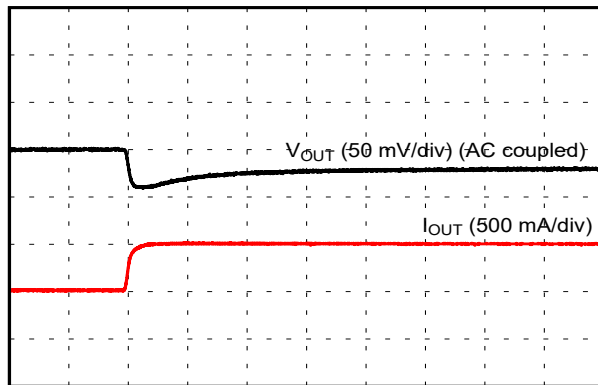

Time (100 $\mu\text{s/div}$)

$V_{IN} = -15\text{ V}$ $V_{OUT} = -12\text{ V}$ $I_{OUT(\text{slew})} = 1\text{ A} / 10\text{ }\mu\text{s}$
 $C_{IN} = 11.1\text{ }\mu\text{F}$ $C_{OUT} = 50\text{ }\mu\text{F}$ $C_{NR_SS} = 100\text{ nF}$

图 6-25. Load Step: 500 mA to 1 mA

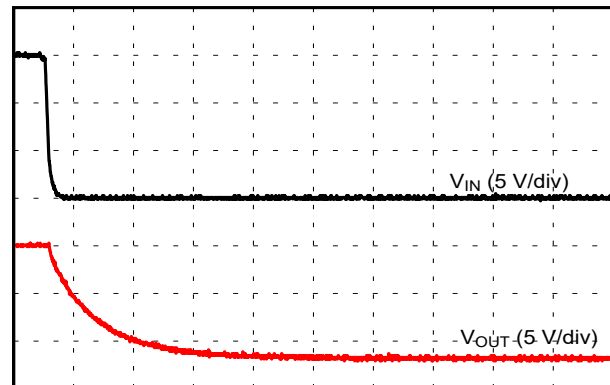

Time (50 ms/div)

$V_{IN(\text{SET})} = -15\text{ V}$ $V_{OUT(\text{SET})} = -12\text{ V}$ $C_{IN} = 11.1\text{ }\mu\text{F}$
 $C_{OUT} = 50\text{ }\mu\text{F}$ $C_{NR_SS} = 100\text{ nF}$

图 6-26. Start-up with Soft-Start

A. C_{IN} is removed as part of PSRR testing. During normal operation, follow the recommended operating condition of $C_{IN} \geq 10\text{ }\mu\text{F}$.

7 Detailed Description

7.1 Overview

The TPS7H1210-SEP negative voltage linear regulator uses a bipolar process to achieve very low noise and very high PSRR levels at a wide input voltage and current range. These features, plus its radiation tolerance, make this device ideal for high-performance analog applications in satellites.

7.2 Functional Block Diagram

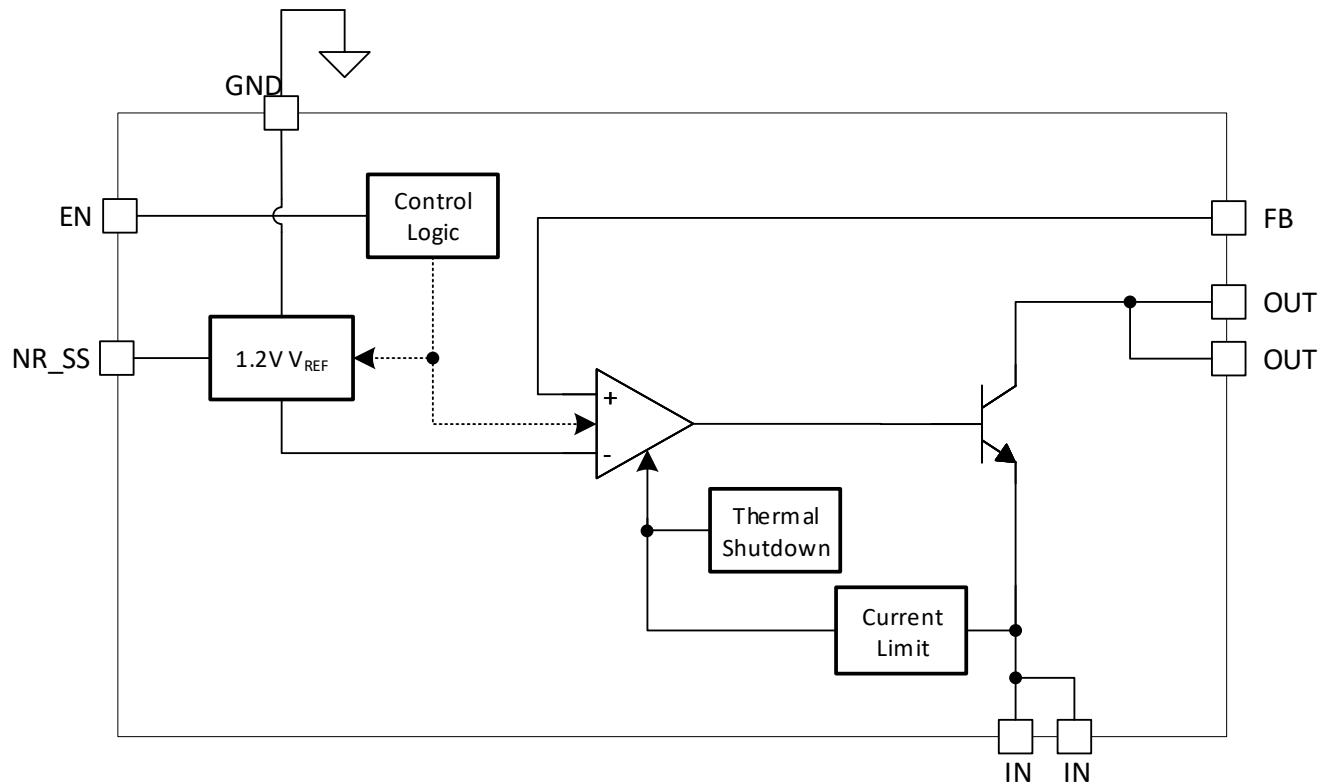

7.3 Feature Description

7.3.1 Internal Current Limit

The fixed internal current limit of the TPS7H1210-SEP device helps protect the regulator during fault conditions. The maximum amount of current the device can source is the current limit (2.9 A, typical), and it is largely independent of output voltage. For reliable operation, do not operate the device in current limit for extended periods of time.

7.3.2 Enable Pin Operation

The TPS7H1210-SEP provides a dual-polarity enable pin (EN) that turns on the regulator when $|V_{EN}| > 2\text{ V}$, whether the voltage is positive or negative, as shown in 图 7-1. Specifically, if $V_{EN} \geq V_{EN(+HI)}$ or $V_{EN} \leq V_{EN(-HI)}$, the regulator is enabled. If $V_{EN(+LO)} \geq V_{EN} \geq V_{EN(-LO)}$, the regulator is disabled.

This functionality allows for different system power management topologies; for example:

- Connecting the EN pin directly to a negative voltage, such as V_{IN} .
- Connecting the EN pin directly to a positive voltage, such as the output of digital logic circuitry.
- Connecting the EN pin to a resistor divider from V_{IN} to GND to turn-on at a specific input voltage level (programmable turn-on voltage).



图 7-1. Enable Pin Positive and Negative Threshold

7.3.3 Programmable Soft-Start

The NR_SS capacitor acts as a noise reduction capacitor and a soft-start capacitor to slow down the rise time of the output. The output rise time, when using an NR_SS capacitor, is approximated by 方程式 1.

$$t_{SS} \text{ (ms)} = 1.2 \times C_{NR_SS} \text{ (nF)} \quad (1)$$

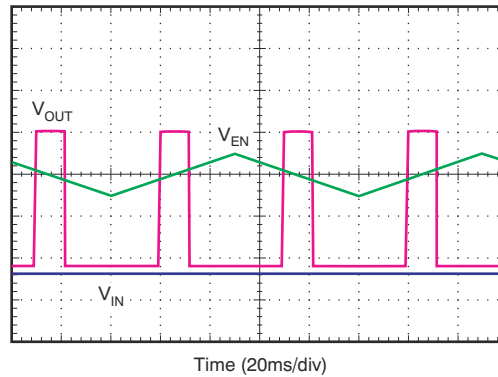
In 方程式 1, t_{SS} is the soft-start time in milliseconds and C_{NR_SS} is the capacitance at the NR_SS pin in nanofarads.

图 7-2 shows the start-up voltage waveforms versus C_{NR_SS} .



图 7-2. Start-Up Waveforms vs C_{NR_SS}

7.3.4 Thermal Protection

Thermal protection disables the output when the junction temperature rises to approximately 178°C, allowing the device to cool. When the junction temperature cools to approximately 152°C, the output circuitry is enabled. Depending on power dissipation, thermal resistance, and ambient temperature, the thermal protection circuit may cycle on and off. This cycling limits the dissipation of the regulator, mitigating damage as a result of overheating.

Any tendency to activate the thermal protection circuit indicates excessive power dissipation or an inadequate heat sink. For reliable operation, limit the junction temperature to a maximum of 125°C.

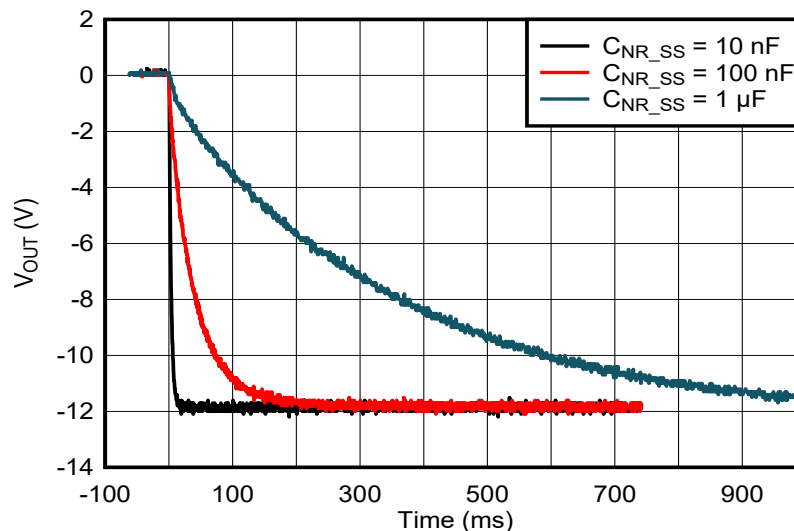
The internal protection circuitry of the TPS7H1210-SEP has been designed to protect against overload conditions. It was not intended to replace proper thermal management. Continuously running the TPS7H1210-SEP into thermal shutdown degrades device reliability.

7.4 Device Functional Modes

7.4.1 Normal Operation

The device regulates to the nominal output voltage under all of the following conditions:

- The input voltage magnitude has previously exceeded the UVLO rising voltage magnitude and has not decreased below the UVLO falling threshold magnitude.
- The input voltage magnitude is greater than the nominal output voltage magnitude added to the dropout voltage magnitude.
- $|V_{EN}| > |V_{(HI)}|$
- The output current is less than the current limit.
- The device junction temperature is less than the maximum specified recommended operating conditions junction temperature.

7.4.2 Dropout Operation

If the input voltage magnitude is lower than the magnitude of the nominal output voltage plus the specified dropout voltage, but all other conditions are met for normal operation, the device operates in dropout mode. In this condition, the output voltage is the same as the input voltage minus the dropout voltage. The transient performance of the device is significantly degraded because the pass device (as a bipolar junction transistor, or BJT) is in saturation and no longer controls the current through the LDO. Line or load transients in dropout can result in large output voltage deviations.

7.4.3 Disabled

The device is disabled under any of the following conditions:

- $|V_{EN}| < |V_{(HI)}|$
- The device junction temperature is greater than the thermal shutdown temperature.

表 7-1 shows the conditions that lead to the different modes of operation.

表 7-1. Device Functional Mode Comparison

OPERATING MODE	PARAMETER			
	V_{IN}	V_{EN}	I_{OUT}	T_J
Normal mode	$ V_{IN} > \{ V_{OUT(nom)} + V_{DOL} , V_{IN(min)} \}$	$ V_{EN} > V_{(HI)} $	$I_{OUT} < I_{CL}$	$T_J < 125^\circ\text{C}$
Dropout mode	$ V_{IN(min)} < V_{IN} < V_{OUT(nom)} + V_{DOL} $	$ V_{EN} > V_{(HI)} $	—	$T_J < 125^\circ\text{C}$
Disabled mode (any true condition disables the device)	$ V_{IN} \leq V_{UVLO} $	$ V_{EN} < V_{(HI)} $	—	$T_J > \sim 178^\circ\text{C}$

8 Application and Implementation

备注

Information in the following applications sections is not part of the TI component specification, and TI does not warrant its accuracy or completeness. TI's customers are responsible for determining suitability of components for their purposes, as well as validating and testing their design implementation to confirm system functionality.

8.1 Application Information

8.1.1 Adjustable Operation

The TPS7H1210-SEP has an output voltage range of V_{REF} to -15.5 V. The nominal output voltage of the device is set by two external resistors, as shown in [图 8-2](#).

R_{FB_TOP} and R_{FB_BOT} can be calculated for any output voltage range using [方程式 2](#). To ensure stability under no-load conditions at $|V_{OUT}| > |V_{REF}|$, this resistive network must provide a current equal to or greater than $5 \mu\text{A}$.

$$R_{FB_TOP} = R_{FB_BOT} \times \left(\frac{V_{OUT}}{V_{REF}} - 1 \right), \text{ where } \frac{|V_{REF}|}{R_{FB_BOT}} > 5 \mu\text{A} \quad (2)$$

[表 8-1](#) shows the resistor combinations to achieve a few of the most common rails using commercially available, 1%-tolerance resistors. If greater voltage accuracy is required, consider the output voltage offset contributions because of the feedback pin current and use 0.1%-tolerance resistors.

表 8-1. Example 1% Tolerance Resistors for Common Voltage Rails

V_{OUT} (V)	R_{FB_TOP} (k Ω)	R_{FB_BOT} (k Ω)	RESISTOR NETWORK BIAS CURRENT (μA)	RESISTOR ERROR CONTRIBUTION ⁽¹⁾
- 1.182	0	∞	N/A	N/A
- 1.8	7.32	14	84.4	+0.001%
- 2.5	11.3	10.2	115.9	+0.341%
- 3.3	19.1	10.7	110.5	- 0.245%
- 5	34	10.5	112.6	- 0.189%
- 9	115	17.4	67.9	+0.066%
- 10	445	15.4	76.8	- 0.086%
- 12	137	15	78.8	+0.187%
- 15	133	11.3	104.6	- 0.627%

- (1) This is the error contribution due to the mismatch between the ideal resistor ratio and the actual resistor ratio (using the indicated resistor values). It does not include the error contribution due to the resistor tolerance itself. More accurate ratios are possible by using 0.1% tolerance resistors.

8.1.2 Capacitor Recommendations

It is recommended to use low equivalent series resistance (ESR) capacitors for the input, output, noise reduction, and bypass capacitors. Ceramic capacitors with an X7R dielectric is preferred. This dielectric offers stable characteristics over temperature.

备注

High-ESR capacitors may degrade PSRR and affect stability.

The TPS7H1210-SEP negative linear regulator achieves stability with a minimum input and output capacitance of 10 μ F. TI recommends using a 10- μ F capacitor at the input. A larger capacitor is recommended at the output. Specifically, TI recommends using a 47- μ F capacitor (or multiple capacitors to reach \sim 47 μ F) at the output to improve single event transient (SET) performance.

8.1.3 Noise Reduction and Feed-Forward Capacitor Requirements

Although the noise-reduction (C_{NR_SS}) capacitor is not needed to achieve stability, TI highly recommends using a 100-nF noise-reduction capacitor to minimize noise and maximize AC performance. The noise-reduction capacitor is especially important at low currents as shown in [图 6-22](#).

It is generally recommended to not use a feed-forward capacitor. While a feed-forward capacitor can provide some improvements in PSRR at certain frequencies, it also has additional risks. See [Pros and Cons of Using a Feed-Forward Capacitor with a Low Dropout Regulator](#) for additional information.

CAUTION

Using a feed-forward capacitor with the TPS7H1210-SEP can cause the FB pin to go too positive during shutdown, thus damaging the device.

[图 8-1](#) shows the different PSRR performance of the device with and without a feed-forward capacitor with $V_{IN} = -13$ V, $V_{OUT} = -12$ V, $I_{OUT} = 1$ A, $C_{NR_SS} = 100$ nF, and $C_{OUT} = 50$ μ F.



图 8-1. Power-Supply Rejection Ratio vs Frequency Across C_{FF}

8.1.4 Power-Supply Rejection Ratio (PSRR)

Using a noise-reduction capacitor (C_{NR_SS}) of at least 10-nF greatly improves TPS7H1210-SEP power-supply rejection ratio. If the C_{NR_SS} capacitor is omitted, the PSRR can be 10 dB lower or worse across a wide range of frequencies. A 100-nF capacitor is generally recommended.

Additionally, TI recommends using at least a 47- μ F output capacitor for both single event transient (SET) and to achieve great AC performance. A 10- μ F input capacitor is generally sufficient for good device performance; however, a 47- μ F input capacitor or larger may be ideal if the input rail is extremely noisy.

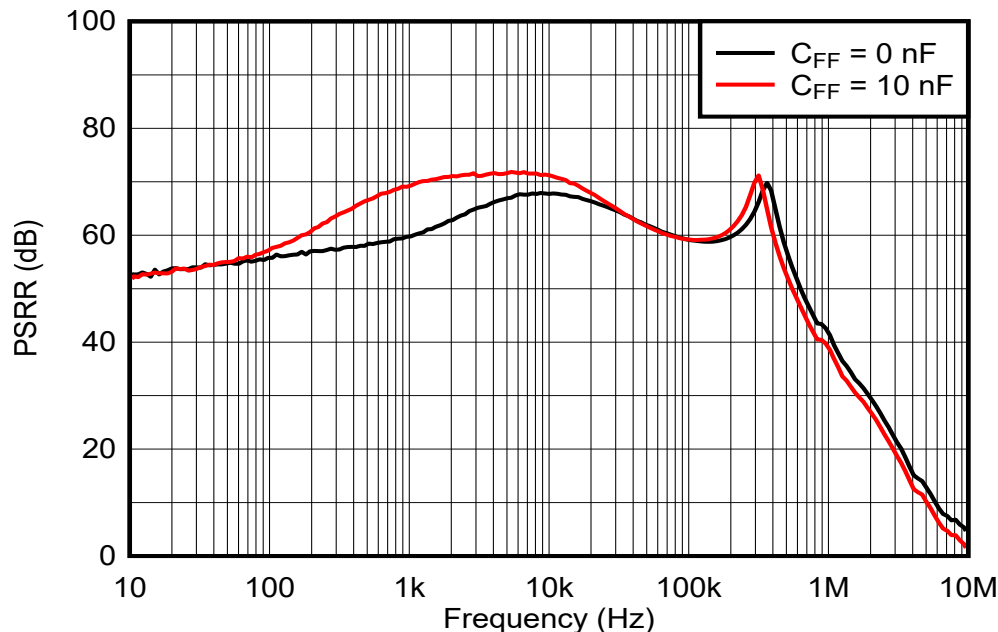
The high power-supply rejection of the TPS7H1210-SEP makes it a good choice for powering high-performance analog circuitry.

8.1.5 Output Noise

The TPS7H1210-SEP provides low output noise when a noise-reduction capacitor (C_{NR_SS}) is used.

The noise-reduction capacitor serves as a filter for the internal reference. By using a 100-nF noise reduction capacitor (C_{NR_SS}), the output noise can be reduced by approximately 80% (from 35.7 μ V_{RMS} to 7.1 μ V_{RMS}). See [Figure 6-22](#) for additional information. The benefit is less pronounced at higher currents (see [Figure 6-21](#)).

The TPS7H1210-SEP low output voltage noise makes it an ideal solution for powering noise-sensitive circuitry.

8.1.6 Transient Response

As with any regulator, increasing the size of the output capacitor reduces overshoot and undershoot magnitude, but increases duration of the transient response.

8.1.7 Post DC-DC Converter Filtering

Most of the time, the voltage rails available in a system do not match the voltage specifications demanded by one or more of its circuits; these rails must be stepped up or down, depending on specific voltage requirements.

DC-DC converters are generally the preferred solution to stepping up or down a voltage rail when current consumption is not negligible. These devices offer high efficiency with minimum heat generation, but they have one primary disadvantage: they introduce a high-frequency component, and the associated harmonics, on top of the DC output signal.

If not filtered properly, this high-frequency component degrades analog circuitry performance, and reduces overall system accuracy and precision.

The TPS7H1210-SEP offers a wide-bandwidth, very-high power-supply rejection ratio (PSRR). This specification makes it ideal for post DC-DC converter filtering. TI recommends using a schematic like the one shown in [Figure 8-2](#) for high performance. Also, verify that the TPS7H1210-SEP regulator PSRR is still high within the fundamental frequency (and its first harmonic, if possible) of the switching regulator.

8.1.8 Power for Precision Analog

One of the primary TPS7H1210-SEP applications is to provide very low noise voltage rails to high-performance analog circuitry in order to maximize system accuracy and precision. This includes powering operational amplifiers, ADCs, DACs, and RF amplifiers.

Because of the low noise levels at high voltages, the TPS7H1210-SEP can directly power high performance analog circuitry with high-voltage input supply requirements.

8.2 Typical Application



图 8-2. Adjustable Operation for Optimized AC and Radiation Performance

8.2.1 Design Requirements

The design goals for this example are $V_{IN} = -6\text{ V}$, $V_{OUT} = -5\text{ V}$, and $I_{OUT} = 1\text{-A}$ maximum. The design must optimize transient response, and the input supply comes from a supply on the same printed-circuit board (PCB).

8.2.2 Detailed Design Procedure

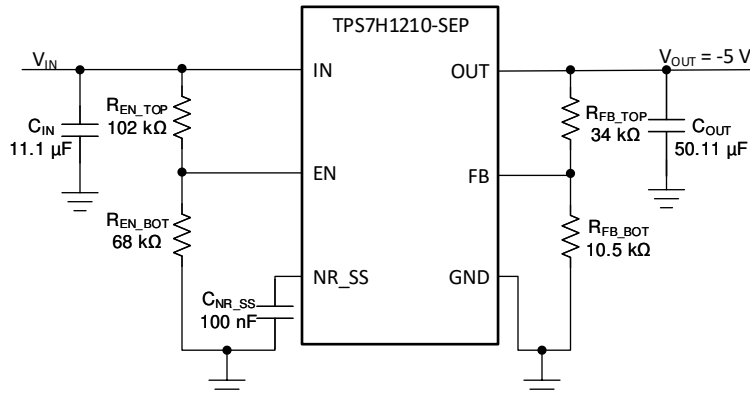
The design consists of C_{IN} , C_{OUT} , C_{NR_SS} , R_{FB_TOP} , R_{FB_BOT} , R_{EN_TOP} , R_{EN_BOT} , and the circuit shown in 图 8-2.

The first step when designing with a linear regulator is to examine the maximum load current along with the input and output voltage requirements to determine if the device thermal and dropout voltage requirements can be met. At 1 A, the input dropout voltage of the TPS7H1210-SEP device is a maximum of 500 mV over temperature; thus, the dropout headroom is sufficient for operation over both input and output voltage accuracy. Keep in mind that operating an LDO close to the dropout limit reduces AC performance, but has the benefit of reducing the power dissipation across the LDO.

The maximum power dissipated in the linear regulator is the maximum voltage drop across the pass element from the input to the output multiplied by the maximum load current (plus a small amount of quiescent power). In this example, the maximum voltage drop across in the pass element is $(-6\text{ V}) - (-5\text{ V})$, giving us a $V_{DROP} = 1\text{ V}$. The power dissipated in the pass element is calculated by taking this voltage drop multiplied by the maximum load current. For this example, the maximum power dissipated in the linear regulator is approximately 1 W.

To ensure an accurate output voltage, R_{FB_TOP} and R_{FB_BOT} must also be found, and the current through these resistors must be greater than 5 μA to ensure stability. For this design, R_{FB_TOP} is set to 34 $\text{k}\Omega$, to achieve reasonable leakage current while continuing to hold it well above 5 μA . Then 方程式 3 is used to calculate the proper value for R_{FB_BOT} .

$$R_{FB_BOT} = \frac{R_{FB_TOP} \times V_{REF}}{V_{OUT} - V_{REF}} = 10.5\text{ k}\Omega \text{ and } I_{DIVIDER} = \frac{|V_{REF}|}{R_{FB_BOT}} = 112.6\text{ }\mu\text{A} \quad (3)$$

Next, for C_{IN} a 10 μF , 1 μF , and 0.1- μF ceramic capacitor are selected. This provides margin over the 10- μF minimum input capacitance and reduces the impedance across a wider range of frequencies than a single 10- μF capacitor.

For C_{OUT} , 5 \times 10- μF , 1 \times 100-nF, and 1 \times 10-nF ceramic capacitors are selected. The multiple ceramic capacitors reduce ESR (equivalent series resistance) and ESL (equivalent series inductance) to aid in good AC performance. Additionally, better SET (single-event-transient) performance is generally achieved by choosing a larger output capacitance than the minimum of 10 μF .

Next, C_{NR_SS} is set at 100 nF for optimal noise performance along with maximized AC performance while keeping reasonable soft-start times.

To have a configurable turn-on voltage, feed the EN pin by a resistor divider from V_{IN} to GND. Since the TPS7H1210-SEP is commanded to turn-on when EN is less than -2 V (see $V_{EN(-HI)}$ in 节 6.5), 方程式 4 can be used to determine the resistors to select for a desired turn-on voltage, $V_{IN(turn-on)}$.

$$R_{EN_BOT} = \frac{R_{EN_TOP} \times 2\text{ V}}{V_{IN(turn-on)} - 2\text{ V}} \quad (4)$$

For this design $R_{EN_TOP} = 102\text{ k}\Omega$ and $R_{EN_BOT} = 68\text{ k}\Omega$, which results in $V_{IN(turn-on)} = -5$ V. This means that as V_{IN} is ramping from 0 V to its final value of -6 V during start-up, the regulator will turn-on when V_{IN} reaches -5 V.

8.2.3 Application Curves

图 8-3 and 图 8-4 show a 1-mA to 500-mA load step and 500-mA to 1-mA load step respectively using the values described within this section.

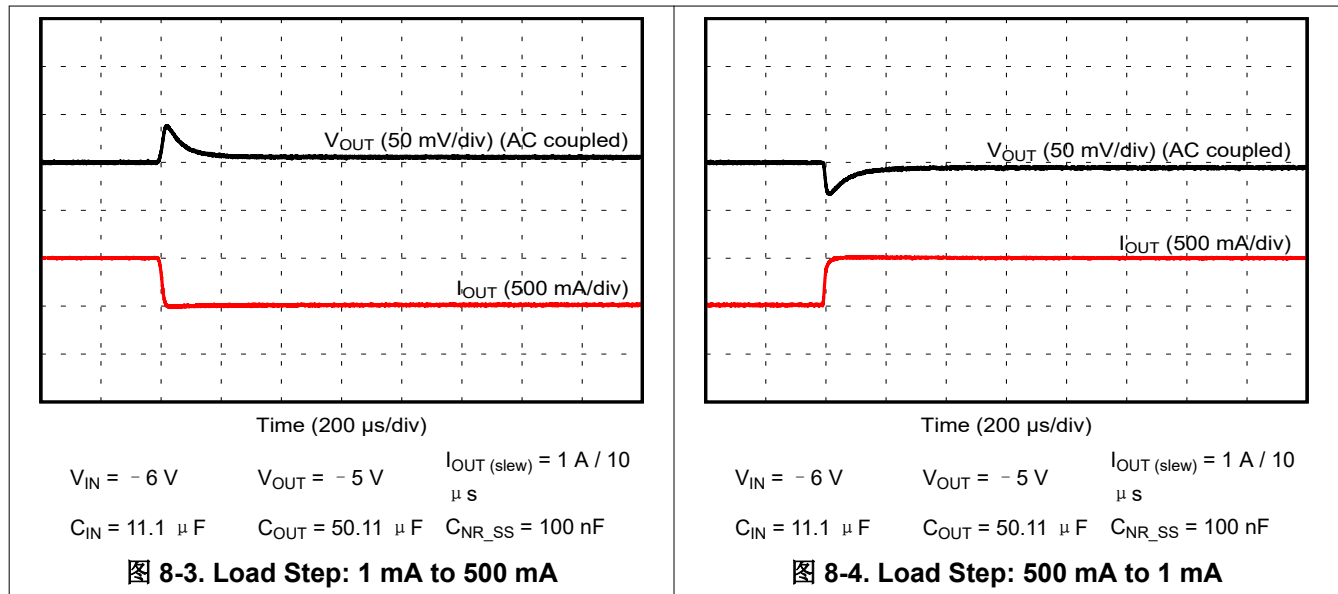

8.3 Do's and Don'ts

Place at least one low ESR 10- μ F capacitor as close as possible to both the IN and OUT terminals of the regulator to the GND pin.

Provide adequate thermal paths away from the device.

Do not place the input or output capacitor more than 10 mm away from the regulator.

Do not exceed the absolute maximum ratings.

Do not float the EN pin.

Do not resistively or inductively load the NR_SS pin.

9 Power Supply Recommendations

The input supply for the LDO must be within its recommended operating conditions, of -16.5 V to -3 V . The input voltage must provide adequate headroom for the device to have a regulated output. If the input supply is noisy, additional input capacitors with low ESR can help improve the output noise performance.

10 Layout

Layout is a critical part of good power-supply design. Several signal paths that conduct fast-changing currents or voltages can interact with stray inductance or parasitic capacitance to generate noise or degrade the power-supply performance. To help eliminate these problems, bypass the IN pin to ground with a low ESR ceramic bypass capacitor with an X7R dielectric.

10.1 Layout Guidelines

10.1.1 Improve PSRR and Noise Performance

To improve AC performance such as PSRR, output noise, and transient response, TI recommends designing the board with separate planes for IN, OUT, and GND. The IN and OUT planes should be isolated from each other by a GND plane section. In addition, the ground connection for the output capacitor should connect directly to the GND pin of the device.

Equivalent series inductance (ESL) and equivalent series resistance (ESR) must be minimized in order to maximize performance and ensure stability. Every capacitor (C_{IN} , C_{OUT} , C_{NR_SS} , and C_{FF} if used) must be placed as close as possible to the device and on the same side of the PCB as the regulator itself.

Do not place any of the capacitors on the opposite side of the PCB from where the regulator is installed. The use of vias and long traces is strongly discouraged because they may impact system performance negatively and even cause instability.

10.2 Layout Example

It may be possible to obtain acceptable performance with alternative PCB layouts.



图 10-1. TPS7H1210-SEP Layout Guideline

10.3 Thermal Performance

The high-current and high-voltage characteristics of the TPS7H1210-SEP means that, often enough, high power (heat) is dissipated from the device itself. This heat, if dissipated into the PCB, creates a temperature gradient in the surrounding area that causes nearby components to react to this temperature change (drift). In high-performance systems, such drift may degrade overall system accuracy and precision.

The heat generated by the device is a result of the power dissipation, which depends on input voltage and load conditions. Power dissipation (P_D) can be approximated by calculating the product of the output current times the voltage drop across the output pass element, as shown in [方程式 5](#):

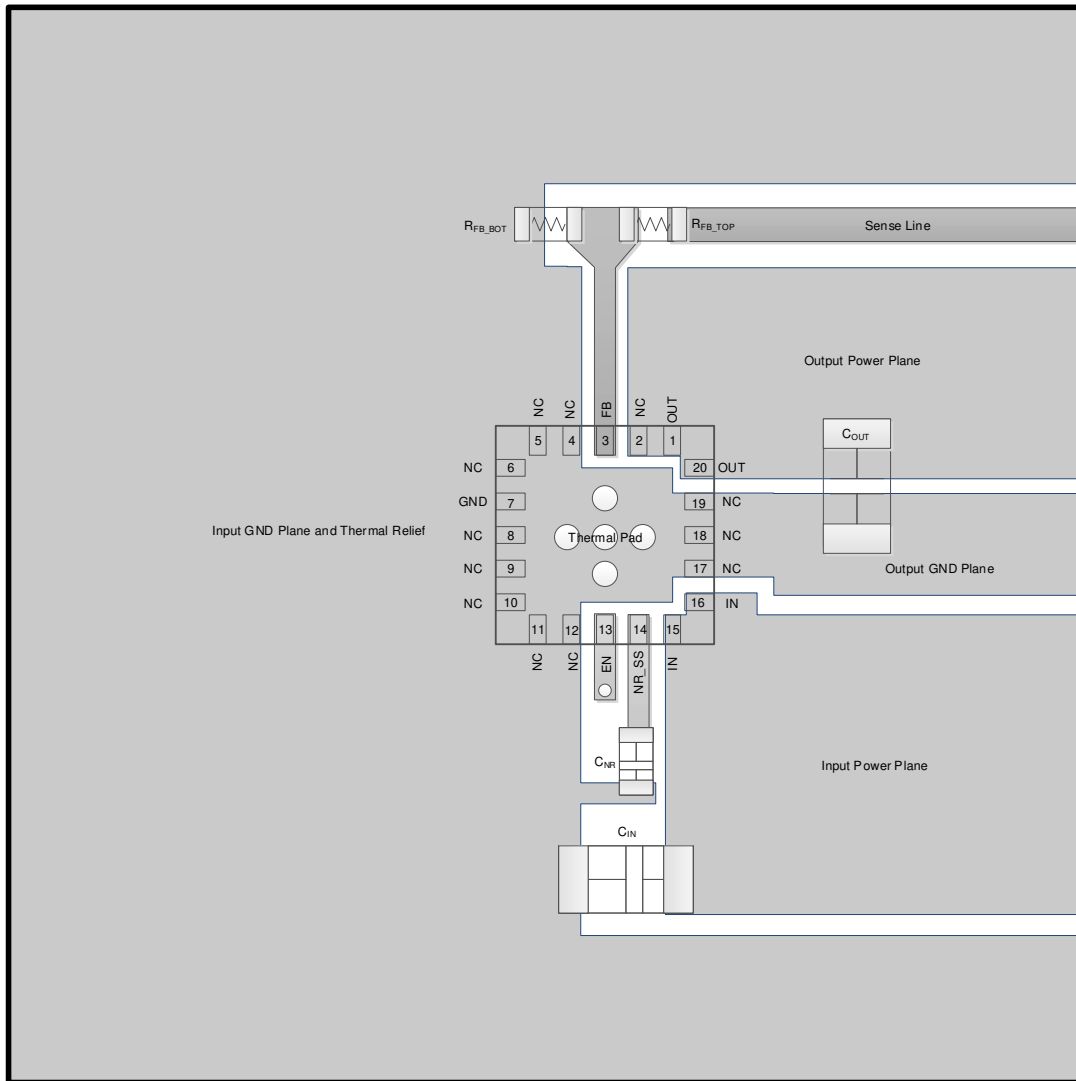
$$P_D = (V_{IN} - V_{OUT}) \times I_{OUT} \quad (5)$$

Be sure the PCB is able to effectively dissipate the heat resulting from the power dissipation.

11 Device and Documentation Support

11.1 Device Support

11.1.1 Development Support

11.1.1.1 Spice Models

Computer simulation of circuit performance using SPICE is often useful when analyzing the performance of analog circuits and systems. A PSpice model for the TPS7H1210-SEP is available through the [product folder under the Design & Development section](#).

11.2 Documentation Support

11.2.1 Related Documentation

For related documentation see the following:

- Texas Instrument, [TPS7H1210-SEP Total Ionizing Dose \(TID\) radiation report](#)
- Texas Instrument, [TPS7H1210-SEP Single-Event Effects \(SEE\) radiation report](#)
- Texas Instrument, [TPS7H1210-SEP Evaluation Module \(EVM\) user's guide](#)
- Texas Instrument, [Pros and Cons of Using a Feedforward Capacitor with a Low-Dropout Regulator application report](#)
- [Vendor item drawing available, VID V62/21616](#)

11.3 接收文档更新通知

要接收文档更新通知，请导航至 [ti.com](#) 上的器件产品文件夹。点击 [订阅更新](#) 进行注册，即可每周接收产品信息更改摘要。有关更改的详细信息，请查看任何已修订文档中包含的修订历史记录。

11.4 支持资源

[TI E2E™ 支持论坛](#) 是工程师的重要参考资料，可直接从专家获得快速、经过验证的解答和设计帮助。搜索现有解答或提出自己的问题可获得所需的快速设计帮助。

链接的内容由各个贡献者“按原样”提供。这些内容并不构成 TI 技术规范，并且不一定反映 TI 的观点；请参阅 TI 的 [《使用条款》](#)。

11.5 Trademarks

TI E2E™ is a trademark of Texas Instruments.

所有商标均为其各自所有者的财产。

11.6 Electrostatic Discharge Caution



This integrated circuit can be damaged by ESD. Texas Instruments recommends that all integrated circuits be handled with appropriate precautions. Failure to observe proper handling and installation procedures can cause damage.

ESD damage can range from subtle performance degradation to complete device failure. Precision integrated circuits may be more susceptible to damage because very small parametric changes could cause the device not to meet its published specifications.

11.7 术语表

[TI 术语表](#) 本术语表列出并解释了术语、首字母缩略词和定义。

12 Mechanical, Packaging, and Orderable Information

The following pages include mechanical, packaging, and orderable information. This information is the most current data available for the designated devices. This data is subject to change without notice and revision of this document. For browser-based versions of this data sheet, refer to the left-hand navigation.

PACKAGING INFORMATION

Orderable part number	Status (1)	Material type (2)	Package Pins	Package qty Carrier	RoHS (3)	Lead finish/ Ball material (4)	MSL rating/ Peak reflow (5)	Op temp (°C)	Part marking (6)
TPS7H1210MRGWSEP	Active	Production	VQFN (RGW) 20	70 TUBE	Yes	NIPDAU	Level-3-260C-168 HR	-55 to 125	7H1210
TPS7H1210MRGWTSEP	Active	Production	VQFN (RGW) 20	250 SMALL T&R	Yes	NIPDAU	Level-3-260C-168 HR	-55 to 125	7H1210
V62/21616-01XE	Active	Production	VQFN (RGW) 20	70 TUBE	Yes	NIPDAU	Level-3-260C-168 HR	See TPS7H1210MRGWSEP	7H1210
V62/21616-01XE-T	Active	Production	VQFN (RGW) 20	250 SMALL T&R	Yes	NIPDAU	Level-3-260C-168 HR	See TPS7H1210MRGWTSEF	7H1210

(1) **Status:** For more details on status, see our [product life cycle](#).

(2) **Material type:** When designated, preproduction parts are prototypes/experimental devices, and are not yet approved or released for full production. Testing and final process, including without limitation quality assurance, reliability performance testing, and/or process qualification, may not yet be complete, and this item is subject to further changes or possible discontinuation. If available for ordering, purchases will be subject to an additional waiver at checkout, and are intended for early internal evaluation purposes only. These items are sold without warranties of any kind.

(3) **RoHS values:** Yes, No, RoHS Exempt. See the [TI RoHS Statement](#) for additional information and value definition.

(4) **Lead finish/Ball material:** Parts may have multiple material finish options. Finish options are separated by a vertical ruled line. Lead finish/Ball material values may wrap to two lines if the finish value exceeds the maximum column width.

(5) **MSL rating/Peak reflow:** The moisture sensitivity level ratings and peak solder (reflow) temperatures. In the event that a part has multiple moisture sensitivity ratings, only the lowest level per JEDEC standards is shown. Refer to the shipping label for the actual reflow temperature that will be used to mount the part to the printed circuit board.

(6) **Part marking:** There may be an additional marking, which relates to the logo, the lot trace code information, or the environmental category of the part.

Multiple part markings will be inside parentheses. Only one part marking contained in parentheses and separated by a "-" will appear on a part. If a line is indented then it is a continuation of the previous line and the two combined represent the entire part marking for that device.

Important Information and Disclaimer:The information provided on this page represents TI's knowledge and belief as of the date that it is provided. TI bases its knowledge and belief on information provided by third parties, and makes no representation or warranty as to the accuracy of such information. Efforts are underway to better integrate information from third parties. TI has taken and continues to take reasonable steps to provide representative and accurate information but may not have conducted destructive testing or chemical analysis on incoming materials and chemicals. TI and TI suppliers consider certain information to be proprietary, and thus CAS numbers and other limited information may not be available for release.

In no event shall TI's liability arising out of such information exceed the total purchase price of the TI part(s) at issue in this document sold by TI to Customer on an annual basis.

GENERIC PACKAGE VIEW

RGW 20

VQFN - 1 mm max height

5 x 5, 0.65 mm pitch

PLASTIC QUAD FLATPACK - NO LEAD

This image is a representation of the package family, actual package may vary.
Refer to the product data sheet for package details.

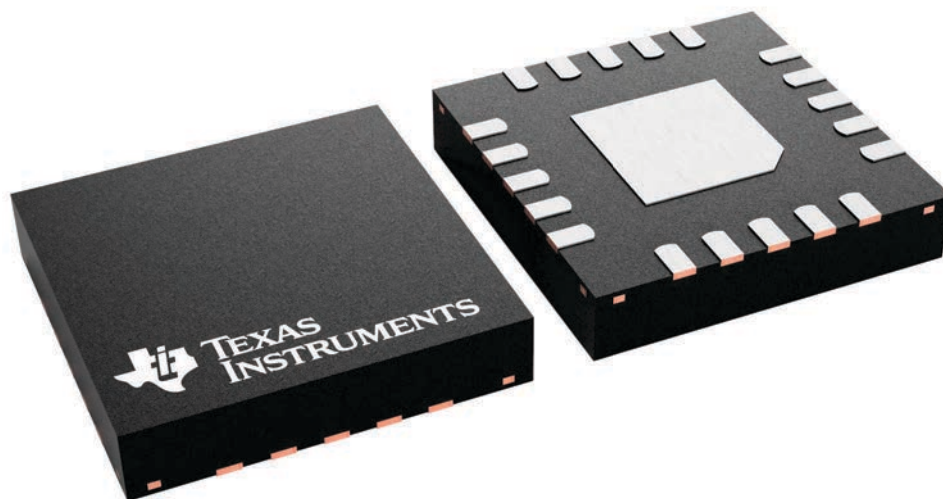

4227157/A

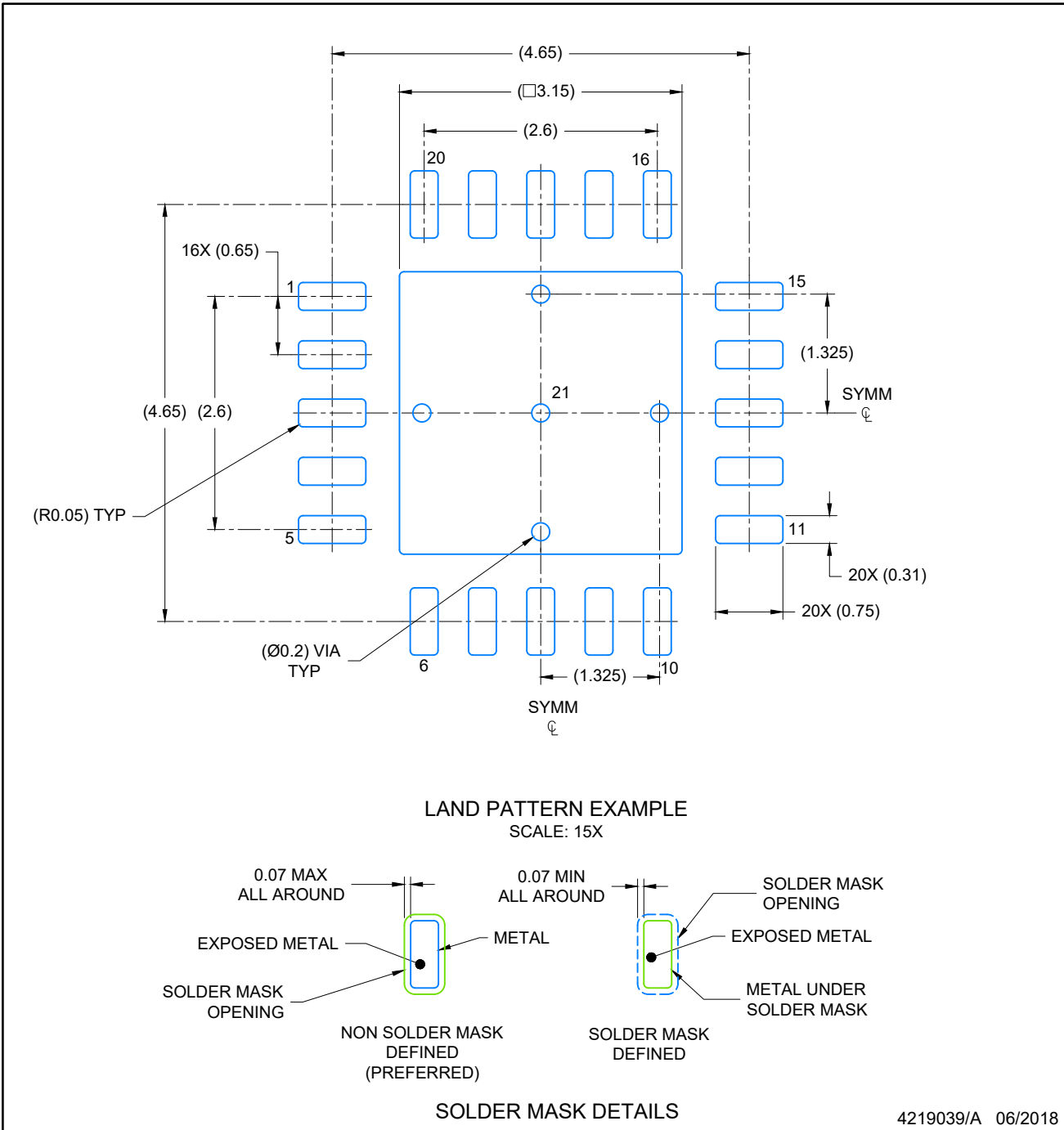

NOTES: (continued)

4. This package is designed to be soldered to a thermal pad on the board. For more information, see Texas Instruments literature number SLUA271 (www.ti.com/lit/sluea271).
5. Vias are optional depending on application, refer to device data sheet. If any vias are implemented, refer to their locations shown on this view. It is recommended that vias under paste be filled, plugged or tented.

EXAMPLE STENCIL DESIGN

VQFN - 1 mm max height

RGW0020A

PLASTIC QUAD FLATPACK-NO LEAD

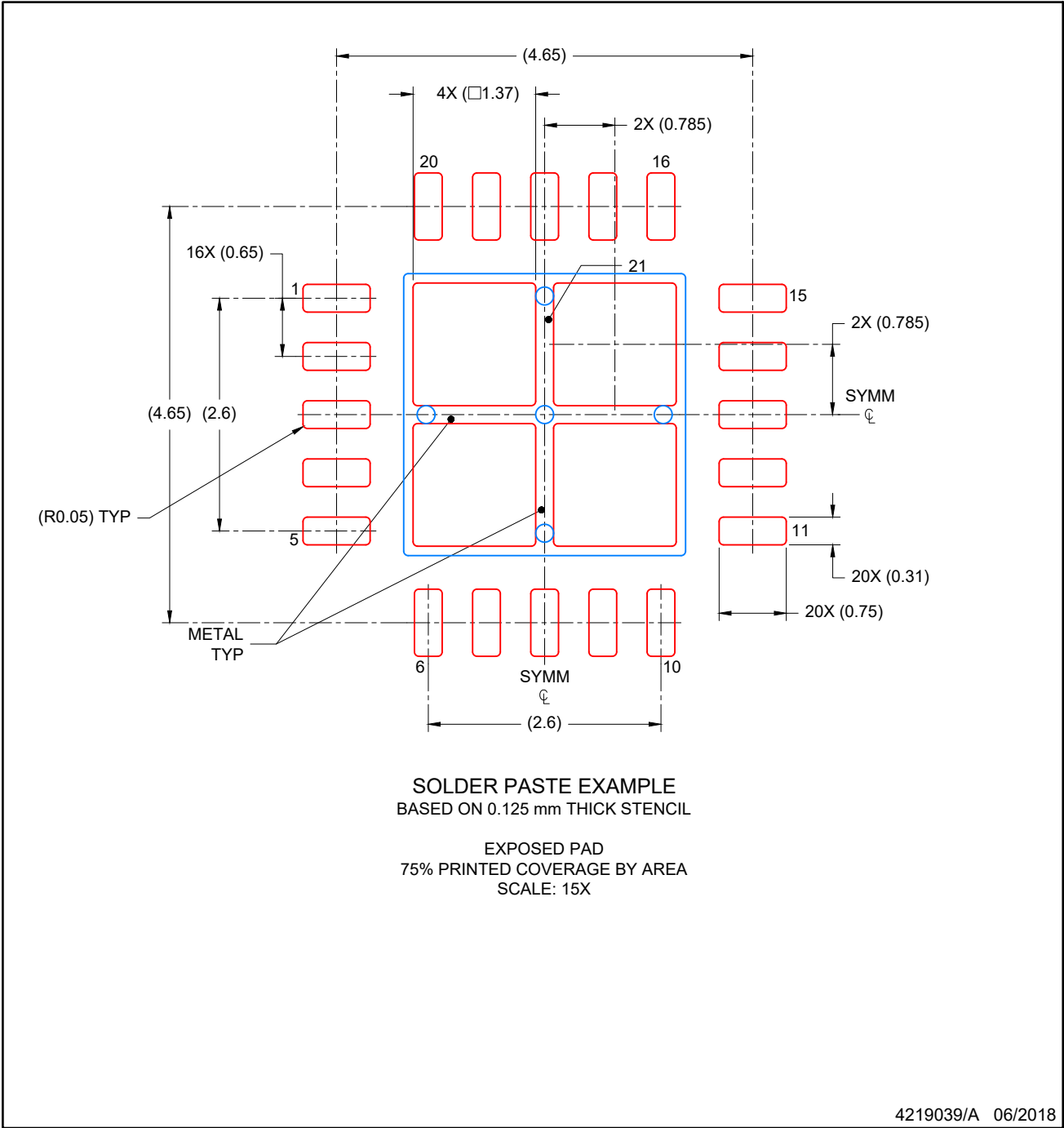

NOTES: (continued)

- 6. Laser cutting apertures with trapezoidal walls and rounded corners may offer better paste release. IPC-7525 may have alternate design recommendations.

重要通知和免责声明

TI“按原样”提供技术和可靠性数据（包括数据表）、设计资源（包括参考设计）、应用或其他设计建议、网络工具、安全信息和其他资源，不保证没有瑕疵且不做任何明示或暗示的担保，包括但不限于对适销性、与某特定用途的适用性或不侵犯任何第三方知识产权的暗示担保。

这些资源可供使用 TI 产品进行设计的熟练开发人员使用。您将自行承担以下全部责任：(1) 针对您的应用选择合适的 TI 产品，(2) 设计、验证并测试您的应用，(3) 确保您的应用满足相应标准以及任何其他安全、安保法规或其他要求。

这些资源如有变更，恕不另行通知。TI 授权您仅可将这些资源用于研发本资源所述的 TI 产品的相关应用。严禁以其他方式对这些资源进行复制或展示。您无权使用任何其他 TI 知识产权或任何第三方知识产权。对于因您对这些资源的使用而对 TI 及其代表造成的任何索赔、损害、成本、损失和债务，您将全额赔偿，TI 对此概不负责。

TI 提供的产品受 [TI 销售条款](#)、[TI 通用质量指南](#) 或 [ti.com](#) 上其他适用条款或 TI 产品随附的其他适用条款的约束。TI 提供这些资源并不会扩展或以其他方式更改 TI 针对 TI 产品发布的适用的担保或担保免责声明。除非德州仪器 (TI) 明确将某产品指定为定制产品或客户特定产品，否则其产品均为按确定价格收入目录的标准通用器件。

TI 反对并拒绝您可能提出的任何其他或不同的条款。

版权所有 © 2026，德州仪器 (TI) 公司

最后更新日期：2025 年 10 月