



2nd-Order Delta-Sigma Modulator with Excitation for Hall Elements

FEATURES

- $\pm 100\text{mV}$ Specified Input Range
- $\pm 125\text{mV}$ Full-Scale Range
- 95dB typ. CMR, 82dB typ. SNR
- Adjustable Current Output for Sensor Biasing
- Digital Output Compatible to ADS1202/03
- Differential Digital Outputs
- Separate 2.7V to 5.5V Digital Supply Pin

APPLICATIONS

- Motor Control
- Current Measurement
- Hall Sensors
- Bridge Sensors
- Instrumentation

DESCRIPTION

The ADS1208 is a 2nd-order $\Delta\Sigma$ (delta-sigma) modulator operating at a 10MHz clock rate. The specified input range is $\pm 100\text{mV}$, optimized for current measurement with a Hall sensor, especially in motor control applications. The ADS1208 contains a programmable current source for sensor biasing and has integrated input buffers for fast settling of the sample capacitors; it also requires only a minimum of external components. The differential analog input offers low noise and excellent common-mode rejection.

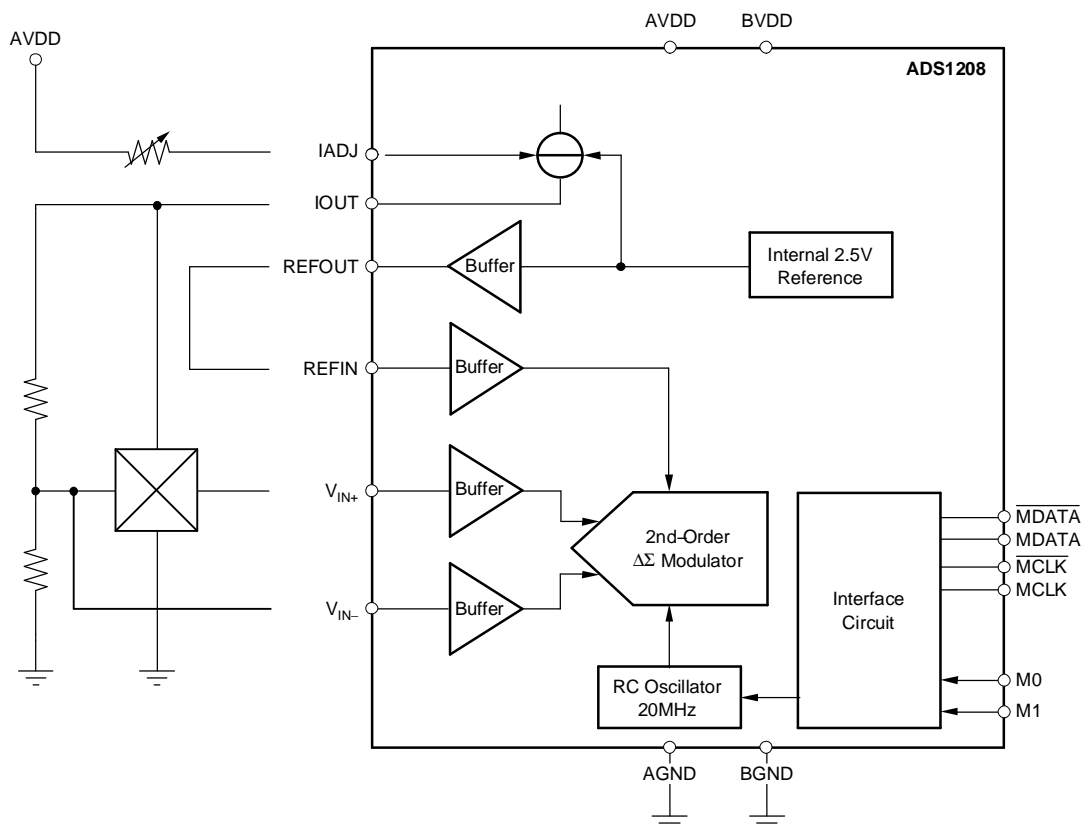

Please be aware that an important notice concerning availability, standard warranty, and use in critical applications of Texas Instruments semiconductor products and disclaimers thereto appears at the end of this data sheet.

 This integrated circuit can be damaged by ESD. Texas Instruments recommends that all integrated circuits be handled with appropriate precautions. Failure to observe proper handling and installation procedures can cause damage.

ESD damage can range from subtle performance degradation to complete device failure. Precision integrated circuits may be more susceptible to damage because very small parametric changes could cause the device not to meet its published specifications.

Package/Ordering Information

For the most current package and ordering information, see the Package Option Addendum at the end of this document, or see the TI web site at www.ti.com.

ABSOLUTE MAXIMUM RATINGS

over operating free-air temperature range (unless otherwise noted)⁽¹⁾

	ADS1208I	UNIT
Supply voltage, AGND to AV _{DD}	-0.3 to +6	V
Supply voltage, BGND to BV _{DD}	-0.3 to +6	V
Analog input voltage with respect to AGND	AGND - 0.3 to AV _{DD} + 0.3	V
Reference input voltage with respect to AGND	AGND - 0.3 to AV _{DD} + 0.3	V
Digital input voltage with respect to BGND	BGND - 0.3 to BV _{DD} + 0.3	V
Ground voltage difference AGND to BGND	±0.3	V
Input current to any pin except supply	±10	mA
Power dissipation	See Dissipation Ratings Table	
Operating virtual junction temperature range, T _J	-40 to +150	°C
Operating free-air temperature range, T _A	-40 to +85	°C
Storage temperature range, T _{STG}	-65 to +150	°C

(1) Stresses beyond those listed under *Absolute Maximum Ratings* may cause permanent damage to the device. These are stress ratings only, and functional operation of the device at these or any other conditions beyond those indicated under *Recommended Operating Conditions* is not implied. Exposure to absolute-maximum-rated conditions for extended periods may affect device reliability.

RECOMMENDED OPERATING CONDITIONS

PARAMETER	MIN	NOM	MAX	UNIT	
Supply voltage, AGND to AV _{DD}	4.5	5.0	5.5	V	
Supply voltage, BGND to BV _{DD}	Low-voltage levels		3.6	V	
	5V logic levels		5.5	V	
Reference input voltage	0.5	2.5	3.0	V	
Analog inputs	V _{IN+} - V _{IN-}		-V _{REFIN} /20	+V _{REFIN} /20	V

DISSIPATION RATINGS TABLE

BOARD	PACKAGE	R _{θJC}	R _{θJA}	DERATING FACTOR ABOVE T _A = 25°C	T _A ≤ 25°C POWER RATING	T _A = 70°C POWER RATING	T _A = 85°C POWER RATING
Low-K ⁽¹⁾	PW	35°C/W	147°C/W	6.8mW/°C	850mW	544mW	442mW
High-K ⁽²⁾	PW	33.6°C/W	108.4°C	9.225W/°C	1150mW	738mW	600mW

(1) The JEDEC low-K (1s) board used to derive this data was a 3in x 3in, two-layer board with 2-ounce copper traces on top of the board.
 (2) The JEDEC high-K (2s2p) board used to derive this data was a 3in x 3in, multilayer board with 1-ounce internal power and ground planes and 2-ounce copper traces on top and bottom of the board.

ELECTRICAL CHARACTERISTICS

Over recommended operating free-air temperature range at -40°C to $+85^{\circ}\text{C}$, $\text{AV}_{\text{DD}} = \text{BV}_{\text{DD}} = +5\text{V}$, $\text{V}_{\text{REF}} = \text{internal } +2.5\text{V}$, Mode 3, MCLK input = 20MHz, differential input voltage = 200mV_{pp} , common-mode voltage = 1.4V, and 16-bit Sinc³ filter with OSR = 256, unless otherwise noted.

PARAMETER	TEST CONDITIONS	ADS1208I			UNIT	
		MIN	TYP ⁽¹⁾	MAX		
Resolution		16			Bits	
DC Accuracy						
Integral nonlinearity ⁽²⁾	16-bit resolution	-8	1.6	8	LSB	
Integral nonlinearity		-0.012	0.0025	0.012	%	
Differential nonlinearity ⁽³⁾	16-bit resolution	-1.0			1.0	LSB
Input offset ⁽⁴⁾		-2.0	-1.4	0	mV	
Input offset drift		2.0			8.0	$\mu\text{V}/^{\circ}\text{C}$
Gain error ⁽⁴⁾	Referenced to voltage at REFIN	-1.25	-0.7	1.25	%	
Gain error drift	Referenced to voltage at REFIN	15			ppm/ $^{\circ}\text{C}$	
Power-supply rejection ratio		66			dB	
Analog Input						
Full-scale range	$\text{V}_{\text{IN}+} - \text{V}_{\text{IN}-}$	-125	125		mV	
Operating common-mode signal		0.8	1.4	2.5	V	
Input capacitance		5.0			pF	
Common-mode rejection		95			dB	
Current Source (IOUT)						
Output current ⁽⁵⁾	I_{OUT}	1.0	5.0	8.0	mA	
Voltage at IOUT pin	V_{OUT}	0	$\text{AVDD} - 1.0$		V	
Voltage between AVDD pin and IADJ	V_{ADJ} at $\text{I}_{\text{OUT}} = 1\text{mA}$ to 8mA	480	500	520	mV	
Internal Voltage Reference						
Reference output voltage	REFOUT	2.45	2.5	2.55	V	
Reference temperature drift		20			ppm/ $^{\circ}\text{C}$	
Output resistance		0.3			Ω	
Output source current		3.0			mA	
Power-supply rejection ratio		60			dB	
Startup time		0.1			ms	
Voltage Reference Input						
Reference voltage input	REFIN	0.5	3.0		V	
Reference input capacitance		5			pF	
Reference input current		-50	+50		nA	
Internal Clock for Modes 0, 1 and 2						
Clock frequency		8.0	10.1	12.0	MHz	
External Clock for Mode 3						
Clock frequency		1.0	24.0		MHz	

(1) All values are at $T_A = 25^{\circ}\text{C}$.

(2) Integral nonlinearity is defined as the maximum deviation of the line through the end points of the specified input range of the transfer curve for $\text{V}_{\text{IN}+} - \text{V}_{\text{IN}-} = -100\text{mV}$ to $+100\text{mV}$, expressed either as the number of LSBs or as a percent of the measured input range (200mV).

(3) Ensured by design.

(4) Maximum values, including temperature drift, are ensured over the full specified temperature range.

(5) It is possible to leave pin IOUT unconnected ($\text{I}_{\text{OUT}} = 0\text{mA}$).

ELECTRICAL CHARACTERISTICS (continued)

Over recommended operating free-air temperature range at -40°C to $+85^{\circ}\text{C}$, $\text{AV}_{\text{DD}} = \text{BV}_{\text{DD}} = +5\text{V}$, $\text{V}_{\text{REF}} = \text{internal } +2.5\text{V}$, Mode 3, MCLK input = 20MHz, differential input voltage = 200mV_{PP} , common-mode voltage = 1.4V, and 16-bit Sinc³ filter with OSR = 256, unless otherwise noted.

PARAMETER	TEST CONDITIONS	ADS1208I			UNIT
		MIN	TYP ⁽¹⁾	MAX	
AC Accuracy					
SNR	$\text{V}_{\text{IN}} = 200\text{mV}_{\text{PP}}$ at 1kHz	80	82		dB
SINAD	$\text{V}_{\text{IN}} = 200\text{mV}_{\text{PP}}$ at 1kHz	77	81.5		dB
THD	$\text{V}_{\text{IN}} = 200\text{mV}_{\text{PP}}$ at 1kHz		-91	-80	dB
SFDR	$\text{V}_{\text{IN}} = 200\text{mV}_{\text{PP}}$ at 1kHz	80	93		dB
Digital Inputs⁽⁶⁾					
Logic family		CMOS			
V_{IH} High-level input voltage		$0.7 \times \text{BV}_{\text{DD}}$		$\text{BV}_{\text{DD}} + 0.3$	V
V_{IL} Low-level input voltage		-0.3		$0.3 \times \text{BV}_{\text{DD}}$	V
I_{IN} Input current	$\text{V}_{\text{IN}} = \text{BV}_{\text{DD}}$ or GND	-50		50	nA
C_{I} Input capacitance			5		pF
Digital Outputs⁽⁶⁾					
Logic family		CMOS			
V_{OH} High-level output voltage	$\text{BV}_{\text{DD}} = 4.5\text{V}$, $\text{I}_{\text{OH}} = -100\mu\text{A}$	4.44			V
V_{OL} Low-level output voltage	$\text{BV}_{\text{DD}} = 4.5\text{V}$, $\text{I}_{\text{OL}} = +100\mu\text{A}$			0.5	V
C_{L} Load capacitance				30	pF
Data format		Bit stream			
Digital Inputs⁽⁷⁾					
Logic family		LVCMOS			
V_{IH} High-level input voltage	$\text{BV}_{\text{DD}} = 3.6\text{V}$	2		$\text{BV}_{\text{DD}} + 0.3$	V
V_{IL} Low-level input voltage	$\text{BV}_{\text{DD}} = 2.7\text{V}$	-0.3		0.8	V
I_{IN} Input current	$\text{V}_{\text{IN}} = \text{BV}_{\text{DD}}$ or GND	-50		50	nA
C_{I} Input capacitance			5		pF
Digital Outputs⁽⁷⁾					
Logic family		LVCMOS			
V_{OH} High-level output voltage	$\text{BV}_{\text{DD}} = 2.7$, $\text{I}_{\text{OH}} = -100\mu\text{A}$	$\text{BV}_{\text{DD}} - 0.2$			V
V_{OL} Low-level output voltage	$\text{BV}_{\text{DD}} = 2.7$, $\text{I}_{\text{OL}} = +100\mu\text{A}$			0.2	V
C_{L} Load capacitance				30	pF
Data format		Bit stream			
Power Supply					
Analog supply voltage, AV_{DD}		4.5	5.0	5.5	V
Digital interface supply voltage, BV_{DD}		2.7	5	5.5	V
Operating supply current, AI_{DD}	Modes 0, 1 and 2		11.9	15.0	mA
Operating supply current, AI_{DD}	Mode 3		11.5	14.5	mA
Operating supply current, BI_{DD}	Modes 0, 1 and 2		2.3	3.0	mA
Operating supply current, BI_{DD}	Mode 3		1.3	2.0	mA
Power dissipation	Modes 0, 1 and 2		71	90	mW
Power dissipation	Mode 3		64	82.5	mW

(6) Applicable for 5.0V nominal supply; BV_{DD} (min) = 4.5V and BV_{DD} (max) = 5.5V.

(7) Applicable for 3.0V nominal supply; BV_{DD} (min) = 2.7V and BV_{DD} (max) = 3.6V

PARAMETER MEASUREMENT INFORMATION

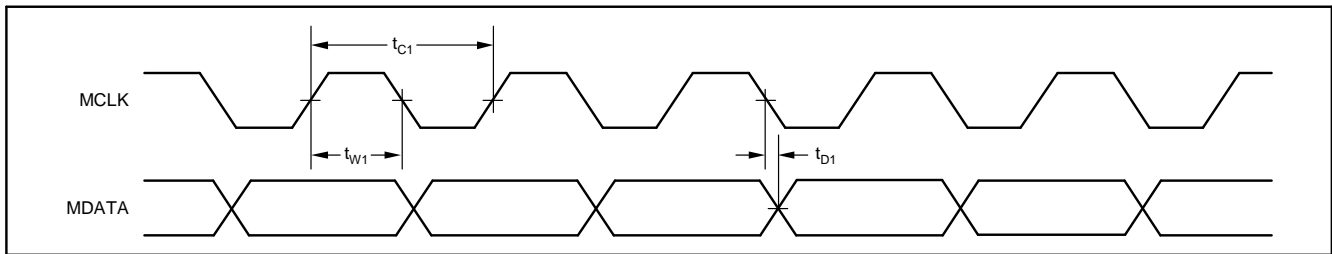

Figure 1. Mode 0 Operation

TIMING CHARACTERISTICS: MODE 0

Over recommended operating free-air temperature range at -40°C to $+85^{\circ}\text{C}$, and $AV_{DD} = +5\text{V}$, $BV_{DD} = +2.7$ to $+5.5\text{V}$, unless otherwise noted.

PARAMETER		MIN	MAX	UNIT
t_{C1}	Clock period	83	125	ns
t_{W1}	Clock high time	$(t_{C1} / 2) - 5$	$(t_{C1} / 2) + 5$	ns
t_{D1}	Data delay after rising edge of clock	-2	+2	ns

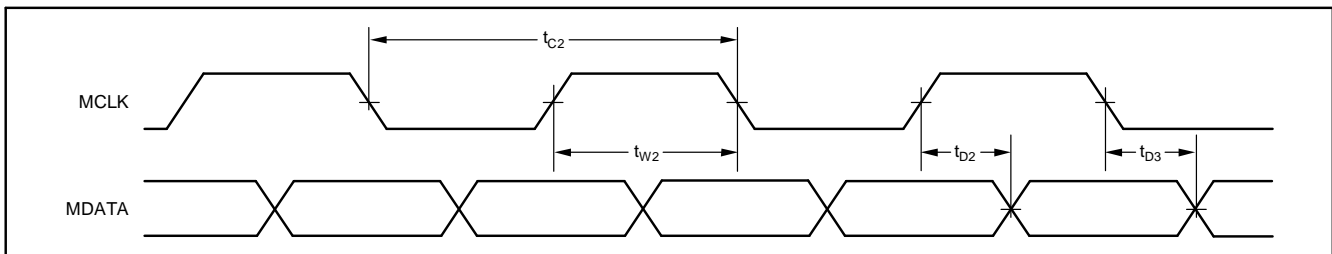

Figure 2. Mode 1 Operation

TIMING CHARACTERISTICS: MODE 1

Over recommended operating free-air temperature range at -40°C to $+85^{\circ}\text{C}$, and $AV_{DD} = +5\text{V}$, $BV_{DD} = +2.7$ to $+5.5\text{V}$, unless otherwise noted.

PARAMETER		MIN	MAX	UNIT
t_{C1}	Clock period	166	250	ns
t_{W2}	Clock high time	$(t_{C2} / 2) - 5$	$(t_{C2} / 2) + 5$	ns
t_{D2}	Data delay after rising edge of clock	$(t_{W2} / 2) - 2$	$(t_{W2} / 2) + 2$	ns
t_{D3}	Data delay after falling edge of clock	$(t_{W2} / 2) - 2$	$(t_{W2} / 2) + 2$	ns

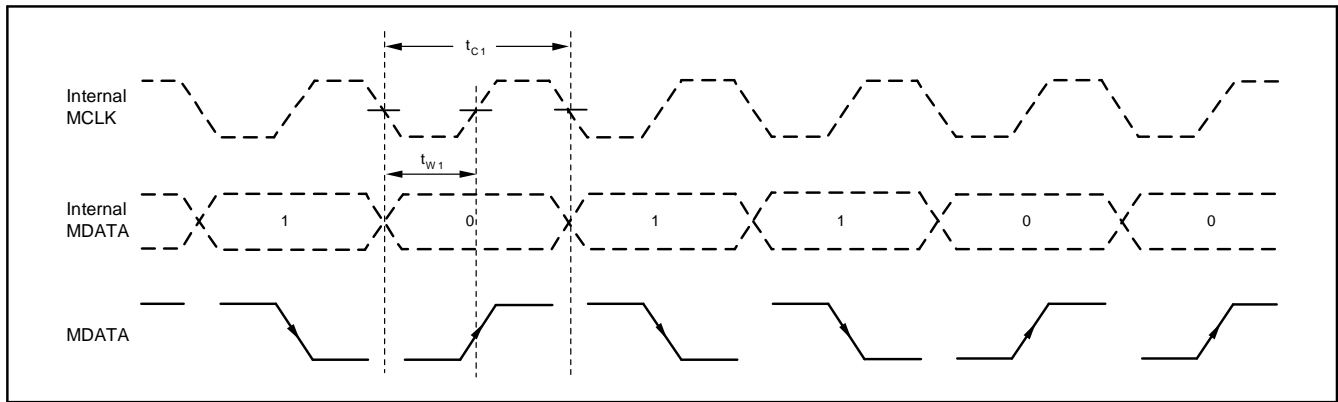
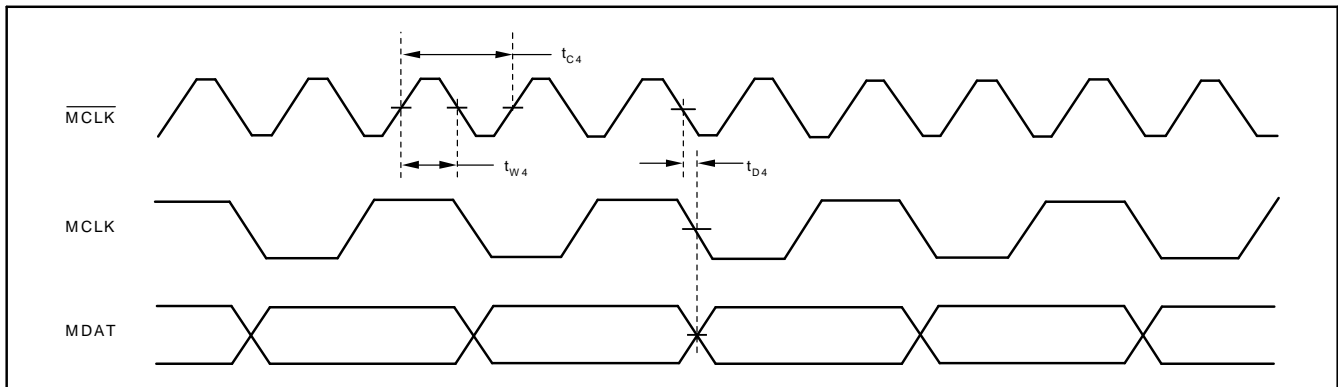

Figure 3. Mode 2 Operation

TIMING CHARACTERISTICS: MODE 2

Over recommended operating free-air temperature range at -40°C to $+85^{\circ}\text{C}$, and $\text{AV}_{\text{DD}} = +5\text{V}$, $\text{BV}_{\text{DD}} = +2.7$ to $+5.5\text{V}$, unless otherwise noted.

PARAMETER		MIN	MAX	UNIT
t_{C1}	Clock period	83	125	ns
t_{W1}	Clock high time	$(t_{\text{C1}} / 2) - 5$	$(t_{\text{C1}} / 2) + 5$	ns



note: $\overline{\text{MCLK}}$ is system clock input. MCLK is modulator clock output. Modulator clock frequency is half of system clock frequency.

Figure 4. Mode 3 Operation

TIMING CHARACTERISTICS: MODE 3

Over recommended operating free-air temperature range at -40°C to $+85^{\circ}\text{C}$, and $\text{AV}_{\text{DD}} = +5\text{V}$, $\text{BV}_{\text{DD}} = +2.7$ to $+5.5\text{V}$, unless otherwise noted.

PARAMETER		MIN	MAX	UNIT
t_{C4}	Clock period	41	1000	ns
t_{W4}	Clock high time	10	$t_{\text{C4}} - 10$	ns
t_{D4}	Data and output clock delay after falling edge of input clock	0	10	ns
t_{R}	Rise time of clock (10% to 90% of BV_{DD})	0	10	ns
t_{F}	Fall time of clock (90% to 10% of BV_{DD})	0	10	ns

DEVICE INFORMATION

**16-LEAD TSSOP PACKAGE
(TOP VIEW)**

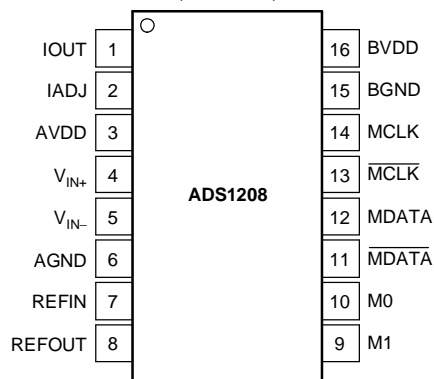
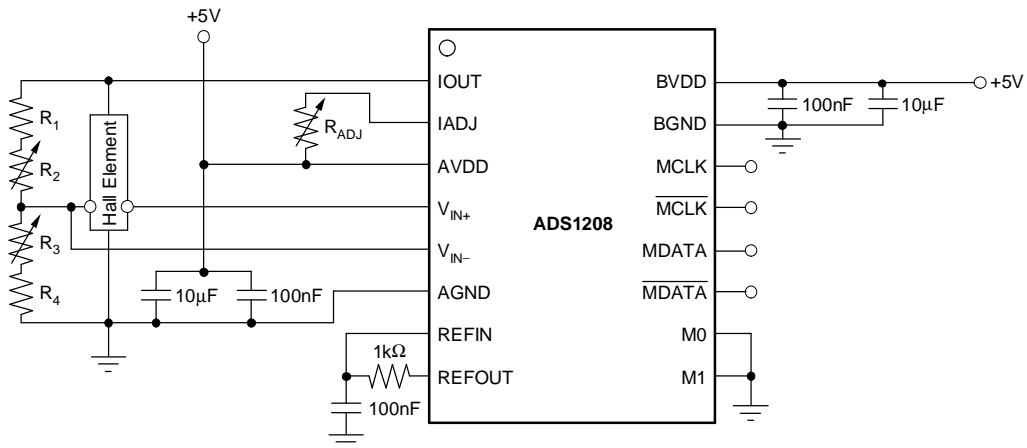

Table 1. TERMINAL FUNCTIONS

PIN		DESCRIPTION
NO.	NAME	
1	IOUT	Current output for sensor
2	IADJ	Output current adjustment
3	AVDD	Analog supply
4	V _{IN+}	Positive input
5	V _{IN-}	Negative input
6	AGND	Analog ground
7	REFIN	Reference input
8	REFOUT	Reference output
9	M1	Mode selection input
10	M0	Mode selection input
11	$\overline{\text{MDATA}}$	Inverted data output
12	MDATA	Noninverted data output
13	$\overline{\text{MCLK}}$	Inverted clock output (Modes 0, 1); Clock input (Mode 3)
14	MCLK	Noninverted clock output
15	BGND	Digital interface ground
16	BVDD	Digital interface supply (2.7V to 5.5V)

FUNCTIONAL BLOCK DIAGRAM



A. For Functional configuration (Mode 0), possible Hall elements include the Toshiba THS119 and the Philips KMZ10.

Figure 5. Functional Configuration (Mode 0)

TYPICAL CHARACTERISTICS

At 25°C, $AV_{DD} = BV_{DD} = +5V$, $V_{REF} = \text{internal } +2.5V$, Mode 3, MCLK input = 20MHz, differential input voltage = 200mV_{PP}, common-mode voltage = 1.4V, and 16-bit Sinc³ filter with OSR = 256, unless otherwise noted.

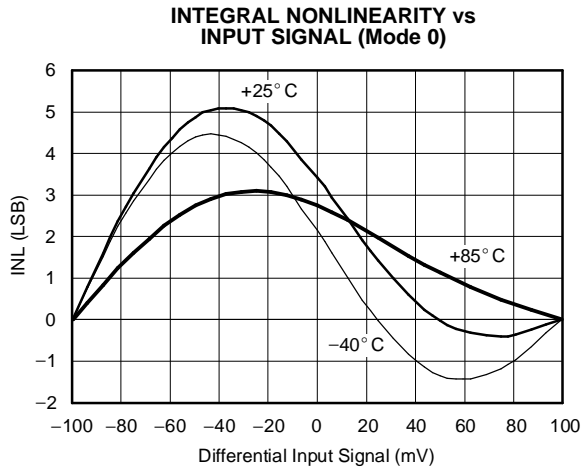

Figure 6.

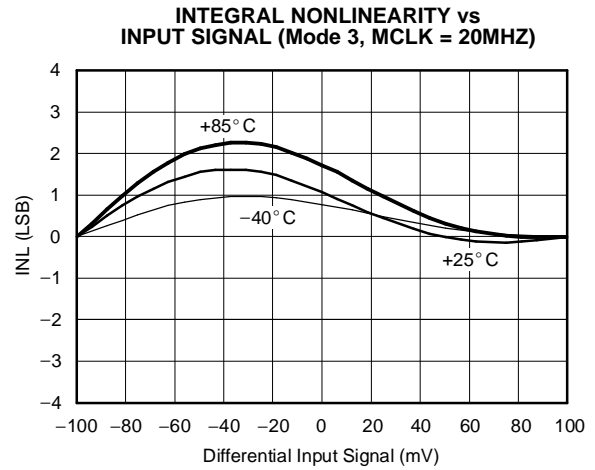

Figure 7.

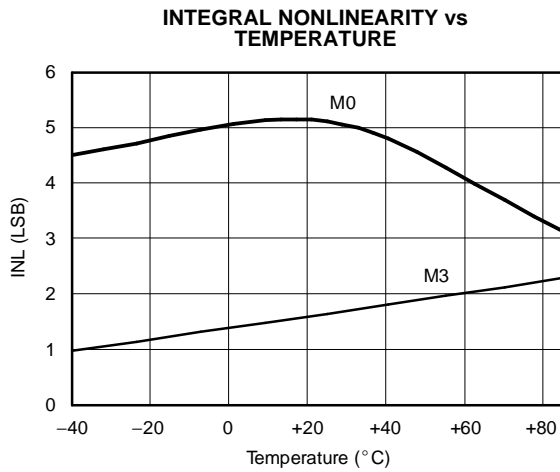

Figure 8.

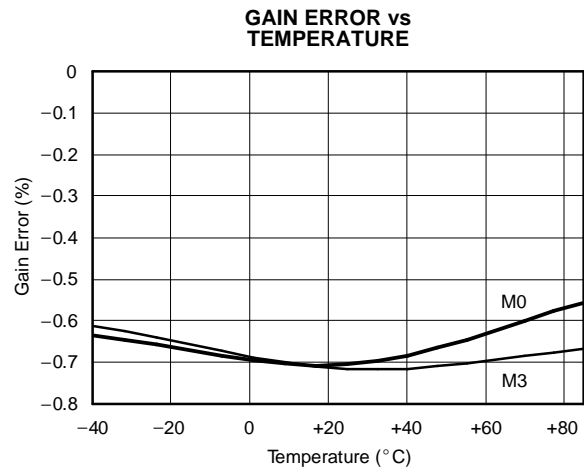

Figure 9.

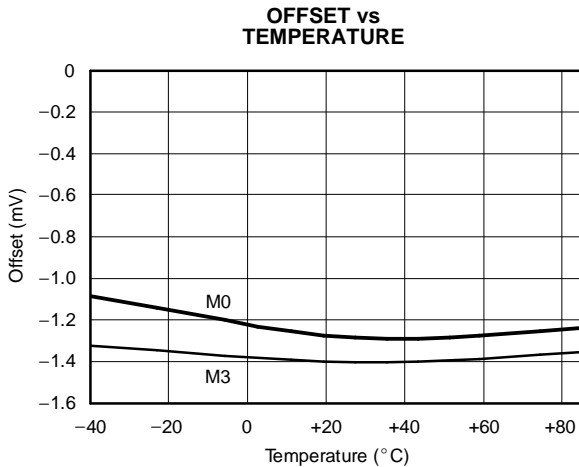

Figure 10.

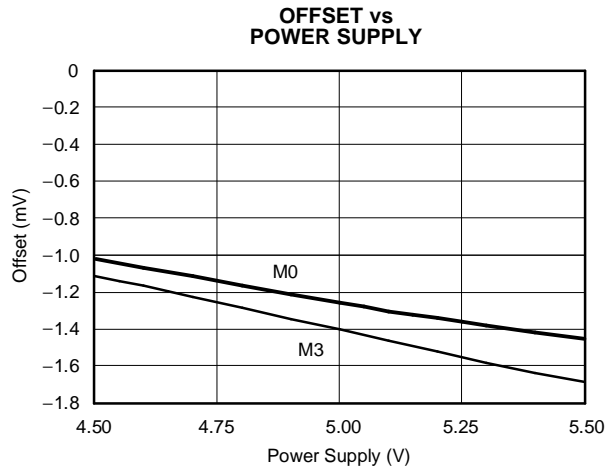

Figure 11.

TYPICAL CHARACTERISTICS (continued)

At 25°C, $AV_{DD} = BV_{DD} = +5V$, $V_{REF} = \text{internal } +2.5V$, Mode 3, MCLK input = 20MHz, differential input voltage = 200mV_{pp}, common-mode voltage = 1.4V, and 16-bit Sinc³ filter with OSR = 256, unless otherwise noted.

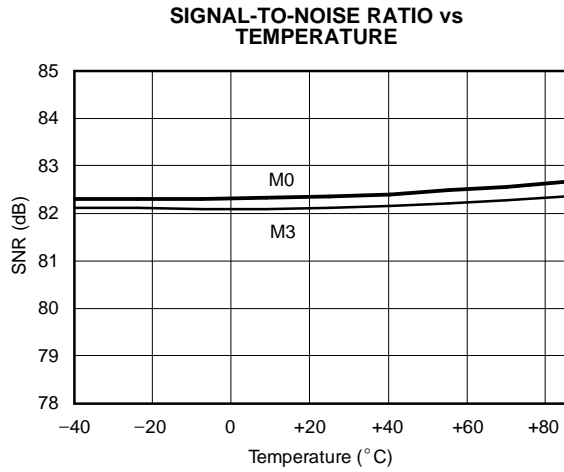

Figure 12.

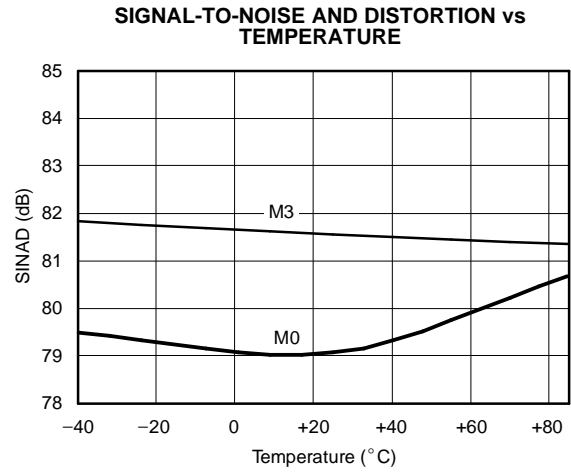

Figure 13.

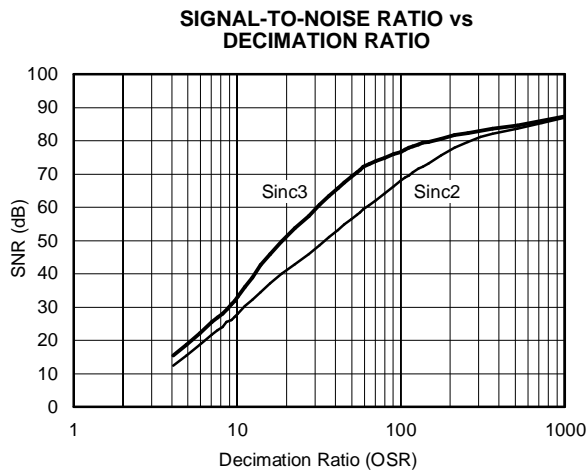

Figure 14.

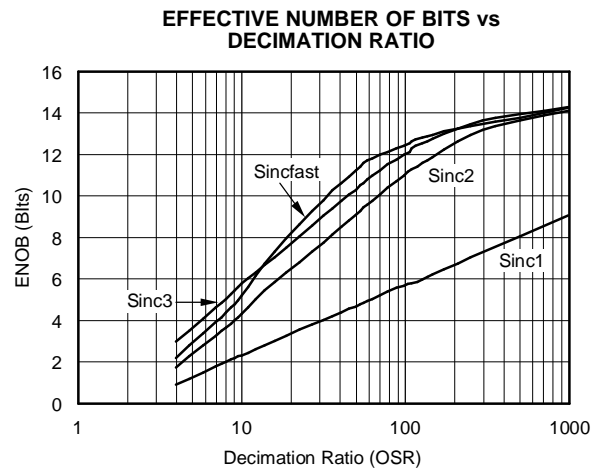

Figure 15.

TYPICAL CHARACTERISTICS (continued)

At 25°C, $AV_{DD} = BV_{DD} = +5V$, $V_{REF} = \text{internal } +2.5V$, Mode 3, MCLK input = 20MHz, differential input voltage = 200mV_{pp}, common-mode voltage = 1.4V, and 16-bit Sinc³ filter with OSR = 256, unless otherwise noted.

SPURIOUS-FREE DYNAMIC RANGE AND TOTAL HARMONIC DISTORTION vs FREQUENCY (Mode 1)

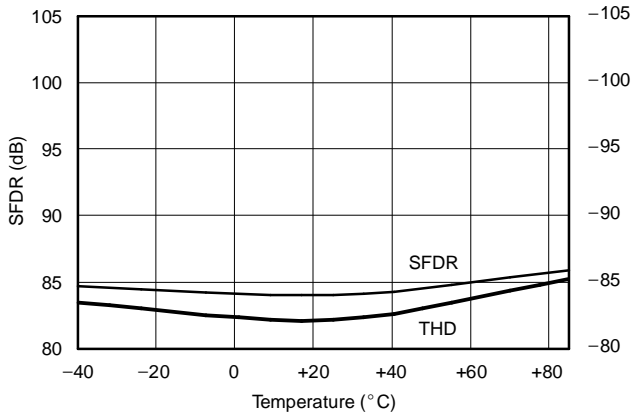

Figure 16.

SPURIOUS-FREE DYNAMIC RANGE AND TOTAL HARMONIC DISTORTION vs TEMPERATURE (Mode 3)

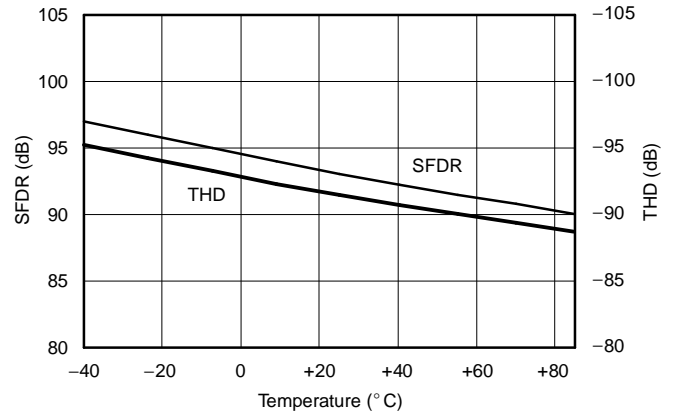

Figure 17.

SPURIOUS-FREE DYNAMIC RANGE AND TOTAL HARMONIC DISTORTION vs FREQUENCY (Mode 1)

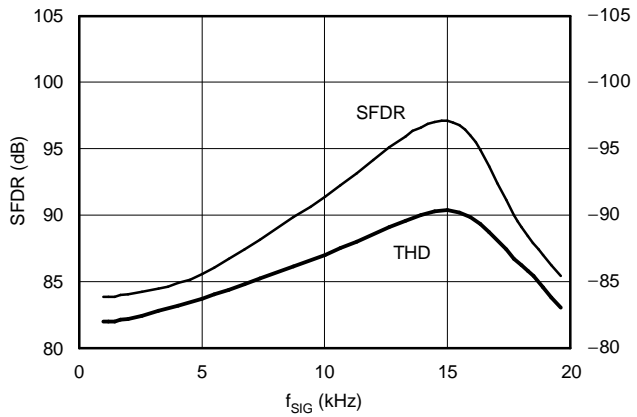

Figure 18.

SPURIOUS-FREE DYNAMIC RANGE AND TOTAL HARMONIC DISTORTION vs TEMPERATURE (Mode 3)

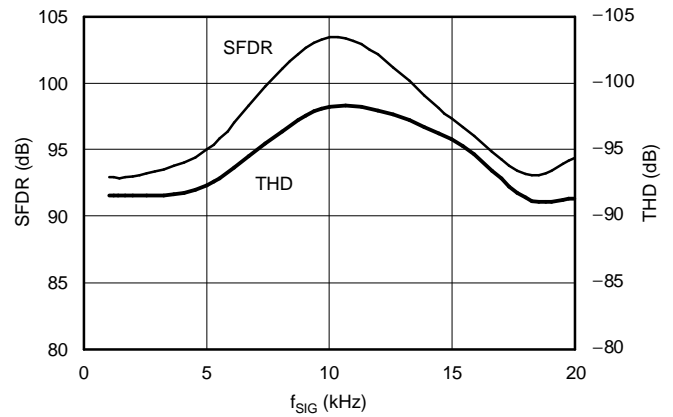

Figure 19.

TYPICAL CHARACTERISTICS (continued)

At 25°C, $AV_{DD} = BV_{DD} = +5V$, $V_{REF} = \text{internal } +2.5V$, Mode 3, MCLK input = 20MHz, differential input voltage = 200mV_{pp}, common-mode voltage = 1.4V, and 16-bit Sinc³ filter with OSR = 256, unless otherwise noted.

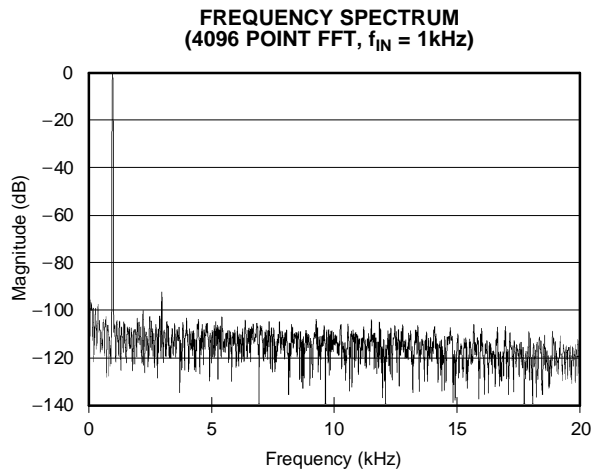

Figure 20.

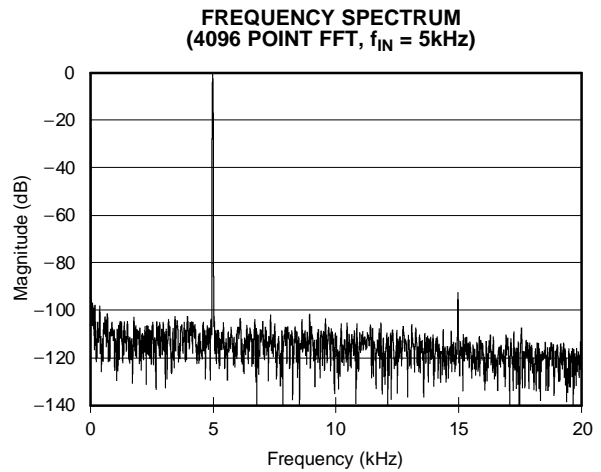

Figure 21.

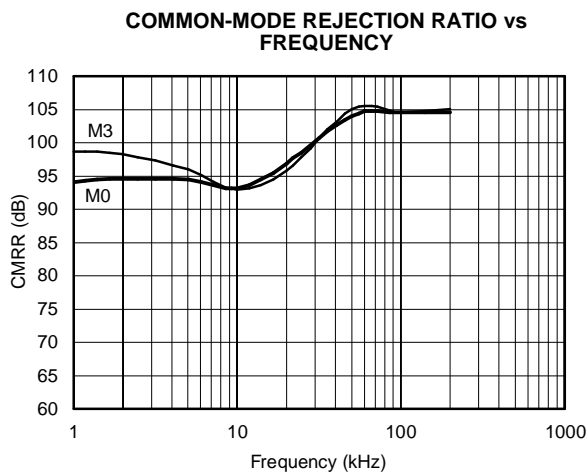

Figure 22.

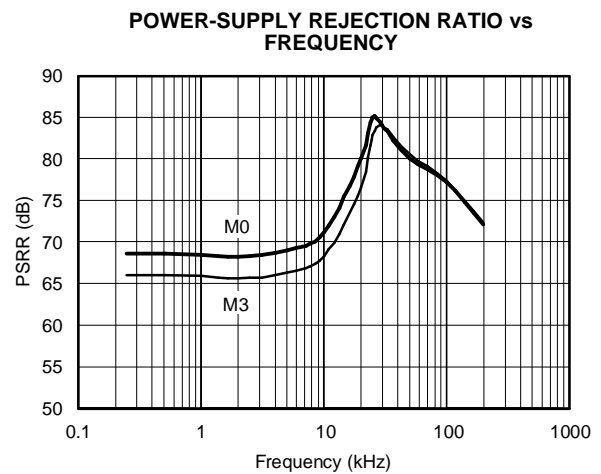

Figure 23.

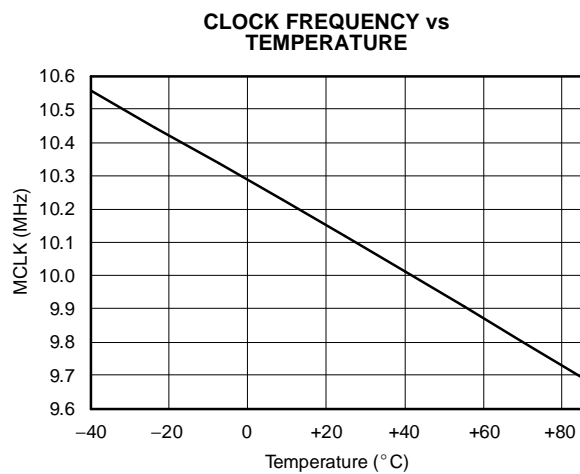

Figure 24.

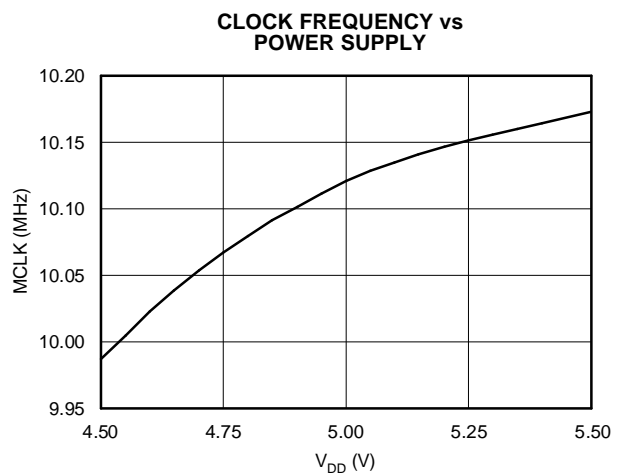

Figure 25.

TYPICAL CHARACTERISTICS (continued)

At 25°C, $AV_{DD} = BV_{DD} = +5V$, $V_{REF} = \text{internal } +2.5V$, Mode 3, MCLK input = 20MHz, differential input voltage = 200mV_{pp}, common-mode voltage = 1.4V, and 16-bit Sinc³ filter with OSR = 256, unless otherwise noted.

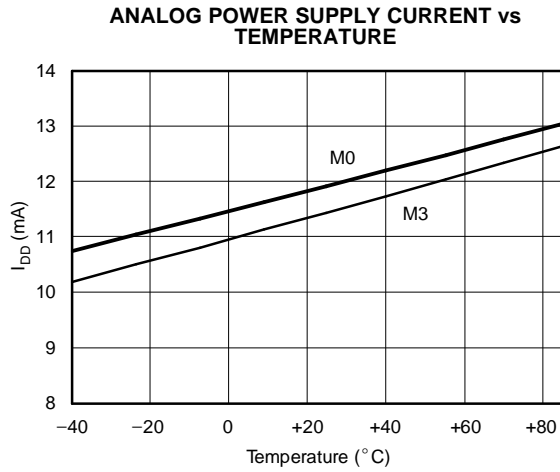

Figure 26.

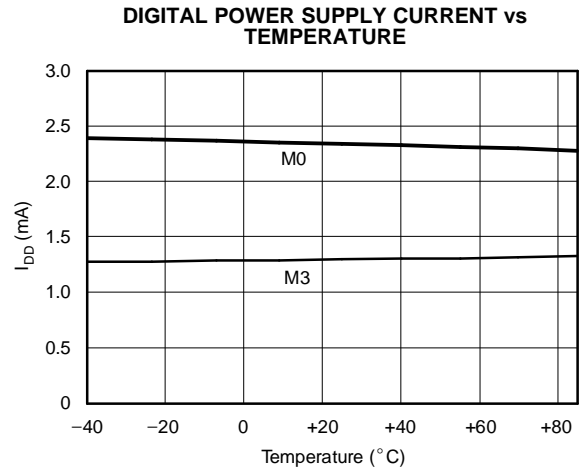

Figure 27.

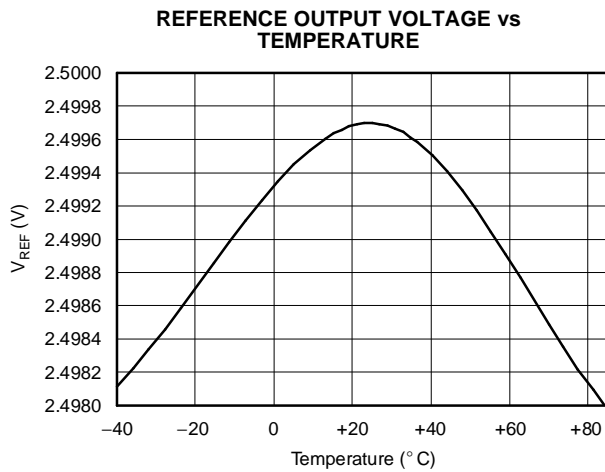

Figure 28.

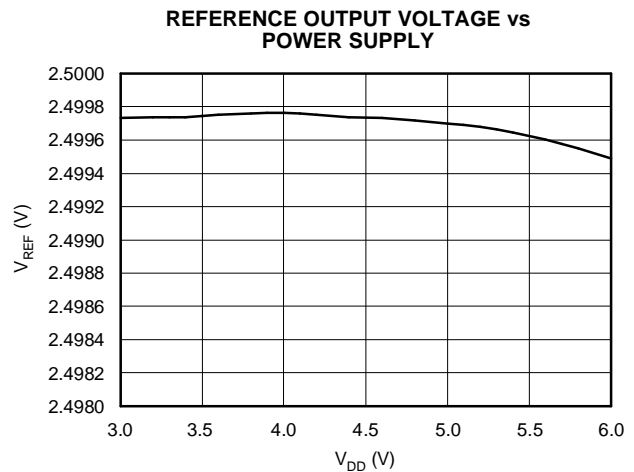

Figure 29.

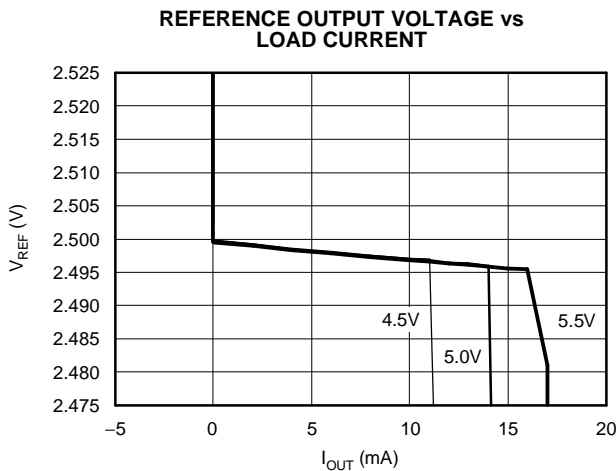

Figure 30.

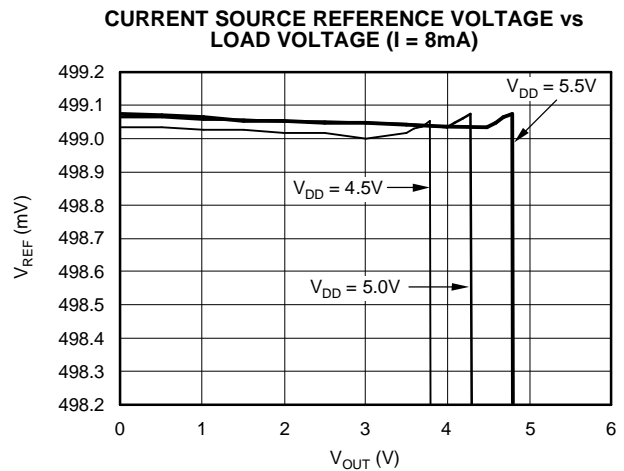

Figure 31.

TYPICAL CHARACTERISTICS (continued)

At 25°C, $AV_{DD} = BV_{DD} = +5V$, $V_{REF} = \text{internal } +2.5V$, Mode 3, MCLK input = 20MHz, differential input voltage = 200mV_{pp}, common-mode voltage = 1.4V, and 16-bit Sinc³ filter with OSR = 256, unless otherwise noted.

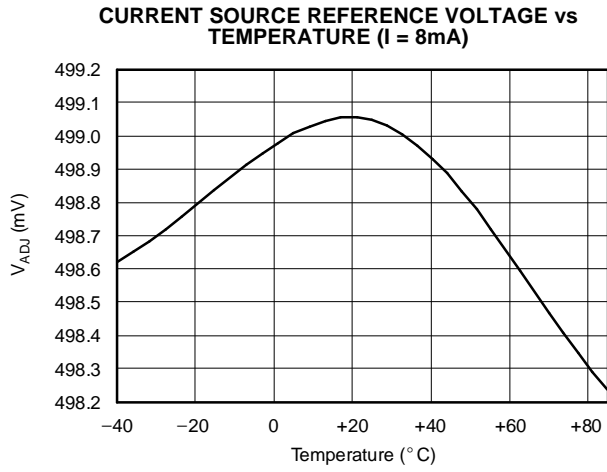

Figure 32.

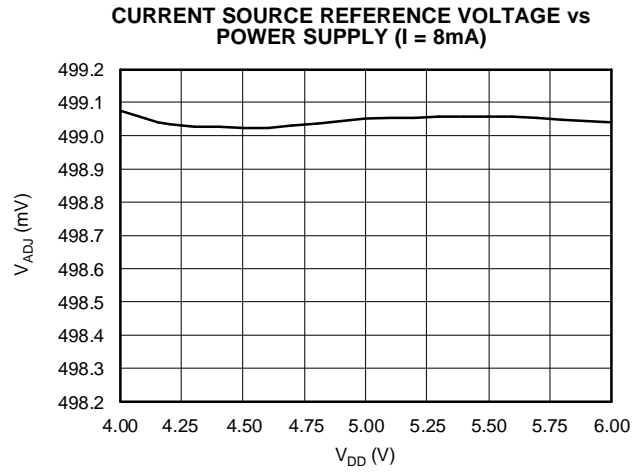

Figure 33.

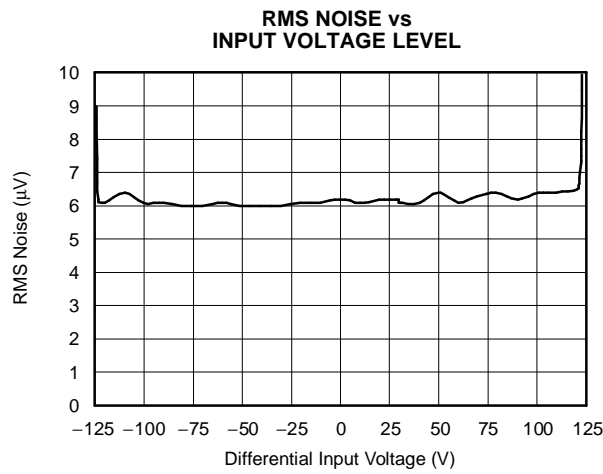

Figure 34.

APPLICATION INFORMATION

GENERAL DESCRIPTION

The ADS1208 is a 2nd-order delta-sigma modulator, which is implemented with a switched capacitor circuit. The analog input signal is continuously sampled by the modulator and compared to an internal voltage reference. A digital bit stream, which accurately represents the analog input voltage over time, appears at the output of the converter.

The ADS1208 is optimized for Hall sensors and similar applications. As a result, the full-scale input range is $\pm V_{REFIN}/20$, which is typically $\pm 125\text{mV}$. However, to achieve good noise and linearity, only 80% of this range should be used ($\pm 100\text{mV}$). The analog input pins (V_{IN+} and V_{IN-}) are internally buffered with two low-noise, high bandwidth, low offset amplifiers.

A current source is also integrated into the ADS1208 that can be used for biasing a Hall element or bridge sensor. This current can be programmed with a resistor that must be placed between AVDD and IADJ.

Additionally, the ADS1208 includes a reference voltage source with a buffered output. A reference input pin is provided as well. The voltage at the REFIN pin sets the analog input range.

The device digital interface is fully compatible with the ADS1202 and ADS1203. The ADS1208 also provides inverted outputs of MCLK and MDATA ($\overline{\text{MCLK}}$ and $\overline{\text{MDATA}}$, respectively) to increase noise immunity for the digital data transmission.

The clock source can be internal as well as external. Different clock frequencies in combination with an optional digital filter enable a variety of solutions and signal bandwidths.

Figure 5 (page 8) shows the functional block diagram with external circuitry. The Hall element is biased from the internal current source. The current is set by resistor R_{ADJ} . An offset compensation of the Hall element is enabled by the optional resistors R1 to R4. The analog inputs V_{IN+} and V_{IN-} are directly connected with the Hall element outputs. The reference input REFIN is connected to the reference output REFOUT with an optional RC low-pass filter, for additional noise filtering. For both power-supply pairs, AVDD and BVDD, decoupling capacitors of 100nF and 10 μF (respectively) are recommended.

ANALOG SECTION

Modulator

The 2nd-order modulator acts as a filter. The input signal is low-passed while the quantization noise is shifted to higher frequencies. A digital low-pass filter

should be used at the output of the delta-sigma modulator. The primary purpose of the digital filter is to remove high-frequency noise. The secondary purpose is to convert the 1-bit data stream at a high sampling rate into a higher-bit data word at a lower rate (that is, decimation). A digital signal processor (DSP), microcontroller (μC), or field programmable gate array (FPGA) could be used to implement the digital filter.

Analog Inputs

The internal sampling capacitors present a very significant load that needs to be recharged within 50ns. The ADS1208 provides two input buffers to decouple the sampling capacitors from the pins (V_{IN+} , V_{IN-}). These buffers provide a high bandwidth (typically, 50MHz) at a low noise and low offset. This configuration improves the system performance significantly, if the input source has a high impedance in the $\text{k}\Omega$ range. A source impedance in this range without buffers would decrease THD and linearity significantly, and would also cause a gain error that changes with supply or temperature.

The input buffers have an auto zero function to reduce the input offset. The auto zero switches of the input buffers may apply a glitch of 10fC to 50fC to the signal source in each clock cycle. For this reason, placing a 1nF capacitor between the inputs is recommended, if the source impedance is larger than 500 Ω . See Figure 35 for the equivalent input circuit, including the protection diodes.

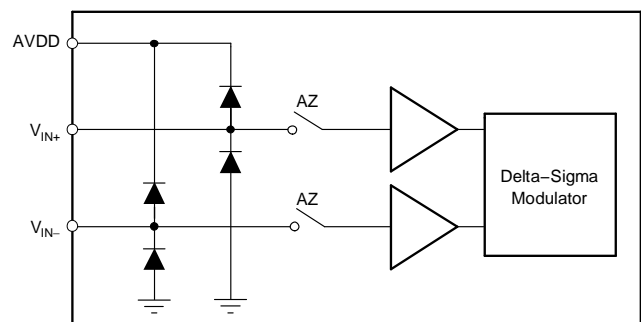

Figure 35. Equivalent Input Circuit

Internal Reference

The ADS1208 includes a 2.5V reference. The reference output is connected to the REFOUT pin via an output buffer that can source 3mA. The sink current is limited to 50 μA . The output resistance of this buffer is 0.3 Ω . The internal reference is also used to control the current source at the IOUT pin.

The ADS1208 additionally provides a REFIN pin. The applied voltage V_{REFIN} sets the gain of the internal

modulator. An external reference could vary from 0.5V to 3V. The modulator input range is defined to $\pm V_{REFIN}/20$. For a 2.5V reference, the full-scale range is $\pm 125\text{mV}$. The REFIN pin is decoupled from the modulator with a buffer.

Current Source for the Hall Element

Internal circuitry (see Figure 36) forces the IADJ pin to a potential of:

$$V_{IADJ} = AVDD - \frac{V_{REFOUT}}{5}$$

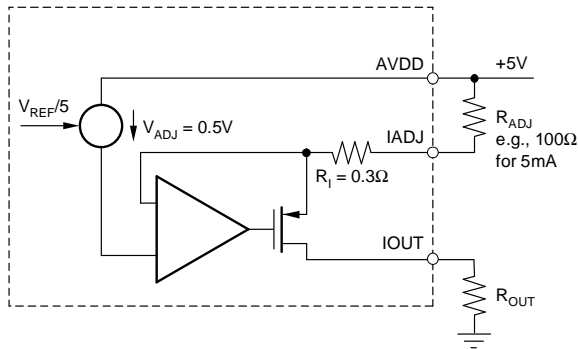

Figure 36. Current Source

This means that the voltage drop of the resistor R_{ADJ} is equal to the current source reference V_{ADJ} .

$$V_{ADJ} = \frac{V_{REFOUT}}{5} = 0.5 \text{ V}$$

With resistor R_{ADJ} placed between AVDD and IADJ, a current of:

$$I_{OUT} = \frac{V_{REFOUT}}{5 \cdot (R_{ADJ} + 0.3\Omega)}$$

is sourced out of the IOOUT pin. The current should be set between 1mA and 8mA. However, it is also possible to leave the pin open. As the Hall voltage is directly proportional to this current, the input voltage to the modulator V_{IN} is directly proportional to the internal reference voltage V_{REFOUT} . As the filtered digital output data word Y_{OUT} from the modulator is

also directly proportional to the reference voltage, the drift of the reference is actually cancelled out. Be aware that this is only the case if the application is using IOOUT to drive the Hall sensor and if REFIN is connected to REFOUT.

$$Y_{OUT} \sim \frac{1}{R_{ADJ}}$$

This means that trimming the resistor can calibrate the gain of the entire system. The resistor can be chosen to be stable over temperature, or to compensate any temperature behavior of the Hall sensor.

DIGITAL OUTPUT

A differential analog input signal of 0V ideally produces a stream of 1s and 0s that are high 50% of the time and low 50% of the time. A differential analog input of +100mV produces a stream of 1s and 0s that are high 80% of the time. A differential analog input of -100mV produces a stream of 1s and 0s that are high 20% of the time. The input voltage versus the output modulator signal is shown in Figure 37.

DIGITAL INTERFACE

Introduction

The analog signal that is connected to the input of the delta-sigma modulator is converted using the clock signal that is applied to the modulator. The result of the conversion, or modulation, is the output signal MDATA from the delta-sigma modulator. In most applications, the two standard signals (MCLK and MDATA) are provided from the modulator to an ASIC, FPGA, DSP, or μC (each with an implemented filter, respectively). A single wire interface is provided in Mode 2, where the data stream is Manchester encoded. This configuration reduces the costs for galvanic isolation.

The interface also provides the inverted outputs $\overline{\text{MDATA}}$ and $\overline{\text{MCLK}}$ for the signals MDATA and MCLK, respectively. These inverted outputs are useful for systems with high common-mode noise at the digital data transmission. The digital interface is specified for the voltage range of 2.7V to 5.5V.

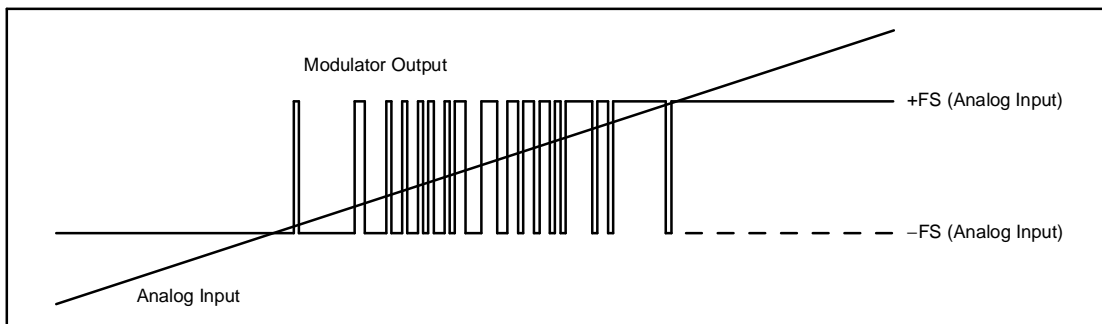

Figure 37. Analog Input vs Modulator Output of the ADS1208

Different Modes of Operation

The typical system clock of the ADS1208 is 20MHz. The system clock can be provided either from the internal 20MHz RC oscillator or from an external clock source. For this reason, the $\overline{\text{MCLK}}$ pin is bidirectional and is controlled by the mode setting. The system clock is divided by two for the modulator clock. Therefore, the default clock frequency of the modulator is 10MHz. With a possible external clock range of 1MHz to 24MHz, the modulator operates between 500kHz and 12MHz. The four modes of operation for the digital data interface are shown in Table 2.

Mode 0

In Mode 0, the internal RC oscillator is running. The data is provided at the MDATA and $\overline{\text{MDATA}}$ output pins, and the modulator clock at the MCLK and $\overline{\text{MCLK}}$ pins. The data changes at the falling edge of MCLK. Therefore, it can safely be strobed with the rising edge. See Figure 1 on page 5.

Mode 1

In Mode 1, the internal RC oscillator is running. The data is provided at the MDATA and $\overline{\text{MDATA}}$ output pins. The frequency at the MCLK and $\overline{\text{MCLK}}$ pins is equivalent to the modulator clock frequency divided by two. The data must be strobed at both the rising and falling edges of MCLK. The data at MDATA changes in the middle, between the rising and falling edge. In this mode, the frequency of both MCLK and MDATA is only 5MHz. See Figure 2 on page 5.

Mode 2

In Mode 2, the internal RC oscillator is running. The data is Manchester encoded and is provided at the MDATA and $\overline{\text{MDATA}}$ pins. There is no clock output in this mode. The MCLK and $\overline{\text{MCLK}}$ outputs are set to low. The Manchester coding allows the data transfer with only a single wire. See Figure 3 on page 6.

Mode 3

In Mode 3, the internal RC oscillator is disabled. The system clock must be provided externally at the input $\overline{\text{MCLK}}$. The system clock must have twice the frequency of the chosen modulator clock. The data is provided at the MDATA and $\overline{\text{MDATA}}$ output pins. Since the modulator runs with half the frequency of the system clock, the data changes at every other falling edge of the external clock. The data can be safely strobed at every rising edge of the MCLK output, which provides half the frequency of the system clock. This mode allows synchronous operation to any digital system or the use of modulator clocks different from 10MHz. See Figure 4 on page 6.

Filter Usage

The modulator generates only a bitstream, which is different from the digital word of an analog-to-digital converter (ADC). In order to output a digital word equivalent to the analog input voltage, the bitstream must be processed by a digital filter. A very simple filter built with minimal effort and hardware is the Sinc³ filter, shown in Equation 1:

$$H(z) = \left(\frac{1 - z^{-\text{OSR}}}{1 - z^{-1}} \right)^3 \quad (1)$$

Table 2. Operating Mode Definition and Description

MODE DEFINITION		M1	M0
Mode 0	Internal clock, synchronous data output	Low	Low
Mode 1	Internal clock, synchronous data output, half output clock frequency	Low	High
Mode 2	Internal clock, Manchester encoded data output, no clock output	High	Low
Mode 3	External clock, synchronous data output	High	High

This filter provides the best output performance at the lowest hardware size (for example, a count of digital gates). For oversampling ratios in the range of 16 to 256, the Sinc³ filter is a good choice. All characterizations in this datasheet were obtained using a Sinc³ filter with an oversampling ratio (OSR) of 256 and an output word length of 16 bits. In a Sinc³ filter response (shown in Figure 38 and Figure 39), the location of the first notch occurs at the frequency of output data rate $f_{DATA} = f_{CLK}/OSR$. The -3dB point is located at half the Nyquist frequency, or $f_{DATA}/4$. For some applications, it may be necessary to use another filter type for better frequency response. Device performance can be improved, for example, by using a cascaded filter structure. The first decimation stage can be a Sinc³ filter with a low OSR and a second stage, high-order filter.

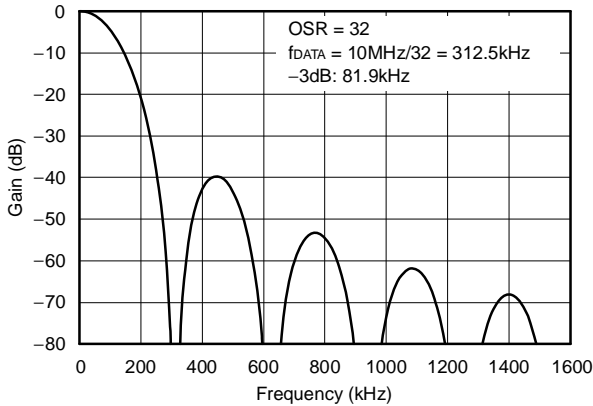

Figure 38. Frequency Response of Sinc³ Filter

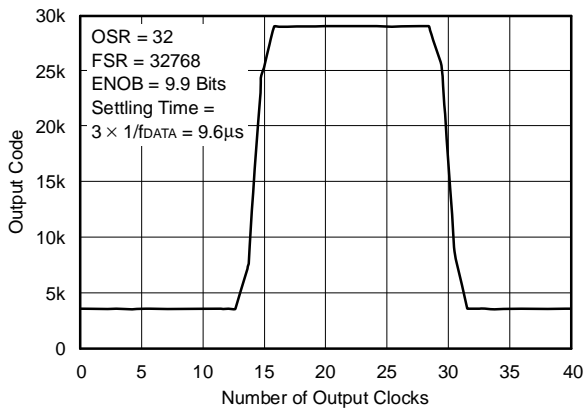

Figure 39. Pulse Response of Sinc³ Filter ($f_{MOD} = 10\text{MHz}$)

The effective number of bits (ENOB) can be used to compare the performance of ADCs and delta-sigma modulators. Figure 40 shows the ENOB of the ADS1208 with different filter types. In this datasheet, the ENOB is calculated from the SNR:

$$SNR = 1.76\text{dB} + 6.02\text{dB} \times \text{ENOB}$$

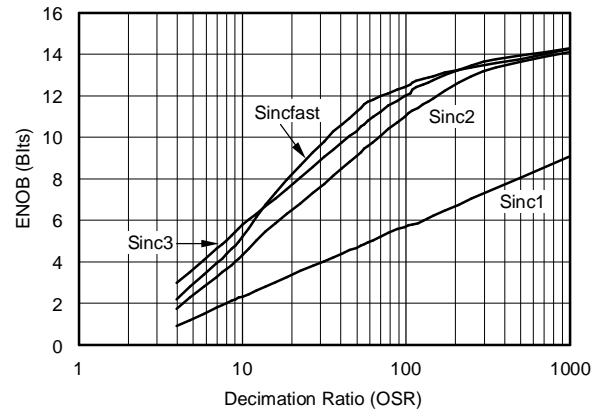

Figure 40. Measured ENOB vs OSR

In motor control applications, a very fast response time for overcurrent detection is required. There is a constraint between 1µs and 5µs with 3 bits to 7 bits of resolution. The time for full settling depends on the filter order. Therefore, the full settling of the Sinc³ filter needs three data clocks and the Sinc² filter needs two data clocks. The data clock is equal to the modulator clock divided by the OSR. For overcurrent protection, filter types other than Sinc³ might be a better choice. A good example is a Sinc² filter. Figure 41 compares the settling time of different filter types. The Sincfast is a modified Sinc² filter, as shown in Equation 2:

$$H(z) = \left(\frac{1 - z^{-OSR}}{1 - z^{-1}} \right)^2 (1 + z^{-2 \cdot OSR}) \tag{2}$$

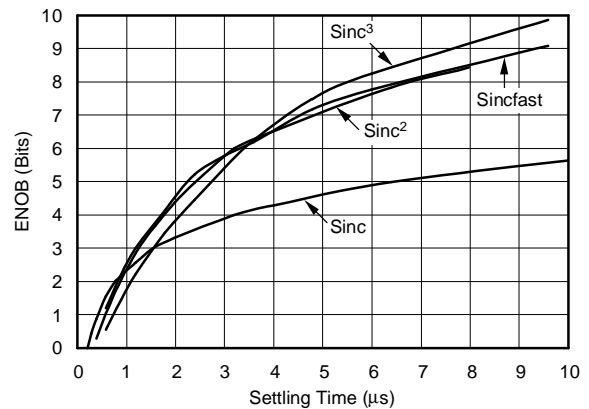

Figure 41. Measured ENOB vs Settling Time

For more information, see application note [SBAA094, Combining the ADS1202 with an FPGA Digital Filter for Current Measurement in Motor Control Applications](#), available for download at www.ti.com.

LAYOUT CONSIDERATIONS

Power Supplies

The ADS1208 has two power supplies, AVDD and BVDD. If there are separate analog and digital power supplies on the board, a good design approach is to have AVDD connected to the analog and BVDD to the digital power supply. Another possible approach to control noise is the use of a resistor on the power supply. The connection can be made between the ADS1208 power supply pins via a 5Ω resistor. The combination of this resistor and the decoupling capacitors between the power supply pins AVDD and AGND provides some filtering. The analog supply must be well-regulated and offer low noise. For designs requiring higher resolution from the ADS1208, power-supply rejection will be a concern. The digital power supply has high-frequency noise that can be coupled into the analog portion of the ADS1208. This noise can originate from switching power supplies, microprocessors, or DSPs. High-frequency noise will generally be rejected by the external digital filter at integer multiples of MCLK. Just below and above these frequencies, noise will alias back into the passband of the digital filter, affecting the conversion result. Inputs to the ADS1208, such as V_{IN+} , V_{IN-} , and MCLK should not be present before the power supply is turned on. Violating this condition could cause latch-up. If these signals are present before the supply is turned on, series resistors should be used to limit the input current. Additional user testing may be necessary in order to determine the appropriate connection between the ADS1208 and different power supplies.

Grounding

Analog and digital sections of the system design must be carefully and cleanly partitioned. Each section should have its own ground plane, with no overlap between them. Do not join the ground planes. Instead, connect the two planes with a moderate signal trace underneath the modulator. For multiple modulators, connect the two ground planes as close as possible to one central location for all of the modulators. In some cases, experimentation may be required to find the best point to connect the two planes together.

Decoupling

Good decoupling practices must be used for the ADS1208 and for all components in the system design. All decoupling capacitors, specifically the $0.1\mu\text{F}$ ceramic capacitors, must be placed as close as possible to the respective pin being decoupled. A $1\mu\text{F}$ and $10\mu\text{F}$ capacitor, in parallel with the $0.1\mu\text{F}$ ceramic capacitor, can be used to decouple AVDD to AGND. At least one $0.1\mu\text{F}$ ceramic capacitor must be used to decouple BVDD to BGND, as well as for the digital supply on each digital component

It is highly recommended to place the 100nF compensation capacitor, which is connected between AVDD and AGND, directly at pins 3 and 6. Otherwise, current glitches from the internal circuitry can cause glitches in the supply, which again causes jitter on the internal clock signal. This jitter degrades the noise performance of the ADS1208. The input signals V_{IN+} and V_{IN-} can be routed underneath this capacitor.

PACKAGING INFORMATION

Orderable part number	Status (1)	Material type (2)	Package Pins	Package qty Carrier	RoHS (3)	Lead finish/ Ball material (4)	MSL rating/ Peak reflow (5)	Op temp (°C)	Part marking (6)
ADS1208IPW	Last Time Buy	Production	TSSOP (PW) 16	90 TUBE	Yes	NIPDAU	Level-2-260C-1 YEAR	-40 to 85	AZ1208I
ADS1208IPW.B	Last Time Buy	Production	TSSOP (PW) 16	90 TUBE	Yes	NIPDAU	Level-2-260C-1 YEAR	-40 to 85	AZ1208I

(1) **Status:** For more details on status, see our [product life cycle](#).

(2) **Material type:** When designated, preproduction parts are prototypes/experimental devices, and are not yet approved or released for full production. Testing and final process, including without limitation quality assurance, reliability performance testing, and/or process qualification, may not yet be complete, and this item is subject to further changes or possible discontinuation. If available for ordering, purchases will be subject to an additional waiver at checkout, and are intended for early internal evaluation purposes only. These items are sold without warranties of any kind.

(3) **RoHS values:** Yes, No, RoHS Exempt. See the [TI RoHS Statement](#) for additional information and value definition.

(4) **Lead finish/Ball material:** Parts may have multiple material finish options. Finish options are separated by a vertical ruled line. Lead finish/Ball material values may wrap to two lines if the finish value exceeds the maximum column width.

(5) **MSL rating/Peak reflow:** The moisture sensitivity level ratings and peak solder (reflow) temperatures. In the event that a part has multiple moisture sensitivity ratings, only the lowest level per JEDEC standards is shown. Refer to the shipping label for the actual reflow temperature that will be used to mount the part to the printed circuit board.

(6) **Part marking:** There may be an additional marking, which relates to the logo, the lot trace code information, or the environmental category of the part.

Multiple part markings will be inside parentheses. Only one part marking contained in parentheses and separated by a "~" will appear on a part. If a line is indented then it is a continuation of the previous line and the two combined represent the entire part marking for that device.

Important Information and Disclaimer: The information provided on this page represents TI's knowledge and belief as of the date that it is provided. TI bases its knowledge and belief on information provided by third parties, and makes no representation or warranty as to the accuracy of such information. Efforts are underway to better integrate information from third parties. TI has taken and continues to take reasonable steps to provide representative and accurate information but may not have conducted destructive testing or chemical analysis on incoming materials and chemicals. TI and TI suppliers consider certain information to be proprietary, and thus CAS numbers and other limited information may not be available for release.

In no event shall TI's liability arising out of such information exceed the total purchase price of the TI part(s) at issue in this document sold by TI to Customer on an annual basis.

TUBE

*All dimensions are nominal

Device	Package Name	Package Type	Pins	SPQ	L (mm)	W (mm)	T (μm)	B (mm)
ADS1208IPW	PW	TSSOP	16	90	530	10.2	3600	3.5
ADS1208IPW.B	PW	TSSOP	16	90	530	10.2	3600	3.5

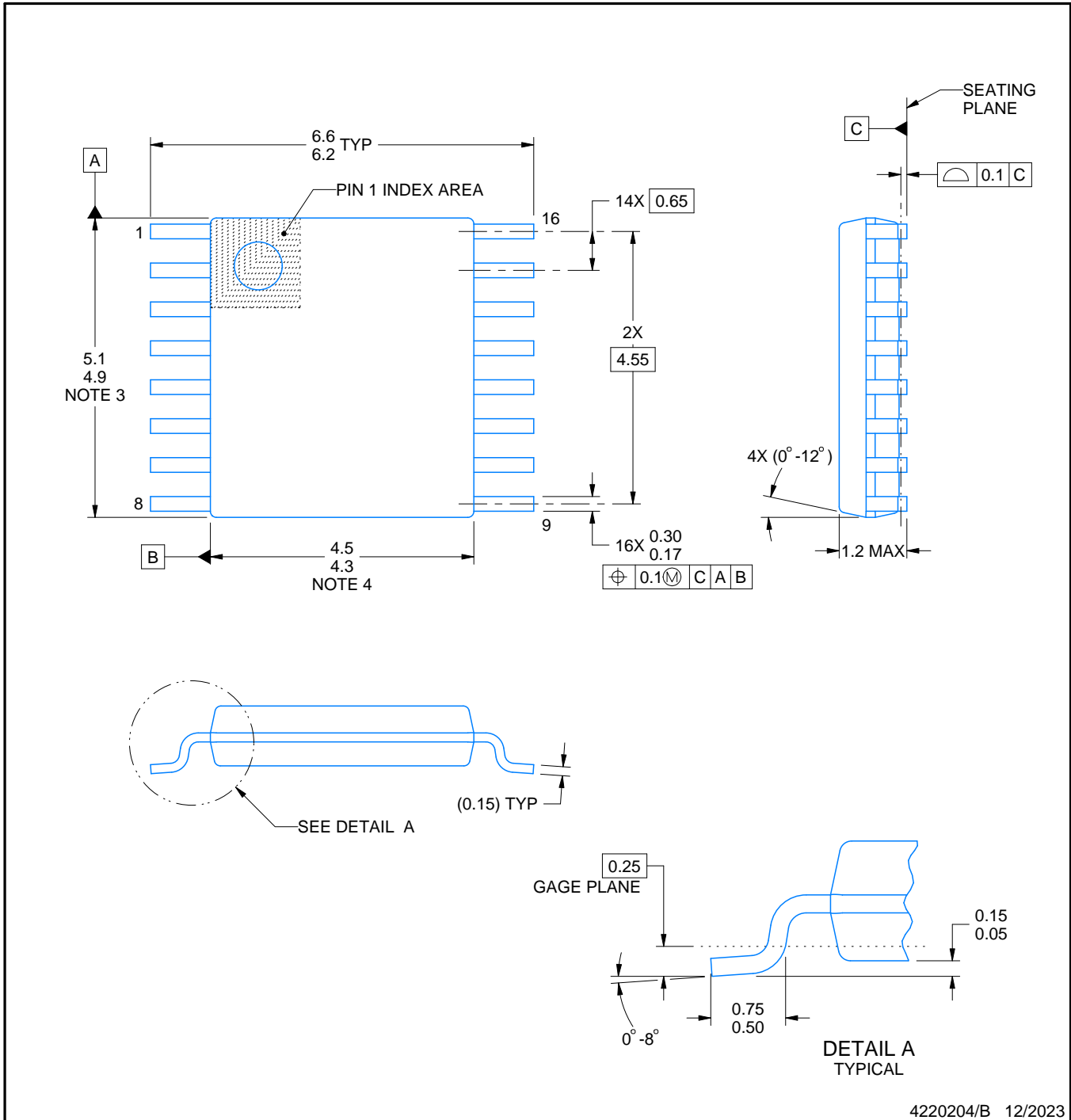

4220204/B 12/2023

NOTES:

1. All linear dimensions are in millimeters. Any dimensions in parenthesis are for reference only. Dimensioning and tolerancing per ASME Y14.5M.
2. This drawing is subject to change without notice.
3. This dimension does not include mold flash, protrusions, or gate burrs. Mold flash, protrusions, or gate burrs shall not exceed 0.15 mm per side.
4. This dimension does not include interlead flash. Interlead flash shall not exceed 0.25 mm per side.
5. Reference JEDEC registration MO-153.

EXAMPLE BOARD LAYOUT

PW0016A

TSSOP - 1.2 mm max height

SMALL OUTLINE PACKAGE

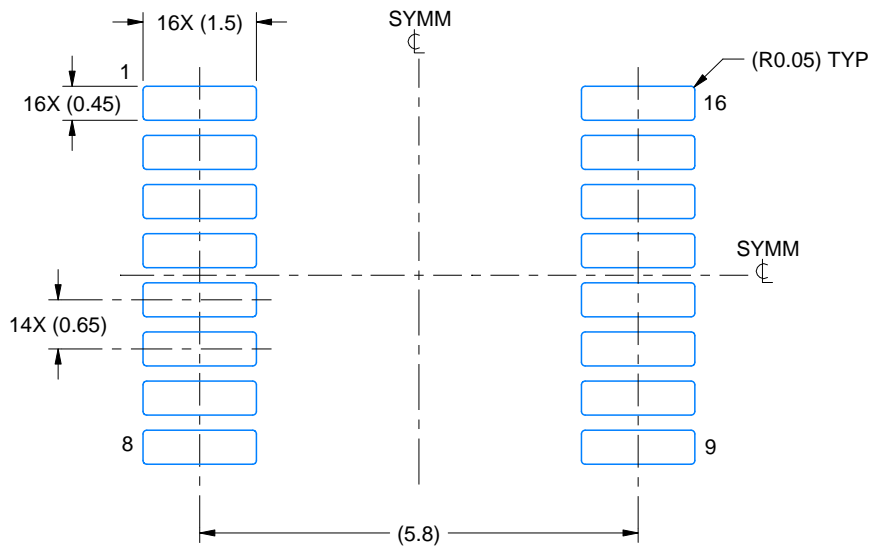

LAND PATTERN EXAMPLE
EXPOSED METAL SHOWN
SCALE: 10X

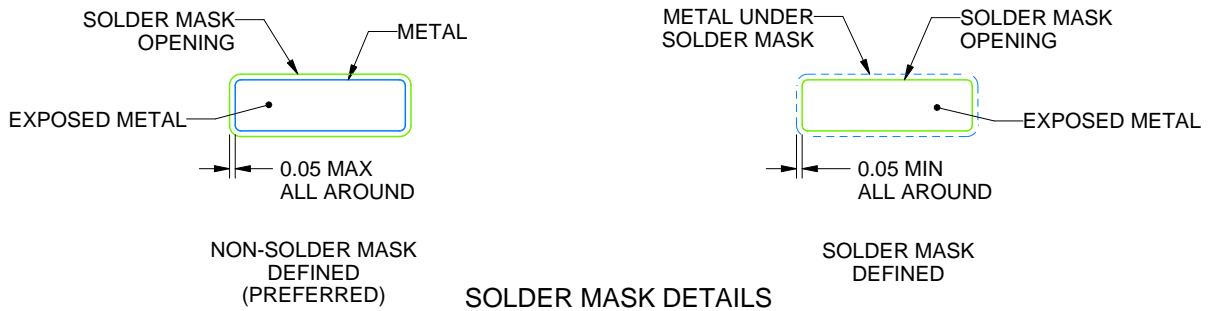

4220204/B 12/2023

NOTES: (continued)

- 6. Publication IPC-7351 may have alternate designs.
- 7. Solder mask tolerances between and around signal pads can vary based on board fabrication site.

EXAMPLE STENCIL DESIGN

PW0016A

TSSOP - 1.2 mm max height

SMALL OUTLINE PACKAGE

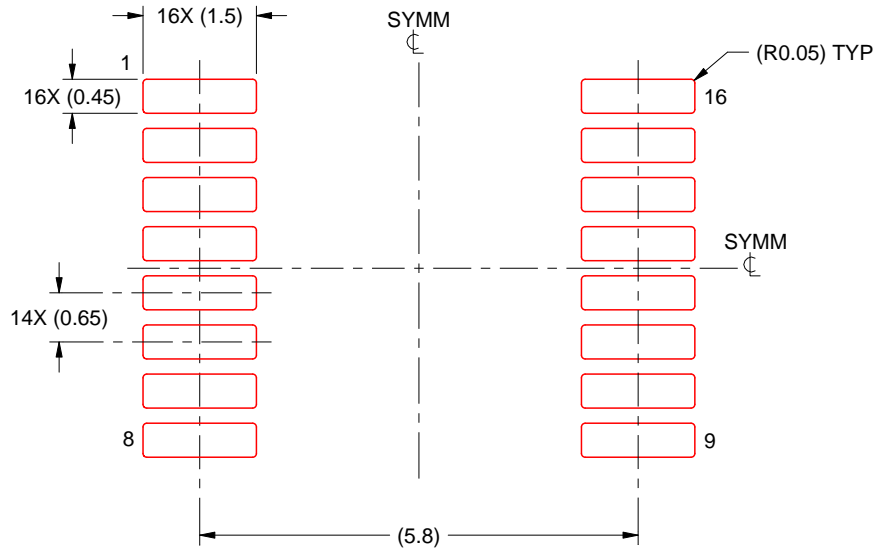

SOLDER PASTE EXAMPLE
BASED ON 0.125 mm THICK STENCIL
SCALE: 10X

4220204/B 12/2023

NOTES: (continued)

8. Laser cutting apertures with trapezoidal walls and rounded corners may offer better paste release. IPC-7525 may have alternate design recommendations.
9. Board assembly site may have different recommendations for stencil design.

IMPORTANT NOTICE AND DISCLAIMER

TI PROVIDES TECHNICAL AND RELIABILITY DATA (INCLUDING DATASHEETS), DESIGN RESOURCES (INCLUDING REFERENCE DESIGNS), APPLICATION OR OTHER DESIGN ADVICE, WEB TOOLS, SAFETY INFORMATION, AND OTHER RESOURCES "AS IS" AND WITH ALL FAULTS, AND DISCLAIMS ALL WARRANTIES, EXPRESS AND IMPLIED, INCLUDING WITHOUT LIMITATION ANY IMPLIED WARRANTIES OF MERCHANTABILITY, FITNESS FOR A PARTICULAR PURPOSE OR NON-INFRINGEMENT OF THIRD PARTY INTELLECTUAL PROPERTY RIGHTS.

These resources are intended for skilled developers designing with TI products. You are solely responsible for (1) selecting the appropriate TI products for your application, (2) designing, validating and testing your application, and (3) ensuring your application meets applicable standards, and any other safety, security, regulatory or other requirements.

These resources are subject to change without notice. TI grants you permission to use these resources only for development of an application that uses the TI products described in the resource. Other reproduction and display of these resources is prohibited. No license is granted to any other TI intellectual property right or to any third party intellectual property right. TI disclaims responsibility for, and you fully indemnify TI and its representatives against any claims, damages, costs, losses, and liabilities arising out of your use of these resources.

TI's products are provided subject to [TI's Terms of Sale](#), [TI's General Quality Guidelines](#), or other applicable terms available either on [ti.com](#) or provided in conjunction with such TI products. TI's provision of these resources does not expand or otherwise alter TI's applicable warranties or warranty disclaimers for TI products. Unless TI explicitly designates a product as custom or customer-specified, TI products are standard, catalog, general purpose devices.

TI objects to and rejects any additional or different terms you may propose.

Copyright © 2026, Texas Instruments Incorporated

Last updated 10/2025