

# bq2438x Overvoltage and Overcurrent Protection IC and Li+ Charger Front-End Protection IC With LDO Mode

## 1 Features

- Input Overvoltage Protection
- Accurate Battery Overvoltage Protection
- Output Short-Circuit Protection
- Soft-Start to Prevent Inrush Currents
- Soft-Stop to Prevent Voltage Spikes
- Maximum Input Voltage of 30 V
- Supports up to 1.7-A Load Current
- Thermal Shutdown
- Enable Function
- Fault Status Indication
- Small 2 mm × 2 mm 8-Pin WSON Package

## 2 Applications

- Smart Phones, Mobile Phones
- PDAs
- MP3 Players
- Low-Power Handheld Devices

## 3 Description

The bq2438x family of devices are charger front-end integrated circuits (ICs) designed to provide protection to Li-ion batteries from failures of the charging circuit. The device continuously monitors the input voltage and battery voltage. The device operates like a linear regulator, maintaining a 5.5-V (bq24380) or 5-V (bq24381, bq24382) output with input voltages up to the Input overvoltage threshold. During input overvoltage conditions, the device immediately turns off the internal pass FET disconnecting the charging circuit from the damaging input source. Additionally, if the battery voltage rises to unsafe levels while charging, power is removed from the system. The device checks for short-circuit or overload conditions at its output when turning the pass FET on, and if it finds unsafe conditions, it switches off and then rechecks the conditions. Additionally, the device also monitors its die temperature and switches off if it exceeds 140°C.

When the device is controlled by a processor, the device provides status information about fault conditions to the host.

### Device Information<sup>(1)</sup>

PART NUMBER	PACKAGE	BODY SIZE (NOM)
bq24380	WSON (8)	2.00 mm × 2.00 mm
bq24381		
bq24382		

(1) For all available packages, see the orderable addendum at the end of the data sheet.

### Simplified Schematic

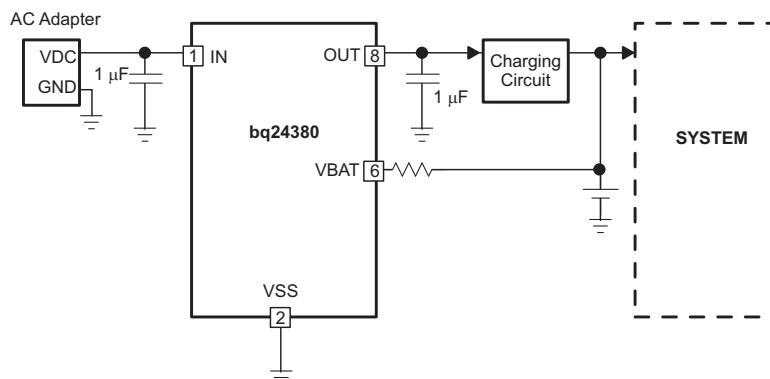

## Table of Contents

<b>1 Features</b> .....	<b>1</b>	7.3 Feature Description .....	<b>10</b>
<b>2 Applications</b> .....	<b>1</b>	7.4 Device Functional Modes .....	<b>11</b>
<b>3 Description</b> .....	<b>1</b>	<b>8 Application and Implementation</b> .....	<b>12</b>
<b>4 Revision History</b> .....	<b>2</b>	8.1 Application Information .....	<b>12</b>
<b>5 Pin Configuration and Functions</b> .....	<b>3</b>	8.2 Typical Application .....	<b>12</b>
<b>6 Specifications</b> .....	<b>4</b>	<b>9 Power Supply Recommendations</b> .....	<b>15</b>
6.1 Absolute Maximum Ratings .....	<b>4</b>	<b>10 Layout</b> .....	<b>15</b>
6.2 ESD Ratings .....	<b>4</b>	10.1 Layout Guidelines .....	<b>15</b>
6.3 Recommended Operating Conditions .....	<b>4</b>	10.2 Layout Example .....	<b>15</b>
6.4 Thermal Information .....	<b>4</b>	<b>11 Device and Documentation Support</b> .....	<b>16</b>
6.5 Electrical Characteristics .....	<b>5</b>	11.1 Related Links .....	<b>16</b>
6.6 Timing Requirements .....	<b>6</b>	11.2 Community Resources .....	<b>16</b>
6.7 Typical Characteristics .....	<b>7</b>	11.3 Trademarks .....	<b>16</b>
<b>7 Detailed Description</b> .....	<b>9</b>	11.4 Electrostatic Discharge Caution .....	<b>16</b>
7.1 Overview .....	<b>9</b>	11.5 Glossary .....	<b>16</b>
7.2 Functional Block Diagram .....	<b>9</b>	<b>12 Mechanical, Packaging, and Orderable Information</b> .....	<b>16</b>

## 4 Revision History

NOTE: Page numbers for previous revisions may differ from page numbers in the current version.

<b>Changes from Revision B (March 2009) to Revision C</b>	<b>Page</b>
• Added ESD Ratings table, Thermal Information, Timing Requirements, Functional Block Diagram, Design Requirements, Application Curves, Power Supply Recommendations, Layout Example, Device and Documentation Support, and Mechanical, Packaging, and Orderable Information .....	<b>1</b>
• Changed SON to WSON throughout the document .....	<b>1</b>
• Changed From: "the bq2430x $\overline{CE}$ pin." To: "the bq2438x $\overline{CE}$ pin." in <a href="#">Selection of <math>R_{(BAT)}</math></a> .....	<b>13</b>
• Moved Figures 1 through 8 from Typical Characteristics to Application Curves section .....	<b>13</b>

<b>Changes from Revision A (May 2008) to Revision B</b>	<b>Page</b>
• Added device bq24382 to the datasheet .....	<b>1</b>
• Added the bq24382 option to $I_{DD}$ in the <a href="#">Electrical Characteristics</a> .....	<b>5</b>
• Added the bq24382 option to $V_{O(REG)}$ in the <a href="#">Electrical Characteristics</a> .....	<b>5</b>
• Added the bq24382 option to $V_{OVP}$ in the <a href="#">Electrical Characteristics</a> .....	<b>5</b>
• Added the bq24382 option to $V_{hys(OVP)}$ in the <a href="#">Electrical Characteristics</a> .....	<b>5</b>

<b>Changes from Original (April 2008) to Revision A</b>	<b>Page</b>
• Changed <a href="#">Figure 4</a> .....	<b>7</b>
• Changed <a href="#">Figure 5</a> .....	<b>7</b>
• Added <a href="#">Figure 9</a> .....	<b>7</b>

## 5 Pin Configuration and Functions

**DSG Package  
8-Pin WSON With Exposed Thermal Pad  
Top View**

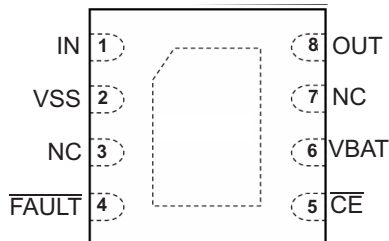

### Pin Functions

PIN		I/O	DESCRIPTION
NAME	NO.		
$\overline{\text{CE}}$	5	I	Active-low chip enable input. Connect $\overline{\text{CE}} = \text{HI}$ to turn the input pass FET off. Connect $\overline{\text{CE}} = \text{LOW}$ to turn the internal pass FET on and connect the input to the charging circuitry. $\overline{\text{CE}}$ is Internally pulled down, approximately 200 k $\Omega$ .
$\overline{\text{FAULT}}$	4	O	Open-drain device status output. $\overline{\text{FAULT}}$ is pulled to VSS internally when the input pass FET has been turned off due to input overvoltage or output short-circuit conditions, an overtemperature condition, or because the battery voltage is outside safe limits. $\overline{\text{FAULT}}$ is high impedance during normal operation.
IN	1	I	Input power, connected to external DC supply. Bypass IN to VSS with a ceramic capacitor (1 $\mu\text{F}$ minimum)
NC	3, 7		Do not connect to any external circuits. These pins may have internal connections used for test purposes.
OUT	8	O	Output terminal to the charging system. Bypass OUT to VSS with a ceramic capacitor (1 $\mu\text{F}$ minimum)
VBAT	6	I	Battery voltage sense input. Connected to pack positive terminal through a 100-k $\Omega$ resistor.
VSS	2	–	Ground terminal. Connect to the thermal pad and to the ground rail of the circuit.
Thermal PAD			There is an internal electrical connection between the exposed thermal pad and the VSS pin of the device. The thermal pad must be connected to the same potential as the VSS pin on the printed-circuit board. Do not use the thermal pad as the primary ground input for the device. VSS pin must be connected to ground at all times.

## 6 Specifications

### 6.1 Absolute Maximum Ratings

over operating free-air temperature range (unless otherwise noted) All voltage values are with respect to the network ground terminal unless otherwise noted.<sup>(1)</sup>

			MIN	MAX	UNIT
V <sub>I</sub>	Input voltage	IN (with respect to VSS)	-0.3	30	V
		OUT (with respect to VSS)	-0.3	12	
		$\overline{\text{FAULT}}$ , $\overline{\text{CE}}$ , VBAT (with respect to VSS)	-0.3	7	
I <sub>OUTmax</sub>	Output source current	OUT		2	A
	Output sink current	$\overline{\text{FAULT}}$		15	mA
T <sub>J</sub>	Junction temperature		-40	150	°C
T <sub>stg</sub>	Storage temperature		-65	150	°C

- (1) Stresses beyond those listed under *Absolute Maximum Ratings* may cause permanent damage to the device. These are stress ratings only, which do not imply functional operation of the device at these or any other conditions beyond those indicated under *Recommended Operating Conditions*. Exposure to absolute-maximum-rated conditions for extended periods may affect device reliability.

### 6.2 ESD Ratings

			VALUE	UNIT
V <sub>(ESD)</sub>	Electrostatic discharge	Human-body model (HBM), per ANSI/ESDA/JEDEC JS-001 <sup>(1)</sup>	±2000	V
		Charged-device model (CDM), per JEDEC specification JESD22-C101 <sup>(2)</sup>	±500	

- (1) JEDEC document JEP155 states that 500-V HBM allows safe manufacturing with a standard ESD control process.  
 (2) JEDEC document JEP157 states that 250-V CDM allows safe manufacturing with a standard ESD control process.

### 6.3 Recommended Operating Conditions

			MIN	NOM	MAX	UNIT
V <sub>I</sub>	IN voltage range		3.3		30	V
I <sub>O</sub>	Output current, OUT pin				1.7	A
T <sub>J</sub>	Junction temperature		-40		125	°C

### 6.4 Thermal Information

THERMAL METRIC <sup>(1)</sup>		bq2438x	UNIT
		DSG (WSON)	
		8 PINS	
R <sub>θJA</sub>	Junction-to-ambient thermal resistance	64	°C/W
R <sub>θJC(top)</sub>	Junction-to-case (top) thermal resistance	84.1	°C/W
R <sub>θJB</sub>	Junction-to-board thermal resistance	33.9	°C/W
ψ <sub>JT</sub>	Junction-to-top characterization parameter	1.9	°C/W
ψ <sub>JB</sub>	Junction-to-board characterization parameter	34.3	°C/W
R <sub>θJC(bot)</sub>	Junction-to-case (bottom) thermal resistance	5.8	°C/W

- (1) For more information about traditional and new thermal metrics, see the *Semiconductor and IC Package Thermal Metrics* application report, [SPRA953](#).

## 6.5 Electrical Characteristics

 Over junction temperature range  $-40^{\circ}\text{C} \leq T_J \leq 125^{\circ}\text{C}$  and recommended supply voltage (unless otherwise noted)

PARAMETER		TEST CONDITIONS	MIN	TYP	MAX	UNIT	
<b>IN</b>							
UVLO	Undervoltage lock-out, input power detected threshold	$\overline{\text{CE}} = \text{LO or HI}, V_{\text{IN}}: 0 \text{ V} \rightarrow 3 \text{ V}$	2.5		2.8	V	
$V_{\text{hys(UVLO)}}$	Hysteresis on UVLO	$\overline{\text{CE}} = \text{LO or HI}, V_{\text{IN}}: 3 \text{ V} \rightarrow 0 \text{ V}$	200		300	mV	
$I_{\text{DD}}$	Operating current	$\overline{\text{CE}} = \text{LO}$ , no load on OUT pin, $V_{\text{IN}} = 5 \text{ V}$				$\mu\text{A}$	
		bq24380			250		
		bq24381			300		
		bq24382			300		
$I_{\text{STDBY}}$	Standby current	$\overline{\text{CE}} = \text{HI}, V_{\text{IN}} = 5.5 \text{ V}$			100	$\mu\text{A}$	
<b>INPUT-TO-OUTPUT CHARACTERISTICS</b>							
$V_{\text{DO}}$	Dropout voltage IN to OUT	$\overline{\text{CE}} = \text{LO}, V_{\text{IN}} = 5 \text{ V}, I_{\text{(OUT)}} = 1 \text{ A}$			280	mV	
$I_{\text{OFF}}$	Q1 off-state leakage current	$\overline{\text{CE}} = \text{HI}, V_{\text{IN}} = 5.5 \text{ V}$			10	$\mu\text{A}$	
<b>INPUT OVERVOLTAGE PROTECTION</b>							
$V_{\text{O(REG)}}$	Output voltage	$\overline{\text{CE}} = \text{LO}, V_{\text{IN}} = 6 \text{ V}$	bq24380	5.3	5.5	5.7	V
			bq24381	4.8	5	5.2	
			bq24382	4.8	5	5.2	
$V_{\text{OVP}}$	Input overvoltage protection threshold	$\overline{\text{CE}} = \text{LO}, V_{\text{IN}}: 5 \text{ V} \rightarrow 8 \text{ V}$	bq24380	6.1	6.3	6.5	V
			bq24831	6.88	7.1	7.31	
			bq24382	10.17	10.5	10.83	
$V_{\text{hys(OVP)}}$	Hysteresis on OVP	$\overline{\text{CE}} = \text{LO or HI}, V_{\text{IN}}: 7 \text{ V} \rightarrow 5 \text{ V}$	bq24380	25		110	mV
		$\overline{\text{CE}} = \text{LO or HI}, V_{\text{IN}}: 8 \text{ V} \rightarrow 5 \text{ V}$	bq24831	25		120	
			bq24382	150		300	
<b>OUTPUT SHORT-CIRCUIT PROTECTION (ONLY at START-UP)</b>							
$I_{\text{O(SC)}}$	Short-circuit detection threshold	$3 \text{ V} < V_{\text{IN}} < V_{\text{OVP}} - V_{\text{hys(OVP)}}$	1.3	1.5	1.7	A	
$t_{\text{REC(SC)}}$	Retry interval if short-circuit detected			64		ms	
<b>BATTERY OVERVOLTAGE PROTECTION</b>							
$BV_{\text{OVP}}$	Battery overvoltage protection threshold	$V_{\text{IN}} > 4.5 \text{ V}, \overline{\text{CE}} = \text{LO}$	4.3	4.35	4.4	V	
$V_{\text{hys(BVovp)}}$	Hysteresis on $BV_{\text{(OVP)}}$	$V_{\text{IN}} > 4.5 \text{ V}, \overline{\text{CE}} = \text{LO}$	200		320	mV	
$I_{\text{(VBAT)}}$	Input bias current on VBAT pin	$T_J = 25^{\circ}\text{C}$			10	nA	
<b>THERMAL PROTECTION</b>							
$T_{\text{J(OFF)}}$	Thermal shutdown temperature			140	150	$^{\circ}\text{C}$	
$T_{\text{J(OFF-HYS)}}$	Thermal shutdown hysteresis			20		$^{\circ}\text{C}$	
<b>LOGIC LEVELS ON <math>\overline{\text{CE}}</math></b>							
$V_{\text{IL}}$	Logic LOW input voltage		0		0.4	V	
$V_{\text{IH}}$	Logic HIGH input voltage		1.4			V	
$I_{\text{IL}}$					1	$\mu\text{A}$	
$I_{\text{IH}}$		$V_{\overline{\text{CE}}} = 1.8 \text{ V}$			15	$\mu\text{A}$	
<b>LOGIC LEVELS ON FAULT</b>							
$V_{\text{OL}}$	Output LOW voltage	$I_{\text{SINK}} = 5 \text{ mA}$			0.2	V	
$I_{\text{IKg}}$	Off-state leakage current, HI-Z	$V_{\text{FAULT}} = 5 \text{ V}$			10	$\mu\text{A}$	

## 6.6 Timing Requirements

			MIN	NOM	MAX	UNIT
<b>IN</b>						
$t_{DGL(PGOOD)}$	Deglitch time, input power detected status	$\overline{CE} = \text{LO or HI}$ . Time measured from $V_{IN} 0 \text{ V} \rightarrow 5 \text{ V}$ 1- $\mu\text{s}$ rise-time		8		ms
<b>INPUT OVERVOLTAGE PROTECTION</b>						
$t_{PD(OVP)}^{(1)}$	Input OV propagation delay	$V_{IN}: 5 \text{ V} \rightarrow 10 \text{ V}$		200		ns
$t_{REC(OVP)}$	Recovery time from input overvoltage condition	$\overline{CE} = \text{LO}$ . Time measured from $V_{IN}: 7 \text{ V} \rightarrow 5 \text{ V}$ , 1- $\mu\text{s}$ fall-time		8		ms
<b>BATTERY OVERVOLTAGE PROTECTION</b>						
$t_{DGL(BVovp)}$	Deglitch time, battery overvoltage detected	$V_{IN} > 4.5 \text{ V}$ , $\overline{CE} = \text{LO}$ , Time measured from $V_{VSAT}$ rising from 4.1 V to 4.4 V to FAULT going low.		176		$\mu\text{s}$

(1) Not tested. Specified by design

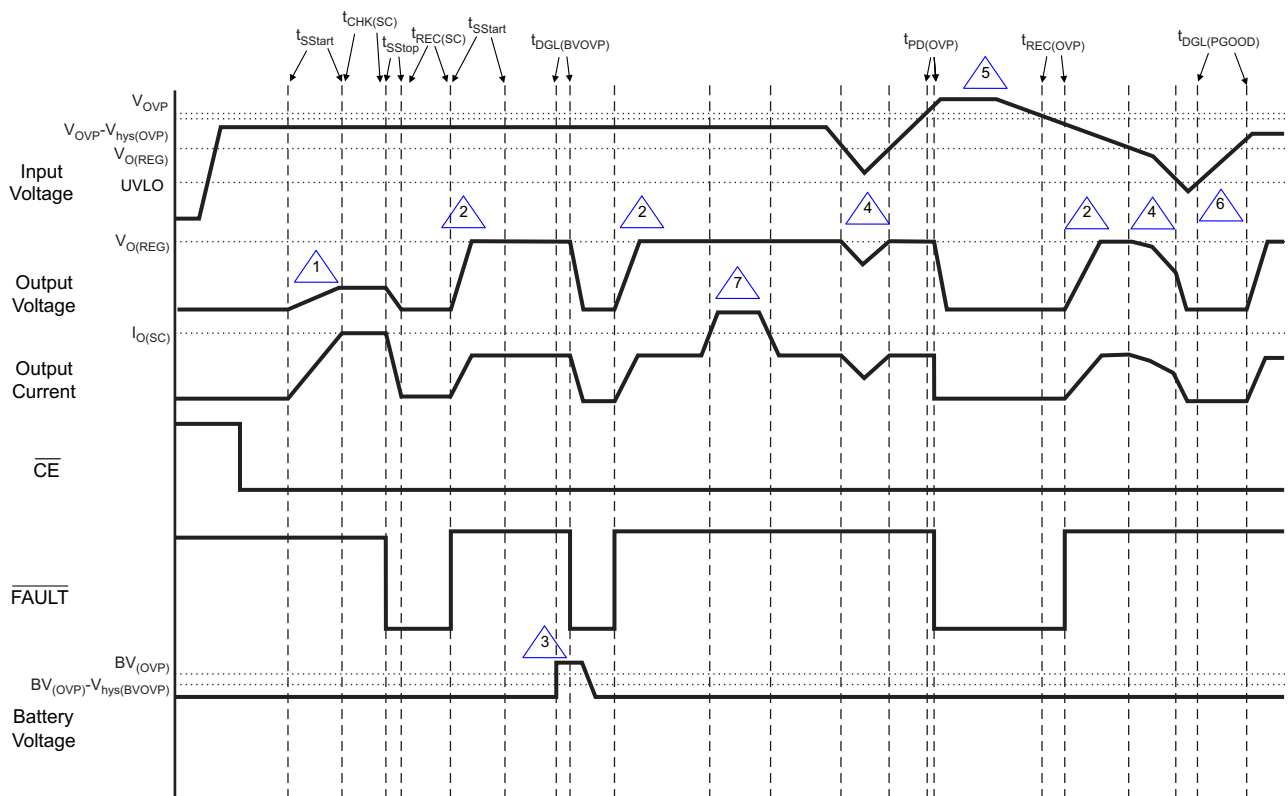

1. Short-circuit during start-up
2. Normal start-up condition
3. Battery overvoltage event
4.  $V_{UVLO} < V_{IN} < V_{(OREG)} - V_{OUT}$  tracks  $V_{IN}$
5. Input overvoltage event
6. Input below UVLO
7. High-current event during normal operation

**Figure 1. Timing Diagram**

## 6.7 Typical Characteristics

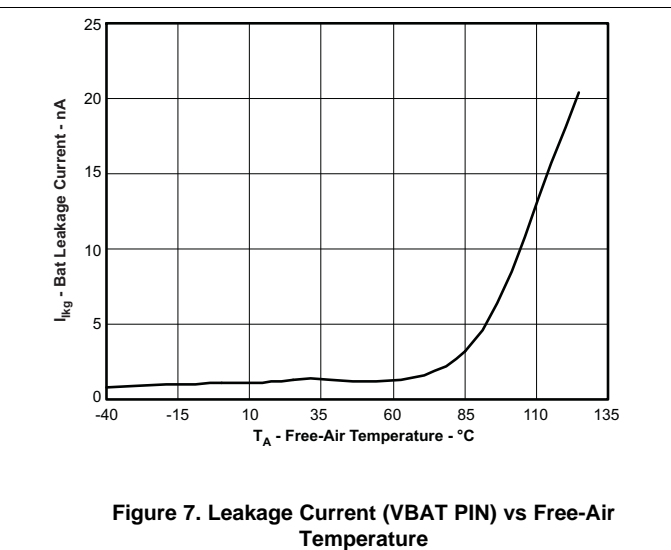
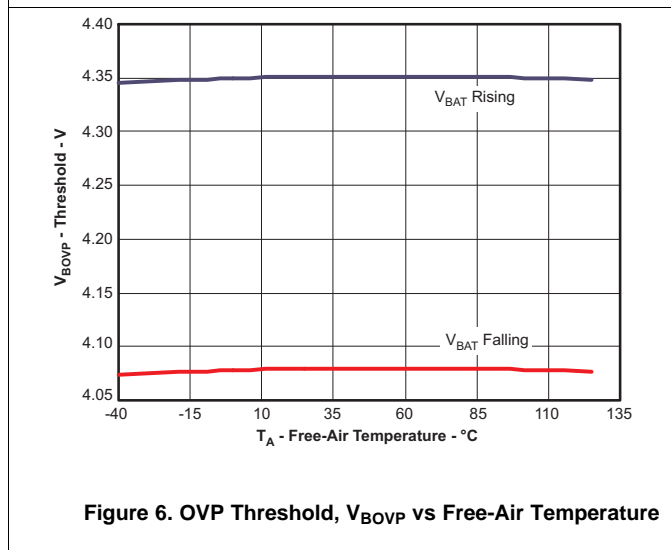
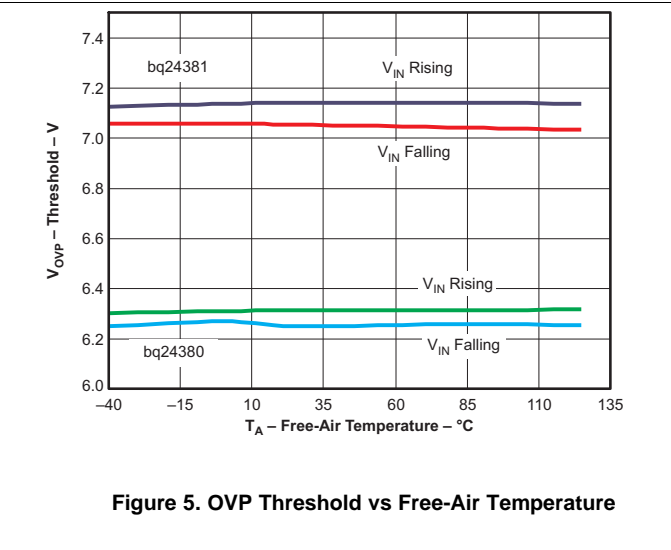
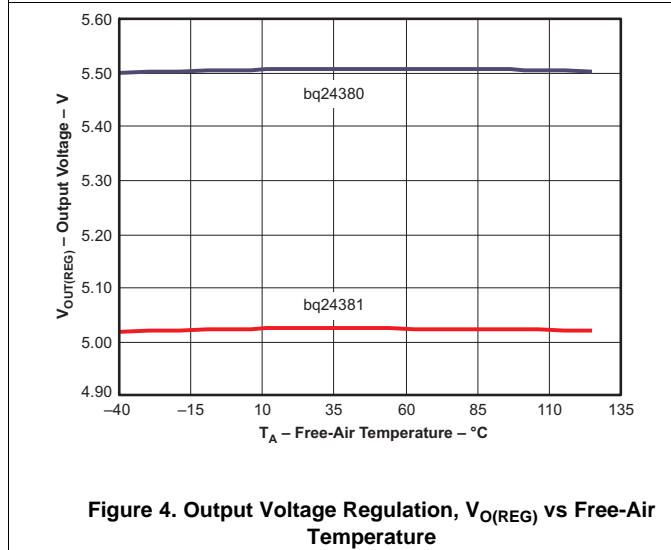
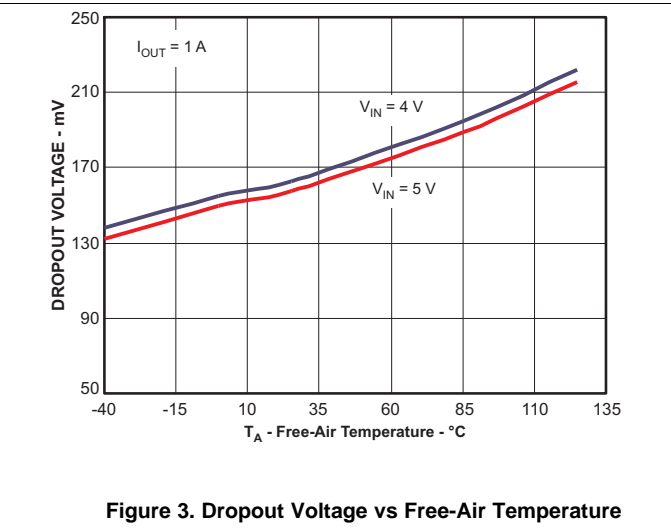
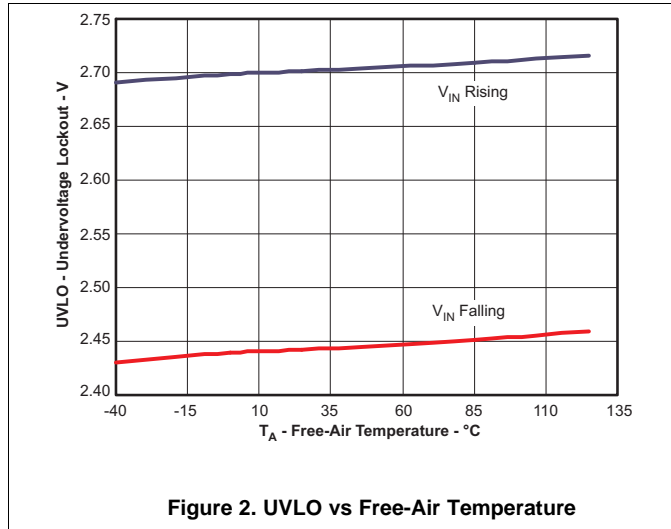

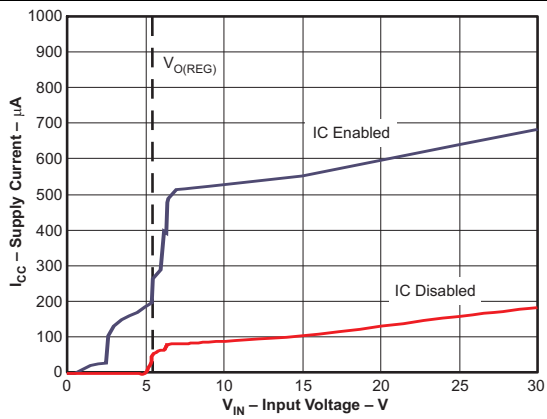
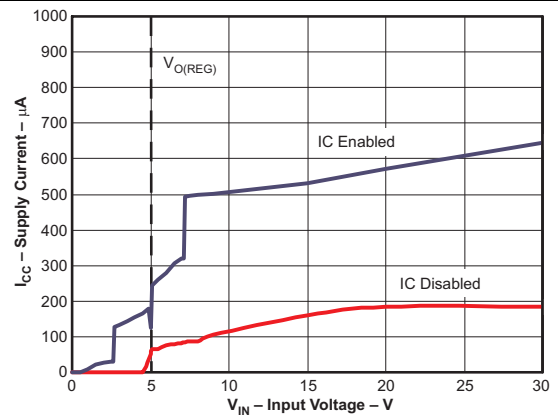
**Typical Characteristics (continued)**

**Figure 8. Supply Current vs Input Voltage (bq24380)**

**Figure 9. Supply Current vs Input Voltage (bq24381)**



## 7 Detailed Description

### 7.1 Overview

The bq2438x is a highly integrated circuit designed to provide protection to Li-ion batteries from failures of the charging circuit and the input source. The device continuously monitors the input voltage and the battery voltage. The device operates like a linear regulator, maintaining a 5.5-V (bq24380) or 5-V (bq24381, bq24382) output with input voltages up to the input overvoltage threshold ( $V_{OVP}$ ). If the input voltage exceeds  $V_{OVP}$ , the device shuts off the pass FET and disconnects the system from input power. Additionally, if the battery voltage rises above 4.35 V, the device switches off the pass FET, removing the power from the system until the battery voltage falls to safe levels. The device also monitors its die temperature and switches the pass FET off if it exceeds 140°C.

The device can be controlled by a processor, and also provides status information about fault conditions to the host.

### 7.2 Functional Block Diagram

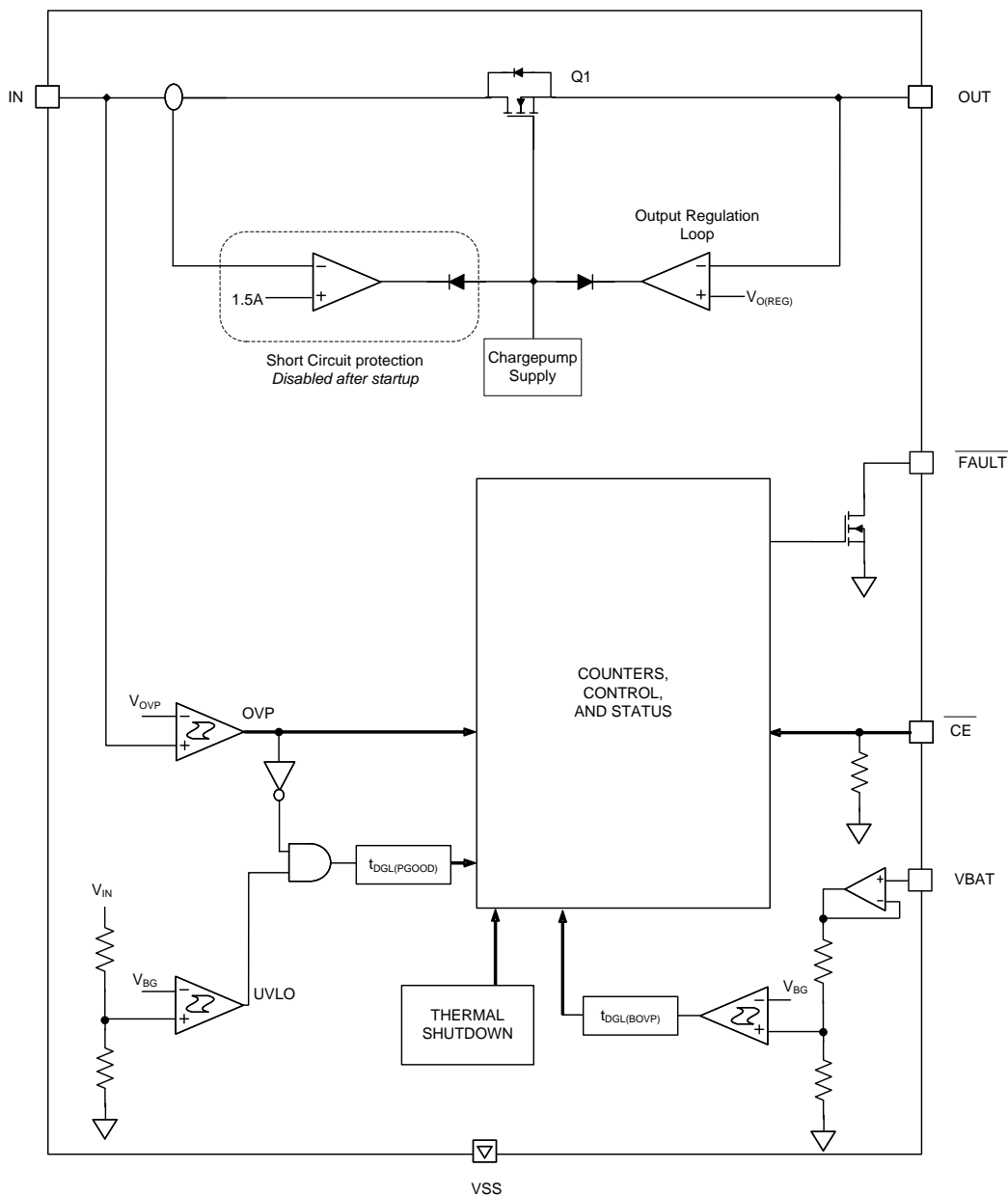

## 7.3 Feature Description

### 7.3.1 Input Overvoltage Protection

The OUT output of the bq2438x operates similar to a linear regulator. While the input voltage is less than  $V_{O(REG)}$  and above the UVLO, the output voltage tracks the input voltage (less the drop caused by  $R_{DS(on)}$  of the pass FET). When the input voltage is greater than  $V_{O(REG)}$  (plus the  $R_{DS(on)}$  drop) and less than  $V_{OVP}$ , the output voltage is regulated to  $V_{O(REG)}$ .  $V_{O(REG)}$  is 5.5 V for the bq24380 and 5 V for both the bq24381 and bq24382. If the input voltage is increased above  $V_{OVP}$ , the internal pass FET is turned off, removing power from the charging circuitry connected to OUT. The  $\overline{FAULT}$  output is then asserted low. When the input voltage drops below  $V_{OVP} - V_{hys(OVP)}$  (but is still above UVLO), the pass FET is turned on after a deglitch time of  $t_{REC(OVP)}$  to ensure that the input supply has stabilized. The *condition 5* in [Figure 1](#) illustrates an input overvoltage event.

### 7.3.2 Battery Overvoltage Protection

The battery overvoltage threshold  $BV_{OVP}$  is internally set to 4.35 V for the bq2438x. *Condition 3* in [Figure 1](#) illustrates a battery overvoltage event. If the battery voltage exceeds the  $BV_{OVP}$  threshold for longer than  $t_{DGL(BV_{OVP})}$ , the pass FET is turned off (using soft-stop), and  $\overline{FAULT}$  is asserted low. The pass FET is turned on (using the soft-start sequence) once the battery voltage drops to  $BV_{OVP} - V_{hys(BV_{OVP})}$ .

### 7.3.3 Thermal Protection

If the junction temperature of the device exceeds  $T_{J(OFF)}$ , the pass FET is turned off and the  $\overline{FAULT}$  output is asserted low. The FET is turned back on when the junction temperature falls below  $T_{J(OFF)} - T_{J(OFF-HYS)}$ .

### 7.3.4 Start-Up Short-Circuit Protection

The bq2438x features overload current protection during start-up. The *condition 1* in [Figure 1](#) illustrates start-up into an overload condition. If after the eight soft-start steps are complete and the current limit is exceeded, the device initiates a short-circuit check timer ( $t_{CHK(SC)}$ ). During this check, the current is clamped to  $I_{O(SC)}$ . If the 5-ms  $t_{CHK(SC)}$  timer expires and the current remains clamped by the current limit, the internal pass FET is turned off using the soft-stop method,  $\overline{FAULT}$  is pulled low, and the  $t_{REC(SC)}$  timer begins. Once the  $t_{REC(SC)}$  timer expires,  $\overline{FAULT}$  becomes high impedance and the soft-start sequence restarts. The device repeats the start/fail sequence until the overload condition is removed. Once the overload condition is removed, the current-limit circuitry is disabled and the device enters normal operation. Additionally, if the current is not limited after the completion of the soft-start sequence, the  $t_{CHK(SC)}$  timer does not start and the current limit circuitry is disabled for normal operation.

### 7.3.5 Enable Function

The device has an enable pin which is used to enable and disable the device. Connect the  $\overline{CE}$  pin high to turn off the internal pass FET. Connect the  $\overline{CE}$  pin low to turn on the internal pass FET and enter the start-up routine. The  $\overline{CE}$  pin has an internal pulldown resistor and can be left unconnected. The  $\overline{FAULT}$  pin is high impedance when the  $\overline{CE}$  pin is high.

### 7.3.6 Fault Indication

The  $\overline{FAULT}$  pin is an active-low, open-drain output. It is in a high-impedance state when operating conditions are safe, or when the device is disabled by setting  $\overline{CE}$  high. With  $\overline{CE}$  low, the  $\overline{FAULT}$  pin goes low whenever any of these events occurs:

1. Output short-circuit at power-on
2. Input overvoltage
3. Battery overvoltage
4. IC overtemperature

See [Figure 1](#) for an example of  $\overline{FAULT}$  conditions during these events. Connect the  $\overline{FAULT}$  pin to the desired logic-level voltage rail through a resistor between 1 k $\Omega$  and 50 k $\Omega$ .

## 7.4 Device Functional Modes

### 7.4.1 OPERATION Mode

The bq2438x device continuously monitors the input voltage and the battery voltage. As long as the input voltage is less than  $V_{OVP}$ , the output voltage tracks the input voltage (less the drop caused by  $R_{DS(ON)}$  of Q1). During fault conditions, the internal FET is turned off and the output is isolated from the input source.

### 7.4.2 POWER-DOWN Mode

The device remains in POWER-DOWN mode when the input voltage at the IN pin is below the undervoltage threshold (UVLO) of 2.8 V. The FET connected between the IN and OUT pins is off, and the status output,  $\overline{FAULT}$ , is set to HI-Z.

### 7.4.3 POWER-ON RESET Mode

The device resets when the input voltage at the IN pin exceeds the UVLO threshold. During power-on reset, the device waits for duration  $t_{DGL(PGOOD)}$  for the input voltage to stabilize. If, after  $t_{DGL(PGOOD)}$ , the input voltage and battery voltage are within operation limits, the pass FET is turned ON. The device has a soft-start feature to control the inrush current. The soft-start minimizes the ringing at the input due to the resonant circuit formed by the parasitic inductance of the adapter cable and the input bypass capacitor. During the soft-start time,  $t_{SStart}$ , the current limit is stepped up in 8 equal steps every 625  $\mu$ s. Each step is one-eighth of the  $I_{O(SC)}$ . After the soft-start sequence is over, the device samples the load current. If the load current exceeds  $I_{O(SC)}$ , the device initiates short circuit protection. See the [Startup Short-Circuit Protection](#) section for details. If no overcurrent event is measured, the current-monitoring circuitry is disabled for normal operation.

In the event a short-circuit is detected at power-on, to prevent the input voltage from spiking up when the pass FET is switched off (due to the inductance of the input cable), The pass FET is turned off by gradually reducing its gate-drive, resulting in a *soft-stop* ( $t_{SStop}$ ).

## 8 Application and Implementation

### NOTE

Information in the following applications sections is not part of the TI component specification, and TI does not warrant its accuracy or completeness. TI's customers are responsible for determining suitability of components for their purposes. Customers should validate and test their design implementation to confirm system functionality.

### 8.1 Application Information

The bq2438x device protects against overvoltage and battery overvoltage events that occur due to faulty adapter or incorrect input sources. If either of these faults occur, the bq2438x device isolates the downstream devices from the input source and alerts the host controller with the FAULT open-drain output.

### 8.2 Typical Application

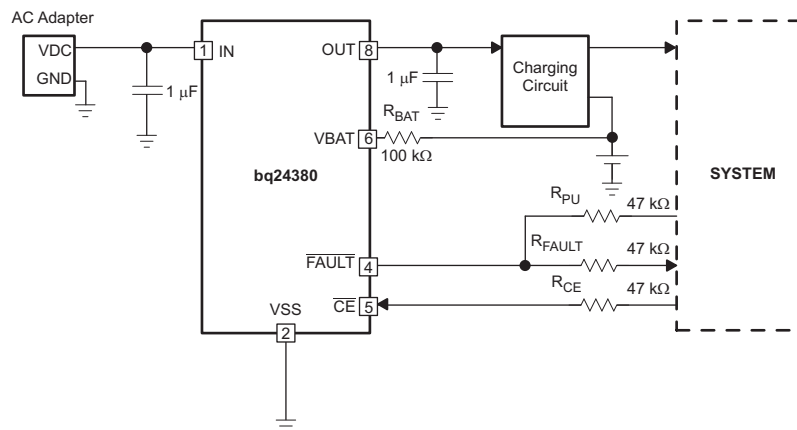

**Figure 10. Typical Application Circuit**

#### 8.2.1 Design Requirements

For this design example, use the parameters shown in [Table 1](#).

**Table 1. Design Parameters**

PARAMETER	VALUE
Voltage	5 V
Current	< 1.5 A

#### 8.2.2 Detailed Design Procedure

##### 8.2.2.1 Selection of $R_{(BAT)}$

It is strongly recommended that the battery not be tied directly to the VBAT pin of the device, as under some failure modes of the device, the voltage at the IN pin may appear on the VBAT pin. This voltage can be as high as 30 V, and applying 30 V to the battery may cause failure of the device and can be hazardous. Connecting the VBAT pin through  $R_{(BAT)}$  prevents a large current from flowing into the battery in the event of failure of the device. For safety,  $R_{(BAT)}$  must have a high value. The problem with a large  $R_{(BAT)}$  is that the voltage drop across this resistor because of the VBAT bias current,  $I_{(VBAT)}$ , causes an error in the  $BV_{OVP}$  threshold. This error is over and above the tolerance on the nominal 4.35-V  $BV_{OVP}$  threshold.

Choosing  $R_{(BAT)}$  in the range from 100 k $\Omega$  to 470 k $\Omega$  is a good compromise. If the device fails with  $R_{(BAT)}$  equal to 100 k $\Omega$ , the maximum current flowing into the battery would be  $(30\text{ V} - 3\text{ V}) \div 100\text{ k}\Omega = 246\text{ }\mu\text{A}$ , which is low enough to be absorbed by the bias currents of the system components.  $R_{(BAT)}$  equal to 100 k $\Omega$  results in a worst-case voltage drop of  $R_{(BAT)} \times I_{(VBAT)} = 1\text{ mV}$ . This is negligible compared to the internal tolerance of 50 mV on the  $BV_{OVP}$  threshold.

If the Bat-OVP function is not required, the VBAT pin must be connected to VSS.

### 8.2.2.2 Selection of $R_{(CE)}$

The  $\overline{CE}$  pin can be used to enable and disable the device. If host control is not required, the  $\overline{CE}$  pin can be tied to ground or left unconnected, permanently enabling the device.

In applications where external control is required, the  $\overline{CE}$  pin can be controlled by a host processor. As with the VBAT pin (see previous discussion), the  $\overline{CE}$  pin must be connected to the host GPIO pin through as large a resistor as possible. The limitation on the resistor value is that the minimum  $V_{OH}$  of the host GPIO pin less the drop across the resistor must be greater than  $V_{IH}$  of the bq2438x  $\overline{CE}$  pin. The drop across the resistor is given by  $R_{(CE)} \times I_{IH}$ .

### 8.2.2.3 Selection of Input and Output Bypass Capacitors

The input capacitor  $C_{IN}$  in Figure 10 is for decoupling and serves an important purpose. Whenever there is a step change downwards in the system load current, the inductance of the input cable causes the input voltage to spike up.  $C_{IN}$  prevents the input voltage from overshooting to dangerous levels. It is recommended that a ceramic capacitor of at least 1  $\mu\text{F}$  be used at the input of the device. It must be located in close proximity to the IN pin.

$C_{OUT}$  in Figure 10 is also important. During an overvoltage transient, this capacitance limits the output overshoot until the power FET is turned off by the overvoltage protection circuitry.  $C_{OUT}$  must be a ceramic capacitor of at least 1  $\mu\text{F}$ , located close to the OUT pin.  $C_{OUT}$  also serves as the input decoupling capacitor for the charging circuit downstream of the protection device.

## 8.2.3 Application Curves

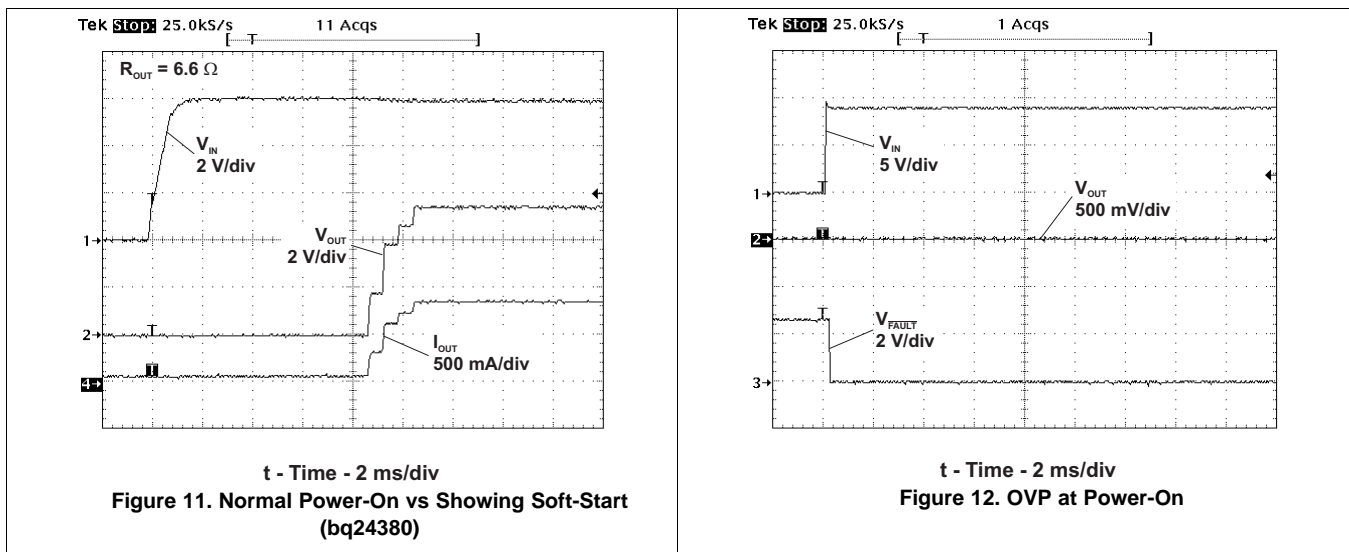

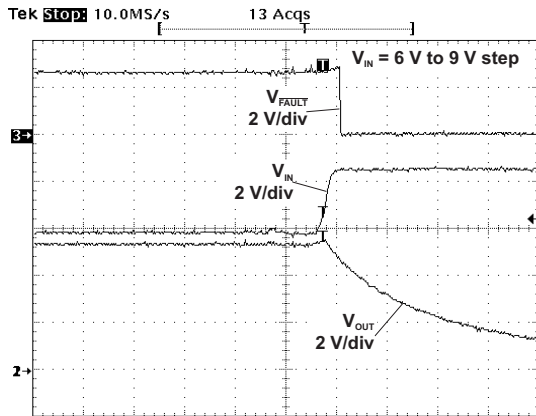

t - Time - 5  $\mu$ s/div

Figure 13. OVP Response for Input Step (bq24380)

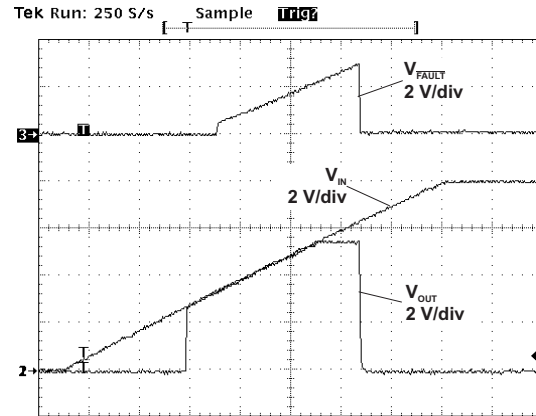

t - Time - 200 ms/div

Figure 14. Slow Input Ramp into OVP Event (bq24380)

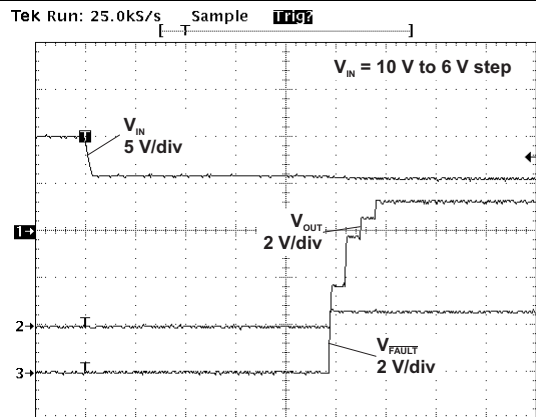

t - Time - 2 ms/div

Figure 15. Recovery from OVP (bq24380)

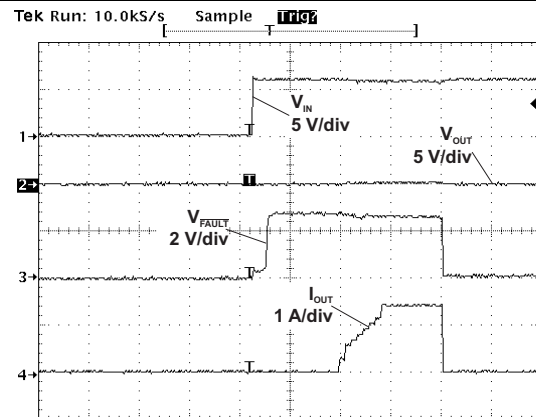

t - Time - 5 ms/div

Figure 16. Power Up into Short Circuit

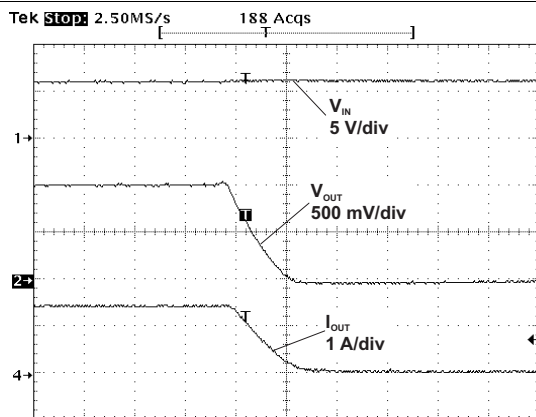

t - Time - 20  $\mu$ s/div

Figure 17. Soft-Stop During OCP Event (bq24380)

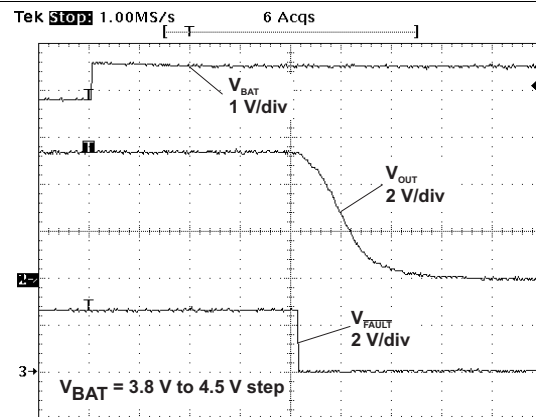

t - Time - 50  $\mu$ s/div

Figure 18. Battery OVP Event (bq24380)

## 9 Power Supply Recommendations

The intention is for the bq2438x device to operate with 5-V adapters with a maximum current rating of 1.5 A. The device operates from sources from 3 V to 5.7 V. Outside of this range, the output is disconnected due to either UVLO or the OVP function.

## 10 Layout

### 10.1 Layout Guidelines

- This device is a protection device and is meant to protect down-stream circuitry from hazardous voltages. Potentially, high voltages may be applied to this device. It has to be ensured that the edge-to-edge clearances of PCB traces satisfy the design rules for the maximum voltages expected to be seen in the system. See [Figure 19](#).
- The device uses WSON packages with a thermal pad. For good thermal performance, the thermal pad must be thermally coupled with the PCB ground plane (GND). In most applications, this requires a copper pad directly under the device. This copper pad must be connected to the ground plane with an array of thermal vias.
- $C_{IN}$  and  $C_{OUT}$  should be located close to the device. Other components like  $R_{(BAT)}$  should also be located close to the device.

### 10.2 Layout Example

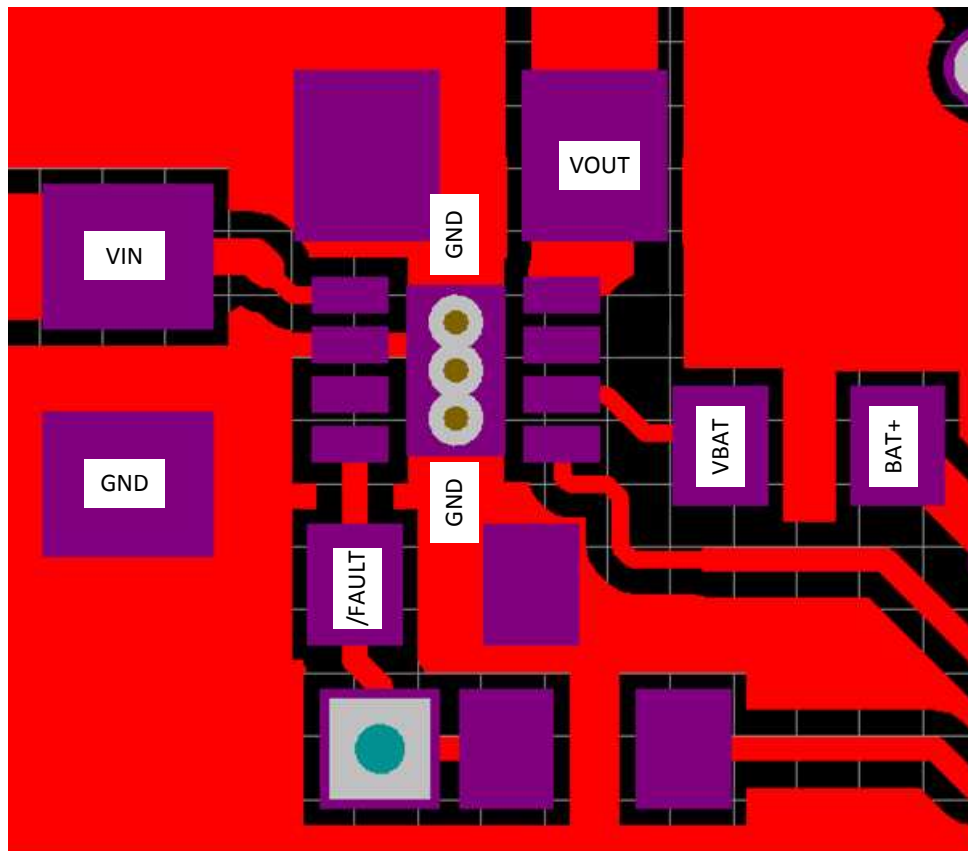

Figure 19. Layout Example Recommendation

## 11 Device and Documentation Support

### 11.1 Related Links

The table below lists quick access links. Categories include technical documents, support and community resources, tools and software, and quick access to sample or buy.

**Table 2. Related Links**

PARTS	PRODUCT FOLDER	SAMPLE & BUY	TECHNICAL DOCUMENTS	TOOLS & SOFTWARE	SUPPORT & COMMUNITY
bq24380	<a href="#">Click here</a>	<a href="#">Click here</a>	<a href="#">Click here</a>	<a href="#">Click here</a>	<a href="#">Click here</a>
bq24381	<a href="#">Click here</a>	<a href="#">Click here</a>	<a href="#">Click here</a>	<a href="#">Click here</a>	<a href="#">Click here</a>
bq24382	<a href="#">Click here</a>	<a href="#">Click here</a>	<a href="#">Click here</a>	<a href="#">Click here</a>	<a href="#">Click here</a>

### 11.2 Community Resources

The following links connect to TI community resources. Linked contents are provided "AS IS" by the respective contributors. They do not constitute TI specifications and do not necessarily reflect TI's views; see TI's [Terms of Use](#).

**TI E2E™ Online Community** *TI's Engineer-to-Engineer (E2E) Community*. Created to foster collaboration among engineers. At [e2e.ti.com](http://e2e.ti.com), you can ask questions, share knowledge, explore ideas and help solve problems with fellow engineers.

**Design Support** *TI's Design Support* Quickly find helpful E2E forums along with design support tools and contact information for technical support.

### 11.3 Trademarks

E2E is a trademark of Texas Instruments.

All other trademarks are the property of their respective owners.

### 11.4 Electrostatic Discharge Caution



These devices have limited built-in ESD protection. The leads should be shorted together or the device placed in conductive foam during storage or handling to prevent electrostatic damage to the MOS gates.

### 11.5 Glossary

[SLYZ022](#) — *TI Glossary*.

This glossary lists and explains terms, acronyms, and definitions.

## 12 Mechanical, Packaging, and Orderable Information

The following pages include mechanical, packaging, and orderable information. This information is the most current data available for the designated devices. This data is subject to change without notice and revision of this document. For browser-based versions of this data sheet, refer to the left-hand navigation.



**PACKAGING INFORMATION**

Orderable Device	Status (1)	Package Type	Package Drawing	Pins	Package Qty	Eco Plan (2)	Lead finish/ Ball material (6)	MSL Peak Temp (3)	Op Temp (°C)	Device Marking (4/5)	Samples
BQ24380DSGR	ACTIVE	WSON	DSG	8	3000	RoHS & Green	NIPDAU   NIPDAUAG	Level-2-260C-1 YEAR	-40 to 125	CFE	<a href="#">Samples</a>
BQ24380DSGT	ACTIVE	WSON	DSG	8	250	RoHS & Green	NIPDAU   NIPDAUAG	Level-2-260C-1 YEAR	-40 to 125	CFE	<a href="#">Samples</a>
BQ24381DSGR	ACTIVE	WSON	DSG	8	3000	RoHS & Green	NIPDAUAG	Level-2-260C-1 YEAR	-40 to 125	CFW	<a href="#">Samples</a>
BQ24381DSGT	ACTIVE	WSON	DSG	8	250	RoHS & Green	NIPDAUAG	Level-2-260C-1 YEAR	-40 to 125	CFW	<a href="#">Samples</a>
BQ24382DSGR	ACTIVE	WSON	DSG	8	3000	RoHS & Green	NIPDAUAG	Level-2-260C-1 YEAR	-40 to 125	OBE	<a href="#">Samples</a>
BQ24382DSGT	ACTIVE	WSON	DSG	8	250	RoHS & Green	NIPDAUAG	Level-2-260C-1 YEAR	-40 to 125	OBE	<a href="#">Samples</a>

(1) The marketing status values are defined as follows:

**ACTIVE:** Product device recommended for new designs.

**LIFEBUY:** TI has announced that the device will be discontinued, and a lifetime-buy period is in effect.

**NRND:** Not recommended for new designs. Device is in production to support existing customers, but TI does not recommend using this part in a new design.

**PREVIEW:** Device has been announced but is not in production. Samples may or may not be available.

**OBSELETE:** TI has discontinued the production of the device.

(2) **RoHS:** TI defines "RoHS" to mean semiconductor products that are compliant with the current EU RoHS requirements for all 10 RoHS substances, including the requirement that RoHS substance do not exceed 0.1% by weight in homogeneous materials. Where designed to be soldered at high temperatures, "RoHS" products are suitable for use in specified lead-free processes. TI may reference these types of products as "Pb-Free".

**RoHS Exempt:** TI defines "RoHS Exempt" to mean products that contain lead but are compliant with EU RoHS pursuant to a specific EU RoHS exemption.

**Green:** TI defines "Green" to mean the content of Chlorine (Cl) and Bromine (Br) based flame retardants meet JS709B low halogen requirements of <=1000ppm threshold. Antimony trioxide based flame retardants must also meet the <=1000ppm threshold requirement.

(3) MSL, Peak Temp. - The Moisture Sensitivity Level rating according to the JEDEC industry standard classifications, and peak solder temperature.

(4) There may be additional marking, which relates to the logo, the lot trace code information, or the environmental category on the device.

(5) Multiple Device Markings will be inside parentheses. Only one Device Marking contained in parentheses and separated by a "~" will appear on a device. If a line is indented then it is a continuation of the previous line and the two combined represent the entire Device Marking for that device.

(6) Lead finish/Ball material - Orderable Devices may have multiple material finish options. Finish options are separated by a vertical ruled line. Lead finish/Ball material values may wrap to two lines if the finish value exceeds the maximum column width.

**Important Information and Disclaimer:** The information provided on this page represents TI's knowledge and belief as of the date that it is provided. TI bases its knowledge and belief on information provided by third parties, and makes no representation or warranty as to the accuracy of such information. Efforts are underway to better integrate information from third parties. TI has taken and continues to take reasonable steps to provide representative and accurate information but may not have conducted destructive testing or chemical analysis on incoming materials and chemicals. TI and TI suppliers consider certain information to be proprietary, and thus CAS numbers and other limited information may not be available for release.

In no event shall TI's liability arising out of such information exceed the total purchase price of the TI part(s) at issue in this document sold by TI to Customer on an annual basis.

## TAPE AND REEL INFORMATION



### QUADRANT ASSIGNMENTS FOR PIN 1 ORIENTATION IN TAPE



\*All dimensions are nominal

Device	Package Type	Package Drawing	Pins	SPQ	Reel Diameter (mm)	Reel Width W1 (mm)	A0 (mm)	B0 (mm)	K0 (mm)	P1 (mm)	W (mm)	Pin1 Quadrant
BQ24380DSGR	WSON	DSG	8	3000	178.0	8.4	2.25	2.25	1.0	4.0	8.0	Q2
BQ24380DSGR	WSON	DSG	8	3000	179.0	8.4	2.2	2.2	1.2	4.0	8.0	Q2
BQ24380DSGT	WSON	DSG	8	250	178.0	8.4	2.25	2.25	1.0	4.0	8.0	Q2
BQ24380DSGT	WSON	DSG	8	250	179.0	8.4	2.2	2.2	1.2	4.0	8.0	Q2
BQ24381DSGR	WSON	DSG	8	3000	179.0	8.4	2.2	2.2	1.2	4.0	8.0	Q2
BQ24381DSGT	WSON	DSG	8	250	179.0	8.4	2.2	2.2	1.2	4.0	8.0	Q2
BQ24382DSGR	WSON	DSG	8	3000	179.0	8.4	2.2	2.2	1.2	4.0	8.0	Q2
BQ24382DSGT	WSON	DSG	8	250	179.0	8.4	2.2	2.2	1.2	4.0	8.0	Q2

**TAPE AND REEL BOX DIMENSIONS**

\*All dimensions are nominal

Device	Package Type	Package Drawing	Pins	SPQ	Length (mm)	Width (mm)	Height (mm)
BQ24380DSGR	WSON	DSG	8	3000	205.0	200.0	33.0
BQ24380DSGR	WSON	DSG	8	3000	213.0	191.0	35.0
BQ24380DSGT	WSON	DSG	8	250	205.0	200.0	33.0
BQ24380DSGT	WSON	DSG	8	250	213.0	191.0	35.0
BQ24381DSGR	WSON	DSG	8	3000	213.0	191.0	35.0
BQ24381DSGT	WSON	DSG	8	250	213.0	191.0	35.0
BQ24382DSGR	WSON	DSG	8	3000	213.0	191.0	35.0
BQ24382DSGT	WSON	DSG	8	250	213.0	191.0	35.0

## GENERIC PACKAGE VIEW

**DSG 8**

**WSON - 0.8 mm max height**

2 x 2, 0.5 mm pitch

PLASTIC SMALL OUTLINE - NO LEAD

This image is a representation of the package family, actual package may vary.  
Refer to the product data sheet for package details.



4224783/A

# DSG0008A



# PACKAGE OUTLINE

## WSON - 0.8 mm max height

PLASTIC SMALL OUTLINE - NO LEAD



ALTERNATIVE TERMINAL SHAPE TYPICAL



SIDE WALL METAL THICKNESS DIM A	
OPTION 1	OPTION 2
0.1	0.2

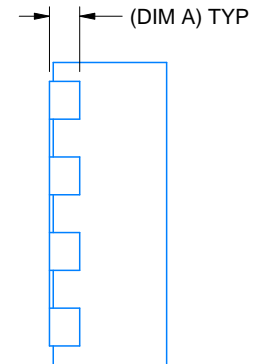
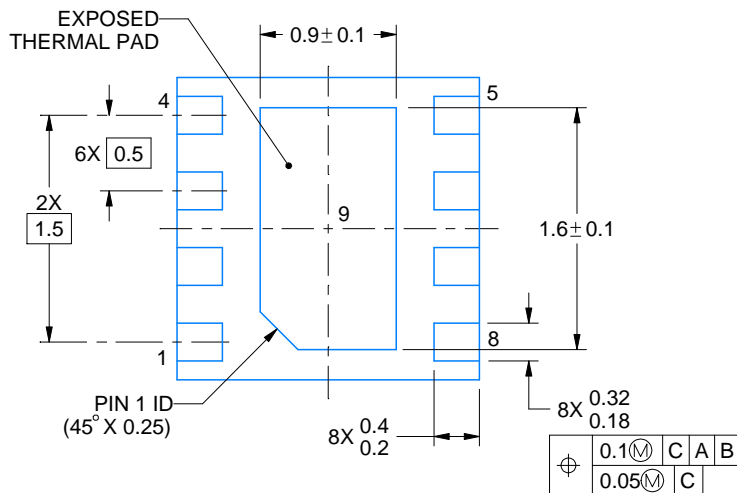

4218900/E 08/2022

### NOTES:

1. All linear dimensions are in millimeters. Any dimensions in parenthesis are for reference only. Dimensioning and tolerancing per ASME Y14.5M.
2. This drawing is subject to change without notice.
3. The package thermal pad must be soldered to the printed circuit board for thermal and mechanical performance.

# EXAMPLE BOARD LAYOUT

DSG0008A

WSON - 0.8 mm max height

PLASTIC SMALL OUTLINE - NO LEAD



LAND PATTERN EXAMPLE  
SCALE:20X

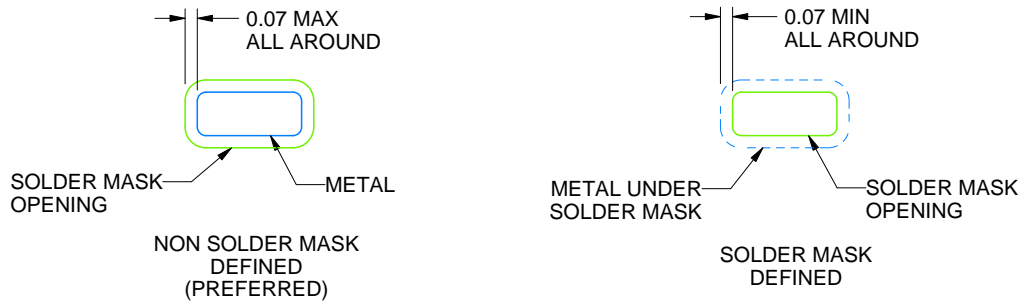

SOLDER MASK DETAILS

4218900/E 08/2022

NOTES: (continued)

4. This package is designed to be soldered to a thermal pad on the board. For more information, see Texas Instruments literature number SLUA271 ([www.ti.com/lit/slua271](http://www.ti.com/lit/slua271)).
5. Vias are optional depending on application, refer to device data sheet. If any vias are implemented, refer to their locations shown on this view. It is recommended that vias under paste be filled, plugged or tented.

# EXAMPLE STENCIL DESIGN

DSG0008A

WSON - 0.8 mm max height

PLASTIC SMALL OUTLINE - NO LEAD

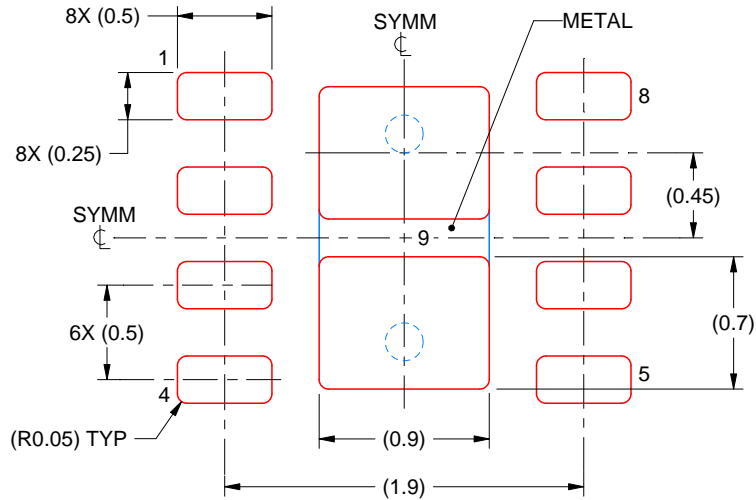

SOLDER PASTE EXAMPLE  
BASED ON 0.125 mm THICK STENCIL

EXPOSED PAD 9:  
87% PRINTED SOLDER COVERAGE BY AREA UNDER PACKAGE  
SCALE:25X

4218900/E 08/2022

NOTES: (continued)

6. Laser cutting apertures with trapezoidal walls and rounded corners may offer better paste release. IPC-7525 may have alternate design recommendations.



## IMPORTANT NOTICE AND DISCLAIMER

TI PROVIDES TECHNICAL AND RELIABILITY DATA (INCLUDING DATA SHEETS), DESIGN RESOURCES (INCLUDING REFERENCE DESIGNS), APPLICATION OR OTHER DESIGN ADVICE, WEB TOOLS, SAFETY INFORMATION, AND OTHER RESOURCES "AS IS" AND WITH ALL FAULTS, AND DISCLAIMS ALL WARRANTIES, EXPRESS AND IMPLIED, INCLUDING WITHOUT LIMITATION ANY IMPLIED WARRANTIES OF MERCHANTABILITY, FITNESS FOR A PARTICULAR PURPOSE OR NON-INFRINGEMENT OF THIRD PARTY INTELLECTUAL PROPERTY RIGHTS.

These resources are intended for skilled developers designing with TI products. You are solely responsible for (1) selecting the appropriate TI products for your application, (2) designing, validating and testing your application, and (3) ensuring your application meets applicable standards, and any other safety, security, regulatory or other requirements.

These resources are subject to change without notice. TI grants you permission to use these resources only for development of an application that uses the TI products described in the resource. Other reproduction and display of these resources is prohibited. No license is granted to any other TI intellectual property right or to any third party intellectual property right. TI disclaims responsibility for, and you will fully indemnify TI and its representatives against, any claims, damages, costs, losses, and liabilities arising out of your use of these resources.

TI's products are provided subject to [TI's Terms of Sale](#) or other applicable terms available either on [ti.com](https://www.ti.com) or provided in conjunction with such TI products. TI's provision of these resources does not expand or otherwise alter TI's applicable warranties or warranty disclaimers for TI products.

TI objects to and rejects any additional or different terms you may have proposed.

Mailing Address: Texas Instruments, Post Office Box 655303, Dallas, Texas 75265  
Copyright © 2023, Texas Instruments Incorporated