

BQ25175 具有 4.35V 充电电压和充电指示功能的独立单节 800mA 线性电池充电器

1 特性

- 可承受高达 30V 的输入电压
- 自动睡眠模式，可降低功耗
 - 350nA 电池泄漏电流
 - 禁用充电时，输入泄漏电流为 80 μ A
- 支持单节锂离子和锂聚合物电池
- 固定 4.35V 电池稳压电压
- 操作可使用外部电阻器进行编程
 - ISET 用于设置 10mA 至 800mA 的充电电流
- 高精度
 - 充电电压精度为 $\pm 0.5\%$
 - 充电电流精度为 $\pm 10\%$
- 充电特性
 - 预充电电流为 20% ISET
 - 终止电流为 10% ISET
 - NTC 热敏电阻输入用于监控电池温度
 - 禁用低温和高温充电
 - 以 20% ISET 低温充电
 - TS 引脚用于充电功能控制
 - 开漏输出用于状态和故障指示
- 集成故障保护
 - 6.6V 输入过压保护
 - 1000mA 过流保护
 - 125 $^{\circ}$ C 热调节；150 $^{\circ}$ C 热关断保护
 - OUT 短路保护
 - ISET 引脚短路/开路保护

2 应用

- 智能追踪器
- 真正无线耳机
- 智能远程控制
- 脉搏血氧仪
- 血糖监控

3 说明

BQ25175 是一款集成式 800mA 线性充电器，适用于单节锂离子和锂聚合物电池。该器件具有为电池充电的单电源输出。只要安全计时器期间内平均系统负载不会妨碍电池充满电，就可以使系统负载与电池并联。当系统负载与电池并联时，充电电流会由系统和电池共享。

该器件分三个阶段为锂离子/锂聚合物电池充电：预充电阶段，用于恢复完全放电的电池；快速充电恒定电流阶段，用于使电池充上大部分电量；以及电压调节阶段，用于使电池电量充满。

在所有充电阶段，内部控制环路都会监控 IC 结温，当其超过内部温度阈值 T_{REG} 时，它会减少充电电流。

充电器功率级和充电电流感测功能均完全集成。该充电器具有高精度电流和电压调节环路功能、充电状态显示和自动充电终止功能。快速充电电流可通过外部电阻进行编程。预充电和终止电流阈值由快速充电电流设置决定。

器件信息

器件型号 ⁽¹⁾	封装	封装尺寸 (标称值)
BQ25175	DSBGA (6)	0.8 mm x 1.25 mm

(1) 如需了解所有可用封装，请参阅数据表末尾的可订购产品附录。

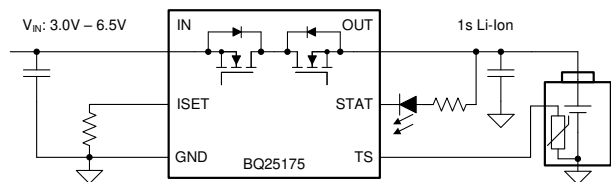

简化版原理图



Table of Contents

1 特性	1	7.4 Device Functional Modes.....	16
2 应用	1	8 Application and Implementation	18
3 说明	1	8.1 Application Information.....	18
4 Revision History	2	8.2 Typical Applications.....	18
5 Pin Configuration and Functions	3	9 Power Supply Recommendations	22
6 Specifications	4	10 Layout	22
6.1 Absolute Maximum Ratings	4	10.1 Layout Guidelines.....	22
6.2 ESD Ratings	4	10.2 Layout Example.....	22
6.3 Recommended Operating Conditions	4	11 Device and Documentation Support	23
6.4 Thermal Information	5	11.1 Device Support.....	23
6.5 Electrical Characteristics	6	11.2 接收文档更新通知.....	23
6.6 Timing Requirements	7	11.3 支持资源.....	23
6.7 Typical Characteristics.....	8	11.4 Trademarks.....	23
7 Detailed Description	10	11.5 Electrostatic Discharge Caution.....	23
7.1 Overview.....	10	11.6 术语表.....	23
7.2 Functional Block Diagram.....	12	12 Mechanical, Packaging, and Orderable Information	24
7.3 Feature Description.....	13		

4 Revision History

注：以前版本的页码可能与当前版本的页码不同

Changes from Revision * (June 2021) to Revision A (September 2021)

Page

• 将“预告信息”更改为“量产数据”	1
--------------------------	---

5 Pin Configuration and Functions

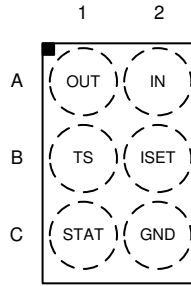

Top View = Xray through a soldered down part with A1 starting in upper left corner

图 5-1. YBG Package 6-Pin DSBGA Top View

表 5-1. Pin Functions

PIN		I/O	DESCRIPTION
NAME	NO.		
OUT	A1	P	Battery connection. System load may be connected in parallel to battery. Bypass OUT with at least a 1- μ F capacitor to GND, place close to the IC.
IN	A2	P	Input power, connected to external DC supply. Bypass IN with at least a 1- μ F capacitor to GND, place close to the IC.
TS	B1	I	Temperature qualification voltage input. Connect a negative temperature coefficient (NTC) thermistor directly from TS to GND (AT103-2 recommended). Charge suspends when $TS < V_{HOT}$ or $TS > V_{COLD}$. Charge at 20% of ISET when $V_{COLD} > TS > V_{COOL}$. If TS function is not needed, connect an external 10-k Ω resistor from this pin to GND. Pulling $TS < V_{TS_ENZ}$ disables the charger.
ISET	B2	I	Programs the device fast-charge current. An external resistor from ISET to GND defines fast charge current value. Expected range is 30 k Ω (10 mA) to 375 Ω (800 mA). $ICHG = K_{ISET} / R_{ISET}$. Precharge current is defined as 20% of ICHG. Termination current is defined as 10% of ICHG.
STAT	C1	O	Open drain charger status indication output. Connect to pull-up rail via 10-k Ω resistor. LOW indicates charge in progress. HIGH indicates charge complete or charge disabled. When a fault condition is detected, the STAT pin blinks at 1 Hz. If unsued, this pin can be left floating.
GND	C2	-	Ground pin

6 Specifications

6.1 Absolute Maximum Ratings

over operating free-air temperature range (unless otherwise noted)⁽¹⁾

		MIN	MAX	UNIT
Voltage	IN	- 0.3	30	V
Voltage	OUT	- 0.3	13	V
Voltage	ISET, STAT, TS	- 0.3	5.5	V
T _J	Junction temperature	- 40	150	°C
T _{stg}	Storage temperature	- 65	150	°C

- (1) Stresses beyond those listed under *Absolute Maximum Rating* may cause permanent damage to the device. These are stress ratings only, which do not imply functional operation of the device at these or any other conditions beyond those indicated under *Recommended Operating Condition*. Exposure to absolute-maximum-rated conditions for extended periods may affect device reliability.

6.2 ESD Ratings

			VALUE	UNIT
V _(ESD)	Electrostatic discharge	Human body model (HBM), per ANSI/ESDA/ JEDEC JS-001 ⁽¹⁾	±2500	V
		Charged device model (CDM), per ANSI/ESDA/ JEDEC JS-002 ⁽²⁾	±1500	

- (1) JEDEC document JEP155 states that 500-V HBM allows safe manufacturing with a standard ESD control process.
 (2) JEDEC document JEP157 states that 250-V CDM allows safe manufacturing with a standard ESD control process.

6.3 Recommended Operating Conditions

over operating free-air temperature range (unless otherwise noted)

		MIN	NOM	MAX	UNIT
V _{IN}	Input voltage	3.0		6.6	V
V _{OUT}	Output voltage			4.35	V
I _{OUT}	Output current			0.8	A
T _J	Junction temperature	- 40		125	°C
C _{IN}	IN capacitor	1			μF
C _{OUT}	OUT capacitor	1			μF
R _{ISET}	ISET resistor	0.375		30	k Ω
R _{TS}	TS thermistor resistor (recommend 103AT-2)		10		k Ω

6.4 Thermal Information

THERMAL METRIC ⁽¹⁾		BQ25175	UNIT
		YBG	
		6 PINS	
$R_{\theta JA}$	Junction-to-ambient thermal resistance (JEDEC ⁽¹⁾)	132.4	°C/W
$R_{\theta JC(top)}$	Junction-to-case (top) thermal resistance	1.5	°C/W
$R_{\theta JB}$	Junction-to-board thermal resistance	36.9	°C/W
Ψ_{JT}	Junction-to-top characterization parameter	0.4	°C/W
Ψ_{JB}	Junction-to-board characterization parameter	36.9	°C/W
$R_{\theta JC(bot)}$	Junction-to-case (bottom) thermal resistance	N/A	°C/W

- (1) For more information about traditional and new thermal metrics, see the [Semiconductor and IC Package Thermal Metrics](#) application report.

6.5 Electrical Characteristics

$3.0V < V_{IN} < V_{IN_OV}$ and $V_{IN} > V_{OUT} + V_{SLEEP}$, $T_J = -40^{\circ}C$ to $+125^{\circ}C$, and $T_J = 25^{\circ}C$ for typical values (unless otherwise noted)

PARAMETER		TEST CONDITIONS	MIN	TYP	MAX	UNIT
QUIESCENT CURRENTS						
I_{Q_OUT}	Quiescent output current (OUT)	OUT = 4.2V, IN floating or IN = 0V - 5V, Charge Disabled, $T_J = 25^{\circ}C$		0.350	0.6	μA
		OUT = 4.2V, IN floating or IN = 0V - 5V, Charge Disabled, $T_J < 105^{\circ}C$		0.350	0.8	μA
$I_{SD_IN_TS}$	Shutdown input current (IN) with charge disabled via TS pin	IN = 5V, Charge Disabled ($V_{TS} < V_{TS_ENZ}$), no battery		80	110	μA
$I_{STANDBY_IN}$	Standby input current (IN) with charge terminated	IN = 5V, Charge Enabled, charge terminated		190		μA
I_{Q_IN}	Quiescent input current (IN)	IN = 5V, OUT = 3.8V, Charge Enabled, ICHG = 0A		0.45	0.6	mA
INPUT						
V_{IN_OP}	IN operating range		3.0		6.6	V
V_{IN_LOWV}	IN voltage to start charging	IN rising	3.05	3.09	3.15	V
V_{IN_LOWV}	IN voltage to stop charging	IN falling	2.80	2.95	3.10	V
V_{SLEEPZ}	Exit sleep mode threshold	IN rising, $V_{IN} - V_{OUT}$, OUT = 4V	95	135	175	mV
V_{SLEEP}	Sleep mode threshold hysteresis	IN falling, $V_{IN} - V_{OUT}$, OUT = 4V		80		mV
V_{IN_OV}	VIN overvoltage rising threshold	IN rising	6.60	6.75	6.90	V
V_{IN_OVZ}	VIN overvoltage falling threshold	IN falling		6.63		V
CONFIGURATION PINS SHORT/OPEN PROTECTION						
R_{ISET_SHORT}	Highest resistor value considered short	R_{ISET} below this at startup, charger does not initiate charge, power cycle or TS toggle to reset			350	Ω
BATTERY CHARGER						
V_{DO}	Dropout voltage ($V_{IN} - V_{OUT}$)	$V_{IN} = 4.4V$, IOU = 300mA		425		mV
V_{REG_ACC}	OUT charge voltage accuracy	$T_J = 25^{\circ}C$	4.328	4.350	4.3721	V
V_{REG_ACC}		$T_J = -40^{\circ}C$ to $125^{\circ}C$	4.306	4.350	4.393	V
I_{CHG_RANGE}	Typical charge current regulation range	$V_{OUT} > V_{BAT_LOWV}$		10	800	mA
K_{ISET}	Charge current setting factor, $I_{CHG} = K_{ISET} / R_{ISET}$	$10mA < I_{CHG} < 800mA$	270	300	330	$A \Omega$
I_{CHG_ACC}	Charge current accuracy	$R_{ISET} = 375 \Omega$, OUT = 3.8V	720	800	880	mA
		$R_{ISET} = 600 \Omega$, OUT = 3.8V	450	500	550	mA
		$R_{ISET} = 3.0k \Omega$, OUT = 3.8V	90	100	110	mA
		$R_{ISET} = 30k \Omega$, OUT = 3.8V	9	10	11	mA
I_{PRECHG}	Typical pre-charge current, as percentage of ICHG	$V_{OUT} < V_{BAT_LOWV}$		20		%
I_{PRECHG_ACC}	Precharge current accuracy	$R_{ISET} = 375 \Omega$, OUT = 2.5V	144	160	176	mA
		$R_{ISET} = 600 \Omega$, OUT = 2.5V	85	100	110	mA
		$R_{ISET} = 3.0k \Omega$, OUT = 2.5V	18	20	22	mA
		$R_{ISET} = 30k \Omega$, OUT = 2.5V	1.4	2	2.6	mA
I_{TERM}	Typical termination current, as percentage of ICHG	$V_{OUT} = V_{REG}$		10		%
I_{TERM_ACC}	Termination current accuracy	$R_{ISET} = 600 \Omega$	45	50	55	mA
		$R_{ISET} = 3.0k \Omega$	8.5	10	11.5	mA
		$R_{ISET} = 30k \Omega$	0.4	1	1.6	mA

6.5 Electrical Characteristics (continued)

$3.0V < V_{IN} < V_{IN_OV}$ and $V_{IN} > V_{OUT} + V_{SLEEP}$, $T_J = -40^{\circ}C$ to $+125^{\circ}C$, and $T_J = 25^{\circ}C$ for typical values (unless otherwise noted)

PARAMETER		TEST CONDITIONS	MIN	TYP	MAX	UNIT
V_{BAT_SHORT}	Output (OUT) short circuit voltage rising threshold, for Li-Ion chemistry	OUT rising	2.1	2.2	2.3	V
$V_{BAT_SHORT_HYS}$	Output (OUT) short circuit voltage hysteresis	OUT falling		200		mV
I_{BAT_SHORT}	OUT short circuit charging current	$V_{OUT} < V_{BAT_SHORT}$	4	6	8	mA
V_{BAT_LOWV}	Pre-charge to fast-charge transition threshold, for Li-Ion chemistry	OUT rising	2.7	2.8	3.0	V
$V_{BAT_LOWV_HYS}$	Battery LOWV hysteresis	OUT falling		100		mV
V_{RECHG}	Battery recharge threshold for Li-Ion chemistry	OUT falling $V_{REG_ACC} - V_{OUT}$	75	100	125	mV
R_{ON}	Charging path FET on-resistance	$V_{IN} = 4.4V, I_{OUT} = 300mA, T_J = 25^{\circ}C$		845	1000	$m\Omega$
		$V_{IN} = 4.4V, I_{OUT} = 300mA, T_J = -40 - 125^{\circ}C$		845	1450	$m\Omega$
BATTERY CHARGER PROTECTION						
V_{OUT_OVP}	OUT overvoltage rising threshold	V_{OUT} rising, as percentage of V_{REG}	103	104	105	%
V_{OUT_OVP}	OUT overvoltage falling threshold	V_{OUT} falling, as percentage of V_{REG}	101	102	103	%
I_{OUT_OCP}	Output current limit threshold	IOUT rising	0.9	1	1.1	A
TEMPERATURE REGULATION AND TEMPERATURE SHUTDOWN						
T_{REG}	Typical junction temperature regulation			125		$^{\circ}C$
T_{SHUT}	Thermal shutdown rising threshold	Temperature increasing		150		$^{\circ}C$
	Thermal shutdown falling threshold	Temperature decreasing		135		$^{\circ}C$
BATTERY-PACK NTC MONITOR						
I_{TS_BIAS}	TS nominal bias current		36.5	38	39.5	μA
V_{COLD}	Cold temperature threshold	TS pin voltage rising (approx. $0^{\circ}C$)	0.99	1.04	1.09	V
	Cold temperature exit threshold	TS pin voltage falling (approx. $4^{\circ}C$)	0.83	0.88	0.93	V
V_{COOL}	Normal to low temperature charge; Charge current target reduced to 20% x ISET	TS pin voltage rising (approx. $10^{\circ}C$)	650	680	710	mV
	Low temperature to normal charge; Charge current target returns to ISET	TS pin voltage falling (approx. $13^{\circ}C$)	580	610	640	mV
V_{HOT}	Hot temperature threshold	TS pin voltage falling (approx. $45^{\circ}C$)	176	188	200	mV
	Hot temperature exit threshold	TS pin voltage rising (approx. $40^{\circ}C$)	208	220	232	mV
V_{TS_ENZ}	Charge Disable threshold. Crossing this threshold shall shutdown IC	TS pin voltage falling	40	50	60	mV
V_{TS_EN}	Charge Enable threshold. Crossing this threshold shall restart IC operation	TS pin voltage rising	65	75	85	mV
V_{TS_CLAMP}	TS maximum voltage clamp	TS pin open-circuit (float)	2.3	2.6	2.9	V
LOGIC OUTPUT PIN (STAT)						
V_{OL}	Output low threshold level	Sink current = 5mA			0.4	V
I_{OUT_BIAS}	High-level leakage current	Pull up rail 3.3V			1	μA

6.6 Timing Requirements

		MIN	NOM	MAX	UNIT
BATTERY CHARGER					
$t_{TS_DUTY_ON}$	TS turn-on time during TS duty cycle mode		100		ms
$t_{TS_DUTY_OFF}$	TS turn-off time during TS duty cycle mode		2		s

		MIN	NOM	MAX	UNIT
t _{OUT_OCP_DGL}	Deglitch time for I _{OUT_OCP} , I _{OUT} rising		100		μs
t _{PRECHG}	Pre-charge safety timer accuracy	28.5	30	31.5	min
t _{SAFETY}	Fast-charge safety timer accuracy	9.5	10	10.5	hr

6.7 Typical Characteristics

C_{IN} = 1 μF, C_{OUT} = 1 μF

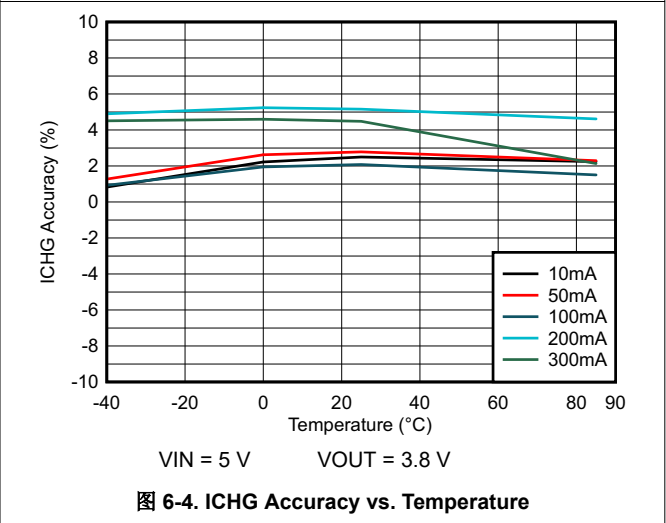
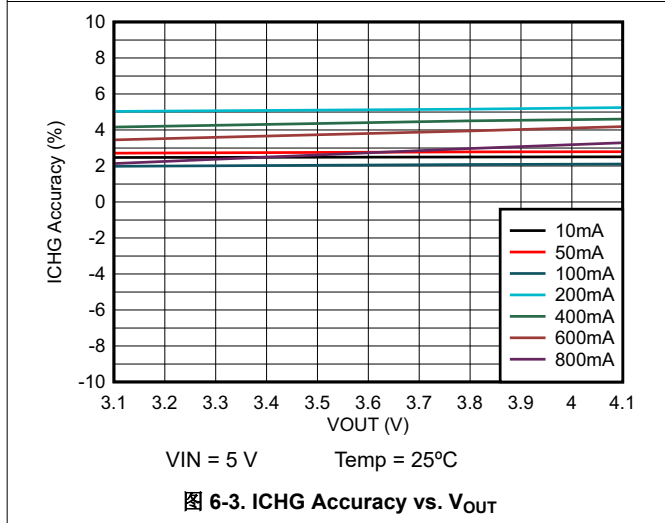
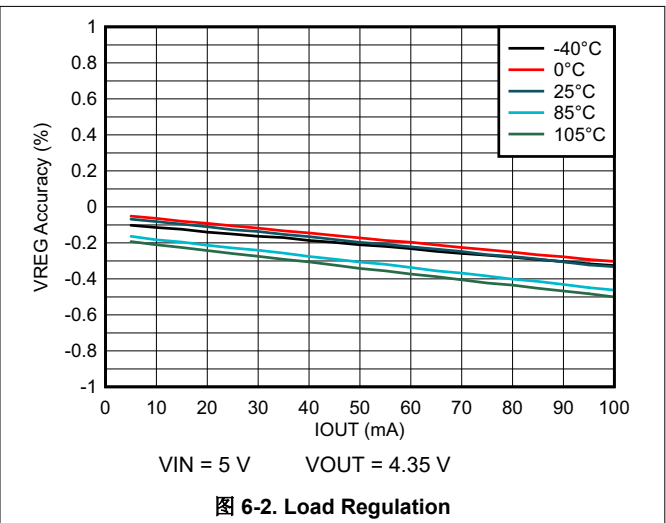
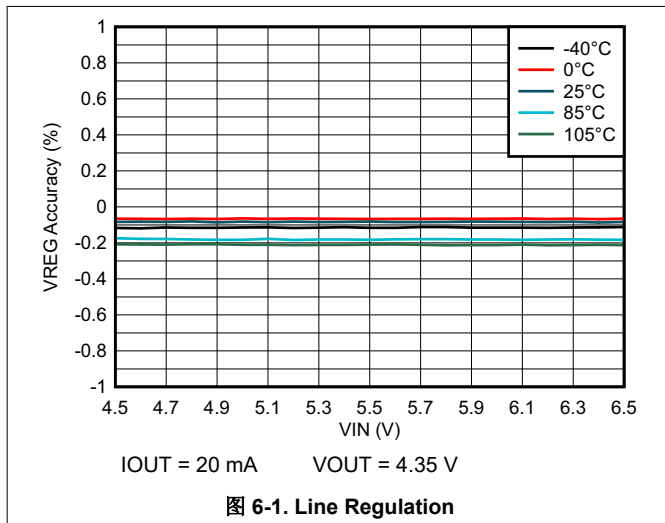

6.7 Typical Characteristics (continued)

$C_{IN} = 1 \mu F$, $C_{OUT} = 1 \mu F$

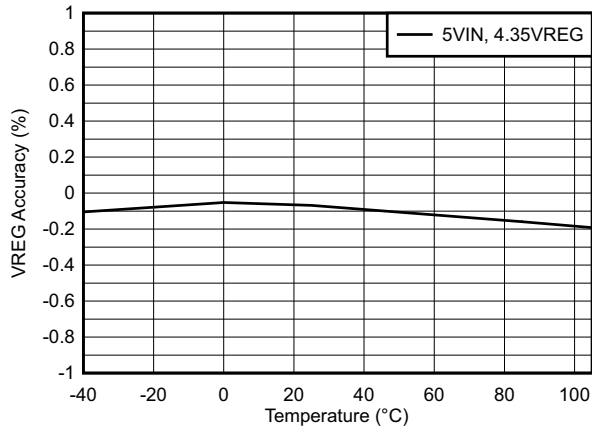

$I_{OUT} = 10 \text{ mA}$

图 6-5. VSET Accuracy vs. Temperature



图 6-6. Dropout Voltage vs. Output Current



TS Pin = LOW

$V_{OUT} = 0 \text{ V}$

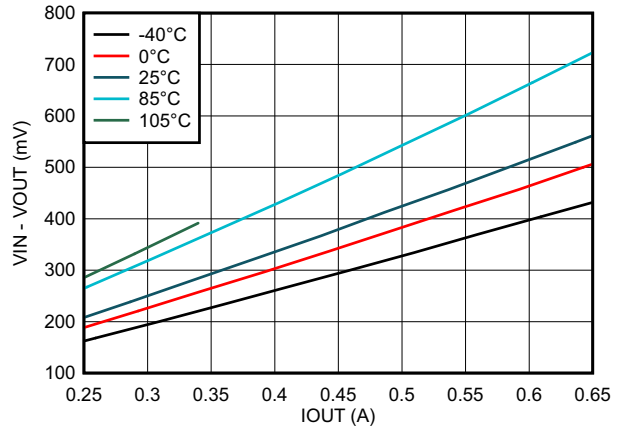
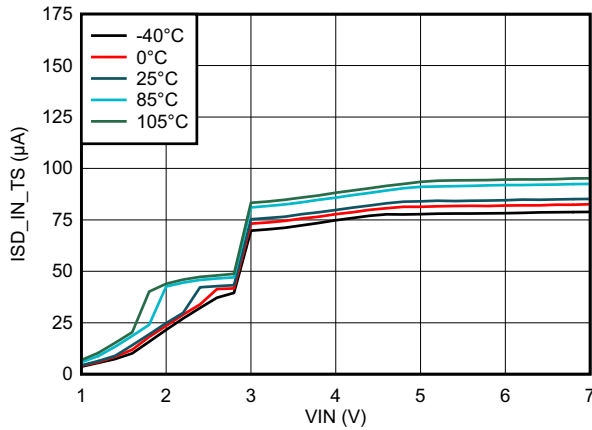
图 6-7. Input Shutdown Current vs. Input Voltage

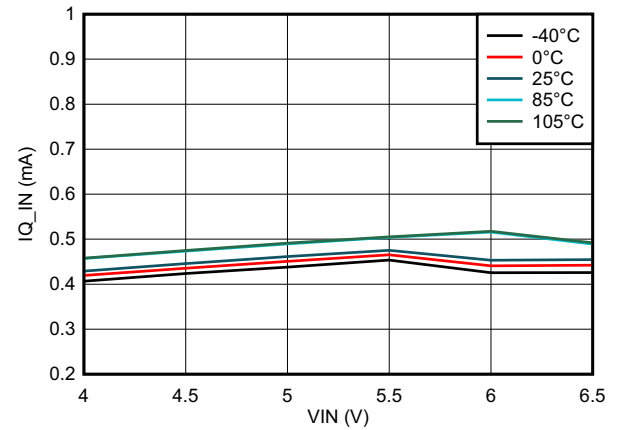

$I_{CHG} = 0 \text{ A}$

$V_{OUT} = 0 \text{ V}$

图 6-8. Input Quiescent Current vs. Input Voltage

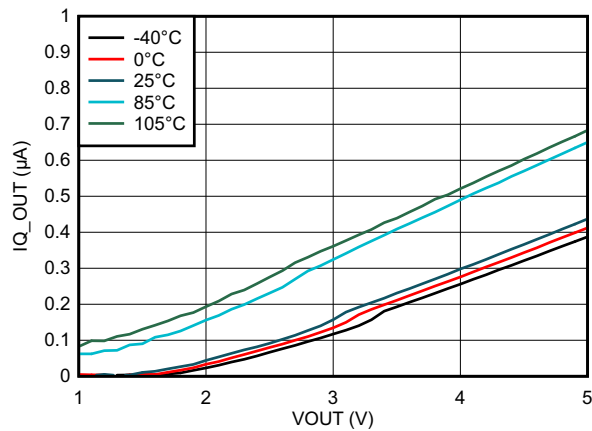

$V_{IN} = 0 \text{ V}$

图 6-9. Output Quiescent Current vs. Output Voltage

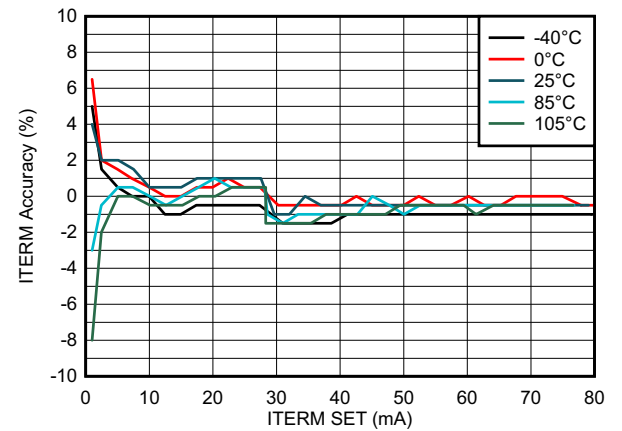

$V_{IN} = 5 \text{ V}$

$V_{OUT} = 4.35 \text{ V}$

图 6-10. Termination Current Accuracy vs. Termination Current Setting

7 Detailed Description

7.1 Overview

The BQ25175 is an integrated 800-mA linear charger for 1-cell Li-Ion/Li-Poly batteries. The device has a single power output that charges the battery. The system load can be placed in parallel with the battery, as long as the average system load does not prevent the battery from charging fully within the safety timer duration. When the system load is placed in parallel with the battery, the input current is shared between the system and the battery.

The device has three phases for charging a Li-Ion/Li-Poly battery: precharge to recover a fully discharged battery, fast-charge constant current to supply the bulk of the charge, and voltage regulation to reach full capacity.

The charger includes flexibility in programming of the fast-charge current. This charger is designed to work with a standard USB connection or dedicated charging adapter (DC output).

The charger also comes with a full set of safety features: battery temperature monitoring, overvoltage protection, charge safety timers, and configuration pin (ISET) short and open protection. All of these features and more are described in detail below.

The charger is designed for a single path from the input to the output to charge the battery. Upon application of a valid input power source, the configuration pins are checked for short/open circuit.

If the battery voltage is below the V_{BAT_LOWV} threshold, the battery is considered discharged and a preconditioning cycle begins. The amount of precharge current is 20% of the programmed fast-charge current via the ISET pin. The t_{PRECHG} safety timer is active, and stops charging after expiration if battery voltage fails to rise above V_{BAT_LOWV} .

Once the battery has charged to the V_{BAT_LOWV} threshold, Fast Charge Mode is initiated, applying the fast charge current and starting the t_{SAFETY} timer. The fast charge constant current is programmed using the ISET pin. The constant current phase provides the bulk of the charge. Power dissipation in the IC is greatest in fast charge with a lower battery voltage. If the IC temperature reaches T_{REG} , the IC enters thermal regulation, slows the timer clock by half, and reduces the charge current as needed to keep the temperature from rising any further. [图 7-1](#) shows the typical lithium battery charging profile with thermal regulation. Under normal operating conditions, the IC junction temperature is less than T_{REG} and thermal regulation is not entered.

Once the battery has charged to the regulation voltage, the voltage loop takes control and holds the battery at the regulation voltage until the current tapers to the termination threshold. The termination threshold is 10% of the programmed fast-charge current.

Further details are described in [节 7.3](#).



图 7-1. Lithium-Ion Battery Charging Profile with Thermal Regulation

7.2 Functional Block Diagram

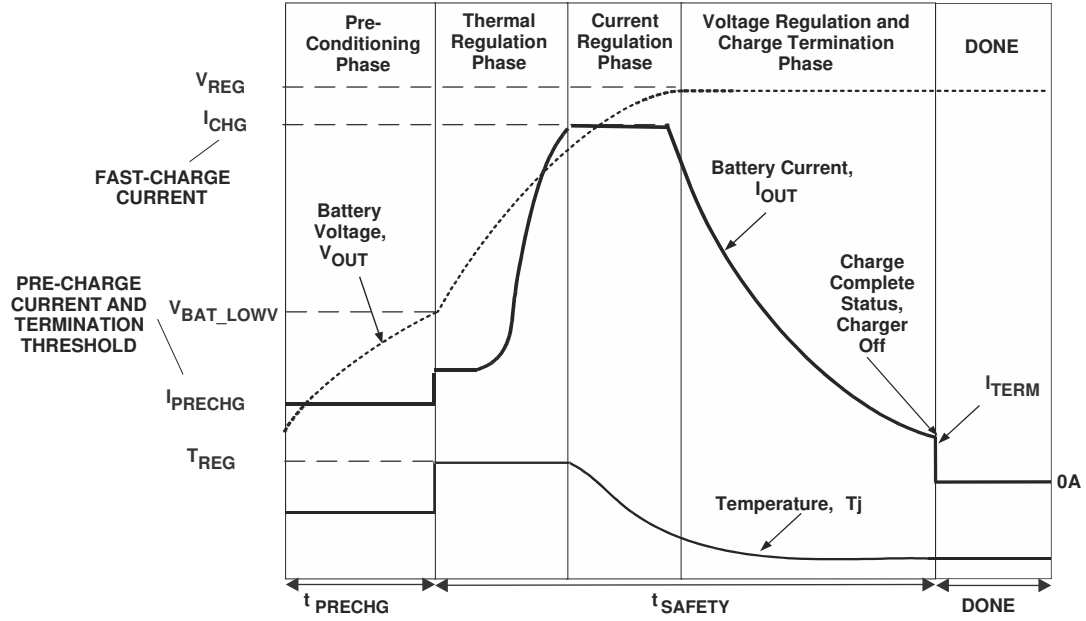
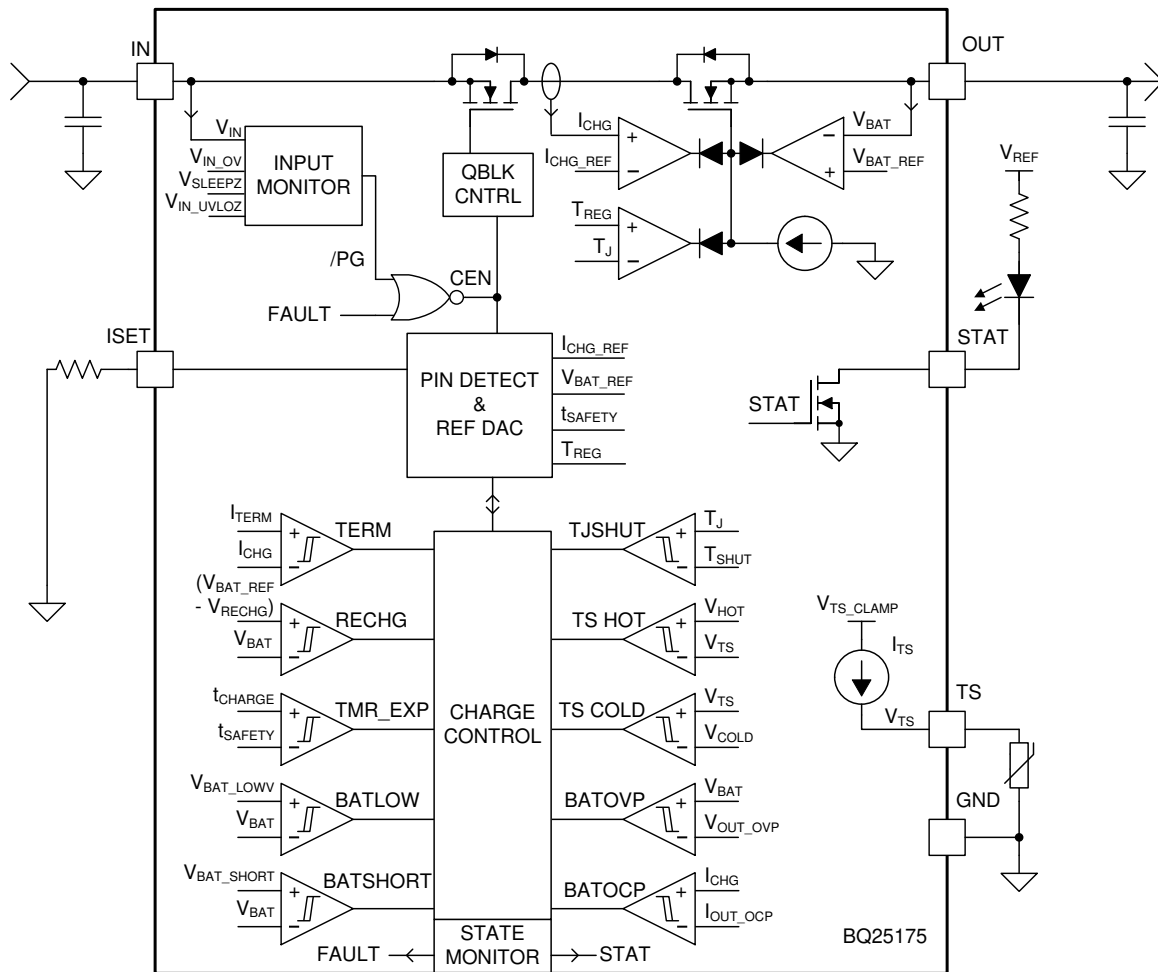

7.3 Feature Description

7.3.1 Device Power Up from Input Source

When an input source is plugged in and charge is enabled, the device checks the input source voltage to turn on all the bias circuits. It detects and sets the charge current and charge voltage limits before the linear regulator is started. The power up sequence from input source is as listed:

1. ISET pin detection
2. Charger power up

7.3.1.1 ISET Pin Detection

After a valid VIN is plugged in, the device checks the resistor on the ISET pin for a short circuit ($R_{ISET} < R_{ISET_SHORT}$). If a short condition is detected, the charger remains in the FAULT state until the input or TS pin is toggled. If the ISET pin is open-circuit, the charger proceeds through pin detection and starts the charger with no charge current. This pin is monitored while charging and changes in R_{ISET} while the charger is operating will immediately translate to changes in charge current.

An external pull-down resistor ($\pm 1\%$ or better is recommended to minimize charge current error) from the ISET pin to GND sets the charge current as:

$$I_{CHG} = \frac{K_{ISET}}{R_{ISET}} \quad (1)$$

where:

- I_{CHG} is the desired fast-charge current
- K_{ISET} is a gain factor found in the electrical specifications
- R_{ISET} is the pull-down resistor from the ISET pin to GND

For charge currents below 50 mA, an extra RC circuit is recommended on ISET to achieve a more stable current signal. For greater accuracy at lower currents, part of the current-sensing FET is disabled to give better resolution.

7.3.1.2 Charger Power Up

After ISET pin resistor values have been validated, the device proceeds to enable the charger. The device automatically begins operation at the correct stage of battery charging depending on the OUT voltage.

7.3.2 Battery Charging Features

When charge is enabled, the device automatically completes a charging cycle according to the setting on the ISET pin without any intervention. The lithium-based charging cycle is automatically terminated when the charging current is below termination threshold, charge voltage is above recharge threshold, and device is not in thermal regulation (TREG). When a full battery is discharged below the recharge threshold (V_{RECHG}), the device automatically starts a new charging cycle. After charge is done, toggling the input supply or the TS pin can initiate a new charging cycle.

7.3.2.1 Lithium-Ion Battery Charging Profile

The device charges a lithium based battery in four phases: trickle charge, precharge, constant current, and constant voltage. At the beginning of a charging cycle, the device checks the battery voltage and regulates current and voltage accordingly.

If the charger is in thermal regulation during charging, the actual charging current is less than the programmed value. In this case, termination is temporarily disabled and the charging safety timer is counted at half the clock rate. For more information, refer to [节 7.3.2.3](#).



图 7-2. Battery Charging Profile

7.3.2.2 Charge Termination and Battery Recharge

The device terminates a charge cycle when the OUT pin voltage is above the recharge threshold (V_{RECHG}) and the current is below the termination threshold (I_{TERM}). Termination is temporarily disabled when the charger device is in thermal regulation. After charge termination is detected, the linear regulator turns off and the device enters the STANDBY state. Once the OUT pin drops below the V_{RECHG} threshold, a new charge cycle is automatically initiated.

7.3.2.3 Charging Safety Timers

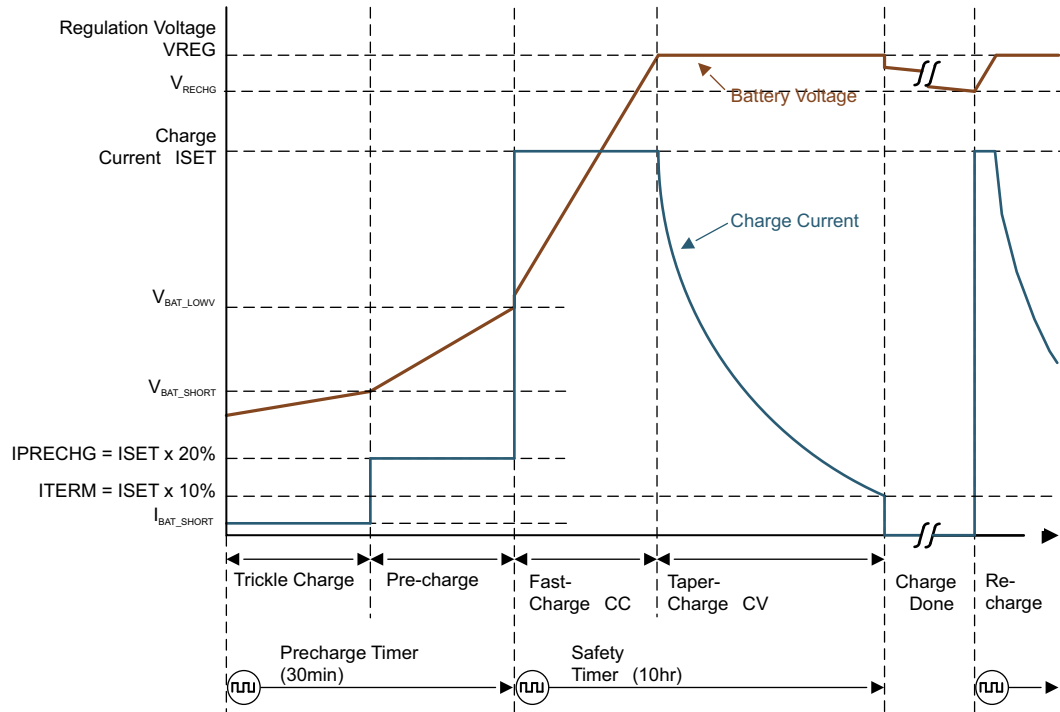
The device has built-in safety timers to prevent an extended charging cycle due to abnormal battery conditions. The precharge timer is fixed at 30 minutes. The fast-charge safety timer is fixed at 10 hours. When the safety timer expires, the charge cycle ends. A toggle on the input supply or TS pin is required to restart a charge cycle after the safety timer has expired.

During thermal regulation, the safety timer counts at half the clock rate as the actual charge current is likely to be below the ISET setting. For example, if the charger is in thermal regulation throughout the whole charging cycle and the safety timer is 10 hours, then the timer will expire in 20 hours.

During faults which disable charging, such as VIN OVP, BAT OVP, TSHUT, or TS faults, the timer is suspended. Once the fault goes away, charging and the safety timer resume. If the charging cycle is stopped and started again, the timer gets reset (toggle of the TS pin restarts the timer).

The safety timer restarts counting for the following events:

1. Charging cycle stop and restart (toggle TS pin, charged battery falls below recharge threshold, or toggle input supply)
2. OUT pin voltage crosses the V_{BAT_LOWV} threshold in either direction

The precharge safety timer (fixed counter that runs when $V_{OUT} < V_{BAT_LOWV}$), follows the same rules as the fast-charge safety timer in terms of getting suspended, reset, and counting at half-rate.

7.3.2.4 Battery Cold, Hot Temperature Qualification (TS Pin)

While charging, the device continuously monitors battery temperature by sensing the voltage at the TS pin. A negative temperature coefficient (NTC) thermistor should be connected between the TS and GND pins (recommend: 103AT-2). If temperature sensing is not required in the application, connect a fixed 10-k Ω resistor from TS to GND to allow normal operation. Battery charging is allowed when the TS pin voltage falls between the V_{COLD} and V_{HOT} thresholds (typically 0°C to 45°C). Charging current is reduced to 20% of the programmed ISET value when $V_{COLD} > TS > V_{COOL}$ (typically 0°C to 10°C). The charging profile can be seen in [图 7-3](#).



图 7-3. BQ25175 Charging Profile

If the TS pin indicates battery temperature is outside this range, the device stops charging, enters the STANDBY state, and blinks the STAT pin. Once battery temperature returns to normal conditions, charging resumes automatically.

In addition to battery temperature sensing, the TS pin can be used to disable the charger at any time by pulling TS voltage below V_{TS_ENZ} . The device disables the charger and consumes $I_{SD_IN_TS}$ from the input supply. In order to minimize quiescent current, the TS current source (I_{TS_BIAS}) is duty-cycled, with an on time of $t_{TS_DUTY_ON}$ and an off time of $t_{TS_DUTY_OFF}$. After the TS pin pulldown is released, the device may take up to $t_{TS_DUTY_OFF}$ to turn the I_{TS_BIAS} back on. After the source is turned on, the TS pin voltage will go above V_{TS_EN} , and re-enable the charger operation. The device treats this TS pin toggle as an input supply toggle, triggering a device power up from input source (see [节 7.3.1](#)).

7.3.3 Status Outputs (STAT)

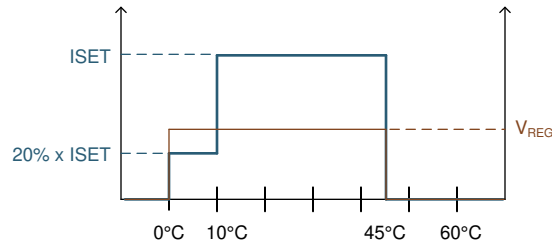
7.3.3.1 Charging Status Indicator (STAT)

The device indicates the charging state on the open-drain STAT pin. This pin can drive an LED.

表 7-1. STAT Pin State

CHARGING STATE	STAT PIN STATE
Charge completed, charger in Sleep mode or charge disabled ($V_{TS} < V_{TS_ENZ}$)	HIGH
Charge in progress (including automatic recharge)	LOW
Fault (VIN OVP, BAT OVP, BAT OCP, TS HOT, TS COLD, TMR_EXP, or ISET pin short)	BLINK at 1 Hz

7.3.4 Protection Features

The device closely monitors input and output voltages, as well as internal FET current and temperature for safe linear regulator operation.

7.3.4.1 Input Overvoltage Protection (VIN OVP)

If the voltage at the IN pin exceeds V_{IN_OV} , the device turns off after a deglitch, $t_{VIN_OV_DGL}$. The safety timer suspends counting and the device enters Standby mode. Once the IN voltage recovers to a normal level, the charge cycle and the safety timer automatically resume operation.

7.3.4.2 Output Overvoltage Protection (BAT OVP)

If the voltage at the OUT pin exceeds V_{OUT_OVP} , the device immediately stops charging. The safety timer suspends counting and the device enters Standby mode. Once the OUT voltage recovers to a normal level, the charge cycle and the safety timer resume operation.

7.3.4.3 Output Overcurrent Protection (BAT OCP)

During normal operation, the OUT current should be regulated to the ISET programmed value. However, if a short circuit occurs on the ISET pin, the OUT current may rise to an unintended level. If the current at the OUT pin exceeds I_{OUT_OCP} , the device turns off after a deglitch, $t_{OUT_OCP_DGL}$. The safety timer resets the count, and the device remains latched off. An input supply or TS pin toggle is required to restart operation.



图 7-4. Overcurrent Protection

7.3.4.4 Thermal Regulation and Thermal Shutdown (TREG and TSHUT)

The device monitors its internal junction temperature (T_J) to avoid overheating and to limit the IC surface temperature. When the internal junction temperature exceeds the thermal regulation limit, the device automatically reduces the charge current to maintain the junction temperature at the thermal regulation limit (TREG). During thermal regulation, the actual charging current is usually below the programmed value on the ISET pin.

Therefore, the termination comparator for the Lithium-Ion battery is disabled, and the safety timer runs at half the clock rate.

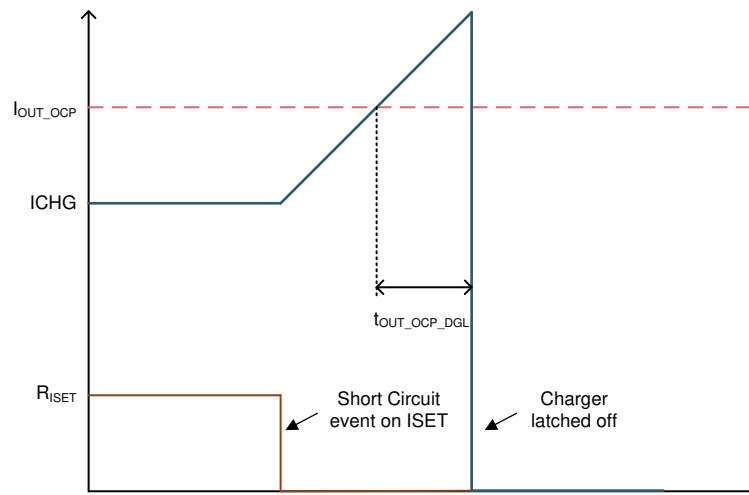
Additionally, the device has thermal shutdown to turn off the linear regulator when the IC junction temperature exceeds the TSHUT threshold. The charger resumes operation when the IC die temperature decreases below the TSHUT falling threshold.

7.4 Device Functional Modes

7.4.1 Shutdown or Undervoltage Lockout (UVLO)

The device is in the shutdown state if the IN pin voltage is less than V_{IN_LOWV} or the TS pin is below V_{TS_ENZ} . The internal circuitry is powered down, all the pins are high impedance, and the device draws $I_{SD_IN_TS}$ from the input supply. Once the IN voltage rises above the V_{IN_LOW} threshold and the TS pin is above V_{TS_EN} , the IC enters Sleep mode or Active mode depending on the OUT pin voltage.

7.4.2 Sleep Mode

The device is in Sleep mode when $V_{IN_LOWV} < V_{IN} < V_{OUT} + V_{SLEEPZ}$. The device waits for the input voltage to rise above $V_{OUT} + V_{SLEEPZ}$ to start operation.

7.4.3 Active Mode

The device is powered up and charges the battery when the TS pin is above V_{TS_ENZ} and the IN voltage ramps above both V_{IN_LOWV} and $V_{OUT} + V_{SLEEPZ}$. The device draws I_{Q_IN} from the supply to bias the internal circuitry. For details on the device power-up sequence, refer to [节 7.3.1](#).

7.4.3.1 Standby Mode

The device is in Standby mode if a valid input supply is present and charge is terminated or if a recoverable fault is detected. The internal circuitry is partially biased, and the device continues to monitor for either VOUT to drop below V_{RECHG} or the recoverable fault to be removed.

7.4.4 Fault Mode

The fault conditions are categorized into recoverable and nonrecoverable as follows:

- Recoverable, from which the device should automatically recover once the fault condition is removed:
 - VIN OVP
 - BAT OVP
 - TS HOT
 - TS COLD
- Nonrecoverable, requiring pin or input supply toggle to resume operation:
 - BAT OCP
 - ISET pin short detected

8 Application and Implementation

Note

以下应用部分中的信息不属于 TI 器件规格的范围，TI 不担保其准确性和完整性。TI 的客户应负责确定器件是否适用于其应用。客户应验证并测试其设计，以确保系统功能。

8.1 Application Information

A typical application consists of the device configured as a standalone battery charger for single-cell Li-Ion or Li-Poly chemistries. The charge current is configured using a pulldown resistor on the ISET pin. A battery thermistor can be connected to the TS pin to allow the device to monitor battery temperature and control charging. Pulling the TS pin below V_{TS_ENZ} disables the charging function. Charger status is reported via the STAT pin.

8.2 Typical Applications

8.2.1 Li-Ion Charger Design Example



图 8-1. BQ25175 Typical Application for 1s Li-Ion Charging at 100 mA

8.2.1.1 Design Requirements

- Input supply up-to 6.6 V
- Battery is 1-cell Li-ion
- Fast charge current: $I_{CHG} = 300 \text{ mA}$
- Charge voltage: $V_{REG} = 4.35 \text{ V}$
- Termination current: $I_{TERM} = 10\% \text{ of } I_{CHG} \text{ or } 30 \text{ mA}$
- Precharge current: $I_{PRECHG} = 20\% \text{ of } I_{CHG} \text{ or } 60 \text{ mA}$
- TS – Battery temperature sense = 10-k Ω NTC (103AT)
 - Charging allowed between battery temperatures of 0°C to 45°C, with charge current reduction ($I_{OUT} = 20\% \times I_{SET}$) between 0°C and 10°C
- TS pin can be pulled low to disable charging or left floating to enable charging

8.2.1.2 Detailed Design Procedure

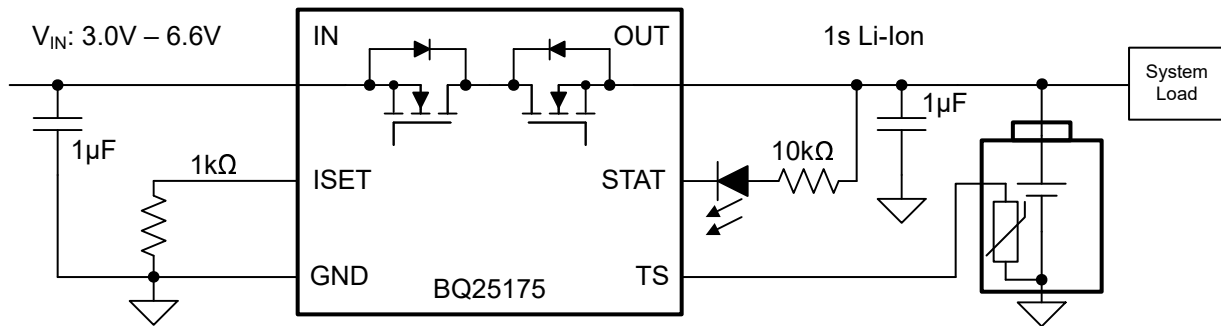
Regulation voltage is fixed to 4.35 V, input voltage is 5 V, and charge current is programmed via the ISET pin to 300 mA.

$$R_{ISET} = [K_{ISET} / I_{CHG}]$$

from the Electrical Characteristics table $K_{ISET} = 300 \text{ A}\Omega$

$$R_{ISET} = [300 \text{ A}\Omega / 0.3 \text{ A}] = 1000 \Omega$$

8.2.1.2.1 TS Function

Use a 10-k Ω NTC thermistor in the battery pack (recommend: 103AT-2). The V_{COLD} and V_{HOT} thresholds in this data sheet are designed to meet a charging window between 0°C and 45°C for a 10-k Ω NTC with $\beta = 3435 \text{ K}$.

To disable the TS sense function, use a fixed 10-k Ω resistor between the TS pin and GND. The TS pin can be pulled down to disable charging.

BQ25175

ZHCS024A - JUNE 2021 - REVISED SEPTEMBER 2021

8.2.1.3 Application Curves

$C_{IN} = 1 \mu F$, $C_{OUT} = 1 \mu F$, $V_{IN} = 5 V$, $I_{CHG} = 200 mA$ (unless otherwise specified)

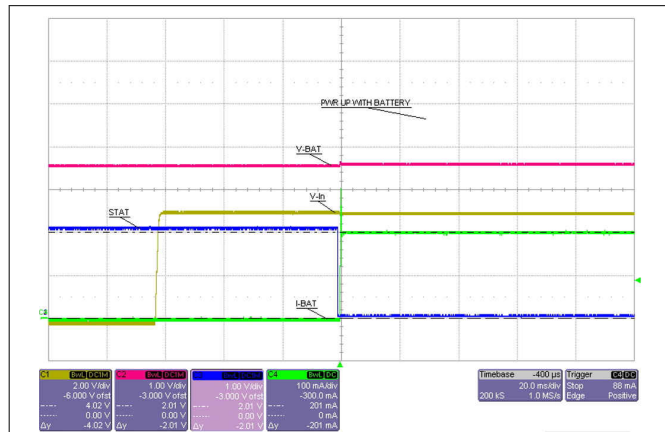

$R_{ISET} = 1.2 k\Omega$

图 8-2. Power Up with Battery

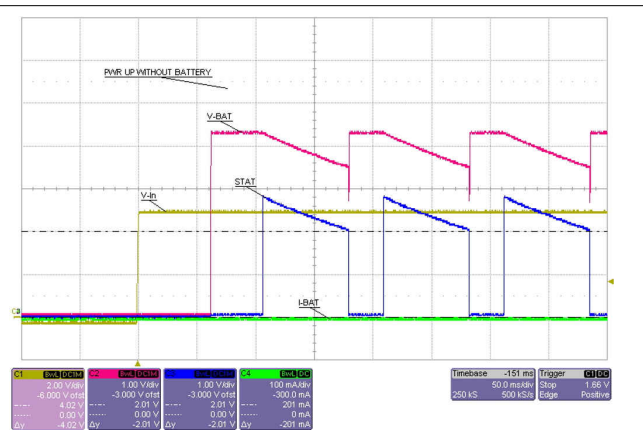

$R_{ISET} = 1.2 k\Omega$ OUT = open-circuit

图 8-3. Power Up without Battery

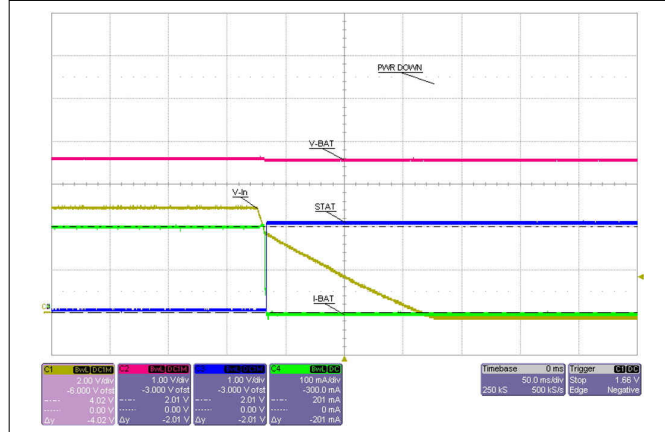

$V_{IN} = 5V \rightarrow 0V$

图 8-4. Power Down

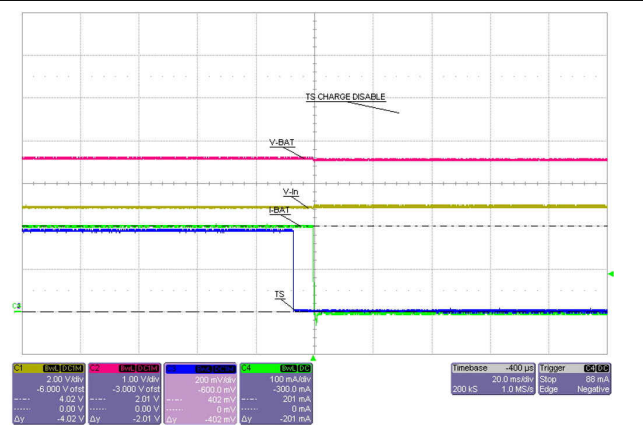

TS pulled LOW

图 8-5. Charge Disable

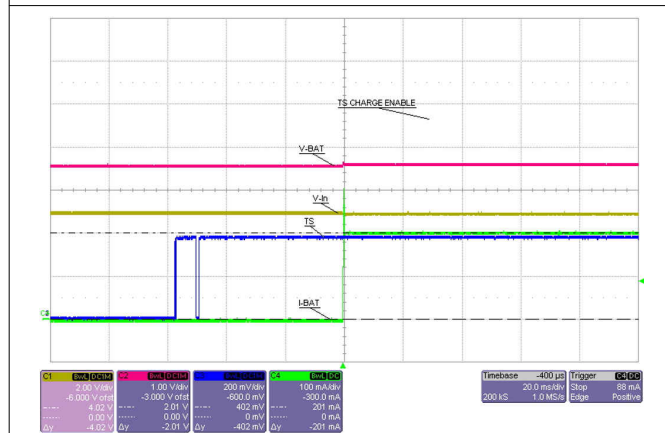

TS pin released

图 8-6. Charge Enable



图 8-7. IN OVP Response



$V_{OUT} = V_{REG} = 3.5\text{ V} \rightarrow 0\text{ V}$

图 8-8. OUT Short-Circuit Response

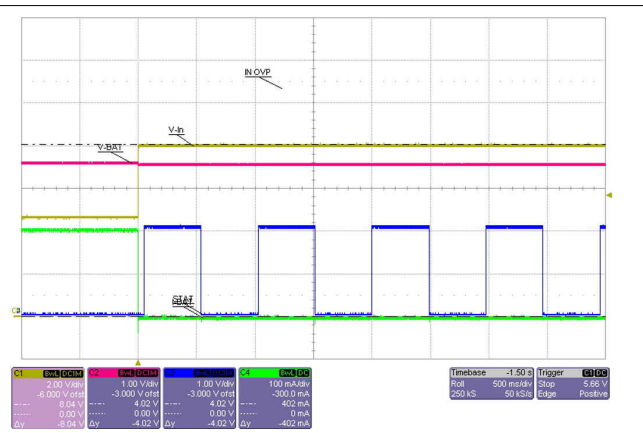
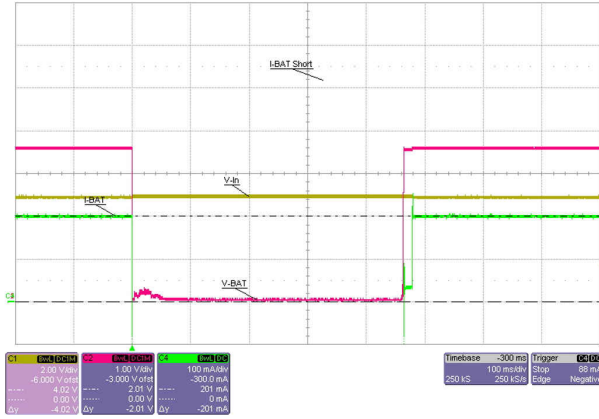
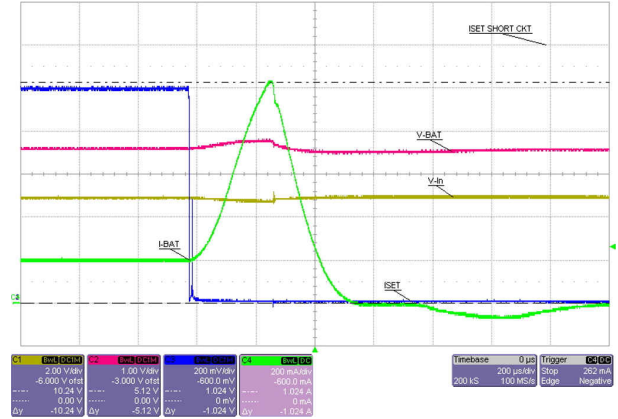

$I_{SET} = 1.5\text{ k}\Omega \rightarrow 0\Omega$

图 8-9. ISET Short-Circuit Response

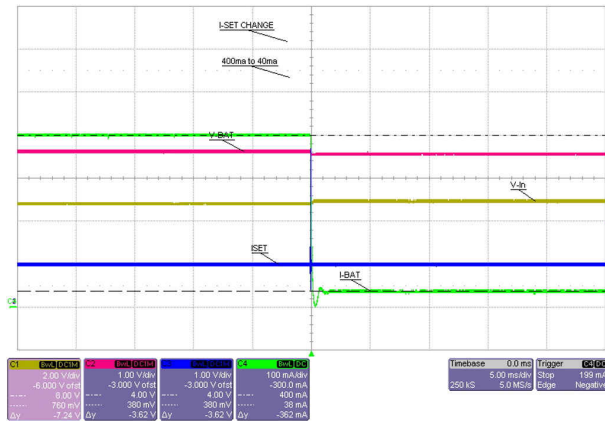

$I_{SET} = 400\text{ mA} \rightarrow 40\text{ mA}$

图 8-10. ISET Change Response



图 8-11. TS Change Response

9 Power Supply Recommendations

The device is designed to operate from an input voltage supply range between 3.0 V and 6.6 V (up to 30 V tolerant) and current capability of at least the maximum designed charge current. If located more than a few inches from the IN and GND pins, a larger capacitor is recommended.

10 Layout

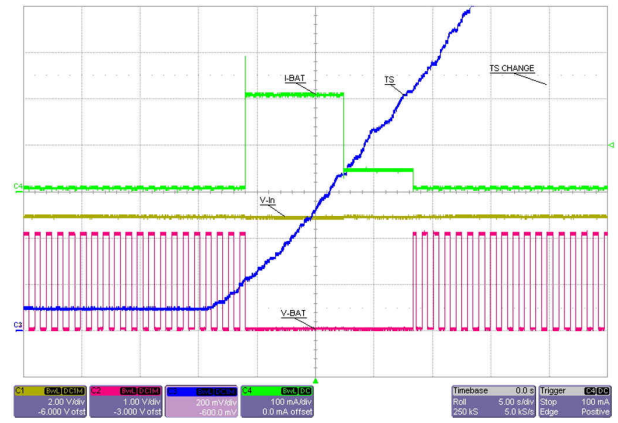
10.1 Layout Guidelines

To obtain optimal performance, the decoupling capacitor from the IN pin to the GND pin and the output filter capacitor from the OUT pin to the GND pin should be placed as close as possible to the device, with short trace runs to both IN, OUT, and GND.

- All low-current GND connections should be kept separate from the high-current charge or discharge paths from the battery. Use a single-point ground technique incorporating both the small signal ground path and the power ground path.
- The high current charge paths into the IN pin and from the OUT pin must be sized appropriately for the maximum charge current in order to avoid voltage drops in these traces.

10.2 Layout Example



图 10-1. BQ25175 Board Layout Example

11 Device and Documentation Support

11.1 Device Support

11.1.1 第三方产品免责声明

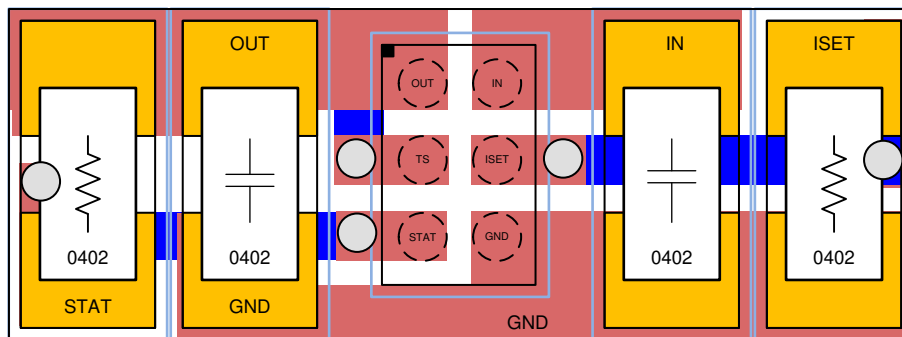
TI 发布的与第三方产品或服务有关的信息，不能构成与此类产品或服务或保修的适用性有关的认可，不能构成此类产品或服务单独或与任何 TI 产品或服务一起的表示或认可。

11.2 接收文档更新通知

要接收文档更新通知，请导航至 ti.com 上的器件产品文件夹。点击 [订阅更新](#) 进行注册，即可每周接收产品信息更改摘要。有关更改的详细信息，请查看任何已修订文档中包含的修订历史记录。

11.3 支持资源

[TI E2E™ 支持论坛](#) 是工程师的重要参考资料，可直接从专家获得快速、经过验证的解答和设计帮助。搜索现有解答或提出自己的问题可获得所需的快速设计帮助。

链接的内容由各个贡献者“按原样”提供。这些内容并不构成 TI 技术规范，并且不一定反映 TI 的观点；请参阅 TI 的 [《使用条款》](#)。

11.4 Trademarks

TI E2E™ is a trademark of Texas Instruments.

所有商标均为其各自所有者的财产。

11.5 Electrostatic Discharge Caution



This integrated circuit can be damaged by ESD. Texas Instruments recommends that all integrated circuits be handled with appropriate precautions. Failure to observe proper handling and installation procedures can cause damage.

ESD damage can range from subtle performance degradation to complete device failure. Precision integrated circuits may be more susceptible to damage because very small parametric changes could cause the device not to meet its published specifications.

11.6 术语表

[TI 术语表](#) 本术语表列出并解释了术语、首字母缩略词和定义。

12 Mechanical, Packaging, and Orderable Information

The following pages include mechanical, packaging, and orderable information. This information is the most current data available for the designated devices. This data is subject to change without notice and revision of this document. For browser-based versions of this data sheet, refer to the left-hand navigation.

重要声明和免责声明

TI 提供技术和可靠性数据 (包括数据表)、设计资源 (包括参考设计)、应用或其他设计建议、网络工具、安全信息和其他资源, 不保证没有瑕疵且不做任何明示或暗示的担保, 包括但不限于对适销性、某特定用途方面的适用性或不侵犯任何第三方知识产权的暗示担保。

这些资源可供使用 TI 产品进行设计的熟练开发人员使用。您将自行承担以下全部责任: (1) 针对您的应用选择合适的 TI 产品, (2) 设计、验证并测试您的应用, (3) 确保您的应用满足相应标准以及任何其他安全、安保或其他要求。这些资源如有变更, 恕不另行通知。TI 授权您仅可将这些资源用于研发本资源所述的 TI 产品的应用。严禁对这些资源进行其他复制或展示。您无权使用任何其他 TI 知识产权或任何第三方知识产权。您应全额赔偿因在这些资源的使用中对 TI 及其代表造成的任何索赔、损害、成本、损失和债务, TI 对此概不负责。

TI 提供的产品受 TI 的销售条款 (<https://www.ti.com/legal/termsofsale.html>) 或 [ti.com](https://www.ti.com) 上其他适用条款/TI 产品随附的其他适用条款的约束。TI 提供这些资源并不会扩展或以其他方式更改 TI 针对 TI 产品发布的适用的担保或担保免责声明。

邮寄地址: Texas Instruments, Post Office Box 655303, Dallas, Texas 75265

Copyright © 2021, 德州仪器 (TI) 公司

PACKAGING INFORMATION

Orderable part number	Status (1)	Material type (2)	Package Pins	Package qty Carrier	RoHS (3)	Lead finish/ Ball material (4)	MSL rating/ Peak reflow (5)	Op temp (°C)	Part marking (6)
BQ25175YBGR	Active	Production	DSBGA (YBG) 6	3000 LARGE T&R	Yes	SNAGCU	Level-1-260C-UNLIM	-40 to 85	B75
BQ25175YBGR.A	Active	Production	DSBGA (YBG) 6	3000 LARGE T&R	Yes	SNAGCU	Level-1-260C-UNLIM	-40 to 85	B75

(1) **Status:** For more details on status, see our [product life cycle](#).

(2) **Material type:** When designated, preproduction parts are prototypes/experimental devices, and are not yet approved or released for full production. Testing and final process, including without limitation quality assurance, reliability performance testing, and/or process qualification, may not yet be complete, and this item is subject to further changes or possible discontinuation. If available for ordering, purchases will be subject to an additional waiver at checkout, and are intended for early internal evaluation purposes only. These items are sold without warranties of any kind.

(3) **RoHS values:** Yes, No, RoHS Exempt. See the [TI RoHS Statement](#) for additional information and value definition.

(4) **Lead finish/Ball material:** Parts may have multiple material finish options. Finish options are separated by a vertical ruled line. Lead finish/Ball material values may wrap to two lines if the finish value exceeds the maximum column width.

(5) **MSL rating/Peak reflow:** The moisture sensitivity level ratings and peak solder (reflow) temperatures. In the event that a part has multiple moisture sensitivity ratings, only the lowest level per JEDEC standards is shown. Refer to the shipping label for the actual reflow temperature that will be used to mount the part to the printed circuit board.

(6) **Part marking:** There may be an additional marking, which relates to the logo, the lot trace code information, or the environmental category of the part.

Multiple part markings will be inside parentheses. Only one part marking contained in parentheses and separated by a "~" will appear on a part. If a line is indented then it is a continuation of the previous line and the two combined represent the entire part marking for that device.

Important Information and Disclaimer: The information provided on this page represents TI's knowledge and belief as of the date that it is provided. TI bases its knowledge and belief on information provided by third parties, and makes no representation or warranty as to the accuracy of such information. Efforts are underway to better integrate information from third parties. TI has taken and continues to take reasonable steps to provide representative and accurate information but may not have conducted destructive testing or chemical analysis on incoming materials and chemicals. TI and TI suppliers consider certain information to be proprietary, and thus CAS numbers and other limited information may not be available for release.

In no event shall TI's liability arising out of such information exceed the total purchase price of the TI part(s) at issue in this document sold by TI to Customer on an annual basis.

TAPE AND REEL INFORMATION

QUADRANT ASSIGNMENTS FOR PIN 1 ORIENTATION IN TAPE

*All dimensions are nominal

Device	Package Type	Package Drawing	Pins	SPQ	Reel Diameter (mm)	Reel Width W1 (mm)	A0 (mm)	B0 (mm)	K0 (mm)	P1 (mm)	W (mm)	Pin1 Quadrant
BQ25175YBGR	DSBGA	YBG	6	3000	180.0	8.4	0.92	1.26	0.55	2.0	8.0	Q1

TAPE AND REEL BOX DIMENSIONS

*All dimensions are nominal

Device	Package Type	Package Drawing	Pins	SPQ	Length (mm)	Width (mm)	Height (mm)
BQ25175YBGR	DSBGA	YBG	6	3000	182.0	182.0	20.0

YBG0006

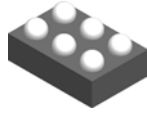

PACKAGE OUTLINE

DSBGA - 0.5 mm max height

DIE SIZE BALL GRID ARRAY

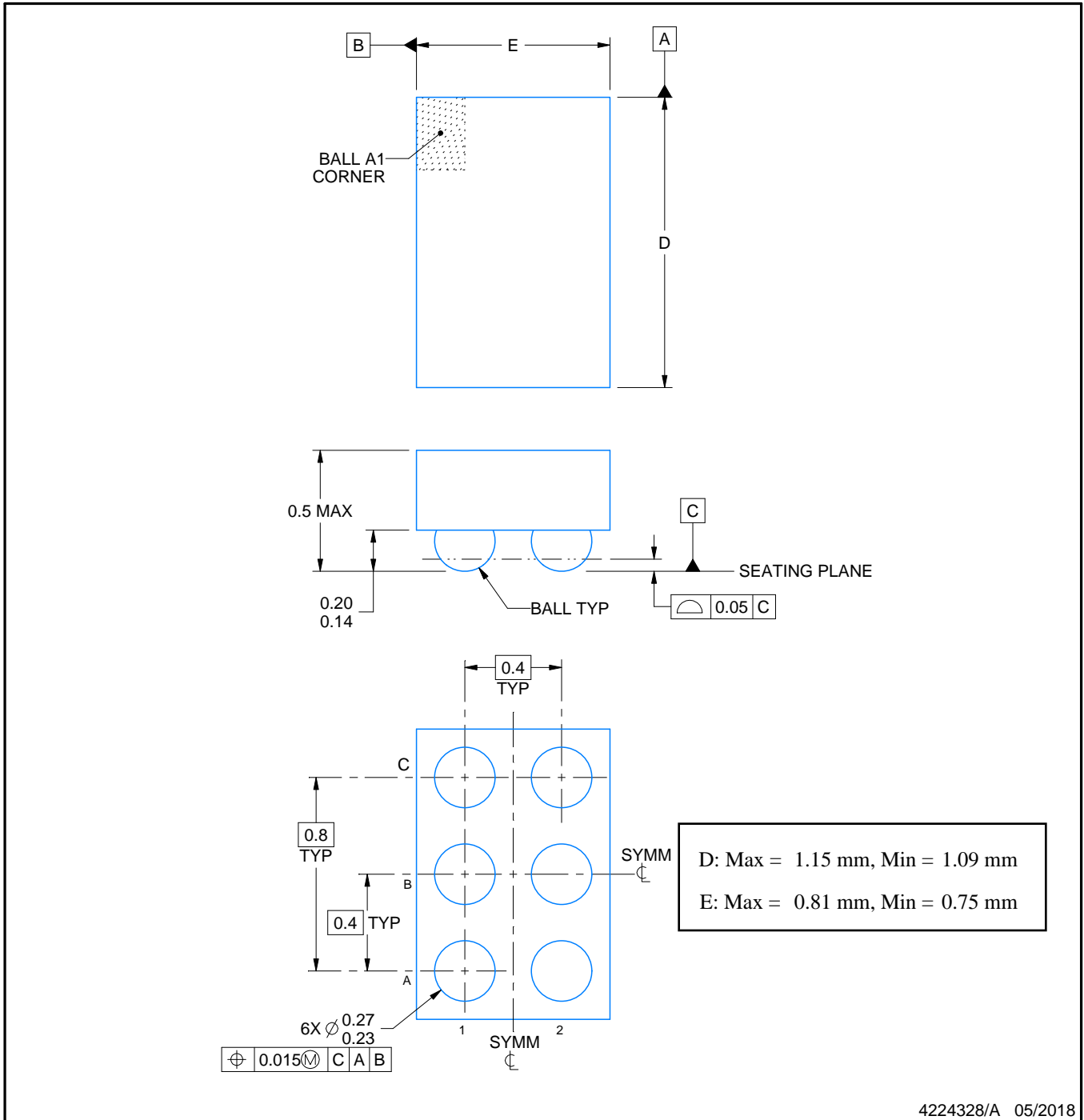

NOTES:

1. All linear dimensions are in millimeters. Any dimensions in parenthesis are for reference only. Dimensioning and tolerancing per ASME Y14.5M.
2. This drawing is subject to change without notice.

EXAMPLE BOARD LAYOUT

YBG0006

DSBGA - 0.5 mm max height

DIE SIZE BALL GRID ARRAY

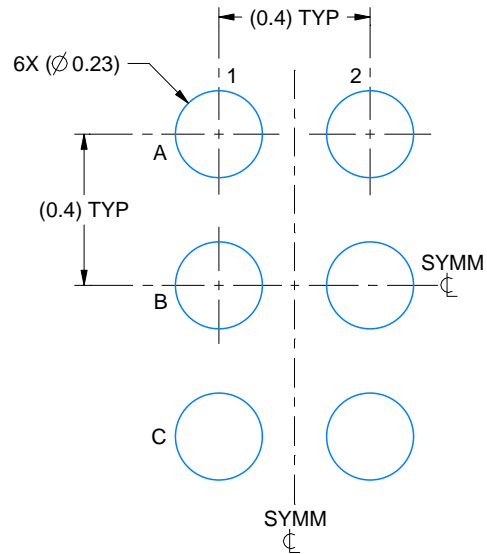

LAND PATTERN EXAMPLE
EXPOSED METAL SHOWN
SCALE: 50X

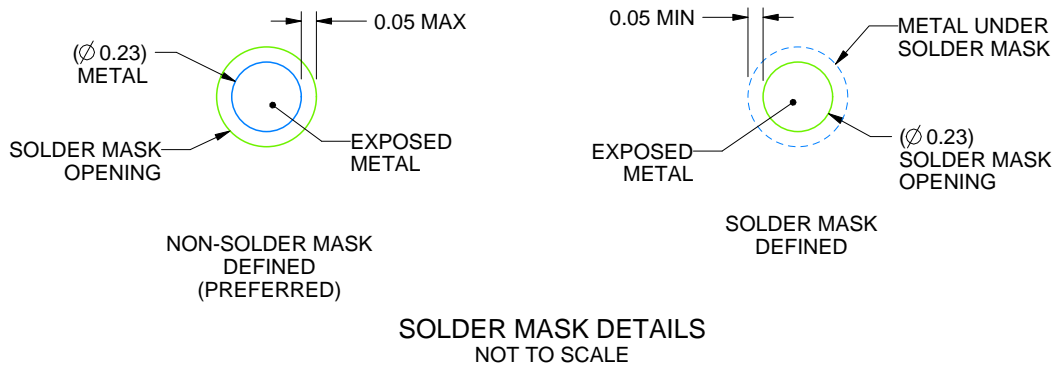

SOLDER MASK DETAILS
NOT TO SCALE

4224328/A 05/2018

NOTES: (continued)

- Final dimensions may vary due to manufacturing tolerance considerations and also routing constraints. See Texas Instruments Literature No. SNVA009 (www.ti.com/lit/snva009).

EXAMPLE STENCIL DESIGN

YBG0006

DSBGA - 0.5 mm max height

DIE SIZE BALL GRID ARRAY

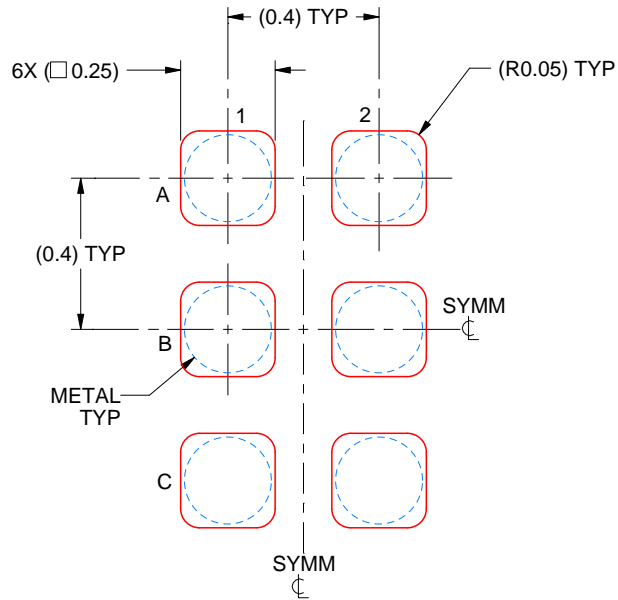

SOLDER PASTE EXAMPLE
BASED ON 0.1 mm THICK STENCIL
SCALE: 50X

4224328/A 05/2018

NOTES: (continued)

4. Laser cutting apertures with trapezoidal walls and rounded corners may offer better paste release.

重要通知和免责声明

TI“按原样”提供技术和可靠性数据（包括数据表）、设计资源（包括参考设计）、应用或其他设计建议、网络工具、安全信息和其他资源，不保证没有瑕疵且不做任何明示或暗示的担保，包括但不限于对适销性、与某特定用途的适用性或不侵犯任何第三方知识产权的暗示担保。

这些资源可供使用 TI 产品进行设计的熟练开发人员使用。您将自行承担以下全部责任：(1) 针对您的应用选择合适的 TI 产品，(2) 设计、验证并测试您的应用，(3) 确保您的应用满足相应标准以及任何其他安全、安保法规或其他要求。

这些资源如有变更，恕不另行通知。TI 授权您仅可将这些资源用于研发本资源所述的 TI 产品的相关应用。严禁以其他方式对这些资源进行复制或展示。您无权使用任何其他 TI 知识产权或任何第三方知识产权。对于因您对这些资源的使用而对 TI 及其代表造成的任何索赔、损害、成本、损失和债务，您将全额赔偿，TI 对此概不负责。

TI 提供的产品受 [TI 销售条款](#)、[TI 通用质量指南](#) 或 [ti.com](#) 上其他适用条款或 TI 产品随附的其他适用条款的约束。TI 提供这些资源并不会扩展或以其他方式更改 TI 针对 TI 产品发布的适用的担保或担保免责声明。除非德州仪器 (TI) 明确将某产品指定为定制产品或客户特定产品，否则其产品均为按确定价格收入目录的标准通用器件。

TI 反对并拒绝您可能提出的任何其他或不同的条款。

版权所有 © 2025，德州仪器 (TI) 公司

最后更新日期：2025 年 10 月