

DACx311 采用 SC70 封装的 2V 至 5.5V、80 μ A、8 位、10 位和 12 位低功耗、单通道数模转换器

1 特性

- 相对精度：
 - 0.25 LSB INL (DAC5311 : 8 位)
 - 0.5 LSB INL (DAC6311 : 10 位)
 - 1 LSB INL (DAC7311 : 12 位)
- 低功耗运行：2.0 V 时为 80 μ A
- 断电：5V 时为 0.5 μ A，2.0V 时为 0.1 μ A
- 宽电源：2.0V 至 5.5V
- 上电复位至零标度
- 直接二进制数据格式
- 具有施密特触发输入的低功耗串口：高达 50MHz
- 片上输出缓冲放大器，轨到轨运行
- $\overline{\text{SYNC}}$ 中断设施
- 工作温度范围为 -40°C 至 +125°C
- 采用微型 6 引脚 SC70 封装的引脚兼容系列

2 应用

- 便携式电池供电仪器
- 4mA 至 20mA 环路供电应用
- [过程控制和工业自动化](#)
- [可编程电压源和电流源](#)

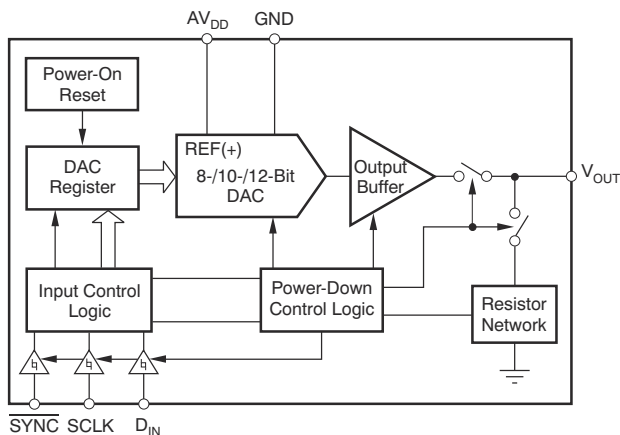

简化原理图

3 说明

8 位 DAC5311、10 位 DAC6311 和 12 位 DAC7311 (DACx311) 是低功耗、单通道、电压输出数模转换器 (DAC)。DACx311 在正常工作状态下具有低功耗 (5V 时为 0.55mW，断电模式下可降至 2.5 μ W)，使其成为便携式电池供电应用的理想选择。

这些器件采用单调性设计，提供出色的线性度，并且大大降低了有害的码字间瞬态电压，同时在引脚兼容系列中提供简单的升级路径。所有器件均使用一个以高达 50MHz 的时钟速率运行的多功能 3 线制串行接口，并与标准 SPI、QSPI、Microwire 和数字信号处理器 (DSP) 接口兼容。

所有器件均使用外部电源作为基准电压来设置输出范围。该器件包含一个上电复位 (POR) 电路，可在 0V 时为 DAC 输出上电，并保持为 0V，直到对器件进行有效写入。DACx311 包含一个由串口访问的断电特性，这将器件处于断电模式时在电压为 2.0V 时的功耗减少至 0.1 μ A。

这些器件与 DAC8311 和 DAC8411 引脚兼容，可从 8 位、10 位和 12 位分辨率轻松升级到 14 位和 16 位。所有器件均采用小型 6 引脚 SC70 (SOT) 封装。此封装可使本系列中的 DAC 在 -40°C 至 +125°C 的工作温度范围内具有灵活性、实现引脚兼容和功能兼容并且可直接插入使用。

器件信息(1)

器件型号(2)	分辨率	封装尺寸(3)
DAC7311	12 位	DCK (SC70 , 6) 2mm × 1.5mm
DAC6311	10 位	
DAC5311	8 位	

- (1) 如需了解所有可用封装，请参阅数据表末尾的封装选项附录。
- (2) 请参阅 [器件比较表](#)。
- (3) 封装尺寸 (长 × 宽) 为标称值，并包括引脚 (如适用)。



Table of Contents

1 特性	1	8.1 Overview.....	22
2 应用	1	8.2 Functional Block Diagram.....	22
3 说明	1	8.3 Feature Description.....	22
4 Revision History	2	8.4 Device Functional Modes.....	24
5 Device Comparison	3	8.5 Programming.....	25
6 Pin Configuration and Functions	3	9 Application and Implementation	27
7 Specifications	4	9.1 Application Information.....	27
7.1 Absolute Maximum Ratings.....	4	9.2 Typical Applications	28
7.2 ESD Ratings.....	4	9.3 Power Supply Recommendations.....	31
7.3 Recommended Operating Conditions.....	4	9.4 Layout.....	32
7.4 Thermal Information.....	4	10 Device and Documentation Support	33
7.5 Electrical Characteristics.....	5	10.1 接收文档更新通知.....	33
7.6 Timing Requirements.....	7	10.2 支持资源.....	33
7.7 Timing Diagrams	7	10.3 Trademarks.....	33
7.8 Typical Characteristics: $AV_{DD} = 5\text{ V}$	8	10.4 静电放电警告.....	33
7.9 Typical Characteristics: $AV_{DD} = 3.6\text{ V}$	15	10.5 术语表.....	33
7.10 Typical Characteristics: $AV_{DD} = 2.7\text{ V}$	16	11 Mechanical, Packaging, and Orderable Information	33
8 Detailed Description	22		

4 Revision History

注：以前版本的页码可能与当前版本的页码不同

Changes from Revision C (July 2015) to Revision D (August 2023)	Page
• 更新了整个文档中的表格、图和交叉参考的编号格式.....	1
• 将英文器件信息表中的“body size”更改为“package size”，并添加了内容以显示不同器件之间的差异.....	1
• Changed power dissipation max value for normal mode at $AV_{DD} = 3.6\text{ V}$ to 5.5 V from 0.88 mW to 0.99 mW in <i>Electrical Characteristics</i>	5
• Changed I_{DD} max value for normal mode at $AV_{DD} = 3.6\text{ V}$ to 5.5 V from $160\text{ }\mu\text{A}$ to $180\text{ }\mu\text{A}$ in <i>Electrical Characteristics</i>	5
Changes from Revision B (May 2013) to Revision C (July 2015)	Page
• 添加了 ESD 等级表和特性说明、器件功能模式、应用和实施、电源相关建议、布局、器件和文档支持以及机械、封装和可订购信息部分.....	1
• Added <i>Device Comparison</i> section and moved existing tables to this new section.....	3
• Moved <i>Operating Temperature</i> parameter from <i>Electrical Characteristics</i> table to <i>Recommended Operating Conditions</i> table	4
• Deleted <i>Parameter Definitions</i> section; definitions moved to new <i>Glossary</i> section.....	33
Changes from Revision A (August 2011) to Revision B (May 2013)	Page
• 将整个数据表中的所有 1.8 V 更改为 2.0 V	1
• Deleted the 1.8-V Typical Characteristics section.....	8
• Changed X-axis for Figure 7-36, Power-Supply Current vs Power-Supply Voltage.....	8
• Changed X-axis for Figure 7-37, Power-Down Current vs Power-Supply Voltage.....	8
Changes from Revision * (August, 2008) to Revision A (August, 2011)	Page
• Changed specifications and test conditions for input low voltage parameter.....	5
• Changed specifications and test conditions for input high voltage parameter.....	5

5 Device Comparison

表 5-1. Related Devices

RELATED DEVICES	16-BIT	14-BIT	12-BIT	10-BIT	8-BIT
Pin and Function Compatible	DAC8411	DAC8311	DAC7311	DAC6311	DAC5311

表 5-2. Relative Accuracy and Differential Nonlinearity

DEVICE	MAXIMUM RELATIVE ACCURACY (LSB)	MAXIMUM DIFFERENTIAL NONLINEARITY (LSB)
DAC5311	±0.25	±0.25
DAC6311	±0.5	±0.5
DAC7311	±1	±1

6 Pin Configuration and Functions



图 6-1. DCK Package, 6-Pin SC70 (Top View)

表 6-1. Pin Functions

PIN		TYPE	DESCRIPTION
NAME	NO.		
AV _{DD} /V _{REF}	4	Input	Power supply input, 2.0 V to 5.5 V.
D _{IN}	3	Input	Serial Data Input. Data are clocked into the 16-bit input shift register on the falling edge of the serial clock input.
GND	5	—	Ground reference point for all circuitry on the part.
SCLK	2	Input	Serial clock input. Data are transferred at rates up to 50 MHz.
SYNC	1	Input	Level-triggered control input (active low). This pin is the frame synchronization signal for the input data. When SYNC goes low, the input shift register is enabled and data are transferred in on the falling edges of the following clocks. The DAC is updated following 16th clock cycle, unless SYNC is taken high before this edge, in which case the rising edge of SYNC acts as an interrupt and the write sequence is ignored by the DACx311. See the <i>SYNC Interrupt</i> section for more details.
V _{OUT}	6	Output	Analog output voltage from DAC. The output amplifier has rail-to-rail operation.

7 Specifications

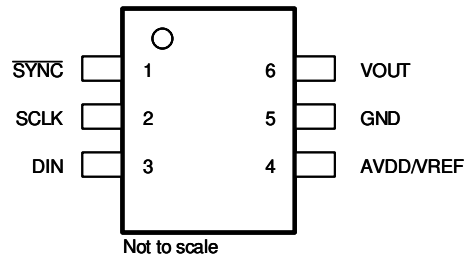
7.1 Absolute Maximum Ratings

over operating free-air temperature range (unless otherwise noted) ⁽¹⁾

			MIN	MAX	UNIT
	Voltage	AV _{DD} to GND	- 0.3	+6	V
		Digital input voltage to GND	- 0.3	+AV _{DD} + 0.3	V
		V _{OUT} to GND	- 0.3	+AV _{DD} + 0.3	V
T _J	Junction temperature		150	°C	
T _{stg}	Storage temperature		- 65	150	°C

- (1) Stresses beyond those listed under *Absolute Maximum Ratings* may cause permanent damage to the device. These are stress ratings only, which do not imply functional operation of the device at these or any other conditions beyond those indicated under *Recommended Operating Conditions*. Exposure to absolute-maximum-rated conditions for extended periods may affect device reliability.

7.2 ESD Ratings

			VALUE	UNIT
V _(ESD)	Electrostatic discharge	Human-body model (HBM), per ANSI/ESDA/JEDEC JS-001 ⁽¹⁾	±1000	V
		Charged-device model (CDM), per JEDEC specification JESD22-C101 ⁽²⁾	±500	

- (1) JEDEC document JEP155 states that 500-V HBM allows safe manufacturing with a standard ESD control process.
(2) JEDEC document JEP157 states that 250-V CDM allows safe manufacturing with a standard ESD control process.

7.3 Recommended Operating Conditions

over operating free-air temperature range (unless otherwise noted)

		MIN	NOM	MAX	UNIT
T _A	Operating temperature	- 40		125	°C
AV _{DD}	Supply voltage	2		5.5	V

7.4 Thermal Information

THERMAL METRIC ⁽¹⁾		DACx311	UNIT
		DCK (SC70)	
		6 PINS	
R _{θJA}	Junction-to-ambient thermal resistance	216.4	°C/W
R _{θJC(top)}	Junction-to-case (top) thermal resistance	52.1	°C/W
R _{θJB}	Junction-to-board thermal resistance	65.9	°C/W
ψ _{JT}	Junction-to-top characterization parameter	1.3	°C/W
ψ _{JB}	Junction-to-board characterization parameter	65.2	°C/W
R _{θJC(bot)}	Junction-to-case (bottom) thermal resistance	N/A	°C/W

- (1) For more information about traditional and new thermal metrics, see the application report, [Semiconductor and IC Package Thermal Metrics application note](#).

7.5 Electrical Characteristics

at $V_{DD} = 2.0\text{ V}$ to 5.5 V , $R_L = 2\text{ k}\Omega$ to GND, $C_L = 200\text{ pF}$ to GND, and $T_A = -40^\circ\text{C}$ to $+125^\circ\text{C}$ (unless otherwise noted)

PARAMETER		TEST CONDITIONS	MIN	TYP	MAX	UNIT
STATIC PERFORMANCE⁽¹⁾						
DAC5311	Resolution		8			Bits
DAC6311			10			Bits
DAC7311			12			Bits
DAC5311	Relative accuracy	Measured by the line passing through codes 3 and 252		± 0.01	± 0.25	LSB
DAC6311		Measured by the line passing through codes 12 and 1012		± 0.06	± 0.5	LSB
DAC7311		Measured by the line passing through codes 30 and 4050		± 0.3	± 1	LSB
DAC5311	Differential nonlinearity			± 0.01	± 0.25	LSB
DAC6311				± 0.03	± 0.5	LSB
DAC7311					± 0.2	± 1
Offset error		Measured by the line passing through two codes ⁽²⁾		± 0.05	± 4	mV
Offset error drift				3		$\mu\text{V}/^\circ\text{C}$
Zero code error		All zeros loaded to the DAC register		0.2		mV
Full-scale error		All ones loaded to DAC register		0.04	0.2	% of FSR
Gain error				0.05	± 0.15	% of FSR
Gain temperature coefficient		$V_{DD} = 5\text{ V}$		± 0.5		ppm of FSR/ $^\circ\text{C}$
		$V_{DD} = 2.0\text{ V}$		± 1.5		
OUTPUT CHARACTERISTICS						
Output voltage range			0		V_{DD}	V
Output voltage settling time ⁽³⁾		$R_L = 2\text{ k}\Omega$, $C_L = 200\text{ pF}$, $V_{DD} = 5\text{ V}$, 1/4 scale to 3/4 scale		6	10	μs
		$R_L = 2\text{ M}\Omega$, $C_L = 470\text{ pF}$		12		μs
Slew rate				0.7		V/ μs
Capacitive load stability		$R_L = \infty$		470		pF
		$R_L = 2\text{ k}\Omega$		1000		pF
Code change glitch impulse		1 LSB change around major carry		0.5		nV-s
Digital feedthrough				0.5		nV-s
Power-on glitch impulse		$R_L = 2\text{ k}\Omega$, $C_L = 200\text{ pF}$, $V_{DD} = 5\text{ V}$		17		mV
DC output impedance				0.5		Ω
Short circuit current		$V_{DD} = 5\text{ V}$		50		mA
		$V_{DD} = 3\text{ V}$		20		mA
Power-up time		Coming out of power-down mode		50		μs
AC PERFORMANCE						
SNR				81		dB
THD		$T_A = 25^\circ\text{C}$, BW = 20 kHz, 12-bit level, $V_{DD} = 5\text{ V}$, $f_{OUT} = 1\text{ kHz}$, 1st 19 harmonics removed for SNR calculation		-65		dB
SFDR				65		dB
SINAD				65		dB

7.5 Electrical Characteristics (continued)

at $AV_{DD} = 2.0\text{ V to }5.5\text{ V}$, $R_L = 2\text{ k}\Omega$ to GND, $C_L = 200\text{ pF}$ to GND, and $T_A = -40^\circ\text{C to }+125^\circ\text{C}$ (unless otherwise noted)

PARAMETER		TEST CONDITIONS		MIN	TYP	MAX	UNIT
DAC output noise density ⁽⁴⁾	$T_A = 25^\circ\text{C}$, at zero-scale input, $f_{OUT} = 1\text{ kHz}$, $AV_{DD} = 5\text{ V}$				17		$\text{nV}/\sqrt{\text{Hz}}$
	$T_A = 25^\circ\text{C}$, at mid-code input, $f_{OUT} = 1\text{ kHz}$, $AV_{DD} = 5\text{ V}$				110		$\text{nV}/\sqrt{\text{Hz}}$
DAC output noise ⁽⁵⁾	$T_A = +25^\circ\text{C}$, at mid-code input, 0.1 Hz to 10 Hz, $AV_{DD} = 5\text{ V}$				3		μV_{PP}
LOGIC INPUTS⁽³⁾							
Input current						± 1	μA
V_{INL} , Input low voltage	$AV_{DD} = 2.7\text{ V to }5.5\text{ V}$				$0.3 \times AV_{DD}$		V
	$AV_{DD} = 2.0\text{ V to }2.7\text{ V}$				$0.1 \times AV_{DD}$		V
V_{INH} , Input high voltage	$AV_{DD} = 2.7\text{ V to }5.5\text{ V}$				$0.7 \times AV_{DD}$		V
	$AV_{DD} = 2.0\text{ V to }2.7\text{ V}$				$0.9 \times AV_{DD}$		V
Pin capacitance					1.5	3	pF
POWER REQUIREMENTS							
AV_{DD}					2.0	5.5	V
I_{DD}	Normal mode	$V_{INH} = AV_{DD}$ and $V_{INL} = \text{GND}$, at midscale code ⁽⁶⁾	$AV_{DD} = 3.6\text{ V to }5.5\text{ V}$		110	180	μA
			$AV_{DD} = 2.7\text{ V to }3.6\text{ V}$		95	150	μA
			$AV_{DD} = 2.0\text{ V to }2.7\text{ V}$		80	140	μA
	All power-down mode	$V_{INH} = AV_{DD}$ and $V_{INL} = \text{GND}$, at midscale code ⁽⁶⁾	$AV_{DD} = 3.6\text{ V to }5.5\text{ V}$		0.5	3.5	μA
			$AV_{DD} = 2.7\text{ V to }3.6\text{ V}$		0.4	3	μA
			$AV_{DD} = 2.0\text{ V to }2.7\text{ V}$		0.1	2	μA
Power dissipation	Normal mode	$V_{INH} = AV_{DD}$ and $V_{INL} = \text{GND}$, at midscale code ⁽⁶⁾	$AV_{DD} = 3.6\text{ V to }5.5\text{ V}$		0.55	0.99	mW
			$AV_{DD} = 2.7\text{ V to }3.6\text{ V}$		0.25	0.54	mW
			$AV_{DD} = 2.0\text{ V to }2.7\text{ V}$		0.14	0.38	mW
	All power-down mode	$V_{INH} = AV_{DD}$ and $V_{INL} = \text{GND}$, at midscale code ⁽⁶⁾	$AV_{DD} = 3.6\text{ V to }5.5\text{ V}$		2.50	19.2	μW
			$AV_{DD} = 2.7\text{ V to }3.6\text{ V}$		1.08	10.8	μW
			$AV_{DD} = 2.0\text{ V to }2.7\text{ V}$		0.72	8.1	μW

- (1) Linearity calculated using a reduced code range of 3 to 252 for 8-bit, 12 to 1012 for 10bit, and 30 to 4050 for 12-bit, output unloaded.
- (2) Straight line passing through codes 3 and 252 for 8-bit, 12 and 1012 for 10-bit, and 30 and 4050 for 12-bit, output unloaded.
- (3) Specified by design and characterization, not production tested.
- (4) For more details, see [Figure 7-23](#).
- (5) For more details, see [Figure 7-24](#).
- (6) For more details, see [Figure 7-16](#) and [Figure 7-58](#).

7.6 Timing Requirements

at -40°C to 125°C, and $AV_{DD} = 2\text{ V to }5.5\text{ V}$ (unless otherwise noted)⁽¹⁾

		MIN	NOM	MAX	UNIT
$f_{(SCLK)}$	Serial clock frequency	$AV_{DD} = 2.0\text{ V to }3.6\text{ V}$		20	MHz
		$AV_{DD} = 3.6\text{ V to }5.5\text{ V}$		50	
t_1	SCLK cycle time	$AV_{DD} = 2.0\text{ V to }3.6\text{ V}$		50	ns
		$AV_{DD} = 3.6\text{ V to }5.5\text{ V}$		20	
t_2	SCLK high time	$AV_{DD} = 2.0\text{ V to }3.6\text{ V}$		25	ns
		$AV_{DD} = 3.6\text{ V to }5.5\text{ V}$		10	
t_3	SCLK low time	$AV_{DD} = 2.0\text{ V to }3.6\text{ V}$		25	ns
		$AV_{DD} = 3.6\text{ V to }5.5\text{ V}$		10	
t_4	SYNC to SCLK rising edge setup time	$AV_{DD} = 2.0\text{ V to }3.6\text{ V}$		0	ns
		$AV_{DD} = 3.6\text{ V to }5.5\text{ V}$		0	
t_5	Data setup time	$AV_{DD} = 2.0\text{ V to }3.6\text{ V}$		5	ns
		$AV_{DD} = 3.6\text{ V to }5.5\text{ V}$		5	
t_6	Data hold time	$AV_{DD} = 2.0\text{ V to }3.6\text{ V}$		4.5	ns
		$AV_{DD} = 3.6\text{ V to }5.5\text{ V}$		4.5	
t_7	SCLK falling edge to $\overline{\text{SYNC}}$ rising edge	$AV_{DD} = 2.0\text{ V to }3.6\text{ V}$		0	ns
		$AV_{DD} = 3.6\text{ V to }5.5\text{ V}$		0	
t_8	Minimum $\overline{\text{SYNC}}$ high time	$AV_{DD} = 2.0\text{ V to }3.6\text{ V}$		50	ns
		$AV_{DD} = 3.6\text{ V to }5.5\text{ V}$		20	
t_9	16th SCLK falling edge to $\overline{\text{SYNC}}$ falling edge	$AV_{DD} = 2.0\text{ V to }3.6\text{ V}$		100	ns
		$AV_{DD} = 3.6\text{ V to }5.5\text{ V}$		100	
t_{10}	$\overline{\text{SYNC}}$ rising edge to 16th SCLK falling edge (for successful SYNC interrupt)	$AV_{DD} = 2.0\text{ V to }3.6\text{ V}$		15	ns
		$AV_{DD} = 3.6\text{ V to }5.5\text{ V}$		15	

(1) All input signals are specified with $t_R = t_F = 3\text{ ns}$ (10% to 90% of AV_{DD}) and timed from a voltage level of $(V_{IL} + V_{IH}) / 2$.

7.7 Timing Diagrams



图 7-1. Serial Write Operation

7.8 Typical Characteristics: $AV_{DD} = 5\text{ V}$

at $T_A = 25^\circ\text{C}$, $AV_{DD} = 5\text{ V}$, and DAC loaded with midscale code (unless otherwise noted)

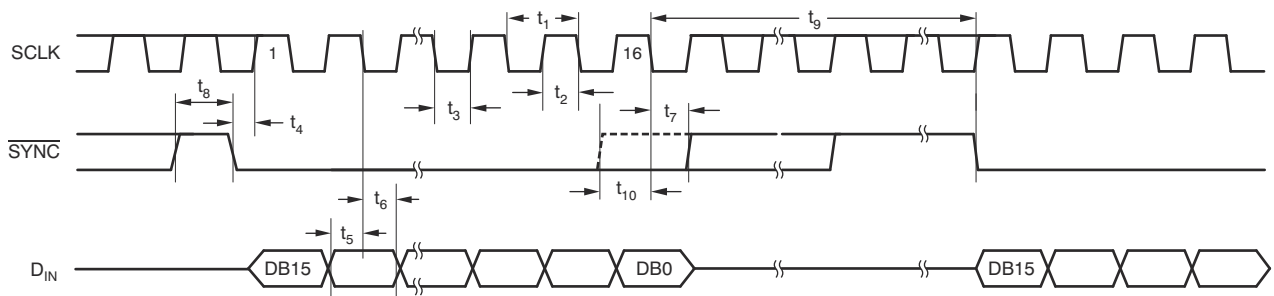

图 7-2. DAC7311 12-Bit Linearity Error and Differential Linearity Error vs Code (-40°C)



图 7-3. DAC6311 10-Bit Linearity Error and Differential Linearity Error vs Code (-40°C)

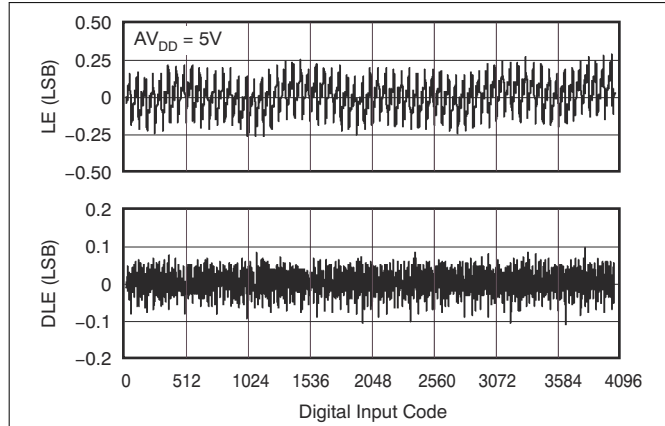

图 7-4. DAC7311 12-Bit Linearity Error and Differential Linearity Error vs Code (25°C)

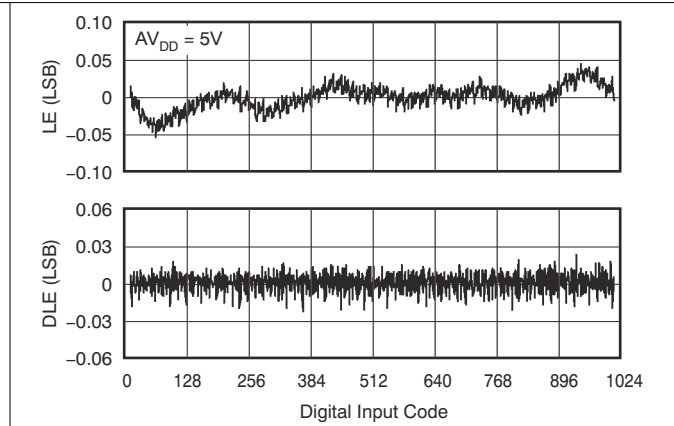

图 7-5. DAC6311 10-Bit Linearity Error and Differential Linearity Error vs Code (25°C)

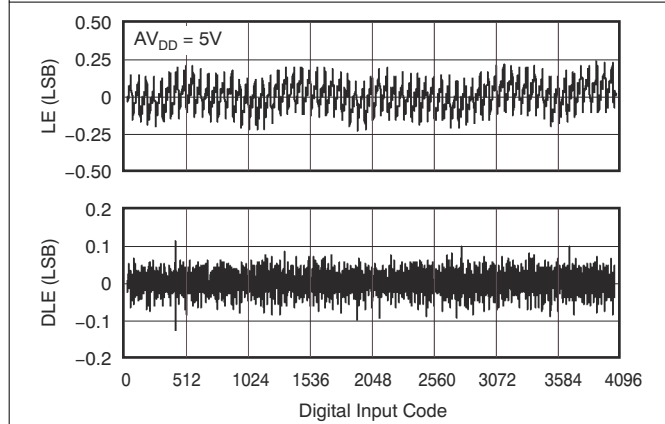

图 7-6. DAC7311 12-Bit Linearity Error and Differential Linearity Error vs Code (125°C)

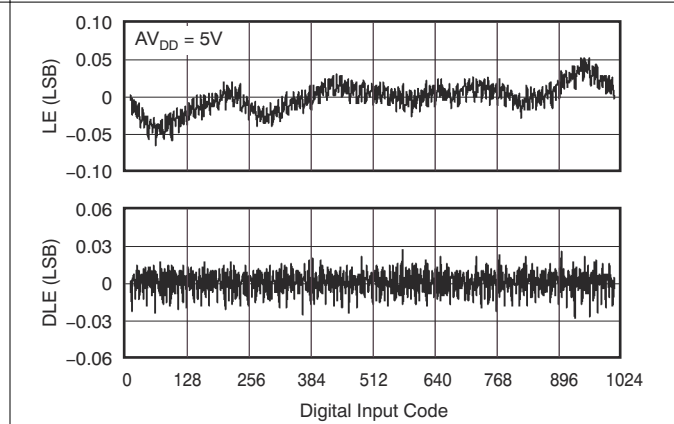

图 7-7. DAC6311 10-Bit Linearity Error and Differential Linearity Error vs Code (125°C)

7.8 Typical Characteristics: $AV_{DD} = 5\text{ V}$ (continued)

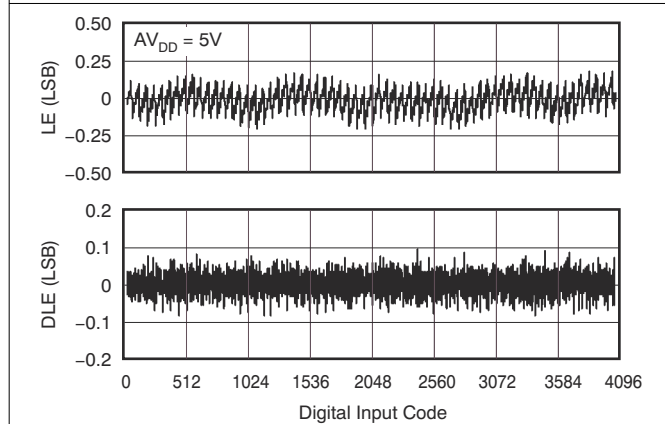
at $T_A = 25^\circ\text{C}$, $AV_{DD} = 5\text{ V}$, and DAC loaded with midscale code (unless otherwise noted)

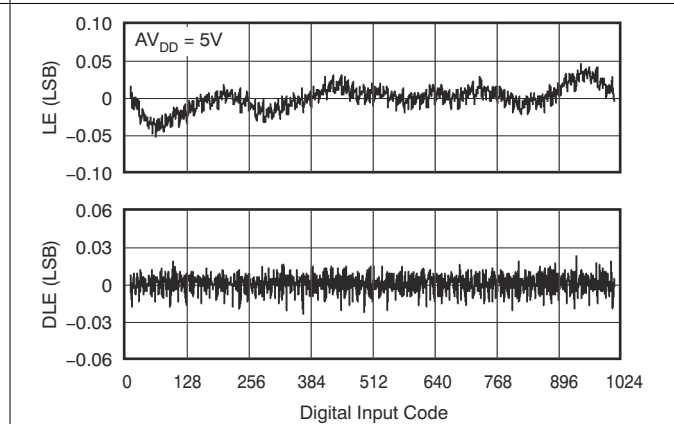
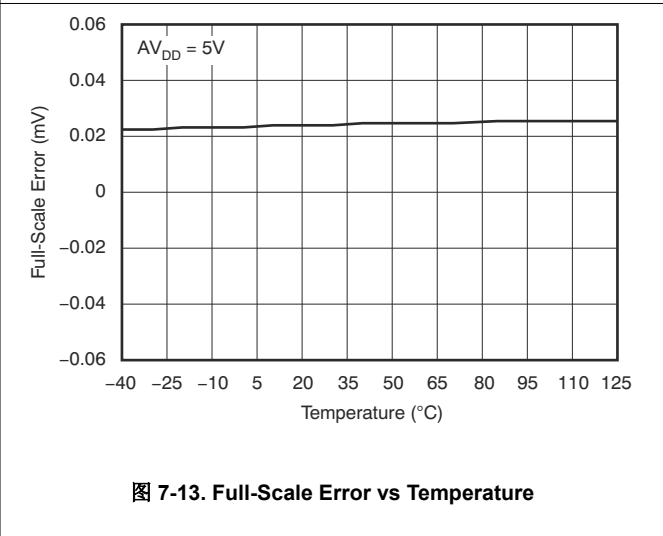
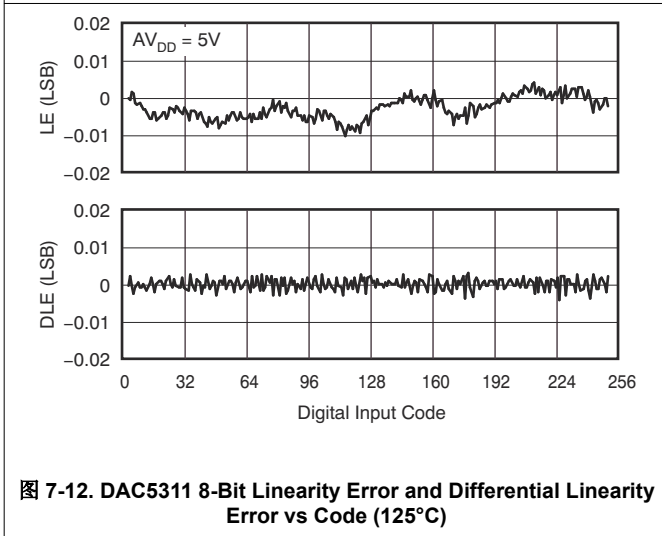
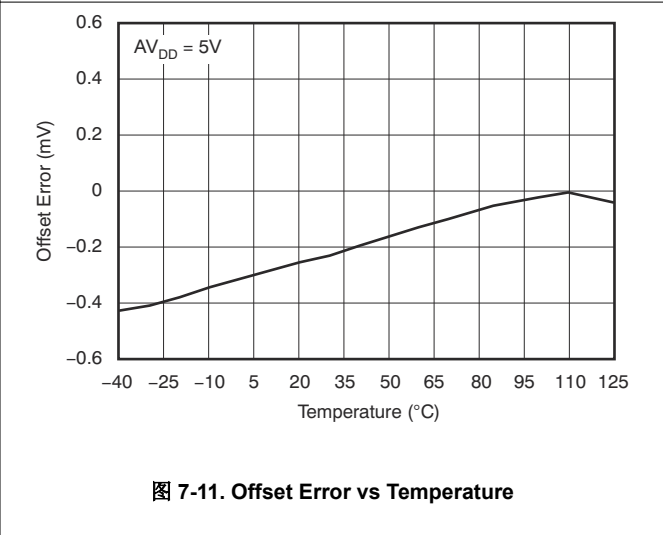
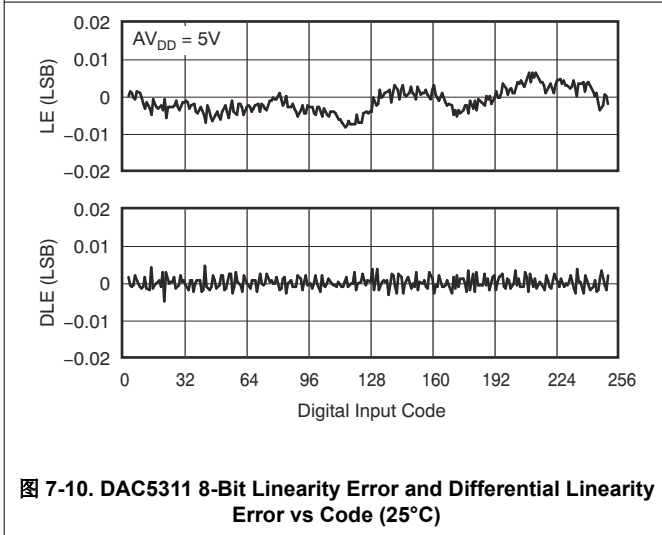
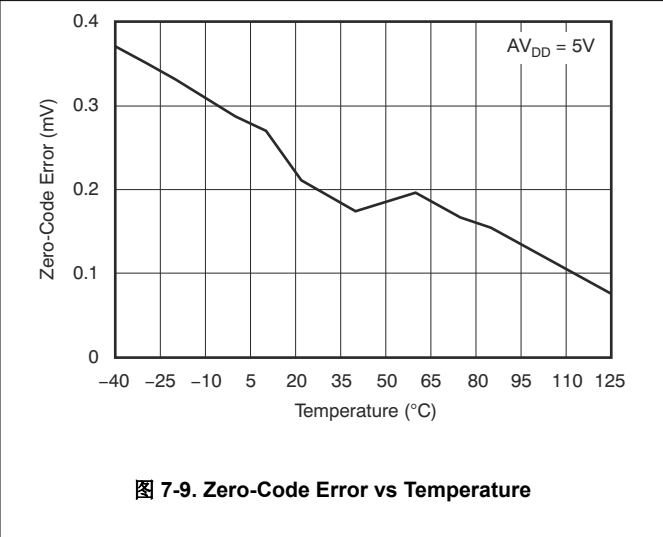
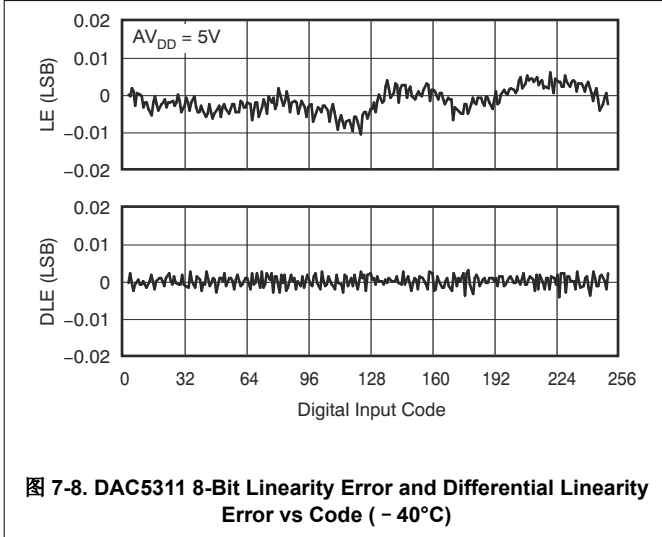

7.8 Typical Characteristics: $AV_{DD} = 5\text{ V}$ (continued)

at $T_A = 25^\circ\text{C}$, $AV_{DD} = 5\text{ V}$, and DAC loaded with midscale code (unless otherwise noted)

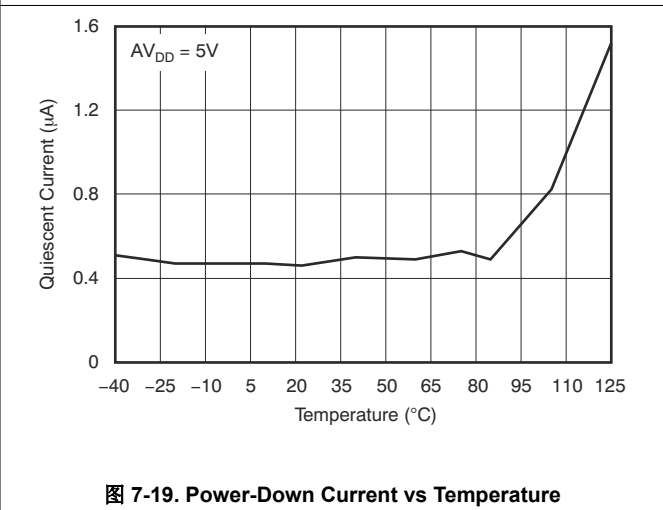
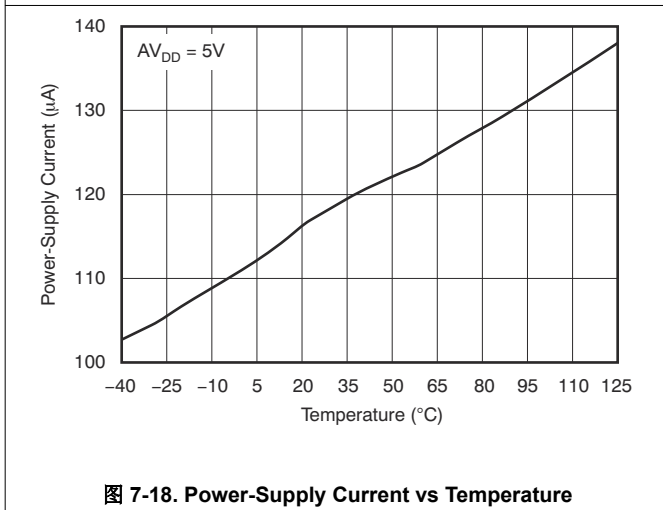
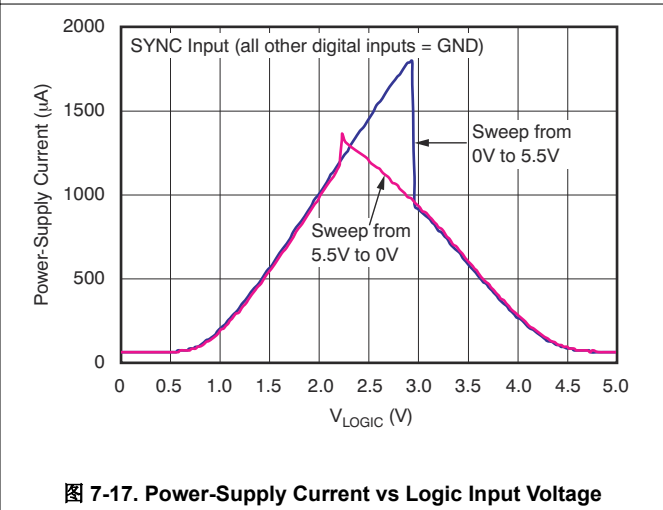
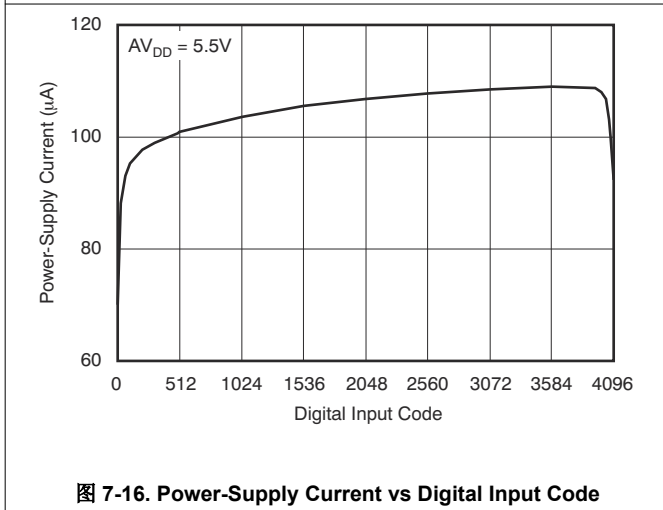
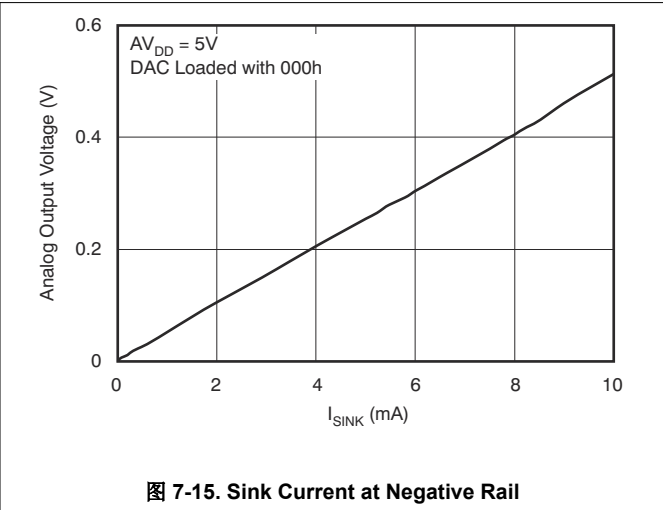
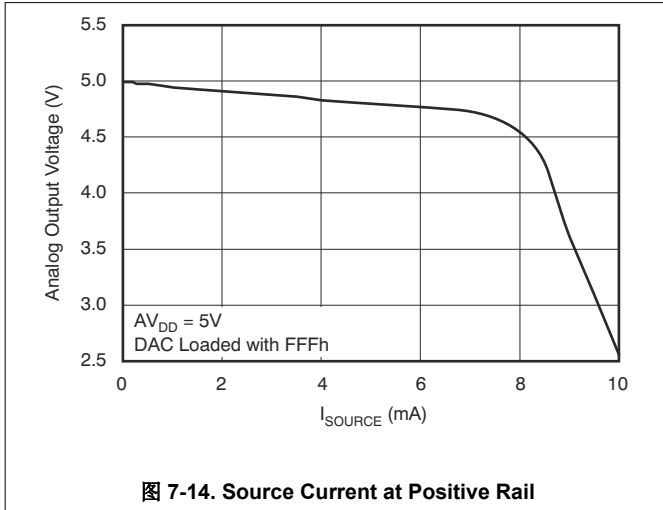

7.8 Typical Characteristics: $AV_{DD} = 5\text{ V}$ (continued)

at $T_A = 25^\circ\text{C}$, $AV_{DD} = 5\text{ V}$, and DAC loaded with midscale code (unless otherwise noted)



图 7-20. Total Harmonic Distortion vs Output Frequency



图 7-21. Signal-to-Noise Ratio vs Output Frequency

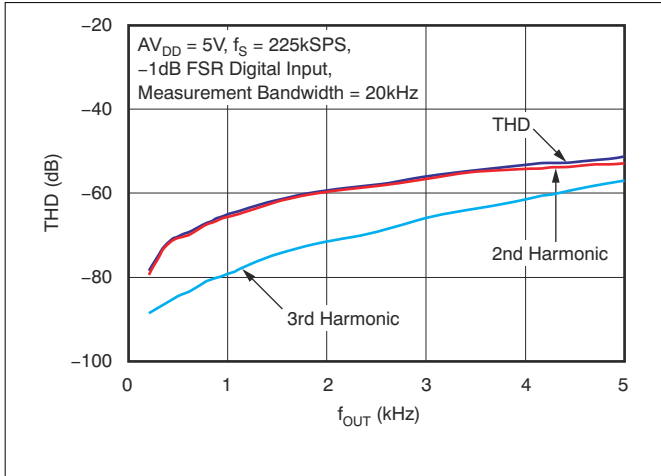

图 7-22. Power Spectral Density

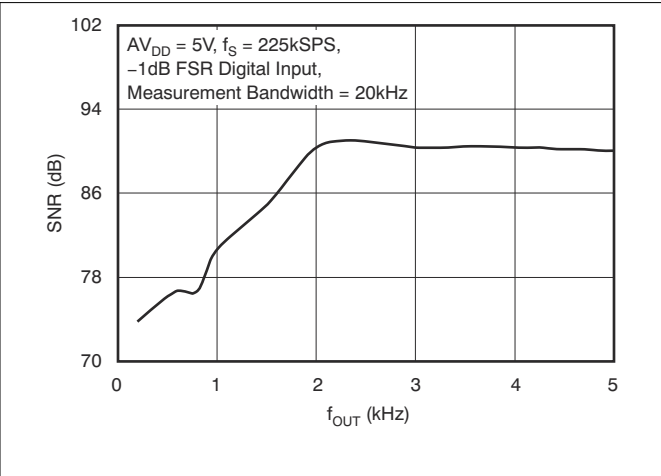

图 7-23. DAC Output Noise Density vs Frequency

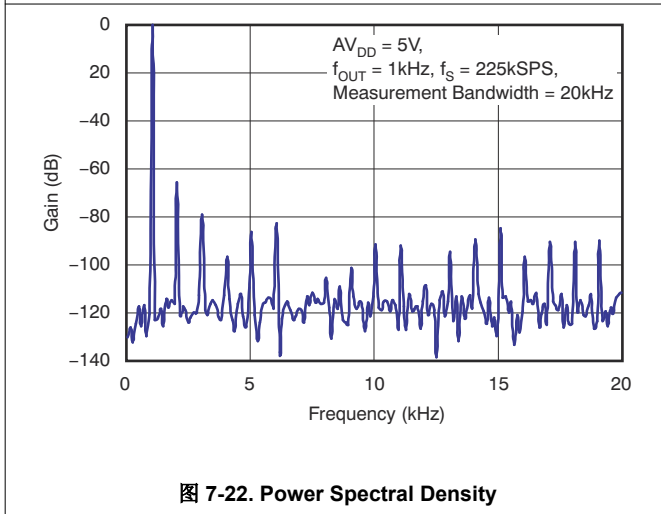

图 7-24. DAC Output Noise, 0.1-Hz to 10-Hz Bandwidth

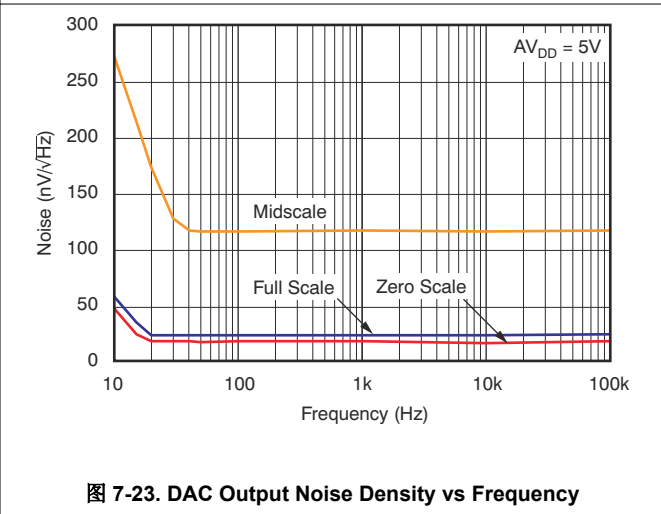

图 7-25. Clock Feedthrough, 5-V, 2-MHz, Midscale

7.8 Typical Characteristics: $AV_{DD} = 5\text{ V}$ (continued)

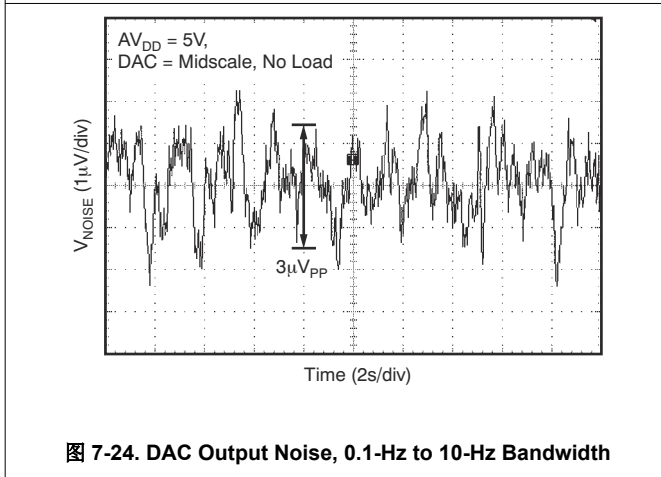
at $T_A = 25^\circ\text{C}$, $AV_{DD} = 5\text{ V}$, and DAC loaded with midscale code (unless otherwise noted)

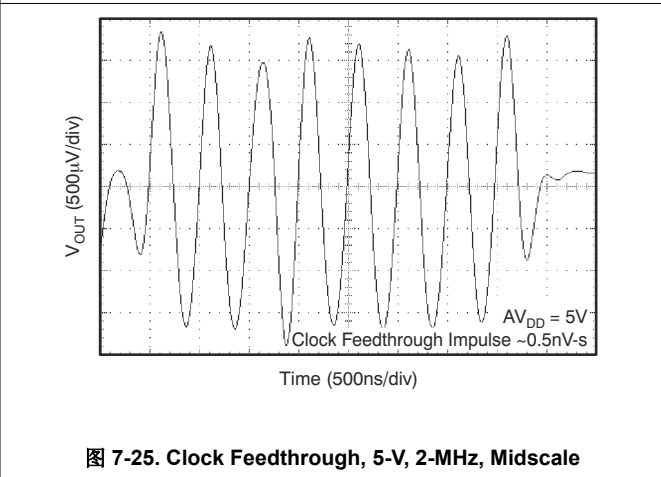

图 7-26. Glitch Energy, 5-V, 12-Bit, 1-LSB Step, Rising Edge



图 7-27. Glitch Energy, 5-V, 12-Bit, 1-LSB Step, Falling Edge

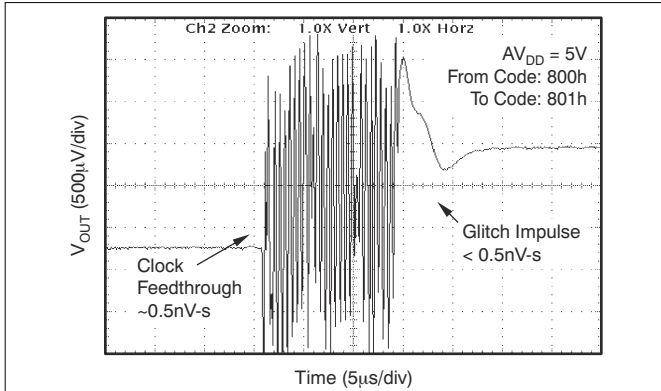

图 7-28. Glitch Energy, 5-V, 8-Bit, 1-LSB Step, Rising Edge

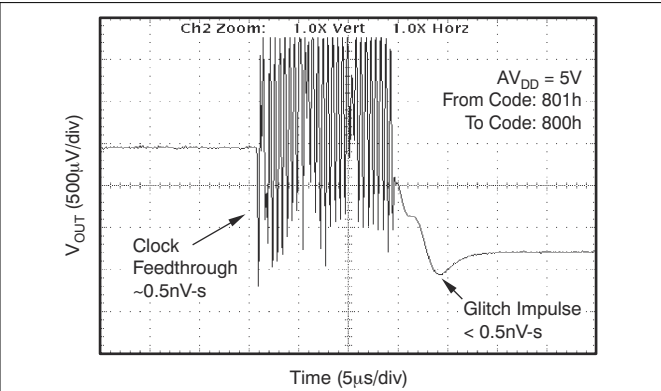

图 7-29. Glitch Energy, 5-V, 8-Bit, 1-LSB Step, Falling Edge

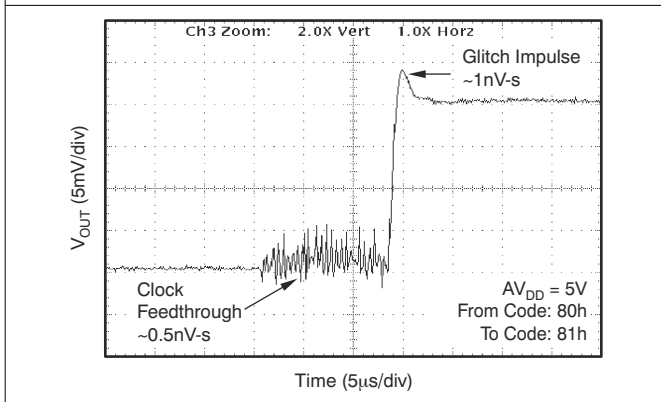

图 7-30. Full-Scale Settling Time, 5-V Rising Edge

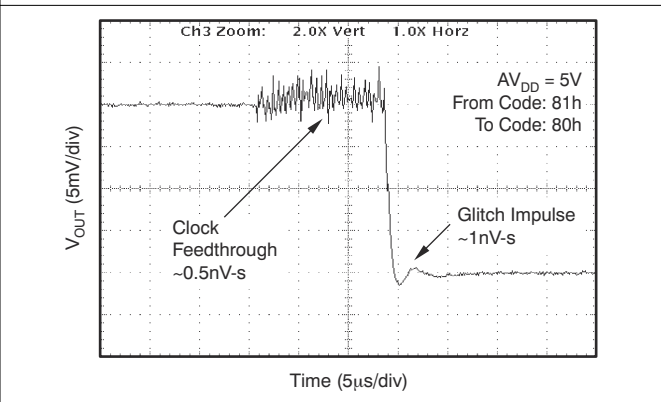

图 7-31. Full-Scale Settling Time, 5-V Falling Edge

7.8 Typical Characteristics: $AV_{DD} = 5\text{ V}$ (continued)

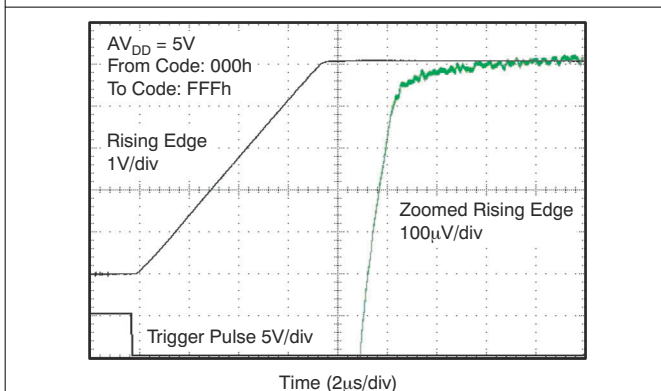
at $T_A = 25^\circ\text{C}$, $AV_{DD} = 5\text{ V}$, and DAC loaded with midscale code (unless otherwise noted)

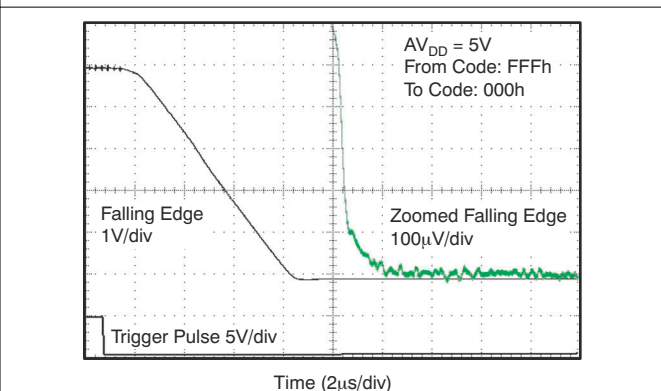

图 7-32. Half-Scale Settling Time, 5-V Rising Edge



图 7-33. Half-Scale Settling Time 5-V Falling Edge

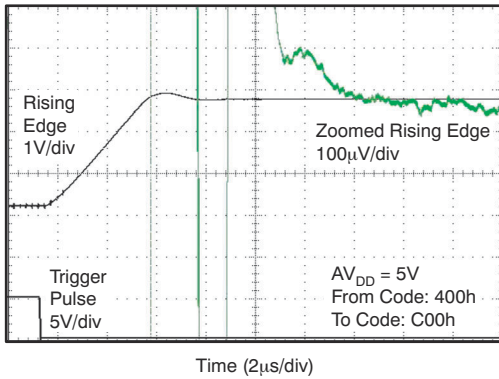

图 7-34. Power-On Reset to 0-V Power-On Glitch

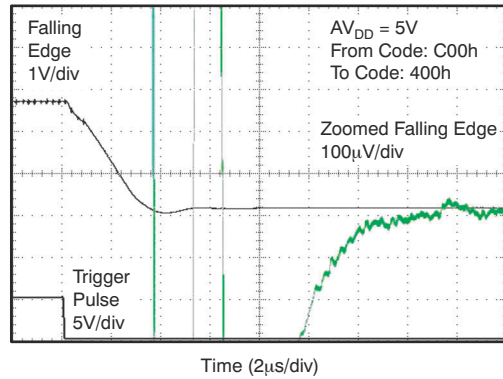

图 7-35. Power-Off Glitch

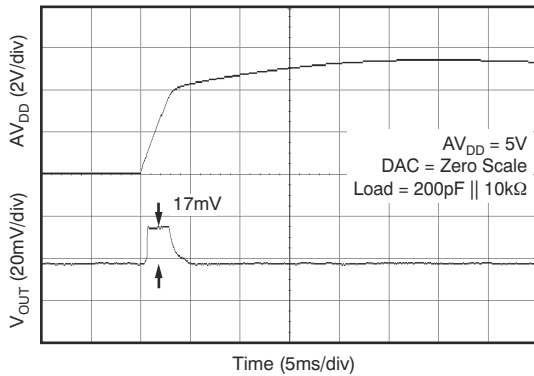

图 7-36. Power-Supply Current vs Power-Supply Voltage

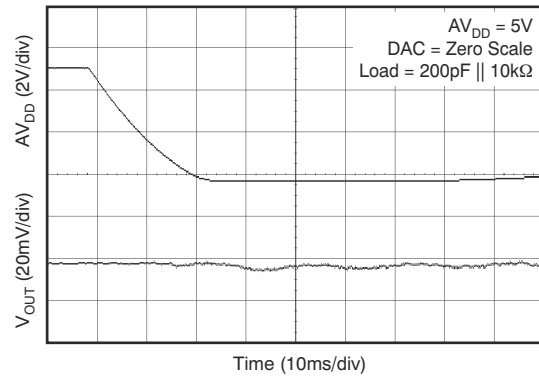

图 7-37. Power-Down Current vs Power-Supply Voltage

7.8 Typical Characteristics: $AV_{DD} = 5\text{ V}$ (continued)

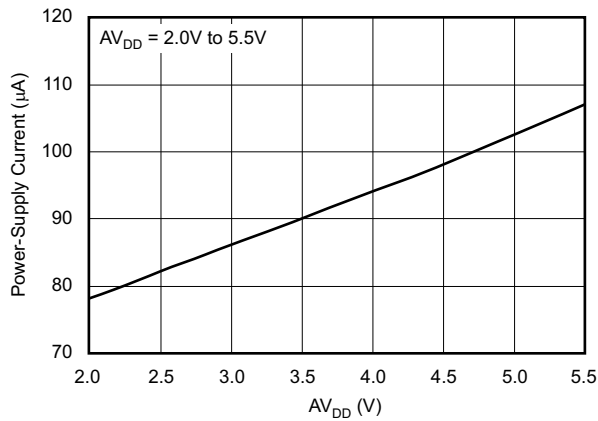
at $T_A = 25^\circ\text{C}$, $AV_{DD} = 5\text{ V}$, and DAC loaded with midscale code (unless otherwise noted)

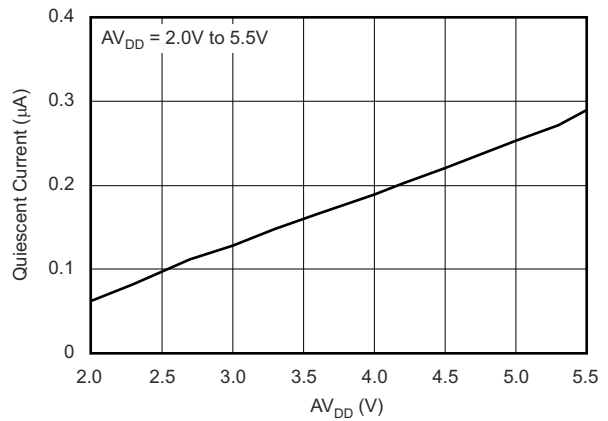

图 7-38. Power-Supply Current Histogram

7.9 Typical Characteristics: $AV_{DD} = 3.6\text{ V}$

at $T_A = 25^\circ\text{C}$, $AV_{DD} = 3.6\text{ V}$, and DAC loaded with midscale code (unless otherwise noted)

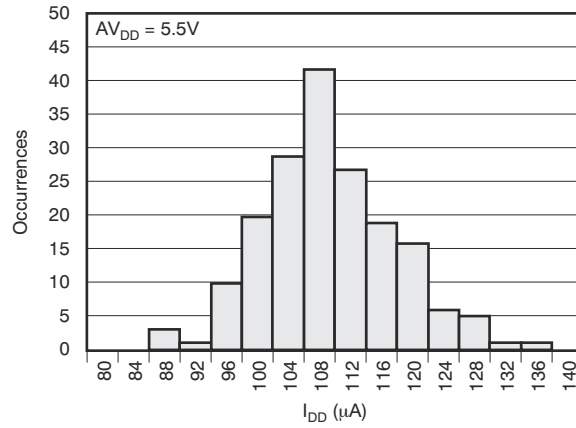

图 7-39. Power-Down Current vs Temperature



图 7-40. Power-Supply Current vs Logic Input Voltage

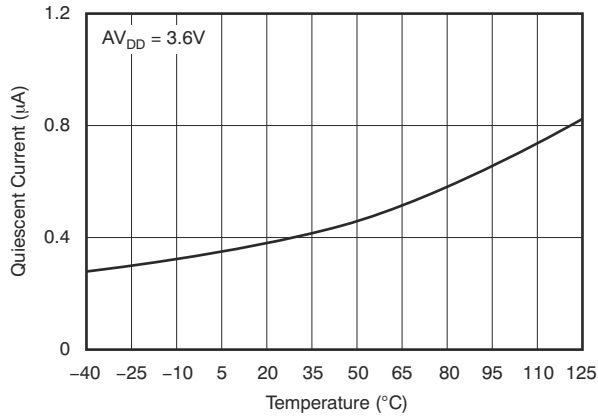

图 7-41. Power-Supply Current Histogram

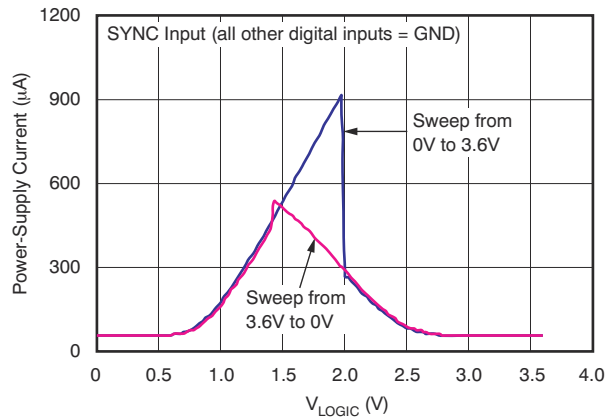

图 7-42. Source Current at Positive Rail

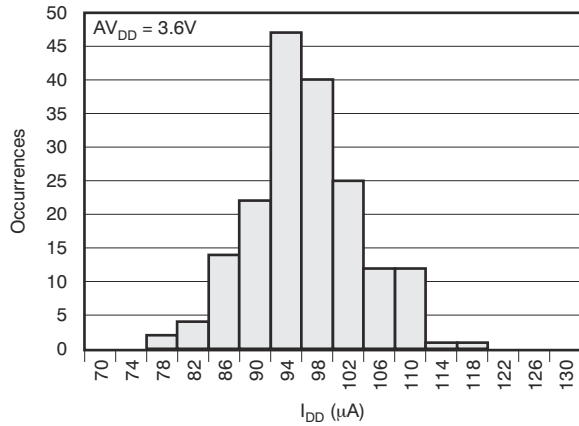

图 7-43. Sink Current at Negative Rail

7.10 Typical Characteristics: $AV_{DD} = 2.7\text{ V}$

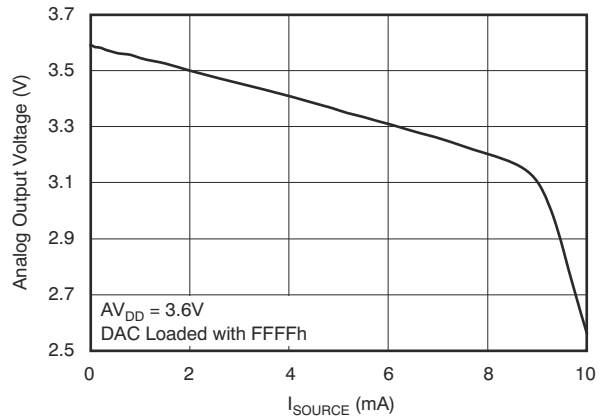
at $T_A = 25^\circ\text{C}$, $AV_{DD} = 2.7\text{ V}$, and DAC loaded with midscale code (unless otherwise noted)

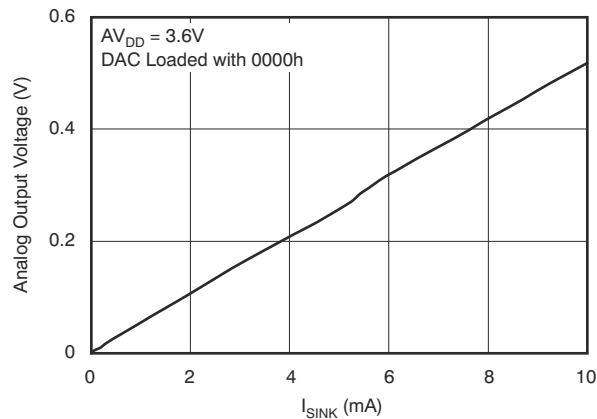

图 7-44. DAC7311 12-Bit Linearity Error and Differential Linearity Error vs Code (-40°C)



图 7-45. DAC6311 10-Bit Linearity Error and Differential Linearity Error vs Code (-40°C)

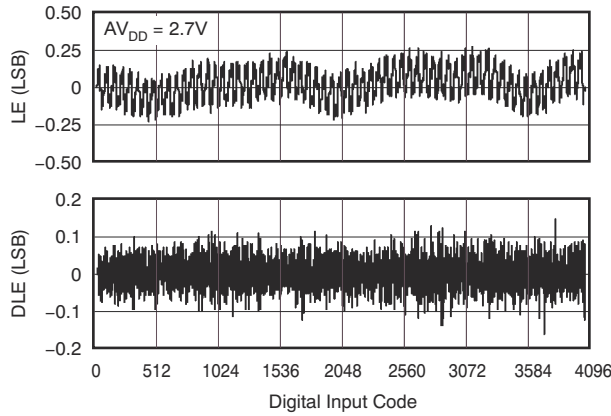

图 7-46. DAC7311 12-Bit Linearity Error and Differential Linearity Error vs Code (25°C)

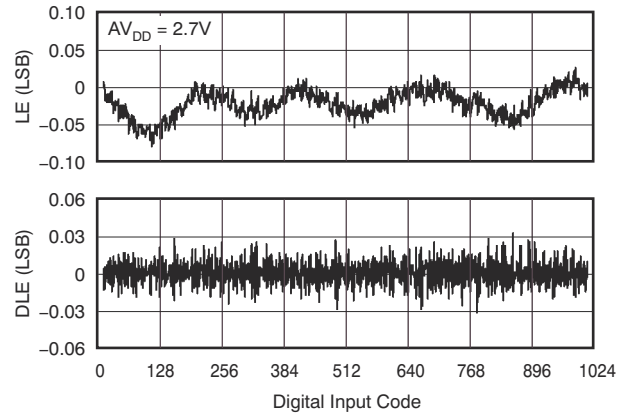

图 7-47. DAC6311 10-Bit Linearity Error and Differential Linearity Error vs Code (25°C)

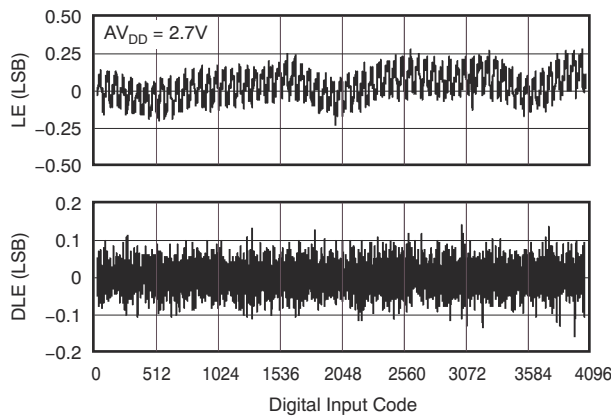

图 7-48. DAC7311 12-Bit Linearity Error and Differential Linearity Error vs Code (125°C)

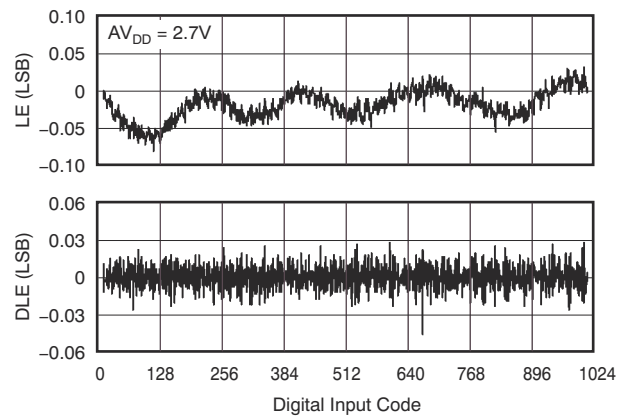

图 7-49. DAC6311 10-Bit Linearity Error and Differential Linearity Error vs Code (125°C)

7.10 Typical Characteristics: $AV_{DD} = 2.7\text{ V}$ (continued)

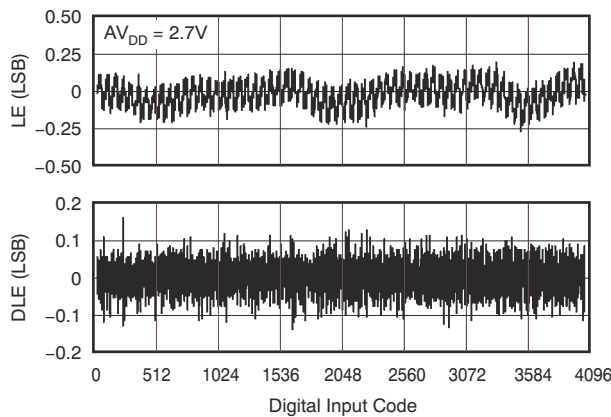
at $T_A = 25^\circ\text{C}$, $AV_{DD} = 2.7\text{ V}$, and DAC loaded with midscale code (unless otherwise noted)

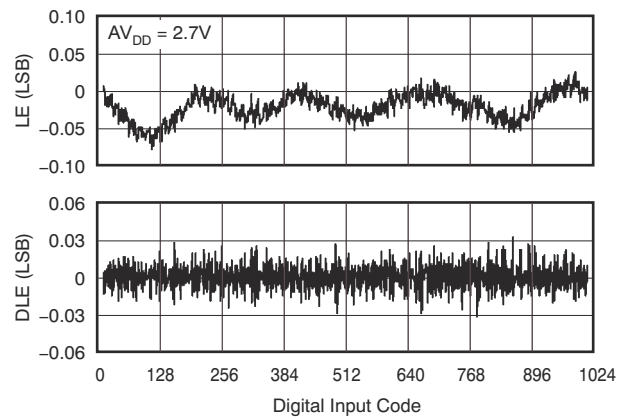
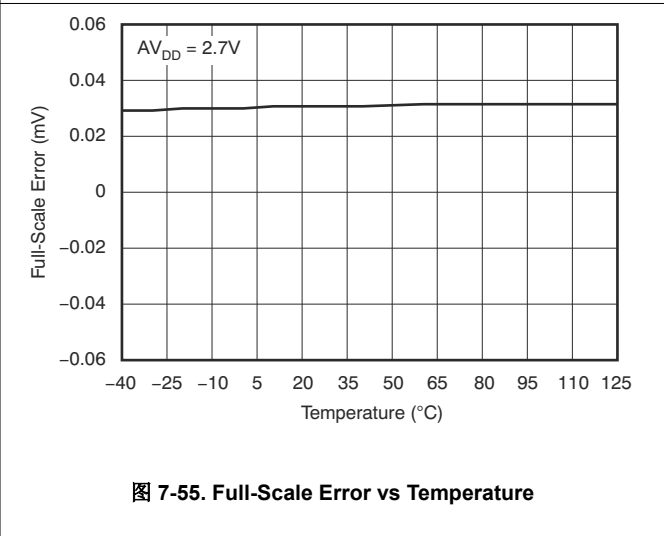
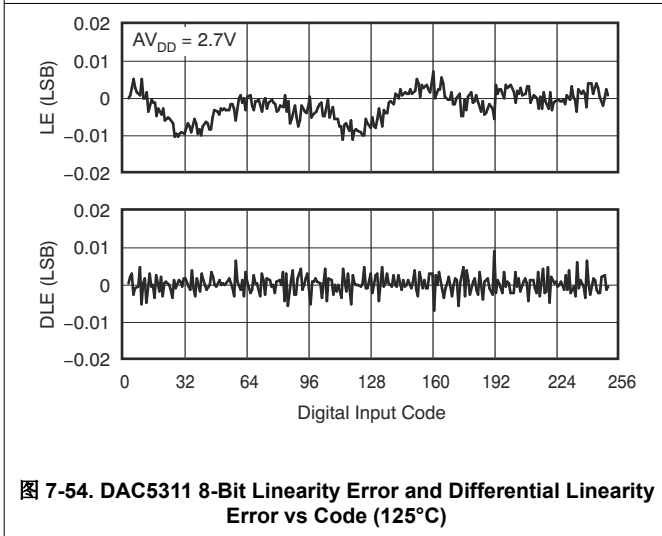
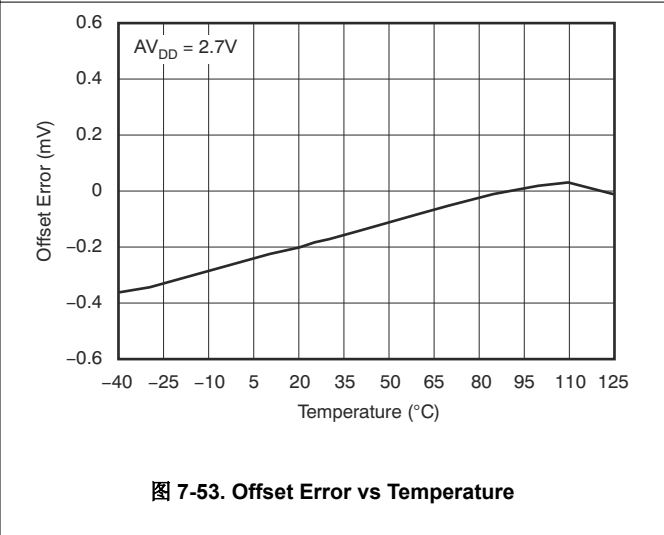
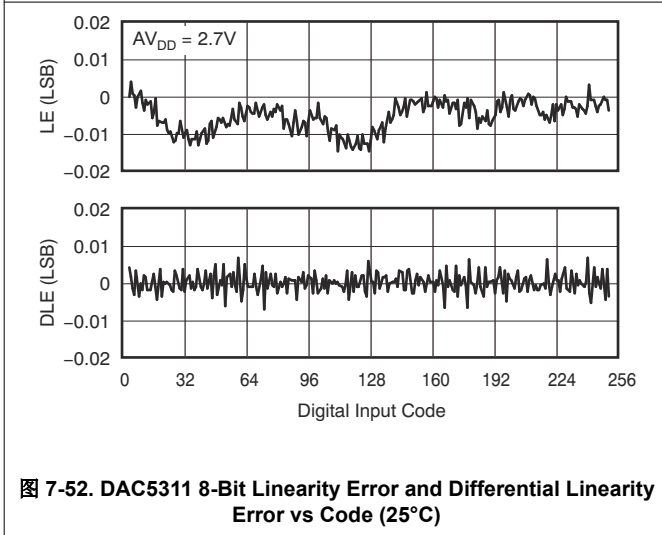
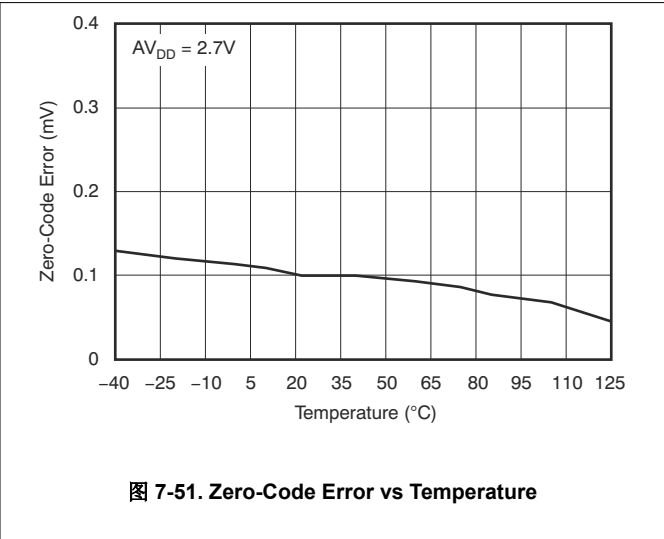
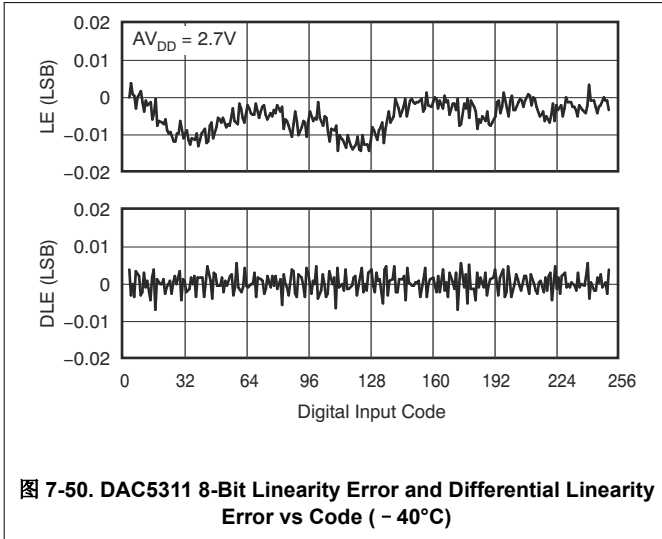

7.10 Typical Characteristics: $AV_{DD} = 2.7\text{ V}$ (continued)

at $T_A = 25^\circ\text{C}$, $AV_{DD} = 2.7\text{ V}$, and DAC loaded with midscale code (unless otherwise noted)

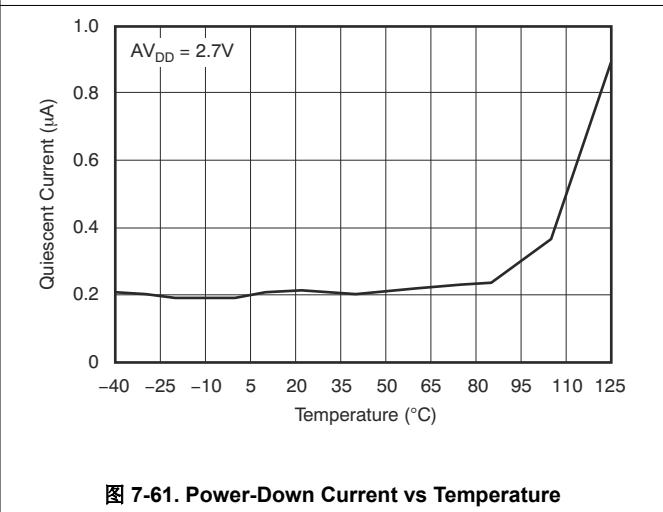
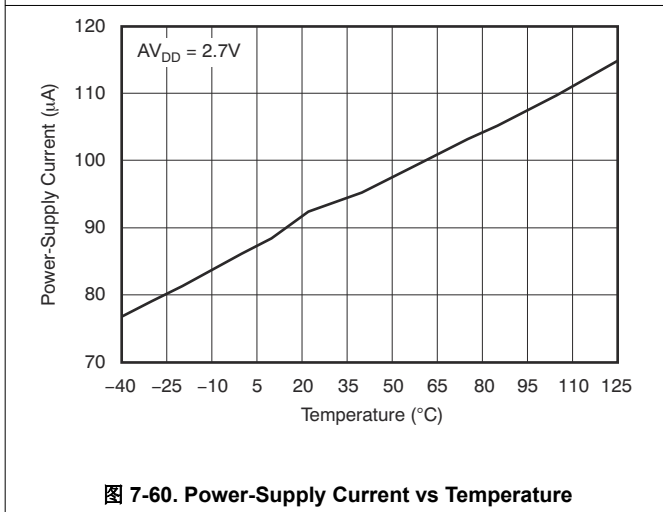
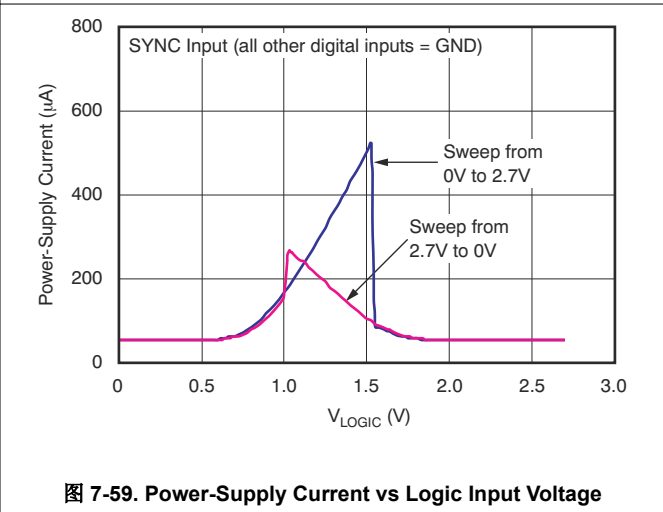
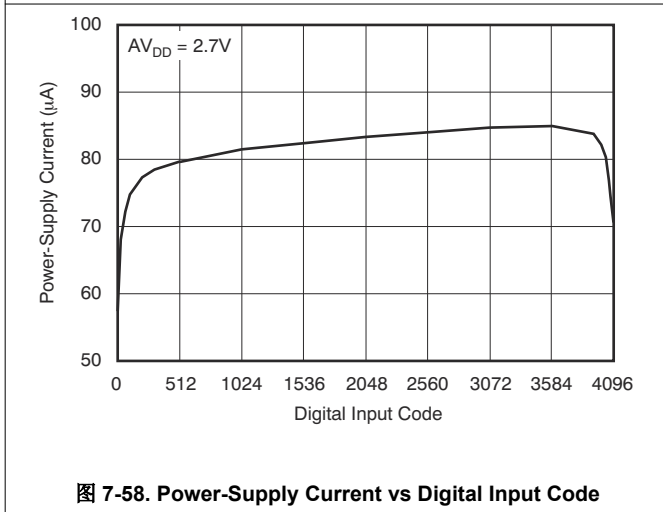
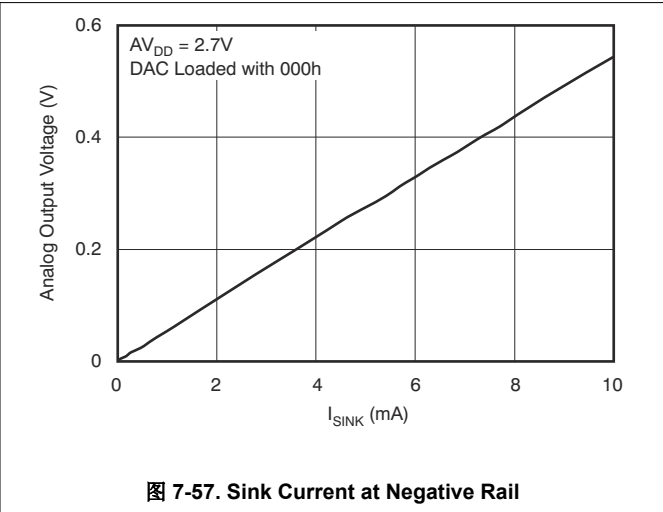
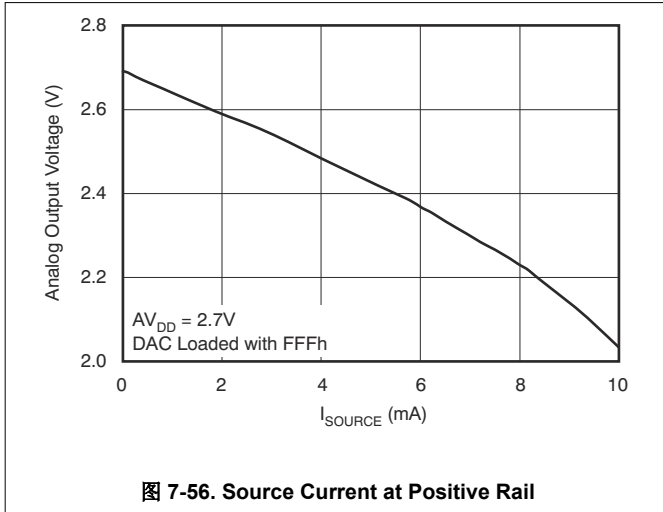

7.10 Typical Characteristics: AV_{DD} = 2.7 V (continued)

at T_A = 25°C, AV_{DD} = 2.7 V, and DAC loaded with midscale code (unless otherwise noted)



图 7-62. Total Harmonic Distortion vs Output Frequency



图 7-63. Signal-to-Noise Ratio vs Output Frequency

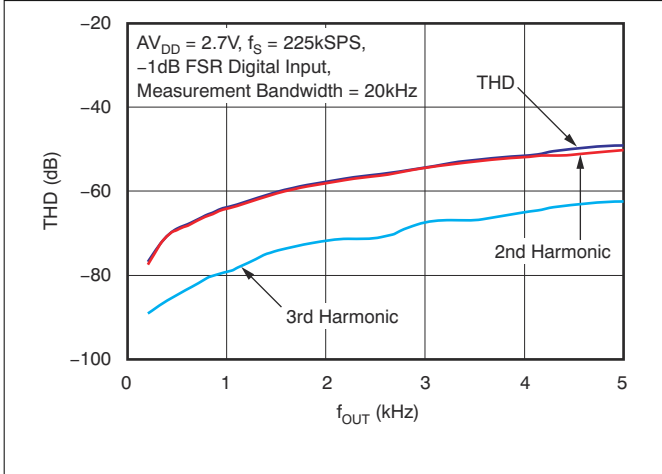

图 7-64. Power Spectral Density

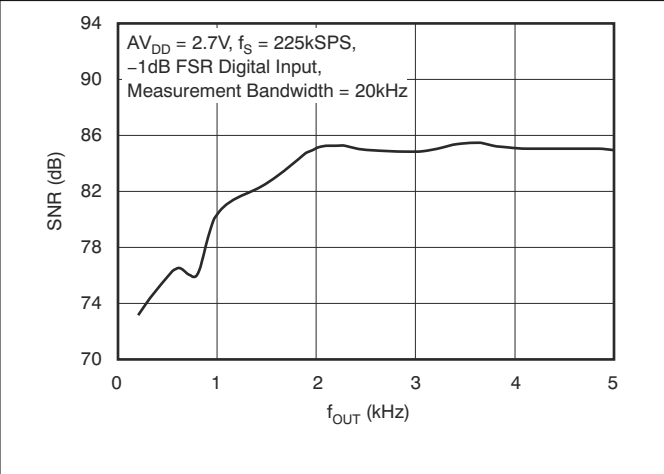

图 7-65. Power-Supply Current Histogram

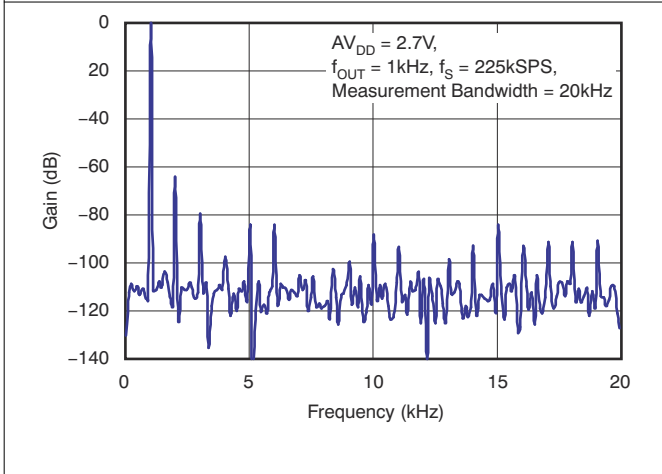

图 7-66. Clock Feedthrough 2.7-V, 20-MHz, Midscale

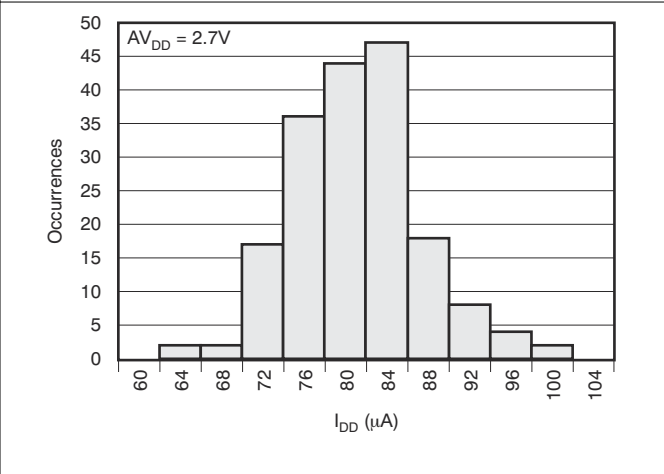

图 7-67. Glitch Energy, 2.7-V, 12-Bit, 1-LSB Step, Rising Edge

7.10 Typical Characteristics: $AV_{DD} = 2.7\text{ V}$ (continued)

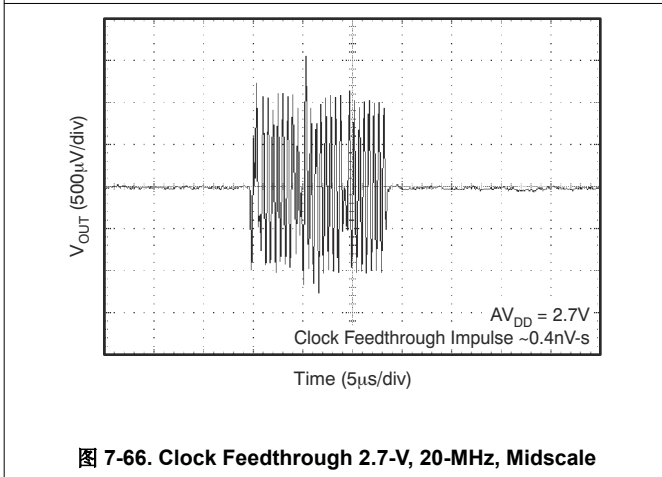
at $T_A = 25^\circ\text{C}$, $AV_{DD} = 2.7\text{ V}$, and DAC loaded with midscale code (unless otherwise noted)

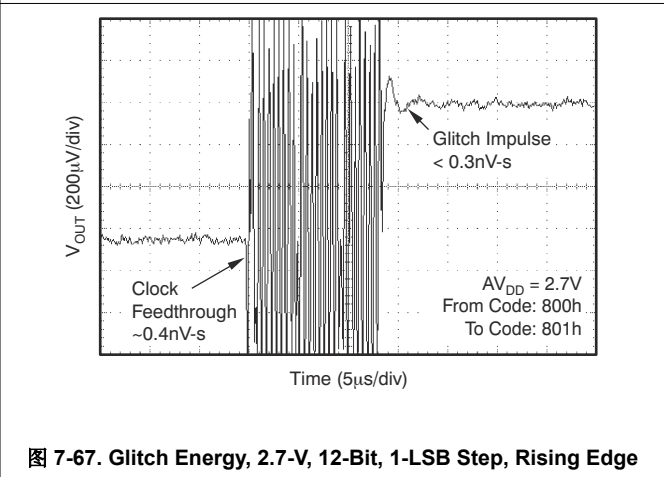

图 7-68. Glitch Energy, 2.7-V, 12-Bit, 1-LSB Step, Falling Edge



图 7-69. Glitch Energy, 2.7-V, 8-Bit, 1-LSB Step, Rising Edge

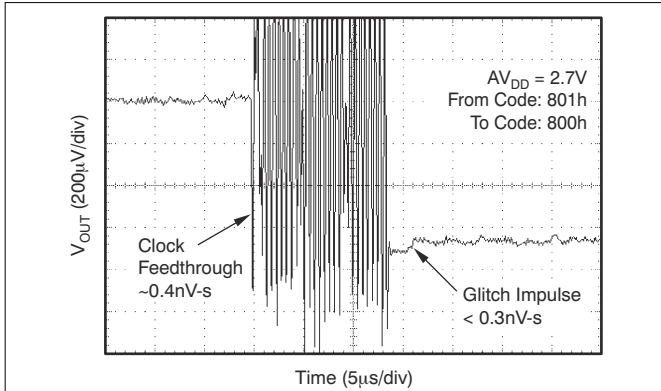

图 7-70. Glitch Energy, 2.7-V, 8-Bit, 1-LSB Step, Falling Edge

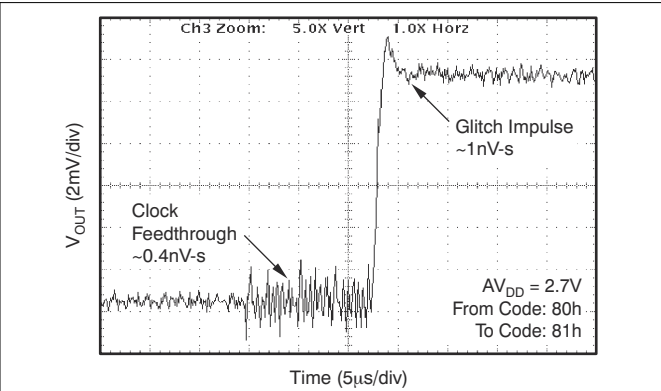

图 7-71. Full-Scale Settling Time, 2.7-V Rising Edge

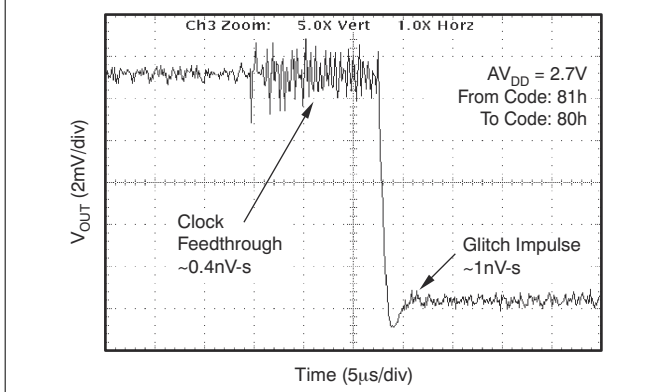

图 7-72. Full-Scale Settling Time, 2.7-V Falling Edge

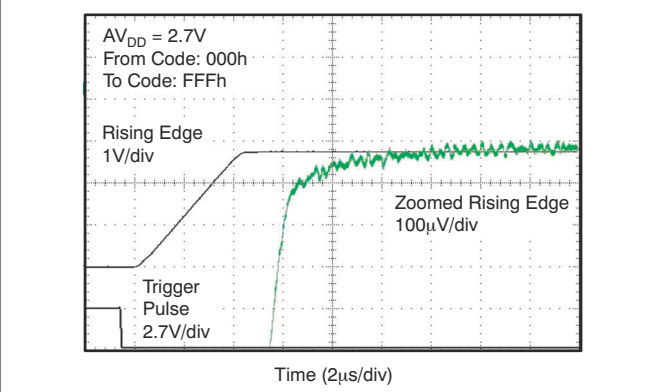

图 7-73. Half-Scale Settling Time, 2.7-V Rising Edge

7.10 Typical Characteristics: $AV_{DD} = 2.7\text{ V}$ (continued)

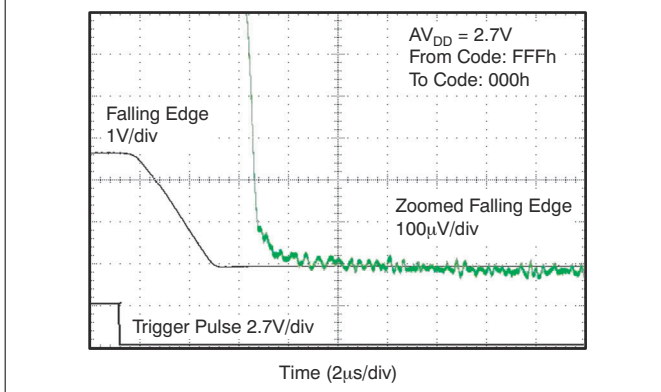
at $T_A = 25^\circ\text{C}$, $AV_{DD} = 2.7\text{ V}$, and DAC loaded with midscale code (unless otherwise noted)

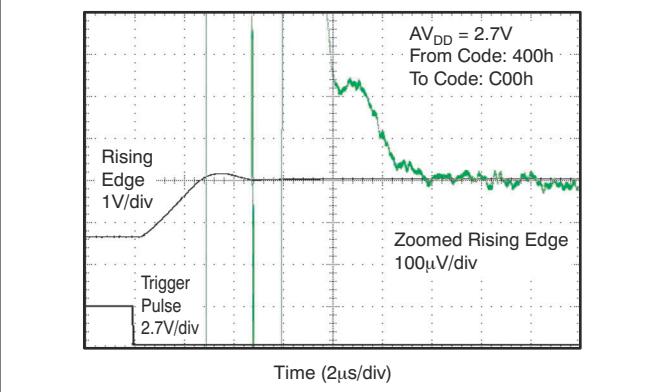

图 7-74. Half-Scale Settling Time, 2.7-V Falling Edge



图 7-75. Power-On Reset to 0-V Power-On Glitch

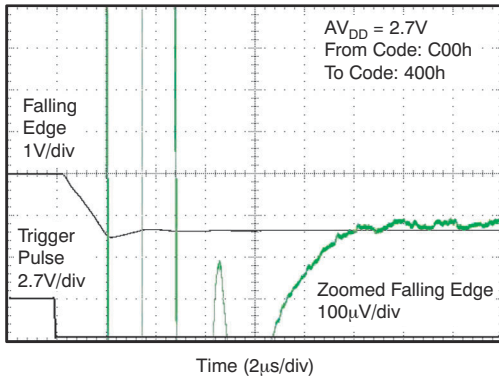

图 7-76. Power-Off Glitch

8 Detailed Description

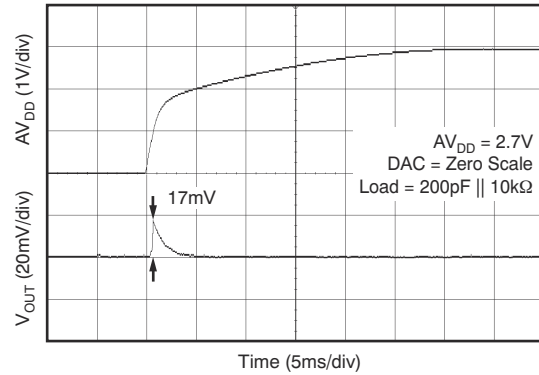
8.1 Overview

The 8-bit DAC5311, 10-bit DAC6311, and 12-bit DAC7311 devices (DACx311) are low-power, single-channel, voltage output DACs. These devices are monotonic by design, provide excellent linearity, and minimize undesired code-to-code transient voltages while offering an easy upgrade path within a pin-compatible family. All devices use a versatile, three-wire serial interface that operates at clock rates of up to 50 MHz and is compatible with standard SPI, QSPI, Microwire, and digital signal processor (DSP) interfaces.

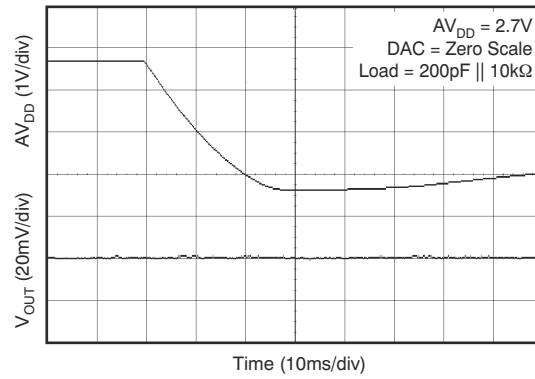
8.2 Functional Block Diagram

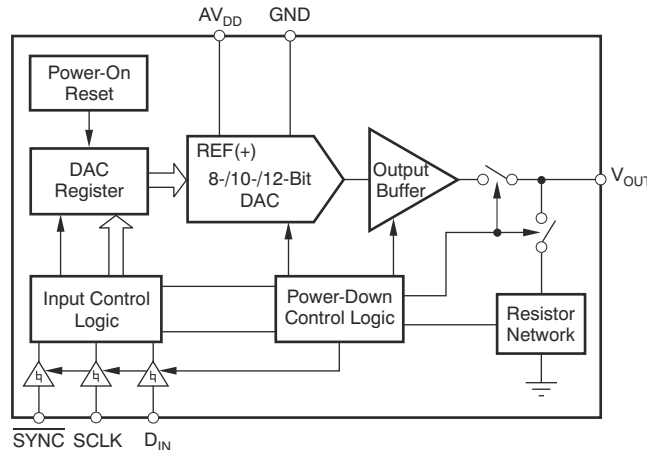

8.3 Feature Description

8.3.1 DAC Section

The DACx311 are fabricated using Texas Instruments' proprietary HPA07 process technology. The architecture consists of a string DAC followed by an output buffer amplifier. Because there is no reference input pin, the power supply (AV_{DD}) acts as the reference. [Figure 8-1](#) shows a block diagram of the DAC architecture.



图 8-1. DACx311 Architecture

The input coding to the DACx311 is straight binary, so the ideal output voltage is given by:

$$V_{OUT} = AV_{DD} \times \frac{D}{2^n} \tag{1}$$

where

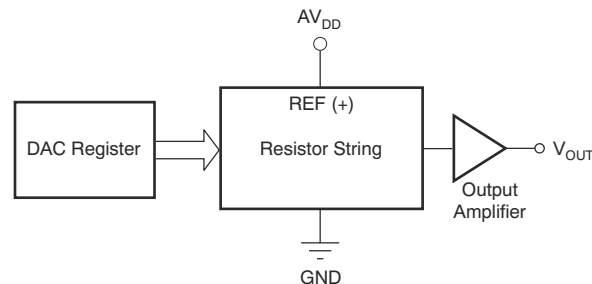
- n = resolution in bits; either 8 (DAC5311), 10 (DAC6311), or 12 (DAC7311).
- D = decimal equivalent of the binary code that is loaded to the DAC register. D ranges from 0 to 255 for 8-bit DAC5311, 0 to 1023 for the 10-bit DAC6311, and 0 to 4095 for the 12-bit DAC7311.

8.3.2 Resistor String

图 8-2 shows the resistor string section, which is a string of resistors, each of value R . The code loaded into the DAC register determines at which node on the string the voltage is tapped off to be fed into the output amplifier by closing one of the switches connecting the string to the amplifier. The resistor string architecture is inherently monotonic.



图 8-2. Resistor String

8.3.3 Output Amplifier

The output buffer amplifier is capable of generating rail-to-rail voltages on the output, which gives an output range of 0 V to AV_{DD} . The output amplifier is capable of driving a load of 2 k Ω in parallel with 1000 pF to GND. The source and sink capabilities of the output amplifier can be seen in the [Typical Characteristics](#) section for the given voltage input. The slew rate is 0.7 V/ μ s with a half-scale settling time of typically 6 μ s with the output unloaded.

8.3.4 Power-On Reset

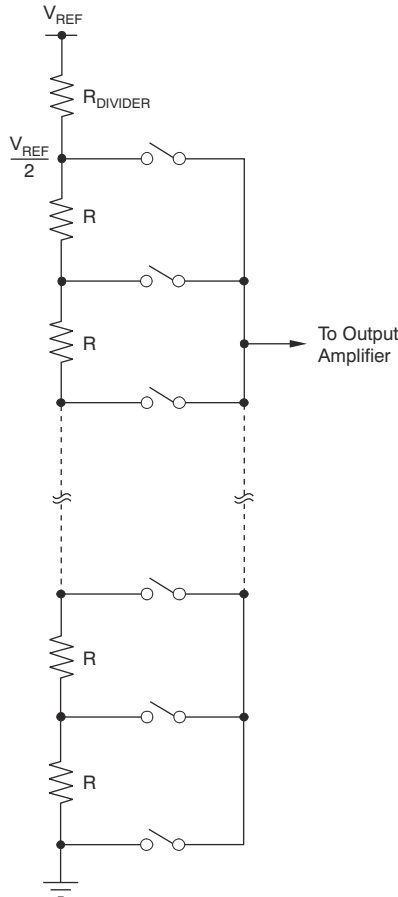
The DACx311 contain a power-on reset circuit that controls the output voltage during power up. On power up, the DAC register is filled with zeros and the output voltage is 0 V. The DAC register remains that way until a valid write sequence is made to the DAC. This design is useful in applications where knowing the state of the DAC output while powering up is important.

The occurring power-on glitch impulse is only a few millivolts (typically, 17 mV; see [图 7-34](#)).

8.4 Device Functional Modes

8.4.1 Power-Down Modes

The DACx311 contain four separate modes of operation. These modes are programmable by setting two bits (PD1 and PD0) in the control register. 表 8-1 shows how the state of the bits corresponds to the mode of operation of the device.

表 8-1. Modes of Operation for the DACx311

PD1	PD0	OPERATING MODE
NORMAL MODE		
0	0	Normal Operation
POWER-DOWN MODES		
0	1	Output 1 k Ω to GND
1	0	Output 100 k Ω to GND
1	1	High-Z

When both bits are set to 0, the device works normally with a standard power consumption of typically 80 μ A at 2 V. However, for the three power-down modes, the typical supply current falls to 0.5 μ A at 5 V, 0.4 μ A at 3 V, and 0.1 μ A at 2 V. Not only does the supply current fall, but the output stage is also internally switched from the output of the amplifier to a resistor network of known values. The advantage of this architecture is that the output impedance of the part is known while the part is in power-down mode. There are three different options: the output is connected internally to GND either through a 1-k Ω resistor or a 100-k Ω resistor, or is left open-circuited (High-Z). 图 8-3 illustrates the output stage.



图 8-3. Output Stage During Power-Down

All linear circuitry is shut down when the power-down mode is activated. However, the contents of the DAC register are unaffected when in power-down. The time to exit power-down is typically 50 μ s for $AV_{DD} = 5$ V and $AV_{DD} = 3$ V.

8.5 Programming

8.5.1 Serial Interface

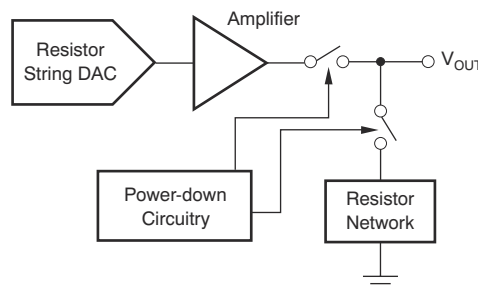
The DACx311 has a 3-wire serial interface ($\overline{\text{SYNC}}$, SCLK, and DIN) compatible with SPI, QSPI, and Microwire interface standards, as well as most DSPs. For an example of a typical write sequence, see [图 7-1](#).

8.5.1.1 Input Shift Register

The input shift register is 16 bits wide, as shown in [表 8-2](#). The first two bits (PD0 and PD1) are reserved control bits that set the desired mode of operation (normal mode or any one of three power-down modes) as indicated in [表 8-1](#).

The remaining data bits are either 12 (DAC7311), 10 (DAC6311), or 8 (DAC5311) data bits, followed by *don't care* bits, as shown in [表 8-2](#), [表 8-3](#), and [表 8-4](#), respectively.

表 8-2. DAC5311 8-Bit Data Input Register

DB15		DB14		DB6						DB5				DB0	
PD1	PD0	D7	D6	D5	D4	D3	D2	D1	D0	X	X	X	X	X	X

LEGEND: R/W = Read/Write; R = Read only; -n = value after reset

表 8-3. DAC6311 10-Bit Data Input Register

DB15		DB14		DB4						DB3		DB0			
PD1	PD0	D9	D8	D7	D6	D5	D4	D3	D2	D1	D0	X	X	X	X

LEGEND: R/W = Read/Write; R = Read only; -n = value after reset

表 8-4. DAC7311 12-Bit Data Input Register

DB15		DB14		DB2								DB1	DB0		
PD1	PD0	D11	D10	D9	D8	D7	D6	D5	D4	D3	D2	D1	D0	X	X

LEGEND: R/W = Read/Write; R = Read only; -n = value after reset

The write sequence begins by bringing the $\overline{\text{SYNC}}$ line low. Data from the DIN line are clocked into the 16-bit shift register on each falling edge of SCLK. The serial clock frequency can be as high as 50 MHz, making

the DACx311 compatible with high-speed DSPs. On the 16th falling edge of the serial clock, the last data bit is clocked in and the programmed function is executed.

At this point, the $\overline{\text{SYNC}}$ line can be kept low or brought high. In either case, $\overline{\text{SYNC}}$ must be brought high for a minimum of 20 ns before the next write sequence so that a falling edge of $\overline{\text{SYNC}}$ can initiate the next write sequence.

8.5.1.2 $\overline{\text{SYNC}}$ Interrupt

In a normal write sequence, the $\overline{\text{SYNC}}$ line is kept low for at least 16 falling edges of SCLK and the DAC is updated on the 16th falling edge. However, bringing $\overline{\text{SYNC}}$ high before the 16th falling edge acts as an interrupt to the write sequence. The shift register is reset and the write sequence is seen as invalid. Neither an update of the DAC register contents nor a change in the operating mode occurs, as shown in [图 8-4](#).



图 8-4. DACx311 $\overline{\text{SYNC}}$ Interrupt Facility

9 Application and Implementation

备注

以下应用部分中的信息不属于 TI 器件规格的范围，TI 不担保其准确性和完整性。TI 的客户应负责确定器件是否适用于其应用。客户应验证并测试其设计，以确保系统功能。

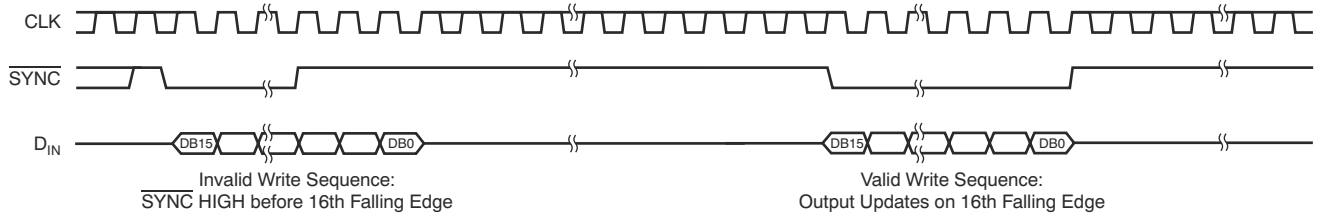
9.1 Application Information

9.1.1 Microprocessor Interfacing

9.1.1.1 DACx311 to 8051 Interface

图 9-1 shows a serial interface between the DACx311 and a typical 8051-type microcontroller. The setup for the interface is as follows: TXD of the 8051 drives SCLK of the DACx311, while RXD drives the serial data line of the device. The SYNC signal is derived from a bit programmable pin on the port. In this case, port line P3.3 is used. When data are to be transmitted to the DACx311, P3.3 is taken low. The 8051 transmits data only in 8-bit bytes; thus, only eight falling clock edges occur in the transmit cycle. To load data to the DAC, P3.3 remains low after the first eight bits are transmitted, and a second write cycle is initiated to transmit the second byte of data. P3.3 is taken high following the completion of this cycle. The 8051 outputs the serial data in a format that has the LSB first. The DACx311 requires data with the MSB as the first bit received. Therefore, the 8051 transmit routine must take this requirement into account, and *mirror* the data as needed.

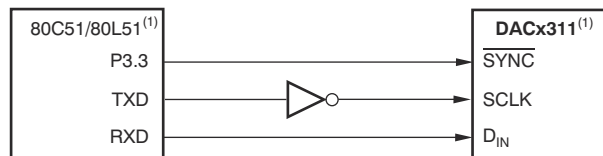

NOTE: (1) Additional pins omitted for clarity.

图 9-1. DACx311 to 80C51/80L51 Interfaces

9.1.1.2 DACx311 to Microwire Interface

图 9-2 shows an interface between the DACx311 and any Microwire-compatible device. Serial data (SO) are shifted out on the falling edge of the serial clock (SK) and are clocked into the DACx311 on the rising edge of the SK signal.

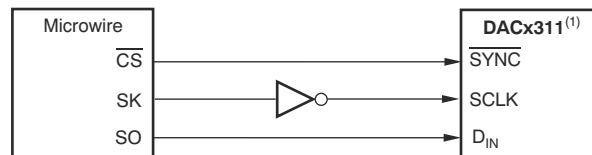

NOTE: (1) Additional pins omitted for clarity.

图 9-2. DACx311 to Microwire Interface

9.1.1.3 DACx311 to 68HC11 Interface

图 9-3 shows a serial interface between the DACx311 and the 68HC11 microcontroller. SCK of the 68HC11 drives the SCLK of the DACx311, while the MOSI output drives the serial data line of the DAC. The SYNC signal is derived from a port line (PC7), similar to what was done for the 8051.

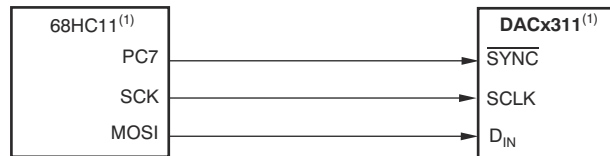

NOTE: (1) Additional pins omitted for clarity.

图 9-3. DACx311 to 68HC11 Interface

Configure the 68HC11 so that the CPOL bit is 0 and the CPHA bit is 1. This configuration causes data appearing on the MOSI output to be valid on the falling edge of SCK. When data are being transmitted to the DAC, the SYNC line is taken low (PC7). Serial data from the 68HC11 are transmitted in 8-bit bytes with only eight falling clock edges occurring in the transmit cycle. Data are transmitted MSB first. To load data to the DACx311, PC7 is held low after the first eight bits are transferred, and a second serial write operation is performed to the DAC; PC7 is taken high at the end of this procedure.

9.2 Typical Applications

9.2.1 Loop Powered Transmitter

The described loop powered transmitter can accurately source currents from 4 mA to 20 mA.



图 9-4. Loop Powered Transmitter Schematic

9.2.1.1 Design Requirements

The transmitter has only two external input pins; a supply connection and a ground (or return) connection. The transmitter communicates back to the host, typically a PLC analog input module, by precisely controlling the magnitude of the return current. To conform to the 4-mA to 20-mA communication standards, the complete transmitter must consume less than 4 mA of current.

The complete design of this circuit is outlined in [TIPD158, Low Cost Loop-Powered 4-20mA Transmitter EMC/EMI Tested Reference Design](#). The design is expected to be low-cost and deliver immunity to the IEC61000-4 suite of tests with minimum impact on the accuracy of the system. Reference design TIPD158 includes the design goals, simulated results, and measured performance.

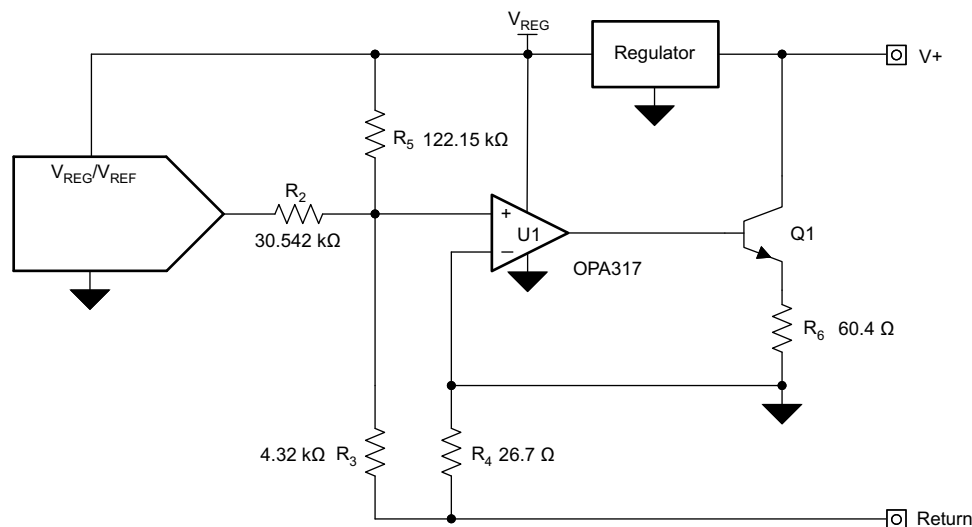
$$i_{out}(\text{Code}) = \left(\frac{V_{REG} \cdot \text{Code}}{2^{\text{Resolution}} \cdot R_2} + \frac{V_{REG}}{R_5} \right) \cdot \left(1 + \frac{R_3}{R_4} \right) \quad (5)$$

Resistor R_6 is included to reduce the gain of transistor Q1, and therefore, reduce the closed-loop gain of the voltage-to-current converter for a stable design. Size resistors R_2 , R_3 , R_4 , and R_5 based on the full-scale range of the DAC, regulator voltage, and the desired current output range of the design.

9.2.1.3 Application Curves

图 9-6 shows the measured transfer function of the circuit. 图 9-7 shows the total unadjusted error (TUE) of the circuit, staying below 0.15 %FSR.



图 9-6. Output Current vs Code



图 9-7. Current Total Unadjusted Error vs Code

9.2.2 Using the REF5050 as a Power Supply for the DACx311

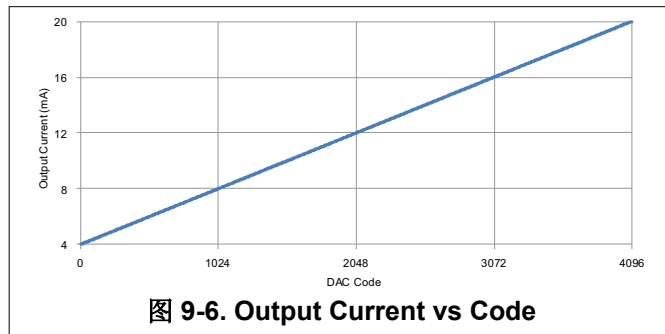
As a result of the extremely low supply current required by the DACx311, an alternative option is to use a REF5050 5-V precision voltage reference to supply the required voltage to the part, as shown in 图 9-8. This option is especially useful if the power supply is too noisy or if the system supply voltages are at some value other than 5 V. The REF5050 outputs a steady supply voltage for the DACx311. If the REF5050 is used, the current needed to supply DACx311 is typically 110 μ A at 5 V, with no load on the output of the DAC. When the DAC output is loaded, the REF5050 also needs to supply the current to the load. The total current required (with a 5 k Ω load on the DAC output) is:

$$110 \mu\text{A} + (5\text{ V} / 5\text{ k}\Omega) = 1.11\text{ mA} \quad (6)$$

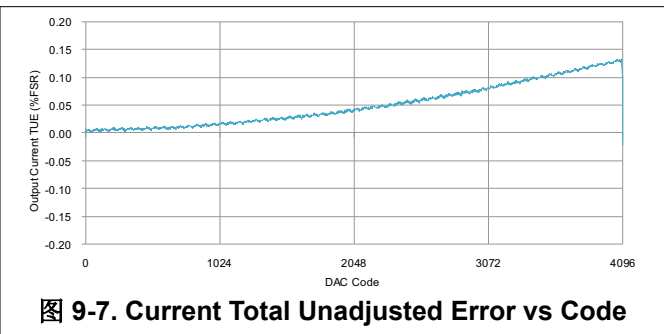
The load regulation of the REF5050 is typically 0.002%/mA, which results in an error of 90 μ V for the 1.1 mA current drawn from the device. This value corresponds to a 0.07 LSB error at 12 bits (DAC7311).



图 9-8. REF5050 as Power Supply to DACx311

For other power-supply voltages, alternative references such as the REF3030 (3 V), REF3033 (3.3 V), or REF3220 (2.048 V) are recommended. For a full list of available voltage references from TI, see the TI web site at www.ti.com.

9.2.3 Bipolar Operation Using the DACx311

The DACx311 has been designed for single-supply operation but a bipolar output range is also possible using the circuit in [图 9-9](#). The circuit shown gives an output voltage range of ± 5 V. Rail-to-rail operation at the amplifier output is achievable using an [OPA211](#), [OPA340](#), or [OPA703](#) as the output amplifier. For a full list of available operational amplifiers from TI, see the TI web site at www.ti.com

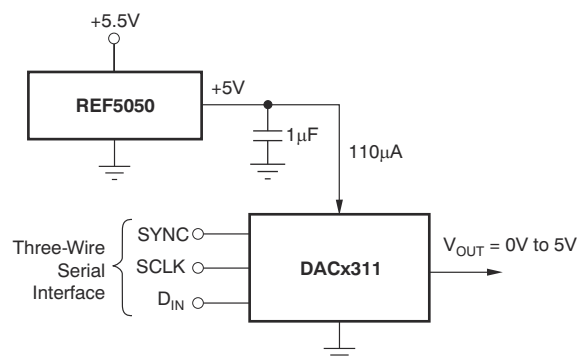
The output voltage for any input code can be calculated as follows:

$$V_O = \left[AV_{DD} \times \left(\frac{D}{2^n} \right) \times \left(\frac{R_1 + R_2}{R_1} \right) - AV_{DD} \times \left(\frac{R_2}{R_1} \right) \right] \quad (7)$$

where

- n = resolution in bits; either 8 (DAC5311), 10 (DAC6311), or 12 (DAC7311).
- D = decimal equivalent of the binary code that is loaded to the DAC register. D ranges from 0 to 255 for 8-bit DAC5311, 0 to 1023 for the 10-bit DAC6311 and 0 to 4095 for the 12-bit DAC7311.

With $AV_{DD} = 5$ V, $R_1 = R_2 = 10$ k Ω :

$$V_O = \left(\frac{10 \times D}{2^n} \right) - 5V \quad (8)$$

The resulting output voltage range is ± 5 V. Code 000h corresponds to a -5 -V output and FFFh (12-bit level) corresponding to a $+5$ -V output.



图 9-9. Bipolar Operation With the DACx311

9.3 Power Supply Recommendations

The DACx311 is designed to operate with a unipolar analog power supply ranging from 2.0 V to 5.5 V on the AV_{DD} pin. The AV_{DD} pin supplies power to the digital and analog circuits (including the resistor string) inside the DAC. The current consumption of this pin is specified in the [Electrical Characteristics](#) table. Use a 1μ F to 10μ F capacitor in parallel with a 0.1μ F bypass capacitor on this pin to remove high-frequency noise.

9.4 Layout

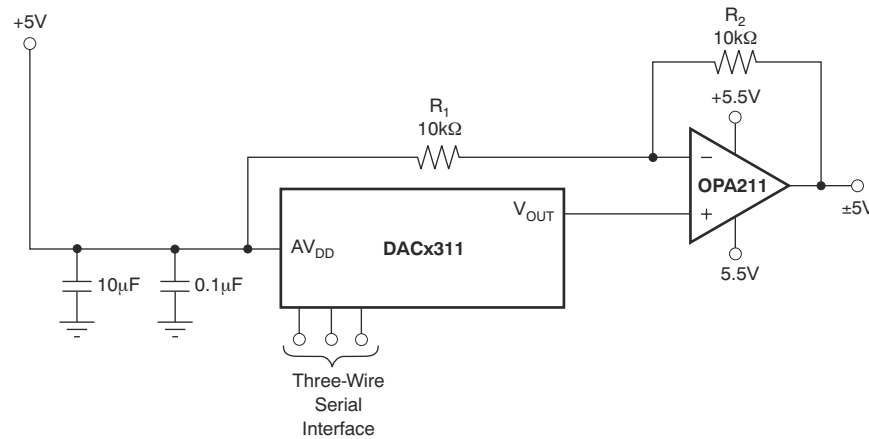
9.4.1 Layout Guidelines

A precision analog component requires careful layout, adequate bypassing, and clean, well-regulated power supplies.

The DACx311 offers single-supply operation, and is often used in close proximity to digital logic, microcontrollers, microprocessors, and digital signal processors. The more digital logic present in the design and the higher the switching speed, the more difficult the task is to achieve good performance from the converter.

As a result of the single ground pin of the DACx311, all return currents, including digital and analog return currents, must flow through the GND pin. Ideally, GND is connected directly to an analog ground plane. Separate this plane from the ground connection for the digital components until connected at the power entry point of the system.

The power applied to AV_{DD} must be well-regulated and low-noise. Switching power supplies and dc/dc converters often have high-frequency glitches or spikes riding on the output voltage. In addition, digital components can create similar high-frequency spikes as the internal logic switches state. This noise can easily couple into the DAC output voltage through various paths between the power connections and analog output. This condition is particularly true for the DACx311, as the power supply is also the reference voltage for the DAC.

As with the GND connection, connect AV_{DD} to a 5-V power supply plane or trace that is separate from the connection for digital logic until connected at the power entry point. In addition, 1- μ F to 10- μ F and 0.1- μ F bypass capacitors are strongly recommended. In some situations, additional bypassing can be required, such as a 100 μ F electrolytic capacitor or even a Pi filter made up of inductors and capacitors—all designed to essentially low-pass filter the 5-V supply and remove high-frequency noise.

9.4.2 Layout Example



图 9-10. Recommended Layout

10 Device and Documentation Support

10.1 接收文档更新通知

要接收文档更新通知，请导航至 ti.com 上的器件产品文件夹。点击 [订阅更新](#) 进行注册，即可每周接收产品信息更改摘要。有关更改的详细信息，请查看任何已修订文档中包含的修订历史记录。

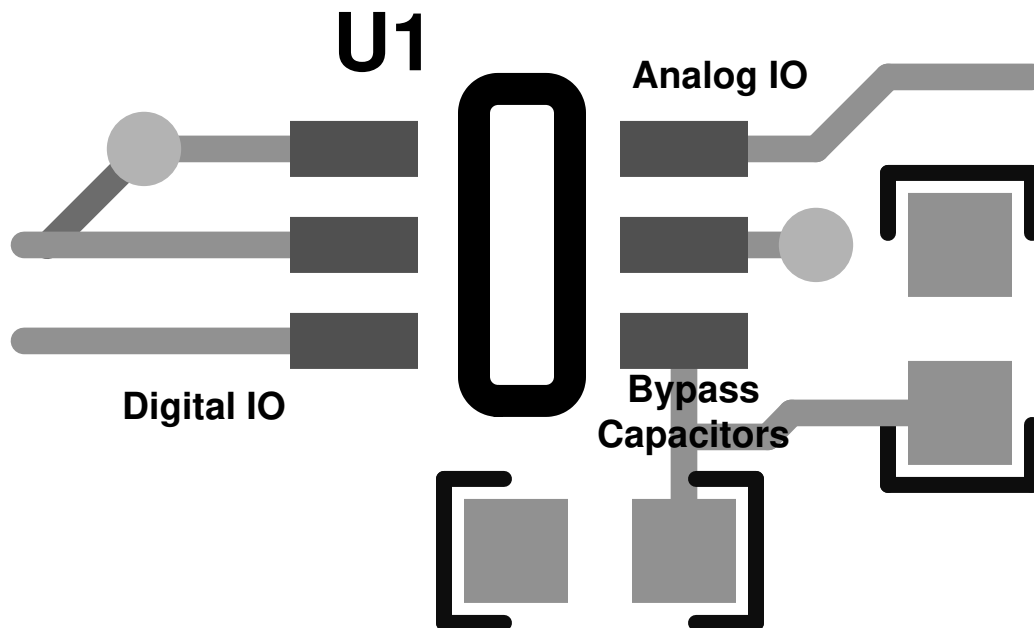
10.2 支持资源

TI E2E™ 支持论坛 是工程师的重要参考资料，可直接从专家获得快速、经过验证的解答和设计帮助。搜索现有解答或提出自己的问题可获得所需的快速设计帮助。

链接的内容由各个贡献者“按原样”提供。这些内容并不构成 TI 技术规范，并且不一定反映 TI 的观点；请参阅 TI 的《[使用条款](#)》。

10.3 Trademarks

TI E2E™ is a trademark of Texas Instruments.

所有商标均为其各自所有者的财产。

10.4 静电放电警告



静电放电 (ESD) 会损坏这个集成电路。德州仪器 (TI) 建议通过适当的预防措施处理所有集成电路。如果不遵守正确的处理和安装程序，可能会损坏集成电路。

ESD 的损坏小至导致微小的性能降级，大至整个器件故障。精密的集成电路可能更容易受到损坏，这是因为非常细微的参数更改都可能会导致器件与其发布的规格不相符。

10.5 术语表

TI 术语表 本术语表列出并解释了术语、首字母缩略词和定义。

11 Mechanical, Packaging, and Orderable Information

The following pages include mechanical, packaging, and orderable information. This information is the most current data available for the designated devices. This data is subject to change without notice and revision of this document. For browser-based versions of this data sheet, refer to the left-hand navigation.

PACKAGING INFORMATION

Orderable part number	Status (1)	Material type (2)	Package Pins	Package qty Carrier	RoHS (3)	Lead finish/ Ball material (4)	MSL rating/ Peak reflow (5)	Op temp (°C)	Part marking (6)
DAC5311IDCKR	Active	Production	SC70 (DCK) 6	3000 LARGE T&R	Yes	NIPDAU	Level-1-260C-UNLIM	-40 to 125	D53
DAC5311IDCKR.A	Active	Production	SC70 (DCK) 6	3000 LARGE T&R	Yes	NIPDAU	Level-1-260C-UNLIM	-40 to 125	D53
DAC5311IDCKRG4	Active	Production	SC70 (DCK) 6	3000 LARGE T&R	Yes	NIPDAU	Level-1-260C-UNLIM	-40 to 125	D53
DAC5311IDCKRG4.A	Active	Production	SC70 (DCK) 6	3000 LARGE T&R	Yes	NIPDAU	Level-1-260C-UNLIM	-40 to 125	D53
DAC5311IDCKT	Active	Production	SC70 (DCK) 6	250 SMALL T&R	Yes	NIPDAU	Level-1-260C-UNLIM	-40 to 125	D53
DAC5311IDCKT.A	Active	Production	SC70 (DCK) 6	250 SMALL T&R	Yes	NIPDAU	Level-1-260C-UNLIM	-40 to 125	D53
DAC6311IDCKR	Active	Production	SC70 (DCK) 6	3000 LARGE T&R	Yes	NIPDAU	Level-1-260C-UNLIM	-40 to 125	D63
DAC6311IDCKR.A	Active	Production	SC70 (DCK) 6	3000 LARGE T&R	Yes	NIPDAU	Level-1-260C-UNLIM	-40 to 125	D63
DAC6311IDCKRG4	Active	Production	SC70 (DCK) 6	3000 LARGE T&R	Yes	NIPDAU	Level-1-260C-UNLIM	-40 to 125	D63
DAC6311IDCKRG4.A	Active	Production	SC70 (DCK) 6	3000 LARGE T&R	Yes	NIPDAU	Level-1-260C-UNLIM	-40 to 125	D63
DAC6311IDCKT	Active	Production	SC70 (DCK) 6	250 SMALL T&R	Yes	NIPDAU	Level-1-260C-UNLIM	-40 to 125	D63
DAC6311IDCKT.A	Active	Production	SC70 (DCK) 6	250 SMALL T&R	Yes	NIPDAU	Level-1-260C-UNLIM	-40 to 125	D63
DAC6311IDCKTG4	Active	Production	SC70 (DCK) 6	250 SMALL T&R	Yes	NIPDAU	Level-1-260C-UNLIM	-40 to 125	D63
DAC7311IDCKR	Active	Production	SC70 (DCK) 6	3000 LARGE T&R	Yes	NIPDAU	Level-1-260C-UNLIM	-40 to 125	D73
DAC7311IDCKR.A	Active	Production	SC70 (DCK) 6	3000 LARGE T&R	Yes	NIPDAU	Level-1-260C-UNLIM	-40 to 125	D73
DAC7311IDCKRG4	Active	Production	SC70 (DCK) 6	3000 LARGE T&R	Yes	NIPDAU	Level-1-260C-UNLIM	-40 to 125	D73
DAC7311IDCKRG4.A	Active	Production	SC70 (DCK) 6	3000 LARGE T&R	Yes	NIPDAU	Level-1-260C-UNLIM	-40 to 125	D73
DAC7311IDCKT	Active	Production	SC70 (DCK) 6	250 SMALL T&R	Yes	NIPDAU	Level-1-260C-UNLIM	-40 to 125	D73
DAC7311IDCKT.A	Active	Production	SC70 (DCK) 6	250 SMALL T&R	Yes	NIPDAU	Level-1-260C-UNLIM	-40 to 125	D73
DAC7311IDCKTG4	Active	Production	SC70 (DCK) 6	250 SMALL T&R	Yes	NIPDAU	Level-1-260C-UNLIM	-40 to 125	D73

(1) **Status:** For more details on status, see our [product life cycle](#).

(2) **Material type:** When designated, preproduction parts are prototypes/experimental devices, and are not yet approved or released for full production. Testing and final process, including without limitation quality assurance, reliability performance testing, and/or process qualification, may not yet be complete, and this item is subject to further changes or possible discontinuation. If available for ordering, purchases will be subject to an additional waiver at checkout, and are intended for early internal evaluation purposes only. These items are sold without warranties of any kind.

(3) **RoHS values:** Yes, No, RoHS Exempt. See the [TI RoHS Statement](#) for additional information and value definition.

(4) **Lead finish/Ball material:** Parts may have multiple material finish options. Finish options are separated by a vertical ruled line. Lead finish/Ball material values may wrap to two lines if the finish value exceeds the maximum column width.

(5) **MSL rating/Peak reflow:** The moisture sensitivity level ratings and peak solder (reflow) temperatures. In the event that a part has multiple moisture sensitivity ratings, only the lowest level per JEDEC standards is shown. Refer to the shipping label for the actual reflow temperature that will be used to mount the part to the printed circuit board.

(6) **Part marking:** There may be an additional marking, which relates to the logo, the lot trace code information, or the environmental category of the part.

Multiple part markings will be inside parentheses. Only one part marking contained in parentheses and separated by a "~" will appear on a part. If a line is indented then it is a continuation of the previous line and the two combined represent the entire part marking for that device.

Important Information and Disclaimer:The information provided on this page represents TI's knowledge and belief as of the date that it is provided. TI bases its knowledge and belief on information provided by third parties, and makes no representation or warranty as to the accuracy of such information. Efforts are underway to better integrate information from third parties. TI has taken and continues to take reasonable steps to provide representative and accurate information but may not have conducted destructive testing or chemical analysis on incoming materials and chemicals. TI and TI suppliers consider certain information to be proprietary, and thus CAS numbers and other limited information may not be available for release.

In no event shall TI's liability arising out of such information exceed the total purchase price of the TI part(s) at issue in this document sold by TI to Customer on an annual basis.

OTHER QUALIFIED VERSIONS OF DAC5311 :

- Automotive : [DAC5311-Q1](#)

NOTE: Qualified Version Definitions:

- Automotive - Q100 devices qualified for high-reliability automotive applications targeting zero defects

TAPE AND REEL INFORMATION

QUADRANT ASSIGNMENTS FOR PIN 1 ORIENTATION IN TAPE

*All dimensions are nominal

Device	Package Type	Package Drawing	Pins	SPQ	Reel Diameter (mm)	Reel Width W1 (mm)	A0 (mm)	B0 (mm)	K0 (mm)	P1 (mm)	W (mm)	Pin1 Quadrant
DAC5311IDCKR	SC70	DCK	6	3000	178.0	9.0	2.4	2.5	1.2	4.0	8.0	Q3
DAC5311IDCKRG4	SC70	DCK	6	3000	178.0	9.0	2.4	2.5	1.2	4.0	8.0	Q3
DAC5311IDCKT	SC70	DCK	6	250	178.0	9.0	2.4	2.5	1.2	4.0	8.0	Q3
DAC6311IDCKR	SC70	DCK	6	3000	178.0	9.0	2.4	2.5	1.2	4.0	8.0	Q3
DAC6311IDCKRG4	SC70	DCK	6	3000	178.0	9.0	2.4	2.5	1.2	4.0	8.0	Q3
DAC6311IDCKT	SC70	DCK	6	250	178.0	9.0	2.4	2.5	1.2	4.0	8.0	Q3
DAC7311IDCKR	SC70	DCK	6	3000	178.0	9.0	2.4	2.5	1.2	4.0	8.0	Q3
DAC7311IDCKRG4	SC70	DCK	6	3000	178.0	9.0	2.4	2.5	1.2	4.0	8.0	Q3
DAC7311IDCKT	SC70	DCK	6	250	178.0	9.0	2.4	2.5	1.2	4.0	8.0	Q3

TAPE AND REEL BOX DIMENSIONS



*All dimensions are nominal

Device	Package Type	Package Drawing	Pins	SPQ	Length (mm)	Width (mm)	Height (mm)
DAC5311IDCKR	SC70	DCK	6	3000	180.0	180.0	18.0
DAC5311IDCKRG4	SC70	DCK	6	3000	180.0	180.0	18.0
DAC5311IDCKT	SC70	DCK	6	250	180.0	180.0	18.0
DAC6311IDCKR	SC70	DCK	6	3000	180.0	180.0	18.0
DAC6311IDCKRG4	SC70	DCK	6	3000	180.0	180.0	18.0
DAC6311IDCKT	SC70	DCK	6	250	180.0	180.0	18.0
DAC7311IDCKR	SC70	DCK	6	3000	180.0	180.0	18.0
DAC7311IDCKRG4	SC70	DCK	6	3000	180.0	180.0	18.0
DAC7311IDCKT	SC70	DCK	6	250	180.0	180.0	18.0



LAND PATTERN EXAMPLE
EXPOSED METAL SHOWN
SCALE:18X

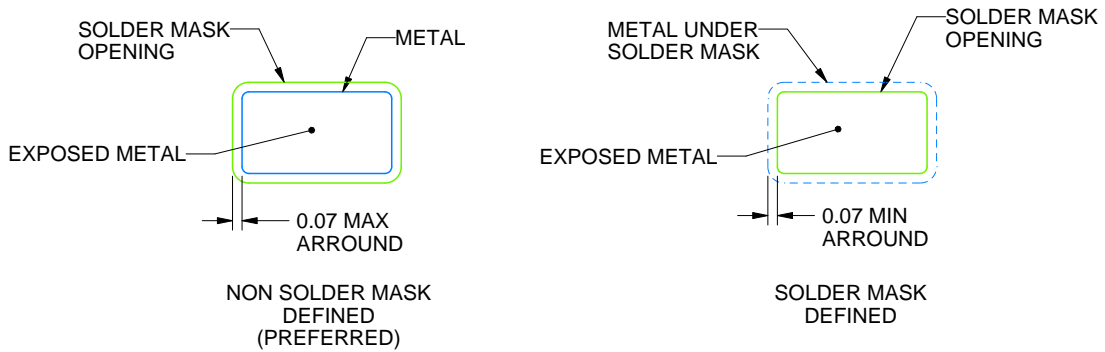

SOLDER MASK DETAILS

4214835/D 11/2024

NOTES: (continued)

- 5. Publication IPC-7351 may have alternate designs.
- 6. Solder mask tolerances between and around signal pads can vary based on board fabrication site.



SOLDER PASTE EXAMPLE
BASED ON 0.125 THICK STENCIL
SCALE:18X

4214835/D 11/2024

NOTES: (continued)

7. Laser cutting apertures with trapezoidal walls and rounded corners may offer better paste release. IPC-7525 may have alternate design recommendations.
8. Board assembly site may have different recommendations for stencil design.

重要通知和免责声明

TI“按原样”提供技术和可靠性数据（包括数据表）、设计资源（包括参考设计）、应用或其他设计建议、网络工具、安全信息和其他资源，不保证没有瑕疵且不做任何明示或暗示的担保，包括但不限于对适销性、与某特定用途的适用性或不侵犯任何第三方知识产权的暗示担保。

这些资源可供使用 TI 产品进行设计的熟练开发人员使用。您将自行承担以下全部责任：(1) 针对您的应用选择合适的 TI 产品，(2) 设计、验证并测试您的应用，(3) 确保您的应用满足相应标准以及任何其他安全、安保法规或其他要求。

这些资源如有变更，恕不另行通知。TI 授权您仅可将这些资源用于研发本资源所述的 TI 产品的相关应用。严禁以其他方式对这些资源进行复制或展示。您无权使用任何其他 TI 知识产权或任何第三方知识产权。对于因您对这些资源的使用而对 TI 及其代表造成的任何索赔、损害、成本、损失和债务，您将全额赔偿，TI 对此概不负责。

TI 提供的产品受 [TI 销售条款](#)、[TI 通用质量指南](#) 或 [ti.com](#) 上其他适用条款或 TI 产品随附的其他适用条款的约束。TI 提供这些资源并不会扩展或以其他方式更改 TI 针对 TI 产品发布的适用的担保或担保免责声明。除非德州仪器 (TI) 明确将某产品指定为定制产品或客户特定产品，否则其产品均为按确定价格收入目录的标准通用器件。

TI 反对并拒绝您可能提出的任何其他或不同的条款。

版权所有 © 2025，德州仪器 (TI) 公司

最后更新日期：2025 年 10 月