

## 具有关断功能的 LP2985 150mA 低噪声低压降稳压器

### 1 特性

- $V_{IN}$  范围 (新芯片) : 2.5V 至 16V
- $V_{OUT}$  范围 (新芯片) :
  - 1.2V 至 5.0V (固定值, 100mV 阶跃)
- $V_{OUT}$  精度:
  - A 级 (旧芯片) 为  $\pm 1\%$
  - 标准级 (旧芯片) 为  $\pm 1.5\%$
  - $\pm 0.5\%$  (新芯片)
- 在整个负载和温度范围内的输出精度为  $\pm 1\%$  (新芯片)
- 输出电流: 高达 150mA
- 低  $I_Q$  (新芯片) :  $I_{LOAD} = 0mA$  时为  $71 \mu A$
- 低  $I_Q$  (新芯片) :  $I_{LOAD} = 150mA$  时为  $750 \mu A$
- 关断电流:
  - $0.01 \mu A$  (典型值, 旧芯片)
  - $1.12 \mu A$  (典型值, 新芯片)
- 低噪声:  $30 \mu V_{RMS}$  (具有 10nF 旁路电容器)
- 输出电流限制和热保护
- 与  $2.2\mu F$  陶瓷电容器搭配使用时可保持稳定 (新芯片)
- 高 PSRR: 1kHz 时 70dB, 1MHz 时 40dB (新芯片)
- 工作结温:  $-40^\circ C$  至  $+125^\circ C$
- 封装: 5 引脚 SOT-23 (DBV)

### 2 应用

- 洗衣机和烘干机
- 陆地移动无线电
- 有源天线系统 mMIMO
- 无线电动工具
- 电机驱动器和控制板

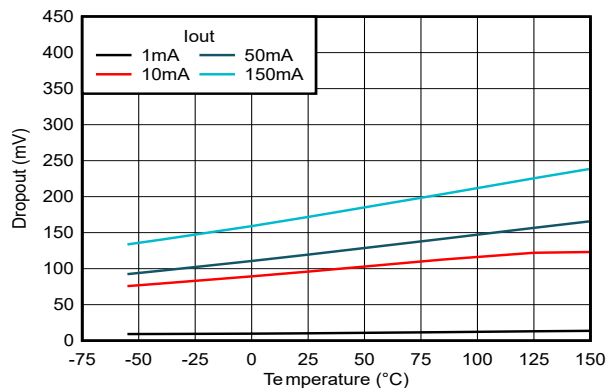

压降电压与温度间的关系 (新芯片)

### 3 说明

LP2985 是一款固定输出、宽输入、低噪声、低压降稳压器, 支持 2.5V 至 16V (对于新芯片) 的输入电压范围和高达 150mA 的负载电流。LP2985 支持 1.2V 至 5.0V 的输出范围 (对于新芯片)。

此外, LP2985 (新芯片) 在整个负载和温度范围内具有  $\pm 1\%$  的输出精度, 可满足低压微控制器 (MCU) 和处理器的需求。

$30\mu V_{RMS}$  的低输出噪声 (带 10nF 旁路电容器) 以及 1kHz 时大于 70dB 和 1MHz 时大于 40dB 的宽带宽 PSRR 性能有助于衰减上游直流/直流转换器的开关频率, 并尽可能减少后置稳压器滤波。

在新芯片中, 内部软启动机制可减小启动期间的浪涌电流, 从而最大限度降低输入电容。还包括标准保护特性, 例如过流和过热保护。

LP2985 采用 5 引脚、2.9mm × 2.8mm SOT-23 (DBV) 封装。

#### 封装信息

器件型号	封装 <sup>(1)</sup>	封装尺寸 <sup>(2)</sup>
LP2985	DBV (SOT-23, 5)	2.9mm × 2.8mm

- (1) 如需更多信息, 请参阅 [机械、封装和可订购信息](#)。
- (2) 封装尺寸 (长 × 宽) 为标称值, 并包括引脚 (如适用)。

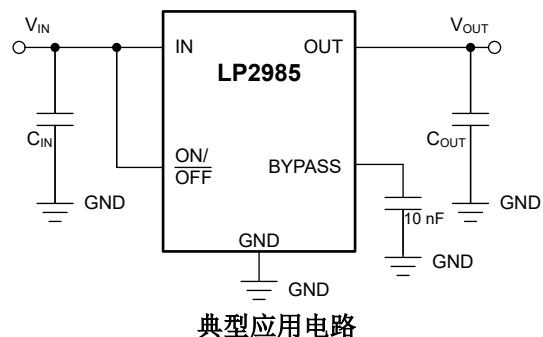

## Table of Contents

<b>1 特性</b> .....	<b>1</b>	<b>7 Application and Implementation</b> .....	<b>20</b>
<b>2 应用</b> .....	<b>1</b>	7.1 Application Information.....	20
<b>3 说明</b> .....	<b>1</b>	7.2 Typical Application.....	24
<b>4 Pin Configuration and Functions</b> .....	<b>3</b>	7.3 Power Supply Recommendations.....	29
<b>5 Specifications</b> .....	<b>4</b>	7.4 Layout.....	29
5.1 Absolute Maximum Ratings.....	4	<b>8 Device and Documentation Support</b> .....	<b>30</b>
5.2 ESD Ratings.....	4	8.1 Device Support.....	30
5.3 Recommended Operating Conditions.....	4	8.2 接收文档更新通知.....	30
5.4 Thermal Information.....	5	8.3 支持资源.....	30
5.5 Electrical Characteristics.....	5	8.4 Trademarks.....	30
5.6 Typical Characteristics.....	8	8.5 静电放电警告.....	30
<b>6 Detailed Description</b> .....	<b>15</b>	8.6 术语表.....	30
6.1 Overview.....	15	<b>9 Revision History</b> .....	<b>31</b>
6.2 Functional Block Diagrams.....	15	<b>10 Mechanical, Packaging, and Orderable Information</b> .....	<b>31</b>
6.3 Feature Description.....	16		
6.4 Device Functional Modes.....	18		

## 4 Pin Configuration and Functions



图 4-1. DBV Package, 5-Pin SOT-23 (Top View)

表 4-1. Pin Functions

PIN		TYPE	DESCRIPTION
NAME	NO.		
BYPASS	4	I/O	BYPASS pin to achieve low noise performance. Connecting an external capacitor between BYPASS pin and ground reduces reference voltage noise. See the <a href="#">Recommended Operating Conditions</a> section for more information.
GND	2	—	Ground
ON/OFF	3	I	Enable pin for the LDO. Driving the ON/OFF pin high enables the device. Driving this pin low disables the device. High and low thresholds are listed in the <a href="#">Electrical Characteristics</a> table. Tie this pin to $V_{IN}$ if unused.
$V_{IN}$	1	I	Input supply pin. Use a capacitor with a value of 1 $\mu\text{F}$ or larger from this pin to ground. See the <a href="#">Input and Output Capacitor Requirements</a> section for more information.
$V_{OUT}$	5	O	Output of the regulator. Use a capacitor with a value of 2.2 $\mu\text{F}$ or larger from this pin to ground. <sup>(1)</sup> See the <a href="#">Input and Output Capacitor Requirements</a> section for more information.

- (1) The nominal output capacitance must be greater than 1  $\mu\text{F}$ . Throughout this document, the nominal derating on these capacitors is 50%. Make sure that the effective capacitance at the pin is greater than 1  $\mu\text{F}$ .

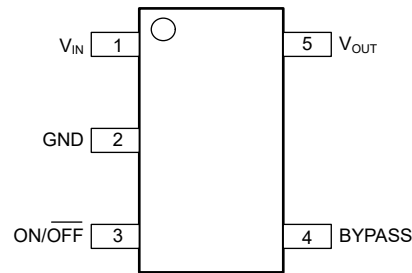
## 5 Specifications

### 5.1 Absolute Maximum Ratings

over operating free-air temperature range (unless otherwise noted)<sup>(1) (2)</sup>

		MIN	MAX	UNIT
V <sub>IN</sub>	Continuous input voltage range (for legacy chip)	- 0.3	16	V
	Continuous input voltage range (for new chip)	- 0.3	18	
V <sub>OUT</sub>	Output voltage range (for legacy chip)	- 0.3	9	
	Output voltage range (for new chip)	- 0.3	V <sub>IN</sub> + 0.3 or 9 (whichever is smaller)	
V <sub>BYPASS</sub>	BYPASS pin voltage range (for new chip)	- 0.3	3	
V <sub>ON/OFF</sub>	ON/OFF pin voltage range (for legacy chip)	- 0.3	16	
	ON/OFF pin voltage range (for new chip)	- 0.3	18	
Current	Maximum output	Internally limited		A
Temperature	Operating junction, T <sub>J</sub>	- 55	150	°C
	Storage, T <sub>stg</sub>	- 65	150	

- (1) Stresses beyond those listed under *Absolute Maximum Ratings* may cause permanent damage to the device. These are stress ratings only, which do not imply functional operation of the device at these or any other conditions beyond those indicated under *Recommended Operating Conditions*. Exposure to absolute-maximum-rated conditions for extended periods may affect device reliability.
- (2) All voltages with respect to GND.

### 5.2 ESD Ratings

			VALUE (Legacy Chip)	VALUE (New Chip)	UNIT
V <sub>(ESD)</sub>	Electrostatic discharge	Human body model (HBM), per ANSI/ESDA/JEDEC JS-001 <sup>(1)</sup>	±2000	±3000	V
		Charged device model (CDM), per JEDEC specification JESD22-C101 <sup>(2)</sup>	±500	±1000	

- (1) JEDEC document JEP155 states that 2-kV HBM allows safe manufacturing with a standard ESD control process.
- (2) JEDEC document JEP157 states that 500-V CDM allows safe manufacturing with a standard ESD control process.

### 5.3 Recommended Operating Conditions

		MIN	NOM	MAX	UNIT
V <sub>IN</sub>	Supply input voltage (for legacy chip)	2.2		16	V
	Supply input voltage (for new chip)	2.5		16	
V <sub>OUT</sub>	Output voltage (for legacy chip)	1.2		10.0	V
	Output voltage (for new chip)	1.2		5.0	
V <sub>BYPASS</sub>	Bypass voltage		1.2		V
V <sub>ON/OFF</sub>	Enable voltage (for legacy chip)	0		V <sub>IN</sub>	V
	Enable voltage (for new chip)	0		16	
I <sub>OUT</sub>	Output current	0		150	mA
C <sub>IN</sub> <sup>(1)</sup>	Input capacitor		1		μF
C <sub>OUT</sub>	Output capacitance (for legacy chip)	2.2	4.7		μF
	Output capacitance (for new chip) <sup>(1)</sup>	1	2.2	200	
C <sub>OUT</sub> ESR <sup>(3)</sup>	Output capacitor ESR (for new chip) <sup>(2)</sup>	0		1	Ω
T <sub>J</sub>	Operating junction temperature	- 40		125	°C

- (1) All capacitor values are assumed to derate to 50% of the nominal capacitor value. Maintain an effective output capacitance of 1 μF minimum for stability.
- (2) Details related to supported ESR range for the legacy chip are available in *Recommended Capacitors for the Legacy Chip*

- (3) Maximum supported ESR range for new chip is 1Ω. For output capacitor with higher ESR values, place a low ESR MLCC capacitor with value of 100nF, close to the output pin of the LDO.

## 5.4 Thermal Information

THERMAL METRIC <sup>(2)</sup> <sup>(1)</sup>		Legacy Chip	New Chip	UNIT
		DBV (SOT23-5)	DBV (SOT23-5)	
		5 PINS	5 PINS	
R <sub>θJA</sub>	Junction-to-ambient thermal resistance	205.4	178.6	°C/W
R <sub>θJC(top)</sub>	Junction-to-case (top) thermal resistance	78.8	77.9	°C/W
R <sub>θJB</sub>	Junction-to-board thermal resistance	46.7	47.2	°C/W
ψ <sub>JT</sub>	Junction-to-top characterization parameter	8.3	15.9	°C/W
ψ <sub>JB</sub>	Junction-to-board characterization parameter	46.3	46.9	°C/W

- (1) For more information about traditional and new thermal metrics, see the [Semiconductor and IC Package Thermal Metrics](#) application note.
- (2) Thermal performance results are based on the JEDEC standard of 2s2p PCB configuration. These thermal metric parameters can be further improved by 35-55% based on thermally optimized PCB layout designs. See the analysis of the [Impact of board layout on LDO thermal performance](#) application note.

## 5.5 Electrical Characteristics

specified at T<sub>J</sub> = 25°C, V<sub>IN</sub> = V<sub>OUT(nom)</sub> + 1.0 V or V<sub>IN</sub> = 2.5 V (whichever is greater), I<sub>OUT</sub> = 1 mA, V<sub>ON/OFF</sub> = 2 V, C<sub>IN</sub> = 1.0 μF, and C<sub>OUT</sub> = 2.2 μF (unless otherwise noted)

PARAMETER		TEST CONDITIONS		MIN	TYP	MAX	UNIT
ΔV <sub>OUT</sub>	Output voltage tolerance	I <sub>L</sub> = 1 mA	Legacy chip (standard grade)	- 1.5		1.5	%
			Legacy chip (A grade)	- 1.0		1.0	
			New chip	- 0.5		0.5	
		1 mA ≤ I <sub>L</sub> ≤ 50 mA	Legacy chip (standard grade)	- 2.5		2.5	
			Legacy chip (A grade)	- 1.5		1.5	
			New chip	- 0.5		0.5	
		1 mA ≤ I <sub>L</sub> ≤ 150 mA	Legacy chip (standard grade)	- 3.0		3.0	
			Legacy chip (A grade)	- 2.5		2.5	
			New chip	- 0.5		0.5	
		1 mA ≤ I <sub>L</sub> ≤ 50 mA, - 40°C ≤ T <sub>J</sub> ≤ 125°C	Legacy chip (standard grade)	- 3.5		3.5	
			Legacy chip (A grade)	- 2.5		2.5	
			New chip	- 1		1	
1 mA ≤ I <sub>L</sub> ≤ 150 mA, - 40°C ≤ T <sub>J</sub> ≤ 125°C	Legacy chip (standard grade)	- 4.0		4.0			
	Legacy chip (A grade)	- 3.5		3.5			
	New chip	- 1		1			

### 5.5 Electrical Characteristics (续)

specified at  $T_J = 25^\circ\text{C}$ ,  $V_{IN} = V_{OUT(nom)} + 1.0\text{ V}$  or  $V_{IN} = 2.5\text{ V}$  (whichever is greater),  $I_{OUT} = 1\text{ mA}$ ,  $V_{ON/OFF} = 2\text{ V}$ ,  $C_{IN} = 1.0\ \mu\text{F}$ , and  $C_{OUT} = 2.2\ \mu\text{F}$  (unless otherwise noted)

PARAMETER		TEST CONDITIONS	MIN	TYP	MAX	UNIT
$\Delta V_{OUT(\Delta V_{IN})}$	Line regulation	$V_{O(NOM)} + 1\text{ V} \leq V_{IN} \leq 16\text{ V}$	Legacy chip	0.007	0.014	%V
			New chip	0.002	0.014	
		$V_{O(NOM)} + 1\text{ V} \leq V_{IN} \leq 16\text{ V}, -40^\circ\text{C} \leq T_J \leq 125^\circ\text{C}$	Legacy chip	0.007	0.032	
			New chip	0.002	0.032	
$V_{IN} - V_{OUT}$	Dropout voltage <sup>(1)</sup>	$I_{OUT} = 0\text{ mA}$	Legacy chip	1	3	mV
			New chip	1	2.75	
		$I_{OUT} = 0\text{ mA}, -40^\circ\text{C} \leq T_J \leq 125^\circ\text{C}$	Legacy chip		5	
			New chip		3	
		$I_{OUT} = 1\text{ mA}$	Legacy chip	7	10	
			New chip	11.5	14	
		$I_{OUT} = 1\text{ mA}, -40^\circ\text{C} \leq T_J \leq 125^\circ\text{C}$	Legacy chip		15	
			New chip		17	
		$I_{OUT} = 10\text{ mA}$	Legacy chip	40	60	
			New chip	98	115	
		$I_{OUT} = 10\text{ mA}, -40^\circ\text{C} \leq T_J \leq 125^\circ\text{C}$	Legacy chip		90	
			New chip		148	
		$I_{OUT} = 50\text{ mA}$	Legacy chip	120	150	
			New chip	120	145	
		$I_{OUT} = 50\text{ mA}, -40^\circ\text{C} \leq T_J \leq 125^\circ\text{C}$	Legacy chip		225	
			New chip		184	
$I_{OUT} = 150\text{ mA}$	Legacy chip	280	350			
	New chip	180	198			
$I_{OUT} = 150\text{ mA}, -40^\circ\text{C} \leq T_J \leq 125^\circ\text{C}$	Legacy chip		575			
	New chip		254			
$I_{GND}$	GND pin current	$I_{OUT} = 0\text{ mA}$	Legacy chip	65	95	$\mu\text{A}$
			New chip	69	95	
		$I_{OUT} = 0\text{ mA}, -40^\circ\text{C} \leq T_J \leq 125^\circ\text{C}$	Legacy chip		125	
			New chip		123	
		$I_{OUT} = 1\text{ mA}$	Legacy chip	75	110	
			New chip	78	110	
		$I_{OUT} = 1\text{ mA}, -40^\circ\text{C} \leq T_J \leq 125^\circ\text{C}$	Legacy chip		170	
			New chip		140	
$I_{GND}$	GND pin current	$I_{OUT} = 10\text{ mA}$	Legacy chip	120	220	$\mu\text{A}$
			New chip	175	210	
		$I_{OUT} = 10\text{ mA}, -40^\circ\text{C} \leq T_J \leq 125^\circ\text{C}$	Legacy chip		400	
			New chip		250	
$I_{GND}$	GND pin current	$I_{OUT} = 50\text{ mA}$	Legacy chip	350	600	$\mu\text{A}$
			New chip	380	440	
$I_{GND}$	GND pin current	$I_{OUT} = 50\text{ mA}, -40^\circ\text{C} \leq T_J \leq 125^\circ\text{C}$	Legacy chip		900	$\mu\text{A}$
$I_{GND}$	GND pin current	$I_{OUT} = 50\text{ mA}, -40^\circ\text{C} \leq T_J \leq 125^\circ\text{C}$	New chip		650	$\mu\text{A}$
$I_{GND}$	GND pin current	$I_{OUT} = 150\text{ mA}$	Legacy chip	850	1200	$\mu\text{A}$
$I_{GND}$	GND pin current	$I_{OUT} = 150\text{ mA}$	New chip	765	890	$\mu\text{A}$

## 5.5 Electrical Characteristics (续)

specified at  $T_J = 25^\circ\text{C}$ ,  $V_{IN} = V_{OUT(nom)} + 1.0\text{ V}$  or  $V_{IN} = 2.5\text{ V}$  (whichever is greater),  $I_{OUT} = 1\text{ mA}$ ,  $V_{ON/OFF} = 2\text{ V}$ ,  $C_{IN} = 1.0\text{ }\mu\text{F}$ , and  $C_{OUT} = 2.2\text{ }\mu\text{F}$  (unless otherwise noted)

PARAMETER		TEST CONDITIONS	MIN	TYP	MAX	UNIT
$I_{GND}$	GND pin current	$I_{OUT} = 150\text{ mA}$ , $-40^\circ\text{C} \leq T_J \leq 125^\circ\text{C}$			2000	$\mu\text{A}$
$I_{GND}$	GND pin current	$I_{OUT} = 150\text{ mA}$ , $-40^\circ\text{C} \leq T_J \leq 125^\circ\text{C}$			1060	$\mu\text{A}$
$I_{GND}$	GND pin current	$V_{ON/OFF} < 0.3\text{ V}$ , $V_{IN} = 16\text{ V}$		0.01	0.08	$\mu\text{A}$
$I_{GND}$	GND pin current	$V_{ON/OFF} < 0.3\text{ V}$ , $V_{IN} = 16\text{ V}$		1.25	1.75	$\mu\text{A}$
$I_{GND}$	GND pin current	$V_{ON/OFF} < 0.15\text{ V}$ , $V_{IN} = 16\text{ V}$ , $-40^\circ\text{C} \leq T_J \leq 85^\circ\text{C}$		0	1	$\mu\text{A}$
$I_{GND}$	GND pin current	$V_{ON/OFF} < 0.15\text{ V}$ , $V_{IN} = 16\text{ V}$ , $-40^\circ\text{C} \leq T_J \leq 85^\circ\text{C}$		1.12	2.25	$\mu\text{A}$
$I_{GND}$	GND pin current	$V_{ON/OFF} < 0.15\text{ V}$ , $V_{IN} = 16\text{ V}$ , $-40^\circ\text{C} \leq T_J \leq 125^\circ\text{C}$		0.01	2	$\mu\text{A}$
$I_{GND}$	GND pin current	$V_{ON/OFF} < 0.15\text{ V}$ , $V_{IN} = 16\text{ V}$ , $-40^\circ\text{C} \leq T_J \leq 125^\circ\text{C}$		1.12	2.75	$\mu\text{A}$
$V_{UVLO+}$	Rising bias supply UVLO	$V_{IN}$ rising, $-40^\circ\text{C} \leq T_J \leq 125^\circ\text{C}$		2.2	2.4	V
$V_{UVLO-}$	Falling bias supply UVLO	$V_{IN}$ falling, $-40^\circ\text{C} \leq T_J \leq 125^\circ\text{C}$		1.9		V
$V_{UVLO(HYST)}$	UVLO hysteresis	$-40^\circ\text{C} \leq T_J \leq 125^\circ\text{C}$		0.130		V
$V_{ON/OFF}$	ON/OFF input voltage	Low = Output OFF	Legacy chip	0.55		V
			New chip	0.72		
		Low = Output OFF, $V_{OUT} + 1 \leq V_{IN} \leq 16\text{ V}$ , $-40^\circ\text{C} \leq T_J \leq 125^\circ\text{C}$	Legacy chip		0.15	
			New chip		0.15	
		High = Output ON	Legacy chip	1.4		
			New chip	0.85		
		High = Output ON, $V_{OUT} + 1 \leq V_{IN} \leq 16\text{ V}$ , $-40^\circ\text{C} \leq T_J \leq 125^\circ\text{C}$	Legacy chip	1.6		
			New chip	1.6		
$I_{ON/OFF}$	ON/OFF input current	$V_{ON/OFF} = 0\text{ V}$	Legacy chip	0.01		$\mu\text{A}$
			New chip	0.42		
$I_{ON/OFF}$	ON/OFF input current	$V_{ON/OFF} = 0\text{ V}$ , $V_{OUT} + 1 \leq V_{IN} \leq 16\text{ V}$ , $-40^\circ\text{C} \leq T_J \leq 125^\circ\text{C}$	Legacy chip		-1	$\mu\text{A}$
			New chip		-0.9	$\mu\text{A}$
		$V_{ON/OFF} = 5\text{ V}$	Legacy chip	5		$\mu\text{A}$
			New chip	0.011		$\mu\text{A}$
		$V_{ON/OFF} = 5\text{ V}$ , $V_{OUT} + 1 \leq V_{IN} \leq 16\text{ V}$ , $-40^\circ\text{C} \leq T_J \leq 125^\circ\text{C}$	Legacy chip		15	$\mu\text{A}$
			New chip		2.20	$\mu\text{A}$
$I_{O(PK)}$	Peak output current	$V_{OUT} \geq V_{O(NOM)} - 5\%$ (steady state)	Legacy chip	300	350	mA
			New chip	300	350	
$I_{O(SC)}$	Short output current	$R_L = 0\text{ }\Omega$ (steady state)	Legacy chip	400		mA
			New chip	375		
$\Delta V_O / \Delta V_{IN}$	Ripple rejection	$f = 1\text{ kHz}$ , $C_{BYPASS} = 10\text{ nF}$ , $C_{OUT} = 10\text{ }\mu\text{F}$	Legacy chip	45		dB
			New chip	78		
$V_n$	Output noise voltage	Bandwidth = 300 Hz to 50 kHz, $C_{BYPASS} = 10\text{ nF}$ , $C_{OUT} = 2.2\text{ }\mu\text{F}$ , $V_{OUT} = 3.3\text{ V}$ , $I_{LOAD} = 150\text{ mA}$	Legacy chip	30		$\mu\text{VRMS}$
			New chip	30		
$T_{sd+}$	Thermal shutdown threshold	Shutdown, temperature increasing	New chip	170		$^\circ\text{C}$
$T_{sd-}$		Reset, temperature decreasing		150		

(1) Dropout voltage ( $V_{DO}$ ) is defined as the input-to-output differential at which the output voltage drops 100 mV below the value measured with a 1 V differential.  $V_{DO}$  is measured with  $V_{IN} = V_{OUT(nom)} - 100\text{ mV}$  for fixed output devices.

### 5.6 Typical Characteristics

at operating temperature  $T_J = 25^\circ\text{C}$ ,  $V_{IN} = V_{OUT(NOM)} + 1.0\text{ V}$  or  $2.5\text{ V}$  (whichever is greater),  $I_{OUT} = 1\text{ mA}$ , ON/OFF pin tied to  $V_{IN}$ ,  $C_{IN} = 1.0\text{ }\mu\text{F}$ , and  $C_{OUT} = 4.7\text{ }\mu\text{F}$  (unless otherwise noted)



图 5-1. Output Voltage vs Temperature for Legacy Chip



图 5-2. Output Voltage vs Temperature for Legacy Chip

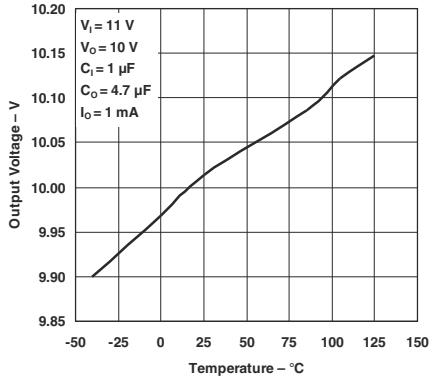

$V_{IN} = 4.3\text{ V}$ ,  $V_{OUT} = 3.3\text{ V}$  (for new chip)

图 5-3. Output Voltage vs Temperature for New Chip

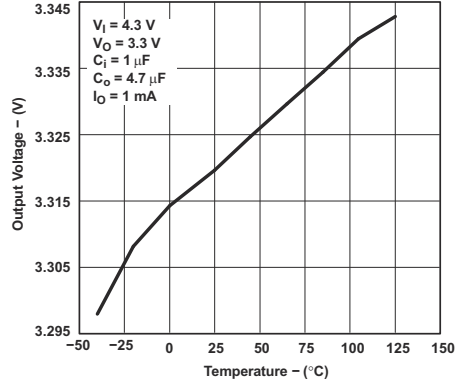
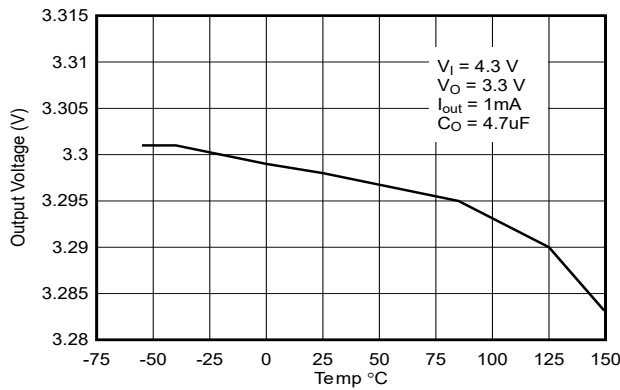

图 5-4. Dropout Voltage vs Temperature for Legacy Chip



图 5-5. Dropout Voltage vs Temperature for New Chip

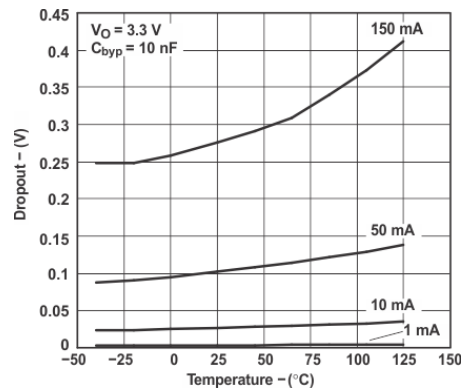

图 5-6. Dropout Voltage vs Load Current for New Chip

### 5.6 Typical Characteristics (continued)

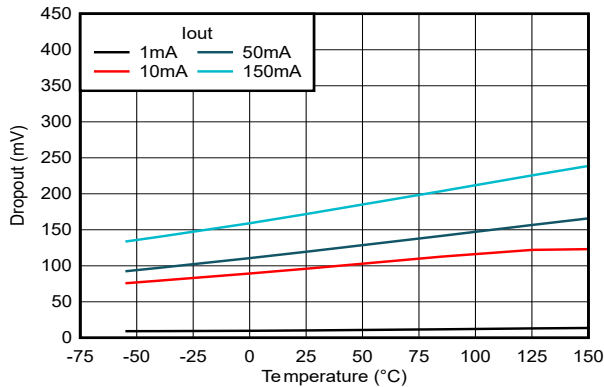
at operating temperature  $T_J = 25^\circ\text{C}$ ,  $V_{IN} = V_{OUT(NOM)} + 1.0\text{ V}$  or  $2.5\text{ V}$  (whichever is greater),  $I_{OUT} = 1\text{ mA}$ , ON/OFF pin tied to  $V_{IN}$ ,  $C_{IN} = 1.0\ \mu\text{F}$ , and  $C_{OUT} = 4.7\ \mu\text{F}$  (unless otherwise noted)

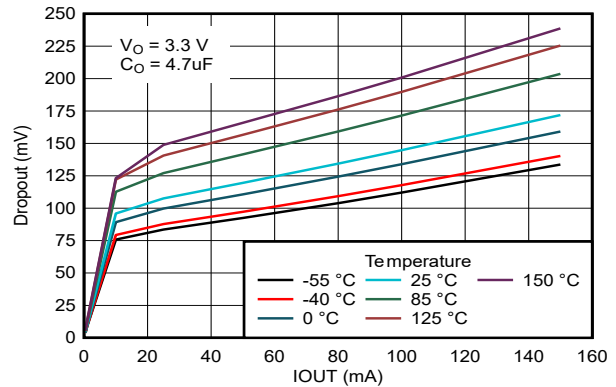

图 5-7. Output Regulation vs Load Current for New Chip



图 5-8. Output Regulation vs Input Voltage for New Chip

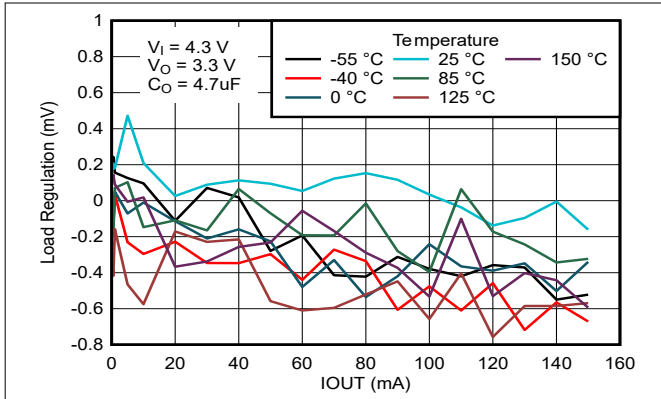

图 5-9. Short-Circuit Current vs Time for Legacy Chip

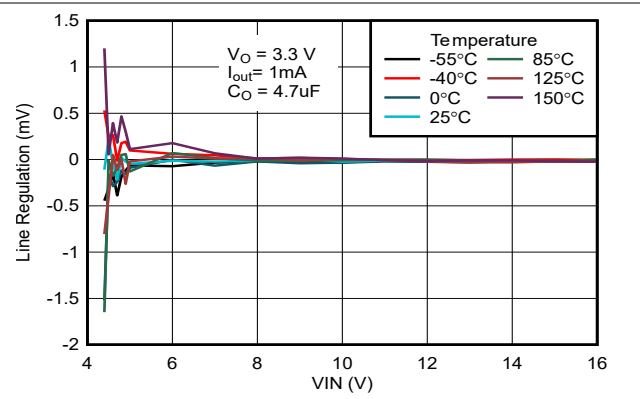

图 5-10. Short-Circuit Current vs Time for New Chip

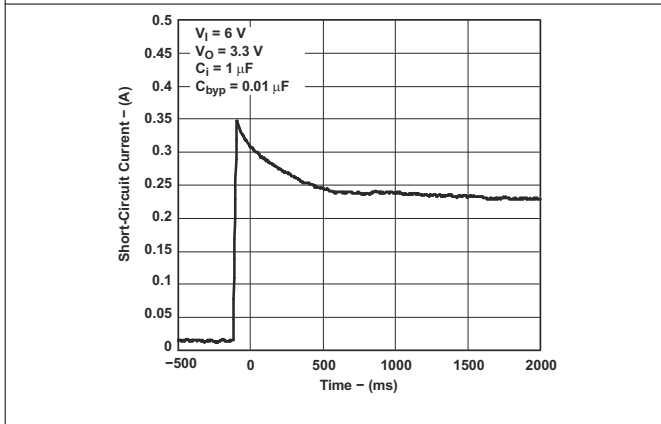

图 5-11. Short-Circuit Current vs Time for Legacy Chip

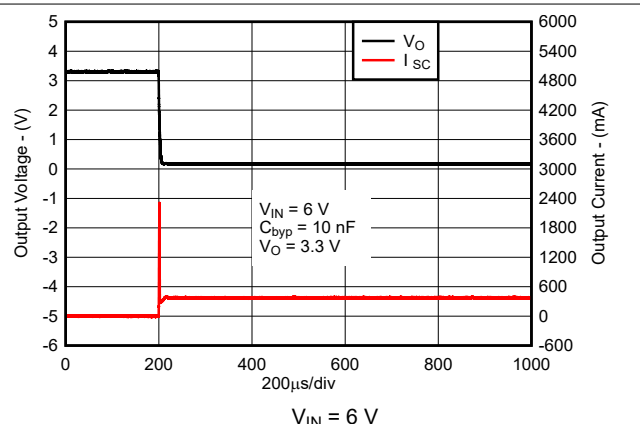

图 5-12. Short-Circuit Current vs Time for New Chip

### 5.6 Typical Characteristics (continued)

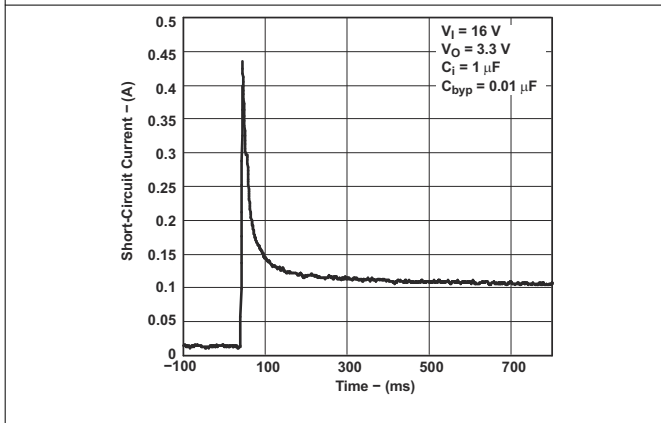
at operating temperature  $T_J = 25^\circ\text{C}$ ,  $V_{IN} = V_{OUT(NOM)} + 1.0\text{ V}$  or  $2.5\text{ V}$  (whichever is greater),  $I_{OUT} = 1\text{ mA}$ , ON/OFF pin tied to  $V_{IN}$ ,  $C_{IN} = 1.0\ \mu\text{F}$ , and  $C_{OUT} = 4.7\ \mu\text{F}$  (unless otherwise noted)

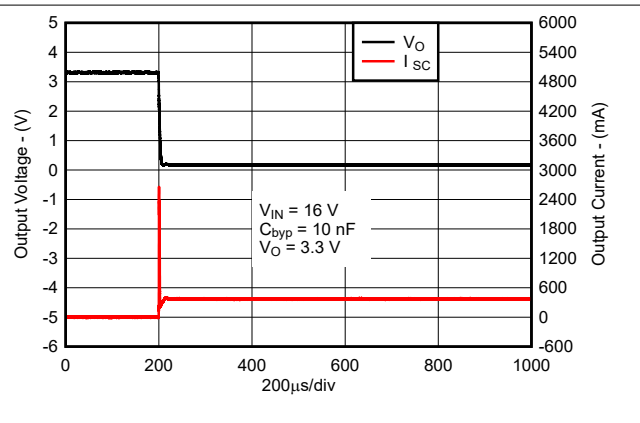

图 5-13. Short-Circuit Current vs Output Voltage for Legacy Chip



图 5-14. Short-Circuit Current vs Output Voltage for New Chip

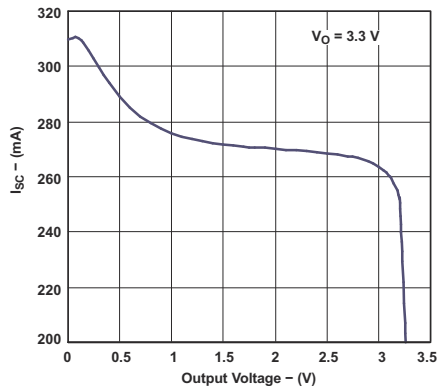

图 5-15. Short-Circuit Current vs Temperature for New Chip

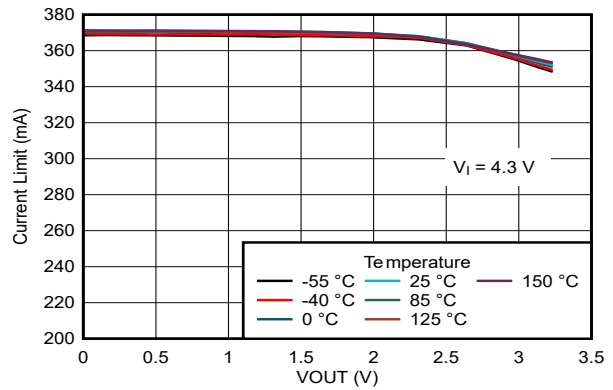

图 5-16. Ground Pin Current vs Load Current for Legacy Chip

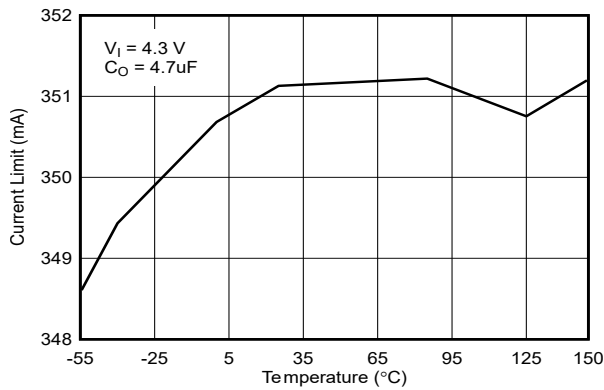

图 5-17. Ground Pin Current vs Load Current for New Chip

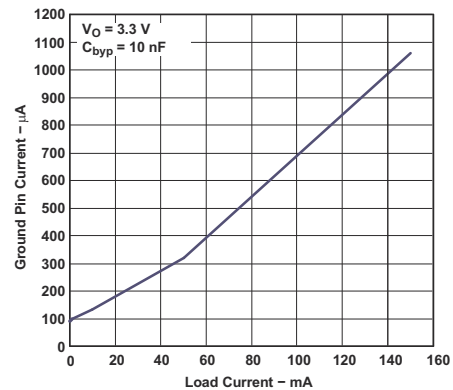

图 5-18. Ripple Rejection vs Frequency for Legacy Chip

### 5.6 Typical Characteristics (continued)

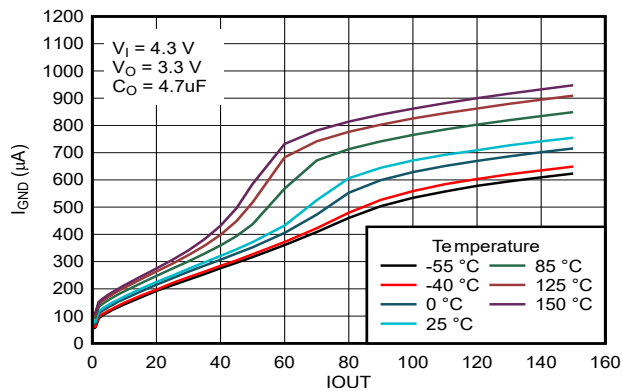
at operating temperature  $T_J = 25^\circ\text{C}$ ,  $V_{IN} = V_{OUT(NOM)} + 1.0\text{ V}$  or  $2.5\text{ V}$  (whichever is greater),  $I_{OUT} = 1\text{ mA}$ , ON/OFF pin tied to  $V_{IN}$ ,  $C_{IN} = 1.0\text{ }\mu\text{F}$ , and  $C_{OUT} = 4.7\text{ }\mu\text{F}$  (unless otherwise noted)

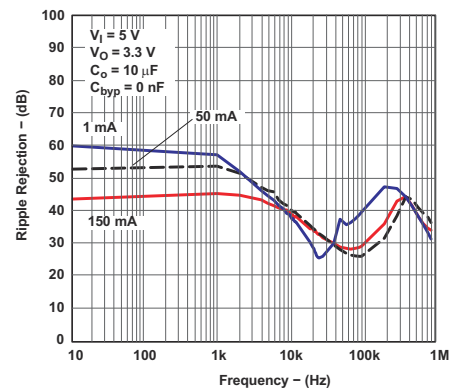

图 5-19. Ripple Rejection vs Frequency for New Chip



图 5-20. Ripple Rejection vs Frequency for Legacy Chip

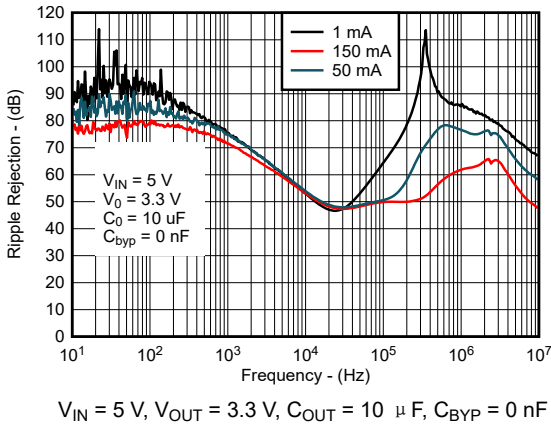

图 5-21. Ripple Rejection vs Frequency for New Chip

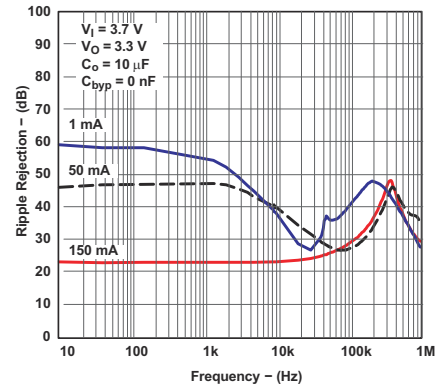

图 5-22. Ripple Rejection vs Frequency for Legacy Chip

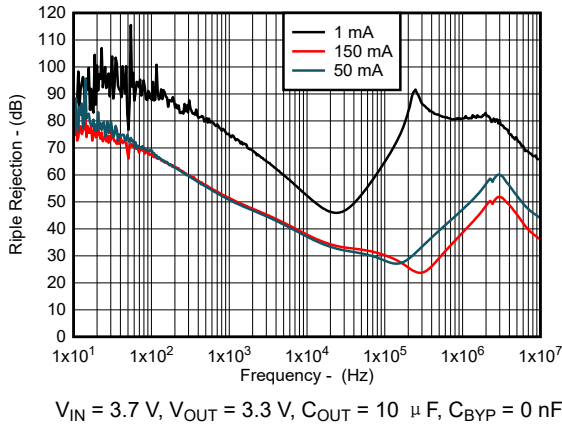

图 5-23. Ripple Rejection vs Frequency for New Chip

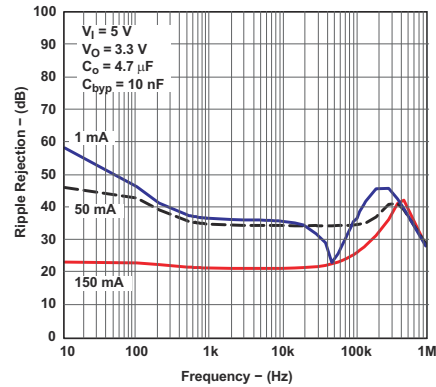

图 5-24. Ripple Rejection vs Frequency for Legacy Chip

### 5.6 Typical Characteristics (continued)

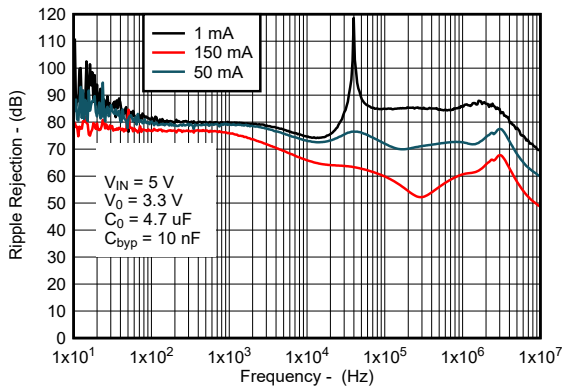
at operating temperature  $T_J = 25^\circ\text{C}$ ,  $V_{IN} = V_{OUT(NOM)} + 1.0\text{ V}$  or  $2.5\text{ V}$  (whichever is greater),  $I_{OUT} = 1\text{ mA}$ , ON/OFF pin tied to  $V_{IN}$ ,  $C_{IN} = 1.0\text{ }\mu\text{F}$ , and  $C_{OUT} = 4.7\text{ }\mu\text{F}$  (unless otherwise noted)

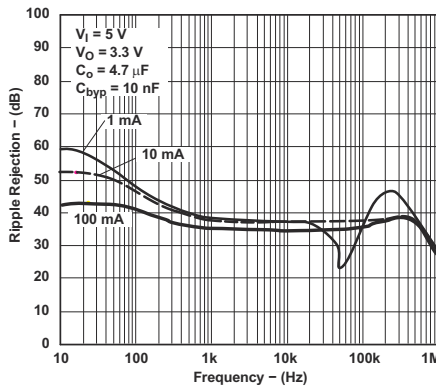

图 5-25. Ripple Rejection vs Frequency for New Chip



图 5-26. Output Impedance vs Frequency for Legacy Chip

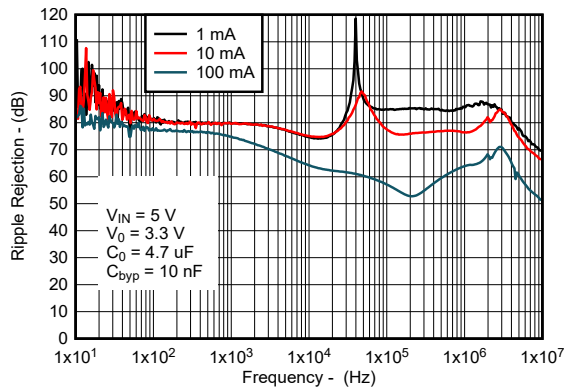

图 5-27. Output Impedance vs Frequency for Legacy Chip

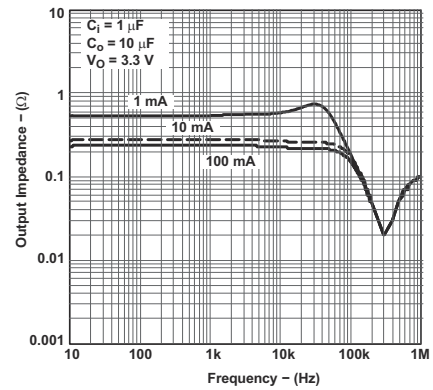

图 5-28. Output Noise Density vs Frequency for Legacy Chip

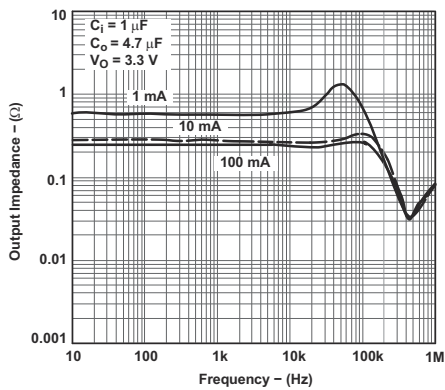

图 5-29. Output Noise Density vs Frequency for New Chip

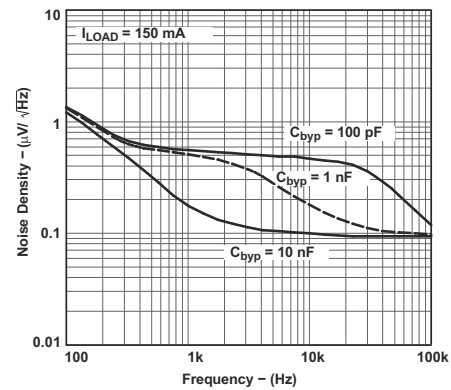

图 5-30. Output Noise Density vs Frequency for Legacy Chip

### 5.6 Typical Characteristics (continued)

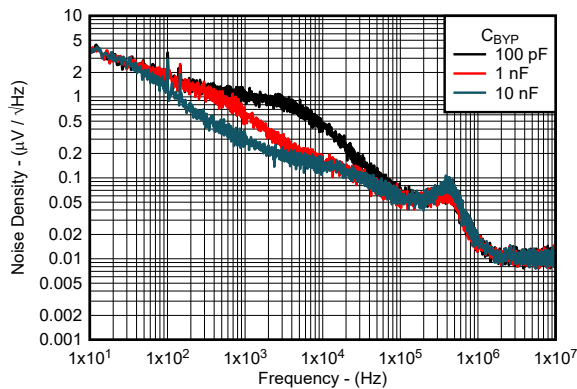
at operating temperature  $T_J = 25^\circ\text{C}$ ,  $V_{IN} = V_{OUT(NOM)} + 1.0\text{ V}$  or  $2.5\text{ V}$  (whichever is greater),  $I_{OUT} = 1\text{ mA}$ , ON/OFF pin tied to  $V_{IN}$ ,  $C_{IN} = 1.0\text{ }\mu\text{F}$ , and  $C_{OUT} = 4.7\text{ }\mu\text{F}$  (unless otherwise noted)

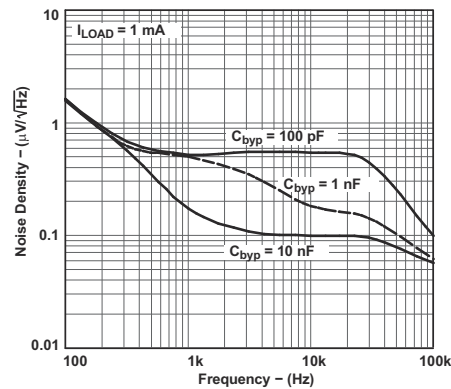

图 5-31. Output Noise Density vs Frequency for New Chip



图 5-32. Input Current vs Input Voltage for Legacy Chip

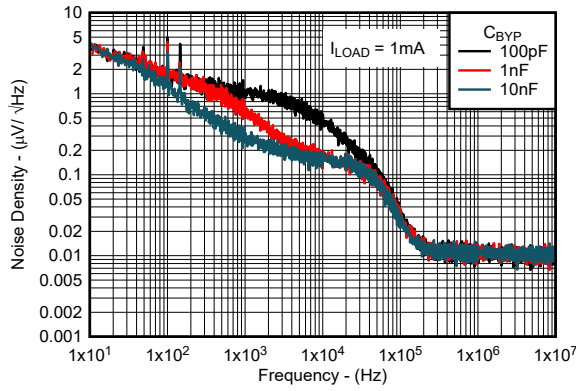

图 5-33. Input Current vs Input Voltage for New Chip

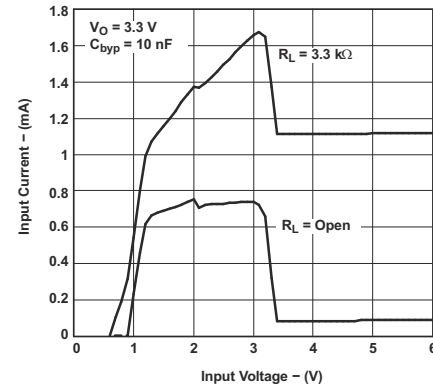

图 5-34. Ground-Pin Current vs Temperature for Legacy Chip

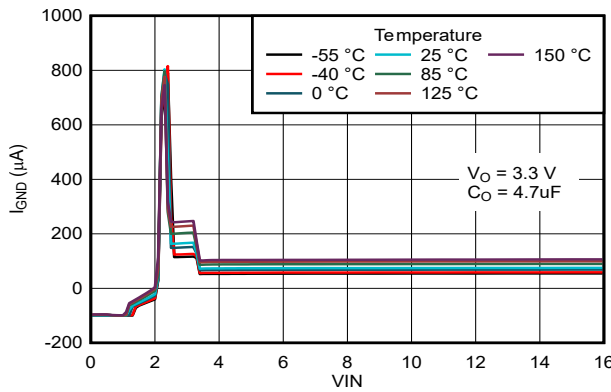

图 5-35. Ground-Pin Current vs Temperature for New Chip

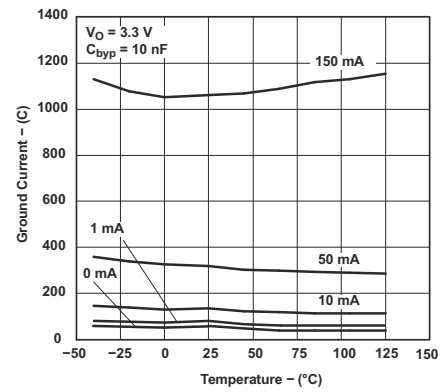

图 5-36. 2.2-µF Stable ESR Range for Output Voltage  $\leq 2.3\text{ V}$  for Legacy Chip

### 5.6 Typical Characteristics (continued)

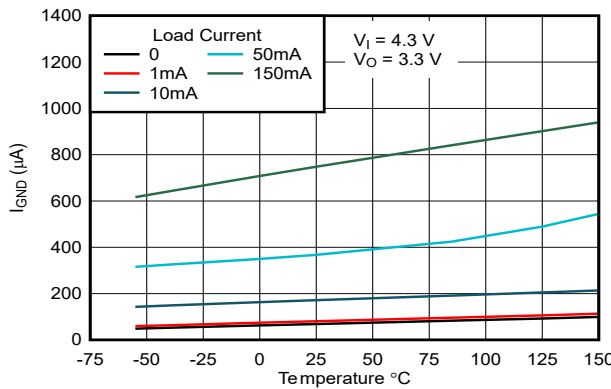
at operating temperature  $T_J = 25^\circ\text{C}$ ,  $V_{IN} = V_{OUT(NOM)} + 1.0\text{ V}$  or  $2.5\text{ V}$  (whichever is greater),  $I_{OUT} = 1\text{ mA}$ , ON/OFF pin tied to  $V_{IN}$ ,  $C_{IN} = 1.0\text{ }\mu\text{F}$ , and  $C_{OUT} = 4.7\text{ }\mu\text{F}$  (unless otherwise noted)

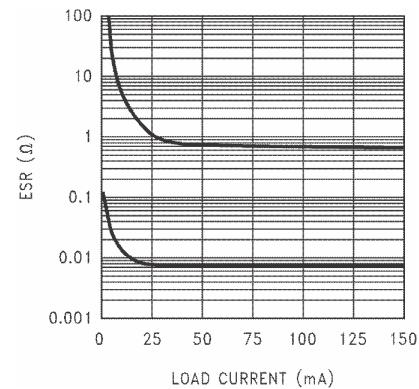

图 5-37. 4.7-  $\mu\text{F}$  Stable ESR Range for Output Voltage  $\leq 2.3\text{ V}$  for Legacy Chip



图 5-38. 2.2-  $\mu\text{F}$ , 3.3-  $\mu\text{F}$  Stable ESR Range for Output Voltage  $\geq 2.5\text{ V}$  for Legacy Chip

## 6 Detailed Description

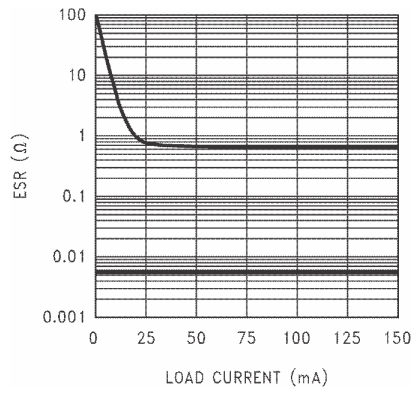
### 6.1 Overview

The LP2985 is a fixed-output, low-noise, high PSRR, low-dropout regulator that offers exceptional, cost-effective performance for both portable and nonportable applications. The LP2985 has an output tolerance of  $\pm 1\%$  across load, and temperature variation (for the new chip) and is capable of delivering 150mA of continuous load current.

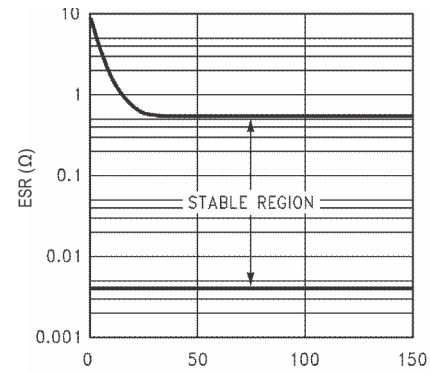
This device features integrated overcurrent protection, thermal shutdown, and output enable. The new chip version also features internal output pulldown and has a built-in soft-start mechanism for controlled inrush current. This device delivers excellent line and load transient performance. The operating ambient temperature range of the device is  $-40^{\circ}\text{C}$  to  $+125^{\circ}\text{C}$ .

### 6.2 Functional Block Diagrams



图 6-1. Functional Block Diagram (Legacy Chip)



图 6-2. Functional Block Diagram (New Chip)

## 6.3 Feature Description

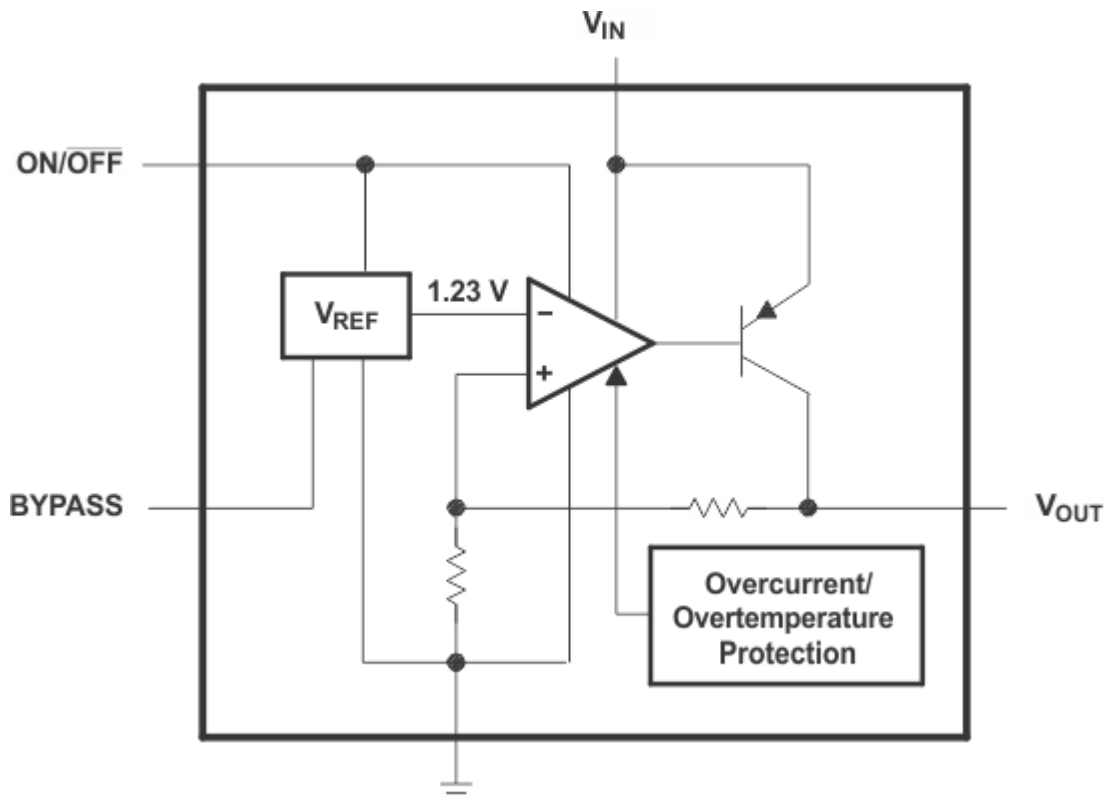
### 6.3.1 Output Enable

The ON/ $\overline{\text{OFF}}$  pin for the device is an active-high pin. The output voltage is enabled when the voltage of the ON/ $\overline{\text{OFF}}$  pin is greater than the high-level input voltage of the ON/ $\overline{\text{OFF}}$  pin and disabled with the ON/ $\overline{\text{OFF}}$  pin voltage is less than the low-level input voltage of the ON/ $\overline{\text{OFF}}$  pin. If independent control of the output voltage is not needed, connect the ON/ $\overline{\text{OFF}}$  pin to the input of the device.

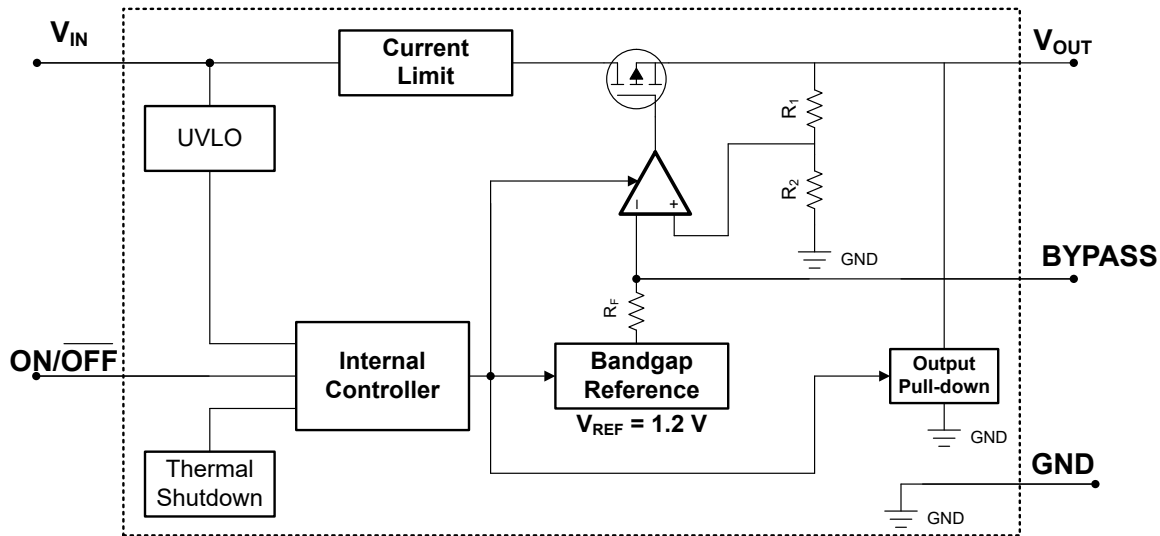
In the legacy chip, for proper operation of the ON/ $\overline{\text{OFF}}$  functionality, apply a signal with a slew rate of  $\geq 40\text{mV}/\mu\text{s}$ . No slew rate consideration is required for the new chip.

The new chip has an internal pulldown circuit that activates when the device is disabled. Pull the ON/ $\overline{\text{OFF}}$  pin voltage lower than the low-level input voltage of the ON/ $\overline{\text{OFF}}$  pin, to actively discharge the output voltage.

### 6.3.2 Dropout Voltage

Dropout voltage ( $V_{\text{DO}}$ ) is defined as the input voltage minus the output voltage ( $V_{\text{IN}} - V_{\text{OUT}}$ ) at the rated output current ( $I_{\text{RATED}}$ ), where the pass transistor is fully on.  $I_{\text{RATED}}$  is the maximum  $I_{\text{OUT}}$  listed in the [Recommended Operating Conditions](#) table. The pass transistor is in the ohmic or triode region of operation, and acts as a switch. The dropout voltage indirectly specifies a minimum input voltage greater than the nominal programmed output voltage at which the output voltage is expected to stay in regulation. If the input voltage falls to less than the nominal output regulation, then the output voltage falls as well.

For a CMOS regulator, the dropout voltage is determined by the drain-source on-state resistance ( $R_{DS(ON)}$ ) of the pass transistor. Therefore, if the linear regulator operates at less than the rated current, the dropout voltage for that current scales accordingly. The following equation calculates the  $R_{DS(ON)}$  of the device.

$$R_{DS(ON)} = \frac{V_{DO}}{I_{RATED}} \quad (1)$$

### 6.3.3 Current Limit

The device has an internal current limit circuit that protects the regulator during transient high-load current faults or shorting events. The current limit is a brick-wall scheme. In a high-load current fault, the brick-wall scheme limits the output current to the current limit ( $I_{CL}$ ).  $I_{CL}$  is listed in the [Electrical Characteristics](#) table.

The output voltage is not regulated when the device is in current limit. When a current limit event occurs, the device begins to heat up because of the increase in power dissipation. When the device is in brick-wall current limit, the pass transistor dissipates power  $[(V_{IN} - V_{OUT}) \times I_{CL}]$ . If thermal shutdown is triggered, the device turns off. After the device cools down, the internal thermal shutdown circuit turns the device back on. If the output current fault condition continues, the device cycles between current limit and thermal shutdown. For more information on current limits, see the [Know Your Limits application note](#).

图 6-3 shows a diagram of the current limit.



图 6-3. Current Limit

### 6.3.4 Undervoltage Lockout (UVLO)

The new chip has an independent undervoltage lockout (UVLO) circuit that monitors the input voltage, allowing a controlled and consistent turn on and off of the output voltage. To prevent the device from turning off if the input drops during turn on, the UVLO has hysteresis as specified in the [Electrical Characteristics](#) table.

### 6.3.5 Output Pulldown

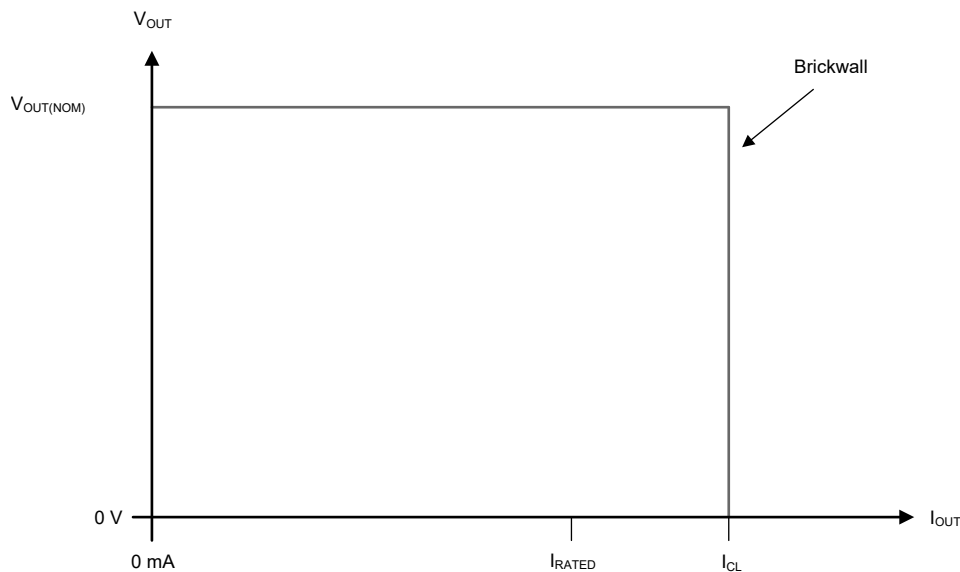
The new chip has an output pulldown circuit. The output pulldown activates in the following conditions:

- When the device is disabled ( $V_{ON/OFF} < V_{ON/OFF(LOW)}$ )
- If  $1.0\text{ V} < V_{IN} < V_{UVLO}$

Do not rely on the output pulldown circuit for discharging a large amount of output capacitance after the input supply has collapsed because reverse current can flow from the output to the input. This reverse current flow can cause damage to the device. See the [Reverse Current](#) section for more details.

### 6.3.6 Thermal Shutdown

The device contains a thermal shutdown protection circuit to disable the device when the junction temperature ( $T_J$ ) of the pass transistor rises to  $T_{SD(shutdown)}$  (typical). Thermal shutdown hysteresis assures that the device resets (turns on) when the temperature falls to  $T_{SD(reset)}$  (typical).

The thermal time-constant of the semiconductor die is fairly short, thus the device can cycle on and off when thermal shutdown is reached until power dissipation is reduced. Power dissipation during start up can be high from large  $V_{IN} - V_{OUT}$  voltage drops across the device or from high inrush currents charging large output capacitors. Under some conditions, the thermal shutdown protection disables the device before start up completes.

For reliable operation, limit the junction temperature to the maximum listed in the [Recommended Operating Conditions](#) table. Operation above this maximum temperature causes the device to exceed operational specifications. Although the internal protection circuitry of the device is designed to protect against thermal overall conditions, this circuitry is not intended to replace proper heat sinking. Continuously running the device into thermal shutdown or above the maximum recommended junction temperature reduces long-term reliability.

## 6.4 Device Functional Modes

### 6.4.1 Device Functional Mode Comparison

表 6-1 shows the conditions that lead to the different modes of operation. See the [Electrical Characteristics](#) table for parameter values.

表 6-1. Device Functional Mode Comparison

OPERATING MODE	PARAMETER			
	$V_{IN}$	$V_{ON/OFF}$	$I_{OUT}$	$T_J$
Normal operation	$V_{IN} > V_{OUT(nom)} + V_{DO}$ and $V_{IN} > V_{IN(min)}$	$V_{ON/OFF} > V_{ON/OFF(HI)}$	$I_{OUT} < I_{OUT(max)}$	$T_J < T_{SD(shutdown)}$
Dropout operation	$V_{IN(min)} < V_{IN} < V_{OUT(nom)} + V_{DO}$	$V_{ON/OFF} > V_{ON/OFF(HI)}$	$I_{OUT} < I_{OUT(max)}$	$T_J < T_{SD(shutdown)}$
Disabled (any true condition disables the device)	$V_{IN} < V_{UVLO}$	$V_{ON/OFF} < V_{ON/OFF(LOW)}$	Not applicable	$T_J > T_{SD(shutdown)}$

### 6.4.2 Normal Operation

The device regulates to the nominal output voltage when the following conditions are met:

- The input voltage is greater than the nominal output voltage plus the dropout voltage ( $V_{OUT(nom)} + V_{DO}$ )
- The output current is less than the current limit ( $I_{OUT} < I_{CL}$ )
- The device junction temperature is less than the thermal shutdown temperature ( $T_J < T_{SD}$ )
- The ON/OFF voltage has previously exceeded the ON/OFF rising threshold voltage and has not yet decreased to less than the enable falling threshold

### 6.4.3 Dropout Operation

If the input voltage is lower than the nominal output voltage plus the specified dropout voltage, but all other conditions are met for normal operation, the device operates in dropout mode. In this mode, the output voltage tracks the input voltage. During this mode, the transient performance of the device becomes significantly degraded because the pass transistor is in the ohmic or triode region, and acts as a switch. Line or load transients in dropout can result in large output-voltage deviations.

When the device is in a steady dropout state (defined as when the device is in dropout,  $V_{IN} < V_{OUT(NOM)} + V_{DO}$ , directly after being in a normal regulation state, but *not* during start up), the pass transistor is driven into the ohmic or triode region. When the input voltage returns to a value greater than or equal to the nominal output voltage plus the dropout voltage ( $V_{OUT(NOM)} + V_{DO}$ ), the output voltage can overshoot for a short period of time while the device pulls the pass transistor back into the linear region.

### 6.4.4 Disabled

The output of the device can be shutdown by forcing the voltage of the ON/OFF pin to less than the maximum ON/OFF pin low-level input voltage (see the [Electrical Characteristics](#) table). When disabled, the pass transistor is turned off, internal circuits are shutdown, and the output voltage is actively discharged to ground by an internal discharge circuit from the output to ground.

## 7 Application and Implementation

### 备注

以下应用部分中的信息不属于 TI 器件规格的范围，TI 不担保其准确性和完整性。TI 的客户应负责确定器件是否适用于其应用。客户应验证并测试其设计，以确保系统功能。

### 7.1 Application Information

#### 7.1.1 Recommended Capacitor Types

##### 7.1.1.1 Recommended Capacitors (Legacy Chip)

Preferably, use ceramic capacitors on the output of the LP2985 for several reasons. For capacitances ranging from 2.2  $\mu\text{F}$  to 4.7  $\mu\text{F}$ , ceramic capacitors have the lowest cost and lowest ESR, making these components choice candidates for filtering high-frequency noise. For instance, a typical 2.2  $\mu\text{F}$  ceramic capacitor has an ESR ranging from 10m $\Omega$  to 20m $\Omega$ , which satisfies the minimum ESR requirements of the regulator. Ceramic capacitors have one major disadvantage to be taken into account: a poor temperature coefficient, where the capacitance varies significantly with temperature. For instance, a large-value ceramic capacitor ( $\geq 2.2 \mu\text{F}$ ) potentially loses more than half of the capacitance as the temperature rises from 25°C to 85°C. Thus, a 2.2  $\mu\text{F}$  capacitor at 25°C drops well below the minimum  $C_{\text{OUT}}$  required for stability, as ambient temperature rises. For this reason, select an output capacitor that maintains the minimum 2.2  $\mu\text{F}$  required for stability over the entire operating temperature range. There are some ceramic capacitors that maintain a  $\pm 15\%$  capacitance tolerance over temperature.

Tantalum capacitors are able to be used at the output of the LP2985, but there are significant disadvantages prohibiting this usage:

- In the 1  $\mu\text{F}$  to 4.7  $\mu\text{F}$  range, tantalum capacitors are more expensive than ceramics of the equivalent capacitance and voltage ratings.
- Tantalum capacitors have higher ESR values than equivalent-sized ceramic counterparts. Thus, to meet the ESR requirements, a higher-capacitance tantalum is required, at the expense of larger size and higher cost.
- The ESR of a tantalum capacitor increases as temperature drops, as much as double from +25°C to -40°C. Thus, maintain ESR margins over the temperature range to prevent regulator instability.

##### 7.1.1.2 Recommended Capacitors (New Chip)

The new chip is designed to be stable using low equivalent series resistance (ESR) ceramic capacitors at the input and output. Multilayer ceramic capacitors have become the industry standard for these types of applications and are recommended, but use good judgment. Ceramic capacitors that employ X7R-, X5R-, and COG-rated dielectric materials provide relatively good capacitive stability across temperature. Using Y5V-rated capacitors is discouraged because of large variations in capacitance.

Maximum supported ESR range across complete temperature (-40°C to +125°C) and load current range (0mA–150mA) is less than 1  $\Omega$ . For existing implementations, where different capacitor types with higher ESR values are used, use a low ESR, 100nF MLCC capacitor. Place this capacitor as close as possible to the device output ( $V_{\text{OUT}}$ ) pin.

Regardless of the ceramic capacitor type selected, the effective capacitance varies with operating voltage and temperature. Generally, expect the effective capacitance to decrease by as much as 50%. The input and output capacitors listed in the [Recommended Operating Conditions](#) table account for an effective capacitance of approximately 50% of the nominal value.

#### 7.1.2 Input and Output Capacitor Requirements

##### 7.1.2.1 Input Capacitor Requirements

For the legacy chip, a minimum value of 1  $\mu\text{F}$  (over the entire operating temperature range) is required at the input of the LP2985. In addition, place this input capacitor within 1cm of the input pin, connected to a clean

analog ground. There are no equivalent series resistance (ESR) requirements for this capacitor; increase capacitance without limit.

For the new chip, although an input capacitor is not required for stability, good analog design practice is to connect a capacitor from IN to GND. This capacitor counteracts reactive input sources and improves transient response, input ripple, and PSRR. Use an input capacitor if the source impedance is more than  $0.5\ \Omega$ . Use a higher value capacitor if large, fast rise-time load or line transients are anticipated. Use this capacitor if the device is located several inches from the input power source.

#### 7.1.2.2 Output Capacitor Requirements

For the legacy chip, the LP2985 permits using low ESR capacitors at the output, including ceramic capacitors that have an ESR as low as  $5\text{m}\Omega$ . Tantalum and film capacitors are also available if size and cost are not issues. Place the output capacitor within 1cm of the output pin. Make sure this capacitor returns to a clean analog ground. As with other PNP LDOs, stability conditions require the output capacitor to have a minimum capacitance and an ESR that falls within a certain range.

- Minimum  $C_{OUT}$ :  $2.2\ \mu\text{F}$  (increase this capacitance without limit to improve transient response stability margin)
- ESR range: see [图 5-36](#) through [图 5-38](#)

Both the minimum capacitance and ESR requirement are critical to be met over the entire operating temperature range. Depending on the type of capacitors used, both these parameters potentially vary significantly with temperature (see the [Recommended Capacitors \(Legacy Chip\)](#) section).

For the new chip, dynamic performance of the device is improved with the use of an output capacitor. Use an output capacitor within the range specified in the [Recommended Operating Conditions](#) table for stability. Review the [Recommended Capacitors \(New Chip\)](#) section for further information on supported output capacitors.

#### 7.1.3 Noise Bypass Capacitor ( $C_{BYPASS}$ )

The LP2985 allows for low-noise performance with the use of a bypass capacitor that is connected to the internal band-gap reference with the BYPASS pin. This high-impedance band-gap circuitry is biased in the microampere range and, thus, cannot be loaded significantly, otherwise, the output (and, correspondingly, the output of the regulator) changes. Thus, for best output accuracy, dc leakage current through  $C_{BYPASS}$  must be minimized as much as possible and must never exceed  $100\ \text{nA}$ . The  $C_{BYPASS}$  capacitor also impacts the start-up behavior of the regulator. Inrush current and start-up time increase with larger bypass capacitor values.

Use a 10-nF capacitor for  $C_{BYPASS}$ . Ceramic and film capacitors are good choices for this purpose.

#### 7.1.4 Reverse Current

Excessive reverse current can damage this device. Reverse current flows through the intrinsic body diode of the pass transistor instead of the normal conducting channel. At high magnitudes, this current flow degrades the long-term reliability of the device.

Conditions where reverse current can occur are outlined in this section, all of which can exceed the absolute maximum rating of  $V_{OUT} \leq V_{IN} + 0.3\ \text{V}$ .

- If the device has a large  $C_{OUT}$  and the input supply collapses with little or no load current
- The output is biased when the input supply is not established
- The output is biased above the input supply

If reverse current flow is expected in the application, use external protection to protect the device. Reverse current is not limited in the device, so external limiting is required if extended reverse voltage operation is anticipated.

[图 7-1](#) shows one approach for protecting the device.



图 7-1. Example Circuit for Reverse Current Protection Using a Schottky Diode

### 7.1.5 Power Dissipation ( $P_D$ )

Circuit reliability requires consideration of the device power dissipation, location of the circuit on the printed circuit board (PCB), and correct sizing of the thermal plane. The PCB area around the regulator must have few or no other heat-generating devices that cause added thermal stress.

To first-order approximation, power dissipation in the regulator depends on the input-to-output voltage difference and load conditions. The following equation calculates power dissipation ( $P_D$ ).

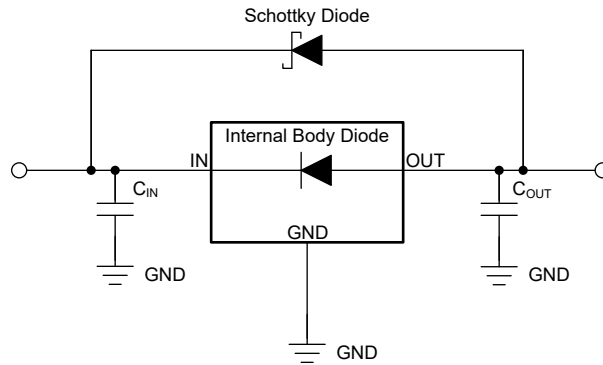
$$P_D = (V_{IN} - V_{OUT}) \times I_{OUT} \quad (2)$$

#### 备注

Power dissipation can be minimized, and therefore greater efficiency can be achieved, by correct selection of the system voltage rails. For the lowest power dissipation use the minimum input voltage required for correct output regulation.

For devices with a thermal pad, the primary heat conduction path for the device package is through the thermal pad to the PCB. Solder the thermal pad to a copper pad area under the device. This pad area must contain an array of plated vias that conduct heat to additional copper planes for increased heat dissipation.

The maximum power dissipation determines the maximum allowable ambient temperature ( $T_A$ ) for the device. According to the following equation, power dissipation and junction temperature are most often related by the junction-to-ambient thermal resistance ( $R_{\theta JA}$ ) of the combined PCB and device package and the temperature of the ambient air ( $T_A$ ).

$$T_J = T_A + (R_{\theta JA} \times P_D) \quad (3)$$

Thermal resistance ( $R_{\theta JA}$ ) is highly dependent on the heat-spreading capability built into the particular PCB design, and therefore varies according to the total copper area, copper weight, and location of the planes. The junction-to-ambient thermal resistance listed in the [Thermal Information](#) table is determined by the JEDEC standard PCB and copper-spreading area, and is used as a relative measure of package thermal performance.

### 7.1.6 Estimating Junction Temperature

The JEDEC standard now recommends the use of psi ( $\Psi$ ) thermal metrics to estimate the junction temperatures of the linear regulator when in-circuit on a typical PCB board application. These metrics are not thermal resistance parameters and instead offer a practical and relative way to estimate junction temperature. These psi metrics are determined to be significantly independent of the copper area available for heat-spreading. The [Thermal Information](#) table lists the primary thermal metrics, which are the junction-to-top characterization parameter ( $\Psi_{JT}$ ) and junction-to-board characterization parameter ( $\Psi_{JB}$ ). These parameters provide two methods for calculating the junction temperature ( $T_J$ ), as described in the following equations. Use the junction-to-top characterization parameter ( $\Psi_{JT}$ ) with the temperature at the center-top of device package ( $T_T$ ) to

calculate the junction temperature. Use the junction-to-board characterization parameter ( $\psi_{JB}$ ) with the PCB surface temperature 1 mm from the device package ( $T_B$ ) to calculate the junction temperature.

$$T_J = T_T + \psi_{JT} \times P_D \quad (4)$$

where:

- $P_D$  is the dissipated power
- $T_T$  is the temperature at the center-top of the device package

$$T_J = T_B + \psi_{JB} \times P_D \quad (5)$$

where:

- $T_B$  is the PCB surface temperature measured 1 mm from the device package and centered on the package edge

For detailed information on the thermal metrics and how to use them, see the [Semiconductor and IC Package Thermal Metrics application note](#).

## 7.2 Typical Application

图 7-2 shows the standard usage of the LP2985 as a low-dropout regulator.



图 7-2. LP2985 Typical Application

### 7.2.1 Design Requirements

Minimum  $C_{OUT}$  value for stability (can be increased without limit for improved stability and transient response)

$ON/\overline{OFF}$  must be actively terminated. Connect to  $V_{IN}$  if shutdown feature is not used.

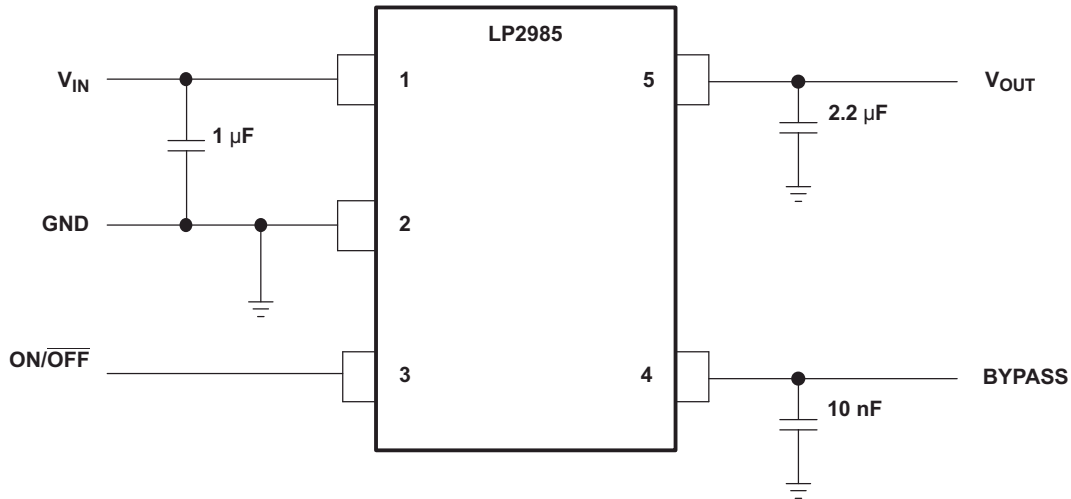
Optional BYPASS capacitor for low-noise operation.

### 7.2.2 Detailed Design Procedure

#### 7.2.2.1 $ON/\overline{OFF}$ Operation

The LP2985 allows for a shutdown mode via the  $ON/\overline{OFF}$  pin. Driving the pin LOW ( $\leq 0.4$  V) turns the device OFF; conversely, a HIGH ( $\geq 1.2$  V) turns the device ON. If the shutdown feature is not used, connect  $ON/\overline{OFF}$  to the input to ensure that the regulator is on at all times. For proper operation, do not leave  $ON/\overline{OFF}$  unconnected.

### 7.2.3 Application Curves

at operating temperature  $T_J = 25^\circ\text{C}$ ,  $V_{IN} = V_{OUT(NOM)} + 1.0\text{ V}$  or  $2.5\text{ V}$  (whichever is greater),  $I_{OUT} = 1\text{ mA}$ , ON/OFF pin tied to  $V_{IN}$ ,  $C_{IN} = 1.0\text{ }\mu\text{F}$ , and  $C_{OUT} = 4.7\text{ }\mu\text{F}$  (unless otherwise noted)



图 7-3. Load Transient Response for Legacy Chip



图 7-4. Load Transient Response for New Chip

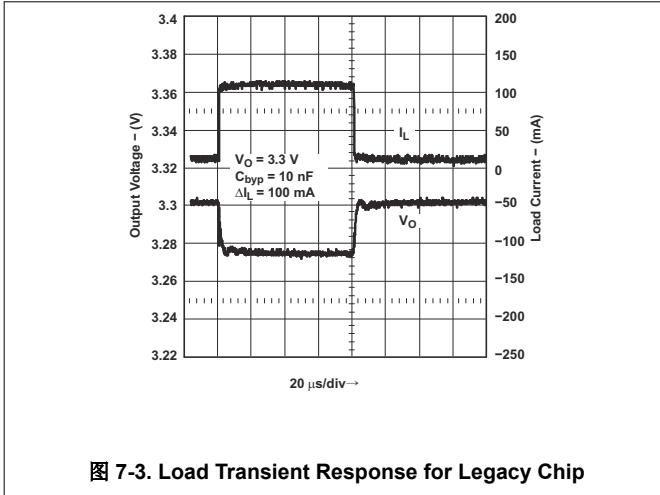

图 7-5. Load Transient Response for Legacy Chip

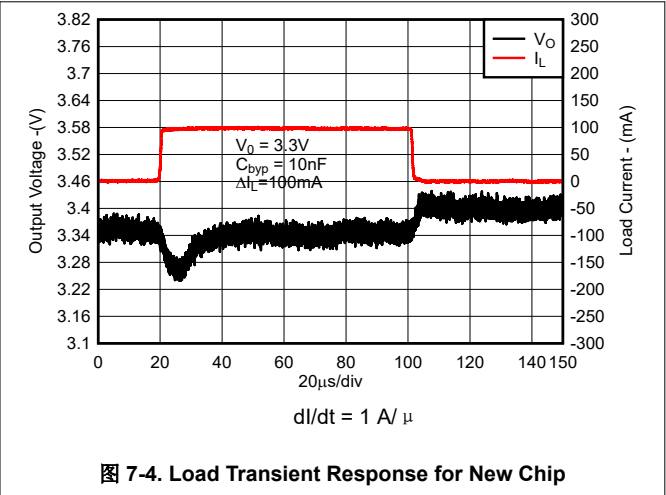

图 7-6. Load Transient for New Chip

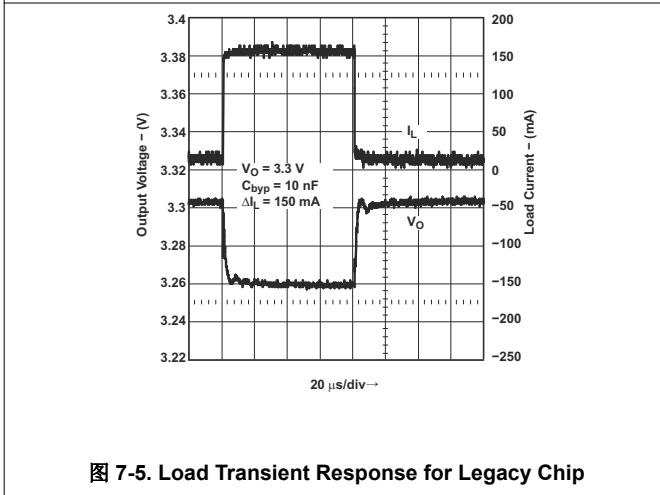

图 7-7. Load Transient Response for Legacy Chip

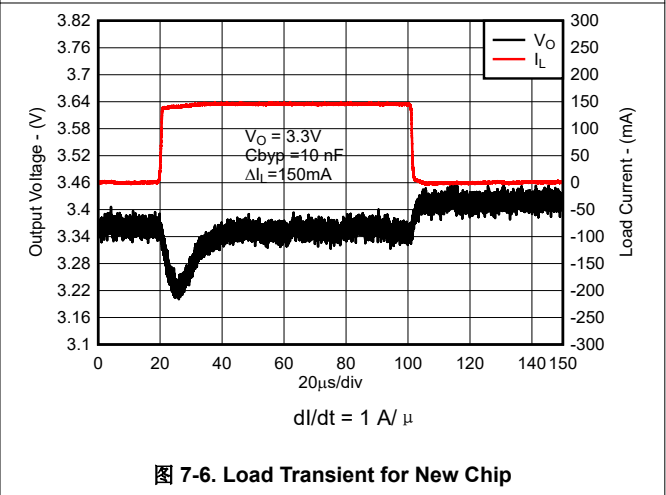

图 7-8. Load Transient Response for New Chip

### 7.2.3 Application Curves (continued)

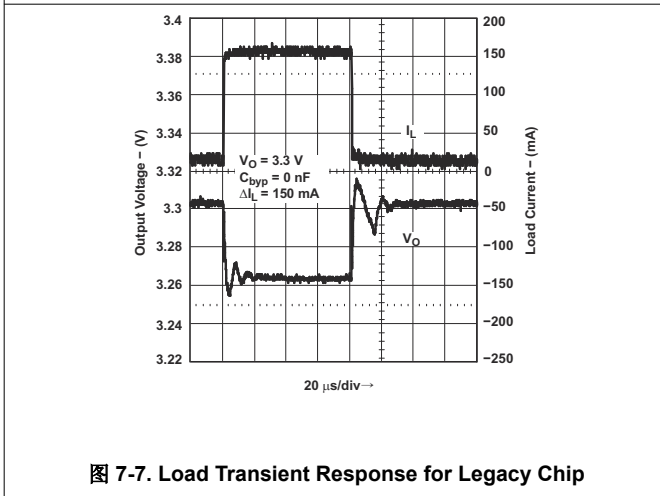
at operating temperature  $T_J = 25^\circ\text{C}$ ,  $V_{IN} = V_{OUT(NOM)} + 1.0\text{ V}$  or  $2.5\text{ V}$  (whichever is greater),  $I_{OUT} = 1\text{ mA}$ , ON/OFF pin tied to  $V_{IN}$ ,  $C_{IN} = 1.0\text{ }\mu\text{F}$ , and  $C_{OUT} = 4.7\text{ }\mu\text{F}$  (unless otherwise noted)

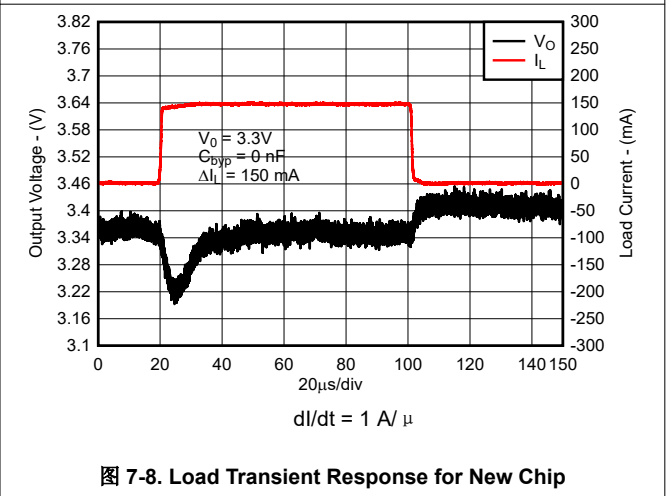

图 7-9. Line Transient Response for Legacy Chip



图 7-10. Line Transient Response for New Chip

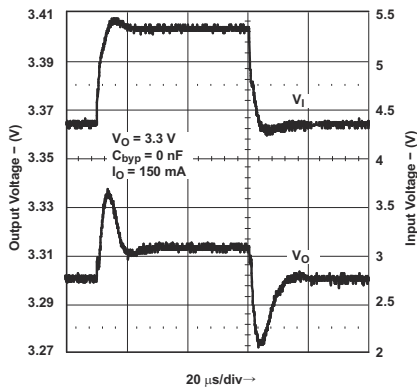

图 7-11. Line Transient Response for Legacy Chip

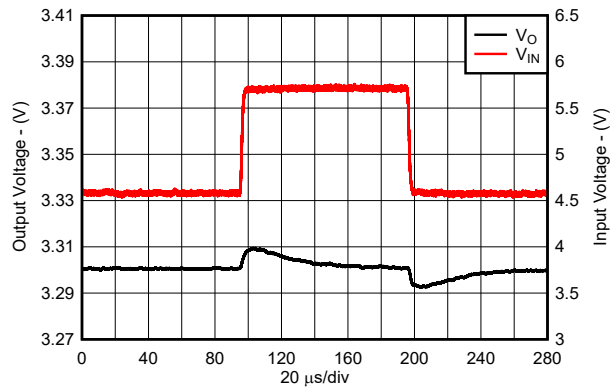

图 7-12. Line Transient Response for New Chip

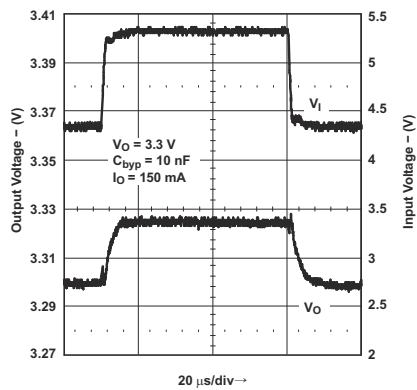

图 7-13. Line Transient Response for Legacy Chip

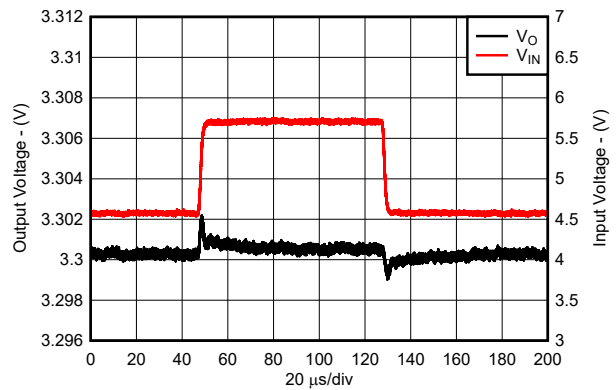

图 7-14. Line Transient Response for New Chip

### 7.2.3 Application Curves (continued)

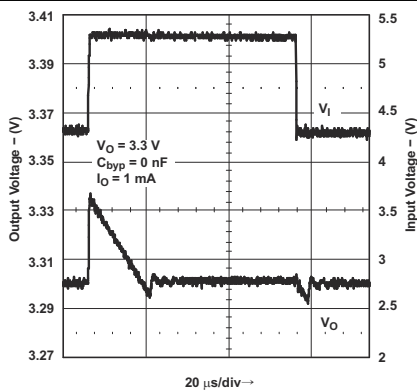
at operating temperature  $T_J = 25^\circ\text{C}$ ,  $V_{IN} = V_{OUT(NOM)} + 1.0\text{ V}$  or  $2.5\text{ V}$  (whichever is greater),  $I_{OUT} = 1\text{ mA}$ ,  $ON/\overline{OFF}$  pin tied to  $V_{IN}$ ,  $C_{IN} = 1.0\text{ }\mu\text{F}$ , and  $C_{OUT} = 4.7\text{ }\mu\text{F}$  (unless otherwise noted)

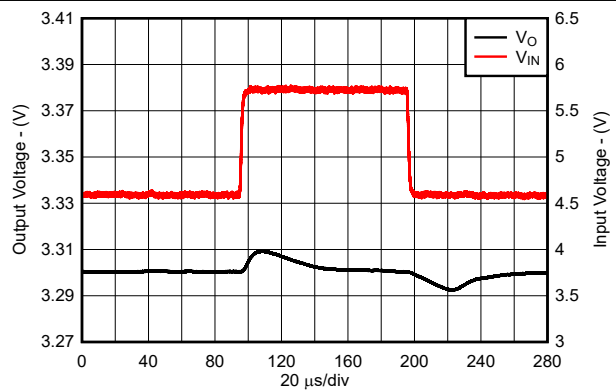

图 7-15. Line Transient Response for Legacy Chip



图 7-16. Line Transient Response for New Chip

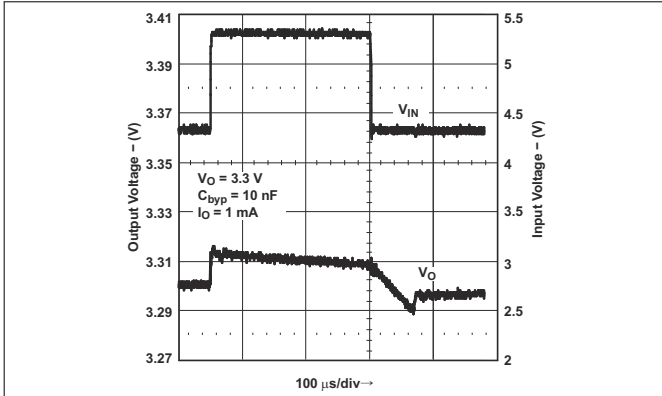

图 7-17. Turn-On Time for Legacy Chip

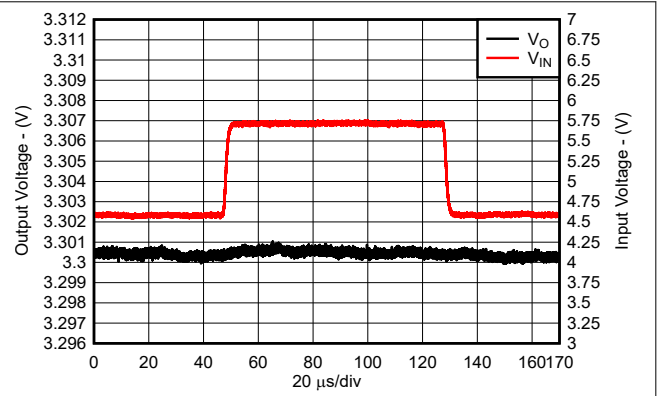

图 7-18. Turn-On Time for New Chip

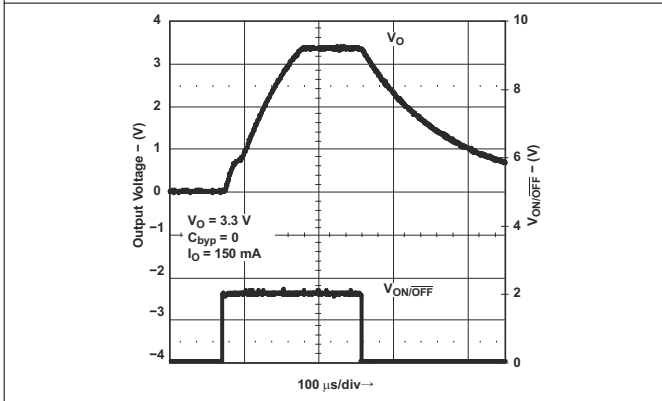

图 7-19. Turn-On Time for Legacy Chip

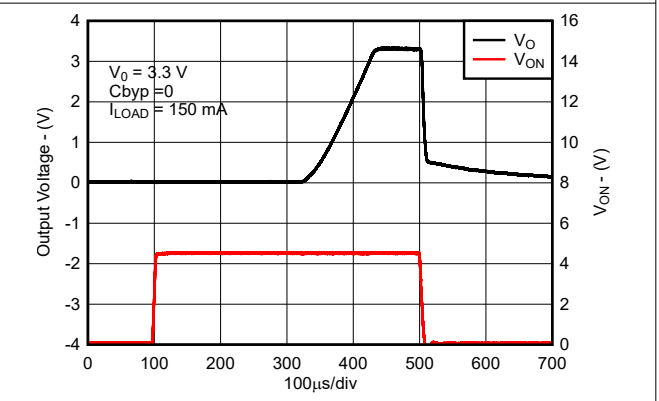

图 7-20. Turn-On Time for New Chip

### 7.2.3 Application Curves (continued)

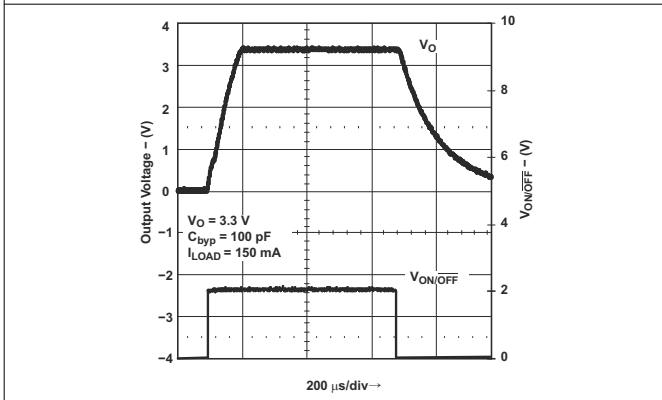
at operating temperature  $T_J = 25^\circ\text{C}$ ,  $V_{IN} = V_{OUT(NOM)} + 1.0\text{ V}$  or  $2.5\text{ V}$  (whichever is greater),  $I_{OUT} = 1\text{ mA}$ ,  $ON/\overline{OFF}$  pin tied to  $V_{IN}$ ,  $C_{IN} = 1.0\text{ }\mu\text{F}$ , and  $C_{OUT} = 4.7\text{ }\mu\text{F}$  (unless otherwise noted)

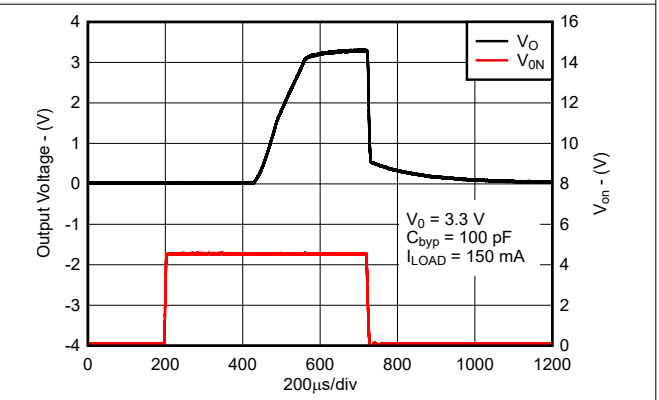

图 7-21. Turn-On Time for Legacy Chip



图 7-22. Turn-On Time for New Chip

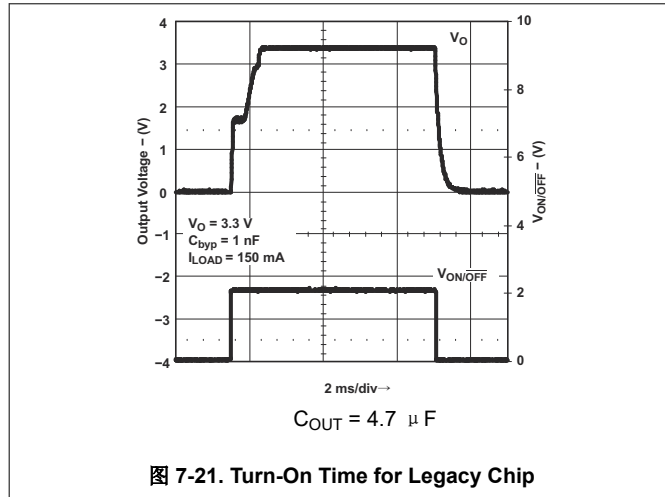

图 7-23. Turn-On Time

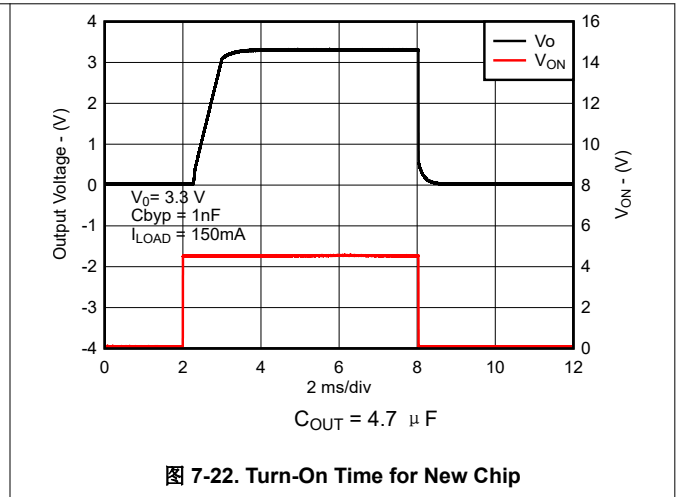

图 7-24. Turn-On Time for New Chip

### 7.3 Power Supply Recommendations

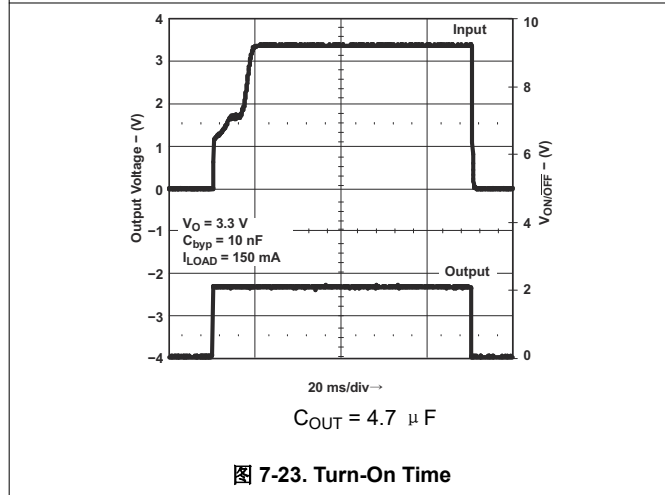
A power supply can be used at the input voltage within the ranges given in the [Recommended Operating Conditions](#) table. Use bypass capacitors as described in the [Layout Guidelines](#) section.

### 7.4 Layout

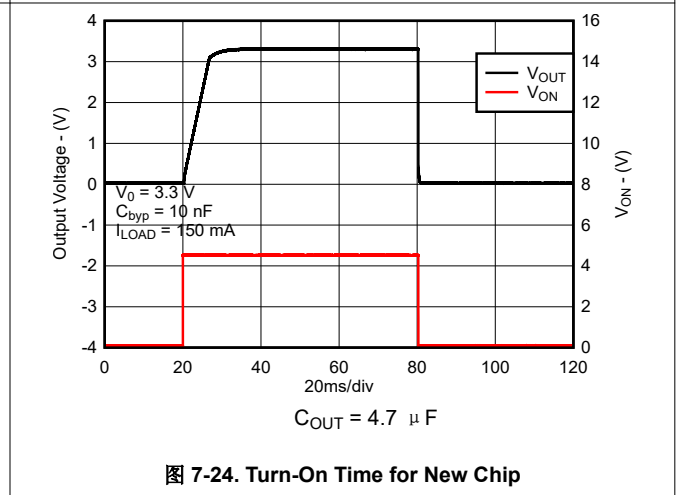
#### 7.4.1 Layout Guidelines

- Bypass the input pin to ground with a bypass capacitor.
- The optimum placement of the bypass capacitor is closest to the  $V_{IN}$  of the device and GND of the system. Care must be taken to minimize the loop area formed by the bypass capacitor connection, the  $V_{IN}$  pin, and the GND pin of the system.
- For operation at full-rated load, use wide trace lengths to eliminate IR drop and heat dissipation.

#### 7.4.2 Layout Example



图 7-25. Layout Diagram

## 8 Device and Documentation Support

### 8.1 Device Support

#### 8.1.1 Device Nomenclature

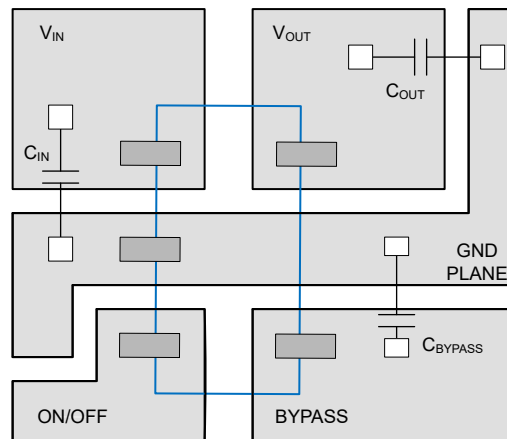
表 8-1. Available Options

PRODUCT <sup>(1)</sup>	DESCRIPTION
LP2985c-xyyyz <b>M3</b>	c is the accuracy specification for the legacy chip (A or blank). See the <a href="#">Electrical Characteristics</a> table for more information. This character is insignificant for the new chip. <b>xx</b> is the nominal output voltage (for example, 33 = 3.3V; 50 = 5.0V). <b>yyy</b> is the package designator (DBV = SOT-23). <b>z</b> is the reel designator size. See the Package Addendum for more information on package quantity. This device ships with the legacy chip (CSO: DLN or GF8) or the new chip (CSO: RFB), which uses the latest manufacturing flow. The reel packaging label provides CSO information to distinguish which chip is used. Device performance for new and legacy chips is denoted throughout the document. <b>M3</b> is a suffix designator only significant for the new chip with CSO:RFB, which uses the latest manufacturing flow.

(1) For the most current package and ordering information, see the Package Option Addendum at the end of this document, or visit the device product folder at [www.ti.com](http://www.ti.com).

### 8.2 接收文档更新通知

要接收文档更新通知，请导航至 [ti.com](http://ti.com) 上的器件产品文件夹。点击 [通知](#) 进行注册，即可每周接收产品信息更改摘要。有关更改的详细信息，请查看任何已修订文档中包含的修订历史记录。

### 8.3 支持资源

[TI E2E™ 中文支持论坛](#) 是工程师的重要参考资料，可直接从专家处获得快速、经过验证的解答和设计帮助。搜索现有解答或提出自己的问题，获得所需的快速设计帮助。

链接的内容由各个贡献者“按原样”提供。这些内容并不构成 TI 技术规范，并且不一定反映 TI 的观点；请参阅 TI 的 [使用条款](#)。

### 8.4 Trademarks

TI E2E™ is a trademark of Texas Instruments.

所有商标均为其各自所有者的财产。

### 8.5 静电放电警告



静电放电 (ESD) 会损坏这个集成电路。德州仪器 (TI) 建议通过适当的预防措施处理所有集成电路。如果不遵守正确的处理和安装程序，可能会损坏集成电路。

ESD 的损坏小至导致微小的性能降级，大至整个器件故障。精密的集成电路可能更容易受到损坏，这是因为非常细微的参数更改都可能会导致器件与其发布的规格不相符。

### 8.6 术语表

[TI 术语表](#) 本术语表列出并解释了术语、首字母缩略词和定义。

## 9 Revision History

注：以前版本的页码可能与当前版本的页码不同

<b>Changes from Revision R (July 2023) to Revision S (May 2025)</b>	<b>Page</b>
• 通篇添加了区分新芯片和旧芯片信息的命名规则.....	1
• Changed <i>Overview</i> section: changed 1% to $\pm 1\%$ , deleted line variation, and clarified new chip features.....	15
• Added <i>Functional Block Diagram (Legacy Chip)</i> figure.....	15
• Changed <i>Output Enable</i> section to identify differences between new and legacy chip functionality.....	16
• Changed <i>Recommended Capacitor Types</i> section and added subsections.....	20
• Changed <i>Input and Output Capacitor Requirements</i> section.....	20
• Changed <i>Device Nomenclature</i> section.....	30

## 10 Mechanical, Packaging, and Orderable Information

The following pages include mechanical, packaging, and orderable information. This information is the most current data available for the designated devices. This data is subject to change without notice and revision of this document. For browser-based versions of this data sheet, refer to the left-hand navigation.

**PACKAGING INFORMATION**

Orderable part number	Status (1)	Material type (2)	Package   Pins	Package qty   Carrier	RoHS (3)	Lead finish/ Ball material (4)	MSL rating/ Peak reflow (5)	Op temp (°C)	Part marking (6)
<a href="#">LP2985-10DBVR</a>	Active	Production	SOT-23 (DBV)   5	3000   LARGE T&R	Yes	NIPDAU	Level-1-260C-UNLIM	-40 to 125	LRCG
LP2985-10DBVR.A	Active	Production	SOT-23 (DBV)   5	3000   LARGE T&R	Yes	NIPDAU	Level-1-260C-UNLIM	-40 to 125	LRCG
<a href="#">LP2985-10DBVT</a>	Active	Production	SOT-23 (DBV)   5	250   SMALL T&R	Yes	NIPDAU	Level-1-260C-UNLIM	-40 to 125	LRCG
LP2985-10DBVT.A	Active	Production	SOT-23 (DBV)   5	250   SMALL T&R	Yes	NIPDAU	Level-1-260C-UNLIM	-40 to 125	LRCG
<a href="#">LP2985-18DBVR</a>	Active	Production	SOT-23 (DBV)   5	3000   LARGE T&R	Yes	SN	Level-1-260C-UNLIM	-40 to 125	(LPHG, LPHL)
LP2985-18DBVR.A	Active	Production	SOT-23 (DBV)   5	3000   LARGE T&R	Yes	SN	Level-1-260C-UNLIM	-40 to 125	(LPHG, LPHL)
LP2985-18DBVRE4	Active	Production	SOT-23 (DBV)   5	3000   LARGE T&R	Yes	NIPDAU	Level-1-260C-UNLIM	-40 to 125	LPHG
<a href="#">LP2985-18DBVRG4</a>	Active	Production	SOT-23 (DBV)   5	3000   LARGE T&R	Yes	NIPDAU	Level-1-260C-UNLIM	-40 to 125	LPHG
LP2985-18DBVRG4.A	Active	Production	SOT-23 (DBV)   5	3000   LARGE T&R	Yes	NIPDAU	Level-1-260C-UNLIM	-40 to 125	LPHG
<a href="#">LP2985-18DBVRM3</a>	Active	Production	SOT-23 (DBV)   5	3000   LARGE T&R	Yes	SN	Level-1-260C-UNLIM	-40 to 125	LPHG
LP2985-18DBVRM3.A	Active	Production	SOT-23 (DBV)   5	3000   LARGE T&R	Yes	SN	Level-1-260C-UNLIM	-40 to 125	LPHG
<a href="#">LP2985-18DBVT</a>	Obsolete	Production	SOT-23 (DBV)   5	-	-	Call TI	Call TI	-40 to 125	(LPHG, LPHL)
<a href="#">LP2985-18DBVTG4</a>	Active	Production	SOT-23 (DBV)   5	250   SMALL T&R	Yes	NIPDAU	Level-1-260C-UNLIM	-40 to 125	LPHG
LP2985-18DBVTG4.A	Active	Production	SOT-23 (DBV)   5	250   SMALL T&R	Yes	NIPDAU	Level-1-260C-UNLIM	-40 to 125	LPHG
<a href="#">LP2985-25DBVR</a>	Active	Production	SOT-23 (DBV)   5	3000   LARGE T&R	Yes	NIPDAU   SN	Level-1-260C-UNLIM	-40 to 125	(LPLG, LPLL)
LP2985-25DBVR.A	Active	Production	SOT-23 (DBV)   5	3000   LARGE T&R	Yes	SN	Level-1-260C-UNLIM	-40 to 125	(LPLG, LPLL)
<a href="#">LP2985-25DBVT</a>	Active	Production	SOT-23 (DBV)   5	250   SMALL T&R	Yes	NIPDAU	Level-1-260C-UNLIM	-40 to 125	(LPLG, LPLL)
LP2985-25DBVT.A	Active	Production	SOT-23 (DBV)   5	250   SMALL T&R	Yes	NIPDAU	Level-1-260C-UNLIM	-40 to 125	(LPLG, LPLL)
<a href="#">LP2985-28DBVR</a>	Active	Production	SOT-23 (DBV)   5	3000   LARGE T&R	Yes	SN	Level-1-260C-UNLIM	-40 to 125	(LPGG, LPGL)
LP2985-28DBVR.A	Active	Production	SOT-23 (DBV)   5	3000   LARGE T&R	Yes	SN	Level-1-260C-UNLIM	-40 to 125	(LPGG, LPGL)
<a href="#">LP2985-28DBVTG4</a>	Active	Production	SOT-23 (DBV)   5	250   SMALL T&R	Yes	NIPDAU	Level-1-260C-UNLIM	-40 to 125	LPGG
LP2985-28DBVTG4.A	Active	Production	SOT-23 (DBV)   5	250   SMALL T&R	Yes	NIPDAU	Level-1-260C-UNLIM	-40 to 125	LPGG
<a href="#">LP2985-29DBVR</a>	Active	Production	SOT-23 (DBV)   5	3000   LARGE T&R	Yes	NIPDAU	Level-1-260C-UNLIM	-40 to 125	LPMG
LP2985-29DBVR.A	Active	Production	SOT-23 (DBV)   5	3000   LARGE T&R	Yes	NIPDAU	Level-1-260C-UNLIM	-40 to 125	LPMG
<a href="#">LP2985-30DBVR</a>	Active	Production	SOT-23 (DBV)   5	3000   LARGE T&R	Yes	NIPDAU   SN	Level-1-260C-UNLIM	-40 to 125	(LPNG, LPNL)
LP2985-30DBVR.A	Active	Production	SOT-23 (DBV)   5	3000   LARGE T&R	Yes	NIPDAU	Level-1-260C-UNLIM	-40 to 125	(LPNG, LPNL)
<a href="#">LP2985-30DBVRG4</a>	Active	Production	SOT-23 (DBV)   5	3000   LARGE T&R	Yes	NIPDAU	Level-1-260C-UNLIM	-40 to 125	(LPNG, LPNL)
LP2985-30DBVRG4.A	Active	Production	SOT-23 (DBV)   5	3000   LARGE T&R	Yes	NIPDAU	Level-1-260C-UNLIM	-40 to 125	(LPNG, LPNL)
<a href="#">LP2985-30DBVT</a>	Obsolete	Production	SOT-23 (DBV)   5	-	-	Call TI	Call TI	-40 to 125	(LPNG, LPNL)

Orderable part number	Status (1)	Material type (2)	Package   Pins	Package qty   Carrier	RoHS (3)	Lead finish/ Ball material (4)	MSL rating/ Peak reflow (5)	Op temp (°C)	Part marking (6)
<a href="#">LP2985-33DBVR</a>	Active	Production	SOT-23 (DBV)   5	3000   LARGE T&R	Yes	SN	Level-1-260C-UNLIM	-40 to 125	(LPFG, LPFL)
LP2985-33DBVR.A	Active	Production	SOT-23 (DBV)   5	3000   LARGE T&R	Yes	SN	Level-1-260C-UNLIM	-40 to 125	(LPFG, LPFL)
LP2985-33DBVRE4	Active	Production	SOT-23 (DBV)   5	3000   LARGE T&R	Yes	NIPDAU	Level-1-260C-UNLIM	-40 to 125	LPFG
<a href="#">LP2985-33DBVRG4</a>	Active	Production	SOT-23 (DBV)   5	3000   LARGE T&R	Yes	NIPDAU	Level-1-260C-UNLIM	-40 to 125	LPFG
LP2985-33DBVRG4.A	Active	Production	SOT-23 (DBV)   5	3000   LARGE T&R	Yes	NIPDAU	Level-1-260C-UNLIM	-40 to 125	LPFG
<a href="#">LP2985-33DBVRM3</a>	Active	Production	SOT-23 (DBV)   5	3000   LARGE T&R	Yes	SN	Level-1-260C-UNLIM	-40 to 125	LPFG
LP2985-33DBVRM3.A	Active	Production	SOT-23 (DBV)   5	3000   LARGE T&R	Yes	SN	Level-1-260C-UNLIM	-40 to 125	LPFG
<a href="#">LP2985-33DBVT</a>	Active	Production	SOT-23 (DBV)   5	250   SMALL T&R	Yes	SN	Level-1-260C-UNLIM	-40 to 125	(LPFG, LPFL)
LP2985-33DBVT.A	Active	Production	SOT-23 (DBV)   5	250   SMALL T&R	Yes	SN	Level-1-260C-UNLIM	-40 to 125	(LPFG, LPFL)
<a href="#">LP2985-33DBVTG4</a>	Obsolete	Production	SOT-23 (DBV)   5	-	-	Call TI	Call TI	-40 to 125	LPFG
<a href="#">LP2985-33DBVTM3</a>	Active	Production	SOT-23 (DBV)   5	250   SMALL T&R	Yes	SN	Level-1-260C-UNLIM	-40 to 125	LPFG
LP2985-33DBVTM3.A	Active	Production	SOT-23 (DBV)   5	250   SMALL T&R	Yes	SN	Level-1-260C-UNLIM	-40 to 125	LPFG
<a href="#">LP2985-50DBVR</a>	Active	Production	SOT-23 (DBV)   5	3000   LARGE T&R	Yes	NIPDAU   SN	Level-1-260C-UNLIM	-40 to 125	(LPSP, LPSL)
LP2985-50DBVR.A	Active	Production	SOT-23 (DBV)   5	3000   LARGE T&R	Yes	NIPDAU	Level-1-260C-UNLIM	-40 to 125	(LPSP, LPSL)
<a href="#">LP2985-50DBVT</a>	Active	Production	SOT-23 (DBV)   5	250   SMALL T&R	Yes	NIPDAU   SN	Level-1-260C-UNLIM	-40 to 125	(LPSP, LPSL)
LP2985-50DBVT.A	Active	Production	SOT-23 (DBV)   5	250   SMALL T&R	Yes	NIPDAU	Level-1-260C-UNLIM	-40 to 125	(LPSP, LPSL)
<a href="#">LP2985-50DBVTG4</a>	Active	Production	SOT-23 (DBV)   5	250   SMALL T&R	Yes	NIPDAU	Level-1-260C-UNLIM	-40 to 125	(LPSP, LPSL)
LP2985-50DBVTG4.A	Active	Production	SOT-23 (DBV)   5	250   SMALL T&R	Yes	NIPDAU	Level-1-260C-UNLIM	-40 to 125	(LPSP, LPSL)
<a href="#">LP2985-50DBVTM3</a>	Active	Production	SOT-23 (DBV)   5	250   SMALL T&R	Yes	SN	Level-1-260C-UNLIM	-40 to 125	LPSP
LP2985-50DBVTM3.A	Active	Production	SOT-23 (DBV)   5	250   SMALL T&R	Yes	SN	Level-1-260C-UNLIM	-40 to 125	LPSP
<a href="#">LP2985A-10DBVR</a>	Active	Production	SOT-23 (DBV)   5	3000   LARGE T&R	Yes	NIPDAU	Level-1-260C-UNLIM	-40 to 125	LRDG
LP2985A-10DBVR.A	Active	Production	SOT-23 (DBV)   5	3000   LARGE T&R	Yes	NIPDAU	Level-1-260C-UNLIM	-40 to 125	LRDG
<a href="#">LP2985A-10DBVT</a>	Active	Production	SOT-23 (DBV)   5	250   SMALL T&R	Yes	NIPDAU	Level-1-260C-UNLIM	-40 to 125	LRDG
LP2985A-10DBVT.A	Active	Production	SOT-23 (DBV)   5	250   SMALL T&R	Yes	NIPDAU	Level-1-260C-UNLIM	-40 to 125	LRDG
<a href="#">LP2985A-18DBVR</a>	Active	Production	SOT-23 (DBV)   5	3000   LARGE T&R	Yes	SN	Level-1-260C-UNLIM	-40 to 125	(LPTG, LPTL)
LP2985A-18DBVR.A	Active	Production	SOT-23 (DBV)   5	3000   LARGE T&R	Yes	SN	Level-1-260C-UNLIM	-40 to 125	(LPTG, LPTL)
<a href="#">LP2985A-18DBVRG4</a>	Active	Production	SOT-23 (DBV)   5	3000   LARGE T&R	Yes	NIPDAU	Level-1-260C-UNLIM	-40 to 125	LPTG
LP2985A-18DBVRG4.A	Active	Production	SOT-23 (DBV)   5	3000   LARGE T&R	Yes	NIPDAU	Level-1-260C-UNLIM	-40 to 125	LPTG
<a href="#">LP2985A-18DBVT</a>	Obsolete	Production	SOT-23 (DBV)   5	-	-	Call TI	Call TI	-40 to 125	(LPTG, LPTL)
<a href="#">LP2985A-25DBVR</a>	Active	Production	SOT-23 (DBV)   5	3000   LARGE T&R	Yes	NIPDAU   SN	Level-1-260C-UNLIM	-40 to 125	(LPUG, LPUL)
LP2985A-25DBVR.A	Active	Production	SOT-23 (DBV)   5	3000   LARGE T&R	Yes	NIPDAU	Level-1-260C-UNLIM	-40 to 125	(LPUG, LPUL)

Orderable part number	Status (1)	Material type (2)	Package   Pins	Package qty   Carrier	RoHS (3)	Lead finish/ Ball material (4)	MSL rating/ Peak reflow (5)	Op temp (°C)	Part marking (6)
<a href="#">LP2985A-25DBVRG4</a>	Active	Production	SOT-23 (DBV)   5	3000   LARGE T&R	Yes	NIPDAU	Level-1-260C-UNLIM	-40 to 125	(LPUG, LPUL)
LP2985A-25DBVRG4.A	Active	Production	SOT-23 (DBV)   5	3000   LARGE T&R	Yes	NIPDAU	Level-1-260C-UNLIM	-40 to 125	(LPUG, LPUL)
<a href="#">LP2985A-25DBVRM3</a>	Active	Production	SOT-23 (DBV)   5	3000   LARGE T&R	Yes	NIPDAU   SN	Level-1-260C-UNLIM	-45 to 125	(LP7G, LPUG)
LP2985A-25DBVRM3.A	Active	Production	SOT-23 (DBV)   5	3000   LARGE T&R	Yes	NIPDAU	Level-1-260C-UNLIM	-45 to 125	(LP7G, LPUG)
<a href="#">LP2985A-25DBVT</a>	Obsolete	Production	SOT-23 (DBV)   5	-	-	Call TI	Call TI	-40 to 125	(LPUG, LPUL)
<a href="#">LP2985A-28DBVR</a>	Active	Production	SOT-23 (DBV)   5	3000   LARGE T&R	Yes	NIPDAU   SN	Level-1-260C-UNLIM	-40 to 125	(LPJG, LPJL)
LP2985A-28DBVR.A	Active	Production	SOT-23 (DBV)   5	3000   LARGE T&R	Yes	NIPDAU	Level-1-260C-UNLIM	-40 to 125	(LPJG, LPJL)
<a href="#">LP2985A-29DBVR</a>	Active	Production	SOT-23 (DBV)   5	3000   LARGE T&R	Yes	NIPDAU	Level-1-260C-UNLIM	-40 to 125	(LPZG, LPZL)
LP2985A-29DBVR.A	Active	Production	SOT-23 (DBV)   5	3000   LARGE T&R	Yes	NIPDAU	Level-1-260C-UNLIM	-40 to 125	(LPZG, LPZL)
<a href="#">LP2985A-30DBVR</a>	Active	Production	SOT-23 (DBV)   5	3000   LARGE T&R	Yes	NIPDAU   SN	Level-1-260C-UNLIM	-40 to 125	(LRAG, LRAL)
LP2985A-30DBVR.A	Active	Production	SOT-23 (DBV)   5	3000   LARGE T&R	Yes	SN	Level-1-260C-UNLIM	-40 to 125	(LRAG, LRAL)
<a href="#">LP2985A-30DBVT</a>	Active	Production	SOT-23 (DBV)   5	250   SMALL T&R	Yes	NIPDAU	Level-1-260C-UNLIM	-40 to 125	(LRAG, LRAL)
LP2985A-30DBVT.A	Active	Production	SOT-23 (DBV)   5	250   SMALL T&R	Yes	NIPDAU	Level-1-260C-UNLIM	-40 to 125	(LRAG, LRAL)
<a href="#">LP2985A-33DBVR</a>	Active	Production	SOT-23 (DBV)   5	3000   LARGE T&R	Yes	NIPDAU   SN	Level-1-260C-UNLIM	-40 to 125	(LPKG, LPKL)
LP2985A-33DBVR.A	Active	Production	SOT-23 (DBV)   5	3000   LARGE T&R	Yes	NIPDAU	Level-1-260C-UNLIM	-40 to 125	(LPKG, LPKL)
<a href="#">LP2985A-33DBVRG4</a>	Active	Production	SOT-23 (DBV)   5	3000   LARGE T&R	Yes	NIPDAU	Level-1-260C-UNLIM	-40 to 125	LPKG
LP2985A-33DBVRG4.A	Active	Production	SOT-23 (DBV)   5	3000   LARGE T&R	Yes	NIPDAU	Level-1-260C-UNLIM	-40 to 125	LPKG
<a href="#">LP2985A-33DBVRM3</a>	Active	Production	SOT-23 (DBV)   5	3000   LARGE T&R	Yes	NIPDAU   SN	Level-1-260C-UNLIM	-40 to 125	LPKG
LP2985A-33DBVRM3.A	Active	Production	SOT-23 (DBV)   5	3000   LARGE T&R	Yes	NIPDAU	Level-1-260C-UNLIM	-40 to 125	LPKG
<a href="#">LP2985A-33DBVT</a>	Active	Production	SOT-23 (DBV)   5	250   SMALL T&R	Yes	SN	Level-1-260C-UNLIM	-40 to 125	(LPFG, LPKG, LPKL)
LP2985A-33DBVT.A	Active	Production	SOT-23 (DBV)   5	250   SMALL T&R	Yes	SN	Level-1-260C-UNLIM	-40 to 125	(LPFG, LPKG, LPKL)
LP2985A-33DBVTE4	Active	Production	SOT-23 (DBV)   5	250   SMALL T&R	Yes	NIPDAU	Level-1-260C-UNLIM	-40 to 125	LPKG
<a href="#">LP2985A-33DBVTG4</a>	Active	Production	SOT-23 (DBV)   5	250   SMALL T&R	Yes	NIPDAU	Level-1-260C-UNLIM	-40 to 125	LPKG
LP2985A-33DBVTG4.A	Active	Production	SOT-23 (DBV)   5	250   SMALL T&R	Yes	NIPDAU	Level-1-260C-UNLIM	-40 to 125	LPKG
<a href="#">LP2985A-50DBVR</a>	Active	Production	SOT-23 (DBV)   5	3000   LARGE T&R	Yes	NIPDAU   SN	Level-1-260C-UNLIM	-40 to 125	(LR1G, LR1L)
LP2985A-50DBVR.A	Active	Production	SOT-23 (DBV)   5	3000   LARGE T&R	Yes	NIPDAU	Level-1-260C-UNLIM	-40 to 125	(LR1G, LR1L)
<a href="#">LP2985A-50DBVRG4</a>	Active	Production	SOT-23 (DBV)   5	3000   LARGE T&R	Yes	NIPDAU	Level-1-260C-UNLIM	-40 to 125	(LR1G, LR1L)
LP2985A-50DBVRG4.A	Active	Production	SOT-23 (DBV)   5	3000   LARGE T&R	Yes	NIPDAU	Level-1-260C-UNLIM	-40 to 125	(LR1G, LR1L)
<a href="#">LP2985A-50DBVRM3</a>	Active	Production	SOT-23 (DBV)   5	3000   LARGE T&R	Yes	SN	Level-1-260C-UNLIM	-40 to 125	LR1G

Orderable part number	Status (1)	Material type (2)	Package   Pins	Package qty   Carrier	RoHS (3)	Lead finish/ Ball material (4)	MSL rating/ Peak reflow (5)	Op temp (°C)	Part marking (6)
LP2985A-50DBVRM3.A	Active	Production	SOT-23 (DBV)   5	3000   LARGE T&R	Yes	SN	Level-1-260C-UNLIM	-40 to 125	LR1G
<a href="#">LP2985A-50DBVT</a>	Active	Production	SOT-23 (DBV)   5	250   SMALL T&R	Yes	NIPDAU   SN	Level-1-260C-UNLIM	-40 to 125	(LPSG, LR1G, LR1L)
LP2985A-50DBVT.A	Active	Production	SOT-23 (DBV)   5	250   SMALL T&R	Yes	SN	Level-1-260C-UNLIM	-40 to 125	(LPSG, LR1G, LR1L)

(1) **Status:** For more details on status, see our [product life cycle](#).

(2) **Material type:** When designated, preproduction parts are prototypes/experimental devices, and are not yet approved or released for full production. Testing and final process, including without limitation quality assurance, reliability performance testing, and/or process qualification, may not yet be complete, and this item is subject to further changes or possible discontinuation. If available for ordering, purchases will be subject to an additional waiver at checkout, and are intended for early internal evaluation purposes only. These items are sold without warranties of any kind.

(3) **RoHS values:** Yes, No, RoHS Exempt. See the [TI RoHS Statement](#) for additional information and value definition.

(4) **Lead finish/Ball material:** Parts may have multiple material finish options. Finish options are separated by a vertical ruled line. Lead finish/Ball material values may wrap to two lines if the finish value exceeds the maximum column width.

(5) **MSL rating/Peak reflow:** The moisture sensitivity level ratings and peak solder (reflow) temperatures. In the event that a part has multiple moisture sensitivity ratings, only the lowest level per JEDEC standards is shown. Refer to the shipping label for the actual reflow temperature that will be used to mount the part to the printed circuit board.

(6) **Part marking:** There may be an additional marking, which relates to the logo, the lot trace code information, or the environmental category of the part.

Multiple part markings will be inside parentheses. Only one part marking contained in parentheses and separated by a "-" will appear on a part. If a line is indented then it is a continuation of the previous line and the two combined represent the entire part marking for that device.

**Important Information and Disclaimer:**The information provided on this page represents TI's knowledge and belief as of the date that it is provided. TI bases its knowledge and belief on information provided by third parties, and makes no representation or warranty as to the accuracy of such information. Efforts are underway to better integrate information from third parties. TI has taken and continues to take reasonable steps to provide representative and accurate information but may not have conducted destructive testing or chemical analysis on incoming materials and chemicals. TI and TI suppliers consider certain information to be proprietary, and thus CAS numbers and other limited information may not be available for release.

In no event shall TI's liability arising out of such information exceed the total purchase price of the TI part(s) at issue in this document sold by TI to Customer on an annual basis.

**TAPE AND REEL INFORMATION**

**QUADRANT ASSIGNMENTS FOR PIN 1 ORIENTATION IN TAPE**

\*All dimensions are nominal

Device	Package Type	Package Drawing	Pins	SPQ	Reel Diameter (mm)	Reel Width W1 (mm)	A0 (mm)	B0 (mm)	K0 (mm)	P1 (mm)	W (mm)	Pin1 Quadrant
LP2985-10DBVR	SOT-23	DBV	5	3000	178.0	9.0	3.23	3.17	1.37	4.0	8.0	Q3
LP2985-10DBVT	SOT-23	DBV	5	250	178.0	9.0	3.3	3.2	1.4	4.0	8.0	Q3
LP2985-18DBVR	SOT-23	DBV	5	3000	178.0	8.4	3.2	3.2	1.4	4.0	8.0	Q3
LP2985-18DBVRG4	SOT-23	DBV	5	3000	178.0	9.0	3.3	3.2	1.4	4.0	8.0	Q3
LP2985-18DBVRM3	SOT-23	DBV	5	3000	180.0	8.4	3.2	3.2	1.4	4.0	8.0	Q3
LP2985-18DBVTG4	SOT-23	DBV	5	250	178.0	9.0	3.23	3.17	1.37	4.0	8.0	Q3
LP2985-25DBVR	SOT-23	DBV	5	3000	178.0	8.4	3.2	3.2	1.4	4.0	8.0	Q3
LP2985-28DBVR	SOT-23	DBV	5	3000	178.0	8.4	3.2	3.2	1.4	4.0	8.0	Q3
LP2985-28DBVTG4	SOT-23	DBV	5	250	178.0	9.0	3.3	3.2	1.4	4.0	8.0	Q3
LP2985-29DBVR	SOT-23	DBV	5	3000	178.0	9.0	3.23	3.17	1.37	4.0	8.0	Q3
LP2985-30DBVR	SOT-23	DBV	5	3000	178.0	8.4	3.2	3.2	1.4	4.0	8.0	Q3
LP2985-30DBVRG4	SOT-23	DBV	5	3000	180.0	8.4	3.2	3.2	1.4	4.0	8.0	Q3
LP2985-33DBVR	SOT-23	DBV	5	3000	178.0	8.4	3.2	3.2	1.4	4.0	8.0	Q3
LP2985-33DBVR	SOT-23	DBV	5	3000	180.0	8.4	3.2	3.2	1.4	4.0	8.0	Q3
LP2985-33DBVRG4	SOT-23	DBV	5	3000	180.0	8.4	3.2	3.2	1.4	4.0	8.0	Q3
LP2985-33DBVRM3	SOT-23	DBV	5	3000	180.0	8.4	3.2	3.2	1.4	4.0	8.0	Q3

Device	Package Type	Package Drawing	Pins	SPQ	Reel Diameter (mm)	Reel Width W1 (mm)	A0 (mm)	B0 (mm)	K0 (mm)	P1 (mm)	W (mm)	Pin1 Quadrant
LP2985-33DBVT	SOT-23	DBV	5	250	180.0	8.4	3.2	3.2	1.4	4.0	8.0	Q3
LP2985-33DBVTM3	SOT-23	DBV	5	250	180.0	8.4	3.2	3.2	1.4	4.0	8.0	Q3
LP2985-50DBVR	SOT-23	DBV	5	3000	180.0	8.4	3.2	3.2	1.4	4.0	8.0	Q3
LP2985-50DBVT	SOT-23	DBV	5	250	180.0	8.4	3.2	3.2	1.4	4.0	8.0	Q3
LP2985-50DBVTG4	SOT-23	DBV	5	250	180.0	8.4	3.2	3.2	1.4	4.0	8.0	Q3
LP2985-50DBVTM3	SOT-23	DBV	5	250	180.0	8.4	3.2	3.2	1.4	4.0	8.0	Q3
LP2985A-10DBVR	SOT-23	DBV	5	3000	178.0	9.0	3.23	3.17	1.37	4.0	8.0	Q3
LP2985A-10DBVT	SOT-23	DBV	5	250	178.0	9.0	3.3	3.2	1.4	4.0	8.0	Q3
LP2985A-18DBVR	SOT-23	DBV	5	3000	180.0	8.4	3.2	3.2	1.4	4.0	8.0	Q3
LP2985A-18DBVRG4	SOT-23	DBV	5	3000	178.0	9.0	3.23	3.17	1.37	4.0	8.0	Q3
LP2985A-25DBVR	SOT-23	DBV	5	3000	178.0	8.4	3.2	3.2	1.4	4.0	8.0	Q3
LP2985A-25DBVRG4	SOT-23	DBV	5	3000	180.0	8.4	3.2	3.2	1.4	4.0	8.0	Q3
LP2985A-25DBVRM3	SOT-23	DBV	5	3000	178.0	8.4	3.2	3.2	1.4	4.0	8.0	Q3
LP2985A-28DBVR	SOT-23	DBV	5	3000	180.0	9.2	3.17	3.23	1.37	4.0	8.0	Q3
LP2985A-28DBVR	SOT-23	DBV	5	3000	178.0	9.0	3.23	3.17	1.37	4.0	8.0	Q3
LP2985A-29DBVR	SOT-23	DBV	5	3000	178.0	9.0	3.23	3.17	1.37	4.0	8.0	Q3
LP2985A-30DBVR	SOT-23	DBV	5	3000	178.0	8.4	3.2	3.2	1.4	4.0	8.0	Q3
LP2985A-33DBVR	SOT-23	DBV	5	3000	178.0	8.4	3.2	3.2	1.4	4.0	8.0	Q3
LP2985A-33DBVRG4	SOT-23	DBV	5	3000	180.0	8.4	3.2	3.2	1.4	4.0	8.0	Q3
LP2985A-33DBVRM3	SOT-23	DBV	5	3000	178.0	8.4	3.2	3.2	1.4	4.0	8.0	Q3
LP2985A-33DBVT	SOT-23	DBV	5	250	180.0	8.4	3.2	3.2	1.4	4.0	8.0	Q3
LP2985A-33DBVTG4	SOT-23	DBV	5	250	180.0	8.4	3.2	3.2	1.4	4.0	8.0	Q3
LP2985A-50DBVR	SOT-23	DBV	5	3000	180.0	8.4	3.2	3.2	1.4	4.0	8.0	Q3
LP2985A-50DBVRG4	SOT-23	DBV	5	3000	180.0	8.4	3.2	3.2	1.4	4.0	8.0	Q3
LP2985A-50DBVRM3	SOT-23	DBV	5	3000	178.0	8.4	3.2	3.2	1.4	4.0	8.0	Q3
LP2985A-50DBVT	SOT-23	DBV	5	250	180.0	8.4	3.2	3.2	1.4	4.0	8.0	Q3

**TAPE AND REEL BOX DIMENSIONS**

\*All dimensions are nominal

Device	Package Type	Package Drawing	Pins	SPQ	Length (mm)	Width (mm)	Height (mm)
LP2985-10DBVR	SOT-23	DBV	5	3000	180.0	180.0	18.0
LP2985-10DBVT	SOT-23	DBV	5	250	180.0	180.0	18.0
LP2985-18DBVR	SOT-23	DBV	5	3000	208.0	191.0	35.0
LP2985-18DBVRG4	SOT-23	DBV	5	3000	180.0	180.0	18.0
LP2985-18DBVRM3	SOT-23	DBV	5	3000	210.0	185.0	35.0
LP2985-18DBVTG4	SOT-23	DBV	5	250	180.0	180.0	18.0
LP2985-25DBVR	SOT-23	DBV	5	3000	208.0	191.0	35.0
LP2985-28DBVR	SOT-23	DBV	5	3000	208.0	191.0	35.0
LP2985-28DBVTG4	SOT-23	DBV	5	250	180.0	180.0	18.0
LP2985-29DBVR	SOT-23	DBV	5	3000	180.0	180.0	18.0
LP2985-30DBVR	SOT-23	DBV	5	3000	208.0	191.0	35.0
LP2985-30DBVRG4	SOT-23	DBV	5	3000	210.0	185.0	35.0
LP2985-33DBVR	SOT-23	DBV	5	3000	208.0	191.0	35.0
LP2985-33DBVR	SOT-23	DBV	5	3000	210.0	185.0	35.0
LP2985-33DBVRG4	SOT-23	DBV	5	3000	210.0	185.0	35.0
LP2985-33DBVRM3	SOT-23	DBV	5	3000	210.0	185.0	35.0
LP2985-33DBVT	SOT-23	DBV	5	250	210.0	185.0	35.0
LP2985-33DBVTM3	SOT-23	DBV	5	250	210.0	185.0	35.0

Device	Package Type	Package Drawing	Pins	SPQ	Length (mm)	Width (mm)	Height (mm)
LP2985-50DBVR	SOT-23	DBV	5	3000	210.0	185.0	35.0
LP2985-50DBVT	SOT-23	DBV	5	250	210.0	185.0	35.0
LP2985-50DBVTG4	SOT-23	DBV	5	250	210.0	185.0	35.0
LP2985-50DBVTM3	SOT-23	DBV	5	250	210.0	185.0	35.0
LP2985A-10DBVR	SOT-23	DBV	5	3000	180.0	180.0	18.0
LP2985A-10DBVT	SOT-23	DBV	5	250	180.0	180.0	18.0
LP2985A-18DBVR	SOT-23	DBV	5	3000	210.0	185.0	35.0
LP2985A-18DBVRG4	SOT-23	DBV	5	3000	180.0	180.0	18.0
LP2985A-25DBVR	SOT-23	DBV	5	3000	208.0	191.0	35.0
LP2985A-25DBVRG4	SOT-23	DBV	5	3000	210.0	185.0	35.0
LP2985A-25DBVRM3	SOT-23	DBV	5	3000	208.0	191.0	35.0
LP2985A-28DBVR	SOT-23	DBV	5	3000	205.0	200.0	33.0
LP2985A-28DBVR	SOT-23	DBV	5	3000	180.0	180.0	18.0
LP2985A-29DBVR	SOT-23	DBV	5	3000	180.0	180.0	18.0
LP2985A-30DBVR	SOT-23	DBV	5	3000	208.0	191.0	35.0
LP2985A-33DBVR	SOT-23	DBV	5	3000	208.0	191.0	35.0
LP2985A-33DBVRG4	SOT-23	DBV	5	3000	210.0	185.0	35.0
LP2985A-33DBVRM3	SOT-23	DBV	5	3000	208.0	191.0	35.0
LP2985A-33DBVT	SOT-23	DBV	5	250	210.0	185.0	35.0
LP2985A-33DBVTG4	SOT-23	DBV	5	250	210.0	185.0	35.0
LP2985A-50DBVR	SOT-23	DBV	5	3000	210.0	185.0	35.0
LP2985A-50DBVRG4	SOT-23	DBV	5	3000	210.0	185.0	35.0
LP2985A-50DBVRM3	SOT-23	DBV	5	3000	208.0	191.0	35.0
LP2985A-50DBVT	SOT-23	DBV	5	250	210.0	185.0	35.0



# EXAMPLE BOARD LAYOUT

DBV0005A

SOT-23 - 1.45 mm max height

SMALL OUTLINE TRANSISTOR



LAND PATTERN EXAMPLE  
EXPOSED METAL SHOWN  
SCALE:15X



SOLDER MASK DETAILS

4214839/K 08/2024

NOTES: (continued)

- 6. Publication IPC-7351 may have alternate designs.
- 7. Solder mask tolerances between and around signal pads can vary based on board fabrication site.

# EXAMPLE STENCIL DESIGN

DBV0005A

SOT-23 - 1.45 mm max height

SMALL OUTLINE TRANSISTOR



SOLDER PASTE EXAMPLE  
BASED ON 0.125 mm THICK STENCIL  
SCALE:15X

4214839/K 08/2024

NOTES: (continued)

8. Laser cutting apertures with trapezoidal walls and rounded corners may offer better paste release. IPC-7525 may have alternate design recommendations.
9. Board assembly site may have different recommendations for stencil design.

## 重要通知和免责声明

TI“按原样”提供技术和可靠性数据（包括数据表）、设计资源（包括参考设计）、应用或其他设计建议、网络工具、安全信息和其他资源，不保证没有瑕疵且不做任何明示或暗示的担保，包括但不限于对适销性、与某特定用途的适用性或不侵犯任何第三方知识产权的暗示担保。

这些资源可供使用 TI 产品进行设计的熟练开发人员使用。您将自行承担以下全部责任：(1) 针对您的应用选择合适的 TI 产品，(2) 设计、验证并测试您的应用，(3) 确保您的应用满足相应标准以及任何其他安全、安保法规或其他要求。

这些资源如有变更，恕不另行通知。TI 授权您仅可将这些资源用于研发本资源所述的 TI 产品的相关应用。严禁以其他方式对这些资源进行复制或展示。您无权使用任何其他 TI 知识产权或任何第三方知识产权。对于因您对这些资源的使用而对 TI 及其代表造成的任何索赔、损害、成本、损失和债务，您将全额赔偿，TI 对此概不负责。

TI 提供的产品受 [TI 销售条款](#)、[TI 通用质量指南](#) 或 [ti.com](#) 上其他适用条款或 TI 产品随附的其他适用条款的约束。TI 提供这些资源并不会扩展或以其他方式更改 TI 针对 TI 产品发布的适用的担保或担保免责声明。除非德州仪器 (TI) 明确将某产品指定为定制产品或客户特定产品，否则其产品均为按确定价格收入目录的标准通用器件。

TI 反对并拒绝您可能提出的任何其他或不同的条款。

版权所有 © 2026，德州仪器 (TI) 公司

最后更新日期：2025 年 10 月