

## LP5922 具有低输入和输出电压能力的 2A 低噪声可调 LDO

### 1 特性

- 宽输入电压范围：1.3V 至 6V
- 支持低  $V_{IN}$  电压，无需额外的偏置电源
- 可调节输出电压：0.5V 至 5V
- 低压降：200mA（2A 负载时）
- 低输出电压噪声：25 $\mu$ V<sub>RMS</sub>
- 输出电流：2A
- 运行结温范围：-40°C 至 +125°C
- 可编程软启动，可限制浪涌电流
- 3mm x 3mm x 0.75mm 10 引脚晶圆级小外形无引线 (WSON) 封装
- 热过载保护和短路保护
- 输出电压容差：±1.5%
- 关断电源电流：0.1 $\mu$ A
- 电源抑制比 (PSRR)：70dB（1kHz 频率时）
- 电源正常输出

### 2 应用

- 空间受限型 应用
- 噪声敏感型和纹波敏感型高电流模拟或射频系统
- 目标领域
  - 医疗、测试和测量设备
  - 便携式消费类电子产品
  - 电信和网卡
  - 无线基础设施
  - 工业 应用
- 典型系统
  - 无线电收发器、功率放大器、锁相环 (PLL)/合成器、定时、压控振荡器 (VCO)、通用分组无线业务 (GPRS)、3G 模块、现场可编程门阵列 (FPGA)、数字信号处理器 (DSP)、图形处理单元 (GPU) 等等

### 3 说明

LP5922 是一款 2A 低压降 (LDO) 线性稳压器，在最大电流情况下的典型压降为 200mV。LP5922 器件支持的工作电源轨低至 1.3V，无需额外的偏置电源。凭借低压降和低  $V_{IN}$  能力，有效确保了最大的系统效率和最小功耗。该器件还具有低静态电流和超低关断电流。

LP5922 器件的设计旨在追求高 PSRR 和低输出噪声，以期在没有额外滤波功能的情况下为敏感型模拟应用提供支持。甚至只需在 SS/NR 引脚连接一个小电容即可使输出噪声进一步得到降低。

输出电压可通过外部电阻分压器调节，范围为 0.5V 到 5V。使能引脚、可调软启动和可选电源正常特性有助于实施系统电源排序。浪涌电流可通过软启动加以控制，而且器件还具有短路保护和热保护。

#### 器件信息<sup>(1)</sup>

器件型号	封装	封装尺寸 (标称值)
LP5922	WSON (10)	3.00mm x 3.00mm

(1) 要了解所有可用封装，请见数据表末尾的可订购产品附录。

简化电路原理图

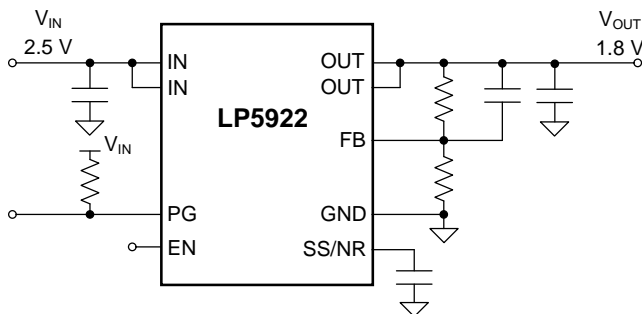

Copyright © 2016, Texas Instruments Incorporated



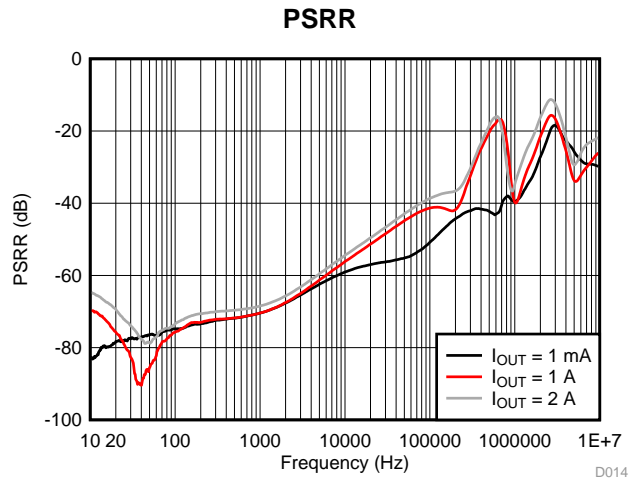

## 目录

<b>1</b>	特性 .....	<b>1</b>	7.4	Device Functional Modes .....	<b>13</b>
<b>2</b>	应用 .....	<b>1</b>	<b>8</b>	<b>Applications and Implementation</b> .....	<b>14</b>
<b>3</b>	说明 .....	<b>1</b>	8.1	Application Information .....	<b>14</b>
<b>4</b>	修订历史记录 .....	<b>3</b>	8.2	Typical Application .....	<b>14</b>
<b>5</b>	<b>Pin Configuration and Functions</b> .....	<b>4</b>	<b>9</b>	<b>Power Supply Recommendations</b> .....	<b>19</b>
<b>6</b>	<b>Specifications</b> .....	<b>5</b>	<b>10</b>	<b>Layout</b> .....	<b>20</b>
6.1	Absolute Maximum Ratings .....	<b>5</b>	10.1	Layout Guidelines .....	<b>20</b>
6.2	ESD Ratings .....	<b>5</b>	10.2	Layout Example .....	<b>20</b>
6.3	Recommended Operating Conditions .....	<b>5</b>	<b>11</b>	<b>器件和文档支持</b> .....	<b>21</b>
6.4	Thermal Information .....	<b>5</b>	11.1	相关文档 .....	<b>21</b>
6.5	Electrical Characteristics .....	<b>6</b>	11.2	接收文档更新通知 .....	<b>21</b>
6.6	Input and Output Capacitors .....	<b>7</b>	11.3	社区资源 .....	<b>21</b>
6.7	Typical Characteristics .....	<b>8</b>	11.4	商标 .....	<b>21</b>
<b>7</b>	<b>Detailed Description</b> .....	<b>11</b>	11.5	静电放电警告 .....	<b>21</b>
7.1	Overview .....	<b>11</b>	11.6	Glossary .....	<b>21</b>
7.2	Functional Block Diagram .....	<b>11</b>	<b>12</b>	<b>机械、封装和可订购信息</b> .....	<b>21</b>
7.3	Feature Description .....	<b>11</b>			

## 4 修订历史记录

日期	修订版本	注释
2016 年 11 月	*	最初发布。

## 5 Pin Configuration and Functions

**DSC Package  
10-Pin WSON With Thermal Pad  
Top View**

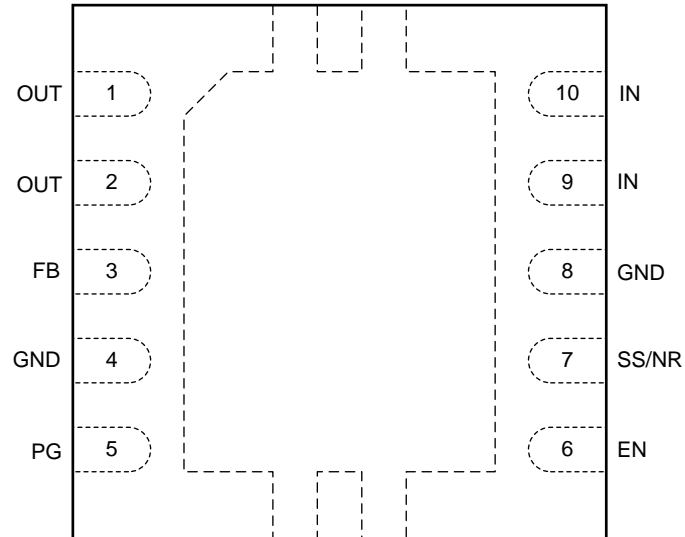

**Pin Functions**

PIN		I/O	DESCRIPTION
NUMBER	NAME		
1	OUT	O	Regulated output voltage, connect directly to pin 2
2	OUT	O	Regulated output voltage, connect directly to pin 1
3	FB	I	Voltage feedback input to the internal error amplifier
4	GND	Ground	Ground; connect to device pin 8.
5	PG	O	Power Good to indicate the status of output voltage. Requires an external pull-up resistor. When PG pin voltage is high the output voltage is considered good.
6	EN	I	Enable
7	SS/NR	I/O	Soft-start and noise reduction pin
8	GND	Ground	Ground —connect to device pin 4.
9	IN	I	Supply voltage input — connect directly to pin 10.
10	IN	I	Supply voltage input —connect directly to pin 9.
Exposed pad	Thermal Pad	—	The exposed thermal pad on the bottom of the package must be connected to a copper area under the package on the PCB. Connect to ground potential. Do not connect to any potential other than the same ground potential seen at device pins 4 and 8 (GND). See <a href="#">Power Dissipation</a> for more information.

## 6 Specifications

### 6.1 Absolute Maximum Ratings

over operating free-air temperature range (unless otherwise noted)<sup>(1)(2)</sup>

	MIN	MAX	UNIT
IN pin voltage, $V_{IN}$	-0.3	7	V
OUT pin voltage, $V_{OUT}$	See <sup>(3)</sup>		
EN pin voltage, $V_{EN}$	-0.3	7	V
PG pin voltage, $V_{PG}$	-0.3	7	V
SS/NR pin voltage, $V_{SS/NR}$	-0.3	3.6	V
FB pin voltage, $V_{FB}$	-0.3	3.6	V
Junction temperature, $T_J$	150		°C
Continuous power dissipation <sup>(4)</sup>	Internally limited		
Storage temperature, $T_{stg}$	-65	150	°C

- (1) Stresses beyond those listed under *Absolute Maximum Ratings* may cause permanent damage to the device. These are stress ratings only, which do not imply functional operation of the device at these or any other conditions beyond those indicated under *Recommended Operating Conditions*. Exposure to absolute-maximum-rated conditions for extended periods may affect device reliability.
- (2) All voltages are with respect to the potential at the GND pin.
- (3) Absolute maximum  $V_{OUT}$  is the lesser of  $V_{IN} + 0.3$  V, or 7 V.
- (4) Internal thermal shutdown circuitry protects the device from permanent damage.

### 6.2 ESD Ratings

		VALUE	UNIT
$V_{(ESD)}$	Electrostatic discharge	Human-body model (HBM), per ANSI/ESDA/JEDEC JS-001 <sup>(1)</sup>	±2000
		Charged-device model (CDM), per JEDEC specification JESD22-C101 <sup>(2)</sup>	±1000

- (1) JEDEC document JEP155 states that 500-V HBM allows safe manufacturing with a standard ESD control process
- (2) JEDEC document JEP157 states that 250-V CDM allows safe manufacturing with a standard ESD control process.

### 6.3 Recommended Operating Conditions

over operating free-air temperature range (unless otherwise noted)

	MIN	NOM	MAX	UNIT
Input voltage, $V_{IN}$	1.3		6	V
Output voltage, $V_{OUT}$	0.5		5	V
FB voltage, $V_{FB}$	0.5			V
EN input voltage, $V_{EN}$	0		$V_{IN}$	V
Recommended load current, $I_L$	0		2	A
Operating junction temperature, $T_{J-MAX-OP}$	-40		125	°C

### 6.4 Thermal Information

THERMAL METRIC <sup>(1)</sup>		LP5922	UNIT
		DSC (WSO)	
		10 PINS	
$R_{\theta JA}$ <sup>(2)</sup>	Junction-to-ambient thermal resistance, High K	49.5 <sup>(3)</sup>	°C/W
$R_{\theta JC(top)}$	Junction-to-case (top) thermal resistance	38.2	°C/W
$R_{\theta JB}$	Junction-to-board thermal resistance	24.0	°C/W
$\Psi_{JT}$	Junction-to-top characterization parameter	0.5	°C/W
$\Psi_{JB}$	Junction-to-board characterization parameter	24.1	°C/W
$R_{\theta JC(bot)}$	Junction-to-case (bottom) thermal resistance	6.0	°C/W

- (1) For more information about traditional and new thermal metrics, see [Semiconductor and IC Package Thermal Metrics](#).
- (2) Thermal resistance value  $R_{\theta JA}$  is based on the EIA/JEDEC High-K printed circuit board defined by *JESD51-7 - High Effective Thermal Conductivity Test Board for Leaded Surface Mount Packages*.
- (3) The PCB for the WSON/DSC package  $R_{\theta JA}$  includes four (4) thermal vias, in a 2 × 2 array, under the exposed thermal pad per EIA/JEDEC JESD51-5.

### 6.5 Electrical Characteristics

$V_{IN} = V_{OUT(NOM)} + 0.5\text{ V}$  or  $1.3\text{ V}$ , whichever is greater;  $V_{EN} = 1.2\text{ V}$ ,  $C_{IN} = 22\text{ }\mu\text{F}$ ,  $C_{OUT} = 22\text{ }\mu\text{F}$ , OUT connected to  $50\text{ }\Omega$  to GND,  $V_{FB} = 0.5\text{ V}$ ,  $C_{SS/NR} = 0.12\text{ }\mu\text{F}$ ,  $C_{FF} = 0.01\text{ }\mu\text{F}$ , and PG pin pulled up to  $V_{IN}$  by  $100\text{-k}\Omega$  resistor (unless otherwise noted).<sup>(1)(2)(3)</sup>

PARAMETER		TEST CONDITIONS	MIN	TYP	MAX	UNIT
<b>SUPPLY VOLTAGE</b>						
$V_{IN}$	Input voltage range		1.3		6	V
UVLO	Undervoltage lock-out threshold	$V_{IN}$ Rising ( $\uparrow$ ) until output is ON		1.2	1.25	V
$\Delta$ UVLO	UVLO hysteresis	$V_{IN}$ Falling ( $\downarrow$ ) from UVLO threshold until output is OFF		160		mV
<b>OUTPUT VOLTAGE AND REGULATION</b>						
$V_{OUT}$	Output voltage range		0.5		5	V
$\Delta$ $V_{OUT}$	Line regulation	$I_{OUT} = 5\text{ mA}$ , $1.3\text{ V} \leq V_{IN} \leq 6\text{ V}$		0.02		%/V
	Load regulation	$5\text{ mA} \leq I_{OUT} \leq 2\text{ A}$		0.1		%/A
$V_{DO}$	Dropout voltage <sup>(4)</sup>	$V_{IN} = 1.4\text{ V}$ , $I_{OUT} = 2\text{ A}$		220	400	mV
		$V_{IN} = 2.5\text{ V}$ , $I_{OUT} = 2\text{ A}$		100	180	
		$V_{IN} = 5.3\text{ V}$ , $I_{OUT} = 2\text{ A}$		90	160	
<b>FB</b>						
$V_{FB}$	FB voltage	$I_{OUT} = 5\text{ mA}$ to $2\text{ A}$	492.5	500	507.5	mV
$I_{FB}$	FB pin input current	$V_{FB} = 0.5\text{ V}$	-100		100	nA
<b>CURRENT LEVELS</b>						
$I_L$	Maximum load current	$V_{IN} \geq 1.3\text{ V}$	2			A
$I_{SC}$	Short-circuit current limit <sup>(5)</sup>		2.2	3	3.8	A
$I_{GND}$	Ground-current minimum load <sup>(6)</sup>	$V_{IN} = 6\text{ V}$ , $I_{OUT} = 0\text{ mA}$		0.7		mA
	Ground-current maximum load <sup>(6)</sup>	$V_{IN} = 1.3\text{ V}$ , $I_{OUT} = 2\text{ A}$		1	4	
$I_{GND(SD)}$	Shutdown current <sup>(7)</sup>	$V_{IN} = 6\text{ V}$ , $V_{EN} = 0\text{ V}$ , $V_{PG} = 0\text{ V}$		0.1	15	$\mu$ A
<b><math>V_{IN}</math> to <math>V_{OUT}</math> RIPPLE REJECTION <sup>(8)</sup></b>						
PSRR	Power-supply rejection ratio	$V_{IN} \geq 1.4\text{ V}$ , $f = 1\text{ kHz}$ , $I_{OUT} = 2\text{ A}$		70		dB
		$V_{IN} \geq 1.4\text{ V}$ , $f = 10\text{ kHz}$ , $I_{OUT} = 2\text{ A}$		55		
		$V_{IN} \geq 1.4\text{ V}$ , $f = 100\text{ kHz}$ , $I_{OUT} = 2\text{ A}$		40		
		$V_{IN} \geq 1.4\text{ V}$ , $f = 1\text{ MHz}$ , $I_{OUT} = 2\text{ A}$		30		
<b>OUTPUT NOISE VOLTAGE</b>						
$e_N$	Noise voltage <sup>(8)</sup>	$V_{IN} = 2.5\text{ V}$ , $V_{OUT} = 1.8\text{ V}$ BW = 10 Hz to 100 kHz		25		$\mu$ V <sub>RMS</sub>

- (1) All voltages are with respect to the GND pin.
- (2) Minimum and maximum limits are design targeted limits over the junction temperature ( $T_J$ ) range of  $-40^\circ\text{C}$  to  $+125^\circ\text{C}$ , unless otherwise stated. Typical values represent the most likely parametric norm at  $T_J = 25^\circ\text{C}$ , and are provided for reference purposes only.
- (3)  $C_{IN}$ ,  $C_{OUT}$ : Low-ESR surface-mount-ceramic capacitors (MLCCs) used in setting electrical characteristics.
- (4) Dropout voltage is the voltage difference between the input and the output at which the FB voltage drops to 97% of its nominal value.
- (5) Short-circuit current ( $I_{SC}$ ) is equivalent to current limit. To minimize thermal effects during testing,  $I_{SC}$  is measured with  $V_{OUT}$  pulled to 100 mV below its nominal voltage.
- (6) Ground current is defined here as the total current flowing to ground as a result of all voltages applied to the device  
 $I_{GND} = (I_{IN} - I_{OUT}) + I_{EN} + I_{LKG(PG)}$
- (7) Ground current in shutdown mode,  $I_{GND(SD)}$ , does NOT include current from PG pin.
- (8) This specification is verified by design.

## Electrical Characteristics (continued)

$V_{IN} = V_{OUT(NOM)} + 0.5\text{ V}$  or  $1.3\text{ V}$ , whichever is greater;  $V_{EN} = 1.2\text{ V}$ ,  $C_{IN} = 22\text{ }\mu\text{F}$ ,  $C_{OUT} = 22\text{ }\mu\text{F}$ , OUT connected to  $50\text{ }\Omega$  to GND,  $V_{FB} = 0.5\text{ V}$ ,  $C_{SS/NR} = 0.12\text{ }\mu\text{F}$ ,  $C_{FF} = 0.01\text{ }\mu\text{F}$ , and PG pin pulled up to  $V_{IN}$  by  $100\text{-k}\Omega$  resistor (unless otherwise noted).<sup>(1)(2)(3)</sup>

PARAMETER		TEST CONDITIONS	MIN	TYP	MAX	UNIT
<b>LOGIC INPUT THRESHOLDS</b>						
$V_{IL(EN)}$	EN pin low threshold	$V_{EN}$ falling ( $\downarrow$ ) until output is OFF			0.35	V
$V_{IH(EN)}$	EN pin high threshold	$V_{EN}$ rising ( $\uparrow$ ) until output is ON	1.2			V
$I_{EN}$	Input current at EN pin <sup>(9)</sup>	$V_{IN} = 6\text{ V}$ , $V_{EN} = 6\text{ V}$		3		$\mu\text{A}$
$PG_{HTH}$	PG high threshold (% of nominal $V_{OUT}$ )	$V_{OUT}$ rising ( $\uparrow$ ) until PG goes high		94%		
$PG_{LTH}$	PG low threshold (% of nominal $V_{OUT}$ )	$V_{OUT}$ falling ( $\downarrow$ ) until PG goes low		90%		
$V_{OL(PG)}$	PG pin low-level output voltage	$V_{OUT} < PG_{LTH}$ , sink current = $1\text{ mA}$			400	mV
$I_{LKG(PG)}$	PG pin leakage current	$V_{OUT} > PG_{HTH}$ , $V_{PG} = 6\text{ V}$			1	$\mu\text{A}$
<b>SOFT START</b>						
$I_{SS}$	SS/NR pin charging current			6.2		$\mu\text{A}$
<b>THERMAL SHUTDOWN</b>						
$T_{SD}$	Thermal shutdown temperature			165		$^{\circ}\text{C}$
$\Delta T_{SD}$	Thermal shutdown hysteresis			15		$^{\circ}\text{C}$
<b>TRANSITION CHARACTERISTICS</b>						
$\Delta V_{OUT}$	Line transients	$\Delta V_{IN} = 0.5\text{ V}$ , $V_{OUT} = 2.8\text{ V}$ , $t_{RISE} = t_{FALL} = 5\text{ }\mu\text{s}$		3		mV
	Load transients	$V_{OUT} = 3.3\text{ V}$ , $I_{OUT} = 10\text{ mA}$ to $2\text{ A}$ to $10\text{ mA}$ $t_{RISE} = t_{FALL} = 1\text{ V}/\mu\text{s}$		25		
$R_{AD}$	Output discharge pull-down resistance	$V_{EN} = 0\text{ V}$ , $V_{IN} = 2.3\text{ V}$		400		$\Omega$

(9) There is a  $2\text{-M}\Omega$  resistor between EN and ground (pulldown) on the device.

## 6.6 Input and Output Capacitors

over operating free-air temperature range (unless otherwise noted)

PARAMETER		TEST CONDITIONS	MIN	TYP	MAX	UNIT
$C_{IN}$	Input capacitance <sup>(1)</sup>			22		$\mu\text{F}$
$C_{OUT}$	Output capacitance	$V_{OUT} \leq 0.8\text{ V}$	34	47		$\mu\text{F}$
		$V_{OUT} > 0.8\text{ V}$	15	22		

(1) Typically input capacitance placed close to the device is in the same order as output capacitance. See also [Input Capacitor,  \$C\_{IN}\$](#) .

### 6.7 Typical Characteristics

$V_{IN} = V_{OUT} + 0.5\text{ V}$ ,  $V_{EN} = 1.2\text{ V}$ ,  $C_{IN} = 22\text{ }\mu\text{F}$ ,  $C_{OUT} = 22\text{ }\mu\text{F}$ , OUT connected to  $50\text{ }\Omega$  to GND,  $V_{FB} = 0.5\text{ V}$ ,  $C_{SS/NR} = 0.12\text{ }\mu\text{F}$ ,  $C_{FF} = 0.01\text{ }\mu\text{F}$ , and PG pin pulled up to  $V_{IN}$  by  $100\text{-k}\Omega$  resistor and  $T_J = 25^\circ\text{C}$ , unless otherwise stated.

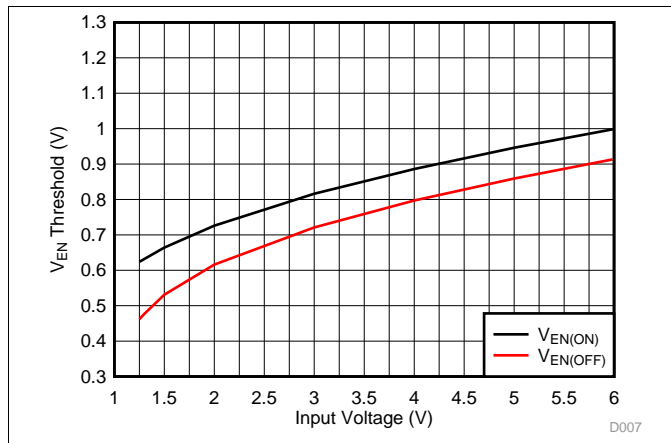

Figure 1.  $V_{EN}$  Thresholds vs Input Voltage

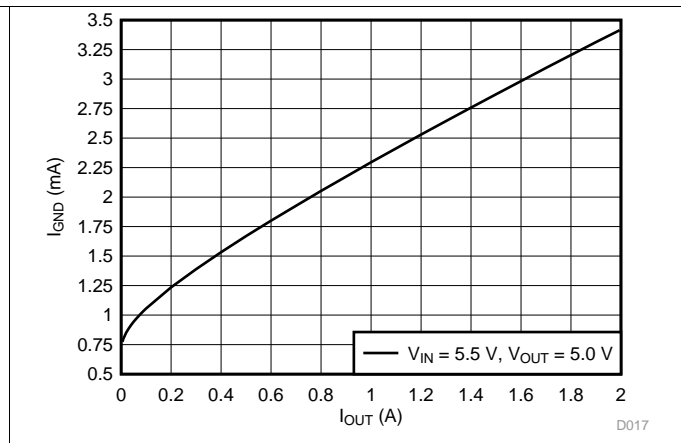

Figure 2. Ground Current vs Output Current

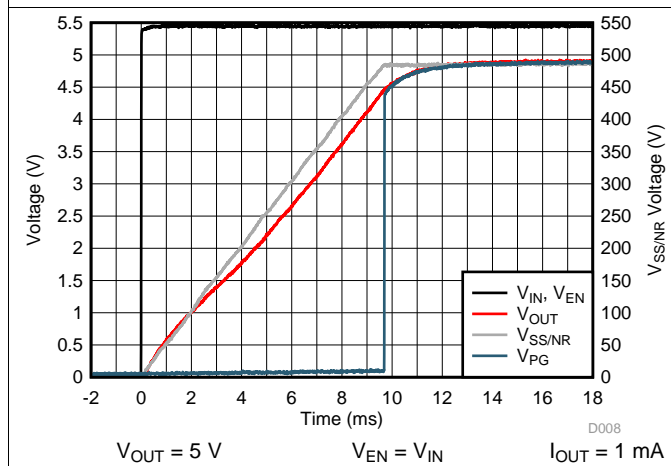

Figure 3. Power Up

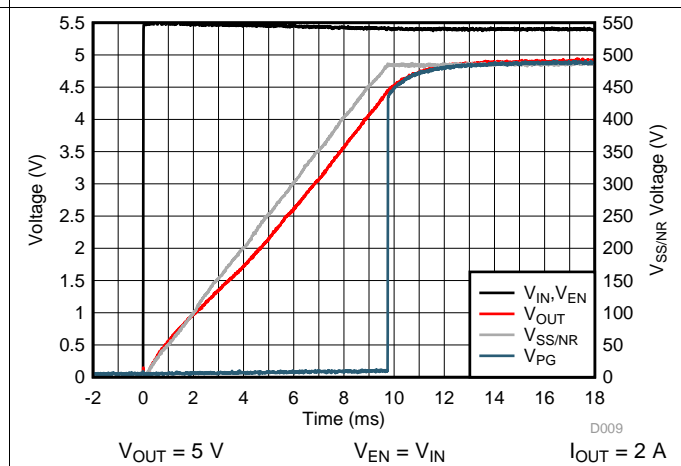

Figure 4. Power Up

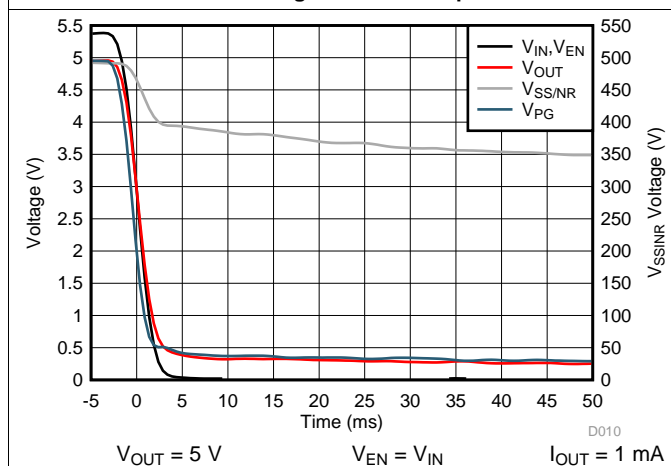

Figure 5. Power Down

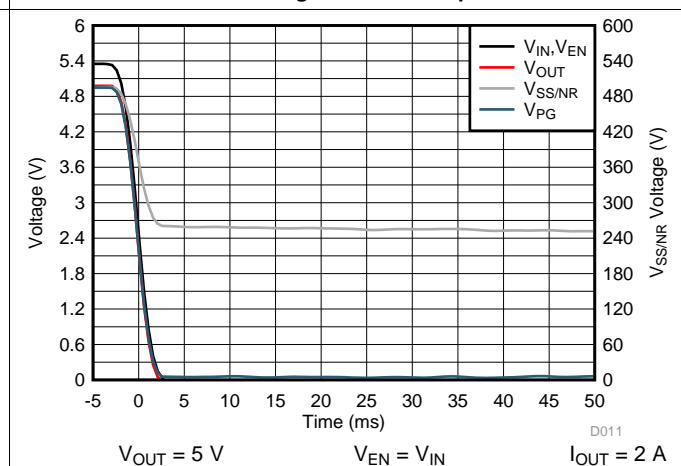

Figure 6. Power Down

Typical Characteristics (continued)

$V_{IN} = V_{OUT} + 0.5\text{ V}$ ,  $V_{EN} = 1.2\text{ V}$ ,  $C_{IN} = 22\text{ }\mu\text{F}$ ,  $C_{OUT} = 22\text{ }\mu\text{F}$ , OUT connected to  $50\text{ }\Omega$  to GND,  $V_{FB} = 0.5\text{ V}$ ,  $C_{SS/NR} = 0.12\text{ }\mu\text{F}$ ,  $C_{FF} = 0.01\text{ }\mu\text{F}$ , and PG pin pulled up to  $V_{IN}$  by  $100\text{-k}\Omega$  resistor and  $T_J = 25^\circ\text{C}$ , unless otherwise stated.

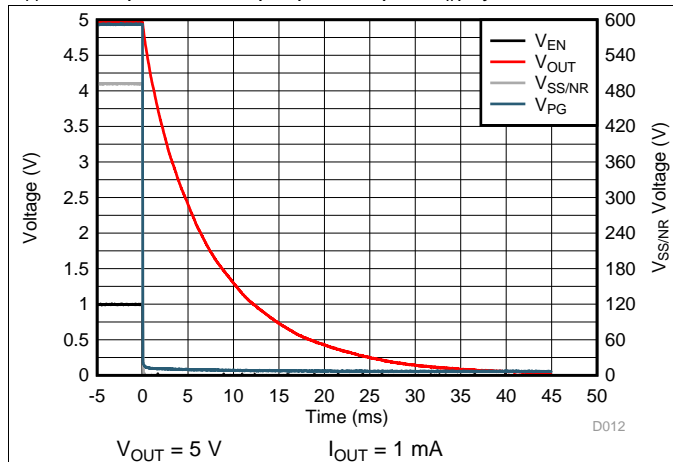

Figure 7. Power Down

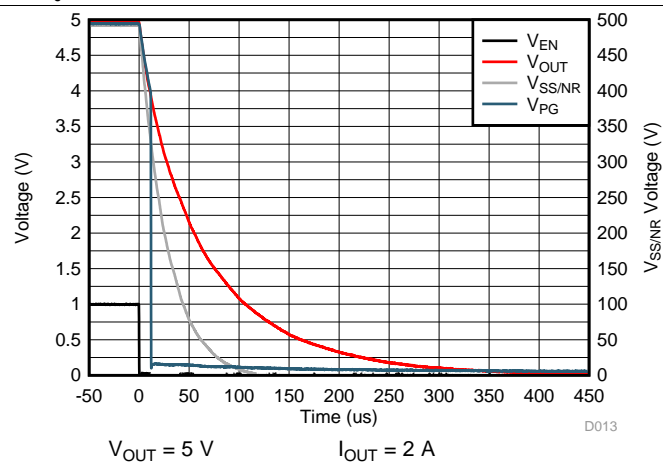

Figure 8. Power Down

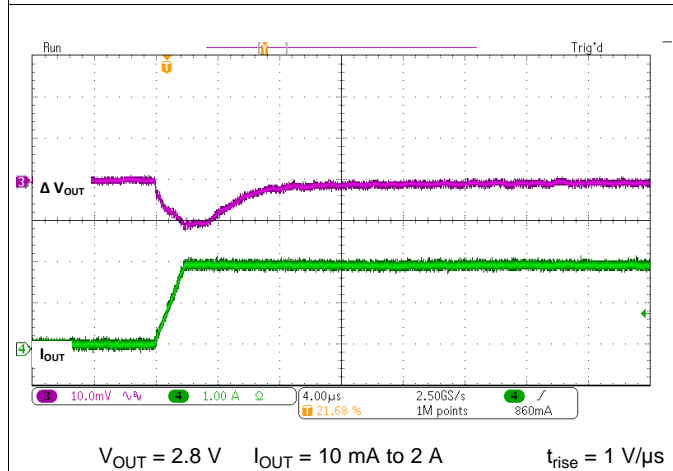

Figure 9. Load Transient Response

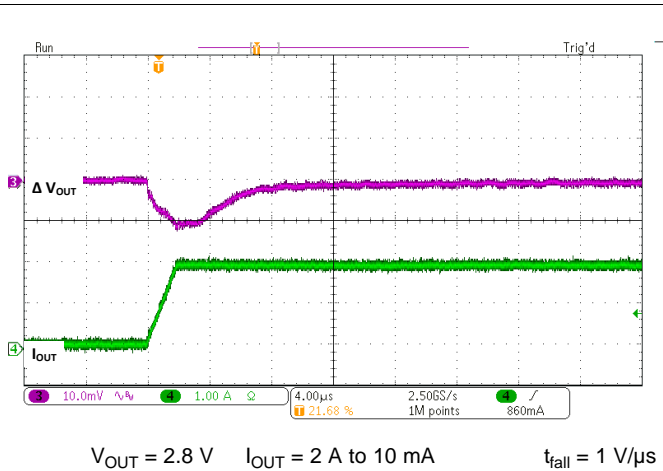

Figure 10. Load Transient Response

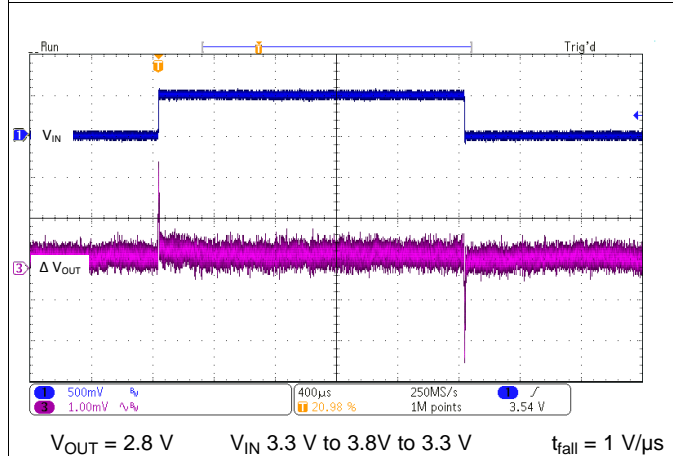

Figure 11. Line Transient Response

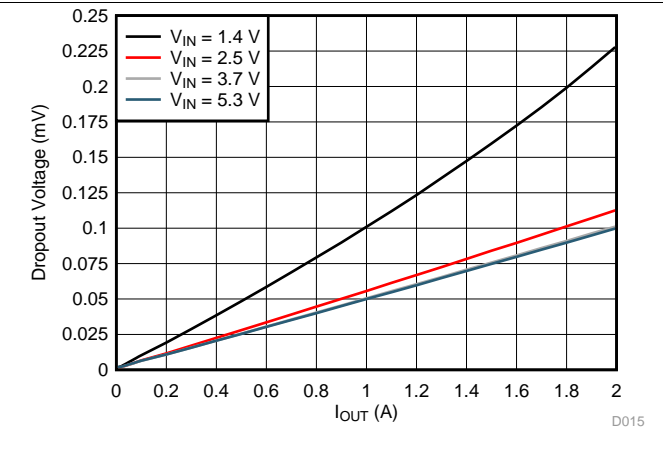
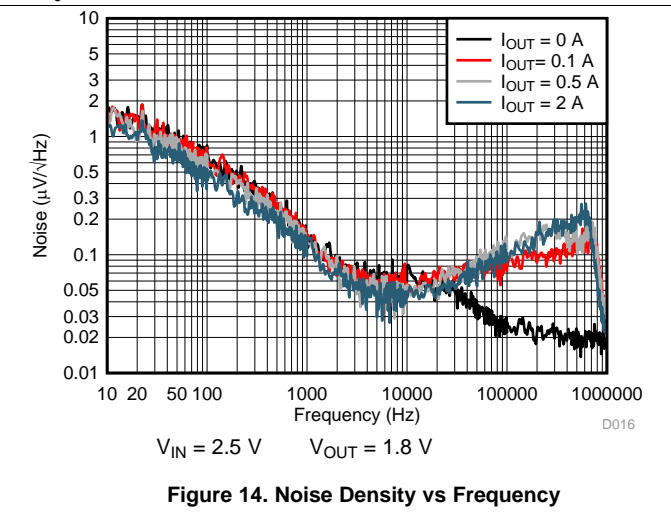
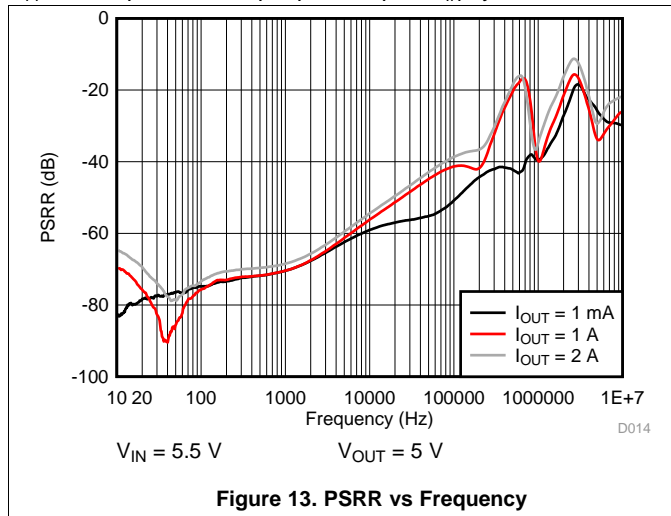

Figure 12. Dropout Voltage ( $V_{DO}$ ) vs Load Current

**Typical Characteristics (continued)**

$V_{IN} = V_{OUT} + 0.5\text{ V}$ ,  $V_{EN} = 1.2\text{ V}$ ,  $C_{IN} = 22\text{ }\mu\text{F}$ ,  $C_{OUT} = 22\text{ }\mu\text{F}$ , OUT connected to  $50\text{ }\Omega$  to GND,  $V_{FB} = 0.5\text{ V}$ ,  $C_{SS/NR} = 0.12\text{ }\mu\text{F}$ ,  $C_{FF} = 0.01\text{ }\mu\text{F}$ , and PG pin pulled up to  $V_{IN}$  by  $100\text{-k}\Omega$  resistor and  $T_J = 25^\circ\text{C}$ , unless otherwise stated.



## 7 Detailed Description

### 7.1 Overview

The LP5922 is a low-noise, high PSRR, low-dropout regulator capable of sourcing a 2-A load. The LP5922 can operate down to 1.3-V input voltage and 0.5-V output voltage. This combination of low noise, high PSRR, and low output voltage makes the device an ideal low dropout (LDO) regulator to power a multitude of loads from noise-sensitive communication components to battery-powered system.

The LP5922 block diagram contains several features, including:

- Low-noise, 0.5-V reference
- Internal protection circuit, such as current limit and thermal shutdown
- Programmable soft-start circuit
- Power Good output

### 7.2 Functional Block Diagram

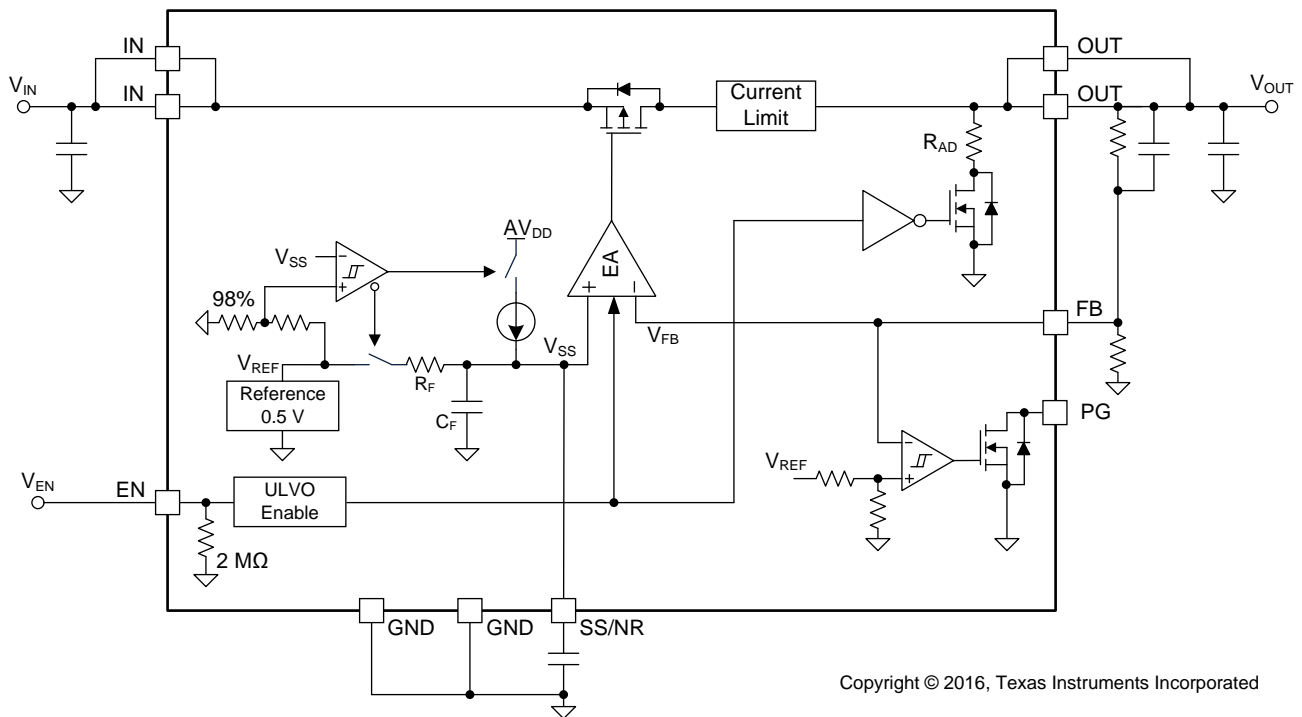

### 7.3 Feature Description

#### 7.3.1 Output Voltage

The LP5922 output voltage can be set to any value from 0.5 V to 5 V using two external resistors shown as  $R_{UPPER}$  and  $R_{LOWER}$  in Figure 15. The value for the  $R_{LOWER}$  should be less than or equal to 100 k $\Omega$  for good loop compensation.  $R_{UPPER}$  can be selected for a given  $V_{OUT}$  using Equation 1:

$$R_{UPPER} = \frac{(V_{OUT} - V_{FB}) \times R_{LOWER}}{V_{FB}}$$

where

- $V_{FB} = 0.5 \text{ V}$

(1)

## Feature Description (continued)

### 7.3.2 Enable

The LP5922 EN pin is internally held low by a 2-M $\Omega$  resistor to GND. The EN pin voltage must be higher than the  $V_{IH}$  threshold to ensure that the device is fully enabled under all operating conditions. The EN pin voltage must be lower than the  $V_{IL}$  threshold to ensure that the device is fully disabled and the automatic output discharge is activated.

### 7.3.3 Output Automatic Discharge

The LP5922 output employs an internal 400- $\Omega$  (typical) pulldown resistance to discharge the output capacitor when the EN pin is low, and the device is disabled.

### 7.3.4 Programmable Soft Start and Noise Reduction

The output voltage of LP5922 ramps up linearly in a constant slew rate until reaching the target regulating voltage after a stable  $V_{IN}$  (greater than  $V_{OUT} + V_{DO}$ ) is supplied and EN pin is pulled high. The slew rate of  $V_{OUT}$  ramping is programmable by an external capacitor on the SS/NR pin; therefore, the duration for soft-start period is programmable as well. Once the LP5922 is enabled, the SS/NR pin sources a constant 6- $\mu$ A current to charge the external  $C_{SS/NR}$  capacitor until the voltage at the SS/NR pin reaches 98% of the internal reference voltage ( $V_{REF}$ ) of 500 mV typical. The final 2% of  $C_{SS/NR}$  charge is determined by a RC time constant. During the soft-start period, the current flowing into the IN pin primarily consists of the sum of the load current at the LDO output and the charging current into the output capacitor. The soft-start period can be calculated by [Equation 2](#):

$$t_{SS} = \frac{C_{SS/NR} \times V_{FB}}{I_{SS}}$$

where

- $V_{FB} = 0.5$  V - this is the voltage that  $C_{SS/NR}$  charges to;
- $C_{SS/NR}$  is the value of the capacitor connected between the SS/NR pin and ground; and
- $I_{SS} = 6.2$   $\mu$ A is the typical charging current to the SS/NR pin during start-up period. (2)

The recommended value for  $C_{SS/NR}$  is 100 nF or larger. [Equation 2](#) is most accurate for these values. The  $C_{SS/NR}$  capacitor is also the filter capacitor for internal reference for noise reduction purpose. An integrated resistor and the  $C_{SS/NR}$  capacitor structure a RC low-pass filter to remove the noise on the internal reference voltage.

### 7.3.5 Internal Current Limit

The internal current limit circuit is used to protect the LDO against high-load current faults or shorting events. The LDO is not designed to operate in a steady-state current limit. During a current-limit event, the LDO sources constant current. Therefore, the output voltage falls when load impedance decreases. Note also that if a current limit occurs and the resulting output voltage is low, excessive power may be dissipated across the LDO, resulting in a thermal shutdown of the output.

### 7.3.6 Thermal Overload Protection

Thermal shutdown disables the output when the junction temperature rises to  $T_{SD}$  level, which allows the device to cool. When the junction temperature cools by  $\Delta T_{SD}$ , the output circuitry enables. Based on power dissipation, thermal resistance, and ambient temperature, the thermal protection circuit may cycle on and off. This thermal cycling limits the dissipation of the regulator and protects it from damage as a result of overheating.

The internal protection circuitry of the LP5922 is designed to protect against thermal overload conditions. The circuitry is not intended to replace proper heat sinking. Continuously running the LP5922 into thermal shutdown degrades device reliability.

## Feature Description (continued)

### 7.3.7 Power Good Output

The LP5922 has a Power-Good function that works by toggling the state of the PG output pin. When the output voltage falls below the PG threshold voltage ( $PG_{LTH}$ ), the PG pin open-drain output engages (low impedance to GND). When the output voltage rises above the PG threshold voltage ( $PG_{HTH}$ ), the PG pin becomes high-impedance. By connecting a pullup resistor to an external supply, any downstream device can receive PG as a logic signal. User must make sure that the external pullup supply voltage results in a valid logic signal for the receiving device or devices; use a pullup resistor from 10 k $\Omega$  to 100 k $\Omega$  for best results.

In Power-Good function, the PG output pin pulled high immediately after output voltage rises above the PG threshold voltage.

## 7.4 Device Functional Modes

### 7.4.1 Enable (EN)

The LP5922 enable (EN) pin is internally held low by a 2-M $\Omega$  resistor to GND. If the EN pin is open the output is OFF. The EN pin voltage must be higher than the  $V_{IH}$  threshold to ensure that the device is fully enabled under all operating conditions. When the EN pin is pulled low, and the output is disabled, the output automatic discharge circuit is activated. Any charge on the OUT pin is discharged to GND through the internal pulldown resistance.

### 7.4.2 Undervoltage Lockout (UVLO)

The LP5922 incorporates UVLO. The UVLO circuit monitors the input voltage and keeps the LP5922 disabled while a rising  $V_{IN}$  is less than 1.2 V (typical). The rising UVLO threshold is approximately 100 mV below the recommended minimum operating  $V_{IN}$  of 1.3 V.

### 7.4.3 Minimum Operating Input Voltage

The LP5922 internal circuit is not fully functional until  $V_{IN}$  is at least 1.3 V. The output voltage is not regulated until  $V_{IN}$  has reached at least the greater of 1.3 V or ( $V_{OUT} + V_{DO}$ ).

## 8 Applications and Implementation

### NOTE

Information in the following applications sections is not part of the TI component specification, and TI does not warrant its accuracy or completeness. TI's customers are responsible for determining suitability of components for their purposes. Customers should validate and test their design implementation to confirm system functionality.

### 8.1 Application Information

The LP5922 is designed to meet the requirements of RF and analog circuits, by providing low noise, high PSRR, low quiescent current, and low line or load transient response figures. The device offers excellent noise performance without the need for a noise bypass capacitor and is stable with input and output capacitors with a value of 22  $\mu\text{F}$ . The LP5922 delivers this performance in an industry-standard WSON package which, for this device, is specified with an operating junction temperature ( $T_J$ ) of  $-40^\circ\text{C}$  to  $+125^\circ\text{C}$ .

### 8.2 Typical Application

Figure 15 shows the typical application circuit for the LP5922. Input and output capacitances may need to be increased above 22  $\mu\text{F}$  minimum for some applications.

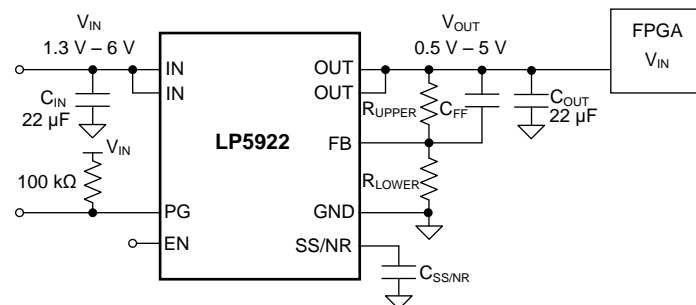

Copyright © 2016, Texas Instruments Incorporated

**Figure 15. LP5922 Typical Application**

#### 8.2.1 Design Requirements

For typical LP5922 applications, use the parameters listed in Table 1.

**Table 1. Design Parameters**

DESIGN PARAMETER	EXAMPLE VALUE
Input voltage	2.25 V to 2.75 V
Output voltage	1.8 V
Output current	2000 mA
Output capacitor range	22 $\mu\text{F}$ to 47 $\mu\text{F}$
Output capacitor ESR range	2 m $\Omega$ to 500 m $\Omega$

## 8.2.2 Detailed Design Procedure

### 8.2.2.1 External Capacitors

The LP5922 is designed to be stable using low equivalent series resistance (ESR) ceramic capacitors at the input, output, and the noise-reduction pin (SS/NR). Multilayer ceramic capacitors have become the industry standard for these types of applications and are recommended, but must be used with good judgment. Ceramic capacitors that employ X7R-, X5R-, and COG-rated dielectric materials provide relatively good capacitive stability across temperature, whereas the use of Y5V-rated capacitors is discouraged because of large variations in capacitance. Additionally, the case size has a direct impact on the capacitance versus applied voltage derating.

Regardless of the ceramic capacitor type selected, the actual capacitance varies with the applied operating voltage and temperature. As a rule of thumb, derate ceramic capacitors by at least 50%. The input and output capacitors recommended herein account for a effective capacitance derating of approximately 50%, but at high applied voltage conditions the capacitance derating can be greater than 50% and must be taken into consideration. The minimum capacitance values declared in [Input and Output Capacitors](#) must be met across the entire expected operating voltage range and temperature range.

#### 8.2.2.2 Input Capacitor, $C_{IN}$

An input capacitor is required for stability. A capacitor with a value of at least 22  $\mu\text{F}$  must be connected between the LP5922 IN pin and ground for stable operation over full load current range. It is acceptable to have more output capacitance than input, as long as the input is at least 22  $\mu\text{F}$ .

The input capacitor must be located as close as possible to, but at a distance not more than 1 cm from, the IN pin and returned to the device GND pin with a clean analog ground. This will minimize the trace inductance between the capacitor and the device. Any good quality ceramic or tantalum capacitor may be used at the input.

#### 8.2.2.3 Output Capacitor, $C_{OUT}$

The LP5922 is designed to work specifically with a low ESR ceramic (MLCC) output capacitor, typically 22  $\mu\text{F}$ . A ceramic capacitor (dielectric types X5R or X7R) in the 22- $\mu\text{F}$  to 100- $\mu\text{F}$  range, with an ESR not exceeding 500 m $\Omega$ , is suitable in the LP5922 application circuit having an output voltage greater than 0.8 V. For output voltages of 0.8 V or less, the output capacitance must be increased to typically 47  $\mu\text{F}$ . The output capacitor must be connected between the device OUT and GND pins. The output capacitor must meet the requirement for the minimum value of capacitance and have an ESR value that does not exceed 500 m $\Omega$  to ensure stability.

It is possible to use tantalum capacitors at the device output, but these are not as attractive for reasons of size, cost, and performance.

A combination of multiple output capacitors in parallel boosts the high-frequency PSRR. The combination of one 0805-sized, 47- $\mu\text{F}$  ceramic capacitor in parallel with two 0805-sized, 10- $\mu\text{F}$  ceramic capacitors with a sufficient voltage rating optimizes PSRR response in the frequency range of 400 kHz to 700 kHz (which is a typical range for dc-dc supply switching frequency). This 47- $\mu\text{F}$  || 10- $\mu\text{F}$  || 10- $\mu\text{F}$  combination also ensures that at high input voltage and high output voltage configurations, the minimum effective capacitance is met. Many 0805-sized, 47- $\mu\text{F}$  ceramic capacitors have a voltage derating of approximately 60% to 75% at 5 V, so the addition of the two 10- $\mu\text{F}$  capacitors ensures that the capacitance is at or above 22  $\mu\text{F}$ .

#### 8.2.2.4 Soft-Start and Noise-Reduction Capacitor, $C_{SS/NR}$

Recommended value for  $C_{SS/NR}$  is 100 nF or larger. The soft-start period can be calculated by [Equation 2](#). The  $C_{SS/NR}$  capacitor is also the filter capacitor for internal reference for noise reduction purpose.

#### 8.2.2.5 Feed-Forward Capacitor, $C_{FF}$

Although a feed-forward capacitor ( $C_{FF}$ ) from the FB pin to the OUT pin is not required to achieve stability, a 10-nF external  $C_{FF}$  optimizes the transient, noise, and PSRR performance. A higher capacitance  $C_{FF}$  value can be used; however, the start-up time may be longer and the Power-Good signal may incorrectly indicate that the output voltage is settled. The maximum recommended value is 100 nF

To ensure proper PGx functionality, the time constant defined by CNR/SSx must be greater than or equal to the time constant from CFFx. For a detailed description, see the application report [Pros and Cons of Using a Feed-Forward Capacitor with a Low Dropout Regulator](#) (SBVA042).

### 8.2.2.6 No-Load Stability

The LP5922 remains stable, and in regulation, with no external load.

### 8.2.2.7 Power Dissipation

Knowing the device power dissipation and proper sizing of the thermal plane connected to the exposed thermal pad is critical to ensuring reliable operation. Device power dissipation depends on input voltage, output voltage, and load conditions and can be calculated with [Equation 3](#).

$$P_{D(MAX)} = (V_{IN(MAX)} - V_{OUT}) \times I_{OUT} \quad (3)$$

Power dissipation can be minimized, and greater efficiency can be achieved, by using the lowest available voltage drop option that is greater than the dropout voltage ( $V_{DO}$ ). However, keep in mind that higher voltage drops result in better dynamic (that is, PSRR and transient) performance.

On the WSON (DSC) package, the primary conduction path for heat is through the exposed thermal pad into the PCB. To ensure the device does not overheat, connect the exposed thermal pad, through multiple thermal vias, to an internal ground plane with an appropriate amount of PCB copper area.

Power dissipation and junction temperature are most often related by the junction-to-ambient thermal resistance ( $R_{\theta JA}$ ) of the combined PCB and device package and the temperature of the ambient air ( $T_A$ ), according to [Equation 4](#) or [Equation 5](#):

$$T_{J(MAX)} = T_{A(MAX)} + (R_{\theta JA} \times P_{D(MAX)}) \quad (4)$$

$$P_D = (T_{J(MAX)} - T_{A(MAX)}) / R_{\theta JA} \quad (5)$$

If the  $V_{IN}$ - $V_{OUT}$  voltage is known, the maximum allowable output current can be calculated with [Equation 6](#)

$$I_{OUT(MAX)} = ((125^\circ\text{C} - T_A) / R_{\theta JA}) / (V_{IN} - V_{OUT}) \quad (6)$$

Unfortunately, the  $R_{\theta JA}$  value is highly dependent on the heat-spreading capability of the particular PCB design, and therefore varies according to the PCB size, total copper area, copper weight, any thermal vias, and location of the planes. The  $R_{\theta JA}$  recorded in [Thermal Information](#) is determined by the specific EIA/JEDEC JESD51-7 standard for PCB and copper spreading area, and is to be used only as a relative measure of package thermal performance. For a well designed thermal layout,  $R_{\theta JA}$  is actually the sum of the package junction-to-case (bottom) thermal resistance ( $R_{\theta JC(bot)}$ ) plus the thermal resistance contribution by the PCB copper area acting as a heat sink.

### 8.2.2.8 Estimating Junction Temperature

The JEDEC standard now recommends the use of psi ( $\Psi$ ) thermal metrics to estimate the junction temperatures of the LDO when in-circuit on a typical PCB board application. These metrics are not strictly speaking thermal resistances, but rather offer practical and relative means of estimating junction temperatures. These psi metrics are determined to be significantly independent of the copper-spreading area. The key thermal metrics ( $\Psi_{JT}$  and  $\Psi_{JB}$ ) are given in the [Thermal Information](#) table and are used in accordance with [Equation 7](#) and [Equation 8](#).

$$T_{J(MAX)} = T_{TOP} + (\Psi_{JT} \times P_{D(MAX)})$$

where

- $T_{TOP}$  is the temperature measured at the center-top of the device package.

- $P_{D(MAX)}$  is described at [Equation 3](#) (7)

$$T_{J(MAX)} = T_{BOARD} + (\Psi_{JB} \times P_{D(MAX)})$$

where

- $T_{BOARD}$  is the PCB surface temperature measured 1 mm from the device package and centered on the package edge.

- $P_{D(MAX)}$  is described at [Equation 3](#) (8)

For more information about the thermal characteristics  $\Psi_{JT}$  and  $\Psi_{JB}$ , see [Semiconductor and IC Package Thermal Metrics](#); for more information about measuring  $T_{TOP}$  and  $T_{BOARD}$ , see [Using New Thermal Metrics](#); and for more information about the EIA/JEDEC JESD51 PCB used for validating  $R_{\theta JA}$ , see the [TI Application Report Thermal Characteristics of Linear and Logic Packages Using JEDEC PCB Designs](#). These application notes are available at [www.ti.com](http://www.ti.com).

### 8.2.2.9 Recommended Continuous Operating Area

The continuous operational area of an LDO is limited by the input voltage ( $V_{IN}$ ), the output voltage ( $V_{OUT}$ ), the dropout voltage ( $V_{DO}$ ), the output current ( $I_{OUT}$ ), and the junction temperature ( $T_J$ ). The recommended area for continuous operation for a linear regulator can be separated into the following steps, and is shown in [Figure 16](#).

- Limited by dropout: Dropout voltage limits the minimum differential voltage between the input and the output ( $V_{IN} - V_{OUT}$ ) at a given output current level.
- Limited by the rated output current: The rated output current limits the maximum recommended output current level. Exceeding this rating causes the device to fall out of specification.
- Limited by thermals: This portion of the boundary is defined by [Equation 6](#). The slope is nonlinear because the junction temperature of the LDO is controlled by the power dissipation ( $P_D$ ) across the LDO; therefore, when  $V_{IN} - V_{OUT}$  increases, the output current must decrease in order to ensure that the rated maximum operating junction temperature of the device is not exceeded. Exceeding the maximum operating junction temperature rating can cause the device to fall out of specifications, reduces long-term reliability, and may activate the thermal shutdown protection circuitry.
- Limited by  $V_{IN}$  range: The rated operating input voltage range governs both the minimum and maximum of  $V_{IN} - V_{OUT}$ .

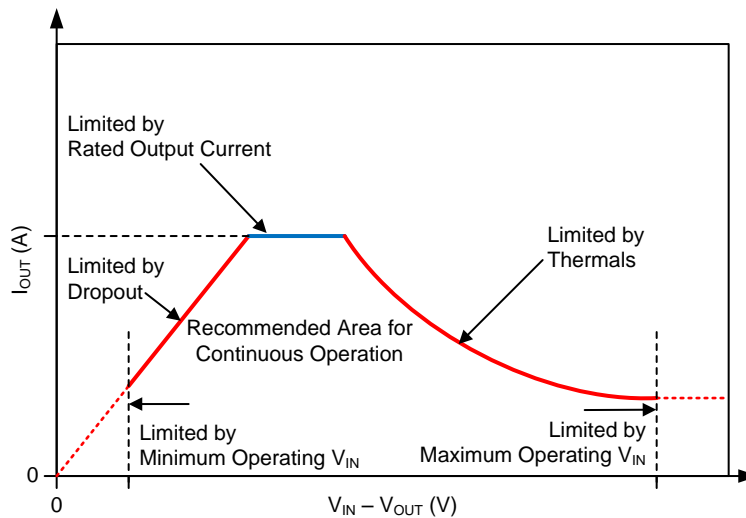

**Figure 16. Recommended Continuous Operating Area**

[Figure 17](#) to [Figure 22](#) show the recommended continuous operating area boundaries for this device in the WSON (DSC) package mounted to a EIA/JEDEC High-K printed circuit board, as defined by JESD51-7, with an  $R_{\theta JA}$  rating of 49.5°C/W.

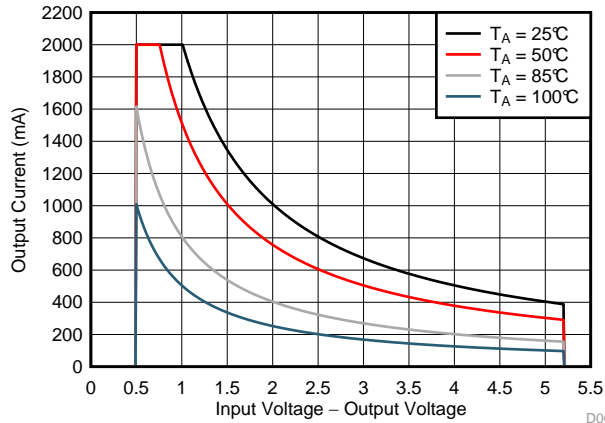

Figure 17. Recommended Continuous Operating Area for  $V_{OUT} = 0.8\text{ V}$

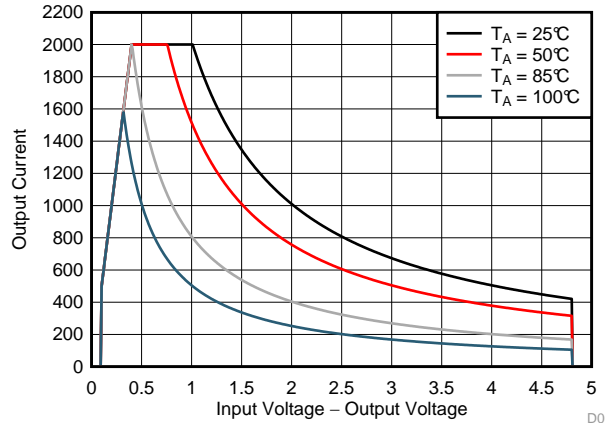

Figure 18. Recommended Continuous Operating Area for  $V_{OUT} = 1.2\text{ V}$

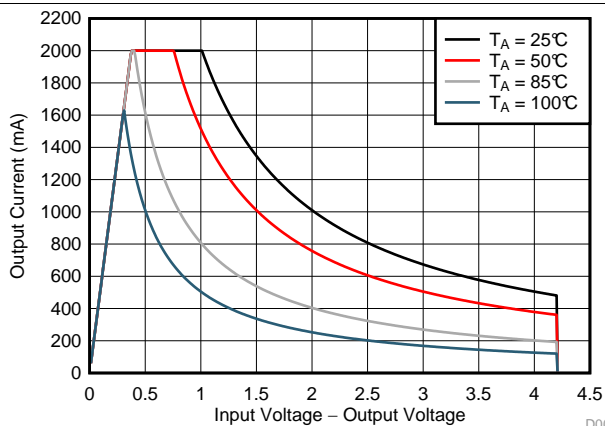

Figure 19. Recommended Continuous Operating Area for  $V_{OUT} = 1.8\text{ V}$

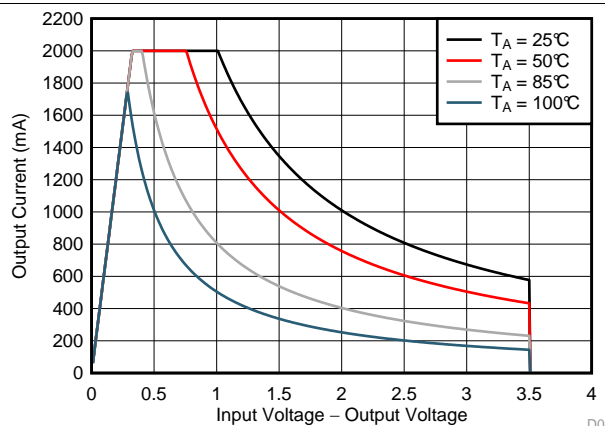

Figure 20. Recommended Continuous Operating Area for  $V_{OUT} = 2.5\text{ V}$

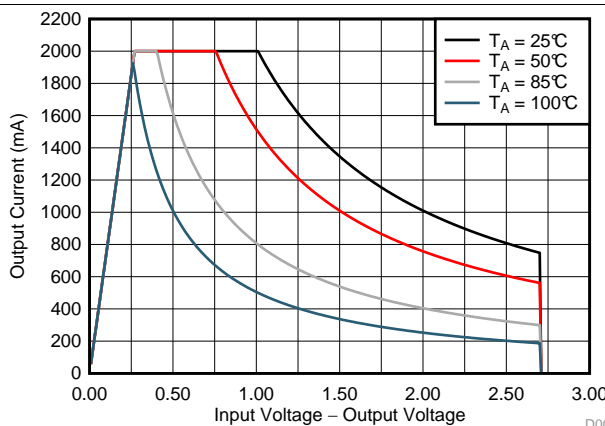

Figure 21. Recommended Continuous Operating Area for  $V_{OUT} = 3.3\text{ V}$

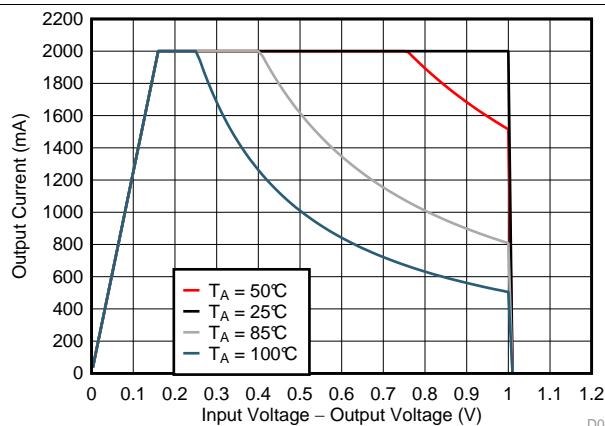
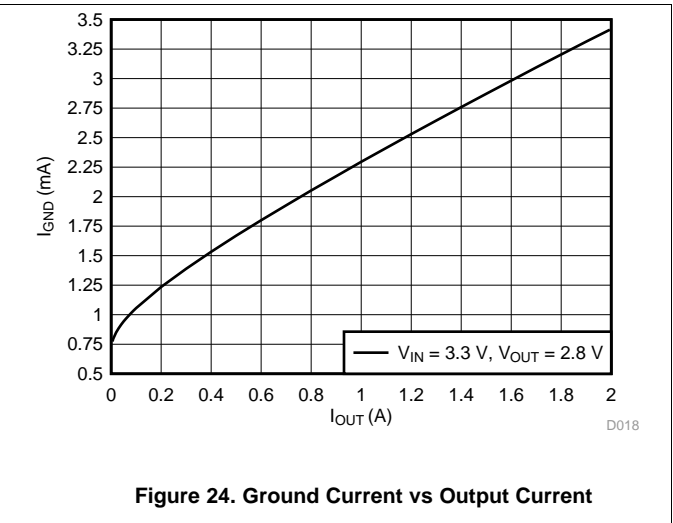
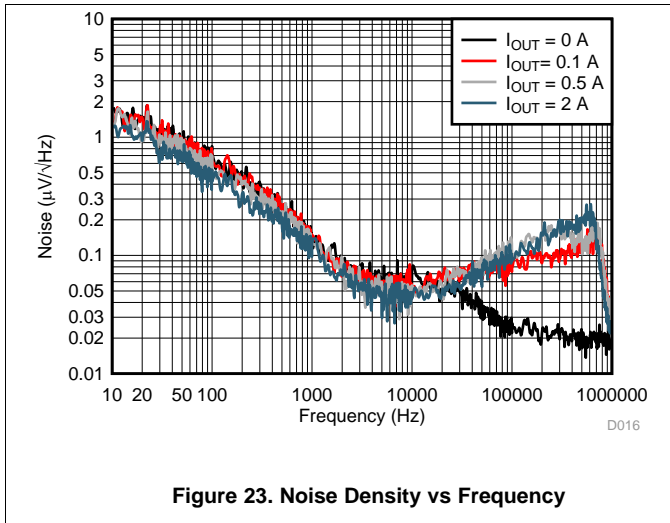

Figure 22. Recommended Continuous Operating Area for  $V_{OUT} = 5\text{ V}$

### 8.2.3 Application Curves



## 9 Power Supply Recommendations

This device is designed to operate from an input supply voltage range of 1.3 V to 6 V. The input supply should be well regulated and free of spurious noise. To ensure that the LP5922 output voltage is well regulated and dynamic performance is optimum, the input supply must be at least  $V_{OUT} + 1$  V. A minimum capacitor value of 22  $\mu$ F is required to be within 1 cm of the IN pin.

## 10 Layout

### 10.1 Layout Guidelines

The dynamic performance of the LP5922 is dependant on the layout of the PCB. PCB layout practices that are adequate for typical LDOs may degrade the PSRR, noise, or transient performance of the LP5922.

Best performance is achieved by placing  $C_{IN}$  and  $C_{OUT}$  on the same side of the PCB as the LP5922 device, and as close as is practical to the package. The ground connections for  $C_{IN}$  and  $C_{OUT}$  must be back to the LP5922 GND pin using as wide and as short of a copper trace as is practical.

Avoid connections using long trace lengths, narrow trace widths, or connections through vias. These add parasitic inductances and resistance that results in inferior performance especially during transient conditions

### 10.2 Layout Example

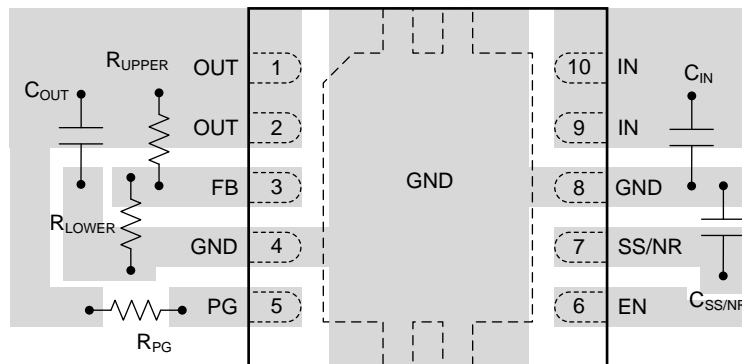

**Figure 25. LP5922 Typical Layout**

## 11 器件和文档支持

### 11.1 相关文档

更多信息，请参见以下文档：

- 《使用热指标》
- 《采用 JEDEC PCB 设计的线性和逻辑封装散热特性》

### 11.2 接收文档更新通知

如需接收文档更新通知，请访问 [www.ti.com.cn](http://www.ti.com.cn) 网站上的器件产品文件夹。点击右上角的提醒我 (Alert me) 注册后，即可每周定期收到已更改的产品信息。有关更改的详细信息，请查阅已修订文档中包含的修订历史记录。

### 11.3 社区资源

The following links connect to TI community resources. Linked contents are provided "AS IS" by the respective contributors. They do not constitute TI specifications and do not necessarily reflect TI's views; see TI's [Terms of Use](#).

**TI E2E™ Online Community** *TI's Engineer-to-Engineer (E2E) Community*. Created to foster collaboration among engineers. At [e2e.ti.com](http://e2e.ti.com), you can ask questions, share knowledge, explore ideas and help solve problems with fellow engineers.

**Design Support** *TI's Design Support* Quickly find helpful E2E forums along with design support tools and contact information for technical support.

### 11.4 商标

E2E is a trademark of Texas Instruments.

All other trademarks are the property of their respective owners.

### 11.5 静电放电警告



ESD 可能会损坏该集成电路。德州仪器 (TI) 建议通过适当的预防措施处理所有集成电路。如果不遵守正确的处理措施和安装程序，可能会损坏集成电路。

ESD 的损坏小至导致微小的性能降级，大至整个器件故障。精密的集成电路可能更容易受到损坏，这是因为非常细微的参数更改都可能会导致器件与其发布的规格不相符。

### 11.6 Glossary

[SLYZ022](#) — *TI Glossary*.

This glossary lists and explains terms, acronyms, and definitions.

## 12 机械、封装和可订购信息

以下页中包括机械、封装和可订购信息。这些信息是针对指定器件可提供的最新数据。这些数据会在无通知且不对本文档进行修订的情况下发生改变。欲获得该数据表的浏览器版本，请查阅左侧的导航栏。

## PACKAGING INFORMATION

Orderable part number	Status (1)	Material type (2)	Package   Pins	Package qty   Carrier	RoHS (3)	Lead finish/ Ball material (4)	MSL rating/ Peak reflow (5)	Op temp (°C)	Part marking (6)
LP592201DSCR	NRND	Production	WSON (DSC)   10	3000   LARGE T&R	Yes	NIPDAU	Level-1-260C-UNLIM	-40 to 125	592201
LP592201DSCR.A	NRND	Production	WSON (DSC)   10	3000   LARGE T&R	Yes	NIPDAU	Level-1-260C-UNLIM	-40 to 125	592201
<a href="#">LP592201DSCT</a>	NRND	Production	WSON (DSC)   10	250   SMALL T&R	Yes	NIPDAU	Level-1-260C-UNLIM	-40 to 125	592201
LP592201DSCT.A	NRND	Production	WSON (DSC)   10	250   SMALL T&R	Yes	NIPDAU	Level-1-260C-UNLIM	-40 to 125	592201

(1) **Status:** For more details on status, see our [product life cycle](#).

(2) **Material type:** When designated, preproduction parts are prototypes/experimental devices, and are not yet approved or released for full production. Testing and final process, including without limitation quality assurance, reliability performance testing, and/or process qualification, may not yet be complete, and this item is subject to further changes or possible discontinuation. If available for ordering, purchases will be subject to an additional waiver at checkout, and are intended for early internal evaluation purposes only. These items are sold without warranties of any kind.

(3) **RoHS values:** Yes, No, RoHS Exempt. See the [TI RoHS Statement](#) for additional information and value definition.

(4) **Lead finish/Ball material:** Parts may have multiple material finish options. Finish options are separated by a vertical ruled line. Lead finish/Ball material values may wrap to two lines if the finish value exceeds the maximum column width.

(5) **MSL rating/Peak reflow:** The moisture sensitivity level ratings and peak solder (reflow) temperatures. In the event that a part has multiple moisture sensitivity ratings, only the lowest level per JEDEC standards is shown. Refer to the shipping label for the actual reflow temperature that will be used to mount the part to the printed circuit board.

(6) **Part marking:** There may be an additional marking, which relates to the logo, the lot trace code information, or the environmental category of the part.

Multiple part markings will be inside parentheses. Only one part marking contained in parentheses and separated by a "~" will appear on a part. If a line is indented then it is a continuation of the previous line and the two combined represent the entire part marking for that device.

**Important Information and Disclaimer:** The information provided on this page represents TI's knowledge and belief as of the date that it is provided. TI bases its knowledge and belief on information provided by third parties, and makes no representation or warranty as to the accuracy of such information. Efforts are underway to better integrate information from third parties. TI has taken and continues to take reasonable steps to provide representative and accurate information but may not have conducted destructive testing or chemical analysis on incoming materials and chemicals. TI and TI suppliers consider certain information to be proprietary, and thus CAS numbers and other limited information may not be available for release.

In no event shall TI's liability arising out of such information exceed the total purchase price of the TI part(s) at issue in this document sold by TI to Customer on an annual basis.

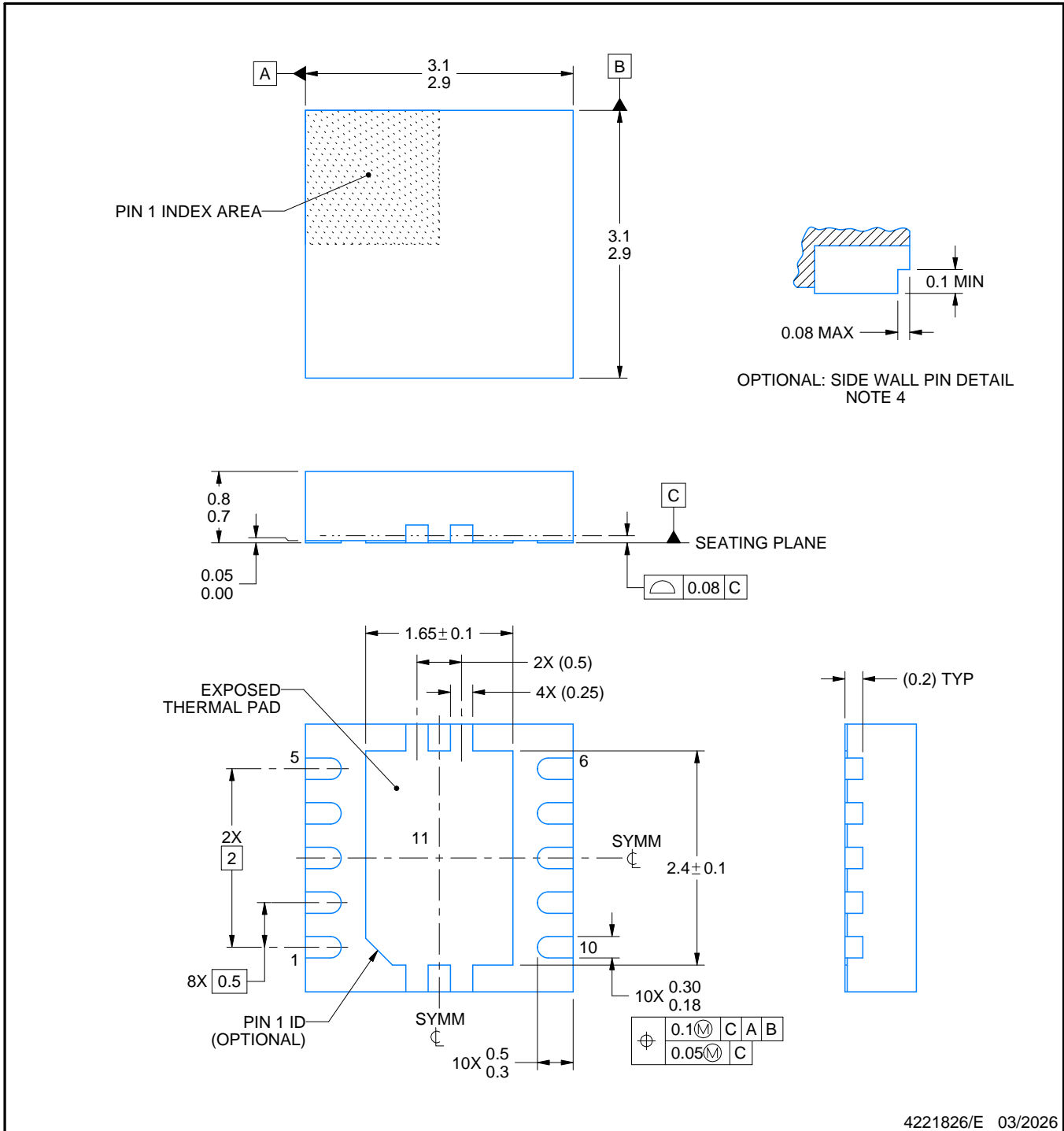
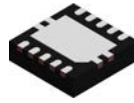

4221826/E 03/2026

NOTES:

1. All linear dimensions are in millimeters. Any dimensions in parenthesis are for reference only. Dimensioning and tolerancing per ASME Y14.5M.
2. This drawing is subject to change without notice.
3. The package thermal pad must be soldered to the printed circuit board for optimal thermal and mechanical performance.
4. Minimum 0.1 mm solder wetting on pin side wall. Available for wettable flank version only.

# EXAMPLE BOARD LAYOUT

DSC0010J

WSON - 0.8 mm max height

PLASTIC SMALL OUTLINE - NO LEAD

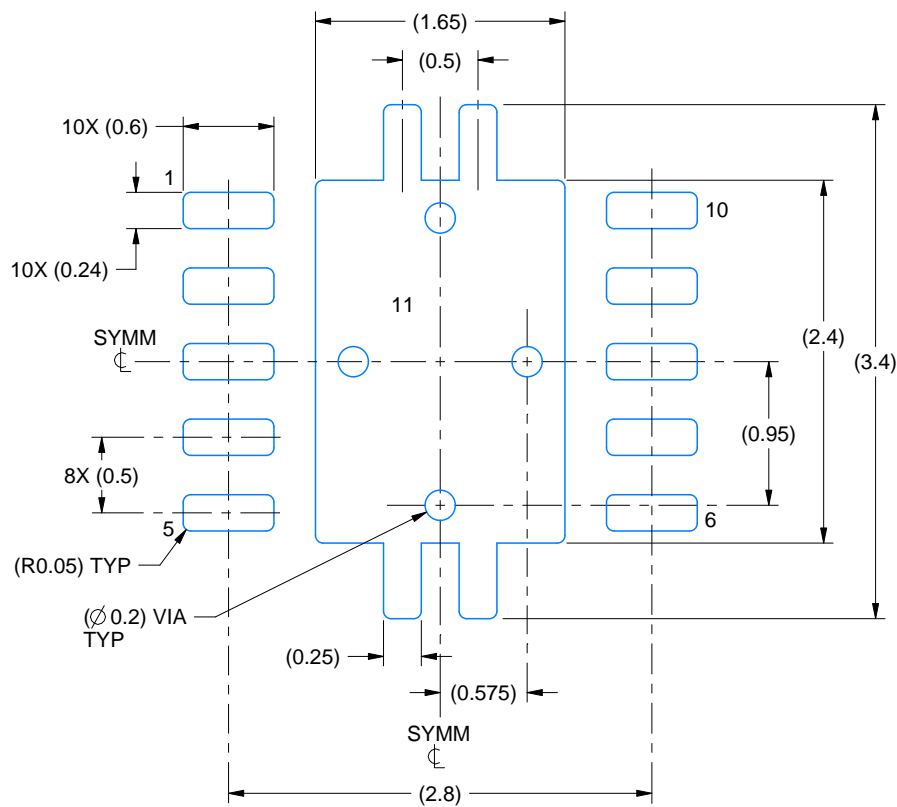

LAND PATTERN EXAMPLE  
EXPOSED METAL SHOWN  
SCALE:20X

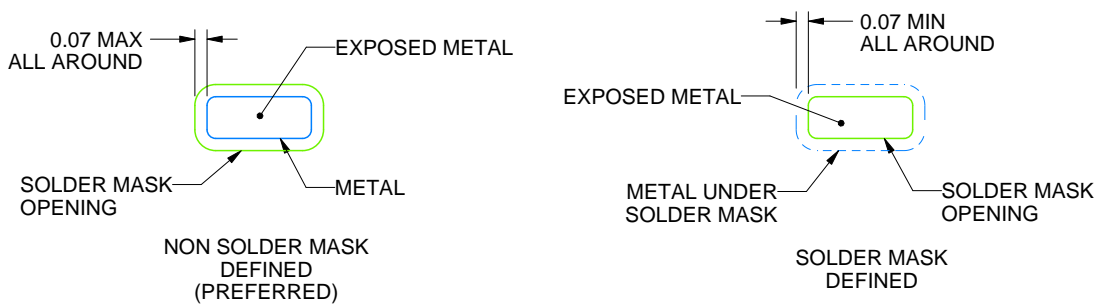

SOLDER MASK DETAILS

4221826/E 03/2026

NOTES: (continued)

5. This package is designed to be soldered to a thermal pad on the board. For more information, see Texas Instruments literature number SLUA271 ([www.ti.com/lit/sluea271](http://www.ti.com/lit/sluea271)).
6. Vias are optional depending on application, refer to device data sheet. If any vias are implemented, refer to their locations shown on this view. It is recommended that vias under paste be filled, plugged or tented.

# EXAMPLE STENCIL DESIGN

DSC0010J

WSON - 0.8 mm max height

PLASTIC SMALL OUTLINE - NO LEAD

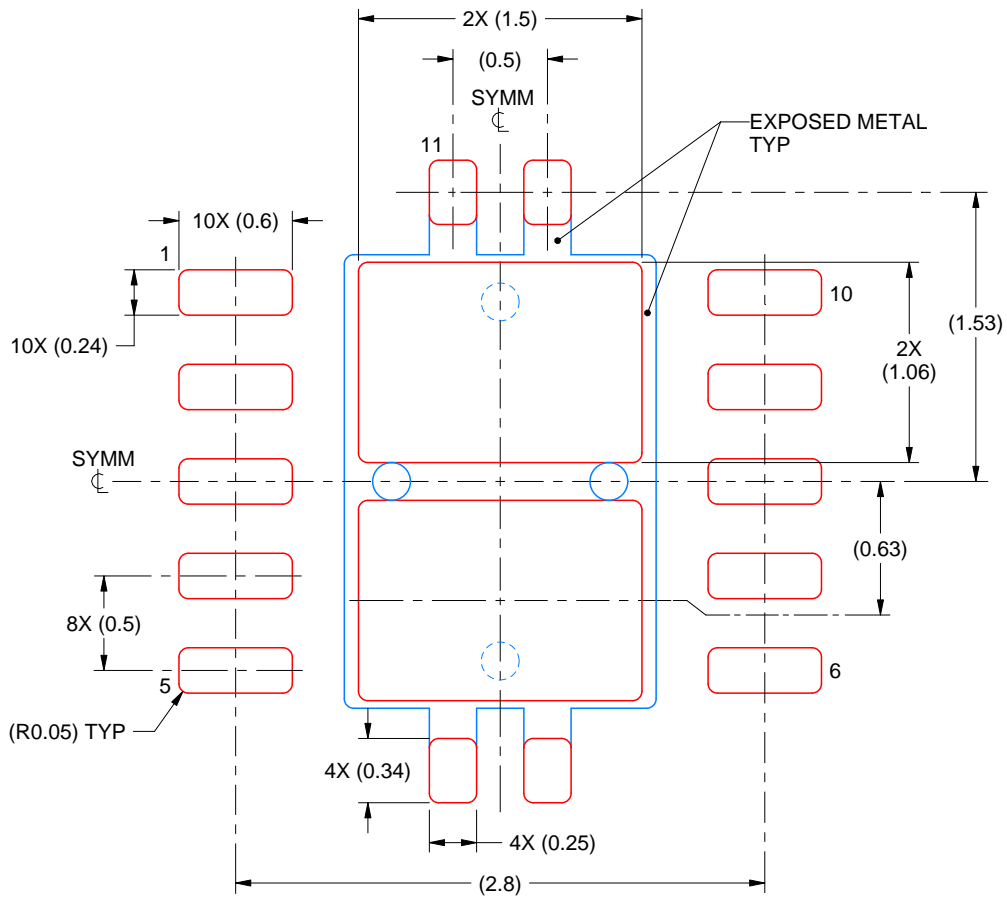

SOLDER PASTE EXAMPLE  
BASED ON 0.125 mm THICK STENCIL

EXPOSED PAD 11:  
80% PRINTED SOLDER COVERAGE BY AREA  
SCALE:25X

4221826/E 03/2026

NOTES: (continued)

7. Laser cutting apertures with trapezoidal walls and rounded corners may offer better paste release. IPC-7525 may have alternate design recommendations.

## 重要通知和免责声明

TI“按原样”提供技术和可靠性数据（包括数据表）、设计资源（包括参考设计）、应用或其他设计建议、网络工具、安全信息和其他资源，不保证没有瑕疵且不做任何明示或暗示的担保，包括但不限于对适销性、与某特定用途的适用性或不侵犯任何第三方知识产权的暗示担保。

这些资源可供使用 TI 产品进行设计的熟练开发人员使用。您将自行承担以下全部责任：(1) 针对您的应用选择合适的 TI 产品，(2) 设计、验证并测试您的应用，(3) 确保您的应用满足相应标准以及任何其他安全、安保法规或其他要求。

这些资源如有变更，恕不另行通知。TI 授权您仅可将这些资源用于研发本资源所述的 TI 产品的相关应用。严禁以其他方式对这些资源进行复制或展示。您无权使用任何其他 TI 知识产权或任何第三方知识产权。对于因您对这些资源的使用而对 TI 及其代表造成的任何索赔、损害、成本、损失和债务，您将全额赔偿，TI 对此概不负责。

TI 提供的产品受 [TI 销售条款](#)、[TI 通用质量指南](#) 或 [ti.com](#) 上其他适用条款或 TI 产品随附的其他适用条款的约束。TI 提供这些资源并不会扩展或以其他方式更改 TI 针对 TI 产品发布的适用的担保或担保免责声明。除非德州仪器 (TI) 明确将某产品指定为定制产品或客户特定产品，否则其产品均为按确定价格收入目录的标准通用器件。

TI 反对并拒绝您可能提出的任何其他或不同的条款。

版权所有 © 2026，德州仪器 (TI) 公司

最后更新日期：2025 年 10 月