

## 24-BIT STEREO AUDIO CODEC WITH 96-kHz ADC, 192-kHz DAC, AND SINGLE-ENDED ANALOG INPUT/OUTPUT

### FEATURES

- 24-Bit Delta-Sigma ADC and DAC
- Stereo ADC:
  - Single-Ended Voltage Input: 3 V<sub>p-p</sub>
  - Antialiasing Filter Included
  - 1/128, 1/64 Decimation Filter:
    - Pass-Band Ripple: ±0.05 dB
    - Stop-Band Attenuation: –65 dB
  - On-Chip High-Pass Filter: 0.84 Hz at f<sub>S</sub> = 44.1 kHz
  - High Performance:
    - THD+N: –95 dB (Typical)
    - SNR: 100 dB (Typical)
    - Dynamic Range: 102 dB (Typical)
- Stereo DAC:
  - Single-Ended Voltage Output: 3 V<sub>p-p</sub>
  - Analog Low-Pass Filter Included
  - ×8 Oversampling Digital Filter:
    - Pass-Band Ripple: ±0.03 dB
    - Stop-Band Attenuation: –50 dB
  - High Performance:
    - THD+N: –96 dB (Typical)
    - SNR: 104 dB (Typical)
    - Dynamic Range: 104 dB (Typical)
- Multiple Functions:
  - Digital De-Emphasis: 32 kHz, 44.1 kHz, 48 kHz
  - Power Down: ADC/DAC Simultaneous
  - 16-, 24-Bit Audio Data Formats
- Sampling Rate: 16–96 kHz (ADC), 16–192 kHz (DAC)

- System Clock: 128 f<sub>S</sub>, 192 f<sub>S</sub>, 256 f<sub>S</sub>, 384 f<sub>S</sub>, 512 f<sub>S</sub>, 768 f<sub>S</sub>
- Dual Power Supplies: 5 V for Analog and 3.3 V for Digital
- Package: 24-Pin SSOP, Lead-Free Product

### APPLICATIONS

- DVD Recorders
- CD Recorders
- PC Audio
- Sound Control System

### DESCRIPTION

The PCM3010 is a low-cost single-chip 24-, 16-bit stereo audio codec (ADC and DAC) with single-ended analog voltage input and output. Both the analog-to-digital converters (ADCs) and digital-to-analog converters (DACs) employ delta-sigma modulation with 64-times oversampling. The ADCs include a digital decimation filter with a high-pass filter, and the DACs include an 8-times-oversampling digital interpolation filter. The DACs also include a digital de-emphasis function. The PCM3010 accepts four different audio data formats for the ADC and DAC. The PCM3010 provides a power-down mode, which works on the ADC and DAC simultaneously. The PCM3010 is suitable for a wide variety of cost-sensitive consumer applications where good performance is required. The PCM3010 is fabricated using a highly advanced CMOS process and is available in a small 24-pin SSOP package.



This integrated circuit can be damaged by ESD. Texas Instruments recommends that all integrated circuits be handled with appropriate precautions. Failure to observe proper handling and installation procedures can cause damage.

ESD damage can range from subtle performance degradation to complete device failure. Precision integrated circuits may be more susceptible to damage because very small parametric changes could cause the device not to meet its published specifications.



Please be aware that an important notice concerning availability, standard warranty, and use in critical applications of Texas Instruments semiconductor products and disclaimers thereto appears at the end of this data sheet.

# PCM3010

SLES055 – NOVEMBER 2002

## DB PACKAGE (TOP VIEW)

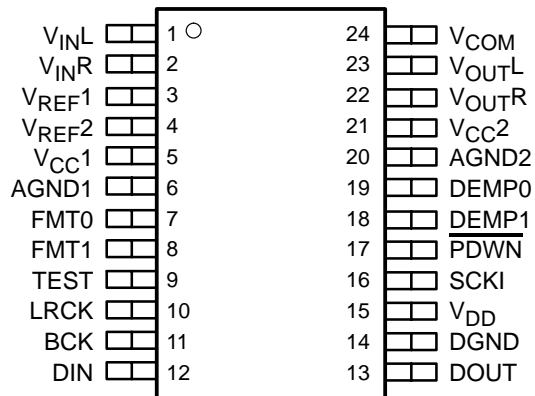

## PACKAGE/ORDERING INFORMATION

PRODUCT	PACKAGE	PACKAGE CODE	OPERATION TEMPERATURE RANGE	PACKAGE MARKING	ORDERING NUMBER	TRANSPORT MEDIA
PCM3010DB	24-lead SSOP	24DB	-25°C to 85°C	PCM3010	PCM3010DB	Tube
					PCM3010DBR	Tape and reel

block diagram

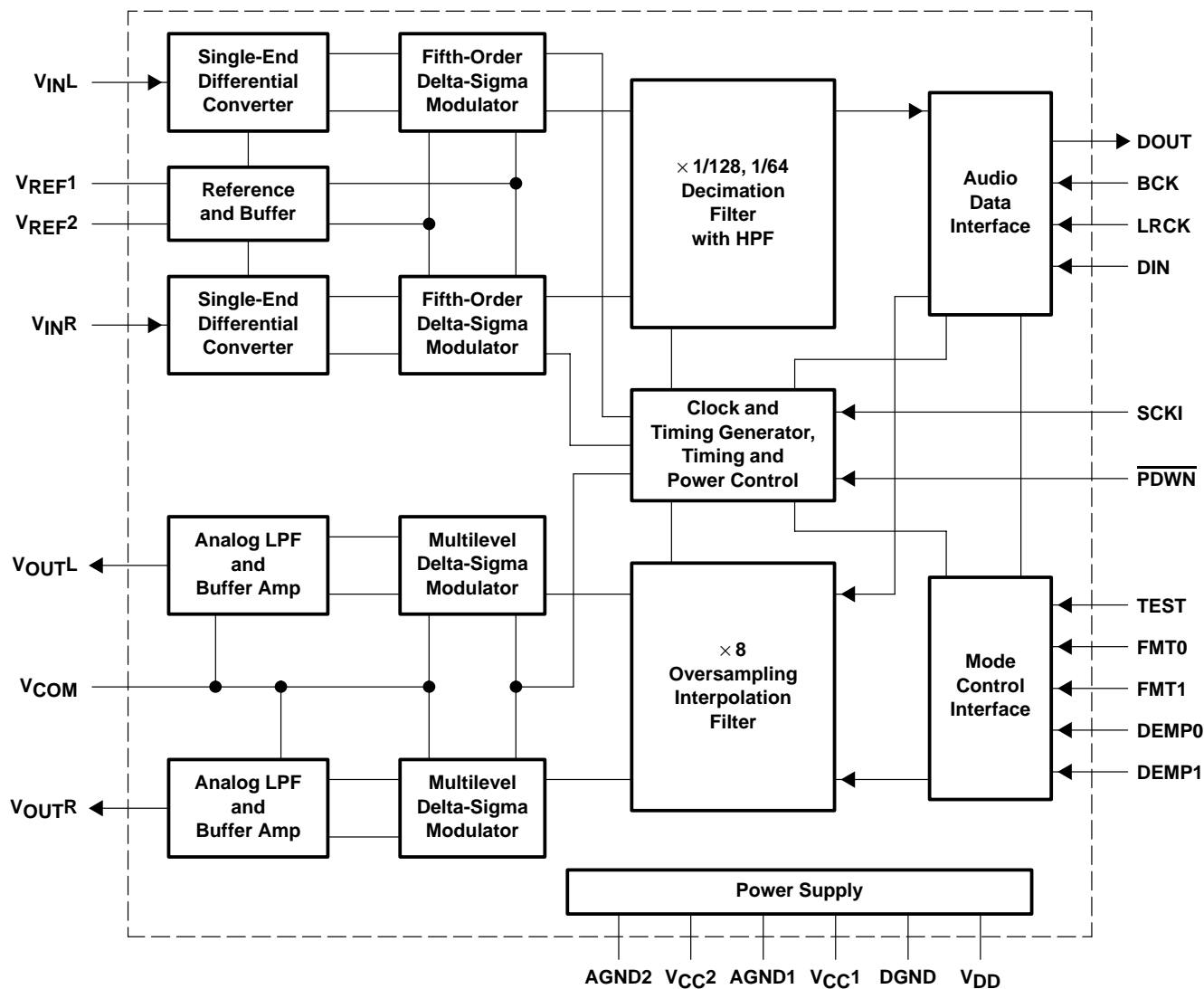
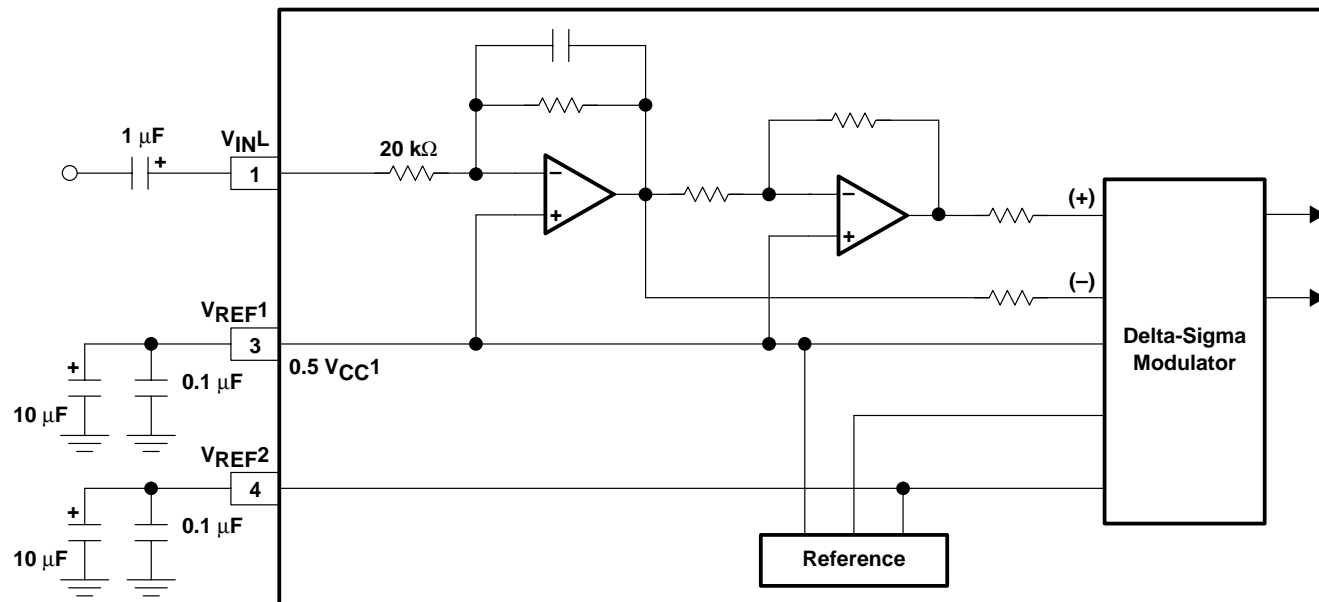

Figure 1. PCM3010 Block Diagram

analog front-end (right-channel)



## Terminal Functions

TERMINAL NAME	NO.	I/O	DESCRIPTIONS
AGND1	6	–	ADC analog ground
AGND2	20	–	DAC analog ground
BCK	11	I	Audio data bit clock input <sup>‡</sup>
DEMP1	18	I	De-emphasis select input, 1 <sup>†</sup>
DEMP0	19	I	De-emphasis select input, 0 <sup>†</sup>
DGND	14	–	Digital ground
DIN	12	I	Audio data digital input <sup>‡</sup>
DOUT	13	O	Audio data digital output
FMT0	7	I	Audio data format select input, 0 <sup>†</sup>
FMT1	8	I	Audio data format select input, 1 <sup>†</sup>
LRCK	10	I	Audio data latch enable input <sup>‡</sup>
$\overline{\text{PDWN}}$	17	I	ADC and DAC power-down control input, active LOW <sup>†</sup>
SCKI	16	I	System clock input <sup>‡</sup>
TEST	9	I	Test control, must be open or connected to DGND <sup>†</sup>
V <sub>CC1</sub>	5	–	ADC analog power supply, 5 V
V <sub>CC2</sub>	21	–	DAC analog power supply, 5 V
V <sub>COM</sub>	24	–	DAC common voltage decoupling (= 0.5 V <sub>CC2</sub> )
V <sub>DD</sub>	15	–	Digital power supply, 3.3 V
V <sub>INL</sub>	1	I	ADC analog input, L-channel
V <sub>INR</sub>	2	I	ADC analog input, R-channel
V <sub>OUTL</sub>	23	O	DAC analog output, L-channel
V <sub>OUTR</sub>	22	O	DAC analog output, R-channel
V <sub>REF1</sub>	3	–	ADC reference voltage decoupling, 1 (= 0.5 V <sub>CC1</sub> )
V <sub>REF2</sub>	4	–	ADC reference voltage decoupling, 2

<sup>†</sup> Schmitt-trigger input with 50-k $\Omega$  typical internal pulldown resistor, 5-V tolerant.

<sup>‡</sup> Schmitt-trigger input, 5-V tolerant.

**absolute maximum ratings over operating free-air temperature (unless otherwise noted)†**

Supply voltage: $V_{CC1}, V_{CC2}$ .....	6.5 V
$V_{DD}$ .....	4.0 V
Supply voltage differences: $V_{CC1}, V_{CC2}$ .....	$\pm 0.1$ V
Ground voltage differences: AGND1, AGND2, DGND .....	$\pm 0.1$ V
Digital input voltage: PDWN, TEST, FMT0, FMT1, DEMP0, DEMP1, LRCK, BCK, DIN, SCKI . . . .	-0.3 V to +6.5 V
Digital input voltage: DOUT .....	-0.3 V to ( $V_{DD} + 0.3$ V)
Analog input voltage, $V_{INL}, V_{INR}, V_{REF1}, V_{REF2}$ .....	-0.3 V to ( $V_{CC1} + 0.3$ V)
Analog input voltage, $V_{COM}, V_{OUTL}, V_{OUTR}$ .....	-0.3 V to ( $V_{CC2} + 0.3$ V)
Input current (any pins except supplies) .....	$\pm 10$ mA
Ambient temperature under bias .....	-40°C to 125°C
Storage temperature .....	-55°C to 150°C
Junction temperature .....	150°C
Lead temperature (soldering) .....	260°C, 5 s
Package temperature (IR reflow, peak) .....	260°C

† Stresses beyond those listed under “absolute maximum ratings” may cause permanent damage to the device. These are stress ratings only, and functional operation of the device at these or any other conditions beyond those indicated under “recommended operating conditions” is not implied. Exposure to absolute-maximum-rated conditions for extended periods may affect device reliability.

**electrical characteristics, all specifications at  $T_A = 25^\circ\text{C}$ ,  $V_{CC1} = V_{CC2} = 5$  V,  $V_{DD} = 3.3$  V,  $f_S = 44.1$  kHz, SCKI = 384  $f_S$ , 24-bit data (unless otherwise noted)**

PARAMETER		TEST CONDITIONS	PCM3010DB			UNIT
			MIN	TYP	MAX	
<b>DIGITAL INPUT/OUTPUT</b>						
<b>DATA FORMAT</b>						
Audio data interface format			Left-justified, I <sup>2</sup> S, right-justified			
Audio data bit length			16, 24			Bits
Audio data format			MSB-first, 2s complement			
f <sub>S</sub>	Sampling frequency, ADC		16	44.1	96	kHz
	Sampling frequency, DAC		16	44.1	192	kHz
System clock frequency		128 f <sub>S</sub> , 192 f <sub>S</sub> , 256 f <sub>S</sub> , 384 f <sub>S</sub> , 512 f <sub>S</sub> , 768 f <sub>S</sub>	4		50	MHz
<b>INPUT LOGIC</b>						
V <sub>IH</sub>	Input logic level (see Notes 1 and 2)		2.0		5.5	VDC
V <sub>IL</sub>					0.8	VDC
I <sub>IH</sub>	Input logic current (see Note 2)	V <sub>IN</sub> = V <sub>DD</sub>			$\pm 10$	$\mu\text{A}$
I <sub>IL</sub>		V <sub>IN</sub> = 0 V			$\pm 10$	$\mu\text{A}$
I <sub>IH</sub>	Input logic current (see Note 1)	V <sub>IN</sub> = V <sub>DD</sub>		65	100	$\mu\text{A}$
I <sub>IL</sub>		V <sub>IN</sub> = 0 V			$\pm 10$	$\mu\text{A}$
<b>OUTPUT LOGIC</b>						
V <sub>OH</sub>	Output logic level (see Note 3)	I <sub>OUT</sub> = -4 mA	2.4			VDC
V <sub>OL</sub>		I <sub>OUT</sub> = 4 mA			0.4	
<b>ADC CHARACTERISTICS</b>						
Resolution				24		Bits

- NOTES: 1. Pins 7, 8, 9, 17, 18, 19: PDWN, TEST, FMT0, FMT1, DEMP0, DEMP1 (Schmitt-trigger input with 50-k $\Omega$  typical internal pulldown resistor, 5-V tolerant).  
 2. Pins 10–12, 16: LRCK, BCK, DIN, SCKI (Schmitt-trigger input, 5-V tolerant).  
 3. Pin 13: DOUT.

electrical characteristics, all specifications at  $T_A = 25^\circ\text{C}$ ,  $V_{CC1} = V_{CC2} = 5\text{ V}$ ,  $V_{DD} = 3.3\text{ V}$ ,  $f_S = 44.1\text{ kHz}$ ,  $\text{SCKI} = 384 f_S$ , 24-bit data (unless otherwise noted) (continued)

PARAMETER	TEST CONDITIONS	PCM3010DB			UNIT
		MIN	TYP	MAX	
<b>ACCURACY</b>					
Gain mismatch, channel-to-channel	1 kHz, full-scale input		$\pm 1$	$\pm 6$	% of FSR
Gain error	1 kHz, full-scale input		$\pm 2$	$\pm 6$	% of FSR
<b>DYNAMIC PERFORMANCE (see Note 4)</b>					
THD+N $V_{IN} = -0.5\text{ dB}$	$f_S = 44.1\text{ kHz}$		-95	-86	dB
	$f_S = 96\text{ kHz}$		-92		
THD+N $V_{IN} = -60\text{ dB}$	$f_S = 44.1\text{ kHz}$		-39		dB
	$f_S = 96\text{ kHz}$		-40		
Dynamic range	$f_S = 44.1\text{ kHz}$ , A-weighted	97	102		dB
	$f_S = 96\text{ kHz}$ , A-weighted		102		
S/N ratio	$f_S = 44.1\text{ kHz}$ , A-weighted	95	100		dB
	$f_S = 96\text{ kHz}$ , A-weighted		102		
Channel separation	$f_S = 44.1\text{ kHz}$	93	98		dB
	$f_S = 96\text{ kHz}$		100		
<b>ANALOG INPUT</b>					
Input voltage			60% of $V_{CC1}$		Vp-p
Center voltage			50% of $V_{CC1}$		V
Input impedance			20		k $\Omega$
Anti-aliasing filter frequency response	-3 dB		300		kHz
<b>DIGITAL FILTER PERFORMANCE</b>					
Pass band			0.454 $f_S$		Hz
Stop band		0.583 $f_S$			Hz
Pass-band ripple			$\pm 0.05$		dB
Stop-band attenuation		-65			dB
Delay time			17.4/ $f_S$		sec
HPF frequency response	-3 dB		0.019 $f_S$		mHz
<b>DAC CHARACTERISTICS</b>					
Resolution			24		Bits
<b>DC ACCURACY</b>					
Gain mismatch, channel-to-channel			$\pm 1.0$	$\pm 4.0$	% of FSR
Gain error			$\pm 2.0$	$\pm 6.0$	% of FSR
Bipolar zero error			$\pm 1.0$		% of FSR
<b>DYNAMIC PERFORMANCE (see Note 5)</b>					
THD+N, $V_{OUT} = 0\text{ dB}$	$f_S = 44.1\text{ kHz}$		-96	-88	dB
	$f_S = 96\text{ kHz}$		-97		
	$f_S = 192\text{ kHz}$		-97		

NOTES: 4.  $f_{IN} = 1\text{ kHz}$ , using System Two™ audio measurement system, RMS mode with 20-kHz LPF, 400-Hz HPF in calculation.

5.  $f_{OUT} = 1\text{ kHz}$ , using System Two audio measurement system, RMS mode with 20-kHz LPF, 400-Hz HPF.

System Two is a trademark of Audio Precision, Inc.  
All other trademarks are the property of their respective owners.

# PCM3010

SLES055 – NOVEMBER 2002

electrical characteristics, all specifications at  $T_A = 25^\circ\text{C}$ ,  $V_{CC1} = V_{CC2} = 5\text{ V}$ ,  $V_{DD} = 3.3\text{ V}$ ,  $f_S = 44.1\text{ kHz}$ ,  $\text{SCKI} = 384 f_S$ , 24-bit data (unless otherwise noted) (continued)

PARAMETER	TEST CONDITIONS	PCM3010DB			UNIT	
		MIN	TYP	MAX		
<b>DYNAMIC PERFORMANCE (see Note 5) (Continued)</b>						
THD+N $V_{OUT} = -60\text{ dB}$	$f_S = 44.1\text{ kHz}$		-42		dB	
	$f_S = 96\text{ kHz}$		-43			
	$f_S = 192\text{ kHz}$		-43			
Dynamic range	$f_S = 44.1\text{ kHz}$ , EIAJ, A-weighted	98	104		dB	
	$f_S = 96\text{ kHz}$ , EIAJ, A-weighted		105			
	$f_S = 192\text{ kHz}$ , EIAJ, A-weighted		105			
S/N ratio	$f_S = 44.1\text{ kHz}$ , EIAJ, A-weighted	98	104		dB	
	$f_S = 96\text{ kHz}$ , EIAJ, A-weighted		105			
	$f_S = 192\text{ kHz}$ , EIAJ, A-weighted		105			
Channel separation	$f_S = 44.1\text{ kHz}$	95	102		dB	
	$f_S = 96\text{ kHz}$		102			
	$f_S = 192\text{ kHz}$		103			
<b>ANALOG OUTPUT</b>						
Output voltage			60% of $V_{CC2}$		Vp-p	
Center voltage			50% of $V_{CC2}$		V	
Load impedance	AC coupling	5			k $\Omega$	
LPF frequency response	$f = 20\text{ kHz}$		-0.03		dB	
	$f = 44\text{ kHz}$		-0.20			
<b>DIGITAL FILTER PERFORMANCE</b>						
Pass band	$\pm 0.03\text{ dB}$			$0.454 f_S$	Hz	
Stop band				$0.546 f_S$	Hz	
Pass-band ripple				$\pm 0.03$	dB	
Stop-band attenuation	$0.546 f_S$	-50			dB	
Delay time				$20/f_S$	sec	
De-emphasis error				$\pm 0.1$	dB	
<b>POWER SUPPLY REQUIREMENTS</b>						
$V_{CC1}$ $V_{CC2}$	Voltage range		4.5	5.0	5.5	VDC
$V_{DD}$			3.0	3.3	3.6	
$I_{CC}$ ( $I_{CC1} + I_{CC2}$ )	Supply current	$f_S = 44.1\text{ kHz}$		31	40	mA
		$f_S = 96\text{ kHz}$		32		
		$f_S = 192\text{ kHz}$		9		
$I_{DD}$		$f_S = 44.1\text{ kHz}$		10	15	mA
		$f_S = 96\text{ kHz}$		20		
		$f_S = 192\text{ kHz}$		14		
Power dissipation, operation		$f_S = 44.1\text{ kHz}$		190	250	mW
		$f_S = 96\text{ kHz}$		230		
		$f_S = 192\text{ kHz}$		90		
Power dissipation, power down (see Note 6)				1	mW	
<b>TEMPERATURE RANGE</b>						
Operating temperature			-25		85	$^\circ\text{C}$
$\theta_{JA}$	Thermal resistance	24-pin SSOP		100		$^\circ\text{C/W}$

NOTES: 5.  $f_{OUT} = 1\text{ kHz}$ , using System Two audio measurement system, RMS mode with 20-kHz LPF, 400-Hz HPF.

6. Halt SCKI, BCK, LRCK.

TYPICAL PERFORMANCE CURVES OF INTERNAL FILTER (ADC PORTION)

digital filter

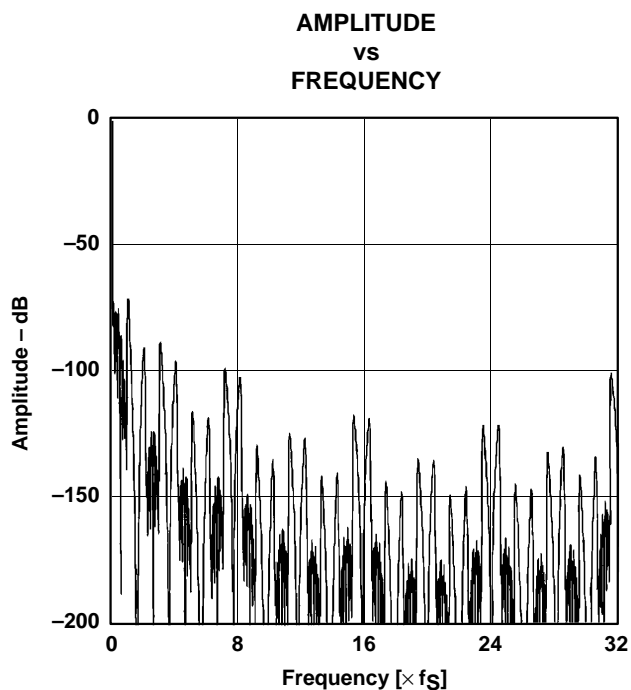

Figure 2. Overall Characteristics

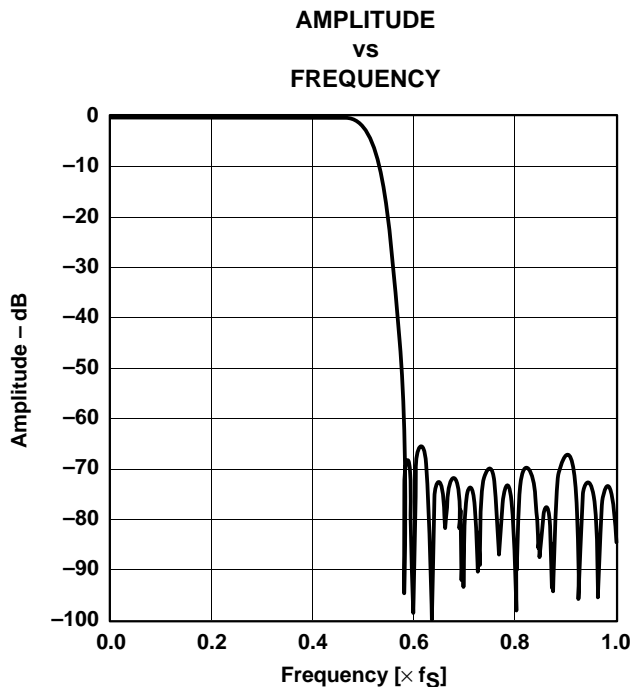

Figure 3. Stop-Band Attenuation Characteristics

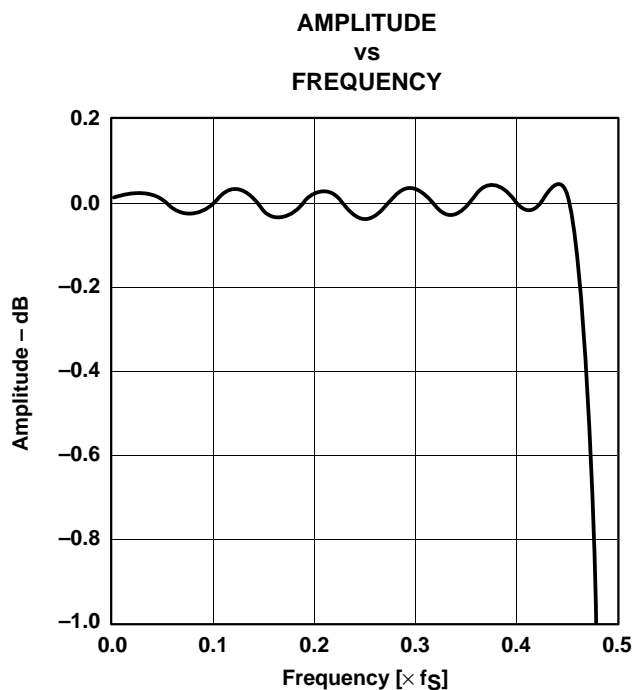

Figure 4. Pass-Band Ripple Characteristics

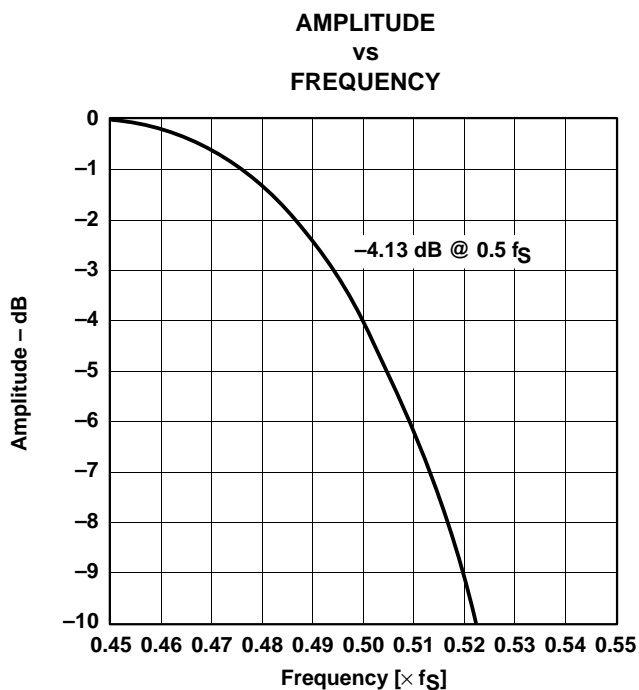

Figure 5. Transient Band Characteristics

All specifications at  $T_A = 25^\circ\text{C}$ ,  $V_{CC1} = V_{CC2} = 5\text{ V}$ ,  $V_{DD} = 3.3\text{ V}$ ,  $f_S = 44.1\text{ kHz}$ ,  $SCK1 = 384 f_S$ , 24-bit data, unless otherwise noted.

digital filter (continued)

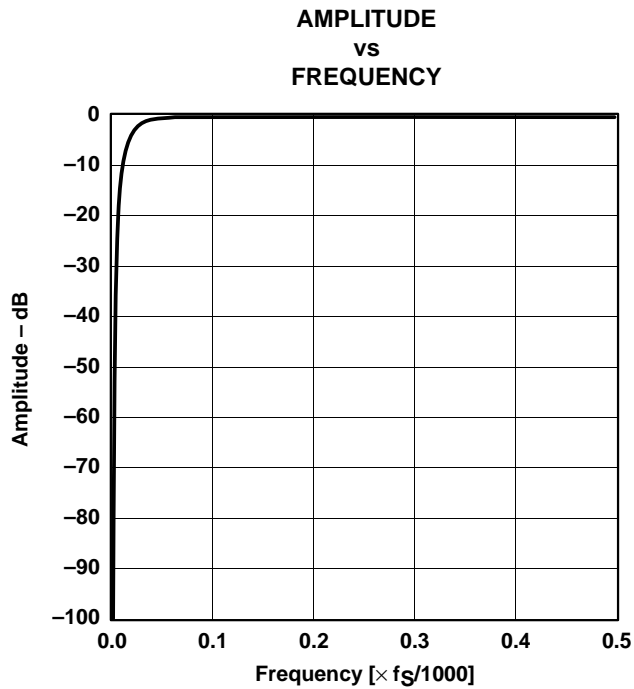

Figure 6. Low-Cut HPF Stop-Band Characteristics

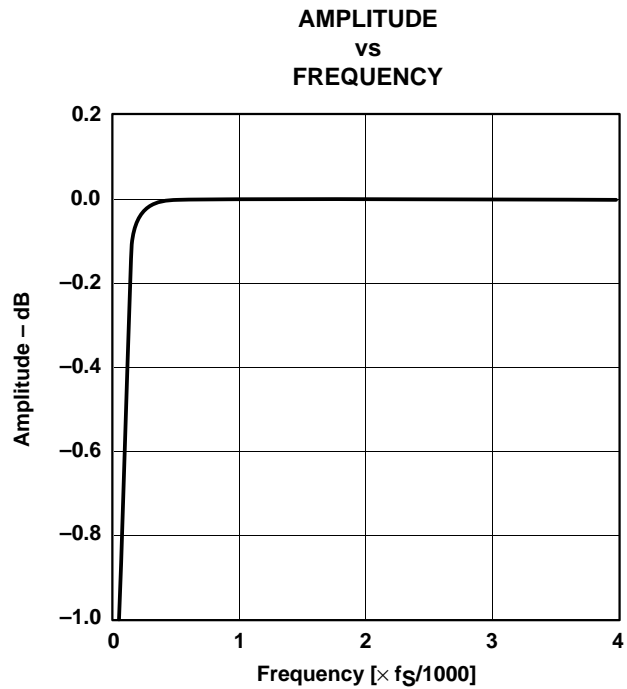

Figure 7. Low-Cut HPF Pass-Band Characteristics

analog filter

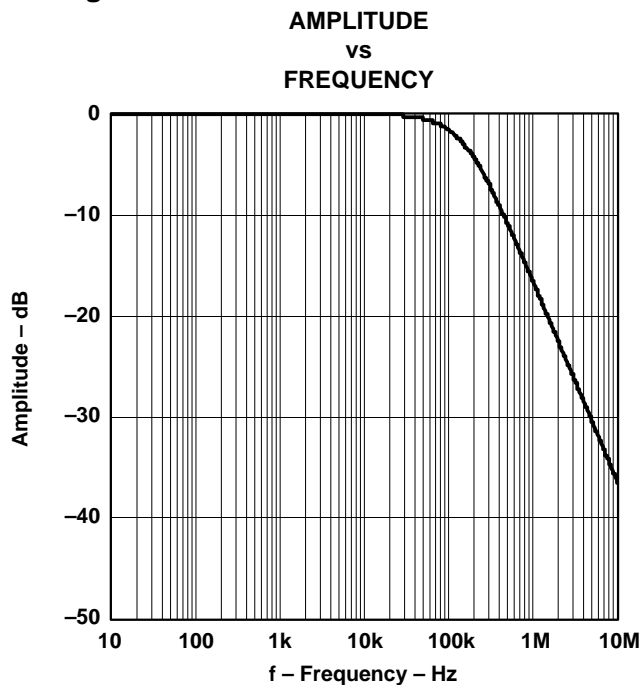

Figure 8. Antialiasing Filter Stop-Band Characteristics

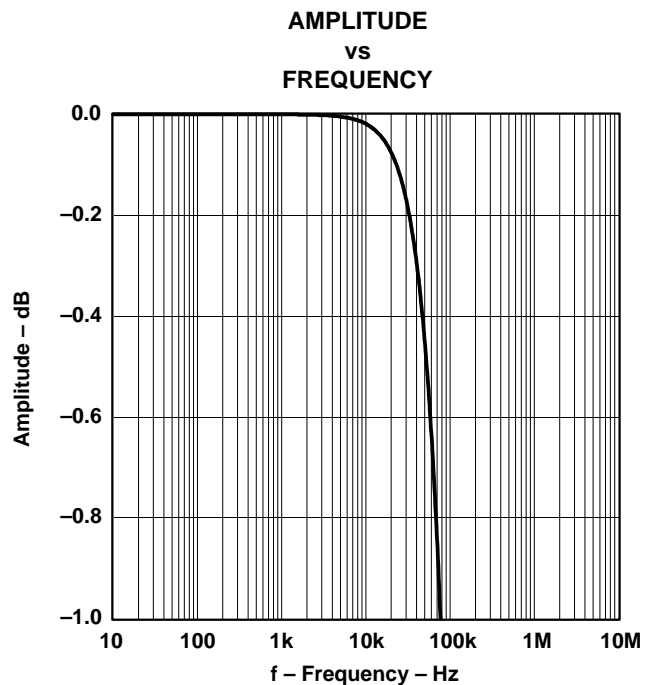

Figure 9. Antialiasing Filter Pass-Band Characteristics

All specifications at  $T_A = 25^\circ\text{C}$ ,  $V_{CC1} = V_{CC2} = 5\text{ V}$ ,  $V_{DD} = 3.3\text{ V}$ ,  $f_S = 44.1\text{ kHz}$ ,  $SCKI = 384\text{ fS}$ , 24-bit data, unless otherwise noted.

TYPICAL PERFORMANCE CURVES OF INTERNAL FILTER (DAC PORTION)

digital filter

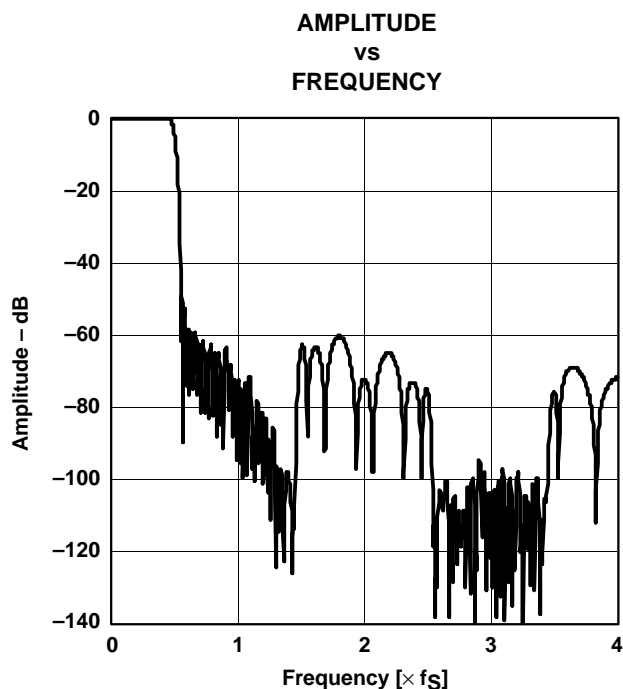

Figure 10. Frequency Response (Sharp Rolloff)

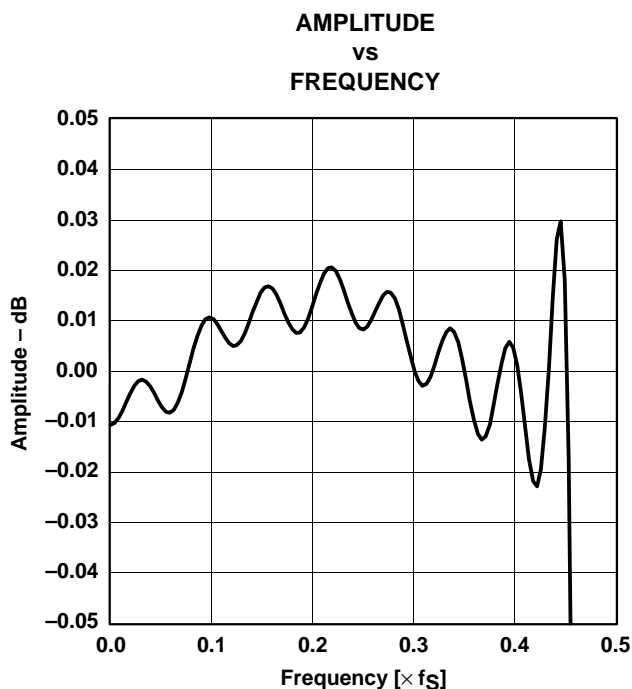

Figure 11. Frequency Response, Pass-Band (Sharp Rolloff)

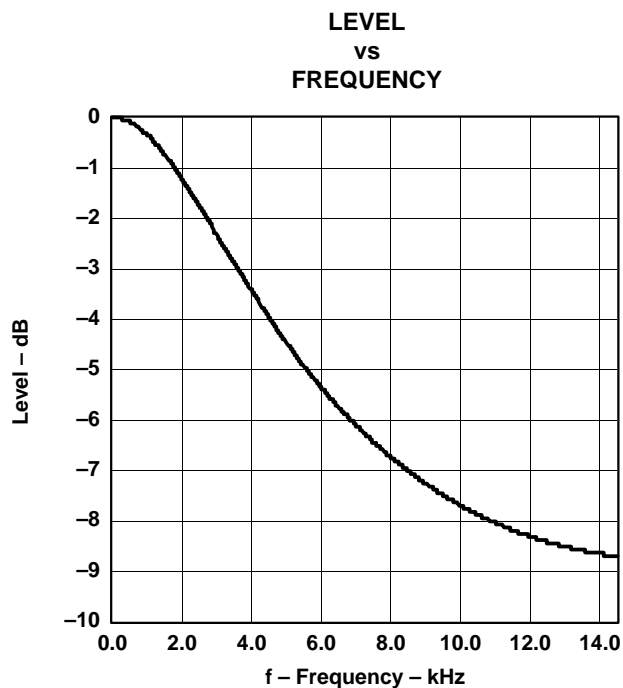

Figure 12. De-Emphasis ( $f_S = 32$  kHz)

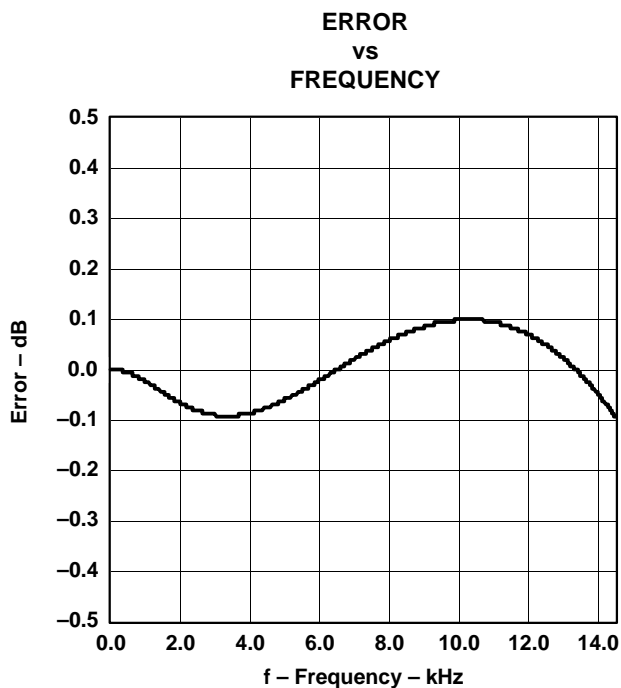

Figure 13. De-Emphasis Error ( $f_S = 32$  kHz)

All specifications at  $T_A = 25^\circ\text{C}$ ,  $V_{CC1} = V_{CC2} = 5$  V,  $V_{DD} = 3.3$  V,  $f_S = 44.1$  kHz,  $SCK1 = 384 f_S$ , 24-bit data, unless otherwise noted.

digital filter (continued)

LEVEL  
vs  
FREQUENCY

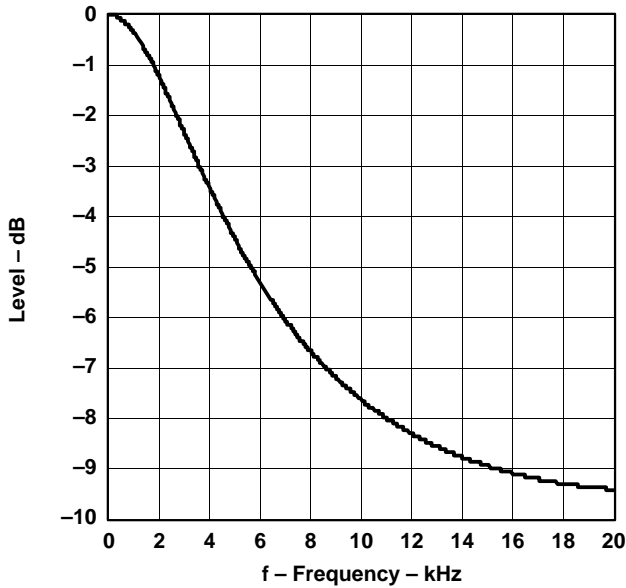

Figure 14. De-Emphasis ( $f_S = 44.1$  kHz)

ERROR  
vs  
FREQUENCY

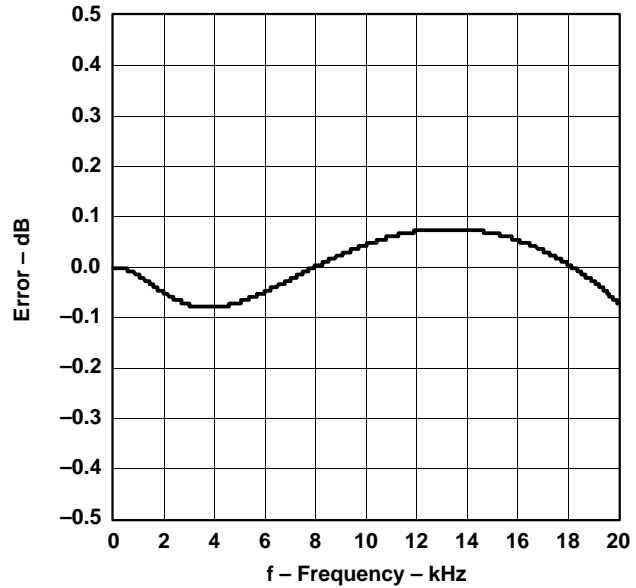

Figure 15. De-Emphasis Error ( $f_S = 44.1$  kHz)

LEVEL  
vs  
FREQUENCY

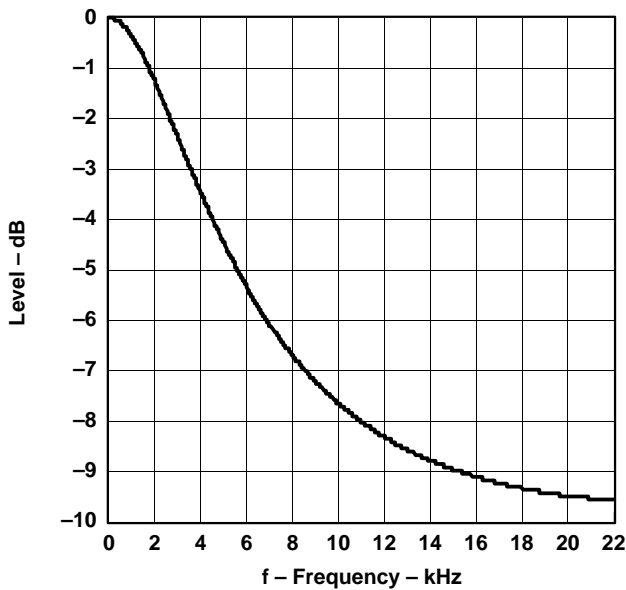

Figure 16. De-Emphasis ( $f_S = 48$  kHz)

ERROR  
vs  
FREQUENCY

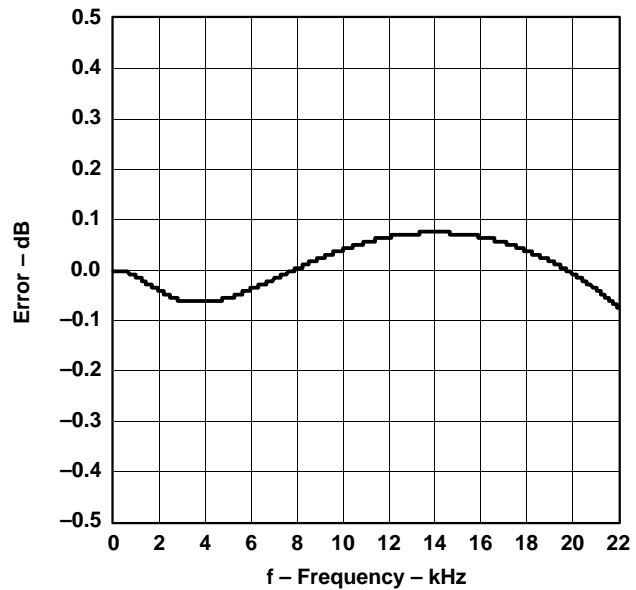

Figure 17. De-Emphasis Error ( $f_S = 48$  kHz)

All specifications at  $T_A = 25^\circ\text{C}$ ,  $V_{CC1} = V_{CC2} = 5$  V,  $V_{DD} = 3.3$  V,  $f_S = 44.1$  kHz,  $SCKI = 384 f_S$ , 24-bit data, unless otherwise noted.

analog filter

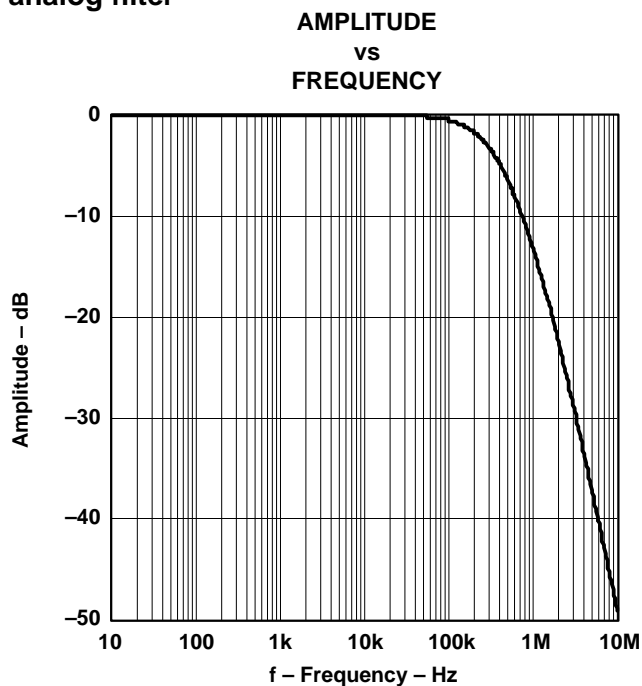

Figure 18. Analog Filter Stop-Band Performance (10 Hz–10 MHz)

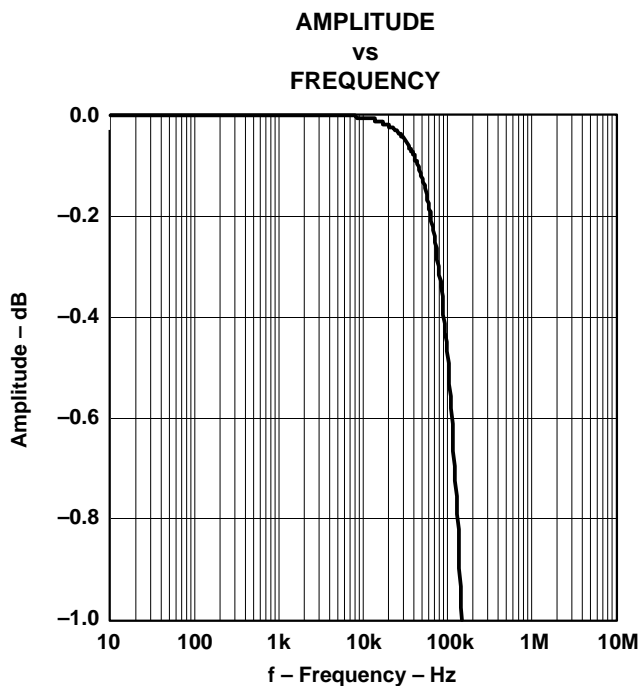

Figure 19. Analog Filter Pass-Band Performance (10 Hz–10 MHz)

TYPICAL PERFORMANCE CURVES (ADC PORTION)

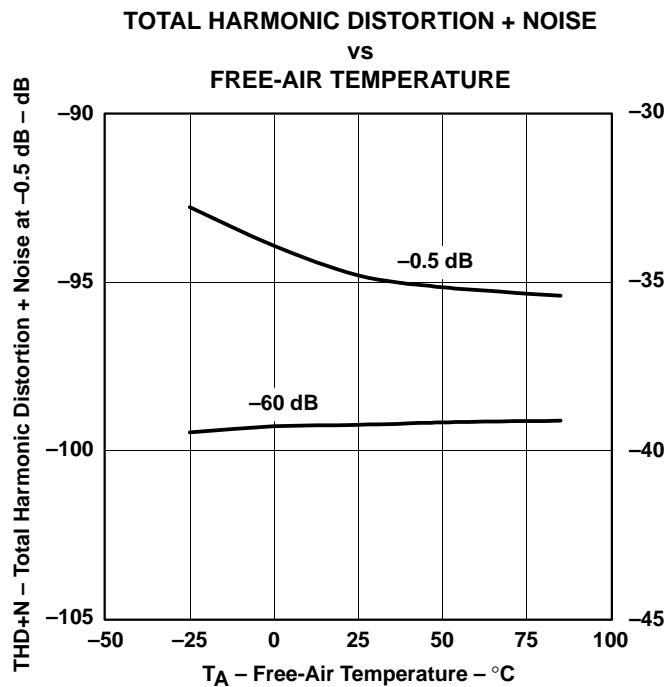

Figure 20

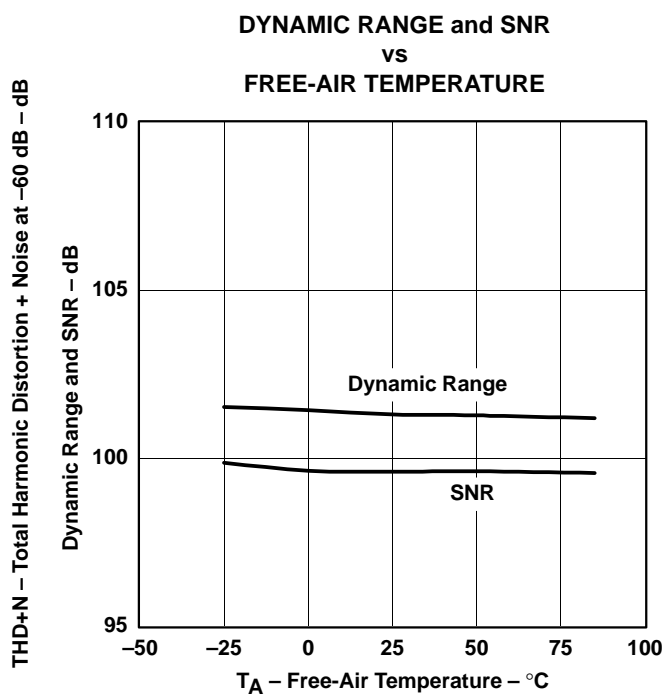

Figure 21

All specifications at  $T_A = 25^\circ\text{C}$ ,  $V_{CC1} = V_{CC2} = 5\text{ V}$ ,  $V_{DD} = 3.3\text{ V}$ ,  $f_S = 44.1\text{ kHz}$ ,  $\text{SCKI} = 384 f_S$ , 24-bit data, unless otherwise noted.

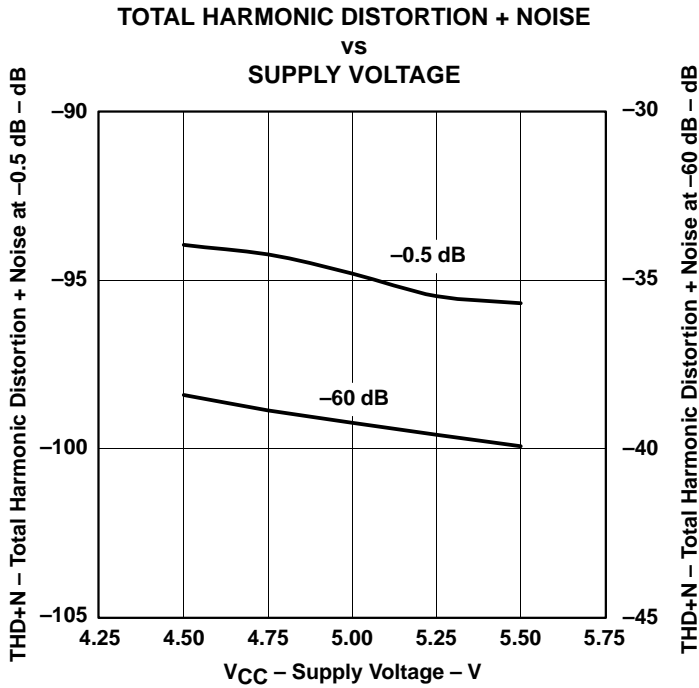

Figure 22

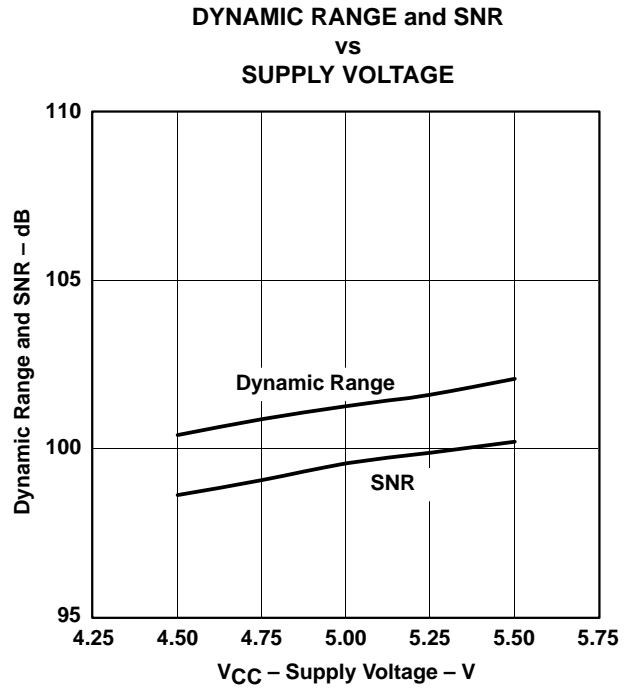

Figure 23

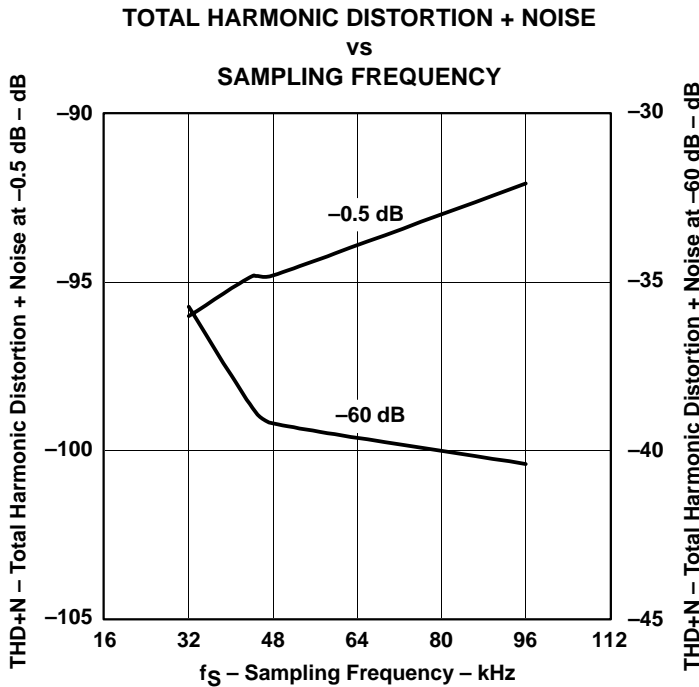

Figure 24

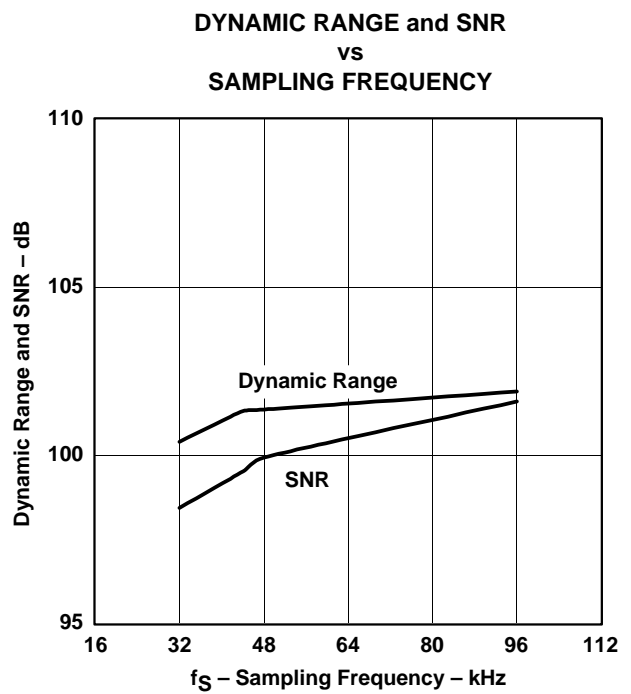
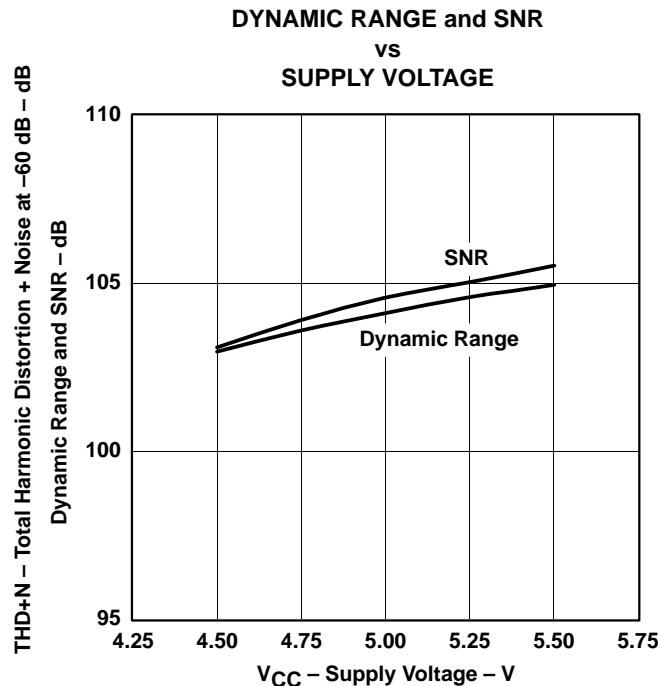
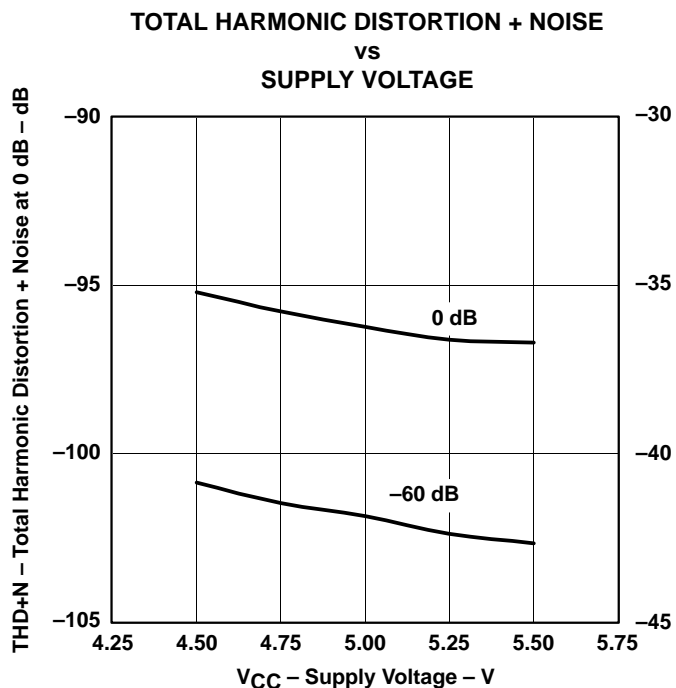
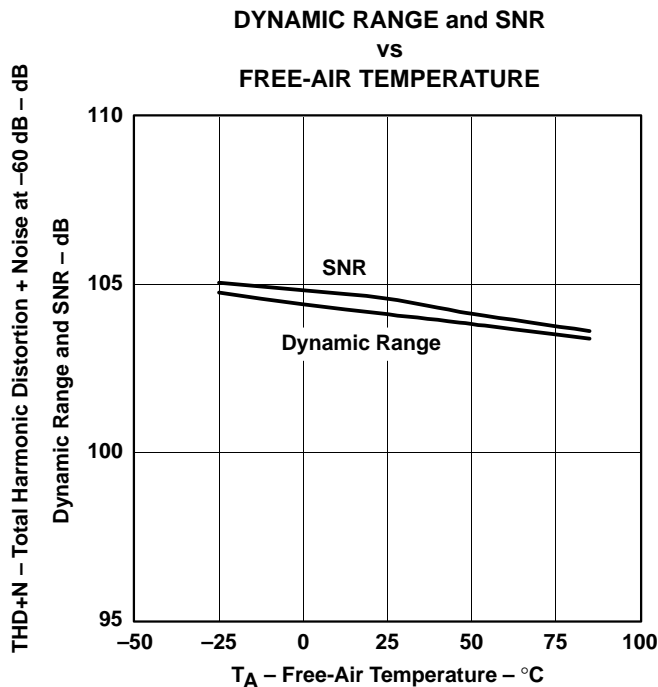
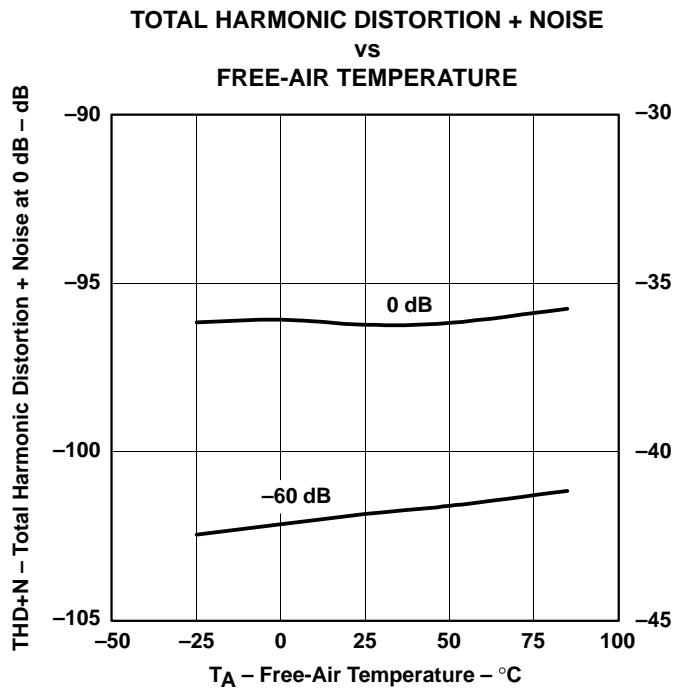

Figure 25

All specifications at T<sub>A</sub> = 25°C, V<sub>CC1</sub> = V<sub>CC2</sub> = 5 V, V<sub>DD</sub> = 3.3 V, f<sub>S</sub> = 44.1 kHz, SCKI = 384 f<sub>S</sub>, 24-bit data, unless otherwise noted.

TYPICAL PERFORMANCE CURVES (DAC PORTION)



All specifications at  $T_A = 25^\circ\text{C}$ ,  $V_{CC1} = V_{CC2} = 5\text{ V}$ ,  $V_{DD} = 3.3\text{ V}$ ,  $f_S = 44.1\text{ kHz}$ ,  $SCKI = 384 f_S$ , 24-bit data, unless otherwise noted.

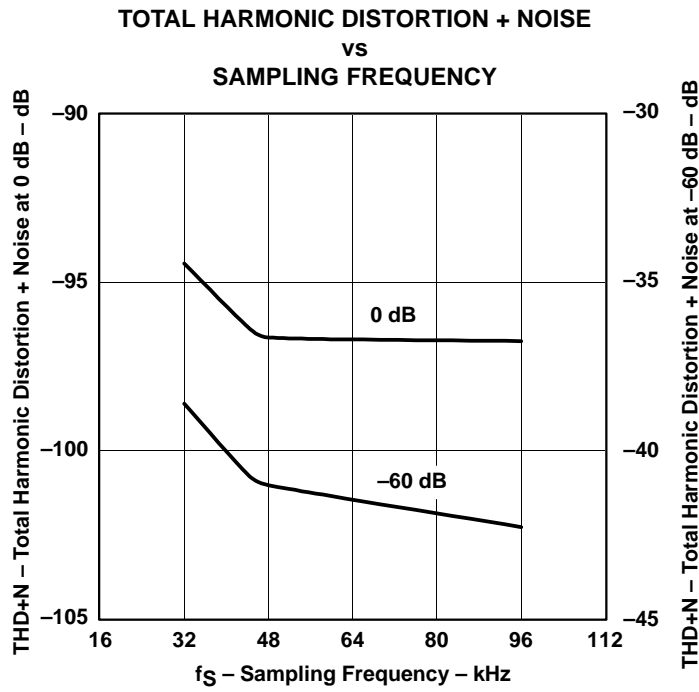

Figure 30

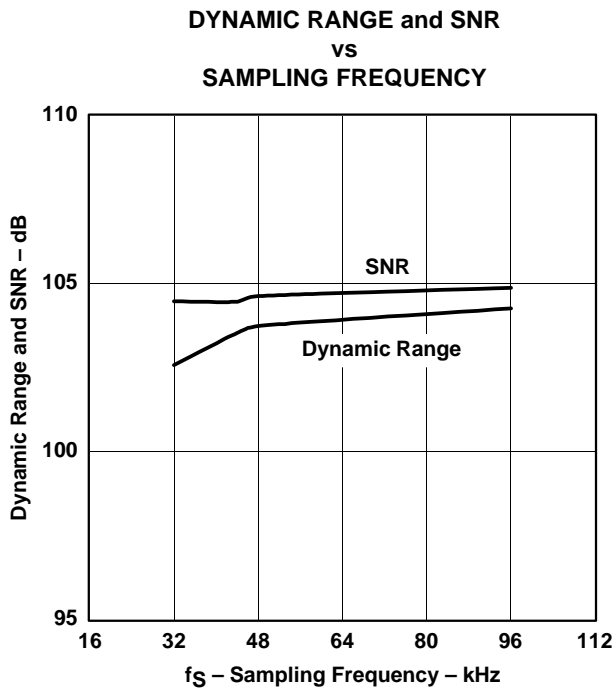

Figure 31

All specifications at  $T_A = 25^\circ\text{C}$ ,  $V_{CC1} = V_{CC2} = 5\text{ V}$ ,  $V_{DD} = 3.3\text{ V}$ ,  $f_S = 44.1\text{ kHz}$ ,  $SCKI = 384\text{ fS}$ , 24-bit data, unless otherwise noted.

TYPICAL PERFORMANCE CURVES

ADC output spectrum

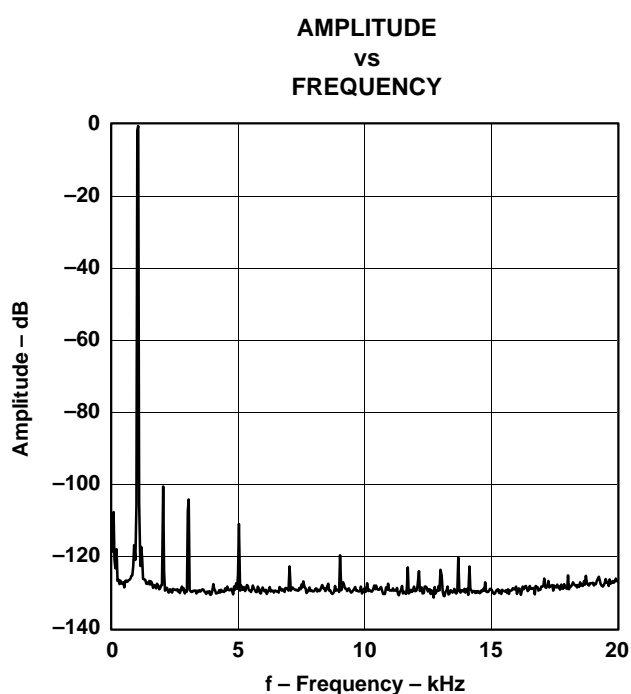

Figure 32. Output Spectrum (-0.5 dB, N = 8192)

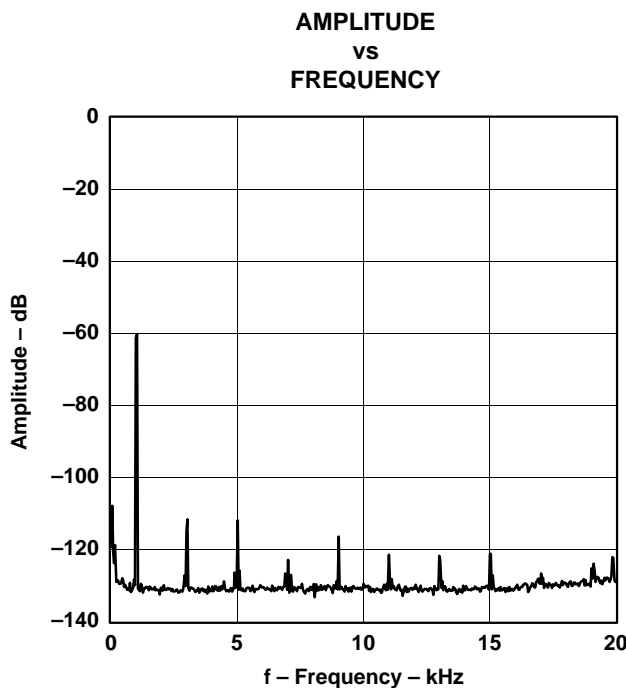

Figure 33. Output Spectrum (-60 dB, N = 8192)

DAC output spectrum

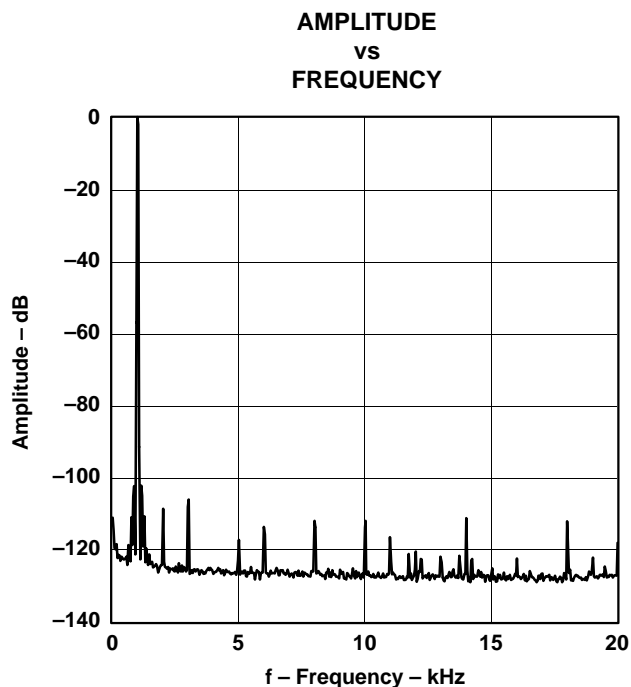

Figure 34. Output Spectrum (0 dB, N = 8192)

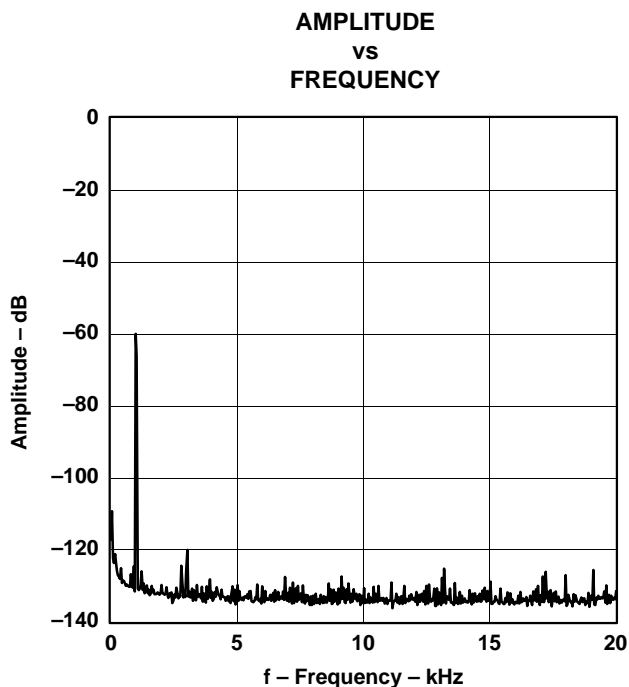

Figure 35. Output Spectrum (-60 dB, N = 8192)

All specifications at  $T_A = 25^\circ\text{C}$ ,  $V_{CC1} = V_{CC2} = 5\text{ V}$ ,  $V_{DD} = 3.3\text{ V}$ ,  $f_S = 44.1\text{ kHz}$ ,  $\text{SCKI} = 384 f_S$ , 24-bit data, unless otherwise noted.

supply current

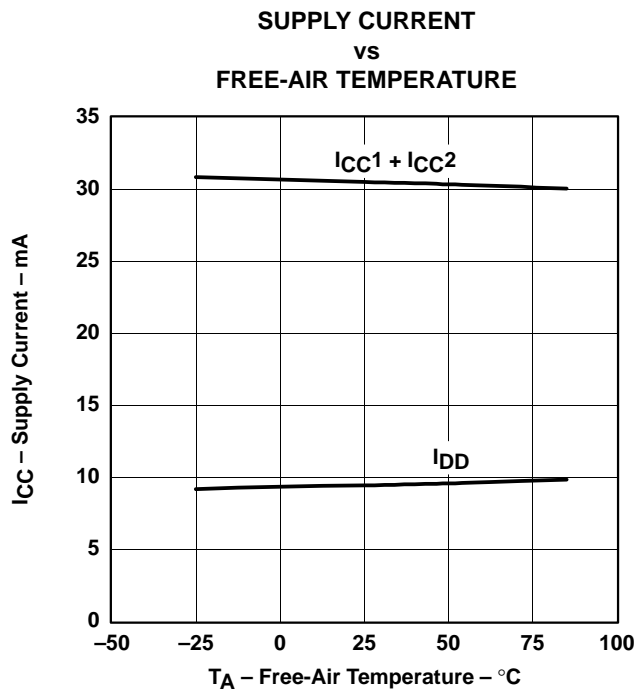

Figure 36

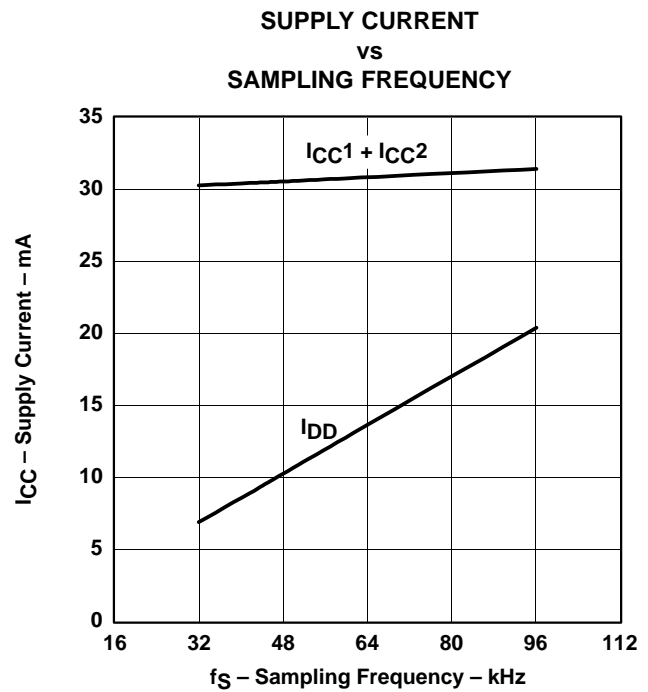

Figure 37. Supply Current vs Sampling Frequency, ADC and DAC Operating

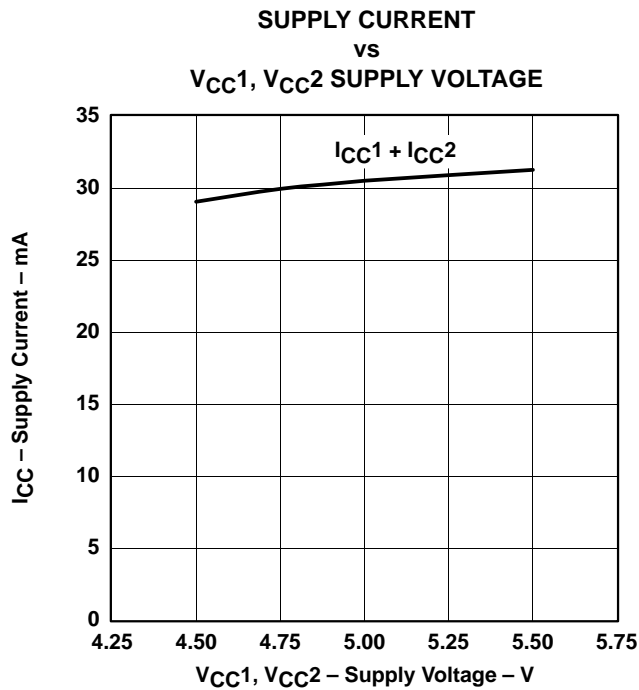

Figure 38

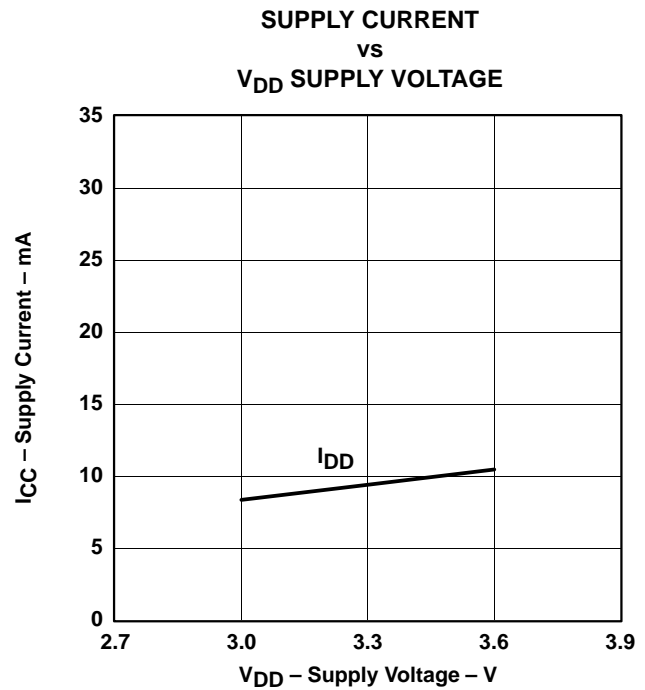

Figure 39

All specifications at T<sub>A</sub> = 25°C, V<sub>CC1</sub> = V<sub>CC2</sub> = 5 V, V<sub>DD</sub> = 3.3 V, f<sub>S</sub> = 44.1 kHz, SCKI = 384 f<sub>S</sub>, 24-bit data, unless otherwise noted.

## THEORY OF OPERATION

### ADC portion

The ADC block consists of a reference circuit, two single-ended to differential converter channels, a fifth-order delta-sigma modulator with full-differential architecture, a decimation filter with low-cut filter, and a serial interface circuit which is also used as a serial interface for the DAC input signal as shown in the block diagram, Figure 1.

The analog front-end diagram illustrates the architecture of the single-ended to differential converter and antialiasing filter. Figure 40 illustrates the block diagram of the fifth-order delta-sigma modulator and transfer function.

An on-chip reference circuit with two external capacitors provides all the reference voltages which are needed in the ADC portion, and defines the full-scale voltage range of both channels.

An on-chip single-ended to differential signal converter saves the design, space, and extra parts cost of an external signal converter.

Full-differential architecture provides a wide dynamic range and excellent power supply rejection performance.

The input signal is sampled at a  $\times 64$  oversampling rate, and an on-chip antialiasing filter eliminates the external sample-hold amplifier. A fifth-order delta-sigma noise shaper, which consists of five integrators using a switched capacitor technique followed by a comparator, shapes the quantization noise generated by the comparator and 1-bit DAC outside the audio signal band.

The high order delta-sigma modulation randomizes the modulator outputs and reduces the idle tone level.

The  $64\text{-}f_S$ , 1-bit stream from the delta-sigma modulator is converted to a  $1\text{-}f_S$ , 24-bit or 16-bit digital signal by removing the high-frequency noise components with a decimation filter.

The dc component of the signal is removed by the HPF, and the HPF output is converted to a time-multiplexed serial signal through the serial interface, which provides flexible serial formats.

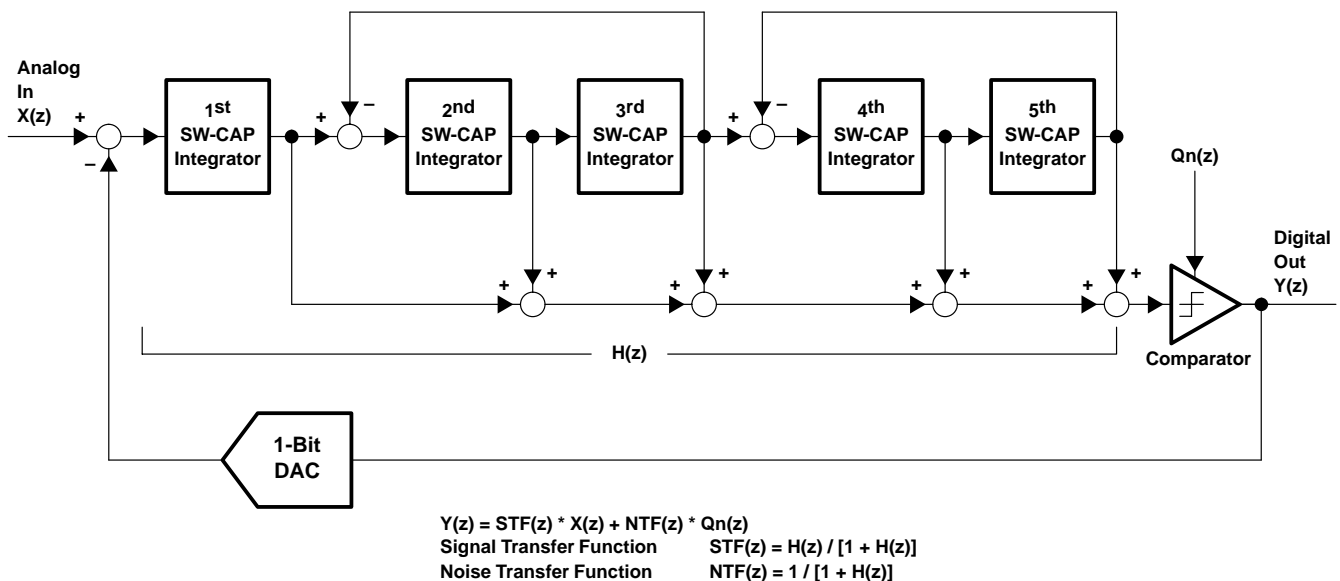

Figure 40. Block Diagram of Fifth-Order Delta-Sigma Modulator



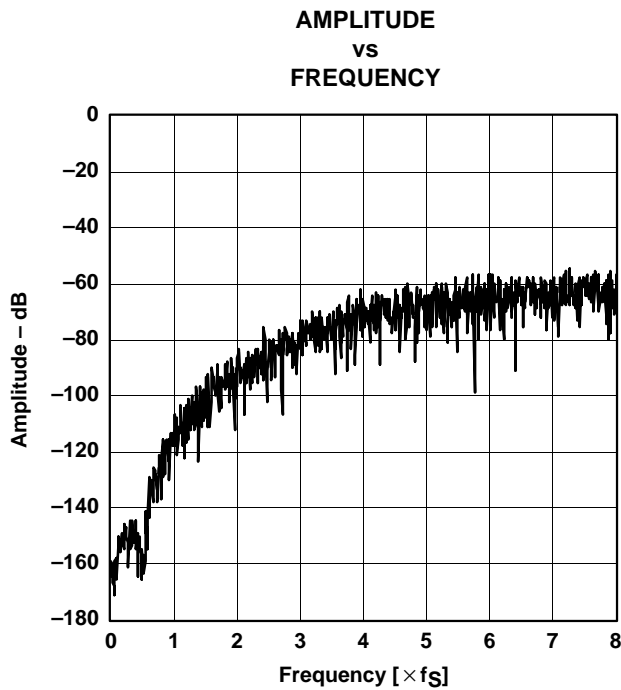

Figure 42. Quantization Noise Spectrum  
( $\times 64$  Oversampling)

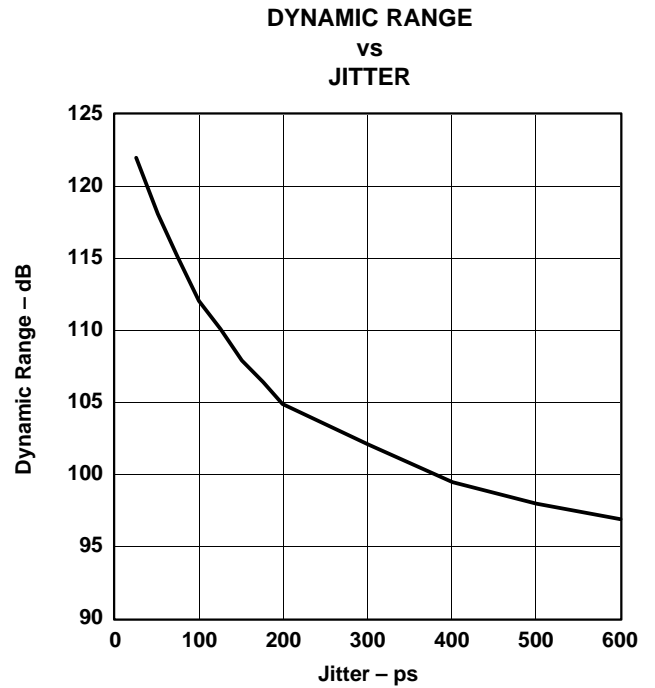

Figure 43. Jitter Dependence  
( $\times 64$  Oversampling)

**system clock**

The system clock for the PCM3010 must be  $128 f_s$ ,  $192 f_s$ ,  $256 f_s$ ,  $384 f_s$ ,  $512 f_s$  or  $768 f_s$ , where  $f_s$  is the audio sampling rate, 16 kHz to 192 kHz. The PCM3010 detects  $128 f_s$ ,  $192 f_s$ ,  $256 f_s$ ,  $384 f_s$ ,  $512 f_s$  or  $768 f_s$  automatically with the built-in circuit. Operation at the 192-kHz sampling rate is available on the DAC only, and when a system clock of  $128 f_s$  or  $192 f_s$  is detected, the ADC is disabled (DOOUT = LOW). Table 1 lists the typical system clock frequency, and Figure 44 illustrates the system clock timing.

**Table 1. Typical System Clock**

SAMPLING RATE FREQUENCY ( $f_s$ ) – LRCK	SYSTEM CLOCK FREQUENCY – MHz					
	$128 f_s$	$192 f_s$	$256 f_s$	$384 f_s$	$512 f_s$	$768 f_s$
32 kHz	–	–	8.192	12.288	16.384	24.576
44.1 kHz	–	–	11.2896	16.9344	22.5792	33.8688
48 kHz	–	–	12.288	18.432	24.576	36.864
96 kHz	–	–	24.576	36.864	49.152	–
192 kHz	24.576†	36.864†	–	–	–	–

† DAC only.

system clock (continued)

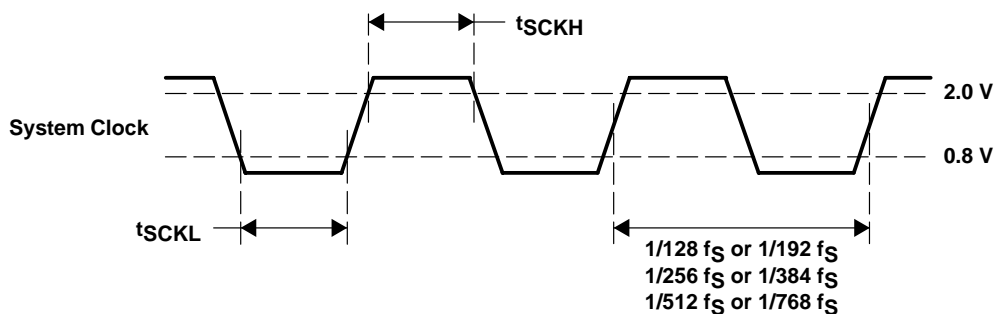

PARAMETER		MIN	MAX	UNIT
$t_{SCKH}$	System clock pulse duration HIGH	8		ns
$t_{SCKL}$	System clock pulse duration LOW	8		ns

Figure 44. System Clock Timing

power supply on, external reset, and power down

The PCM3010 has both an internal power-on reset circuit and an external reset circuit. The sequences for both resets are explained as follows.

Figure 45 is the timing diagram for the internal power-on reset. Two power-on reset circuits are implemented for  $V_{CC1}$  and  $V_{DD}$ , respectively. Initialization (reset) occurs automatically when  $V_{CC1}$  and  $V_{DD}$  exceed 4.0 V and 2.2 V, typically.

Internal reset is released 1024 SCKI clock cycles following the release from power-on reset, and the PCM3010 begins normal operation.  $V_{OUTL}$  and  $V_{OUTR}$  from the DAC are forced to the  $V_{COM}$  ( $= 0.5 V_{CC2}$ ) level as  $V_{CC2}$  rises. When synchronization between SCKI, BCK and LRCK is obtained while  $V_{OUTL}$  and  $V_{OUTR}$  go into the fade sequence and provide outputs corresponding to DIN after  $t_{DACDLY1} = 2100/f_S$  following release from power-on reset. On the other hand, DOUT from the ADC provides an output corresponding to  $V_{INL}$  and  $V_{INR}$  after  $t_{ADC DLY1} = 4500/f_S$  following release from power-on reset. If the synchronization is not held, the internal reset is not released and device operation remains in the power-down mode. After resynchronization, the DAC performs the fade-in sequence and the ADC resumes normal operation following internal initialization.

Figure 46 is the external-reset timing diagram. External forced reset, driving the  $\overline{PDWN}$  pin LOW, puts the PCM3010 in the power-down mode, which is its lowest power-dissipation state.

When  $\overline{PDWN}$  transitions from HIGH to LOW while synchronization is maintained between SCKI, BCK, and LRCK, then  $V_{OUTL}$  and  $V_{OUTR}$  are faded out and forced to the  $V_{COM}$  ( $= 0.5 V_{CC2}$ ) level after  $t_{DACDLY1} = 2100/f_S$ . At the same time as the internal reset becomes LOW, DOUT becomes ZERO, the PCM3010 enters into power-down mode. To enter into normal operation mode again, change  $\overline{PDWN}$  to HIGH again. The reset sequence shown in Figure 45 occurs.

Notes:

1. A large popping noise may be generated on  $V_{OUTL}$  and  $V_{OUTR}$  when the power supply is turned off during normal operation.
2. To switch  $\overline{PDWN}$  during fade in or fade out causes an immediate change between fade in and fade out.
3. To switch the control pins on the fly during normal operation can degrade analog performance. It is recommended that changing control pins, changing clocks, stopping clocks, turning power supplies off, etc., be done in the power-down mode.

power supply on, external reset and power down (continued)

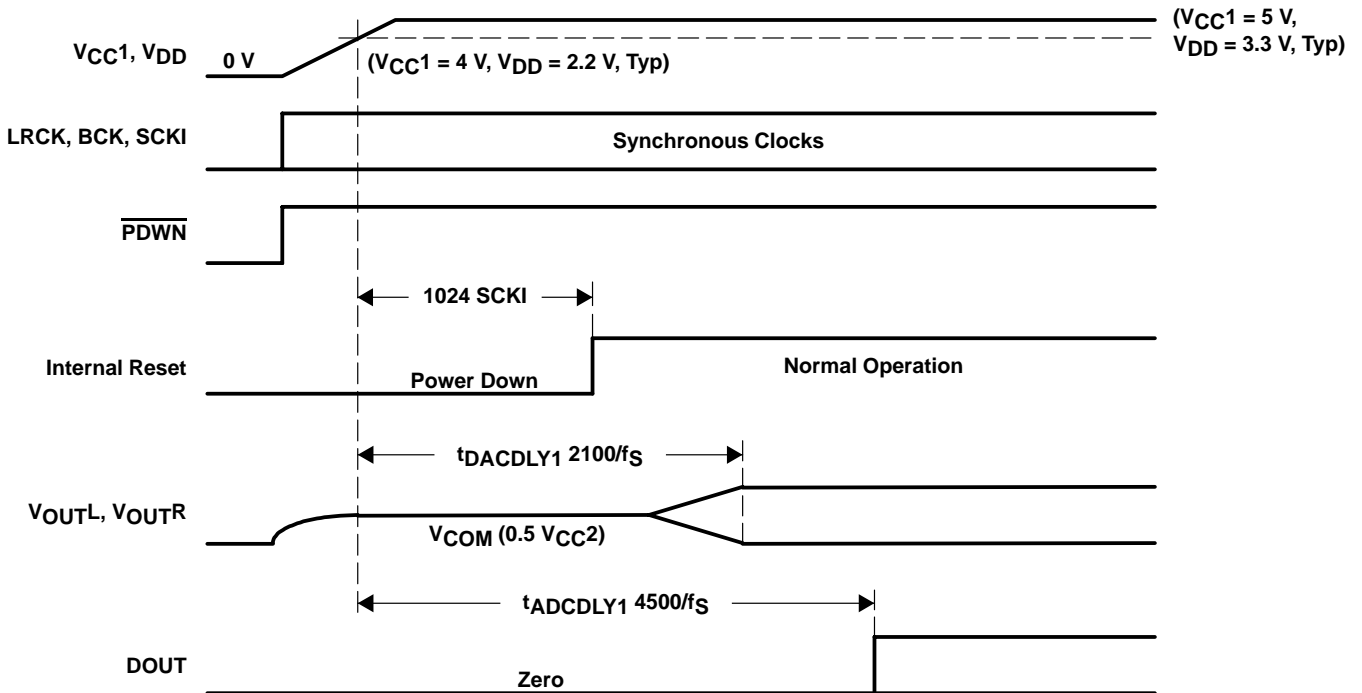

Figure 45. DAC Output and ADC Output for Power-On Reset

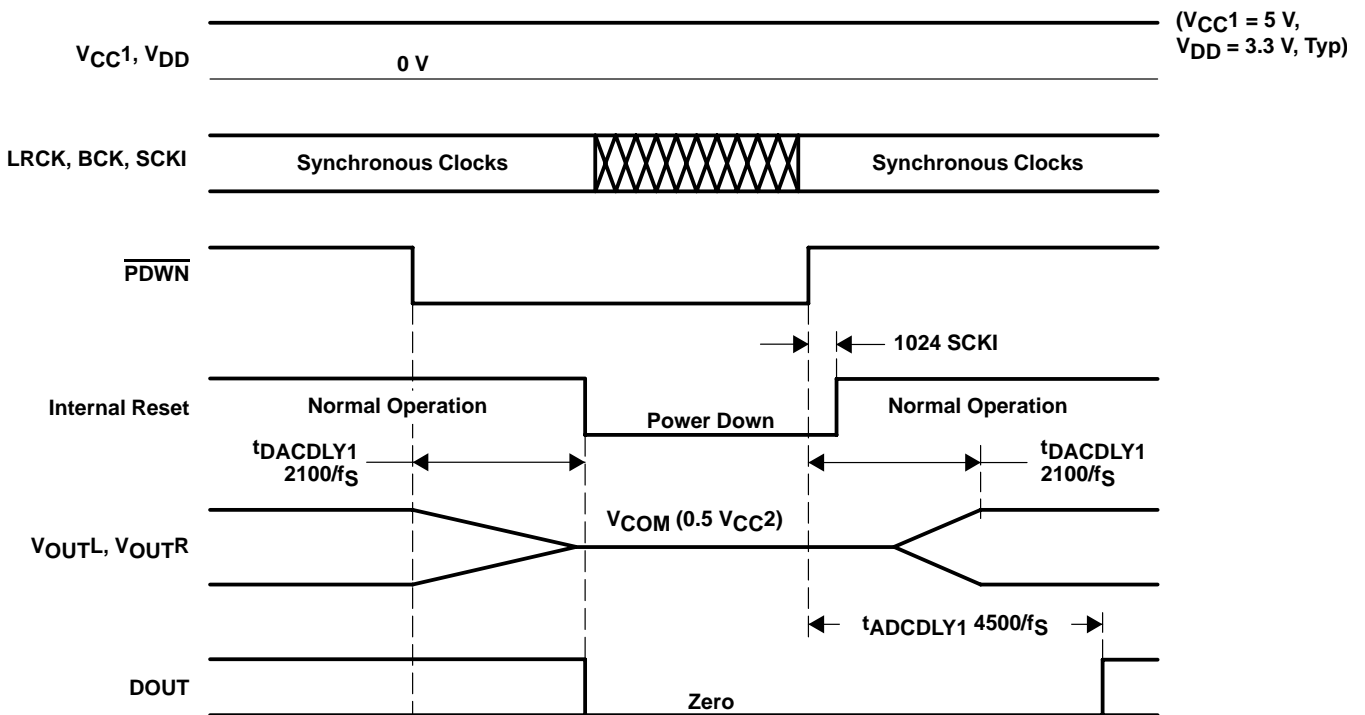

Figure 46. DAC Output and ADC Output for External Reset ( $\overline{PDWN}$  Pin)

PCM audio interface

Digital audio data is interfaced to the PCM3010 on LRCK (pin 10), BCK (pin 11), DIN (pin 12), and DOUT (pin 13). The PCM3010 can accept the following 16-bit and 24-bit formats. These formats are selected through FMT0 (pin 7) and FMT1 (pin 8), as shown in Table 2.

Table 2. Audio Data Format Select

FMT1	FMT0	DAC DATA FORMAT	ADC DATA FORMAT
LOW	LOW	24-bit, MSB-first, right-justified	24-bit, MSB-first, left-justified
LOW	HIGH	16-bit, MSB-first, right-justified	24-bit, MSB-first, left-justified
HIGH	LOW	24-bit, MSB-first, left-justified	24-bit, MSB-first, left-justified
HIGH	HIGH	24-bit, MSB-first, I <sup>2</sup> S	24-bit, MSB-first, I <sup>2</sup> S

The PCM3010 accepts two combinations of BCK and LRCK, 64 or 48 clocks of BCK in one clock of LRCK. The following figures illustrate audio data input/output format and timing.

FORMAT 0: FMT[1:0] = 00

DAC: 24-Bit, MSB-First, Right-Justified

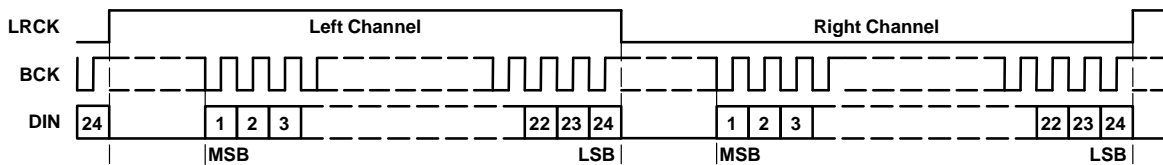

ADC: 24-Bit, MSB-First, Left-Justified

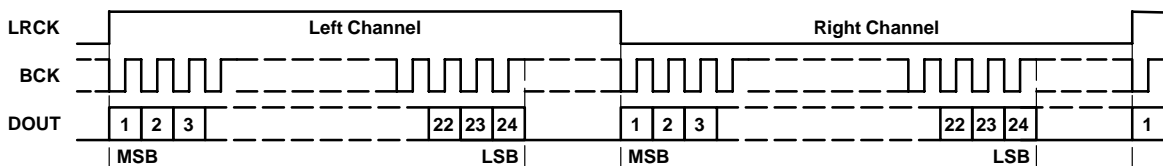

FORMAT 1: FMT[1:0] = 01

DAC: 16-Bit, MSB-First, Right-Justified

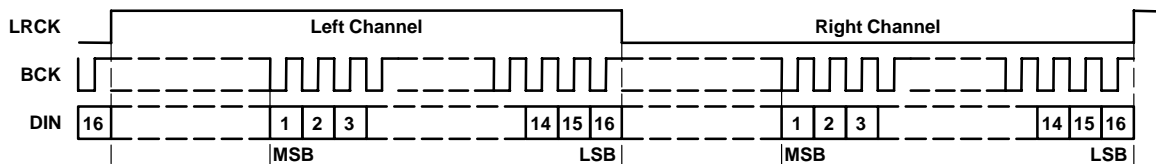

ADC: 24-Bit, MSB-First, Left-Justified

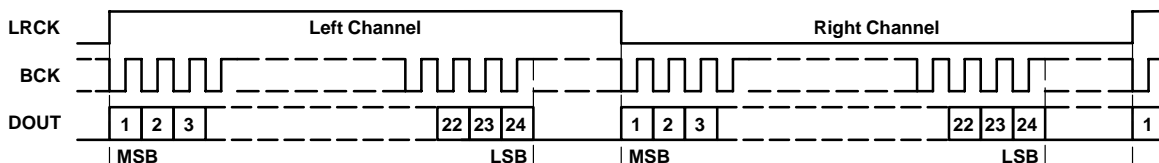
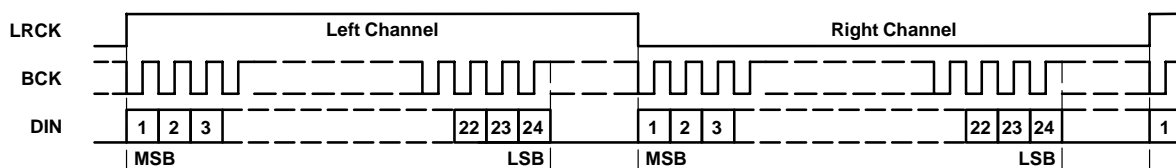

Figure 47. Audio Data Input/Output Format

PCM audio interface (continued)

FORMAT 2: FMT[1:0] = 10

DAC: 24-Bit, MSB-First, Left-Justified



ADC: 24-Bit, MSB-First, Left-Justified

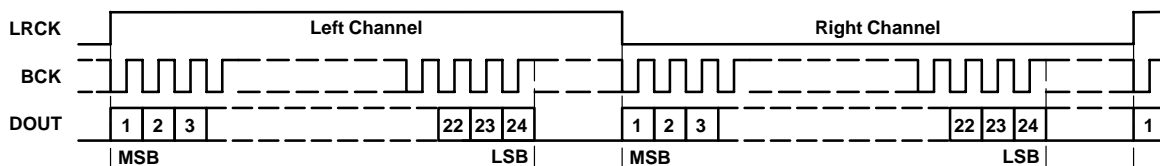

FORMAT 3: FMT[1:0] = 11

DAC: 24-Bit, MSB-First, I<sup>2</sup>S

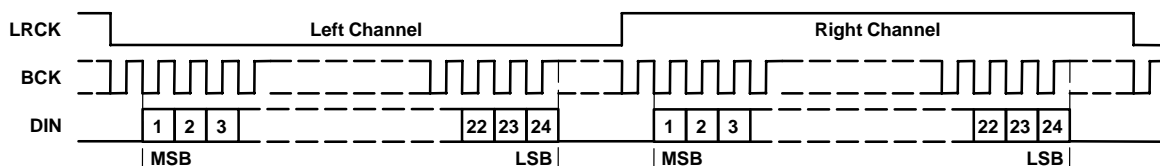

ADC: 24-Bit, MSB-First, I<sup>2</sup>S

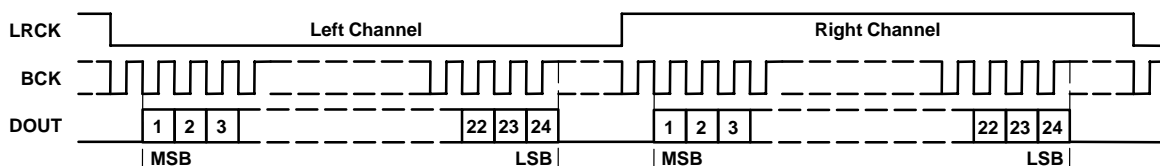
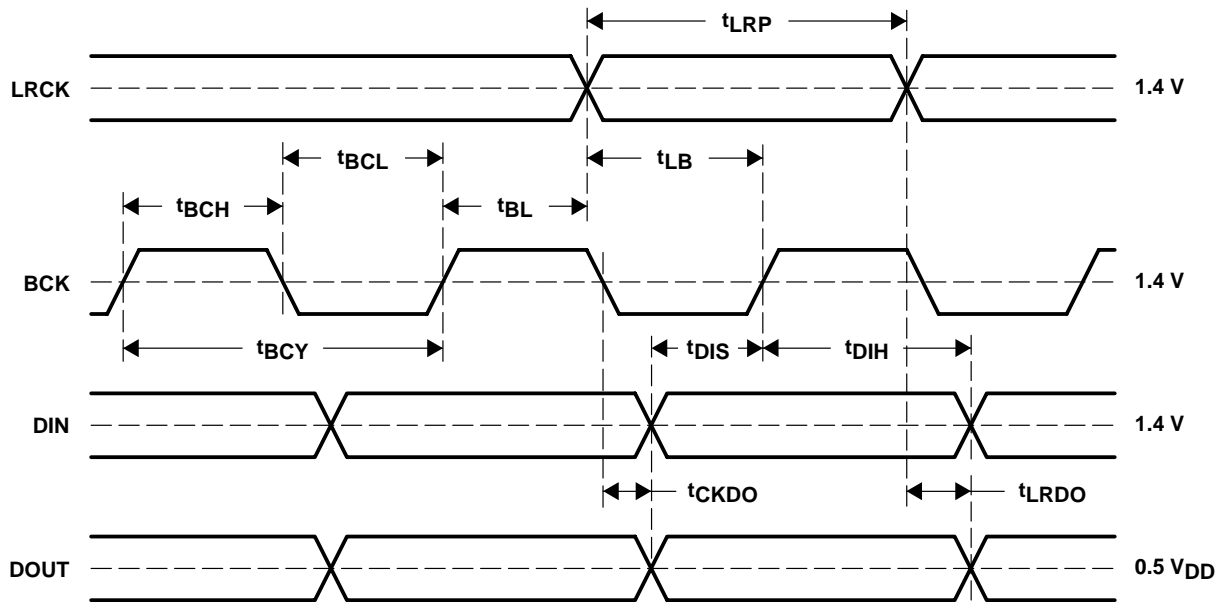

Figure 48. Audio Data Input/Output Format (Continued)

PCM audio interface (continued)



PARAMETER		MIN	MAX	UNIT
$t_{BCY}$	BCK pulse cycle time	80		ns
$t_{BCH}$	BCK pulse duration, HIGH	35		ns
$t_{BCL}$	BCK pulse duration, LOW	35		ns
$t_{BL}$	BCK rising edge to LRCK edge	10		ns
$t_{LB}$	LRCK edge to BCK rising edge	10		ns
$t_{LRP}$	LRCK pulse duration	2.1		$\mu$ s
$t_{DIS}$	DIN setup time	10		ns
$t_{DIH}$	DIN hold time	10		ns
$t_{CKDO}$	DOUT delay time from BCK falling edge		20	ns
$t_{LRDO}$	DOUT delay time from LRCK edge		20	ns
$t_R$	Rising time of all signals		10	ns
$t_F$	Falling time of all signals		10	ns

Figure 49. Audio Data Input/Output Timing

synchronization with digital audio system

The PCM3010 operates with LRCK and BCK synchronized to the system clock. The PCM3010 does not need a specific phase relationship between LRCK, BCK and the system clock, but does require the synchronization of LRCK, BCK, and the system clock.

If the relationship between system clock and LRCK changes more than  $\pm 6$  BCKs during one sample period due to LRCK jitter, etc., internal operation of DAC halts within  $6/f_S$ , and the analog output is forced to  $0.5 V_{CC2}$  until resynchronization between the system clock, LRCK, and BCK is completed and then  $t_{DACDLY2}$  elapses.

Internal operation of the ADC also halts within  $6/f_S$ , and the digital output is forced to a ZERO code until resynchronization between the system clock, LRCK, and BCK is completed, and then  $t_{ADC DLY2}$  elapses.

In the case of changes less than  $\pm 5$  BCKs, resynchronization does not occur and the previously described discontinuity in analog/digital output control does not occur.

## synchronization with digital audio system (continued)

Figure 50 illustrates the DAC analog output and ADC digital output for loss of synchronization.

During undefined data, some noise may be generated in the audio signal. Also, the transition from normal to undefined data and from undefined or zero data to normal creates a data discontinuity on the analog and digital outputs, which may generate some noise in the audio signal.

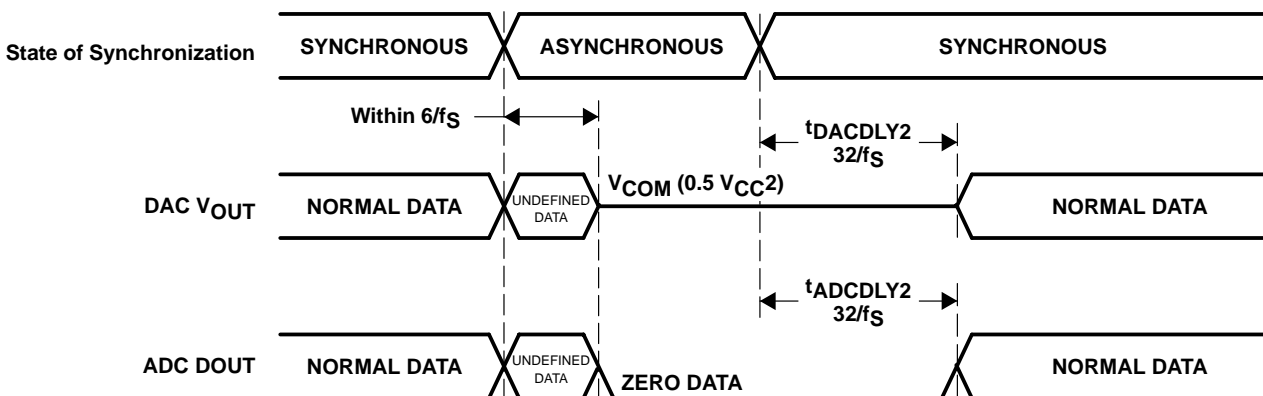

Figure 50. DAC Output and ADC Output for Lost of Synchronization

## de-emphasis control

**DEMP1, DEMP0:** De-emphasis control pins select the de-emphasis mode of the DACs as shown below.

DEMP1	DEMP0	DESCRIPTION
LOW	LOW	De-emphasis 44.1 kHz ON
LOW	HIGH	De-emphasis OFF
HIGH	LOW	De-emphasis 48 kHz ON
HIGH	HIGH	De-emphasis 32 kHz ON

## test control

**TEST:** The TEST pin is used for device testing; it must be connected to DGND for normal operation.

typical circuit connection

The following figure illustrates typical circuit connection.

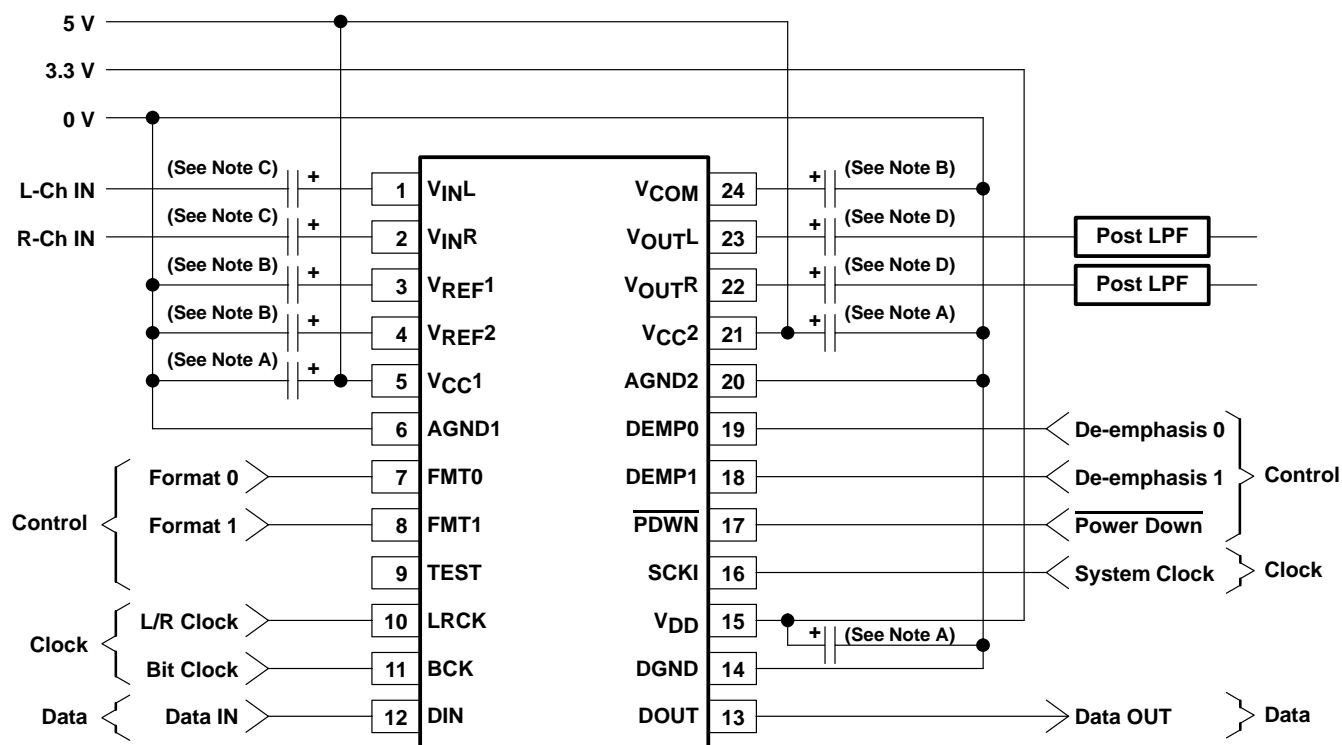

- NOTES: A. 0.1  $\mu$ F ceramic and 10  $\mu$ F electrolytic capacitors typical, depending on power supply quality and pattern layout.  
 B. 0.1  $\mu$ F ceramic and 10  $\mu$ F electrolytic capacitors are recommended.  
 C. 1  $\mu$ F electrolytic capacitor typical, gives 8-Hz cutoff frequency of input HPF in normal operation and gives settling time with 20 ms ( $1 \mu\text{F} \times 20 \text{k}\Omega$ ) time constant in power ON and power down OFF period.  
 D. 10  $\mu$ F electrolytic capacitor typical, gives 2-Hz cutoff frequency for 10-k $\Omega$  post-LPF input resistance in normal operation and gives settling time with 100 ms ( $10 \mu\text{F} \times 10 \text{k}\Omega$ ) time constant in power ON and power down OFF period.

design and layout considerations in application

power supply pins ( $V_{CC1}$ ,  $V_{CC2}$ ,  $V_{DD}$ )

The digital and analog power supply lines to the PCM3010 should be bypassed to the corresponding ground pins, with 0.1- $\mu$ F ceramic and 10- $\mu$ F electrolytic capacitors as close to the pins as possible to maximize the dynamic performance of the ADC and the DAC.

Although the PCM3010 has three power lines to maximize the potential of dynamic performance, using one common 5-V power supply for  $V_{CC1}$  and  $V_{CC2}$  and a 3.3-V power supply, which is generated from the 5-V  $V_{CC1}$  and  $V_{CC2}$  power supply, for  $V_{DD}$ . This power supply arrangement is recommended to avoid unexpected power supply trouble, like latch-up or power supply sequencing problems.

grounding ( $AGND1$ ,  $AGND2$ ,  $DGND$ )

To maximize the dynamic performance of the PCM3010, the analog and digital grounds are not connected internally. These points should have very low impedance to avoid digital noise feeding back into the analog ground. They should be connected directly to each other under the connected parts to reduce the potential for noise problems.

**V<sub>IN</sub> pins**

A 1- $\mu$ F electrolytic capacitor is recommended as an ac-coupling capacitor, which gives an 8-Hz cutoff frequency. If a higher full-scale input voltage is required, it can be adjusted by adding only one series resistor to each V<sub>IN</sub> pin.

**V<sub>REF1</sub>, V<sub>REF2</sub> pins**

A 0.1- $\mu$ F ceramic capacitor and a 10- $\mu$ F electrolytic capacitor are recommended between V<sub>REF1</sub>, V<sub>REF2</sub>, and AGND1 to ensure low source impedance of the ADC references. These capacitors should be located as close as possible to the V<sub>REF1</sub> and V<sub>REF2</sub> pins and the AGND1 pin to reduce dynamic errors on the ADC references.

**V<sub>COM</sub> pin**

A 0.1- $\mu$ F ceramic capacitor and a 10- $\mu$ F electrolytic capacitor are recommended between V<sub>COM</sub> and AGND2 to ensure low source impedance of the DAC common voltage. These capacitors should be located as close as possible to the V<sub>COM</sub> pin to reduce dynamic errors on the DAC common voltage.

**system clock**

The quality of SCKI may influence dynamic performance, as the PCM3010 (both DAC and ADC) operates based on SCKI. Therefore, it may be necessary to consider the jitter, duty cycle, rise and fall time, etc., of the system clock.

**reset control**

If large capacitors (more than 22  $\mu$ F) are used on V<sub>REF1</sub>, V<sub>REF2</sub>, and V<sub>COM</sub>, external reset control by  $\overline{\text{PDWN}} = \text{LOW}$  is required after the V<sub>REF1</sub>, V<sub>REF2</sub>, and V<sub>COM</sub> transient response settles.

**external mute control**

To eliminate the clicking noise which is generated by DAC output dc level change during power-down ON/OFF control, external mute control is generally required. The recommended control sequence is: external mute ON, codec power down ON, SCKI stop and restart if necessary, codec power down OFF, and external mute OFF.

MECHANICAL DATA

DB (R-PDSO-G\*\*)

PLASTIC SMALL-OUTLINE

28 PINS SHOWN

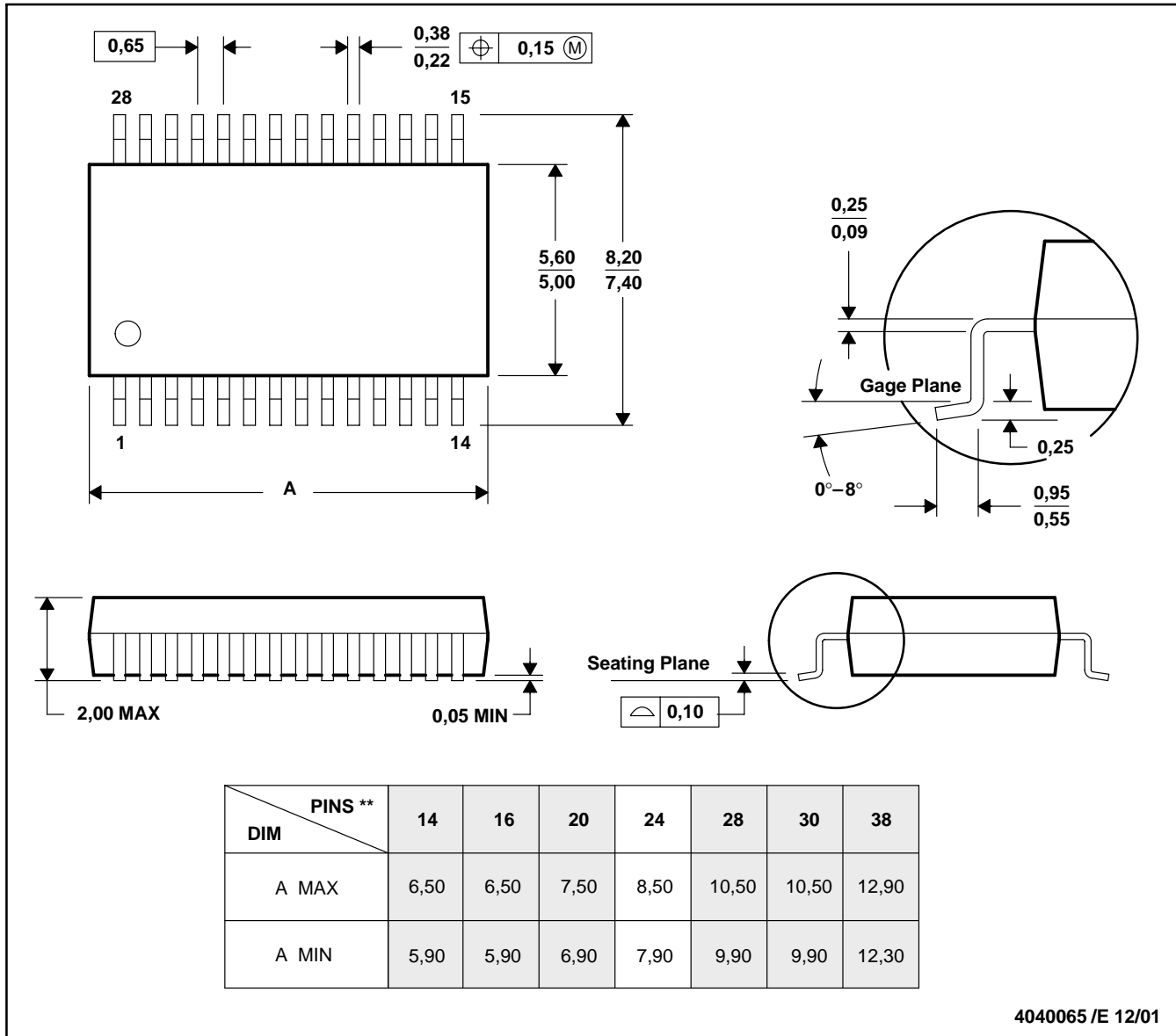

4040065 /E 12/01

- NOTES: A. All linear dimensions are in millimeters.  
 B. This drawing is subject to change without notice.  
 C. Body dimensions do not include mold flash or protrusion not to exceed 0,15.  
 D. Falls within JEDEC MO-150

**PACKAGING INFORMATION**

Orderable part number	Status (1)	Material type (2)	Package   Pins	Package qty   Carrier	RoHS (3)	Lead finish/ Ball material (4)	MSL rating/ Peak reflow (5)	Op temp (°C)	Part marking (6)
<a href="#">PCM3010DB</a>	Active	Production	SSOP (DB)   24	58   TUBE	Yes	NIPDAU	Level-1-260C-UNLIM	-25 to 85	PCM3010
PCM3010DB.B	Active	Production	SSOP (DB)   24	58   TUBE	Yes	NIPDAU	Level-1-260C-UNLIM	-25 to 85	PCM3010
PCM3010DBG4	Active	Production	SSOP (DB)   24	58   TUBE	Yes	NIPDAU	Level-1-260C-UNLIM	-25 to 85	PCM3010
<a href="#">PCM3010DBR</a>	Active	Production	SSOP (DB)   24	2000   LARGE T&R	Yes	NIPDAU	Level-1-260C-UNLIM	-25 to 85	PCM3010
PCM3010DBR.B	Active	Production	SSOP (DB)   24	2000   LARGE T&R	Yes	NIPDAU	Level-1-260C-UNLIM	-25 to 85	PCM3010

(1) **Status:** For more details on status, see our [product life cycle](#).

(2) **Material type:** When designated, preproduction parts are prototypes/experimental devices, and are not yet approved or released for full production. Testing and final process, including without limitation quality assurance, reliability performance testing, and/or process qualification, may not yet be complete, and this item is subject to further changes or possible discontinuation. If available for ordering, purchases will be subject to an additional waiver at checkout, and are intended for early internal evaluation purposes only. These items are sold without warranties of any kind.

(3) **RoHS values:** Yes, No, RoHS Exempt. See the [TI RoHS Statement](#) for additional information and value definition.

(4) **Lead finish/Ball material:** Parts may have multiple material finish options. Finish options are separated by a vertical ruled line. Lead finish/Ball material values may wrap to two lines if the finish value exceeds the maximum column width.

(5) **MSL rating/Peak reflow:** The moisture sensitivity level ratings and peak solder (reflow) temperatures. In the event that a part has multiple moisture sensitivity ratings, only the lowest level per JEDEC standards is shown. Refer to the shipping label for the actual reflow temperature that will be used to mount the part to the printed circuit board.

(6) **Part marking:** There may be an additional marking, which relates to the logo, the lot trace code information, or the environmental category of the part.

Multiple part markings will be inside parentheses. Only one part marking contained in parentheses and separated by a "-" will appear on a part. If a line is indented then it is a continuation of the previous line and the two combined represent the entire part marking for that device.

**Important Information and Disclaimer:**The information provided on this page represents TI's knowledge and belief as of the date that it is provided. TI bases its knowledge and belief on information provided by third parties, and makes no representation or warranty as to the accuracy of such information. Efforts are underway to better integrate information from third parties. TI has taken and continues to take reasonable steps to provide representative and accurate information but may not have conducted destructive testing or chemical analysis on incoming materials and chemicals. TI and TI suppliers consider certain information to be proprietary, and thus CAS numbers and other limited information may not be available for release.

In no event shall TI's liability arising out of such information exceed the total purchase price of the TI part(s) at issue in this document sold by TI to Customer on an annual basis.

**TUBE**

\*All dimensions are nominal

Device	Package Name	Package Type	Pins	SPQ	L (mm)	W (mm)	T (μm)	B (mm)
PCM3010DB	DB	SSOP	24	58	500	10.6	500	9.6
PCM3010DB	DB	SSOP	24	58	530	10.5	4000	4.1
PCM3010DB.B	DB	SSOP	24	58	530	10.5	4000	4.1
PCM3010DB.B	DB	SSOP	24	58	500	10.6	500	9.6
PCM3010DBG4	DB	SSOP	24	58	530	10.5	4000	4.1
PCM3010DBG4	DB	SSOP	24	58	500	10.6	500	9.6
PCM3010DBR	DB	SSOP	24	2000	500	10.6	500	9.6
PCM3010DBR.B	DB	SSOP	24	2000	500	10.6	500	9.6

DB (R-PDSO-G\*\*)

PLASTIC SMALL-OUTLINE

28 PINS SHOWN



- NOTES: A. All linear dimensions are in millimeters.  
 B. This drawing is subject to change without notice.  
 C. Body dimensions do not include mold flash or protrusion not to exceed 0,15.  
 D. Falls within JEDEC MO-150

## IMPORTANT NOTICE AND DISCLAIMER

TI PROVIDES TECHNICAL AND RELIABILITY DATA (INCLUDING DATASHEETS), DESIGN RESOURCES (INCLUDING REFERENCE DESIGNS), APPLICATION OR OTHER DESIGN ADVICE, WEB TOOLS, SAFETY INFORMATION, AND OTHER RESOURCES "AS IS" AND WITH ALL FAULTS, AND DISCLAIMS ALL WARRANTIES, EXPRESS AND IMPLIED, INCLUDING WITHOUT LIMITATION ANY IMPLIED WARRANTIES OF MERCHANTABILITY, FITNESS FOR A PARTICULAR PURPOSE OR NON-INFRINGEMENT OF THIRD PARTY INTELLECTUAL PROPERTY RIGHTS.

These resources are intended for skilled developers designing with TI products. You are solely responsible for (1) selecting the appropriate TI products for your application, (2) designing, validating and testing your application, and (3) ensuring your application meets applicable standards, and any other safety, security, regulatory or other requirements.

These resources are subject to change without notice. TI grants you permission to use these resources only for development of an application that uses the TI products described in the resource. Other reproduction and display of these resources is prohibited. No license is granted to any other TI intellectual property right or to any third party intellectual property right. TI disclaims responsibility for, and you fully indemnify TI and its representatives against any claims, damages, costs, losses, and liabilities arising out of your use of these resources.

TI's products are provided subject to [TI's Terms of Sale](#), [TI's General Quality Guidelines](#), or other applicable terms available either on [ti.com](http://ti.com) or provided in conjunction with such TI products. TI's provision of these resources does not expand or otherwise alter TI's applicable warranties or warranty disclaimers for TI products. Unless TI explicitly designates a product as custom or customer-specified, TI products are standard, catalog, general purpose devices.

TI objects to and rejects any additional or different terms you may propose.

Copyright © 2026, Texas Instruments Incorporated

Last updated 10/2025