

Excalibur 低噪声高速精确运算放大器

1 特性

- 低噪声
 - 10Hz. $\dots 15\text{nV}/\sqrt{\text{Hz}}$
 - 1kHz. $\dots 10.5\text{nV}/\sqrt{\text{Hz}}$
- 负载能力：10000pF
- 短路输出电流：20mA (最小值)
- 压摆率：27V/ μs (最小值)
- 高增益带宽积：5.9MHz
- 低 V_{IO} ：25°C 时最大电压为 500 μV
- 单电源或双电源：4V 至 44V
- 快速稳定时间：
 - 340ns 至 0.1%
 - 400ns 至 0.01%
- 饱和恢复：150ns
- 大输出摆幅：
 - $V_{\text{CC-}} + 0.1\text{V}$ 至 $V_{\text{CC+}} - 1\text{V}$

2 应用

- 电动汽车充电基础设施
- 工业交流-直流
- 火警控制面板 (FACP)
- 串式逆变器

3 说明

TLE214x 和 TLE214xA 器件是采用德州仪器 (TI) 互补双极 Excalibur 工艺制造的高性能内部补偿型运算放大器。TLE214xA 是 TLE214x 的更严格失调电压级。两者都是标准行业产品的引脚兼容升级版。

该设计集成了一个输入级，可同时实现 $10.5\text{nV}/\sqrt{\text{Hz}}$ 的低音频带噪声、10Hz 1/f 角和对称 40V/ μs 压摆率，典型负载高达 800pF。由此产生的低失真和高功率带宽在高保真音频应用中至关重要。在 $2\text{k}\Omega/100\text{pF}$ 负载条件下，10V 阶跃 0.1% 的快速稳定时间为 430ns，这在快速执行器/定位驱动器中非常有用。在类似测试条件下，0.01% 的稳定时间为 640ns。

这两个版本也可用作比较器。 $V_{\text{CC}\pm}$ 的差分输入可以保持而不会损坏器件。在 TTL 电源电平下，开环传播延迟通常为 200ns。当器件的驱动超出推荐输出摆幅的限制时，这可以很好地显示输出级的饱和和恢复情况。

TLE214x 和 TLE214xA 有多种封装可供选择，包括行业标准的 8 引脚小外型版本和适用于高密度系统应用的芯片形式。后缀为 C 的器件在 0°C 至 70°C 的温度范围内运行。后缀为 I 的器件在 -40°C 至 105°C 的温度范围内运行。后缀为 M 的器件覆盖 -55°C 至 125°C 的完整军用温度范围。

封装信息

器件型号	封装 ⁽¹⁾	封装尺寸 ⁽²⁾
TLE2141、 TLE2141A	P (PDIP , 8)	9.81mm × 9.43mm
	D (SOIC , 8)	4.9mm × 6mm
TLE2142	P (PDIP , 8)	9.81mm × 9.43mm
	D (SOIC , 8)	4.9mm × 6mm
	PW (TSSOP , 16)	5mm × 6.4mm
TLE2142A	D (SOIC , 8)	4.9mm × 6mm
TLE2142AM	JG (CDIP , 8)	9.6mm × 6.67mm
	U (CFP , 10)	21.44mm × 6.5mm
	FK (LCCC , 20)	8.89mm × 8.89mm
TLE2142AM-D	D (SOIC , 8)	4.9mm × 6mm
TLE2142M	JG (CDIP , 8)	9.6mm × 6.67mm
	U (CFP , 10)	21.44mm × 6.5mm
	FK (LCCC , 20)	8.89mm × 8.89mm
TLE2142M-D	D (SOIC , 8)	4.9mm × 6mm
TLE2144	N (PDIP , 14)	19.3mm × 9.4mm
	DW (SOIC , 16)	10.3mm × 10.3mm
TLE2144A	N (PDIP , 14)	19.3mm × 9.4mm
TLE2144AM、 TLE2144M	J (CDIP , 14)	19.56mm × 6.67mm
	FK (LCCC , 20)	8.89mm × 8.89mm
TLE2144M-D	DW (SOIC , 16)	10.3mm × 10.3mm

(1) 有关所有可用封装，请参阅 节 9。

(2) 封装尺寸 (长 × 宽) 为标称值，并包括引脚 (如适用)。

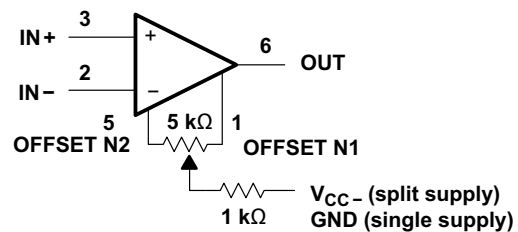

输入失调电压零电路



内容

1 特性	1	5.25 TLE2144I 电气特性	27
2 应用	1	5.26 TLE2144I 工作特性, $V_{CC\pm} = \pm 15V$, $T_A = 25^\circ C$	28
3 说明	1	5.27 TLE2144I 电气特性	29
4 引脚配置和功能	3	5.28 TLE2141M 工作特性, $V_{CC} = 5V$, $T_A = 25^\circ C$	30
5 规格	4	5.29 TLE2141M 电气特性	31
5.1 绝对最大额定值	4	5.30 TLE2141M 工作特性, $V_{CC\pm} = \pm 15V$, $T_A = 25^\circ C$...	32
5.2 建议运行条件	4	5.31 TLE2142M 电气特性	33
5.3 TLE2141C 电气特性	5	5.32 TLE2142M 工作特性, $V_{CC} = 5V$, $T_A = 25^\circ C$	34
5.4 TLE2141C 工作特性, $V_{CC} = 5V$, $T_A = 25^\circ C$	6	5.33 TLE2142M 电气特性	35
5.5 TLE2141C 电气特性	7	5.34 TLE2142M 工作特性, $V_{CC\pm} = \pm 15V$, $T_A = 25^\circ C$...	36
5.6 TLE2141C 工作特性, $V_{CC\pm} = \pm 15V$, $T_A = 25^\circ C$	8	5.35 TLE2144M 电气特性	37
5.7 TLE2142C 电气特性	9	5.36 TLE2144M 工作特性	38
5.8 TLE2142C 工作特性, $V_{CC} = 5V$, $T_A = 25^\circ C$	10	5.37 TLE2144M 电气特性	39
5.9 TLE2142C 电气特性	11	5.38 TLE2144M 工作特性	40
5.10 TLE2142C 工作特性, $V_{CC\pm} = \pm 15V$, $T_A = 25^\circ C$...	12	5.39 TLE2141Y 电气特性	41
5.11 TLE2144C 电气特性	13	5.40 TLE2142Y 电气特性	42
5.12 TLE2144C 工作特性, $V_{CC} = 5V$, $T_A = 25^\circ C$	14	5.41 TLE2144Y 电气特性	43
5.13 TLE2144C 电气特性	15	5.42 典型特性	44
5.14 TLE2144C 工作特性, $V_{CC\pm} = \pm 15V$, $T_A = 25^\circ C$...	16	6 详细说明	54
5.15 TLE2141I 电气特性	17	6.1 概述	54
5.16 TLE2141I 工作特性, $V_{CC} = 5V$, $T_A = 25^\circ C$	18	7 器件和文档支持	55
5.17 TLE2141I 电气特性	19	7.1 接收文档更新通知	55
5.18 TLE2141I 工作特性, $V_{CC\pm} = \pm 15V$, $T_A = 25^\circ C$	20	7.2 支持资源	55
5.19 TLE2142I 电气特性	21	7.3 商标	55
5.20 TLE2142I 工作特性, $V_{CC} = 5V$, $T_A = 25^\circ C$	22	7.4 静电放电警告	55
5.21 TLE2142I 电气特性	23	7.5 术语表	55
5.22 TLE2142I 工作特性, $V_{CC\pm} = \pm 15V$, $T_A = 25^\circ C$	24	8 修订历史记录	55
5.23 TLE2144I 电气特性	25	9 机械、封装和可订购信息	55
5.24 TLE2144C 工作特性, $V_{CC} = 5V$, $T_A = 25^\circ C$	26		

4 引脚配置和功能

**TLE2141
D, JG, OR P PACKAGE
(TOP VIEW)**

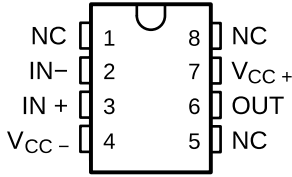

**TLE2141
FK PACKAGE
(TOP VIEW)**

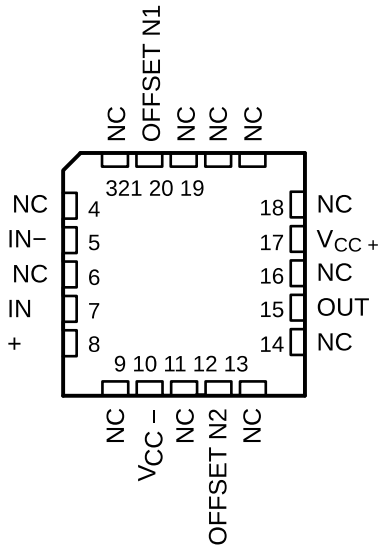

**TLE2142
PW PACKAGE
(TOP VIEW)**

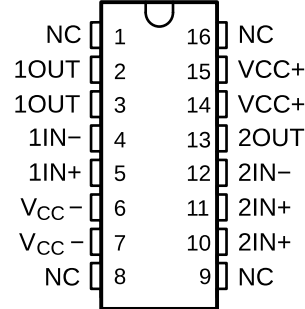

**TLE2142
D, JG, OR P PACKAGE
(TOP VIEW)**

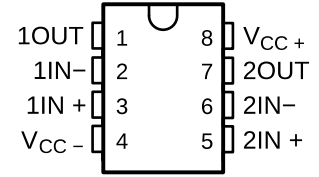

**TLE2142
FK PACKAGE
(TOP VIEW)**

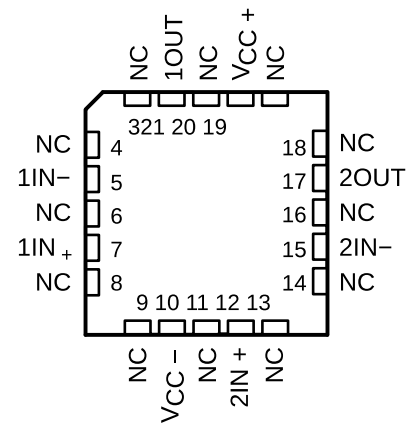

**TLE2142
U PACKAGE
(TOP VIEW)**

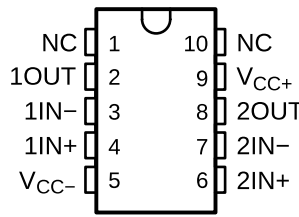

**TLE2144
DW PACKAGE
(TOP VIEW)**

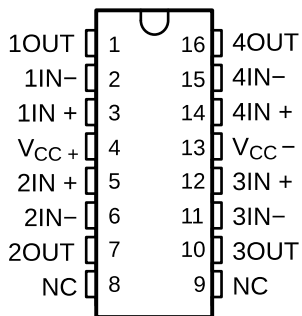

**TLE2144
J OR N PACKAGE
(TOP VIEW)**

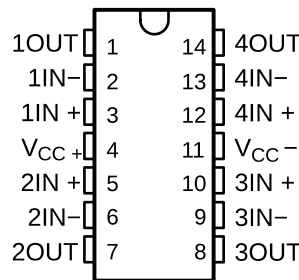

**TLE2144
FK PACKAGE
(TOP VIEW)**

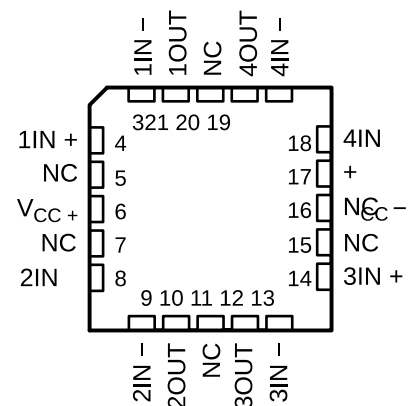

NC - No internal connection

5 规格

5.1 绝对最大额定值

在自然通风条件下的工作温度范围内测得 (除非另有说明) (1)

		值	单位	
V _{CC+}	电源电压(2)	22	V	
V _{CC-}	电源电压	-22	V	
V _{ID}	差分输入电压(3)	±44	V	
V _I	输入电压范围, (任何输入端)	V _{CC+} 至 V _{CC-} -0.3	V	
I _I	输入电流 (每个输入端)	±1	mA	
I _O	输出电流	±80	mA	
	流入 V _{CC+} 的总电流	80	mA	
	流出 V _{CC-} 的总电流	80	mA	
	短路电流的持续时间 (≤ 25°C) (4)	无限		
θ _{JA}	封装热阻抗(5) (6)	D 封装	97.1	°C/W
		DW 封装	57.3	
		N 封装	79.7	
		P 封装	84.6	
		PW 封装	108.4	
θ _{JC}	封装热阻抗(5) (6)	FK 封装	5.6	°C/W
		J 封装	15.1	
		JG 封装	14.5	
		U 封装	14.7	
T _A	自然通风条件下的工作温度范围	C 后缀	0 至 70	°C
		I 后缀	-40 至 105	°C
		M 后缀	-55 至 125	°C
	贮存温度范围	-65 至 150	°C	
	60 秒内的外壳温度: FK 封装	260	°C	
	10 秒内距离外壳 1.6mm (1/16 英寸) 的引线温度: D、DW、N、P 或 PW 封装	260	°C	
	60 秒内距离外壳 1.6mm (1/16 英寸) 的引线温度: J 或 JG 封装	300	°C	

- 应力超出“绝对最大额定值”下列出的值可能会对器件造成永久损坏。这些列出的值仅仅是应力额定值, 这并不表示器件在这些条件下以及在“建议运行条件”以外的任何其他条件下能够正常运行。长时间处于绝对最大额定条件下可能会影响器件的可靠性。
- 除差分电压外的所有电压值均以 V_{CC+} 和 V_{CC-} 之间的中间点为参考基准。
- 差分电压是相对于 IN- 的 IN+ 上的值。如果输入低于 V_{CC-} -0.3V, 则会产生过大的电流。
- 输出端可以短接到任一电源。必须限制温度和/或电源电压, 从而确保不超过最大额定功耗。
- 最大功耗是与 T_{J(max)}、θ_{JA} 和 T_A 相关的函数。在任何允许的环境温度下, 允许的最大功率耗散为 P_D = (T_{J(max)} - T_A) / θ_{JA}。在 150°C 的绝对最大 T_J 下运行可能会影响可靠性。
- 封装热阻抗根据 JEDEC 51-7 (塑料) 和 MIL-STD-883 方法 1012 (陶瓷) 计算。

5.2 建议运行条件

在自然通风条件下的工作温度范围内测得 (除非另有说明)

		C 后缀		I 后缀		M 后缀		单位
		最小值	最大值	最小值	最大值	最小值	最大值	
V _{CC±}	电源电压	±2	±22	±2	±22	±2	±22	V
V _{IC}	共模输入电压	V _{CC} = 5V		0	2.9	0	2.7	V
		V _{CC±} = ±15V		-15	12.9	-15	12.7	
T _A	自然通风条件下的工作温度	0	70	-40	105	-55	125	°C

5.3 TLE2141C 电气特性

在指定自然通风温度下, $V_{CC} = 5V$ (除非另有说明)

参数	测试条件	T_A (1)	TLE2141C			TLE2141AC			单位
			最小值	典型值	最大值	最小值	典型值	最大值	
V_{IO} 输入失调电压	$V_O = 2.5V, R_S = 50\Omega, V_{IC} = 2.5V$	25°C	225	1400	200	1000	μV		
		完整范围	1700			1300			
$\alpha_{V_{IO}}$ 输入失调电压的温度系数		完整范围	1.7			1.7		$\mu V/^\circ C$	
I_{IO} 输入失调电流		25°C	8	100	8	100	nA		
		完整范围	150			150			
I_B 输入偏置电流		25°C	-0.8	-2	-0.8	-2	μA		
	完整范围	-2.1			-2.1				
V_{ICR} 共模输入电压范围	$R_S = 50\Omega$	25°C	0 至 3	-0.3 至 3.2	0 至 3	-0.3 至 3.2	V		
		完整范围	0 至 2.9		0 至 2.9		V		
V_{OH} 高电平输出电压	$I_{OH} = -150\mu A$	25°C	3.9	4.1	3.9	4.1	V		
		完整范围	3.8			3.8			
	$I_{OH} = -1.5mA$	25°C	3.8	4	3.8	4	V		
		完整范围	3.7			3.7			
	$I_{OH} = -15mA$	25°C	3.2	3.7	3.2	3.7	V		
		完整范围	3.2			3.2			
V_{OL} 低电平输出电压	$I_{OL} = 150\mu A$	25°C	75	125	75	125	mV		
		完整范围	150			150			
	$I_{OL} = 1.5mA$	25°C	150	225	150	225	mV		
		完整范围	250			250			
	$I_{OL} = 15mA$	25°C	1.2	1.5	1.2	1.5	V		
		完整范围	1.7			1.7			
A_{VD} 大信号差分电压放大	$V_{CC} = \pm 2.5V, R_L = 2k\Omega, V_O = 1V$ 至 $-1.5V$	25°C	50	220	50	220	V/mV		
		完整范围	25			25			
r_i 输入电阻		25°C	70			70	$M\Omega$		
C_i 输入电容		25°C	2.5			2.5	pF		
Z_o 开环输出阻抗	$f = 1MHz$	25°C	30			30	Ω		
CMRR 共模抑制比	$V_{IC} = V_{ICR}$ 最小值, $R_S = 50\Omega$	25°C	85	118	85	118	dB		
		完整范围	80			80			
k_{SVR} 电源电压抑制比 ($\Delta V_{CC\pm} / \Delta V_{IO}$)	$V_{CC\pm} = \pm 2.5V$ 至 $\pm 15V, R_S = 50\Omega$	25°C	90	106	90	106	dB		
		完整范围	85			85			
I_{CC} 电源电流	$V_O = 2.5V$, 空载, $V_{IC} = 2.5V$	25°C	3.4	4.4	3.4	4.4	mA		
		完整范围	4.6			4.6			

(1) 完整范围为 0°C 至 70°C。

5.4 TLE2141C 工作特性, $V_{CC} = 5V$, $T_A = 25^\circ C$

参数	测试条件	TLE2141C			TLE2141AC			单位
		最小值	典型值	最大值	最小值	典型值	最大值	
SR+ 正压摆率	$A_{VD} = -1$, $R_L = 2k\Omega$, ⁽¹⁾ $C_L = 500pF$	45			45			V/ μs
SR- 负压摆率		42			42			
t_s 稳定时间	$A_{VD} = -1$, 2.5V 阶跃	达 0.1%			0.66			μs
		达 0.01%			0.99			
V_n 等效输入噪声电压	$R_S = 20\Omega$, $f = 10Hz$	15			15			nV/ \sqrt{Hz}
	$R_S = 20\Omega$, $f = 1kHz$	10.5			10.5			
$V_{N(PP)}$ 峰值间等效输入噪声电压	$f = 0.1Hz$ 至 $1Hz$	0.48			0.48			μV
	$f = 0.1Hz$ 至 $10Hz$	0.51			0.51			
I_n 等效输入噪声电流	$f = 10Hz$	1.92			1.92			pA/ \sqrt{Hz}
	$f = 1kHz$	0.5			0.5			
THD + N 总谐波失真 + 噪声	$O = 1V$ 至 $3V$, $R_L = 2k\Omega$, ⁽¹⁾ $A_{VD} = 2$, $f = 10kHz$	0.0052%			0.0052%			
B_1 单位增益带宽	$R_L = 2k\Omega$ ⁽¹⁾ , $C_L = 100pF$ ⁽¹⁾	5.9			5.9			MHz
增益带宽积	$R_L = 2k\Omega$ ⁽¹⁾ , $C_L = 100pF$ ⁽¹⁾ $f = 100kHz$	5.8			5.8			MHz
B_{OM} 最大输出摆幅带宽 ⁽²⁾	$V_{O(PP)} = 2V$, $R_L = 2k\Omega$, ⁽¹⁾ $A_{VD} = 1$, $C_L = 100pF$ ⁽¹⁾	380			380			kHz
ϕ_m 单位增益下的相位裕度	$R_L = 2k\Omega$ ⁽¹⁾ , $C_L = 100pF$ ⁽¹⁾	57°			57°			

- (1) R_L 和 C_L 端接至 2.5V。
 (2) 在 -0.1dB 时测得。

5.5 TLE2141C 电气特性

在指定自然通风温度下， $V_{CC\pm} = \pm 15V$ (除非另有说明)

参数	测试条件	T_A (1)	TLE2141C			TLE2141AC			单位
			最小值	典型值	最大值	最小值	典型值	最大值	
V_{IO} 输入失调电压	$V_{IC} = 0V, R_S = 50\Omega, V_O = 0V$	25°C	200	900	175	500	μV		
		完整范围	1300			800			
$\alpha_{V_{IO}}$ 输入失调电压的温度系数		完整范围	1.7			1.7	$\mu V/^\circ C$		
I_{IO} 输入失调电流		25°C	7	100	7	100	nA		
		完整范围	150			150			
I_B 输入偏置电流		25°C	-0.7	-1.5	-0.7	-1.5	μA		
	完整范围	-1.6			-1.6				
V_{ICR} 共模输入电压范围	$R_S = 50\Omega$	25°C	-15 至 13	-15.3 至 13.2	-15 至 13	-15.3 至 13.2	V		
		完整范围	-15 至 12.9	15.3 至 13.1	-15 至 12.9	-15.3 至 13.1	V		
V_{OM+} 最大正峰值输出电压摆幅	$I_O = -150\mu A$	25°C	13.8	14.1	13.8	14.1	V		
		完整范围	13.7			13.7			
	$I_O = -1.5mA$	25°C	13.7	14	13.7	14			
		完整范围	13.6			13.6			
	$I_O = -15mA$	25°C	13.1	13.7	13.1	13.7			
		完整范围	13			13			
V_{OM-} 最大负峰值输出电压摆幅	$I_O = 150\mu A$	25°C	-14.7	-14.9	-14.7	-14.9	V		
		完整范围	-14.6			-14.6			
	$I_O = 1.5mA$	25°C	-14.5	-14.8	-14.5	-14.8			
		完整范围	-14.4			-14.4			
	$I_O = 15mA$	25°C	-13.4	-13.8	-13.4	-13.8	V		
		完整范围	-13.3			-13.3			
A_{VD} 大信号差分电压放大	$V_O = \pm 10V$	25°C	100	450	100	450	V/mV		
		完整范围	75			75			
r_i 输入电阻	$R_L = 2k\Omega$	25°C	65			65	$M\Omega$		
C_i 输入电容		25°C	2.5			2.5	pF		
Z_o 开环输出阻抗	$f = 1MHz$	25°C	30			30	Ω		
CMRR 共模抑制比	$V_{IC} = V_{ICR}$ 最小值, $R_S = 50\Omega$	25°C	85	108	85	108	dB		
		完整范围	80			80			
k_{SVR} 电源电压抑制比 ($\Delta V_{CC\pm} / \Delta V_{IO}$)	$V_{CC\pm} = \pm 2.5V$ 至 $\pm 15V$, $R_S = 50\Omega$	25°C	90	106	90	106	dB		
		完整范围	85			85			
I_{OS} 短路输出电流	$V_O = 0$	25°C	$V_{ID} = 1V$	-25	-50	-25	-50	mA	
			$V_{ID} = -1V$	20	31	20	31		
I_{CC} 电源电流	$V_O = 0V$, 无负载	25°C	3.5	4.5	3.5	4.5	mA		
		完整范围	4.7			4.7			

(1) 完整范围为 0°C 至 70°C。

5.6 TLE2141C 工作特性, $V_{CC\pm} = \pm 15V$, $T_A = 25^\circ C$

参数	测试条件	TLE2141C			TLE2141AC			单位
		最小值	典型值	最大值	最小值	典型值	最大值	
SR+ 正压摆率	$A_{VD} = -1$, $R_L = 2k\Omega$, $C_L = 500pF$	27 ⁽²⁾	45		27 ⁽²⁾	45		V/ μs
SR- 负压摆率		27 ⁽²⁾	42		27 ⁽²⁾	42		
t_s 稳定时间	$A_{VD} = -1$, 10V 阶跃	达 0.1%	0.43		0.43			μs
		达 0.01%	0.64		0.64			
V_n 等效输入噪声电压	$R_S = 20\Omega$, $f = 10Hz$		15		15		nV/ \sqrt{Hz}	
	$R_S = 20\Omega$, $f = 1kHz$		10.5		10.5			
$V_{N(PP)}$ 峰值间等效输入噪声电压	$f = 0.1Hz$ 至 $1Hz$		0.48		0.48		μV	
	$f = 0.1Hz$ 至 $10Hz$		0.51		0.51			
I_n 等效输入噪声电流	$f = 10Hz$		1.89		1.89		pA/ \sqrt{Hz}	
	$f = 1kHz$		0.47		0.47			
THD + N 总谐波失真 + 噪声	$V_{O(PP)} = 20V$, $R_L = 2k\Omega$, ⁽¹⁾ $A_{VD} = 10$, $f = 10kHz$		0.06%		0.06%			
B_1 单位增益带宽	$R_L = 2k\Omega$, $C_L = 100pF$ ⁽¹⁾		6		6		MHz	
增益带宽积	$R_L = 2k\Omega$, $C_L = 100pF$, ⁽¹⁾ $f = 100kHz$		5.9		5.9		MHz	
B_{OM} 最大输出摆幅带宽 ⁽³⁾	$V_{O(PP)} = 2V$, $R_L = 2k\Omega$, $A_{VD} = 1$, $C_L = 100pF$ ⁽¹⁾		668		668		kHz	
ϕ_m 单位增益下的相位裕度	$R_L = 2k\Omega$, $C_L = 100pF$ ⁽¹⁾		58°		58°			

- (1) R_L 和 C_L 端接至 2.5V。
- (2) 根据特征确定。
- (3) 在 -0.1dB 时测得。

5.7 TLE2142C 电气特性

在指定自然通风温度下， $V_{CC} = 5V$ (除非另有说明)

参数	测试条件	T_A (1)	TLE2142C			TLE2142AC			单位
			最小值	典型值	最大值	最小值	典型值	最大值	
V_{IO} 输入失调电压		25°C	220	1900	200	1500	μV		
		完整范围	2200			1800			
α_{VIO} 输入失调电压的温度系数		完整范围	1.7			1.7			$\mu V/^\circ C$
I_{IO} 输入失调电流	$V_O = 2.5V, R_S = 50\ \Omega, V_{IC} = 2.5V$	25°C	8	100	8	100	nA		
		完整范围	150			150			
I_B 输入偏置电流		25°C	-0.8	-2	-0.8	-2	μA		
		完整范围	-2.1			-2.1			
V_{ICR} 共模输入电压范围	$R_S = 50\ \Omega$	25°C	0 至 3	-0.3 至 3.2	0 至 3	-0.3 至 3.2	V		
		完整范围	0 至 2.9			0 至 2.9			
V_{OH} 高电平输出电压	$I_{OH} = -150\ \mu A$	25°C	3.9	4.1	3.9	4.1	V		
		完整范围	3.8			3.8			
	$I_{OH} = -1.5mA$	25°C	3.8	4	3.8	4	V		
		完整范围	3.7			3.7			
	$I_{OH} = -15mA$	25°C	3.4	3.7	3.4	3.7	V		
		完整范围	3.4			3.4			
V_{OL} 低电平输出电压	$I_{OL} = 150\ \mu A$	25°C	75	125	75	125	mV		
		完整范围	150			150			
	$I_{OL} = 1.5mA$	25°C	150	225	150	225	mV		
		完整范围	250			250			
	$I_{OL} = 15mA$	25°C	1.2	1.4	1.2	1.4	V		
		完整范围	1.5			1.5			
A_{VD} 大信号差分电压放大	$V_{CC} = \pm 2.5V, R_L = 2k\ \Omega, V_O = 1V$ 至 $-1.5V$	25°C	50	220	50	220	V/mV		
		完整范围	25			25			
r_i 输入电阻		25°C	70			70			$M\ \Omega$
C_i 输入电容		25°C	2.5			2.5			pF
Z_o 开环输出阻抗	$f = 1MHz$	25°C	30			30			Ω
CMRR 共模抑制比	$V_{IC} = V_{ICR}$ 最小值, $R_S = 50\ \Omega$	25°C	85	118	85	118	dB		
		完整范围	80			80			
k_{SVR} 电源电压抑制比 ($\Delta V_{CC\pm} / \Delta V_{IO}$)	$V_{CC\pm} = \pm 2.5V$ 至 $\pm 15V, R_S = 50\ \Omega$	25°C	90	106	90	106	dB		
		完整范围	85			85			
I_{CC} 电源电流	$V_O = 2.5V$, 空载, $V_{IC} = 2.5V$	25°C	6.6	8.8	6.6	8.8	mA		
		完整范围	9.2			9.2			

(1) 完整范围为 0°C 至 70°C。

5.8 TLE2142C 工作特性, $V_{CC} = 5V$, $T_A = 25^\circ C$

参数	测试条件	TLE2142C			TLE2142AC			单位
		最小值	典型值	最大值	最小值	典型值	最大值	
SR+ 正压摆率	$A_{VD} = -1$, $R_L = 2k\Omega$, ⁽¹⁾	45			45			V/ μs
SR- 负压摆率	$C_L = 500pF$	42			42			
t_s 稳定时间	$A_{VD} = -1$, 2.5V 阶跃	达 0.1%			0.66			μs
		达 0.01%			0.99			
V_n 等效输入噪声电压	$R_S = 20\Omega$, $f = 10Hz$	15			15			nV/ \sqrt{Hz}
	$R_S = 20\Omega$, $f = 1kHz$	10.5			10.5			
$V_{N(PP)}$ 峰值间等效输入噪声电压	$f = 0.1Hz$ 至 $1Hz$	0.48			0.48			μV
	$f = 0.1Hz$ 至 $10Hz$	0.51			0.51			
I_n 等效输入噪声电流	$f = 10Hz$	1.92			1.92			pA/ \sqrt{Hz}
	$f = 1kHz$	0.5			0.5			
THD + N 总谐波失真 + 噪声	$V_O = 1V$ 至 $3V$, $R_L = 2k\Omega$, ⁽¹⁾ $A_{VD} = 2$, $f = 10kHz$	0.0052%			0.0052%			
B_1 单位增益带宽	$R_L = 2k\Omega$ ⁽¹⁾ , $C_L = 100pF$	5.9			5.9			MHz
增益带宽积	$R_L = 2k\Omega$ ⁽¹⁾ , $C_L = 100pF$, $f = 100kHz$	5.8			5.8			MHz
B_{OM} 最大输出摆幅带宽 ⁽²⁾	$V_{O(PP)} = 2V$, $R_L = 2k\Omega$, ⁽¹⁾ $A_{VD} = 1$, $C_L = 100pF$	380			380			kHz
ϕ_m 单位增益下的相位裕度	$R_L = 2k\Omega$ ⁽¹⁾ , $C_L = 100pF$	57°			57°			

- (1) R_L 端接至 2.5V。
 (2) 在 -0.1dB 时测得。

5.9 TLE2142C 电气特性

在指定自然通风温度下， $V_{CC\pm} = \pm 15V$ (除非另有说明)

参数	测试条件	T_A (1)	TLE2142C			TLE2142AC			单位
			最小值	典型值	最大值	最小值	典型值	最大值	
V_{IO} 输入失调电压	$V_{IC} = 0V, R_S = 50\Omega, V_O = 0V$	25°C	290	1200	275	750	μV		
		完整范围	1600		1200				
α_{VIO} 输入失调电压的温度系数		完整范围	1.7		1.7		$\mu V/^\circ C$		
I_{IO} 输入失调电流		25°C	7	100	7	100	nA		
		完整范围	150		150				
I_B 输入偏置电流		25°C	-0.7	-1.5	-0.7	-1.5	μA		
	完整范围	-1.6		-1.6					
V_{ICR} 共模输入电压范围	$R_S = 50\Omega$	25°C	-15 至 13	-15.3 至 13.2	-15 至 13	-15.3 至 13.2	V		
		完整范围	-15 至 12.9	15.3 至 13.1	-15 至 12.9	-15.3 至 13.1	V		
V_{OM+} 最大正峰值输出电压摆幅	$I_O = -150\mu A$	25°C	13.8	14.1	13.8	14.1	V		
		完整范围	13.7		13.7				
	$I_O = -1.5mA$	25°C	13.7	14	13.7	14			
		完整范围	13.6		13.6				
	$I_O = -15mA$	25°C	13.3	13.7	13.2	13.7			
		完整范围	13.2		13.2				
V_{OM-} 最大负峰值输出电压摆幅	$I_O = 150\mu A$	25°C	-14.7	-14.9	-14.7	-14.9	V		
		完整范围	-14.6		-14.6				
	$I_O = 1.5mA$	25°C	-14.5	-14.8	-14.5	-14.8			
		完整范围	-14.4		-14.4				
	$I_O = 15mA$	25°C	-13.4	-13.8	-13.4	-13.8	V		
		完整范围	-13.3		-13.3				
A_{VD} 大信号差分电压放大	$V_O = \pm 10V$	25°C	100	450	100	450	V/mV		
		完整范围	75		75				
r_i 输入电阻	$R_L = 2k\Omega$	25°C	65			65	$M\Omega$		
C_i 输入电容		25°C	2.5			2.5	pF		
Z_o 开环输出阻抗	$f = 1MHz$	25°C	30			30	Ω		
CMRR 共模抑制比	$V_{IC} = V_{ICR}$ 最小值, $R_S = 50\Omega$	25°C	85	108	85	108	dB		
		完整范围	80		80				
k_{SVR} 电源电压抑制比 ($\Delta V_{CC\pm} / \Delta V_{IO}$)	$V_{CC\pm} = \pm 2.5V$ 至 $\pm 15V$, $R_S = 50\Omega$	25°C	90	106	90	106	dB		
		完整范围	85		85				
I_{OS} 短路输出电流	$V_O = 0$	25°C	$V_{ID} = 1V$	-25	-50	-25	-50	mA	
			$V_{ID} = -1V$	20	31	20	31		
I_{CC} 电源电流	$V_O = 0V$, 无负载	25°C	6.9	9	6.9	9	mA		
		完整范围	9.4		9.4				

(1) 完整范围为 0°C 至 70°C。

5.10 TLE2142C 工作特性, $V_{CC\pm} = \pm 15V$, $T_A = 25^\circ C$

参数	测试条件	TLE2142C			TLE2142AC			单位
		最小值	典型值	最大值	最小值	典型值	最大值	
SR+ 正压摆率	$A_{VD} = -1$, $R_L = 2k\Omega$, $C_L = 500pF$	27 ⁽²⁾	45		27 ⁽²⁾	45		V/ μs
SR- 负压摆率		27 ⁽²⁾	42		27 ⁽²⁾	42		
t_s 稳定时间	$A_{VD} = -1$, 10V 阶跃	达 0.1%	0.43		0.43			μs
		达 0.01%	0.64		0.64			
V_n 等效输入噪声电压	$R_S = 20\Omega$, $f = 10Hz$		15		15		nV/ \sqrt{Hz}	
	$R_S = 20\Omega$, $f = 1kHz$		10.5		10.5			
$V_{N(PP)}$ 峰值间等效输入噪声电压	$f = 0.1Hz$ 至 $1Hz$		0.48		0.48		μV	
	$f = 0.1Hz$ 至 $10Hz$		0.51		0.51			
I_n 等效输入噪声电流	$f = 10Hz$		1.89		1.89		pA/ \sqrt{Hz}	
	$f = 1kHz$		0.47		0.47			
THD + N 总谐波失真 + 噪声	$V_{O(PP)} = 20V$, $R_L = 2k\Omega$, ⁽¹⁾ $A_{VD} = 10$, $f = 10kHz$		0.06%		0.06%			
B_1 单位增益带宽	$R_L = 2k\Omega$, $C_L = 100pF$ ⁽¹⁾		6		6		MHz	
增益带宽积	$R_L = 2k\Omega$, $C_L = 100pF$, ⁽¹⁾ $f = 100kHz$		5.9		5.9		MHz	
B_{OM} 最大输出摆幅带宽 ⁽¹⁾	$V_{O(PP)} = 2V$, $R_L = 2k\Omega$, $A_{VD} = 1$, $C_L = 100pF$ ⁽¹⁾		668		668		kHz	
ϕ_m 单位增益下的相位裕度	$R_L = 2k\Omega$, $C_L = 100pF$ ⁽¹⁾		58°		58°			

(1) 在 -0.1dB 时测得。

5.11 TLE2144C 电气特性

在指定自然通风温度下， $V_{CC} = 5V$ (除非另有说明)

参数	测试条件	T_A (1)	TLE2144C			TLE2144AC			单位
			最小值	典型值	最大值	最小值	典型值	最大值	
V_{IO} 输入失调电压	$V_O = 2.5V, R_S = 50\Omega, V_{IC} = 2.5V$	25°C	0.5 3.8		0.5 3		mV		
		完整范围	4.4		3.6				
$\alpha_{V_{IO}}$ 输入失调电压的温度系数		完整范围	1.7		1.7		$\mu V/^\circ C$		
I_{IO} 输入失调电流		25°C	8 100		8 100		nA		
		完整范围	150		150				
I_B 输入偏置电流		25°C	-0.8 -2		-0.8 -2		μA		
		完整范围	-2.1		-2.1				
V_{ICR} 共模输入电压范围		$R_S = 50\Omega$	25°C	0 至 3	-0.3 至 3.2	0 至 3	-0.3 至 3.2	V	
			完整范围	0 至 2.9		0 至 2.9		V	
V_{OH} 高电平输出电压		$I_{OH} = -150\mu A$	25°C	3.9	4.1	3.9	4.1	V	
	完整范围		3.8		3.8				
	$I_{OH} = -1.5mA$	25°C	3.8	4	3.8	4	V		
		完整范围	3.7		3.7				
	$I_{OH} = -15mA$	25°C	3.4	3.7	3.4	3.7	V		
		完整范围	3.4		3.4				
V_{OL} 低电平输出电压	$I_{OL} = 150\mu A$	25°C	75 125		75 125		mV		
		完整范围	150		150				
	$I_{OL} = 1.5mA$	25°C	150 225		150 225		mV		
		完整范围	250		250				
	$I_{OL} = 15mA$	25°C	1.2 1.6		1.2 1.6		V		
		完整范围	1.7		1.7				
A_{VD} 大信号差分电压放大	$V_{CC} = \pm 2.5V, R_L = 2k\Omega, V_O = 1V$ 至 $-1.5V$	25°C	50	95	50	95	V/mV		
		完整范围	25		25				
r_i 输入电阻		25°C	70		70		$M\Omega$		
C_i 输入电容		25°C	2.5		2.5		pF		
Z_o 开环输出阻抗	$f = 1MHz$	25°C	30		30		Ω		
CMRR 共模抑制比	$V_{IC} = V_{ICR}$ 最小值, $R_S = 50\Omega$	25°C	85	118	85	118	dB		
		完整范围	80		80				
k_{SVR} 电源电压抑制比 ($\Delta V_{CC\pm} / \Delta V_{IO}$)	$V_{CC\pm} = \pm 2.5V$ 至 $\pm 15V, R_S = 50\Omega$	25°C	90	106	90	106	dB		
		完整范围	85		85				
I_{CC} 电源电流	$V_O = 2.5V$, 空载, $V_{IC} = 2.5V$	25°C	13.2 17.6		13.2 17.6		mA		
		完整范围	18.5		18.5				

(1) 完整范围为 0°C 至 70°C。

5.12 TLE2144C 工作特性, $V_{CC} = 5V$, $T_A = 25^\circ C$

参数	测试条件	TLE2144C			TLE2144AC			单位
		最小值	典型值	最大值	最小值	典型值	最大值	
SR+ 正压摆率	$A_{VD} = -1$, $R_L = 2k\Omega^{(1)}$, $C_L = 500pF$	45			45			V/ μs
SR- 负压摆率		42			42			
t_s 稳定时间	$A_{VD} = -1$, 2.5V 阶跃	达 0.1%			0.66			μs
		达 0.01%			0.99			
V_n 等效输入噪声电压	$R_S = 20\Omega$, $f = 10Hz$	15			15			nV/ \sqrt{Hz}
	$R_S = 20\Omega$, $f = 1kHz$	10.5			10.5			
$V_{N(PP)}$ 峰值间等效输入噪声电压	$f = 0.1Hz$ 至 $1Hz$	0.48			0.48			μV
	$f = 0.1Hz$ 至 $10Hz$	0.51			0.51			
I_n 等效输入噪声电流	$f = 10Hz$	1.92			1.92			pA/ \sqrt{Hz}
	$f = 1kHz$	0.5			0.5			
THD + N 总谐波失真 + 噪声	$O = 1V$ 至 $3V$, $R_L = 2k\Omega$, (1) $A_{VD} = 2$, $f = 10kHz$	0.0052%			0.0052%			
B_1 单位增益带宽	$R_L = 2k\Omega^{(1)}$, $C_L = 100pF$	5.9			5.9			MHz
增益带宽积	$R_L = 2k\Omega^{(1)}$, $C_L = 100pF$, $f = 100kHz$	5.8			5.8			MHz
B_{OM} 最大输出摆幅带宽 (2)	$V_{O(PP)} = 2V$, $R_L = 2k\Omega$, (1) $A_{VD} = 1$, $C_L = 100pF$	380			380			kHz
ϕ_m 单位增益下的相位裕度	$R_L = 2k\Omega^{(1)}$, $C_L = 100pF$	57°			57°			

- (1) R_L 端接至 2.5V。
 (2) 在 -0.1dB 时测得。

5.13 TLE2144C 电气特性

在指定自然通风温度下， $V_{CC\pm} = \pm 15V$ (除非另有说明)

参数	测试条件	T_A (1)	TLE2144C			TLE2144AC			单位
			最小值	典型值	最大值	最小值	典型值	最大值	
V_{IO} 输入失调电压		25°C	0.6	2.4		0.5	1.5	μV	
		完整范围			3.2		2.4		
α_{VIO} 输入失调电压的温度系数		完整范围	1.7			1.7		$\mu V/^\circ C$	
I_{IO} 输入失调电流	$V_{IC} = 0, R_S = 50 \Omega, V_O = 0$	25°C	7	100		7	100	nA	
		完整范围			150		150		
I_B 输入偏置电流		25°C	-0.7	-1.5		-0.7	-1.5	μA	
		完整范围			-1.6		-1.6		
V_{ICR} 共模输入电压范围	$R_S = 50 \Omega$	25°C	-15 至 13	-15.3 至 13.2		-15 至 13	-15.3 至 13.2	V	
		完整范围	-15 至 12.9	15.3 至 13.1		-15 至 12.9	-15.3 至 13.1	V	
V_{OM+} 最大正峰值输出电压摆幅	$I_O = -150 \mu A$	25°C	13.8	14.1		13.8	14.1	V	
		完整范围	13.7			13.7			
	$I_O = -1.5mA$	25°C	13.7	14		13.7	14		
		完整范围	13.6			13.6			
	$I_O = -15mA$	25°C	13.1	13.7		13.1	13.7		
		完整范围	13			13			
V_{OM-} 最大负峰值输出电压摆幅	$I_O = 150 \mu A$	25°C	-14.7	-14.9		-14.7	-14.9	V	
		完整范围	-14.6			-14.6			
	$I_O = 1.5mA$	25°C	-14.5	-14.8		-14.5	-14.8		
		完整范围	-14.4			-14.4			
	$I_O = 15mA$	25°C	-13.4	-13.8		-13.4	-13.8		
		完整范围	-13.3			-13.3			
A_{VD} 大信号差分电压放大	$V_O = \pm 10V, R_L = 2k \Omega$	25°C	100	170		100	170	V/mV	
		完整范围	75			75			
r_i 输入电阻		25°C	65			65	$M \Omega$		
C_i 输入电容		25°C	2.5			2.5	pF		
Z_o 开环输出阻抗	$f = 1MHz$	25°C	30			30	Ω		
CMRR 共模抑制比	$V_{IC} = V_{ICR}$ 最小值, $R_S = 50 \Omega$	25°C	85	108		85	108	dB	
		完整范围	80			80			
k_{SVR} 电源电压抑制比 ($\Delta V_{CC\pm} / \Delta V_{IO}$)	$V_{CC\pm} = \pm 2.5V$ 至 $\pm 15V, R_S = 50 \Omega$	25°C	90	106		90	106	dB	
		完整范围	85			85			
I_{OS} 短路输出电流	$V_O = 0$	25°C	$V_{ID} = 1V$	-25	-50		-25	-50	mA
			$V_{ID} = -1V$	20	31		20	31	
I_{CC} 电源电流	$V_O = 0V, 无负载$	25°C	13.8	18		13.8	18	mA	
		完整范围			18.8		18.8		

(1) 完整范围为 0°C 至 70°C。

5.14 TLE2144C 工作特性, $V_{CC\pm} = \pm 15V$, $T_A = 25^\circ C$

参数	测试条件	TLE2144C			TLE2144AC			单位
		最小值	典型值	最大值	最小值	典型值	最大值	
SR+ 正压摆率	$A_{VD} = -1$, $R_L = 2k\Omega$, $C_L = 500pF$	27 ⁽¹⁾	45		27 ⁽¹⁾	45		V/ μs
SR- 负压摆率		27 ⁽¹⁾	42		27 ⁽¹⁾	42		
t_s 稳定时间	$A_{VD} = -1$, 10V 阶跃	达 0.1%	0.43		0.43			μs
		达 0.01%	0.64		0.64			
V_n 等效输入噪声电压	$R_S = 20\Omega$, $f = 10Hz$		15		15		nV/ \sqrt{Hz}	
	$R_S = 20\Omega$, $f = 1kHz$		10.5		10.5			
$V_{N(PP)}$ 峰值间等效输入噪声电压	$f = 0.1Hz$ 至 $1Hz$		0.48		0.48		μV	
	$f = 0.1Hz$ 至 $10Hz$		0.51		0.51			
I_n 等效输入噪声电流	$f = 10Hz$		1.89		1.89		pA/ \sqrt{Hz}	
	$f = 1kHz$		0.47		0.47			
THD + N 总谐波失真 + 噪声	$V_{O(PP)} = 20V$, $R_L = 2k\Omega$, $A_{VD} = 10$, $f = 10kHz$		0.06%		0.06%			
B_1 单位增益带宽	$R_L = 2k\Omega$, $C_L = 100pF$		6		6		MHz	
增益带宽积	$R_L = 2k\Omega$, $C_L = 100pF$, $f = 100kHz$		5.9		5.9		MHz	
B_{OM} 最大输出摆幅带宽 ⁽²⁾	$V_{O(PP)} = 2V$, $R_L = 2k\Omega$, $A_{VD} = 1$, $C_L = 100pF$		668		668		kHz	
ϕ_m 单位增益下的相位裕度	$R_L = 2k\Omega$, $C_L = 100pF$		58°		58°			

- (1) 根据特征确定。
 (2) 在 -0.1dB 时测得。

5.15 TLE2141I 电气特性

在指定自然通风温度下， $V_{CC} = 5V$ (除非另有说明)

参数	测试条件	T_A (1)	TLE2141I			TLE2141AI			单位
			最小值	典型值	最大值	最小值	典型值	最大值	
V_{IO} 输入失调电压	$V_O = 2.5V, R_S = 50\Omega, V_{IC} = 2.5V$	25°C	225	1400	200	1000	mV		
		完整范围	1900		1500				
α_{VIO} 输入失调电压的温度系数		完整范围	1.7		1.7		$\mu V/^\circ C$		
I_{IO} 输入失调电流		25°C	8	100	8	100	nA		
		完整范围	200		200				
I_{IB} 输入偏置电流		25°C	-0.8	-2	-0.8	-2	μA		
	完整范围	-2.2		-2.2					
V_{ICR} 共模输入电压范围	$R_S = 50\Omega$	25°C	0 至 3	-0.3 至 3.2	0 至 3	-0.3 至 3.2	V		
		完整范围	0 至 2.7	-0.3 至 2.9	0 至 2.7	-0.3 至 2.9	V		
V_{OH} 高电平输出电压	$I_{OH} = -150\mu A$	25°C	3.9	4.1	3.9	4.1	V		
	$I_{OH} = -1.5mA$		3.8	4	3.8	4			
	$I_{OH} = -15mA$		3.2	3.7	3.2	3.7			
	$I_{OH} = -100\mu A$	完整范围	3.8		3.8		V		
	$I_{OH} = -1mA$		3.7		3.7				
	$I_{OH} = -10mA$		3.3		3.3				
V_{OL} 低电平输出电压	$I_{OL} = 150\mu A$	25°C	75	125	75	125	mV		
	$I_{OL} = 1.5mA$		150	225	150	225			
	$I_{OL} = 15mA$		1.2	1.6	1.2	1.6			
	$I_{OL} = 100\mu A$	完整范围	175		175		mV		
	$I_{OL} = 1mA$		225		225				
	$I_{OL} = 10mA$		1.4		1.4				
A_{VD} 大信号差分电压放大	$V_{CC} = \pm 2.5V, R_L = 2k\Omega, V_O = 1V$ 至 $-1.5V$	25°C	50	220	50	220	V/mV		
		完整范围	10		10				
r_i 输入电阻		25°C	70			$M\Omega$			
C_i 输入电容		25°C	2.5			pF			
Z_o 开环输出阻抗	$f = 1MHz$	25°C	30			Ω			
CMRR 共模抑制比	$V_{IC} = V_{ICR}$ 最小值, $R_S = 50\Omega$	25°C	85	118	85	118	dB		
		完整范围	80		80				
k_{SVR} 电源电压抑制比 ($\Delta V_{CC\pm} / \Delta V_{IO}$)	$V_{CC\pm} = \pm 2.5V$ 至 $\pm 15V, R_S = 50\Omega$	25°C	90	106	90	106	dB		
		完整范围	85		85				
I_{CC} 电源电流	$V_O = 2.5V$, 空载, $V_{IC} = 2.5V$	25°C	3.4	4.4	3.4	4.4	mA		
		完整范围	4.6		4.6				

(1) 完整范围为 $-40^\circ C$ 至 $105^\circ C$ 。

5.16 TLE2141I 工作特性, $V_{CC} = 5V$, $T_A = 25^\circ C$

参数	测试条件	TLE2141I			TLE2141AI			单位
		最小值	典型值	最大值	最小值	典型值	最大值	
SR+ 正压摆率	$A_{VD} = -1$, $R_L = 2k\Omega^{(1)}$, $C_L = 500pF$	45			45			V/ μs
SR- 负压摆率		42			42			
t_s 稳定时间	$A_{VD} = -1$, 2.5V 阶跃	达 0.1%			0.66			μs
		达 0.01%			0.99			
V_n 等效输入噪声电压	$R_S = 20\Omega$, $f = 10Hz$	15			15			nV/ \sqrt{Hz}
	$R_S = 20\Omega$, $f = 1kHz$	10.5			10.5			
$V_{N(PP)}$ 峰值间等效输入噪声电压	$f = 0.1Hz$ 至 $1Hz$	0.48			0.48			μV
	$f = 0.1Hz$ 至 $10Hz$	0.51			0.51			
I_n 等效输入噪声电流	$f = 10Hz$	1.92			1.92			pA/ \sqrt{Hz}
	$f = 1kHz$	0.5			0.5			
THD + N 总谐波失真 + 噪声	$O = 1V$ 至 $3V$, $R_L = 2k\Omega$, $A_{VD} = 2$, $f = 10kHz$	0.0052%			0.0052%			
B_1 单位增益带宽	$R_L = 2k\Omega^{(1)}$, $C_L = 100pF^{(1)}$	5.9			5.9			MHz
增益带宽积	$R_L = 2k\Omega^{(1)}$, $C_L = 100pF^{(1)}$, $f = 100kHz$	5.8			5.8			MHz
B_{OM} 最大输出摆幅带宽 ⁽²⁾	$V_{O(PP)} = 2V$, $R_L = 2k\Omega$, $A_{VD} = 1$, $C_L = 100pF$	380			380			kHz
ϕ_m 单位增益下的相位裕度	$R_L = 2k\Omega^{(1)}$, $C_L = 100pF^{(1)}$	57°			57°			

- (1) R_L 和 C_L 端接至 2.5V。
 (2) 在 -0.1dB 时测得。

5.17 TLE2141I 电气特性

在指定自然通风温度下, $V_{CC\pm} = \pm 15V$ (除非另有说明)

参数	测试条件	T_A (1)	TLE2141I			TLE2141AI			单位
			最小值	典型值	最大值	最小值	典型值	最大值	
V_{IO} 输入失调电压	$V_{IC} = 0, R_S = 50 \Omega, V_O = 0$	25°C	200	900	175	500	μV		
		完整范围	1500		1000				
α_{VIO} 输入失调电压的温度系数		完整范围	1.7		1.7		$\mu V/^\circ C$		
I_{IO} 输入失调电流		25°C	7	100	7	100	nA		
		完整范围	200		200				
I_B 输入偏置电流		25°C	-0.7	-1.5	-0.7	-1.5	μA		
	完整范围	-1.7		-1.7					
V_{ICR} 共模输入电压范围	$R_S = 50 \Omega$	25°C	-15 至 13	-15.3 至 13.2	-15 至 13	-15.3 至 13.2	V		
		完整范围	-15 至 12.7	15.3 至 12.9	-15 至 12.7	-15.3 至 12.9	V		
V_{OM+} 最大正峰值输出电压摆幅	$I_O = -150 \mu A$ $I_O = -1.5mA$ $I_O = -15mA$ $I_O = 100 \mu A$ $I_O = 1mA$ $I_O = 10mA$	25°C	13.8	14.1	13.8	14.1	V		
			13.7	14	13.7	14			
			13.1	13.7	13.1	13.7			
		完整范围	13.7		13.7				
			13.6		13.6				
			13.1		13.1				
V_{OM-} 最大负峰值输出电压摆幅	$I_O = 150 \mu A$ $I_O = 1.5mA$ $I_O = 15mA$ $I_O = 100 \mu A$ $I_O = 1mA$ $I_O = 10mA$	25°C	-14.7	-14.9	-14.7	-14.9	V		
			-14.5	-14.8	-14.5	-14.8			
			-13.4	-13.8	-13.4	-13.8			
		完整范围	-14.6		-14.6				
			-14.5		-14.5				
			-13.4		-13.4				
A_{VD} 大信号差分电压放大	$V_O = \pm 10V, R_L = 2k \Omega$	25°C	100	450	100	450	V/mV		
		完整范围	40		40				
r_i 输入电阻		25°C	65			$M \Omega$			
c_i 输入电容		25°C	2.5			pF			
Z_o 开环输出阻抗	$f = 1MHz$	25°C	30			Ω			
CMRR 共模抑制比	$V_{IC} = V_{ICR}$ 最小值, $R_S = 50 \Omega$	25°C	85	108	85	108	dB		
		完整范围	80		80				
k_{SVR} 电源电压抑制比 ($\Delta V_{CC\pm} / \Delta V_{IO}$)	$V_{CC\pm} = \pm 2.5V$ 至 $\pm 15V$, $R_S = 50 \Omega$	25°C	90	106	90	106	dB		
		完整范围	85		85				
I_{OS} 短路输出电流	$V_O = 0$	25°C	$V_{ID} = 1V$	-25	-50	-25	-50	mA	
			$V_{ID} = -1V$	20	31	20	31		
I_{CC} 电源电流	$V_O = 0V$, 无负载	25°C	3.5	4.5	3.5	4.5	mA		
		完整范围	4.7		4.7				

(1) 完整范围为 $-40^\circ C$ 至 $105^\circ C$ 。

5.18 TLE2141I 工作特性, $V_{CC\pm} = \pm 15V$, $T_A = 25^\circ C$

参数	测试条件	TLE2141I			TLE2141AI			单位
		最小值	典型值	最大值	最小值	典型值	最大值	
SR+ 正压摆率	$A_{VD} = -1$, $R_L = 2k\Omega$, $C_L = 500pF$	27 ⁽¹⁾	45		27 ⁽¹⁾	45		V/ μs
SR- 负压摆率		27 ⁽¹⁾	42		27 ⁽¹⁾	42		
t_s 稳定时间	$A_{VD} = -1$, 10V 阶跃	达 0.1%		0.43	0.43		μs	
		达 0.01%		0.64	0.64			
V_n 等效输入噪声电压	$R_S = 20\Omega$, $f = 10Hz$	15			15			nV/ \sqrt{Hz}
	$R_S = 20\Omega$, $f = 1kHz$	10.5			10.5			
$V_{N(PP)}$ 峰值间等效输入噪声电压	$f = 0.1Hz$ 至 $1Hz$	0.48			0.48			μV
	$f = 0.1Hz$ 至 $10Hz$	0.51			0.51			
I_n 等效输入噪声电流	$f = 10Hz$	1.89			1.89			pA/ \sqrt{Hz}
	$f = 1kHz$	0.47			0.47			
THD + N 总谐波失真 + 噪声	$V_{O(PP)} = 20V$, $R_L = 2k\Omega$, $A_{VD} = 10$, $f = 10kHz$	0.06%			0.06%			
B_1 单位增益带宽	$R_L = 2k\Omega$, $C_L = 100pF$	6			6			MHz
增益带宽积	$R_L = 2k\Omega$, $C_L = 100pF$, $f = 100kHz$	5.9			5.9			MHz
B_{OM} 最大输出摆幅带宽 ⁽²⁾	$V_{O(PP)} = 2V$, $R_L = 2k\Omega$, $A_{VD} = 1$, $C_L = 100pF$	668			668			kHz
ϕ_m 单位增益下的相位裕度	$R_L = 2k\Omega$, $C_L = 100pF$	58°			58°			

- (1) 根据特征确定。
 (2) 在 -0.1dB 时测得。

5.19 TLE2142I 电气特性

在指定自然通风温度下, $V_{CC} = 5V$ (除非另有说明)

参数	测试条件	T_A (1)	TLE2142I			TLE2142AI			单位
			最小值	典型值	最大值	最小值	典型值	最大值	
V_{IO} 输入失调电压	$V_O = 2.5V, R_S = 50\Omega, V_{IC} = 2.5V$	25°C	220	1900	220	1500	μV		
		完整范围	2400		2000				
$\alpha_{V_{IO}}$ 输入失调电压的温度系数		完整范围	1.7		1.7		$\mu V/^\circ C$		
I_{IO} 输入失调电流		25°C	8	100	8	100	nA		
		完整范围	200		200				
I_{IB} 输入偏置电流		25°C	-0.8	-2	-0.8	-2	μA		
	完整范围	-2.2		-2.2					
V_{ICR} 共模输入电压范围	$R_S = 50\Omega$	25°C	0 至 3	-0.3 至 3.2	0 至 3	-0.3 至 3.2	V		
		完整范围	0 至 2.7	-0.3 至 2.9	0 至 2.7	-0.3 至 2.9	V		
V_{OH} 高电平输出电压	$I_{OH} = -150\mu A$ $I_{OH} = -1.5mA$ $I_{OH} = -15mA$ $I_{OH} = 100\mu A$ $I_{OH} = 1mA$ $I_{OH} = 10mA$	25°C	13.8	14.1	13.8	14.1	V		
			13.7	14	13.7	14			
			13.1	13.7	13.1	13.7			
		完整范围	13.7		13.7				
			13.6		13.6				
			13.1		13.1				
V_{OL} 低电平输出电压	$I_{OL} = 150\mu A$ $I_{OL} = 1.5mA$ $I_{OL} = 15mA$ $I_{OL} = 100\mu A$ $I_{OL} = 1mA$ $I_{OL} = 10mA$	25°C	3.9	4.1	3.9	4.1	mV		
			3.8	4	3.8	4			
			3.4	3.7	3.4	3.7			
		完整范围	3.8		3.8				
			3.7		3.7				
			3.5		3.5				
A_{VD} 大信号差分电压放大	$V_{IC} = \pm 2.5V, R_L = 2k\Omega, V_O = 1V$ 至 $-1.5V$	25°C	50	220	50	220	V/mV		
		完整范围	10		10				
r_i 输入电阻		25°C	70			$M\Omega$			
C_i 输入电容		25°C	2.5			pF			
Z_o 开环输出阻抗	$f = 1MHz$	25°C	30			Ω			
CMRR 共模抑制比	$V_{IC} = V_{ICR}$ 最小值, $R_S = 50\Omega$	25°C	85	118	85	118	dB		
		完整范围	80		80				
k_{SVR} 电源电压抑制比 ($\Delta V_{CC\pm} / \Delta V_{IO}$)	$V_{CC\pm} = \pm 2.5V$ 至 $\pm 15V, R_S = 50\Omega$	25°C	90	106	90	106	dB		
		完整范围	85		85				
I_{CC} 电源电流	$V_O = 2.5V, V_{IC} = 2.5V$, 空载	25°C	6.6	8.8	6.6	8.8	mA		
		完整范围	9.2		9.2				

(1) 完整范围为 $-40^\circ C$ 至 $105^\circ C$ 。

5.20 TLE2142I 工作特性, $V_{CC} = 5V$, $T_A = 25^\circ C$

参数	测试条件	TLE2142I			TLE2142AI			单位
		最小值	典型值	最大值	最小值	典型值	最大值	
SR+ 正压摆率	$A_{VD} = -1$, $R_L = 2k\Omega^{(1)}$, $C_L = 500pF$	45			45			V/ μs
SR- 负压摆率		42			42			
t_s 稳定时间	$A_{VD} = -1$, 2.5V 阶跃	达 0.1%			0.66			μs
		达 0.01%			0.99			
V_n 等效输入噪声电压	$R_S = 20\Omega$, $f = 10Hz$	15			15			nV/ \sqrt{Hz}
	$R_S = 20\Omega$, $f = 1kHz$	10.5			10.5			
$V_{N(PP)}$ 峰值间等效输入噪声电压	$f = 0.1Hz$ 至 $1Hz$	0.48			0.48			μV
	$f = 0.1Hz$ 至 $10Hz$	0.51			0.51			
I_n 等效输入噪声电流	$f = 10Hz$	1.92			1.92			pA/ \sqrt{Hz}
	$f = 1kHz$	0.5			0.5			
THD + N 总谐波失真 + 噪声	$V_O = 1V$ 至 $3V$, $R_L = 2k\Omega^{(1)}$, $A_{VD} = 2$, $f = 10kHz$	0.0052%			0.0052%			
B_1 单位增益带宽	$R_L = 2k\Omega^{(1)}$, $C_L = 100pF$	5.9			5.9			MHz
增益带宽积	$R_L = 2k\Omega^{(1)}$, $C_L = 100pF$, $f = 100kHz$	5.8			5.8			MHz
B_{OM} 最大输出摆幅带宽 ⁽²⁾	$V_{O(PP)} = 2V$, $R_L = 2k\Omega^{(1)}$, $A_{VD} = 1$, $C_L = 100pF$	380			380			kHz
ϕ_m 单位增益下的相位裕度	$R_L = 2k\Omega^{(1)}$, $C_L = 100pF$	57°			57°			

- (1) R_L 端接至 2.5V。
- (2) 在 -0.1dB 时测得。

5.21 TLE2142I 电气特性

在指定自然通风温度下， $V_{CC\pm} = \pm 15V$ (除非另有说明)

参数	测试条件	T_A (1)	TLE2142I			TLE2142I			单位
			最小值	典型值	最大值	最小值	典型值	最大值	
V_{IO} 输入失调电压		25°C	290	1200		275	750	μV	
		完整范围	1800		1400				
α_{VIO} 输入失调电压的温度系数		完整范围	1.7		1.7		$\mu V/^\circ C$		
I_{IO} 输入失调电流	$V_{IC} = 0, R_S = 50 \Omega, V_O = 0$	25°C	7	100	7	100	nA		
		完整范围	200		200				
I_{IB} 输入偏置电流		25°C	-0.7	-1.5	-0.7	-1.5	μA		
		完整范围	-1.7		-1.7				
V_{ICR} 共模输入电压范围	$R_S = 50 \Omega$	25°C	-15 至 13	-15.3 至 13.2	-15 至 13	-15.3 至 13.2	V		
		完整范围	-15 至 12.7	15.3 至 12.9	-15 至 12.7	-15.3 至 12.9	V		
V_{OM+} 最大正峰值输出电压摆幅	$I_O = -150 \mu A$	25°C	13.8	14.1	13.8	14.1	V		
	$I_O = -1.5mA$		13.7	14	13.7	14			
	$I_O = -15mA$		13.3	13.7	13.3	13.7			
	$I_O = -100 \mu A$	完整范围	13.7	13.7	13.7	13.7	V		
	$I_O = -1mA$		13.6		13.6				
	$I_O = -10mA$		13.3		13.3				
V_{OM-} 最大负峰值输出电压摆幅	$I_O = 150 \mu A$	25°C	-14.7	-14.9	-14.7	-14.9	V		
	$I_O = 1.5mA$		-14.5	-14.8	-14.5	-14.8			
	$I_O = 15mA$		-13.4	-13.8	-13.4	-13.8			
	$I_O = 100 \mu A$	完整范围	-14.6		-14.6		V		
	$I_O = 1mA$		-14.5		-14.5				
	$I_O = 10mA$		-13.4		-13.4				
A_{VD} 大信号差分电压放大	$V_O = \pm 10V, R_L = 2k \Omega$	25°C	100	450	100	450	V/mV		
		完整范围	40		40				
r_i 输入电阻		25°C	65			$M \Omega$			
c_i 输入电容		25°C	2.5			pF			
Z_o 开环输出阻抗	$f = 1MHz$	25°C	30			Ω			
CMRR 共模抑制比	$V_{IC} = V_{ICRmin}$	25°C	85	108	85	108	dB		
	$R_S = 50 \Omega$	完整范围	80		80				
k_{SVR} 电源电压抑制比 ($\Delta V_{CC\pm} / \Delta V_{IO}$)	$V_{CC\pm} = \pm 2.5V$ 至 $\pm 15V, R_S = 50 \Omega$	25°C	90	106	90	106	dB		
		完整范围	85		85				
I_{OS} 短路输出电流	$V_O = 0$	25°C	$V_{ID} = 1V$	-25	-50	-25	-50	mA	
			$V_{ID} = -1V$	20	31	20	31		
I_{CC} 电源电流	$V_O = 0V, 无负载$	25°C	6.9	9	6.9	9	mA		
		完整范围	9.4		9.4				

(1) 完整范围为 $-40^\circ C$ 至 $105^\circ C$ 。

5.22 TLE2142I 工作特性, $V_{CC\pm} = \pm 15V$, $T_A = 25^\circ C$

参数	测试条件	TLE2142I			TLE2142AI			单位
		最小值	典型值	最大值	最小值	典型值	最大值	
SR+ 正压摆率	$A_{VD} = -1$, $R_L = 2k\Omega$, $C_L = 500pF$	30 ⁽¹⁾	45		30 ⁽¹⁾	45		V/ μ s
SR- 负压摆率		30 ⁵	42		30 ⁽¹⁾	42		
t_s 稳定时间	$A_{VD} = -1$, 10V 阶跃	达 0.1%	0.43		0.43			μ s
		达 0.01%	0.64		0.64			
V_n 等效输入噪声电压	$R_S = 20\Omega$, $f = 10Hz$		15		15			nV/ \sqrt{Hz}
	$R_S = 20\Omega$, $f = 1kHz$		10.5		10.5			
$V_{N(PP)}$ 峰值间等效输入噪声电压	$f = 0.1Hz$ 至 $1Hz$		0.48		0.48			μ V
	$f = 0.1Hz$ 至 $10Hz$		0.51		0.51			
I_n 等效输入噪声电流	$f = 10Hz$		1.89		1.89			pA/ \sqrt{Hz}
	$f = 1kHz$		0.47		0.47			
THD + N 总谐波失真 + 噪声	$V_{O(PP)} = 20V$, $R_L = 2k\Omega$, $A_{VD} = 10$, $f = 10kHz$		0.06%		0.06%			
B_1 单位增益带宽	$R_L = 2k\Omega$, $C_L = 100pF$		6		6			MHz
增益带宽积	$R_L = 2k\Omega$, $C_L = 100pF$, $f = 100kHz$		5.9		5.9			MHz
B_{OM} 最大输出摆幅带宽 ⁽²⁾	$V_{O(PP)} = 2V$, $R_L = 2k\Omega$, $A_{VD} = 1$, $C_L = 100pF$		668		668			kHz
ϕ_m 单位增益下的相位裕度	$R_L = 2k\Omega$, $C_L = 100pF$		58°		58°			

- (1) 根据特征确定。
 (2) 在 -0.1dB 时测得。

5.23 TLE2144I 电气特性

在指定自然通风温度下， $V_{CC} = 5V$ (除非另有说明)

参数	测试条件	T_A (1)	TLE2144I			TLE2144AI			单位
			最小值	典型值	最大值	最小值	典型值	最大值	
V_{IO} 输入失调电压	$V_O = 0, R_S = 50 \Omega, V_O = 0$	25°C	0.5 3.8		0.5 3		mV		
		完整范围	4.8		4				
$\alpha_{V_{IO}}$ 输入失调电压的温度系数		完整范围	1.7		1.7		$\mu V/^\circ C$		
I_{IO} 输入失调电流		25°C	8 100		8 100		nA		
		完整范围	200		200				
I_B 输入偏置电流		25°C	-0.8 -2		-0.8 -2		μA		
	完整范围	-2.2		-2.2					
V_{ICR} 共模输入电压范围	$R_S = 50 \Omega$	25°C	0 至 3	-0.3 至 3.2	0 至 3	-0.3 至 3.2	V		
		完整范围	0 至 2.7	-0.3 至 2.9	0 至 2.7	-0.3 至 2.9	V		
V_{OH} 高电平输出电压	$I_{OH} = -150 \mu A$	25°C	3.9	4.1	3.9	4.1	V		
	$I_{OH} = -1.5mA$		3.8	4	3.8	4			
	$I_{OH} = -15mA$		3.4	3.7	3.4	3.7			
	$I_{OH} = 100 \mu A$	完整范围	3.8		3.8		V		
	$I_{OH} = 1mA$		3.7		3.7				
	$I_{OH} = 10mA$		3.5		3.5				
V_{OL} 低电平输出电压	$I_{OL} = 150 \mu A$	25°C	75 125		75 125		mV		
	$I_{OL} = 1.5mA$		150 225		150 225				
	$I_{OL} = 15mA$		1.2 1.6		1.2 1.6				
	$I_{OL} = 100 \mu A$	完整范围	175		175		mV		
	$I_{OL} = 1mA$		225		225				
	$I_{OL} = 10mA$		1.4		1.4				
A_{VD} 大信号差分电压放大	$V_{CC} = \pm 2.5V, R_L = 2k\Omega, V_O = 1V$ 至 $-1.5V$	25°C	50 95		50 95		V/mV		
		完整范围	10		10				
r_i 输入电阻		25°C	70		70		M Ω		
C_i 输入电容		25°C	2.5		2.5		pF		
Z_o 开环输出阻抗	$f = 1MHz$	25°C	30		30		Ω		
CMRR 共模抑制比	$V_{IC} = V_{ICR}$ 最小值, $R_S = 50 \Omega$	25°C	85 118		85 118		dB		
		完整范围	80		80				
k_{SVR} 电源电压抑制比 ($\Delta V_{CC\pm} / \Delta V_{IO}$)	$V_{CC\pm} = \pm 2.5V$ 至 $\pm 15V, R_S = 50 \Omega$	25°C	90 106		90 106		dB		
		完整范围	85		85				
I_{CC} 电源电流	$V_O = 2.5V$, 空载, $V_{IC} = 2.5V$	25°C	13.2 17.6		13.2 17.6		mA		
		完整范围	18.4		18.4				

(1) 完整范围为 $-40^\circ C$ 至 $105^\circ C$ 。

5.24 TLE2144C 工作特性, $V_{CC} = 5V$, $T_A = 25^\circ C$

参数	测试条件	TLE2144C			TLE2144AC			单位
		最小值	典型值	最大值	最小值	典型值	最大值	
SR+ 正压摆率	$A_{VD} = -1$, $R_L = 2k\Omega^{(1)}$, $C_L = 500pF$	45			45			V/ μs
SR- 负压摆率		42			42			
t_s 稳定时间	$A_{VD} = -1$, 2.5V 阶跃	达 0.1%			0.66			μs
		达 0.01%			0.99			
V_n 等效输入噪声电压	$R_S = 20\Omega$, $f = 10Hz$	15			15			nV/ \sqrt{Hz}
	$R_S = 20\Omega$, $f = 1kHz$	10.5			10.5			
$V_{N(PP)}$ 峰值间等效输入噪声电压	$f = 0.1Hz$ 至 $1Hz$	0.48			0.48			μV
	$f = 0.1Hz$ 至 $10Hz$	0.51			0.51			
I_n 等效输入噪声电流	$f = 10Hz$	1.92			1.92			pA/ \sqrt{Hz}
	$f = 1kHz$	0.5			0.5			
THD + N 总谐波失真 + 噪声	$O = 1V$ 至 $3V$, $R_L = 2k\Omega$, (1) $A_{VD} = 2$, $f = 10kHz$	0.0052%			0.0052%			
B_1 单位增益带宽	$R_L = 2k\Omega^{(1)}$, $C_L = 100pF$	5.9			5.9			MHz
增益带宽积	$R_L = 2k\Omega^{(1)}$, $C_L = 100pF$, $f = 100kHz$	5.8			5.8			MHz
B_{OM} 最大输出摆幅带宽 (2)	$V_{O(PP)} = 2V$, $R_L = 2k\Omega$, (1) $A_{VD} = 1$, $C_L = 100pF$	380			380			kHz
ϕ_m 单位增益下的相位裕度	$R_L = 2k\Omega^{(1)}$, $C_L = 100pF$	57°			57°			

- (1) R_L 端接至 2.5V。
- (2) 在 -0.1dB 时测得。

5.25 TLE2144I 电气特性

在指定自然通风温度下， $V_{CC\pm} = \pm 15V$ (除非另有说明)

参数	测试条件	T_A (1)	TLE2144I			TLE2144AI			单位
			最小值	典型值	最大值	最小值	典型值	最大值	
V_{IO} 输入失调电压	$V_{IC} = 0, R_S = 50 \Omega, V_O = 0$	25°C	0.6	2.4		0.5	1.5	μV	
		完整范围			3.2		2.8		
$\alpha_{V_{IO}}$ 输入失调电压的温度系数		完整范围	1.7			1.7		$\mu V/^\circ C$	
I_{IO} 输入失调电流		25°C	7	100		7	100	nA	
		完整范围			200		200		
I_B 输入偏置电流		25°C	-0.7	-1.5		-0.7	-1.5	μA	
	完整范围			-1.7		-1.7			
V_{ICR} 共模输入电压范围	$R_S = 50 \Omega$	25°C	-15 至 13	-15.3 至 13.2		-15 至 13	-15.3 至 13.2	V	
		完整范围	-15 至 12.7	15.3 至 12.9		-15 至 12.7	-15.3 至 12.9	V	
V_{OM+} 最大正峰值输出电压摆幅	$I_O = -150 \mu A$	25°C	13.8	14.1		13.8	14.1	V	
	$I_O = -1.5mA$		13.7	14		13.7	14		
	$I_O = -15mA$		13.1	13.7		13.1	13.7		
	完整范围	$I_O = -100 \mu A$	13.7			13.7		V	
		$I_O = -1mA$	13.6			13.6			
		$I_O = -10mA$	13.1			13.1			
V_{OM-} 最大负峰值输出电压摆幅	$I_O = 150 \mu A$	25°C	-14.7	-14.9		-14.7	-14.9	V	
	$I_O = 1.5mA$		-14.5	-14.8		-14.5	-14.8		
	$I_O = 15mA$		-13.4	-13.8		-13.4	-13.8		
	完整范围	$I_O = 100 \mu A$	-14.6			-14.6		V	
		$I_O = 1mA$	-14.5			-14.5			
		$I_O = 10mA$	-13.4			-13.4			
A_{VD} 大信号差分电压放大	$V_O = \pm 10V, R_L = 2k \Omega$	25°C	100	170		100	170	V/mV	
		完整范围	40			40			
r_i 输入电阻		25°C	65			65	$M \Omega$		
c_i 输入电容		25°C	2.5			2.5	pF		
Z_o 开环输出阻抗	$f = 1MHz$	25°C	30			30	Ω		
CMRR 共模抑制比	$V_{IC} = V_{ICRmin}$	25°C	85	108		85	108	dB	
	$R_S = 50 \Omega$	完整范围	80			80			
k_{SVR} 电源电压抑制比 ($\Delta V_{CC\pm} / \Delta V_{IO}$)	$V_{CC\pm} = \pm 2.5V$ 至 $\pm 15V$, $R_S = 50 \Omega$	25°C	90	106		90	106	dB	
		完整范围	85			85			
I_{OS} 短路输出电流	$V_O = 0$	25°C	$V_{ID} = 1V$	-25	-50		-25	-50	mA
			$V_{ID} = -1V$	20	31		20	31	
I_{CC} 电源电流	$V_O = 0V$, 无负载	25°C	13.8	18		13.8	18	mA	
		完整范围			18.8		18.8		

(1) 完整范围为 $-40^\circ C$ 至 $105^\circ C$ 。

5.26 TLE2144I 工作特性, $V_{CC\pm} = \pm 15V$, $T_A = 25^\circ C$

参数	测试条件	TLE2144I			TLE2144AI			单位
		最小值	典型值	最大值	最小值	典型值	最大值	
SR+ 正压摆率	$A_{VD} = -1$, $R_L = 2k\Omega$, $C_L = 500pF$	27 ⁽¹⁾	45		27 ⁽¹⁾	45		V/ μs
SR- 负压摆率		27 ⁽¹⁾	42		27 ⁽¹⁾	42		
t_s 稳定时间	$A_{VD} = -1$, 10V 阶跃	达 0.1%		0.43	0.43		μs	
		达 0.01%		0.64	0.64			
V_n 等效输入噪声电压	$R_S = 20\Omega$, $f = 10Hz$			15	15		nV/ \sqrt{Hz}	
	$R_S = 20\Omega$, $f = 1kHz$			10.5	10.5			
$V_{N(PP)}$ 峰值间等效输入噪声电压	$f = 0.1Hz$ 至 $1Hz$			0.48	0.48		μV	
	$f = 0.1Hz$ 至 $10Hz$			0.51	0.51			
I_n 等效输入噪声电流	$f = 10Hz$			1.89	1.89		pA/ \sqrt{Hz}	
	$f = 1kHz$			0.47	0.47			
THD + N 总谐波失真 + 噪声	$V_{O(PP)} = 20V$, $R_L = 2k\Omega$, $A_{VD} = 10$, $f = 10kHz$			0.06%	0.06%			
B_1 单位增益带宽	$R_L = 2k\Omega$, $C_L = 100pF$			6	6		MHz	
增益带宽积	$R_L = 2k\Omega$, $C_L = 100pF$, $f = 100kHz$			5.9	5.9		MHz	
B_{OM} 最大输出摆幅带宽 ⁽²⁾	$V_{O(PP)} = 20V$, $R_L = 2k\Omega$, $A_{VD} = 1$, $C_L = 100pF$			668	668		kHz	
ϕ_m 单位增益下的相位裕度	$R_L = 2k\Omega$, $C_L = 100pF$			58°	58°			

- (1) 根据特征确定。
 (2) 在 -0.1dB 时测得。

5.27 TLE2144I 电气特性

在指定自然通风温度下， $V_{CC} = 5V$ (除非另有说明)

参数	测试条件	T_A (1)	TLE2141M			TLE2141AM			单位
			最小值	典型值	最大值	最小值	典型值	最大值	
V_{IO} 输入失调电压	$V_O = 2.5V, R_S = 50\Omega, V_O = 2.5V$	25°C	225	1400	200	1000	μV		
		完整范围	2100		1700				
α_{VIO} 输入失调电压的温度系数		完整范围	1.7		1.7		$\mu V/^\circ C$		
I_{IO} 输入失调电流		25°C	8	100	8	100	nA		
		完整范围	250		250				
I_B 输入偏置电流		25°C	-0.8	-2	-0.8	-2	μA		
	完整范围	-2.3		-2.3					
V_{ICR} 共模输入电压范围	$R_S = 50\Omega$	25°C	0 至 3	-0.3 至 3.2	0 至 3	-0.3 至 3.2	V		
		完整范围	0 至 2.7	-0.3 至 2.9	0 至 2.7	-0.3 至 2.9	V		
V_{OH} 高电平输出电压	$I_{OH} = -150\mu A$	25°C	3.9	4.1	3.9	4.1	V		
	$I_{OH} = -1.5mA$		3.8	4	3.8	4			
	$I_{OH} = -15mA$		3.2	3.7	3.2	3.7			
	$I_{OH} = -100\mu A$	完整范围	3.75		3.75		V		
	$I_{OH} = -1mA$		3.65		3.65				
	$I_{OH} = -10mA$		3.25		3.25				
V_{OL} 低电平输出电压	$I_{OL} = 150\mu A$	25°C	75	125	75	125	mV		
	$I_{OL} = 1.5mA$		150	225	150	225			
	$I_{OL} = 15mA$		1.2	1.4	1.2	1.4			
	$I_{OL} = 100\mu A$	完整范围	200		200		mV		
	$I_{OL} = 1mA$		250		225				
	$I_{OL} = 10mA$		1.25		1.25				
A_{VD} 大信号差分电压放大	$V_{CC} = \pm 2.5V, R_L = 2k\Omega, V_O = 1V$ 至 $-1.5V$	25°C	50	220	50	220	V/mV		
		完整范围	5		5				
r_i 输入电阻		25°C	70			$M\Omega$			
C_i 输入电容		25°C	2.5			pF			
Z_o 开环输出阻抗	$f = 1MHz$	25°C	30			Ω			
CMRR 共模抑制比	$V_{IC} = V_{ICR}$ 最小值, $R_S = 50\Omega$	25°C	85	118	85	118	dB		
		完整范围	80		80				
k_{SVR} 电源电压抑制比 ($\Delta V_{CC\pm} / \Delta V_{IO}$)	$V_{CC\pm} = \pm 2.5V$ 至 $\pm 15V, R_S = 50\Omega$	25°C	90	106	90	106	dB		
		完整范围	85		85				
I_{CC} 电源电流	$V_O = 2.5V$, 空载, $V_{IC} = 2.5V$	25°C	3.4	4.4	3.4	4.4	mA		
		完整范围	4.6		4.6				

(1) 完整范围为 $-55^\circ C$ 至 $125^\circ C$ 。

5.28 TLE2141M 工作特性, $V_{CC} = 5V$, $T_A = 25^\circ C$

参数	测试条件	TLE2141M			TLE2141AM			单位
		最小值	典型值	最大值	最小值	典型值	最大值	
SR+ 正压摆率	$A_{VD} = -1$, $R_L = 2k\Omega$, ⁽¹⁾ $C_L = 500pF$	45			45			V/ μs
SR- 负压摆率		42			42			
t_s 稳定时间	$A_{VD} = -1$, 2.5V 阶跃	达 0.1%			0.66			μs
		达 0.01%			0.99			
V_n 等效输入噪声电压	$R_S = 20\Omega$, $f = 10Hz$	15			15			nV/ \sqrt{Hz}
	$R_S = 20\Omega$, $f = 1kHz$	10.5			10.5			
$V_{N(PP)}$ 峰值间等效输入噪声电压	$f = 0.1Hz$ 至 $1Hz$	0.48			0.48			μV
	$f = 0.1Hz$ 至 $10Hz$	0.51			0.51			
I_n 等效输入噪声电流	$f = 10Hz$	1.92			1.92			pA/ \sqrt{Hz}
	$f = 1kHz$	0.5			0.5			
THD + N 总谐波失真 + 噪声	$O = 1V$ 至 $3V$, $R_L = 2k\Omega$, ⁽¹⁾ $A_{VD} = 2$, $f = 10kHz$	0.0052%			0.0052%			
B_1 单位增益带宽	$R_L = 2k\Omega$ ⁽¹⁾ , $C_L = 100pF$ ⁽¹⁾	5.9			5.9			MHz
增益带宽积	$R_L = 2k\Omega$ ⁽¹⁾ , $C_L = 100pF$ ⁽¹⁾ $f = 100kHz$	5.8			5.8			MHz
B_{OM} 最大输出摆幅带宽 ⁽²⁾	$V_{O(PP)} = 2V$, $R_L = 2k\Omega$, ⁽¹⁾ $A_{VD} = 1$, $C_L = 100pF$ ⁽¹⁾	380			380			kHz
ϕ_m 单位增益下的相位裕度	$R_L = 2k\Omega$ ⁽¹⁾ , $C_L = 100pF$ ⁽¹⁾	57°			57°			

(1) R_L 和 C_L 端接至 2.5V。

(2) 在 -0.1dB 时测得。

5.29 TLE2141M 电气特性

在指定自然通风温度下， $V_{CC\pm} = \pm 15V$ (除非另有说明)

参数	测试条件	T_A (1)	TLE2141M			TLE2141AM			单位
			最小值	典型值	最大值	最小值	典型值	最大值	
V_{IO} 输入失调电压	$V_{IC} = 0, R_S = 50 \Omega$	25°C	200	900	175	500	μV		
		完整范围	1700		1200				
$\alpha_{V_{IO}}$ 输入失调电压的温度系数		完整范围	1.7		1.7		$\mu V/^\circ C$		
I_{IO} 输入失调电流		25°C	7	100	7	100	nA		
		完整范围	250		250				
I_B 输入偏置电流		25°C	-0.7	-1.5	-0.7	-1.5	μA		
	完整范围	-1.8		-1.8					
V_{ICR} 共模输入电压范围	$R_S = 50 \Omega$	25°C	-15 至 13	-15.3 至 13.2	-15 至 13	-15.3 至 13.2	V		
		完整范围	-15 至 12.7	15.3 至 12.9	-15 至 12.7	-15.3 至 12.9	V		
V_{OM+} 最大正峰值输出电压摆幅	$I_O = -150 \mu A$	25°C	13.8	14.1	13.8	14.1	V		
	$I_O = -1.5mA$		13.7	14	13.7	14			
	$I_O = -15mA$		13.1	13.7	13.1	13.7			
	$I_O = -100 \mu A$	完整范围	13.7		13.7		V		
	$I_O = -1mA$		13.6		13.6				
	$I_O = -10mA$		13.1		13.1				
V_{OM-} 最大负峰值输出电压摆幅	$I_O = 150 \mu A$	25°C	-14.7	-14.9	-14.7	-14.9	V		
	$I_O = 1.5mA$		-14.5	-14.8	-14.5	-14.8			
	$I_O = 15mA$		-13.4	-13.8	-13.4	-13.8			
	$I_O = 100 \mu A$	完整范围	-14.6		-14.6		V		
	$I_O = 1mA$		-14.5		-14.5				
	$I_O = 10mA$		-13.4		-13.4				
A_{VD} 大信号差分电压放大	$V_O = \pm 10V, R_L = 2k \Omega$	25°C	100	450	100	450	V/mV		
		完整范围	20		20				
r_i 输入电阻		25°C	65			$M \Omega$			
c_i 输入电容		25°C	2.5			pF			
Z_o 开环输出阻抗	$f = 1MHz$	25°C	30			Ω			
CMRR 共模抑制比	$V_{IC} = V_{ICR}$ 最小值, $R_S = 50 \Omega$	25°C	85	108	85	108	dB		
		完整范围	80		80				
k_{SVR} 电源电压抑制比 ($\Delta V_{CC\pm} / \Delta V_{IO}$)	$V_{CC\pm} = \pm 2.5V$ 至 $\pm 15V$, $R_S = 50 \Omega$	25°C	90	106	90	106	dB		
		完整范围	85		85				
I_{OS} 短路输出电流	$V_O = 0$	25°C	$V_{ID} = 1V$	-25	-50	-25	-50	mA	
			$V_{ID} = -1V$	20	31	20	31		
I_{CC} 电源电流	$V_O = 0V, V_{IC} = 2.5V$, 空载	25°C	3.5	4.5	3.5	4.5	mA		
		完整范围	4.7		4.7				

(1) 完整范围为 $-55^\circ C$ 至 $125^\circ C$ 。

5.30 TLE2141M 工作特性, $V_{CC\pm} = \pm 15V$, $T_A = 25^\circ C$

参数	测试条件	TLE2141M			TLE2141AM			单位
		最小值	典型值	最大值	最小值	典型值	最大值	
SR+ 正压摆率	$A_{VD} = -1$, $R_L = 2k\Omega$, $C_L = 100pF$	27 ⁽¹⁾	45		27 ⁽¹⁾	45		V/ μs
SR- 负压摆率		27 ⁽¹⁾	42		27 ⁽¹⁾	42		
t_s 稳定时间	$A_{VD} = -1$, 10V 阶跃	达 0.1%		0.43	0.43		μs	
		达 0.01%		0.64	0.64			
V_n 等效输入噪声电压	$R_S = 20\Omega$, $f = 10Hz$			15	15		nV/ \sqrt{Hz}	
	$R_S = 20\Omega$, $f = 1kHz$			10.5	10.5			
$V_{N(PP)}$ 峰值间等效输入噪声电压	$f = 0.1Hz$ 至 $1Hz$			0.48	0.48		μV	
	$f = 0.1Hz$ 至 $10Hz$			0.51	0.51			
I_n 等效输入噪声电流	$f = 10Hz$			1.89	1.89		pA/ \sqrt{Hz}	
	$f = 1kHz$			0.47	0.47			
THD + N 总谐波失真 + 噪声	$V_{O(PP)} = 20V$, $R_L = 2k\Omega$, $A_{VD} = 10$, $f = 10kHz$			0.06%	0.06%			
B_1 单位增益带宽	$R_L = 2k\Omega$, $C_L = 100pF$			6	6		MHz	
增益带宽积	$R_L = 2k\Omega$, $C_L = 100pF$, $f = 100kHz$			5.9	5.9		MHz	
B_{OM} 最大输出摆幅带宽 ⁽²⁾	$V_{O(PP)} = 20V$, $R_L = 2k\Omega$, $A_{VD} = 1$, $C_L = 100pF$			668	668		kHz	
ϕ_m 单位增益下的相位裕度	$R_L = 2k\Omega$, $C_L = 100pF$			58°	58°			

- (1) 根据特征确定。
 (2) 在 -0.1dB 时测得。

5.31 TLE2142M 电气特性

在指定自然通风温度下， $V_{CC} = 5V$ (除非另有说明)

参数	测试条件	T_A (1)	TLE2142M			TLE2142AM			单位
			最小值	典型值	最大值	最小值	典型值	最大值	
V_{IO} 输入失调电压	$V_{IC} = 0, R_S = 50 \Omega$	25°C	220	1900	200	1500	μV		
		完整范围	2600		2200				
$\alpha_{V_{IO}}$ 输入失调电压的温度系数		完整范围	1.7		1.7		$\mu V/^\circ C$		
I_{IO} 输入失调电流		25°C	8	100	8	100	nA		
		完整范围	200		200				
I_B 输入偏置电流		25°C	-0.8	-2	-0.8	-2	μA		
	完整范围	-2.3		-2.3					
V_{ICR} 共模输入电压范围	$R_S = 50 \Omega$	25°C	0 至 3	-0.3 至 3.2	0 至 3	-0.3 至 3.2	V		
		完整范围	0 至 2.7	-0.3 至 2.9	0 至 2.7	-0.3 至 2.9	V		
V_{OM+} 最大正峰值输出电压摆幅	$I_O = -150 \mu A$	25°C	3.9	4.1	3.9	4.1	V		
	$I_O = -1.5mA$		3.8	4	3.8	4			
	$I_O = -15mA$		3.4	3.7	3.4	3.7			
	$I_O = 100 \mu A$	完整范围	3.75		3.75		V		
	$I_O = 1mA$		3.65		3.65				
	$I_O = 10mA$		3.45		3.45				
V_{OM-} 最大负峰值输出电压摆幅	$I_O = 150 \mu A$	25°C	75	125	75	125	mV		
	$I_O = 1.5mA$		150	225	150	225			
	$I_O = 15mA$		1.2	1.4	1.2	1.4			
	$I_O = 100 \mu A$	完整范围	200		200		mV		
	$I_O = 1mA$		250		250				
	$I_O = 10mA$		125		125				
A_{VD} 大信号差分电压放大	$V_{IC} = \pm 2.5V, R_L = 2k \Omega, V_O = 1V$ 至 $-1.5V$	25°C	50	220	50	220	V/mV		
		完整范围	5		5				
r_i 输入电阻		25°C	70			$M \Omega$			
C_i 输入电容		25°C	2.5			pF			
Z_o 开环输出阻抗	$f = 1MHz$	25°C	30			Ω			
CMRR 共模抑制比	$V_{IC} = V_{ICR}$ 最小值, $R_S = 50 \Omega$	25°C	85	118	85	118	dB		
		完整范围	80		80				
k_{SVR} 电源电压抑制比 ($\Delta V_{CC\pm} / \Delta V_{IO}$)	$V_{CC\pm} = \pm 2.5V$ 至 $\pm 15V, R_S = 50 \Omega$	25°C	90	106	90	106	dB		
		完整范围	85		85				
I_{OS} 短路输出电流	$V_O = 0$	25°C	$V_{ID} = 1V$	-25	-50	-25	-50	mA	
			$V_{ID} = -1V$	20	31	20	31		
I_{CC} 电源电流	$V_O = 0V, V_{IC} = 2.5V, 空载$	25°C	6.6	8.8	6.6	8.8	mA		
		完整范围	9.2		9.2				

(1) 完整范围为 $-55^\circ C$ 至 $125^\circ C$ 。

5.32 TLE2142M 工作特性, $V_{CC} = 5V$, $T_A = 25^\circ C$

参数	测试条件	TLE2142M			TLE2142AM			单位	
		最小值	典型值	最大值	最小值	典型值	最大值		
SR+ 正压摆率	$A_{VD} = -1$, $R_L = 2k\Omega^{(1)}$, $C_L = 500pF$	45			45			V/ μs	
SR- 负压摆率		42			42				
t_s 稳定时间	$A_{VD} = -1$, 10V 阶跃	达 0.1%	0.66			0.66			μs
		达 0.01%	0.99			0.99			
V_n 等效输入噪声电压	$R_S = 20\Omega$, $f = 10Hz$	15			15			nV/ \sqrt{Hz}	
	$R_S = 20\Omega$, $f = 1kHz$	10.5			10.5				
$V_{N(PP)}$ 峰值间等效输入噪声电压	$f = 0.1Hz$ 至 $1Hz$	0.48			0.48			μV	
	$f = 0.1Hz$ 至 $10Hz$	0.51			0.51				
I_n 等效输入噪声电流	$f = 10Hz$	1.92			1.92			pA/ \sqrt{Hz}	
	$f = 1kHz$	0.5			0.5				
THD + N 总谐波失真 + 噪声	$V_O = 1V$ 至 $3V$, $R_L = 2k\Omega^{(1)}$, $A_{VD} = 2$, $f = 10kHz$	0.0052%			0.0052%				
B_1 单位增益带宽	$R_L = 2k\Omega^{(1)}$, $C_L = 100pF$	5.9			5.9			MHz	
增益带宽积	$R_L = 2k\Omega^{(1)}$, $C_L = 100pF$, $f = 100kHz$	5.8			5.8			MHz	
B_{OM} 最大输出摆幅带宽 ⁽²⁾	$V_{O(PP)} = 2V$, $R_L = 2k\Omega^{(1)}$, $A_{VD} = 1$, $C_L = 100pF$	380			380			kHz	
ϕ_m 单位增益下的相位裕度	$R_L = 2k\Omega^{(1)}$, $C_L = 100pF$	57°			57°				

(1) R_L 端接至 2.5V。

(2) 在 -0.1dB 时测得。

5.33 TLE2142M 电气特性

在指定自然通风温度下， $V_{CC\pm} = \pm 15V$ (除非另有说明)

参数	测试条件	T_A (1)	TLE2142M			TLE2142AM			单位
			最小值	典型值	最大值	最小值	典型值	最大值	
V_{IO} 输入失调电压	$V_{IC} = 0, R_S = 50 \Omega$	25°C	290	1200	275	750	μV		
		完整范围	2000		1600				
$\alpha_{V_{IO}}$ 输入失调电压的温度系数		完整范围	1.7		1.7		$\mu V/^\circ C$		
I_{IO} 输入失调电流		25°C	7	100	7	100	nA		
		完整范围	250		250				
I_B 输入偏置电流		25°C	-0.7	-1.5	-0.7	-1.5	μA		
	完整范围	-1.8		-1.8					
V_{ICR} 共模输入电压范围	$R_S = 50 \Omega$	25°C	-15 至 13	-15.3 至 13.2	-15 至 13	-15.3 至 13.2	V		
		完整范围	-15 至 12.7	-15.3 至 12.9	-15 至 12.7	-15.3 至 12.9	V		
V_{OM+} 最大正峰值输出电压摆幅	$I_O = -150 \mu A$ $I_O = -1.5mA$ $I_O = -15mA$	25°C	13.8	14.1	13.8	14.1	V		
			13.7	14	13.7	14			
			13.3	13.7	13.3	13.7			
	完整范围	$I_O = -100 \mu A$	13.7		13.7		V		
		$I_O = -1mA$	13.6		13.6				
		$I_O = -10mA$	13.3		13.3				
V_{OM-} 最大负峰值输出电压摆幅	$I_O = 150 \mu A$ $I_O = 1.5mA$ $I_O = 15mA$	25°C	-14.7	-14.9			V		
			-14.5	-14.8					
			-13.4	-13.8					
	完整范围	$I_O = 100 \mu A$	-14.6		-14.6		V		
		$I_O = 1mA$	-14.5		-14.5				
		$I_O = 10mA$	-13.4		-13.4				
A_{VD} 大信号差分电压放大	$V_O = \pm 10V, R_L = 2k \Omega$	25°C	100	450	100	450	V/mV		
		完整范围	20		20				
r_i 输入电阻		25°C	65			$M \Omega$			
c_i 输入电容		25°C	2.5			pF			
Z_o 开环输出阻抗	$f = 1MHz$	25°C	30			Ω			
CMRR 共模抑制比	$V_{IC} = V_{ICR}$ 最小值, $R_S = 50 \Omega$	25°C	85	108	85	108	dB		
		完整范围	80		80				
k_{SVR} 电源电压抑制比 ($\Delta V_{CC\pm} / \Delta V_{IO}$)	$V_{CC\pm} = \pm 2.5V$ 至 $\pm 15V$, $R_S = 50 \Omega$	25°C	90	106	90	106	dB		
		完整范围	85		85				
I_{OS} 短路输出电流	$V_O = 0$	25°C	$V_{ID} = 1V$	-25	-50	-25	-50	mA	
			$V_{ID} = -1V$	20	31	20	31		
I_{CC} 电源电流	$V_O = 0V, V_{IC} = 2.5V$, 空载	25°C	6.9	9	6.9	9	mA		
		完整范围	9.4		9.4				

(1) 完整范围为 $-55^\circ C$ 至 $125^\circ C$ 。

5.34 TLE2142M 工作特性, $V_{CC\pm} = \pm 15V$, $T_A = 25^\circ C$

参数	测试条件	TLE2142M			TLE2142AM			单位
		最小值	典型值	最大值	最小值	典型值	最大值	
SR+ 正压摆率	$A_{VD} = -1$, $R_L = 2k\Omega$, $C_L = 100pF$	27 ⁽¹⁾	45		27 ^s	45		V/ μs
SR- 负压摆率		27 ⁽¹⁾	42		27 ^s	42		
t_s 稳定时间	$A_{VD} = -1$, 10V 阶跃	达 0.1%		0.43	0.43			μs
		达 0.01%		0.64	0.64			
V_n 等效输入噪声电压	$R_S = 20\Omega$, $f = 10Hz$	15			15			nV/ \sqrt{Hz}
	$R_S = 20\Omega$, $f = 1kHz$	10.5			10.5			
$V_{N(PP)}$ 峰值间等效输入噪声电压	$f = 0.1Hz$ 至 $1Hz$	0.48			0.48			μV
	$f = 0.1Hz$ 至 $10Hz$	0.51			0.51			
I_n 等效输入噪声电流	$f = 10Hz$	1.89			1.89			pA/ \sqrt{Hz}
	$f = 1kHz$	0.47			0.47			
THD + N 总谐波失真 + 噪声	$V_{O(PP)} = 20V$, $R_L = 2k\Omega$, $A_{VD} = 2$, $f = 10kHz$	0.06%			0.06%			
B_1 单位增益带宽	$R_L = 2k\Omega$, $C_L = 100pF$	6			6			MHz
增益带宽积	$R_L = 2k\Omega$, $C_L = 100pF$, $f = 100kHz$	5.9			5.9			MHz
B_{OM} 最大输出摆幅带宽 ⁽²⁾	$V_{O(PP)} = 2V$, $R_L = 2k\Omega$, $A_{VD} = 1$, $C_L = 100pF$	668			668			kHz
ϕ_m 单位增益下的相位裕度	$R_L = 2k\Omega$, $C_L = 100pF$	58°			58°			

- (1) 根据特征确定。
 (2) 在 -0.1dB 时测得。

5.35 TLE2144M 电气特性

在指定自然通风温度下, $V_{CC} = 5V$ (除非另有说明)

参数	测试条件	T_A (1)	TLE2144M			TLE2144AM			单位
			最小值	典型值	最大值	最小值	典型值	最大值	
V_{IO} 输入失调电压	$V_O = 2.5V, R_S = 50\Omega, V_{IC} = 2.5V$	25°C	0.5	3.8	0.5	3	mV		
		完整范围	5.2			4.4			
$\alpha_{V_{IO}}$ 输入失调电压的温度系数		完整范围	1.7			1.7			$\mu V/^\circ C$
I_{IO} 输入失调电流		25°C	8	100	8	100	nA		
		完整范围	250			250			
I_{IB} 输入偏置电流		25°C	8	-0.	-2	-0.8	-2	nA	
	完整范围	-2.3			-2.3				
V_{ICR} 共模输入电压范围	$R_S = 50\Omega$	25°C	0 至 3	-0.3 至 3.2	0 至 3	-0.3 至 3.2	V		
		完整范围	0 至 2.7	-0.3 至 2.9	0 至 2.7	-0.3 至 2.9	V		
V_{OH} 高电平输出电压	$I_{OH} = -150\mu A$	25°C	3.9	4.1	3.9	4.1	V		
	$I_{OH} = -1.5mA$		3.8	4	3.8	4			
	$I_{OH} = -15mA$		3.4	3.7	3.4	3.7			
	$I_{OH} = 100\mu A$	完整范围	3.75		3.75				
	$I_{OH} = 1mA$		3.65		3.65				
	$I_{OH} = 10mA$		3.45		3.45				
V_{OL} 低电平输出电压	$I_{OL} = 150\mu A$	25°C	75	125	75	125	mV		
	$I_{OL} = 1.5\mu A$		150	225	150	225			
	$I_{OL} = 15mA$		1.2	1.6	1.2	1.6			
	$I_{OL} = 100\mu A$	完整范围	200		200				
	$I_{OL} = 1mA$		250		250				
	$I_{OL} = 10mA$		1.45		1.45				
A_{VD} 大信号差分电压放大	$V_{IC} = \pm 2.5V, R_L = 2k\Omega, V_O = 1V$ 至 $-1.5V$	25°C	50	95	50	95	V/mV		
		完整范围	5						
r_i 输入电阻		25°C	70			$M\Omega$			
C_i 输入电容		25°C	2.5			pF			
Z_o 开环输出阻抗	$f = 1MHz$	25°C	30			Ω			
CMR R 共模抑制比	$V_{IC} = V_{ICR}$ 最小值, $R_S = 50\Omega$	25°C	85	118	85	118	dB		
		完整范围	80						
k_{SVR} 电源电压抑制比 ($\Delta V_{CC} \pm / \Delta V_{IO}$)	$V_{CC} \pm = \pm 2.5V$ 至 $\pm 15V, R_S = 50\Omega$	25°C	90	106	90	106	dB		
		完整范围	85						
I_{CC} 电源电流	$V_O = 2.5V$, 空载, $V_{IC} = 2.5V$	25°C	13.2	17.6	13.2	17.6	mA		
		完整范围	18.4						

(1) 完整范围为 $-55^\circ C$ 至 $125^\circ C$ 。

5.36 TLE2144M 工作特性

$V_{CC} = 5V$, $T_A = 25^\circ C$

参数	测试条件	TLE2144M			TLE2144AM			单位
		最小值	典型值	最大值	最小值	典型值	最大值	
SR+ 正压摆率	$A_{VD} = -1$, $R_L = 2k\Omega^{(1)}$, $C_L = 500pF$	45			45			V/ μs
SR- 负压摆率		42			42			
t_s 稳定时间	$A_{VD} = -1$, 2.5V 阶跃	达 0.1%	0.66		0.66		μs	
		达 0.01%	0.99		0.99			
V_n 等效输入噪声电压	$R_S = 20\Omega$, $f = 10Hz$	15			15			nV/ \sqrt{Hz}
	$R_S = 20\Omega$, $f = 1kHz$	10.5			10.5			
$V_{N(PP)}$ 峰值间等效输入噪声电压	$f = 0.1Hz$ 至 $1Hz$	0.48			0.48			μV
	$f = 0.1Hz$ 至 $10Hz$	0.51			0.51			
I_n 等效输入噪声电流	$f = 10Hz$	1.92			1.92			pA/ \sqrt{Hz}
	$f = 1kHz$	0.5			0.5			
THD + N 总谐波失真 + 噪声	$V_O = 1V$ 至 $3V$, $R_L = 2k\Omega^{(1)}$, $A_{VD} = 2$, $f = 10kHz$	0.0052%			0.0052%			
B_1 单位增益带宽	$R_L = 2k\Omega^{(1)}$, $C_L = 100pF$	5.9			5.9			MHz
增益带宽积	$R_L = 2k\Omega^{(1)}$, $C_L = 100pF$, $f = 100kHz$	5.8			5.8			MHz
B_{OM} 最大输出摆幅带宽 ⁽²⁾	$V_{O(PP)} = 2V$, $R_L = 2k\Omega^{(1)}$, $A_{VD} = 1$	380			380			kHz
ϕ_m 相位裕度	$R_L = 2k\Omega^{(1)(1)}$, $C_L = 100pF$	57°			57°			

- (1) R_L 端接至 2.5V。
 (2) 在 -0.1dB 时测得。

5.37 TLE2144M 电气特性

在指定自然通风温度下， $V_{CC\pm} = \pm 15V$ (除非另有说明)

参数	测试条件	T_A ⁽¹⁾	TLE2144M			TLE2144AM			单位
			最小值	典型值	最大值	最小值	典型值	最大值	
V_{IO} 输入失调电压	$V_{IC} = 0, R_S = 50 \Omega$	25°C	0.6	2.4	0.5	1.5	mV		
		完整范围	4			3.2			
α_{VIO} 输入失调电压的温度系数		完整范围	1.7			1.7	$\mu V/^\circ C$		
		25°C	7	100	7	100			
I_{IO} 输入失调电流		完整范围	250			250	nA		
		25°C	-0.7	-1.5	-0.7	-1.5			
I_{IB} 输入偏置电流	完整范围	-1.8			-1.8	μA			
V_{ICR} 共模输入电压范围	$R_S = 50 \Omega$	25°C	-15 至 13	-15.3 至 13.2	-15 至 13	- 15.3 至 13.2	V		
		完整范围	-15 至 12.7	-15.3 至 12.9	-15 至 12.7	- 15.3 至 12.9			
V_{OM+} 最大正峰值输出电压摆幅	$I_O = -150 \mu A$ $I_O = -1.5mA$ $I_O = -15mA$ $I_O = -100 \mu A$ $I_O = -1mA$ $I_O = -10mA$	25°C	13.8	14.1	13.8	14.1	V		
			13.7	14	13.7	14			
			13.1	13.7	13.1	13.7			
		完整范围	13.7		13.7				
			13.6		13.6				
			13.1		13.1				
V_{OM-} 最大负峰值输出电压摆幅	$I_O = 150 \mu A$ $I_O = 1.5mA$ $I_O = 15mA$ $I_O = 100 \mu A$ $I_O = 1mA$ $I_O = 10mA$	25°C	-14.7	-14.9	-14.7	-14.9	V		
			-14.5	-14.8	-14.5	-14.8			
			-13.4	-13.8	-13.4	-13.8			
		完整范围	-14.6		-14.6				
			-14.5		-14.5				
			-13.4		-13.4				
A_{VD} 大信号差分电压放大	$V_O = \pm 10V, R_L = 2k \Omega$	25°C	100	170	100	170	V/mV		
		完整范围	20						
r_i 输入电阻		25°C	65			$M \Omega$			
C_i 输入电容		25°C	2.5			pF			
Z_o 开环输出阻抗	$f = 1MHz$	25°C	30			Ω			
CMRR 共模抑制比	$V_{IC} = V_{ICRmin}, R_S = 50 \Omega$	25°C	85	108	85	108	dB		
		完整范围	80						
k_{SVR} 电源电压抑制比 ($\Delta V_{CC} \pm / \Delta V_{IO}$)	$V_{CC\pm} = \pm 2.5V$ 至 $\pm 15V, R_S = 50 \Omega$	25°C	90	106	90	106	dB		
		完整范围	85						
I_{OS} 短路输出电流	$V_O = 0$	25°C	$V_{ID} = 1V$	-25	-50	-25	-50	mA	
			$V_{ID} = -1V$	20	31	20	31		
I_{CC} 电源电流	$V_O = 0, \text{空载}, V_{IC} = 2.5V$	25°C	13.8	18	13.8	18	mA		
		完整范围	18.8						

(1) 完整范围为 -55°C 至 125°C

5.38 TLE2144M 工作特性

$V_{CC\pm} = \pm 15V$, $T_A = 25^\circ C$

参数	测试条件	TLE2144M			TLE2144AM			单位
		最小值	典型值	最大值	最小值	典型值	最大值	
SR+ 正压摆率	$R_L = 2k\Omega$, $A_{VD} = -1$, $C_L = 100pF$	27 ⁽¹⁾	45		27 ⁽¹⁾	45		V/ μs
SR- 负压摆率		27 ⁽¹⁾	42		27 ⁽¹⁾	42		
t_s 稳定时间	$A_{VD} = -1$, 10V 阶跃	达 0.1%	0.43		0.43			μs
		达 0.01%	0.64		0.64			
V_n 等效输入噪声电压	$R_S = 20\Omega$, $f = 10Hz$		15		15			nV/ \sqrt{Hz}
	$R_S = 20\Omega$, $f = 1kHz$		10.5		10.5			
$V_{N(PP)}$ 峰值间等效输入噪声电压	$f = 0.1Hz$ 至 $1Hz$		0.48		0.48			μV
	$f = 0.1Hz$ 至 $10Hz$		0.51		0.51			
I_n 等效输入噪声电流	$f = 10Hz$		1.89		1.89			pA/ \sqrt{Hz}
	$f = 10kHz$		0.47		0.47			
THD+N 总谐波失真 + 噪声	$V_{O(PP)} = 20V$, $R_L = 2k\Omega$, $A_{VD} = 10$, $f = 10kHz$		0.06%		0.06%			
B_1 单位增益带宽	$R_L = 2k\Omega$, $C_L = 100pF$		6		6			MHz
增益带宽积	$R_L = 2k\Omega$, $C_L = 100pF$, $f = 100kHz$		5.9		5.9			MHz
B_{OM} 最大输出摆幅带宽 ⁽²⁾	$V_{O(PP)} = 20V$, $R_L = 2k\Omega$, $A_{VD} = 1$, $C_L = 100pF$		668		668			kHz
ϕ_m 单位增益下的相位裕度	$R_L = 2k\Omega$, $C_L = 100pF$		58°		58°			

(1) 根据特征确定。

(2) 在 -0.1dB 时测得。

5.39 TLE2141Y 电气特性

在指定自然通风温度下， $V_{CC\pm} = \pm 15V$ ， $T_A = 25^\circ C$ （除非另有说明）

参数	测试条件	TLE2141Y			单位
		最小值	典型值	最大值	
V_{IO} 输入失调电压			200	1000	μV
I_{IO} 输入失调电流	$V_{IC} = 0, R_S = 50 \Omega, V_O = 0$		7	100	nA
I_{IB} 输入偏置电流			-0.7	-1.5	μA
V_{ICR} 共模输入电压范围	$R_S = 50 \Omega$	-15 至 13	- 15.3 至 13.2		V
V_{OM+} 最大正峰值输出电压摆幅	$I_O = -150 \mu A$	13.8	14.1		V
	$I_O = -1.5mA$	13.7	14		
	$I_O = -15mA$	13.3	13.7		
V_{OM-} 最大负峰值输出电压摆幅	$I_O = 150 \mu A$	-14.7	-14.9		V
	$I_O = 1.5mA$	-14.5	-14.8		
	$I_O = 15mA$	-13.4	-13.8		
A_{VD} 大信号差分电压放大	$V_O = \pm 10V, R_L = 2k \Omega$	100	450		V/mV
r_i 输入电阻			65		$M \Omega$
C_i 输入电容			2.5		pF
Z_o 开环输出阻抗	$f = 1MHz$		30		Ω
CMRR 共模抑制比	$V_{IC} = V_{ICR}$ 最小值， $R_S = 50 \Omega$	80	108		dB
k_{SVR} 电源电压抑制比 ($\Delta V_{CC\pm} / \Delta V_{IO}$)	$V_{CC\pm} = \pm 2.5V$ 至 $\pm 15V, R_S = 50 \Omega$	85	106		dB
I_{OS} 短路输出电流	$V_O = 0$	$V_{ID} = 1V$	-25	-50	mA
		$V_{ID} = -1V$	20	31	
I_{CC} 电源电流	$V_O = 0, \text{空载}$	3.5	4.5		mA

5.40 TLE2142Y 电气特性

在指定自然通风温度下， $V_{CC\pm} = \pm 15V$ ， $T_A = 25^\circ$ (除非另有说明)

参数	测试条件	TLE2142Y			单位
		最小值	典型值	最大值	
V_{IO} 输入失调电压			150	875	μV
I_{IO} 输入失调电流	$V_{IC} = 0$, $R_S = 50 \Omega$, $V_O = 0$		7	100	nA
I_{IB} 输入偏置电流			-0.7	-1.5	μA
V_{ICR} 共模输入电压范围	$R_S = 50 \Omega$	-15 至 13	-15.3 至 13.2		V
V_{OM+} 最大正峰值输出电压摆幅	$I_O = -150 \mu A$	13.8	14.1		V
	$I_O = -1.5mA$	13.7	14		
	$I_O = -15mA$	13.3	13.7		
V_{OM-} 最大负峰值输出电压摆幅	$I_O = 150 \mu A$	-14.7	-14.9		V
	$I_O = 1.5mA$	-14.5	-14.8		
	$I_O = 15mA$	-13.4	-13.8		
A_{VD} 大信号差分电压放大	$V_O = \pm 10V$, $R_L = 2k \Omega$	100	450		V/mV
r_i 输入电阻			65		M Ω
C_i 输入电容			2.5		pF
Z_o 开环输出阻抗	$f = 1MHz$		30		Ω
CMRR 共模抑制比	$V_{IC} = V_{ICR}$ 最小值, $R_S = 50 \Omega$	80	108		dB
k_{SVR} 电源电压抑制比 ($\Delta V_{CC} \pm / \Delta V_{IO}$)	$V_{CC\pm} = \pm 2.5V$ 至 $\pm 15V$, $R_S = 50 \Omega$	85	106		dB
I_{OS} 短路输出电流	$V_O = 0$	$V_{ID} = 1V$	-25	-50	mA
		$V_{ID} = -1V$	20	31	
I_{CC} 电源电流	$V_O = 0$, 空载		6.9	9	mA

5.41 TLE2144Y 电气特性

$V_{CC\pm} = \pm 15V$ 时, $T_A = 25^\circ C$ (除非另有说明)

参数	测试条件	TLE2144Y			单位
		最小值	典型值	最大值	
V_{IO} 输入失调电压			0.3	1.8	μV
I_{IO} 输入失调电流	$V_{IC} = 0, R_S = 50 \Omega, V_O = 0$		7	100	nA
I_{IB} 输入偏置电流			-0.7	-1.5	μA
V_{ICR} 共模输入电压范围	$R_S = 50 \Omega$	-15 至 13	-15.3 至 13.2		V
V_{OM+} 最大正峰值输出电压摆幅	$I_O = -150 \mu A$	13.8	14.1		V
	$I_O = -1.5mA$	13.7	14		
	$I_O = -15mA$	13.3	13.7		
V_{OM-} 最大负峰值输出电压摆幅	$I_O = 150 \mu A$	-14.7	-14.9		V
	$I_O = 1.5mA$	-14.5	-14.8		
	$I_O = 15mA$	-13.4	-13.8		
A_{VD} 大信号差分电压放大	$V_O = \pm 10V, R_L = 2k \Omega$	100	450		V/mV
r_i 输入电阻			65		M Ω
c_i 输入电容			2.5		pF
z_o 开环输出阻抗	$f = 1MHz$		30		Ω
CMRR 共模抑制比	$V_{IC} = V_{ICR}$ 最小值, $R_S = 50 \Omega$	80	108		dB
k_{SVR} 电源电压抑制比 ($\Delta V_{CC} \pm / \Delta V_{IO}$)	$V_{CC\pm} = \pm 2.5V$ 至 $\pm 15V, R_S = 50 \Omega$	85	106		dB
I_{OS} 短路输出电流	$V_O = 0$	$V_{ID} = 1V$	-25	-50	mA
		$V_{ID} = -1V$	20	31	
I_{CC} 电源电流	$V_O = 0$, 空载		13.8	18	mA

5.42 典型特性

图形表

			图表
V_{IO}	输入失调电压	经销商	1、2、3
I_{IO}	输入失调电流	与自然通风温度间的关系	4
I_{IB}	输入偏置电流	与共模输入电压间的关系	5
		与自然通风温度间的关系	6
V_{OM+}	最大正峰值输出电压	与电源电压之间的关系	7
		与自然通风温度间的关系	8
		与输出电流之间的关系	9
		与稳定时间之间的关系	11
V_{OM-}	最大负峰值输出电压	与电源电压之间的关系	7
		与自然通风温度间的关系	8
		与输出电流之间的关系	10
		与稳定时间之间的关系	11
$V_{O(PP)}$	最大峰值间输出电压	与频率间的关系	12
V_{OH}	高电平输出电压	与输出电流之间的关系	13
V_{OL}	低电平输出电压	与输出电流之间的关系	14
A_{VD}	大信号差分电压放大	与频率间的关系	15
		与自然通风温度间的关系	16
	相移	与频率间的关系	15
Z_o	闭环输出阻抗	与频率间的关系	17
I_{OS}	短路输出电流	与自然通风温度间的关系	18
CMRR	共模抑制比	与频率间的关系	19
		与自然通风温度间的关系	20
K_{SVR}	电源电压抑制比	与频率间的关系	21
		与自然通风温度间的关系	22
		与电源电压之间的关系	23
I_{CC}	电源电流	与自然通风温度间的关系	24
V_n	等效输入噪声电压	与频率间的关系	25
V_n	输入噪声电压	在 10 秒周期内	26
I_n	噪声电流	与频率间的关系	27
THD + N	总谐波失真 + 噪声	与频率间的关系	28
SR	压摆率	与自然通风温度间的关系	29
		与负载电容间的关系	30
脉冲响应	同相大信号	与时间之间的关系	31
	反相大信号	与时间之间的关系	32
	小信号	与时间之间的关系	33
B_1	单位增益带宽	与负载电容间的关系	34
	增益裕度	与负载电容间的关系	35
ϕ_m	相位裕度	与负载电容间的关系	36

5.42 典型特性 (续)

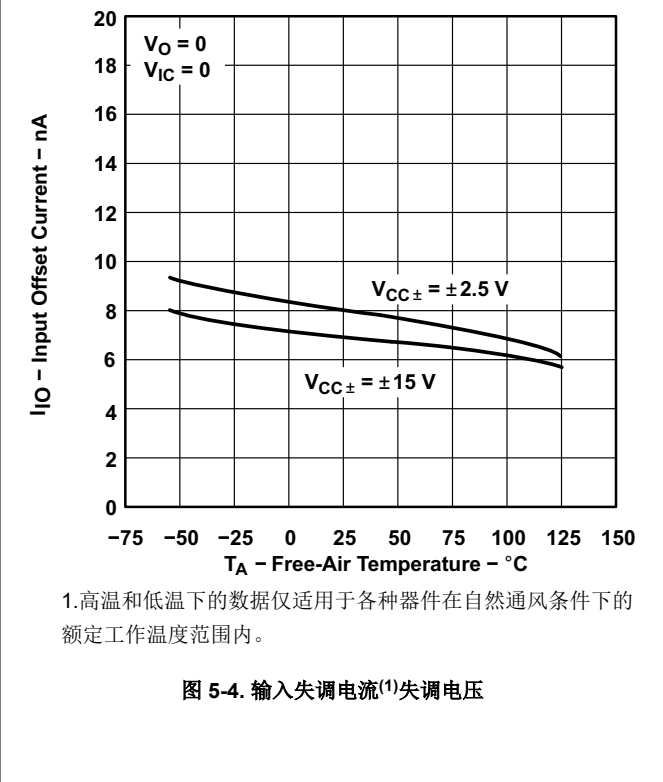
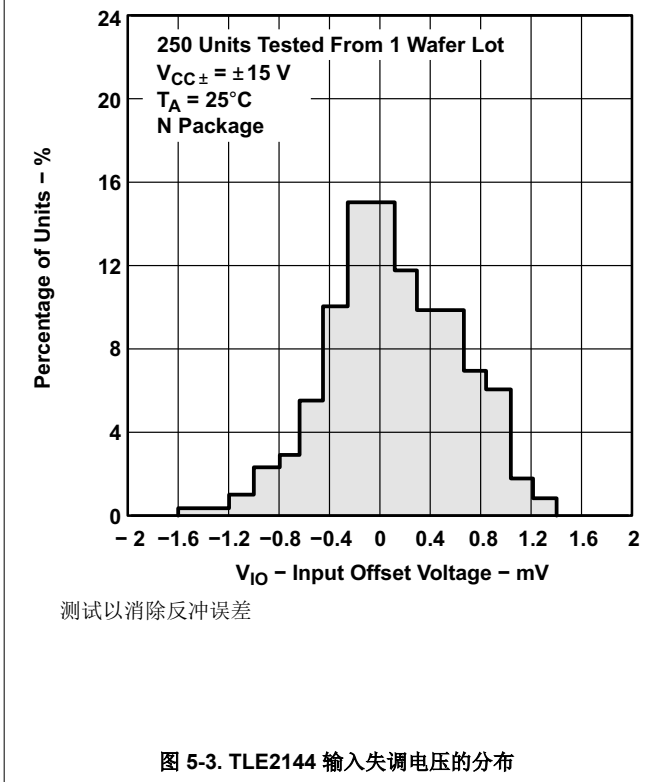
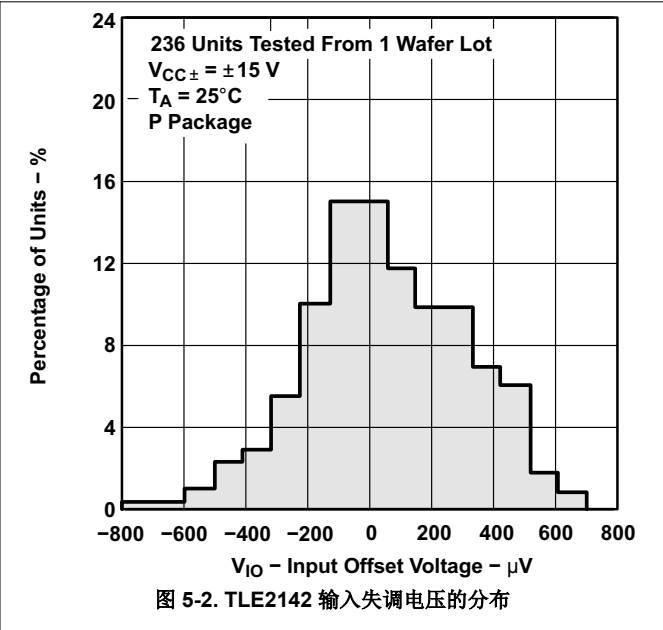
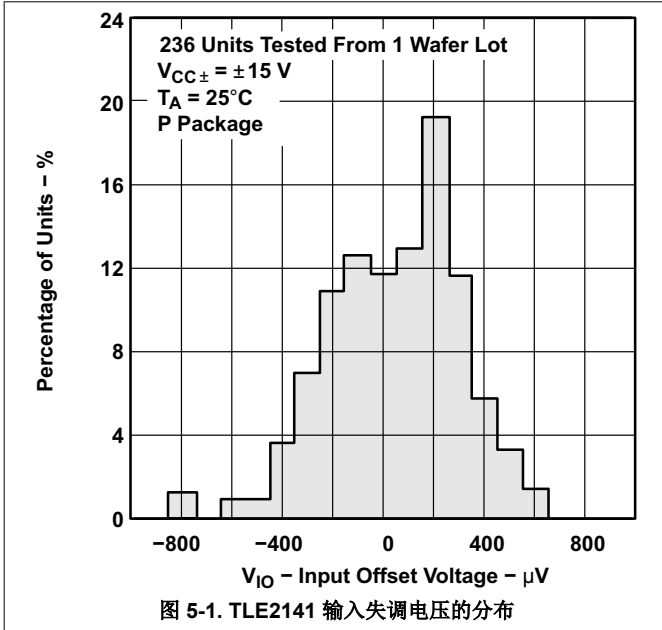

5.42 典型特性 (续)

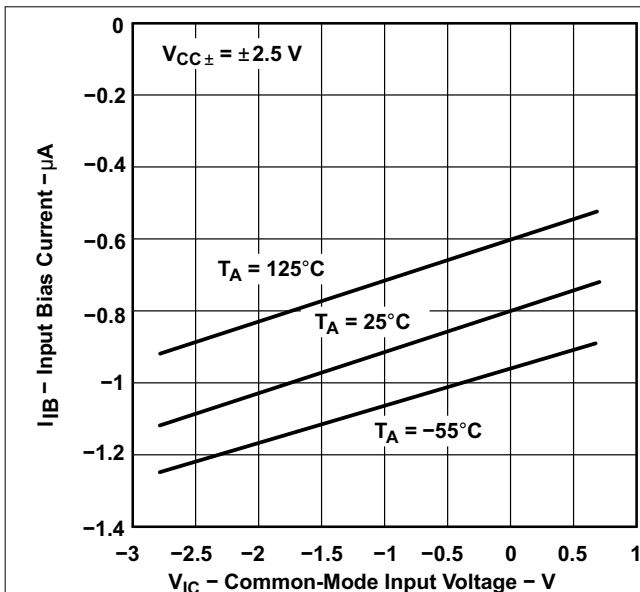

1. 高温和低温下的数据仅适用于各种器件在自然通风条件下的额定工作温度范围内。

图 5-5. 输入偏置电流⁽¹⁾与共模输入电压间的关系

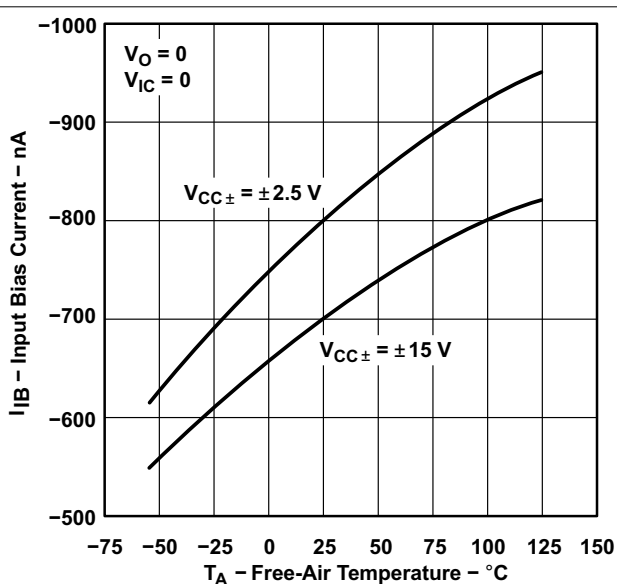

1. 高温和低温下的数据仅适用于各种器件在自然通风条件下的额定工作温度范围内。

图 5-6. 输入偏置电流⁽¹⁾与自然通风温度间的关系



图 5-7. 最大峰值输出电压与电源电压间的关系



图 5-8. 最大峰值输出电压与自然通风温度间的关系

5.42 典型特性 (续)

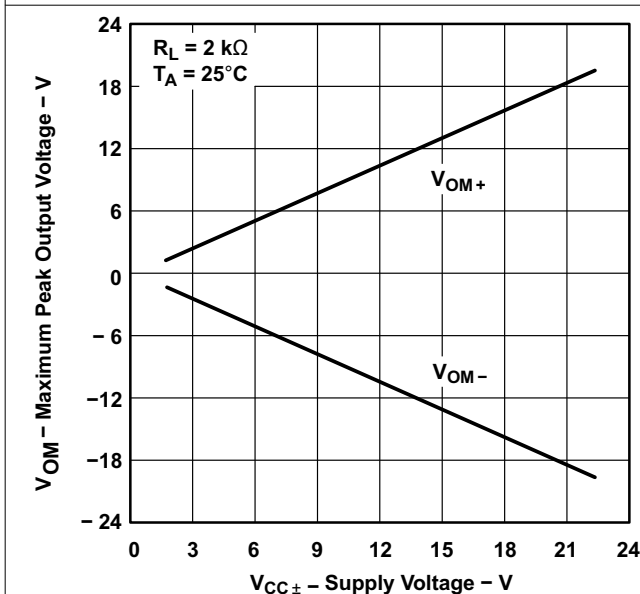

1. 高温和低温下的数据仅适用于各种器件在自然通风条件下的额定工作温度范围内。

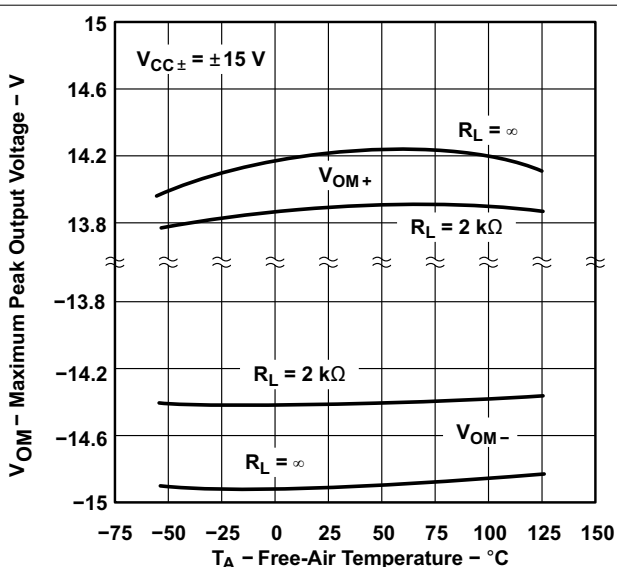
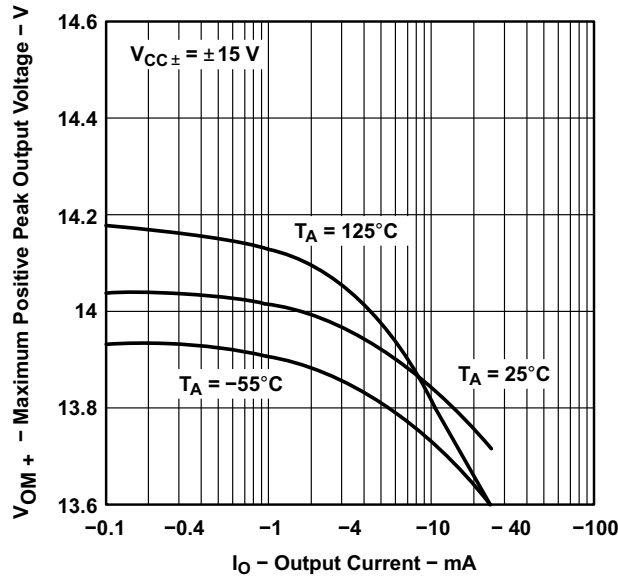
图 5-9. 最大正峰值输出电压⁽¹⁾与输出电流间的关系

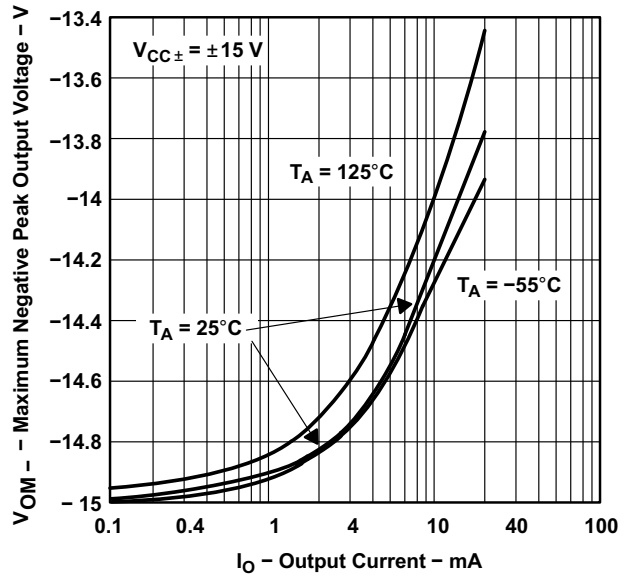

1. 高温和低温下的数据仅适用于各种器件在自然通风条件下的额定工作温度范围内。

图 5-10. 最大负峰值输出电压⁽¹⁾与输出电流间的关系



图 5-11. 最大峰值输出电压与稳定时间之间的关系



1. 高温和低温下的数据仅适用于各种器件在自然通风条件下的额定工作温度范围内。

图 5-12. 最大峰值间输出电压⁽¹⁾与频率间的关系

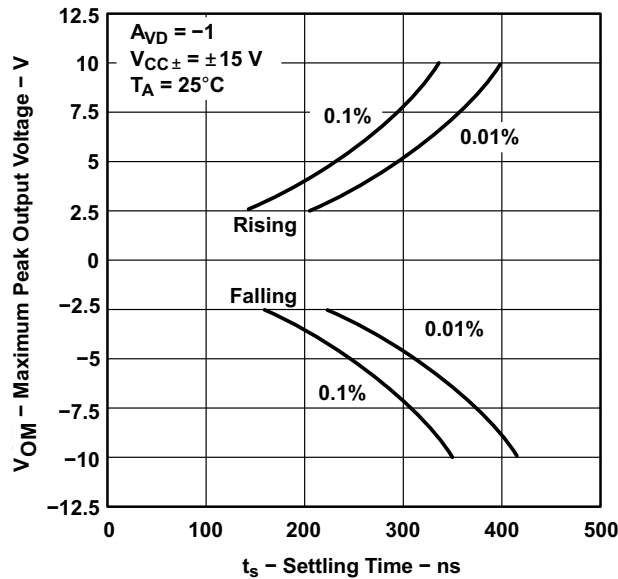
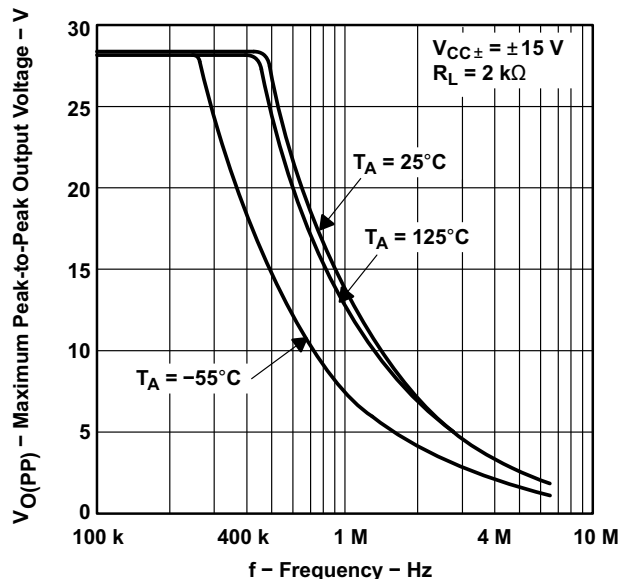
5.42 典型特性 (续)

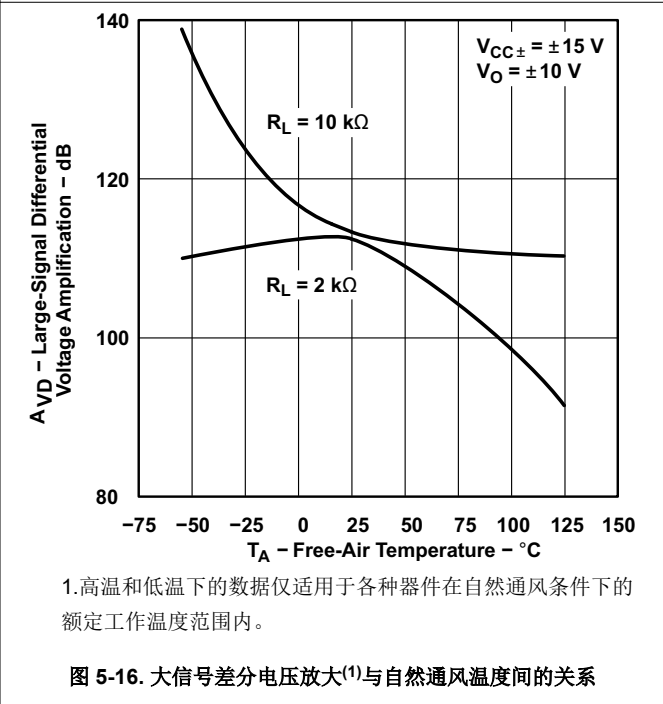
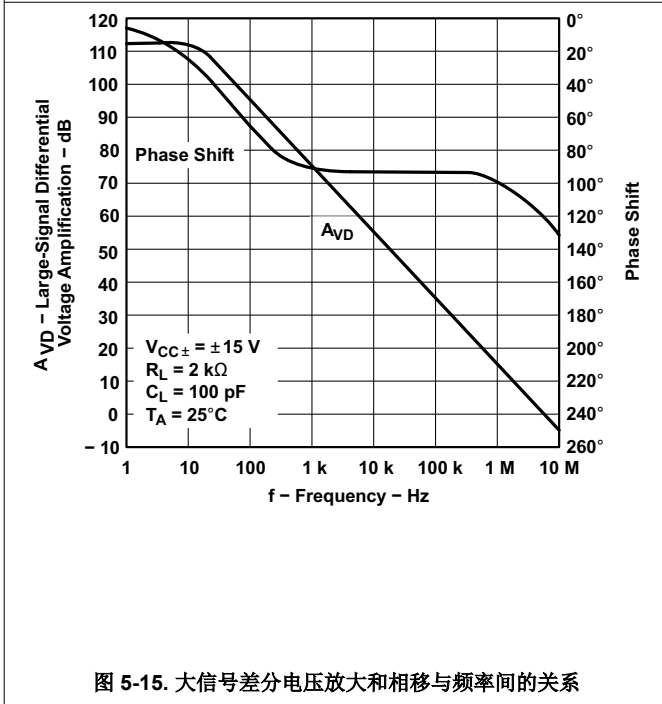
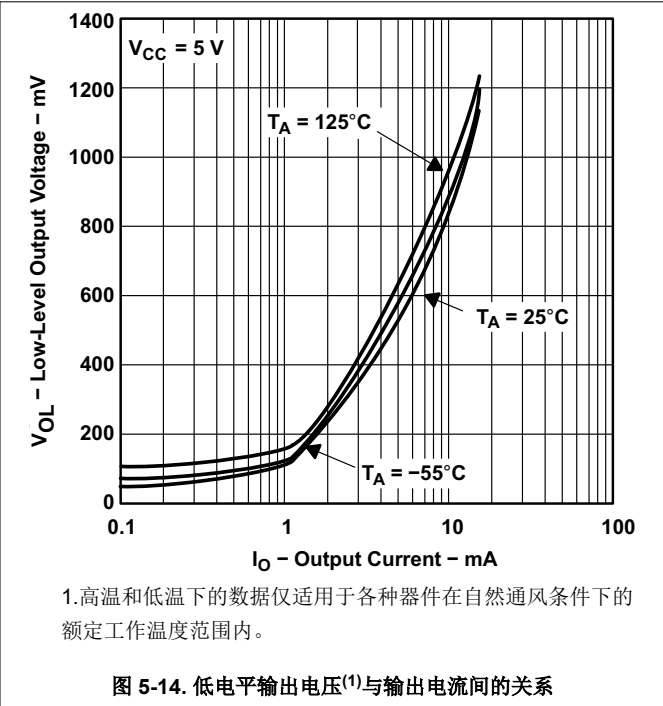
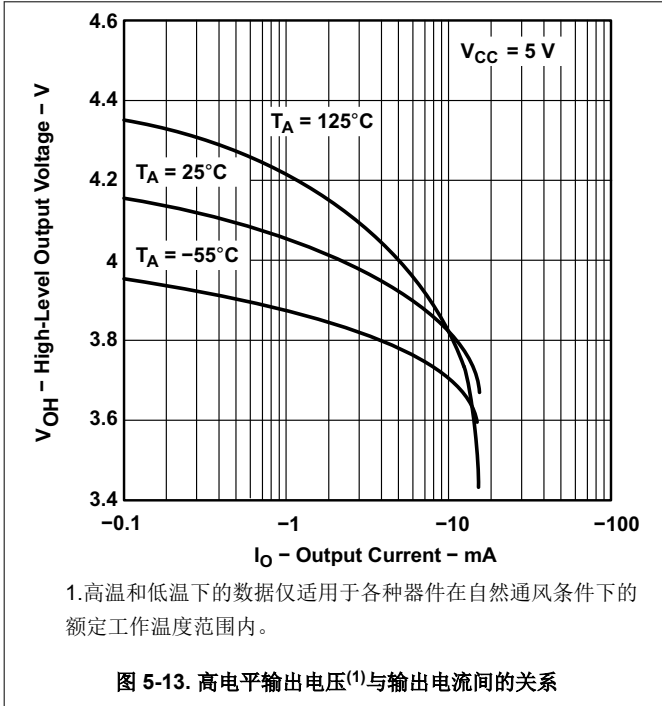

5.42 典型特性 (续)



图 5-17. 闭环输出阻抗与频率间的关系



1. 高温和低温下的数据仅适用于各种器件在自然通风条件下的额定工作温度范围内。

图 5-18. 短路输出电流⁽¹⁾与自然通风温度间的关系

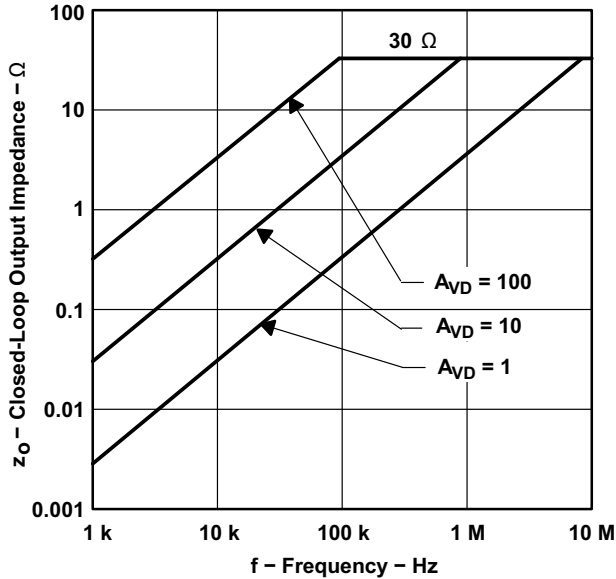
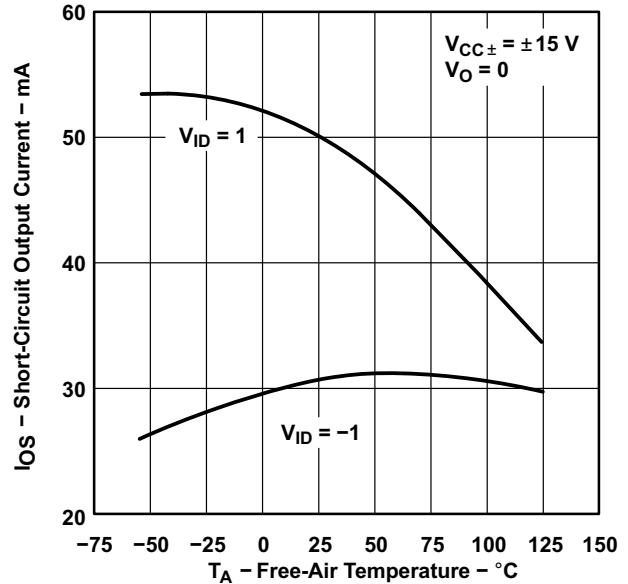

图 5-19. 共模抑制比与频率间的关系



1. 高温和低温下的数据仅适用于各种器件在自然通风条件下的额定工作温度范围内。

图 5-20. 共模抑制比⁽¹⁾与自然通风温度间的关系

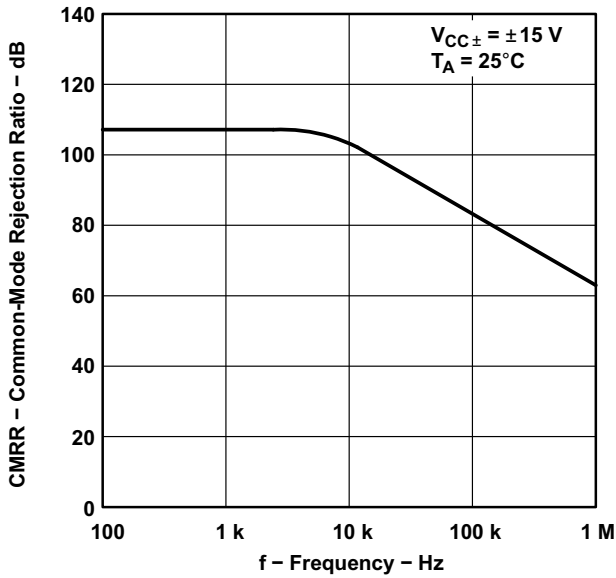
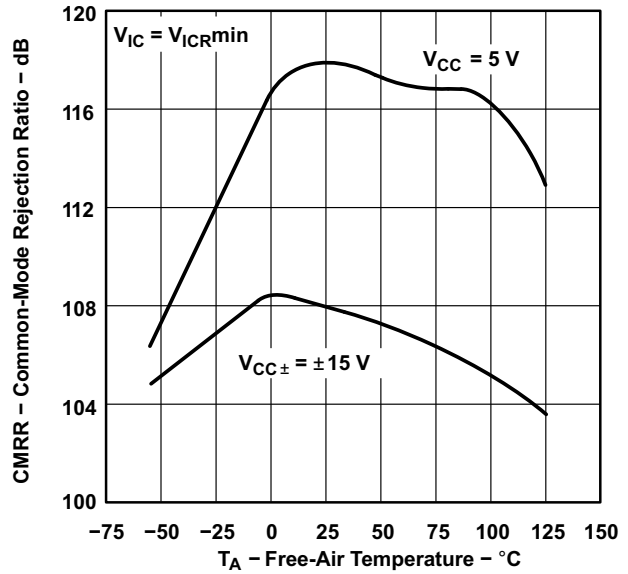
5.42 典型特性 (续)



图 5-21. 电源电压抑制比与频率间的关系



1. 高温和低温下的数据仅适用于各种器件在自然通风条件下的额定工作温度范围内。

图 5-22. 电源电压抑制比⁽¹⁾与自然通风温度间的关系

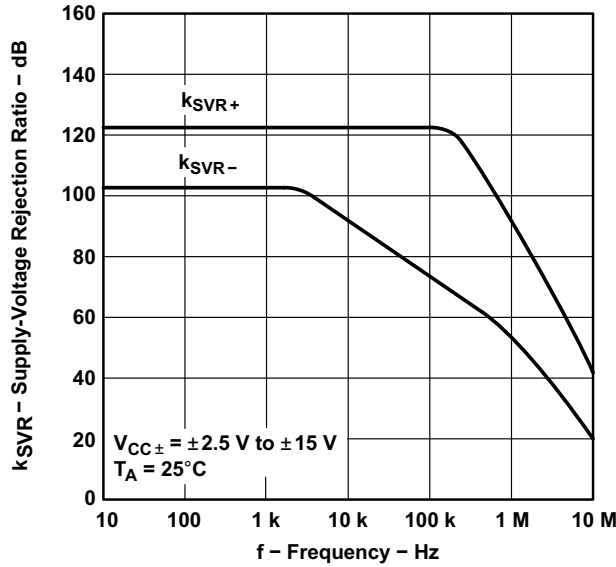
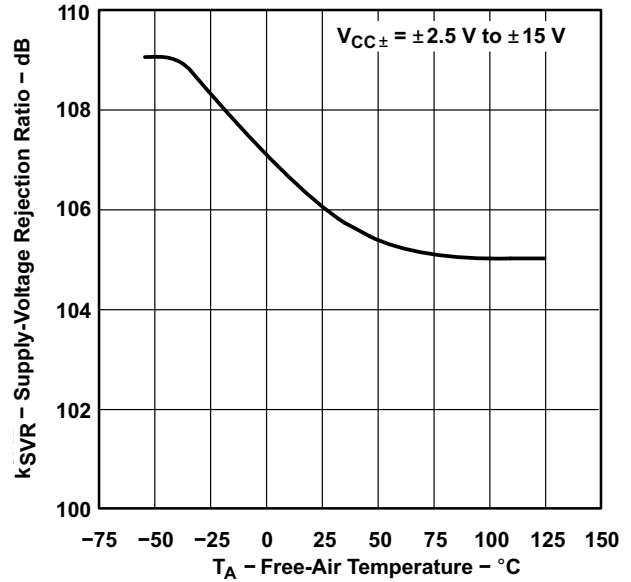
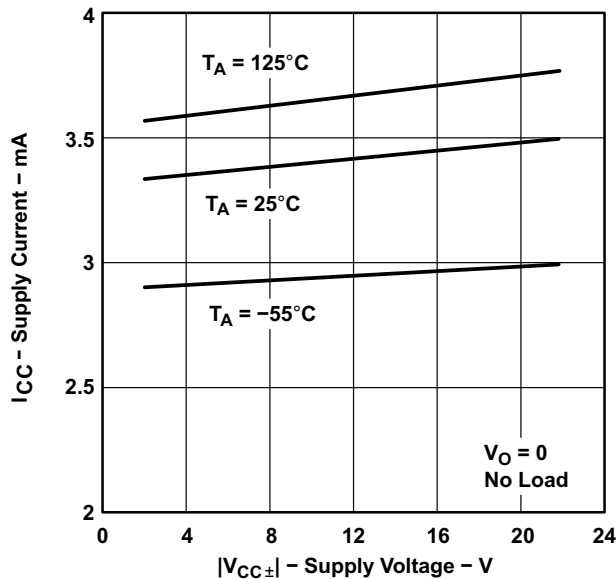

1. 高温和低温下的数据仅适用于各种器件在自然通风条件下的额定工作温度范围内。

图 5-23. 电源电流⁽¹⁾与电源电压间的关系

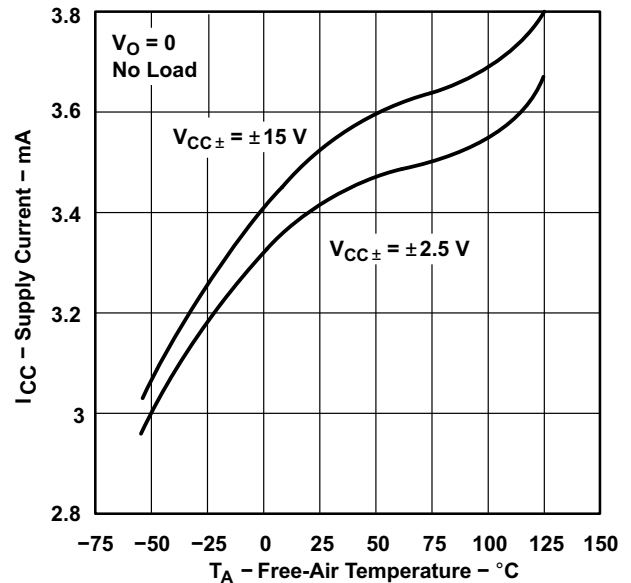

1. 高温和低温下的数据仅适用于各种器件在自然通风条件下的额定工作温度范围内。

图 5-24. 电源电流⁽¹⁾与自然通风温度间的关系

5.42 典型特性 (续)

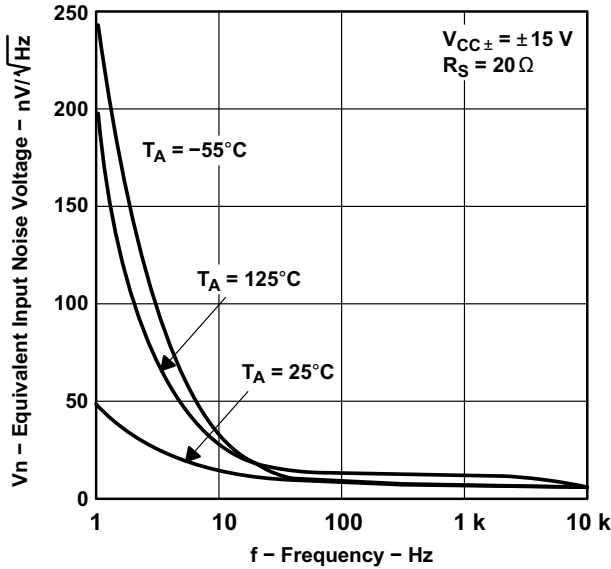

1. 高温和低温下的数据仅适用于各种器件在自然通风条件下的额定工作温度范围内。

图 5-25. 等效输入噪声电压⁽¹⁾与频率间的关系



图 5-26. 10 秒周期内的输入噪声电压



1. 高温和低温下的数据仅适用于各种器件在自然通风条件下的额定工作温度范围内。

图 5-27. 噪声电流⁽¹⁾与频率间的关系

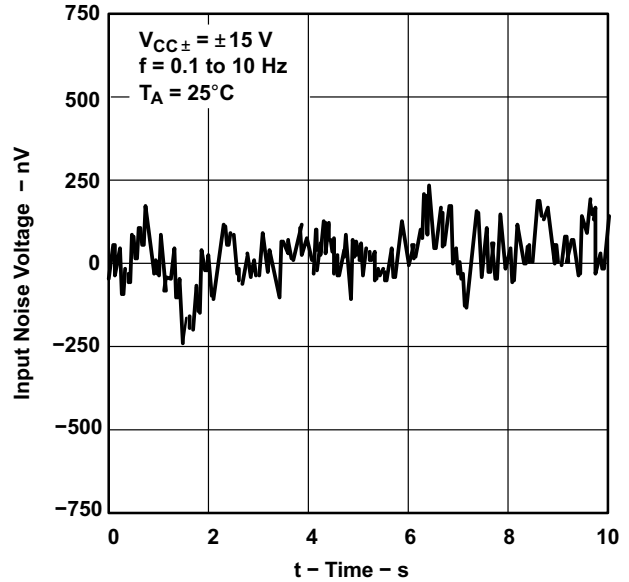
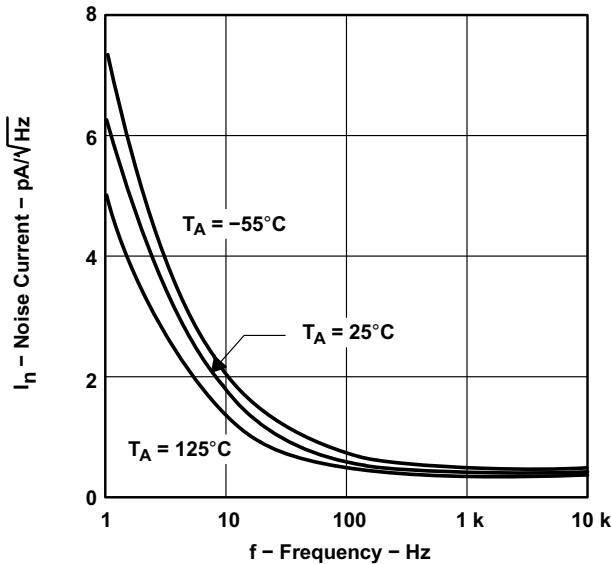

图 5-28. 总谐波失真加噪声与频率间的关系

5.42 典型特性 (续)

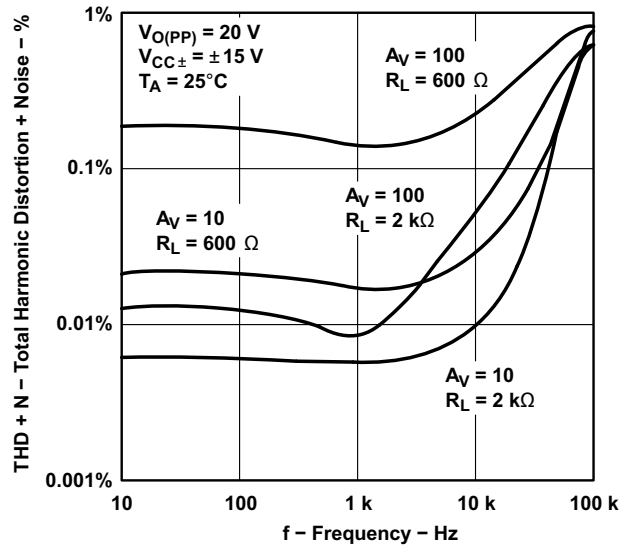
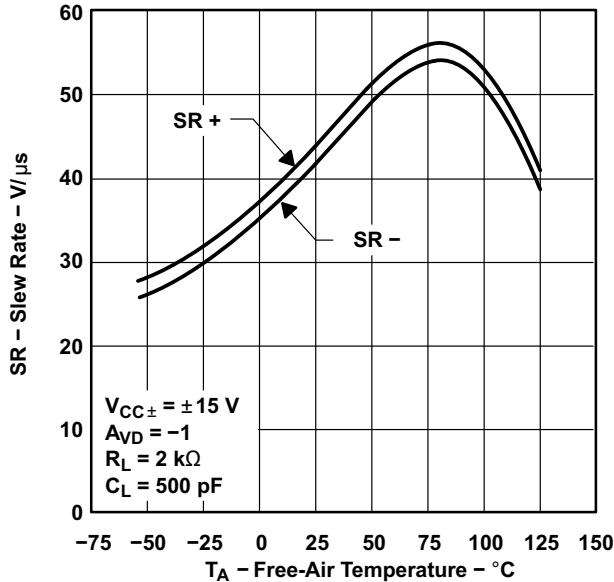

1. 高温和低温下的数据仅适用于各种器件在自然通风条件下的额定工作温度范围内。

图 5-29. 压摆率⁽¹⁾与自然通风温度间的关系



图 5-30. 压摆率与负载电容间的关系



1. 高温和低温下的数据仅适用于各种器件在自然通风条件下的额定工作温度范围内。

图 5-31. 同相大信号脉冲响应⁽¹⁾

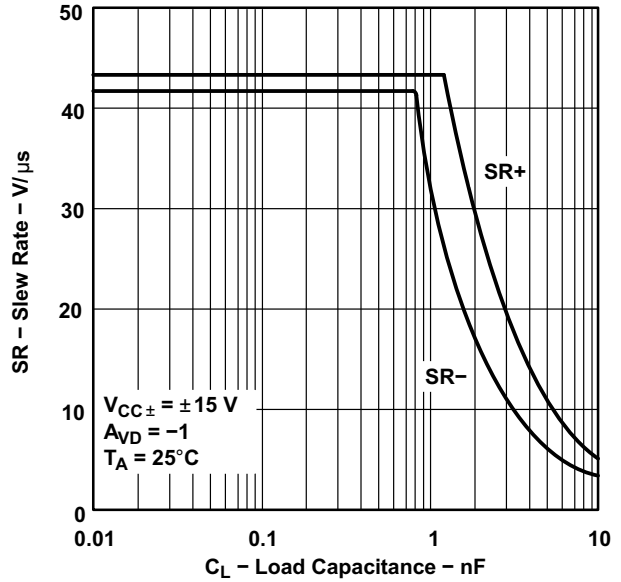
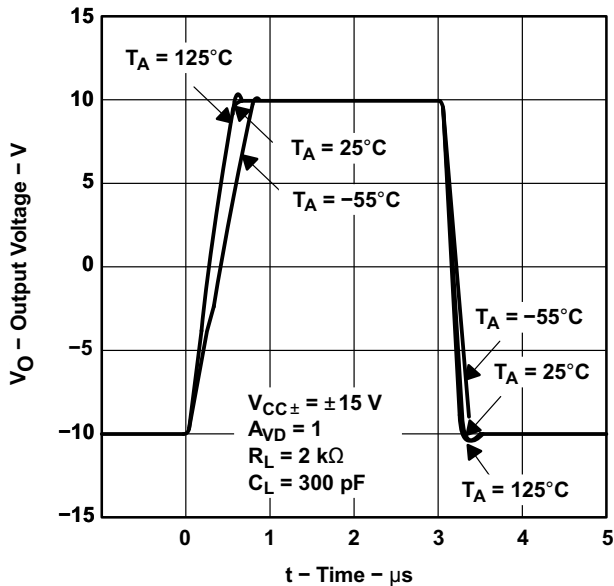
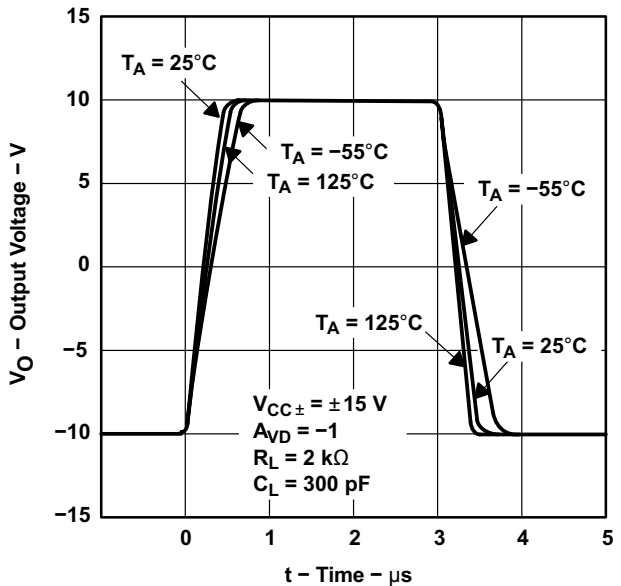

1. 高温和低温下的数据仅适用于各种器件在自然通风条件下的额定工作温度范围内。

图 5-32. 反相大信号脉冲响应⁽¹⁾

5.42 典型特性 (续)



图 5-33. 小信号脉冲响应



1. 高温和低温下的数据仅适用于各种器件在自然通风条件下的额定工作温度范围内。

图 5-34. 单位增益带宽⁽¹⁾与负载电容间的关系

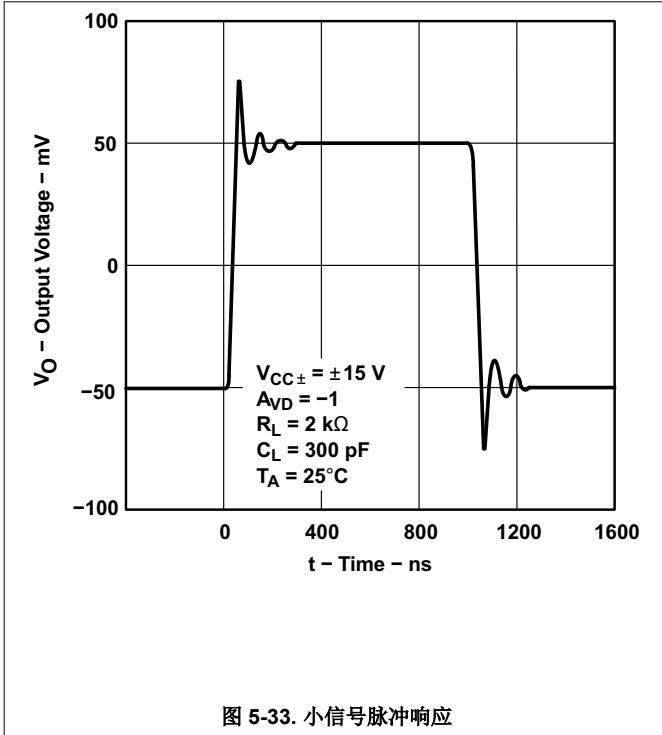
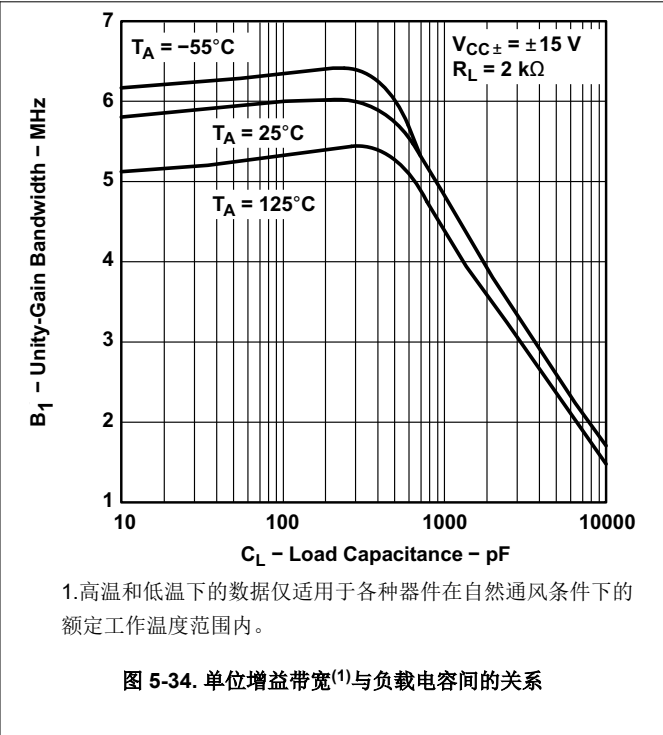

图 5-35. 增益裕度与负载电容间的关系



1. 高温和低温下的数据仅适用于各种器件在自然通风条件下的额定工作温度范围内。

图 5-36. 相位裕度⁽¹⁾与负载电容间的关系

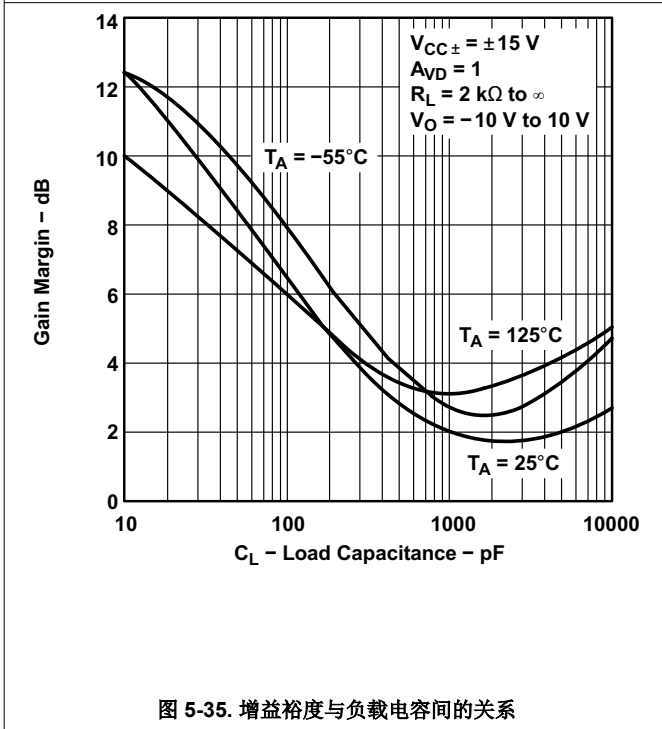
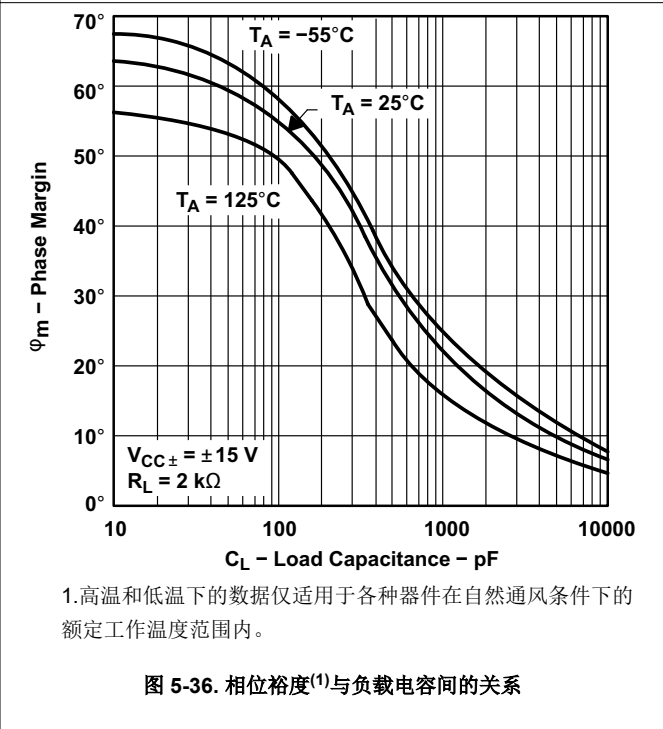
6 详细说明

备注

以下应用部分中的信息不属于 TI 器件规格的范围，TI 不担保其准确性和完整性。TI 的客户应负责确定器件是否适用于其应用。客户应验证并测试其设计，以确保系统功能。

6.1 概述

TLE214x 放大器在高达 10nF 的电容性负载下性能稳定，不过在此高负载水平下，6MHz 带宽会降至 1.8MHz。因此，这些器件可用于低压降采样保持和直接缓冲长电缆，包括 4mA 至 20mA 电流环路。

500 μ V 最大偏移电压和 1.7 μ V/ $^{\circ}$ C 典型漂移也证明了这种特殊设计对固有集成电路元件失配的不敏感性有所提高。最小共模抑制比和电源电压抑制比分别为 85dB 和 90dB。

在 ± 2 V 至 ± 22 V 范围内，器件性能相对不受电源电压的影响。输入可以在 $V_{CC-} - 0.3$ V 至 $V_{CC+} - 1.8$ V 之间工作，而不会引起相位反转，不过每个输入端都可能流出超过较低共模输入范围的过大输入电流。全 NPN 输出级可在轻电流负载条件下提供 $V_{CC-} - 0.1$ V 至 $V_{CC+} - 1$ V 的接近轨到轨输出摆幅。由于输出电流受到内部限制，该器件可以承受任一电源的短路，但必须注意确保不超过最大封装功耗。

7 器件和文档支持

TI 提供广泛的开发工具。下面列出了用于评估器件性能、生成代码和开发解决方案的工具和软件。

7.1 接收文档更新通知

要接收文档更新通知，请导航至 ti.com 上的器件产品文件夹。点击 [通知](#) 进行注册，即可每周接收产品信息更改摘要。有关更改的详细信息，请查看任何已修订文档中包含的修订历史记录。

7.2 支持资源

[TI E2E™ 中文支持论坛](#) 是工程师的重要参考资料，可直接从专家处获得快速、经过验证的解答和设计帮助。搜索现有解答或提出自己的问题，获得所需的快速设计帮助。

链接的内容由各个贡献者“按原样”提供。这些内容并不构成 TI 技术规范，并且不一定反映 TI 的观点；请参阅 TI 的 [使用条款](#)。

7.3 商标

TI E2E™ is a trademark of Texas Instruments.

所有商标均为其各自所有者的财产。

7.4 静电放电警告



静电放电 (ESD) 会损坏这个集成电路。德州仪器 (TI) 建议通过适当的预防措施处理所有集成电路。如果不遵守正确的处理和安装程序，可能会损坏集成电路。

ESD 的损坏小至导致微小的性能降级，大至整个器件故障。精密的集成电路可能更容易受到损坏，这是因为非常细微的参数更改都可能会导致器件与其发布的规格不相符。

7.5 术语表

[TI 术语表](#) 本术语表列出并解释了术语、首字母缩略词和定义。

8 修订历史记录

注：以前版本的页码可能与当前版本的页码不同

Changes from Revision D (October 2012) to Revision E (July 2025)	Page
• 更新了整个文档中的表格、图和交叉参考的编号格式.....	1
• 针对 TLE2141 D、JG 和 P 封装引脚布局，将引脚 1 和 5 从 OFFSET N1 更改为 NC，并将 OFFSET N2 更改为 NC.....	3
• 将所有器件的典型稳定时间规格从 0.34μs (0.1%, ±15V V _S) 更改为 0.43μs，从 0.4μs (0.01%, ±15V V _S) 更改为 0.64μs，从 0.16μs (0.1%, 5V V _S) 更改为 0.66μs，并将 0.22μs (0.01%, 5V V _S) 更改为 0.99μs.....	4
• 将所有器件在 ±15V V _S 时的典型 THD+N 规格从 0.01% 更改为 0.06%.....	4
• 将所有器件在 5V V _S 时的典型最大输出带宽规格从 660kHz 更改为 380kHz.....	4

9 机械、封装和可订购信息

以下页面包含机械、封装和可订购信息。这些信息是指定器件可用的最新数据。数据如有变更，恕不另行通知，且不会对此文档进行修订。有关此数据表的浏览器版本，请查阅左侧的导航栏。

PACKAGING INFORMATION

Orderable part number	Status (1)	Material type (2)	Package Pins	Package qty Carrier	RoHS (3)	Lead finish/ Ball material (4)	MSL rating/ Peak reflow (5)	Op temp (°C)	Part marking (6)
5962-9321603Q2A	Active	Production	LCCC (FK) 20	55 TUBE	No	SNPB	N/A for Pkg Type	-55 to 125	5962- 9321603Q2A TLE2142MFKB
5962-9321603QHA	Active	Production	CFP (U) 10	25 TUBE	No	SNPB	N/A for Pkg Type	-55 to 125	9321603QHA TLE2142M
5962-9321603QPA	Active	Production	CDIP (JG) 8	50 TUBE	No	SNPB	N/A for Pkg Type	-55 to 125	9321603QPA TLE2142M
5962-9321604Q2A	Active	Production	LCCC (FK) 20	55 TUBE	No	SNPB	N/A for Pkg Type	-55 to 125	5962- 9321604Q2A TLE2142 AMFKB
5962-9321604QHA	Active	Production	CFP (U) 10	25 TUBE	No	SNPB	N/A for Pkg Type	-55 to 125	9321604QHA TLE2142AM
5962-9321604QPA	Active	Production	CDIP (JG) 8	50 TUBE	No	SNPB	N/A for Pkg Type	-55 to 125	9321604QPA TLE2142AM
5962-9321605Q2A	Active	Production	LCCC (FK) 20	55 TUBE	No	SNPB	N/A for Pkg Type	-55 to 125	5962- 9321605Q2A TLE2144MFKB
5962-9321605QCA	Active	Production	CDIP (J) 14	25 TUBE	No	SNPB	N/A for Pkg Type	-55 to 125	5962-9321605QC A TLE2144MJB
5962-9321606Q2A	Active	Production	LCCC (FK) 20	55 TUBE	No	SNPB	N/A for Pkg Type	-55 to 125	5962- 9321606Q2A TLE2144 AMFKB
5962-9321606QCA	Active	Production	CDIP (J) 14	25 TUBE	No	SNPB	N/A for Pkg Type	-55 to 125	5962-9321606QC A TLE2144AMJB
TLE2141ACD	Obsolete	Production	SOIC (D) 8	-	-	Call TI	Call TI	-	2141AC
TLE2141ACP	Active	Production	PDIP (P) 8	50 TUBE	Yes	NIPDAU	N/A for Pkg Type	-	TLE2141AC
TLE2141ACP.A	Active	Production	PDIP (P) 8	50 TUBE	Yes	NIPDAU	N/A for Pkg Type	0 to 70	TLE2141AC
TLE2141AID	Obsolete	Production	SOIC (D) 8	-	-	Call TI	Call TI	-	2141AI
TLE2141AIDR	Active	Production	SOIC (D) 8	2500 LARGE T&R	Yes	NIPDAU	Level-1-260C-UNLIM	-	2141AI
TLE2141AIDR.A	Active	Production	SOIC (D) 8	2500 LARGE T&R	Yes	NIPDAU	Level-1-260C-UNLIM	0 to 70	2141AI

Orderable part number	Status (1)	Material type (2)	Package Pins	Package qty Carrier	RoHS (3)	Lead finish/ Ball material (4)	MSL rating/ Peak reflow (5)	Op temp (°C)	Part marking (6)
TLE2141AIP	Active	Production	PDIP (P) 8	50 TUBE	Yes	NIPDAU	N/A for Pkg Type	0 to 70	TLE2141AI
TLE2141AIP.A	Active	Production	PDIP (P) 8	50 TUBE	Yes	NIPDAU	N/A for Pkg Type	0 to 70	TLE2141AI
TLE2141CD	Obsolete	Production	SOIC (D) 8	-	-	Call TI	Call TI	-	2141C
TLE2141CDR	Active	Production	SOIC (D) 8	2500 LARGE T&R	Yes	NIPDAU	Level-1-260C-UNLIM	-	2141C
TLE2141CDR.A	Active	Production	SOIC (D) 8	2500 LARGE T&R	Yes	NIPDAU	Level-1-260C-UNLIM	-55 to 125	2141C
TLE2141CDRG4	Active	Production	SOIC (D) 8	2500 LARGE T&R	-	Call TI	Call TI	See TLE2141CDR	
TLE2141CP	Active	Production	PDIP (P) 8	50 TUBE	Yes	NIPDAU	N/A for Pkg Type	-	TLE2141CP
TLE2141CP.A	Active	Production	PDIP (P) 8	50 TUBE	Yes	NIPDAU	N/A for Pkg Type	-55 to 125	TLE2141CP
TLE2141ID	Obsolete	Production	SOIC (D) 8	-	-	Call TI	Call TI	-	2141I
TLE2141IDR	Active	Production	SOIC (D) 8	2500 LARGE T&R	Yes	NIPDAU	Level-1-260C-UNLIM	-	2141I
TLE2141IDR.A	Active	Production	SOIC (D) 8	2500 LARGE T&R	Yes	NIPDAU	Level-1-260C-UNLIM	-55 to 125	2141I
TLE2141IP	Active	Production	PDIP (P) 8	50 TUBE	Yes	NIPDAU	N/A for Pkg Type	-	TLE2141IP
TLE2141IP.A	Active	Production	PDIP (P) 8	50 TUBE	Yes	NIPDAU	N/A for Pkg Type	-55 to 125	TLE2141IP
TLE2141MD	Active	Production	SOIC (D) 8	75 TUBE	Yes	NIPDAU	Level-1-260C-UNLIM	-55 to 125	2141M
TLE2141MD.A	Active	Production	SOIC (D) 8	75 TUBE	Yes	NIPDAU	Level-1-260C-UNLIM	-55 to 125	2141M
TLE2141MDR	Active	Production	SOIC (D) 8	2500 LARGE T&R	Yes	NIPDAU	Level-1-260C-UNLIM	-55 to 125	2141M
TLE2141MDR.A	Active	Production	SOIC (D) 8	2500 LARGE T&R	Yes	NIPDAU	Level-1-260C-UNLIM	-55 to 125	2141M
TLE2142ACD	Obsolete	Production	SOIC (D) 8	-	-	Call TI	Call TI	0 to 70	2142AC
TLE2142ACDR	Active	Production	SOIC (D) 8	2500 LARGE T&R	Yes	NIPDAU	Level-1-260C-UNLIM	-	2142AC
TLE2142ACDR.A	Active	Production	SOIC (D) 8	2500 LARGE T&R	Yes	NIPDAU	Level-1-260C-UNLIM	-40 to 85	2142AC
TLE2142AID	Obsolete	Production	SOIC (D) 8	-	-	Call TI	Call TI	-40 to 85	2142AI
TLE2142AIDR	Active	Production	SOIC (D) 8	2500 LARGE T&R	Yes	NIPDAU	Level-1-260C-UNLIM	-	2142AI
TLE2142AIDR.A	Active	Production	SOIC (D) 8	2500 LARGE T&R	Yes	NIPDAU	Level-1-260C-UNLIM	-40 to 85	2142AI
TLE2142AMD	Obsolete	Production	SOIC (D) 8	-	-	Call TI	Call TI	-55 to 125	
TLE2142AMDG4	Obsolete	Production	SOIC (D) 8	-	-	Call TI	Call TI	-	E2142A
TLE2142AMDR	Active	Production	SOIC (D) 8	2500 LARGE T&R	Yes	NIPDAU	Level-1-260C-UNLIM	-55 to 125	E2142A
TLE2142AMDR.A	Active	Production	SOIC (D) 8	2500 LARGE T&R	Yes	NIPDAU	Level-1-260C-UNLIM	-55 to 125	E2142A
TLE2142AMDRG4	Obsolete	Production	SOIC (D) 8	-	-	Call TI	Call TI	-	

Orderable part number	Status (1)	Material type (2)	Package Pins	Package qty Carrier	RoHS (3)	Lead finish/ Ball material (4)	MSL rating/ Peak reflow (5)	Op temp (°C)	Part marking (6)
TLE2142AMFKB	Active	Production	LCCC (FK) 20	55 TUBE	No	SNPB	N/A for Pkg Type	-55 to 125	5962- 9321604Q2A TLE2142 AMFKB
TLE2142AMFKB.A	Active	Production	LCCC (FK) 20	55 TUBE	No	SNPB	N/A for Pkg Type	-55 to 125	5962- 9321604Q2A TLE2142 AMFKB
TLE2142AMJG	Active	Production	CDIP (JG) 8	50 TUBE	No	SNPB	N/A for Pkg Type	-	TLE2142AMJG
TLE2142AMJG.A	Active	Production	CDIP (JG) 8	50 TUBE	No	SNPB	N/A for Pkg Type	-55 to 125	TLE2142AMJG
TLE2142AMJGB	Active	Production	CDIP (JG) 8	50 TUBE	No	SNPB	N/A for Pkg Type	-55 to 125	9321604QPA TLE2142AM
TLE2142AMJGB.A	Active	Production	CDIP (JG) 8	50 TUBE	No	SNPB	N/A for Pkg Type	-55 to 125	9321604QPA TLE2142AM
TLE2142AMUB	Active	Production	CFP (U) 10	25 TUBE	No	SNPB	N/A for Pkg Type	-55 to 125	9321604QHA TLE2142AM
TLE2142AMUB.A	Active	Production	CFP (U) 10	25 TUBE	No	SNPB	N/A for Pkg Type	-55 to 125	9321604QHA TLE2142AM
TLE2142CD	Obsolete	Production	SOIC (D) 8	-	-	Call TI	Call TI	0 to 70	2142C
TLE2142CDR	Active	Production	SOIC (D) 8	2500 LARGE T&R	Yes	NIPDAU	Level-1-260C-UNLIM	0 to 70	2142C
TLE2142CDR.A	Active	Production	SOIC (D) 8	2500 LARGE T&R	Yes	NIPDAU	Level-1-260C-UNLIM	0 to 70	2142C
TLE2142CDRG4	Active	Production	SOIC (D) 8	2500 LARGE T&R	-	Call TI	Call TI	0 to 70	
TLE2142CP	Active	Production	PDIP (P) 8	50 TUBE	Yes	NIPDAU	N/A for Pkg Type	0 to 70	TLE2142CP
TLE2142CP.A	Active	Production	PDIP (P) 8	50 TUBE	Yes	NIPDAU	N/A for Pkg Type	0 to 70	TLE2142CP
TLE2142CPWR	Active	Production	TSSOP (PW) 16	2000 LARGE T&R	Yes	NIPDAU	Level-1-260C-UNLIM	0 to 70	Q2142
TLE2142CPWR.A	Active	Production	TSSOP (PW) 16	2000 LARGE T&R	Yes	NIPDAU	Level-1-260C-UNLIM	0 to 70	Q2142
TLE2142ID	Obsolete	Production	SOIC (D) 8	-	-	Call TI	Call TI	-40 to 105	2142I
TLE2142IDR	Active	Production	SOIC (D) 8	2500 LARGE T&R	Yes	NIPDAU	Level-1-260C-UNLIM	-40 to 105	2142I
TLE2142IDR.A	Active	Production	SOIC (D) 8	2500 LARGE T&R	Yes	NIPDAU	Level-1-260C-UNLIM	-40 to 105	2142I
TLE2142IP	Active	Production	PDIP (P) 8	50 TUBE	Yes	NIPDAU	N/A for Pkg Type	-40 to 105	TLE2142IP
TLE2142IP.A	Active	Production	PDIP (P) 8	50 TUBE	Yes	NIPDAU	N/A for Pkg Type	-40 to 105	TLE2142IP
TLE2142MD	Obsolete	Production	SOIC (D) 8	-	-	Call TI	Call TI	-55 to 125	
TLE2142MDG4	Obsolete	Production	SOIC (D) 8	-	-	Call TI	Call TI	-	

Orderable part number	Status (1)	Material type (2)	Package Pins	Package qty Carrier	RoHS (3)	Lead finish/ Ball material (4)	MSL rating/ Peak reflow (5)	Op temp (°C)	Part marking (6)
TLE2142MDR	Active	Production	SOIC (D) 8	2500 LARGE T&R	Yes	NIPDAU	Level-1-260C-UNLIM	-55 to 125	2142M
TLE2142MDR.A	Active	Production	SOIC (D) 8	2500 LARGE T&R	Yes	NIPDAU	Level-1-260C-UNLIM	-55 to 125	2142M
TLE2142MFKB	Active	Production	LCCC (FK) 20	55 TUBE	No	SNPB	N/A for Pkg Type	-55 to 125	5962-9321603Q2A TLE2142MFKB
TLE2142MFKB.A	Active	Production	LCCC (FK) 20	55 TUBE	No	SNPB	N/A for Pkg Type	-55 to 125	5962-9321603Q2A TLE2142MFKB
TLE2142MJGB	Active	Production	CDIP (JG) 8	50 TUBE	No	SNPB	N/A for Pkg Type	-55 to 125	9321603QPA TLE2142M
TLE2142MJGB.A	Active	Production	CDIP (JG) 8	50 TUBE	No	SNPB	N/A for Pkg Type	-55 to 125	9321603QPA TLE2142M
TLE2142MUB	Active	Production	CFP (U) 10	25 TUBE	No	SNPB	N/A for Pkg Type	-55 to 125	9321603QHA TLE2142M
TLE2142MUB.A	Active	Production	CFP (U) 10	25 TUBE	No	SNPB	N/A for Pkg Type	-55 to 125	9321603QHA TLE2142M
TLE2144ACN	Active	Production	PDIP (N) 14	25 TUBE	Yes	NIPDAU	N/A for Pkg Type	0 to 70	TLE2144ACN
TLE2144ACN.A	Active	Production	PDIP (N) 14	25 TUBE	Yes	NIPDAU	N/A for Pkg Type	0 to 70	TLE2144ACN
TLE2144AIN	Active	Production	PDIP (N) 14	25 TUBE	Yes	NIPDAU	N/A for Pkg Type	-40 to 85	TLE2144AIN
TLE2144AIN.A	Active	Production	PDIP (N) 14	25 TUBE	Yes	NIPDAU	N/A for Pkg Type	-40 to 85	TLE2144AIN
TLE2144AMFKB	Active	Production	LCCC (FK) 20	55 TUBE	No	SNPB	N/A for Pkg Type	-55 to 125	5962-9321606Q2A TLE2144 AMFKB
TLE2144AMFKB.A	Active	Production	LCCC (FK) 20	55 TUBE	No	SNPB	N/A for Pkg Type	-55 to 125	5962-9321606Q2A TLE2144 AMFKB
TLE2144AMJB	Active	Production	CDIP (J) 14	25 TUBE	No	SNPB	N/A for Pkg Type	-55 to 125	5962-9321606QC A TLE2144AMJB
TLE2144AMJB.A	Active	Production	CDIP (J) 14	25 TUBE	No	SNPB	N/A for Pkg Type	-55 to 125	5962-9321606QC A TLE2144AMJB
TLE2144CDW	Active	Production	SOIC (DW) 16	40 TUBE	Yes	NIPDAU	Level-1-260C-UNLIM	0 to 70	TLE2144C

Orderable part number	Status (1)	Material type (2)	Package Pins	Package qty Carrier	RoHS (3)	Lead finish/ Ball material (4)	MSL rating/ Peak reflow (5)	Op temp (°C)	Part marking (6)
TLE2144CDW.A	Active	Production	SOIC (DW) 16	40 TUBE	Yes	NIPDAU	Level-1-260C-UNLIM	0 to 70	TLE2144C
TLE2144CDWR	Active	Production	SOIC (DW) 16	2000 LARGE T&R	Yes	NIPDAU	Level-1-260C-UNLIM	0 to 70	TLE2144C
TLE2144CDWR.A	Active	Production	SOIC (DW) 16	2000 LARGE T&R	Yes	NIPDAU	Level-1-260C-UNLIM	0 to 70	TLE2144C
TLE2144CN	Active	Production	PDIP (N) 14	25 TUBE	Yes	NIPDAU	N/A for Pkg Type	0 to 70	TLE2144CN
TLE2144CN.A	Active	Production	PDIP (N) 14	25 TUBE	Yes	NIPDAU	N/A for Pkg Type	0 to 70	TLE2144CN
TLE2144IDW	Active	Production	SOIC (DW) 16	40 TUBE	Yes	NIPDAU	Level-1-260C-UNLIM	-40 to 105	TLE2144I
TLE2144IDW.A	Active	Production	SOIC (DW) 16	40 TUBE	Yes	NIPDAU	Level-1-260C-UNLIM	-40 to 105	TLE2144I
TLE2144IDWR	Active	Production	SOIC (DW) 16	2000 LARGE T&R	Yes	NIPDAU	Level-1-260C-UNLIM	-40 to 105	TLE2144I
TLE2144IDWR.A	Active	Production	SOIC (DW) 16	2000 LARGE T&R	Yes	NIPDAU	Level-1-260C-UNLIM	-40 to 105	TLE2144I
TLE2144IN	Active	Production	PDIP (N) 14	25 TUBE	Yes	NIPDAU	N/A for Pkg Type	-40 to 105	TLE2144IN
TLE2144IN.A	Active	Production	PDIP (N) 14	25 TUBE	Yes	NIPDAU	N/A for Pkg Type	-40 to 105	TLE2144IN
TLE2144MDW	Active	Production	SOIC (DW) 16	40 TUBE	Yes	NIPDAU	Level-1-260C-UNLIM	-55 to 125	TLE2144M
TLE2144MDW.A	Active	Production	SOIC (DW) 16	40 TUBE	Yes	NIPDAU	Level-1-260C-UNLIM	-55 to 125	TLE2144M
TLE2144MDWG4	Active	Production	SOIC (DW) 16	40 TUBE	Yes	NIPDAU	Level-1-260C-UNLIM	-	TLE2144M
TLE2144MDWG4.A	Active	Production	SOIC (DW) 16	40 TUBE	Yes	NIPDAU	Level-1-260C-UNLIM	-55 to 125	TLE2144M
TLE2144MFKB	Active	Production	LCCC (FK) 20	55 TUBE	No	SNPB	N/A for Pkg Type	-55 to 125	5962-9321605Q2A TLE2144MFKB
TLE2144MFKB.A	Active	Production	LCCC (FK) 20	55 TUBE	No	SNPB	N/A for Pkg Type	-55 to 125	5962-9321605Q2A TLE2144MFKB
TLE2144MJB	Active	Production	CDIP (J) 14	25 TUBE	No	SNPB	N/A for Pkg Type	-55 to 125	5962-9321605QC A TLE2144MJB
TLE2144MJB.A	Active	Production	CDIP (J) 14	25 TUBE	No	SNPB	N/A for Pkg Type	-55 to 125	5962-9321605QC A TLE2144MJB

(1) **Status:** For more details on status, see our [product life cycle](#).

(2) **Material type:** When designated, preproduction parts are prototypes/experimental devices, and are not yet approved or released for full production. Testing and final process, including without limitation quality assurance, reliability performance testing, and/or process qualification, may not yet be complete, and this item is subject to further changes or possible discontinuation. If available for ordering, purchases will be subject to an additional waiver at checkout, and are intended for early internal evaluation purposes only. These items are sold without warranties of any kind.

(3) **RoHS values:** Yes, No, RoHS Exempt. See the [TI RoHS Statement](#) for additional information and value definition.

(4) **Lead finish/Ball material:** Parts may have multiple material finish options. Finish options are separated by a vertical ruled line. Lead finish/Ball material values may wrap to two lines if the finish value exceeds the maximum column width.

(5) **MSL rating/Peak reflow:** The moisture sensitivity level ratings and peak solder (reflow) temperatures. In the event that a part has multiple moisture sensitivity ratings, only the lowest level per JEDEC standards is shown. Refer to the shipping label for the actual reflow temperature that will be used to mount the part to the printed circuit board.

(6) **Part marking:** There may be an additional marking, which relates to the logo, the lot trace code information, or the environmental category of the part.

Multiple part markings will be inside parentheses. Only one part marking contained in parentheses and separated by a "~" will appear on a part. If a line is indented then it is a continuation of the previous line and the two combined represent the entire part marking for that device.

Important Information and Disclaimer: The information provided on this page represents TI's knowledge and belief as of the date that it is provided. TI bases its knowledge and belief on information provided by third parties, and makes no representation or warranty as to the accuracy of such information. Efforts are underway to better integrate information from third parties. TI has taken and continues to take reasonable steps to provide representative and accurate information but may not have conducted destructive testing or chemical analysis on incoming materials and chemicals. TI and TI suppliers consider certain information to be proprietary, and thus CAS numbers and other limited information may not be available for release.

In no event shall TI's liability arising out of such information exceed the total purchase price of the TI part(s) at issue in this document sold by TI to Customer on an annual basis.

OTHER QUALIFIED VERSIONS OF TLE2141, TLE2141A, TLE2142, TLE2142A, TLE2142AM, TLE2142M, TLE2144, TLE2144A, TLE2144AM, TLE2144M :

- Catalog : [TLE2142A](#), [TLE2142](#), [TLE2144A](#), [TLE2144](#)
- Automotive : [TLE2141-Q1](#), [TLE2142-Q1](#), [TLE2142-Q1](#)
- Enhanced Product : [TLE2141-EP](#), [TLE2144-EP](#), [TLE2144-EP](#)
- Military : [TLE2141M](#), [TLE2141AM](#), [TLE2142M](#), [TLE2142AM](#), [TLE2144M](#), [TLE2144AM](#)

NOTE: Qualified Version Definitions:

- Catalog - TI's standard catalog product
- Automotive - Q100 devices qualified for high-reliability automotive applications targeting zero defects
- Enhanced Product - Supports Defense, Aerospace and Medical Applications

- Military - QML certified for Military and Defense Applications

TAPE AND REEL INFORMATION

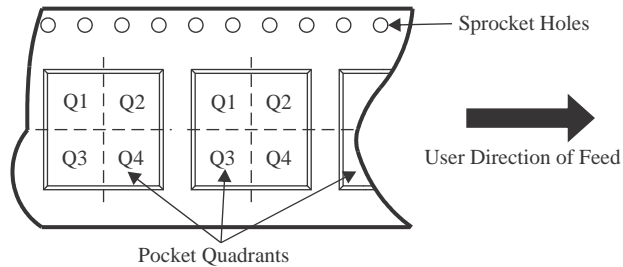
QUADRANT ASSIGNMENTS FOR PIN 1 ORIENTATION IN TAPE

*All dimensions are nominal

Device	Package Type	Package Drawing	Pins	SPQ	Reel Diameter (mm)	Reel Width W1 (mm)	A0 (mm)	B0 (mm)	K0 (mm)	P1 (mm)	W (mm)	Pin1 Quadrant
TLE2141AIDR	SOIC	D	8	2500	330.0	12.4	6.4	5.2	2.1	8.0	12.0	Q1
TLE2141CDR	SOIC	D	8	2500	330.0	12.4	6.4	5.2	2.1	8.0	12.0	Q1
TLE2141IDR	SOIC	D	8	2500	330.0	12.4	6.4	5.2	2.1	8.0	12.0	Q1
TLE2141MDR	SOIC	D	8	2500	330.0	12.4	6.4	5.2	2.1	8.0	12.0	Q1
TLE2142ACDR	SOIC	D	8	2500	330.0	12.4	6.4	5.2	2.1	8.0	12.0	Q1
TLE2142AIDR	SOIC	D	8	2500	330.0	12.4	6.4	5.2	2.1	8.0	12.0	Q1
TLE2142AMDR	SOIC	D	8	2500	330.0	12.4	6.4	5.2	2.1	8.0	12.0	Q1
TLE2142CDR	SOIC	D	8	2500	330.0	12.4	6.4	5.2	2.1	8.0	12.0	Q1
TLE2142CPWR	TSSOP	PW	16	2000	330.0	12.4	6.9	5.6	1.6	8.0	12.0	Q1
TLE2142IDR	SOIC	D	8	2500	330.0	12.4	6.4	5.2	2.1	8.0	12.0	Q1
TLE2142MDR	SOIC	D	8	2500	330.0	12.4	6.4	5.2	2.1	8.0	12.0	Q1
TLE2144CDWR	SOIC	DW	16	2000	330.0	16.4	10.75	10.7	2.7	12.0	16.0	Q1
TLE2144IDWR	SOIC	DW	16	2000	330.0	16.4	10.75	10.7	2.7	12.0	16.0	Q1

TAPE AND REEL BOX DIMENSIONS

*All dimensions are nominal

Device	Package Type	Package Drawing	Pins	SPQ	Length (mm)	Width (mm)	Height (mm)
TLE2141AIDR	SOIC	D	8	2500	353.0	353.0	32.0
TLE2141CDR	SOIC	D	8	2500	353.0	353.0	32.0
TLE2141IDR	SOIC	D	8	2500	353.0	353.0	32.0
TLE2141MDR	SOIC	D	8	2500	350.0	350.0	43.0
TLE2142ACDR	SOIC	D	8	2500	353.0	353.0	32.0
TLE2142AIDR	SOIC	D	8	2500	353.0	353.0	32.0
TLE2142AMDR	SOIC	D	8	2500	353.0	353.0	32.0
TLE2142CDR	SOIC	D	8	2500	353.0	353.0	32.0
TLE2142CPWR	TSSOP	PW	16	2000	353.0	353.0	32.0
TLE2142IDR	SOIC	D	8	2500	353.0	353.0	32.0
TLE2142MDR	SOIC	D	8	2500	353.0	353.0	32.0
TLE2144CDWR	SOIC	DW	16	2000	350.0	350.0	43.0
TLE2144IDWR	SOIC	DW	16	2000	350.0	350.0	43.0

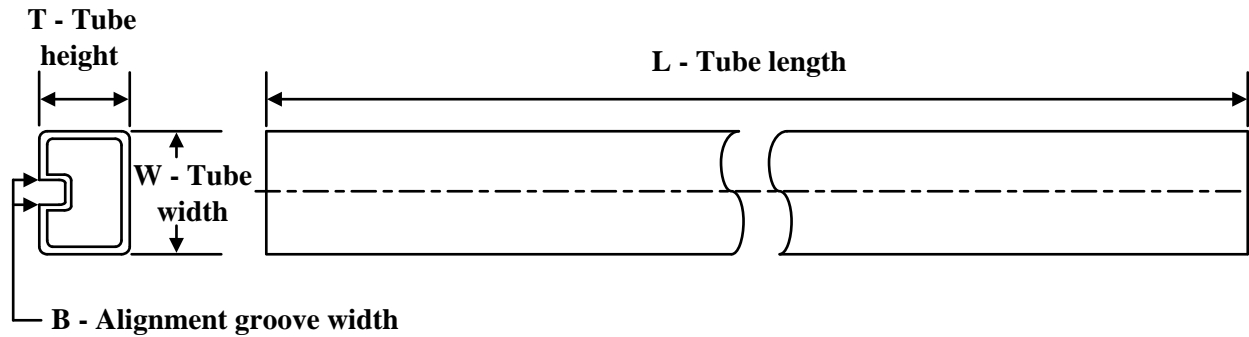
TUBE

*All dimensions are nominal

Device	Package Name	Package Type	Pins	SPQ	L (mm)	W (mm)	T (µm)	B (mm)
5962-9321603Q2A	FK	LCCC	20	55	506.98	12.06	2030	NA
5962-9321603QHA	U	CFP	10	25	506.98	26.16	6220	NA
5962-9321604Q2A	FK	LCCC	20	55	506.98	12.06	2030	NA
5962-9321604QHA	U	CFP	10	25	506.98	26.16	6220	NA
5962-9321605Q2A	FK	LCCC	20	55	506.98	12.06	2030	NA
5962-9321606Q2A	FK	LCCC	20	55	506.98	12.06	2030	NA
TLE2141ACP	P	PDIP	8	50	506	13.97	11230	4.32
TLE2141ACP.A	P	PDIP	8	50	506	13.97	11230	4.32
TLE2141AIP	P	PDIP	8	50	506	13.97	11230	4.32
TLE2141AIP.A	P	PDIP	8	50	506	13.97	11230	4.32
TLE2141CP	P	PDIP	8	50	506	13.97	11230	4.32
TLE2141CP.A	P	PDIP	8	50	506	13.97	11230	4.32
TLE2141IP	P	PDIP	8	50	506	13.97	11230	4.32
TLE2141IP.A	P	PDIP	8	50	506	13.97	11230	4.32
TLE2141MD	D	SOIC	8	75	505.46	6.76	3810	4
TLE2141MD.A	D	SOIC	8	75	505.46	6.76	3810	4
TLE2142AMFKB	FK	LCCC	20	55	506.98	12.06	2030	NA
TLE2142AMFKB.A	FK	LCCC	20	55	506.98	12.06	2030	NA
TLE2142AMUB	U	CFP	10	25	506.98	26.16	6220	NA
TLE2142AMUB.A	U	CFP	10	25	506.98	26.16	6220	NA
TLE2142CP	P	PDIP	8	50	506	13.97	11230	4.32
TLE2142CP.A	P	PDIP	8	50	506	13.97	11230	4.32
TLE2142IP	P	PDIP	8	50	506	13.97	11230	4.32
TLE2142IP.A	P	PDIP	8	50	506	13.97	11230	4.32
TLE2142MFKB	FK	LCCC	20	55	506.98	12.06	2030	NA
TLE2142MFKB.A	FK	LCCC	20	55	506.98	12.06	2030	NA
TLE2142MUB	U	CFP	10	25	506.98	26.16	6220	NA
TLE2142MUB.A	U	CFP	10	25	506.98	26.16	6220	NA
TLE2144ACN	N	PDIP	14	25	506	13.97	11230	4.32

Device	Package Name	Package Type	Pins	SPQ	L (mm)	W (mm)	T (µm)	B (mm)
TLE2144ACN.A	N	PDIP	14	25	506	13.97	11230	4.32
TLE2144AIN	N	PDIP	14	25	506	13.97	11230	4.32
TLE2144AIN.A	N	PDIP	14	25	506	13.97	11230	4.32
TLE2144AMFKB	FK	LCCC	20	55	506.98	12.06	2030	NA
TLE2144AMFKB.A	FK	LCCC	20	55	506.98	12.06	2030	NA
TLE2144CDW	DW	SOIC	16	40	506.98	12.7	4826	6.6
TLE2144CDW.A	DW	SOIC	16	40	506.98	12.7	4826	6.6
TLE2144CN	N	PDIP	14	25	506	13.97	11230	4.32
TLE2144CN.A	N	PDIP	14	25	506	13.97	11230	4.32
TLE2144IDW	DW	SOIC	16	40	506.98	12.7	4826	6.6
TLE2144IDW.A	DW	SOIC	16	40	506.98	12.7	4826	6.6
TLE2144IN	N	PDIP	14	25	506	13.97	11230	4.32
TLE2144IN.A	N	PDIP	14	25	506	13.97	11230	4.32
TLE2144MDW	DW	SOIC	16	40	506.98	12.7	4826	6.6
TLE2144MDW.A	DW	SOIC	16	40	506.98	12.7	4826	6.6
TLE2144MDWG4	DW	SOIC	16	40	506.98	12.7	4826	6.6
TLE2144MDWG4.A	DW	SOIC	16	40	506.98	12.7	4826	6.6
TLE2144MFKB	FK	LCCC	20	55	506.98	12.06	2030	NA
TLE2144MFKB.A	FK	LCCC	20	55	506.98	12.06	2030	NA

GENERIC PACKAGE VIEW

DW 16

SOIC - 2.65 mm max height

7.5 x 10.3, 1.27 mm pitch

SMALL OUTLINE INTEGRATED CIRCUIT

This image is a representation of the package family, actual package may vary.
Refer to the product data sheet for package details.

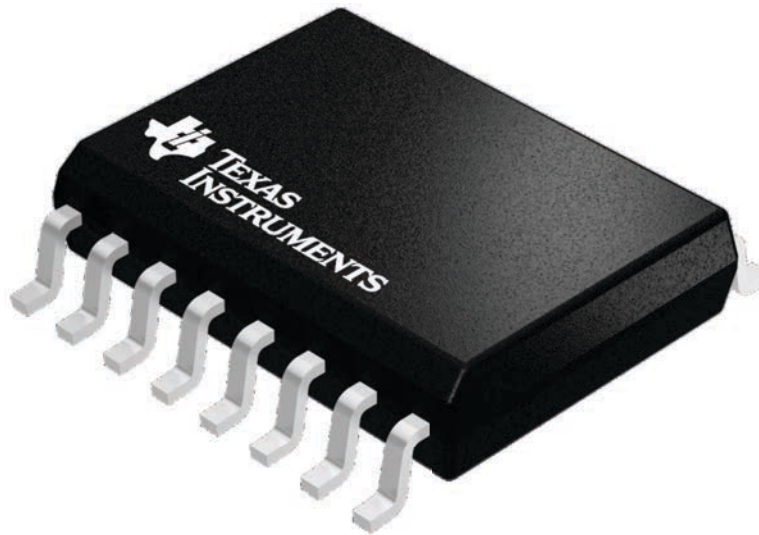

4224780/A

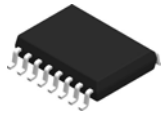

DW0016A

PACKAGE OUTLINE SOIC - 2.65 mm max height

SOIC

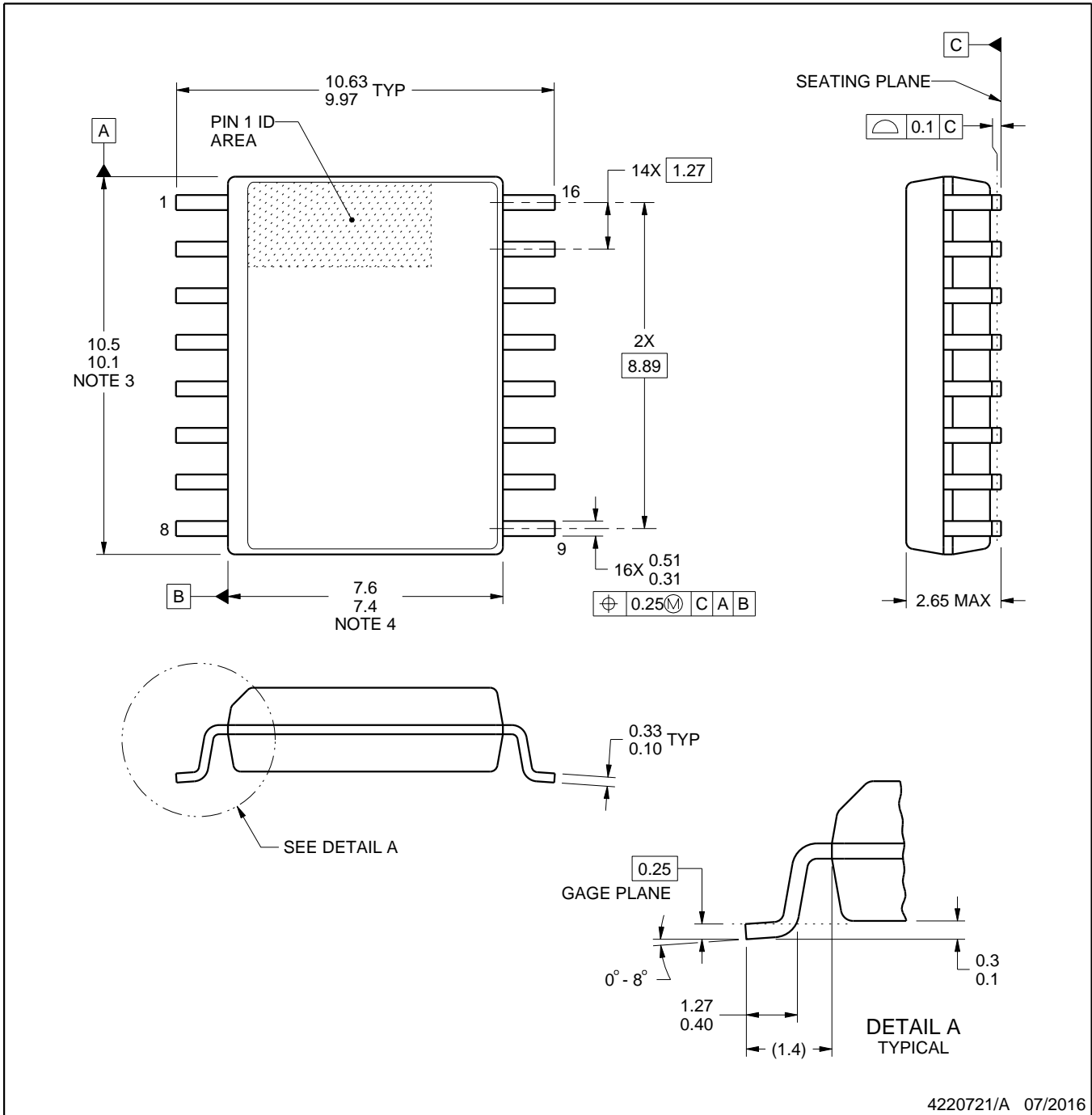

4220721/A 07/2016

NOTES:

1. All linear dimensions are in millimeters. Dimensions in parenthesis are for reference only. Dimensioning and tolerancing per ASME Y14.5M.
2. This drawing is subject to change without notice.
3. This dimension does not include mold flash, protrusions, or gate burrs. Mold flash, protrusions, or gate burrs shall not exceed 0.15 mm, per side.
4. This dimension does not include interlead flash. Interlead flash shall not exceed 0.25 mm, per side.
5. Reference JEDEC registration MS-013.

EXAMPLE BOARD LAYOUT

DW0016A

SOIC - 2.65 mm max height

SOIC

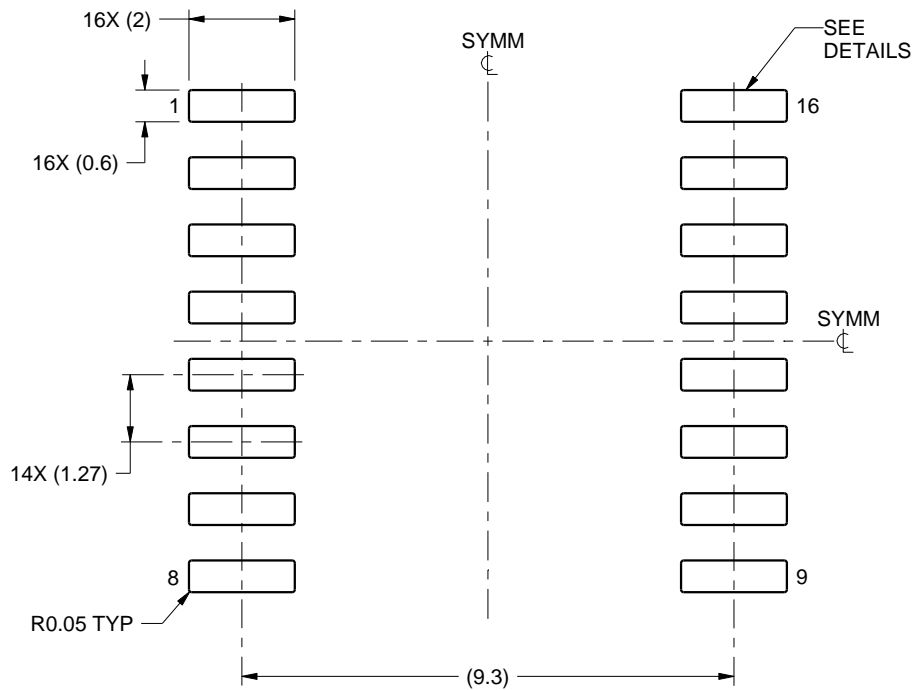

LAND PATTERN EXAMPLE
SCALE:7X

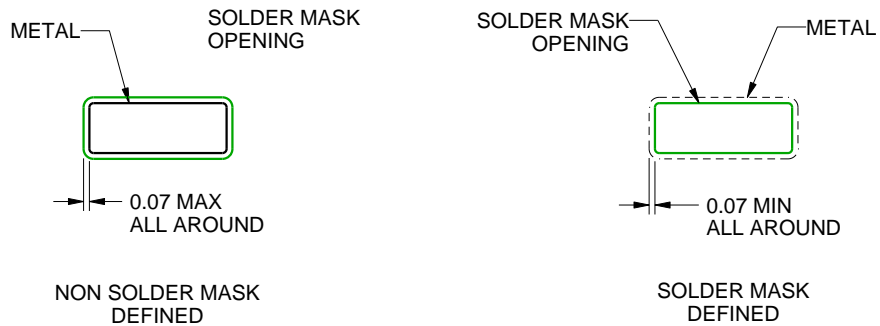

SOLDER MASK DETAILS

4220721/A 07/2016

NOTES: (continued)

6. Publication IPC-7351 may have alternate designs.

7. Solder mask tolerances between and around signal pads can vary based on board fabrication site.

EXAMPLE STENCIL DESIGN

DW0016A

SOIC - 2.65 mm max height

SOIC

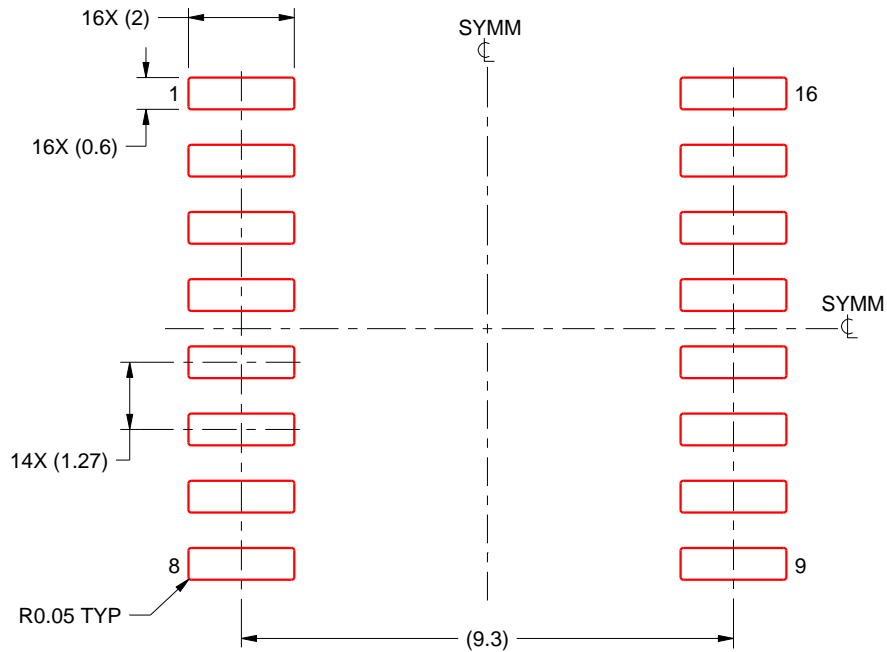

SOLDER PASTE EXAMPLE
BASED ON 0.125 mm THICK STENCIL
SCALE:7X

4220721/A 07/2016

NOTES: (continued)

8. Laser cutting apertures with trapezoidal walls and rounded corners may offer better paste release. IPC-7525 may have alternate design recommendations.
9. Board assembly site may have different recommendations for stencil design.

GENERIC PACKAGE VIEW

FK 20

LCCC - 2.03 mm max height

8.89 x 8.89, 1.27 mm pitch

LEADLESS CERAMIC CHIP CARRIER

This image is a representation of the package family, actual package may vary.
Refer to the product data sheet for package details.

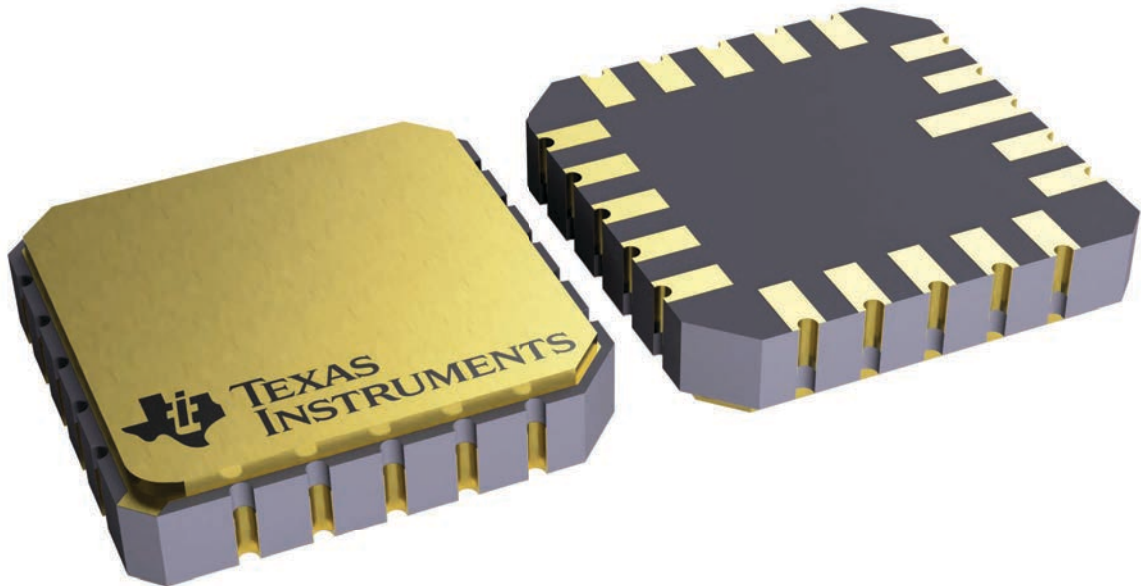

4229370VA\

J 14

GENERIC PACKAGE VIEW
CDIP - 5.08 mm max height
CERAMIC DUAL IN LINE PACKAGE

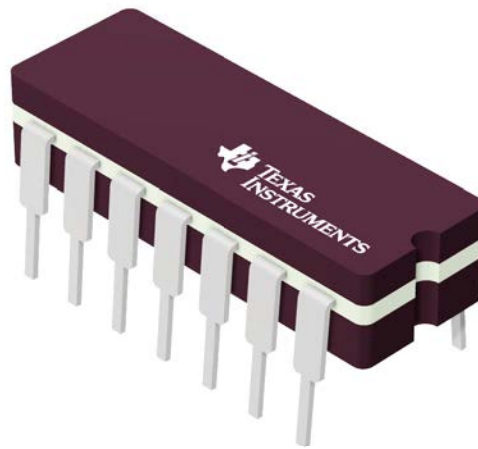

Images above are just a representation of the package family, actual package may vary.
Refer to the product data sheet for package details.

4040083-5/G



J0014A

PACKAGE OUTLINE

CDIP - 5.08 mm max height

CERAMIC DUAL IN LINE PACKAGE

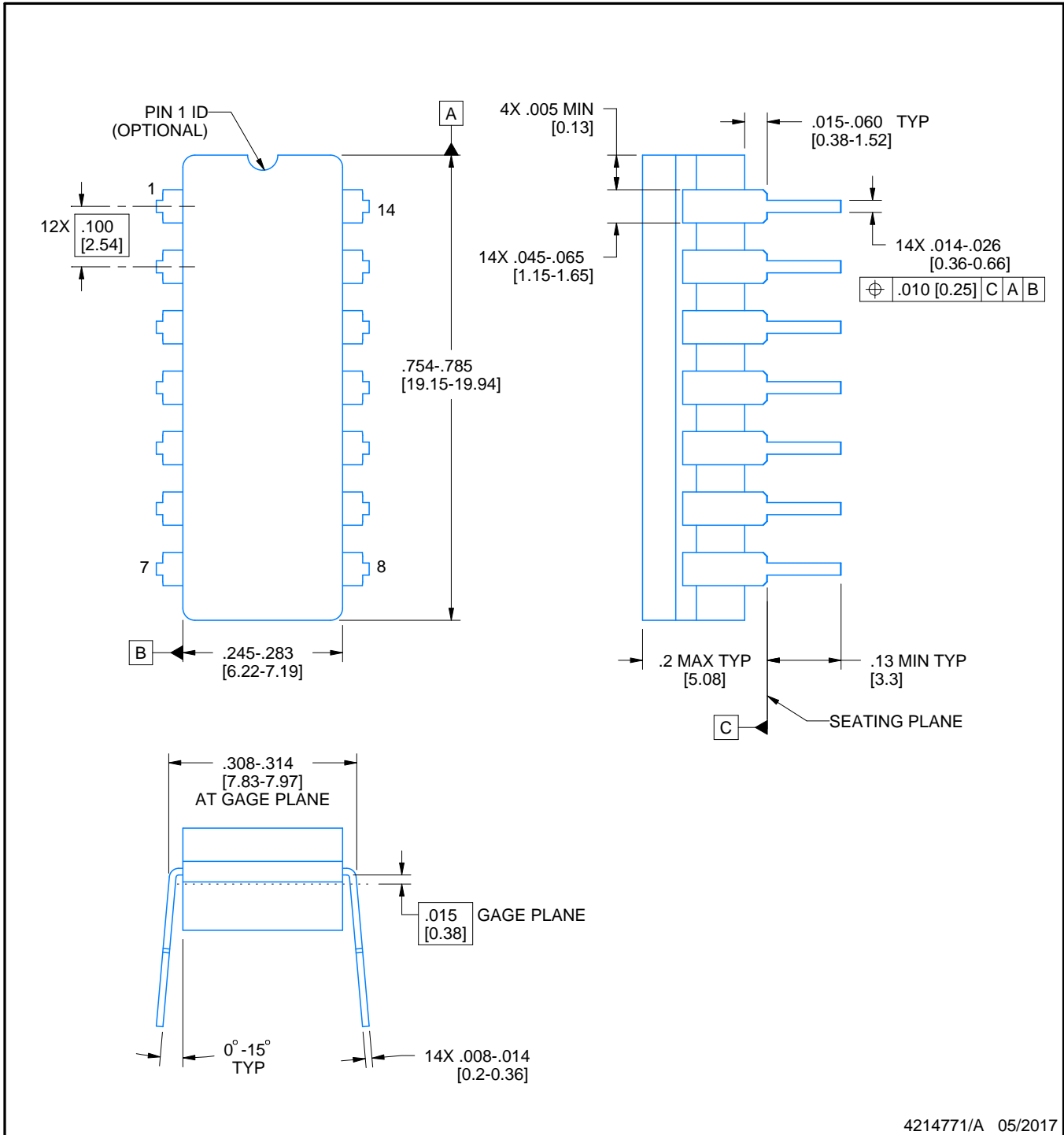

4214771/A 05/2017

NOTES:

1. All controlling linear dimensions are in inches. Dimensions in brackets are in millimeters. Any dimension in brackets or parenthesis are for reference only. Dimensioning and tolerancing per ASME Y14.5M.
2. This drawing is subject to change without notice.
3. This package is hermetically sealed with a ceramic lid using glass frit.
4. Index point is provided on cap for terminal identification only and on press ceramic glass frit seal only.
5. Falls within MIL-STD-1835 and GDIP1-T14.

EXAMPLE BOARD LAYOUT

J0014A

CDIP - 5.08 mm max height

CERAMIC DUAL IN LINE PACKAGE



LAND PATTERN EXAMPLE
NON-SOLDER MASK DEFINED
SCALE: 5X

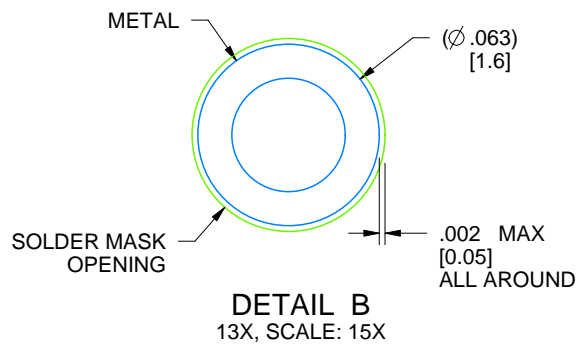

4214771/A 05/2017

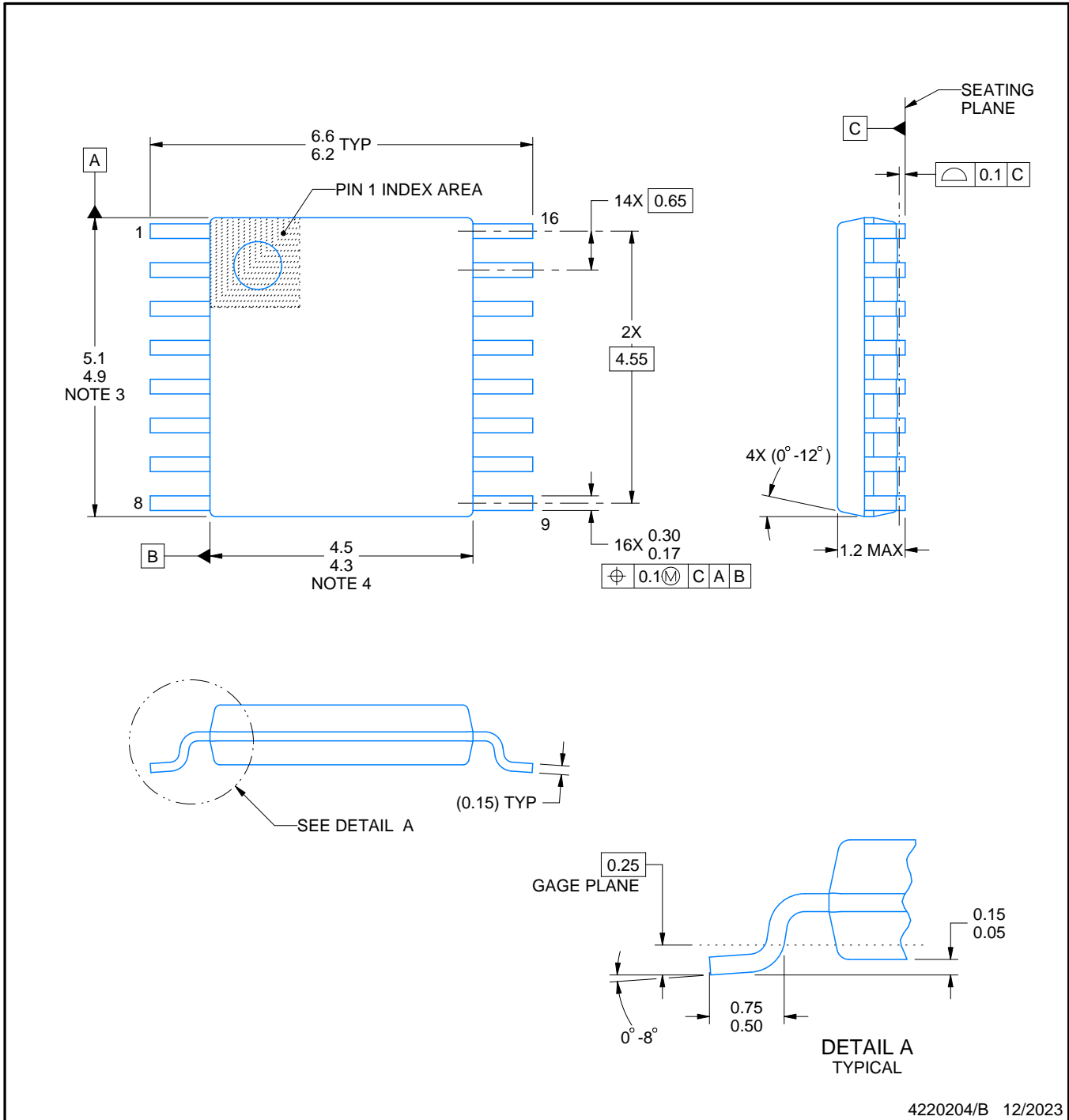
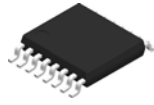

4220204/B 12/2023

NOTES:

1. All linear dimensions are in millimeters. Any dimensions in parenthesis are for reference only. Dimensioning and tolerancing per ASME Y14.5M.
2. This drawing is subject to change without notice.
3. This dimension does not include mold flash, protrusions, or gate burrs. Mold flash, protrusions, or gate burrs shall not exceed 0.15 mm per side.
4. This dimension does not include interlead flash. Interlead flash shall not exceed 0.25 mm per side.
5. Reference JEDEC registration MO-153.

EXAMPLE BOARD LAYOUT

PW0016A

TSSOP - 1.2 mm max height

SMALL OUTLINE PACKAGE

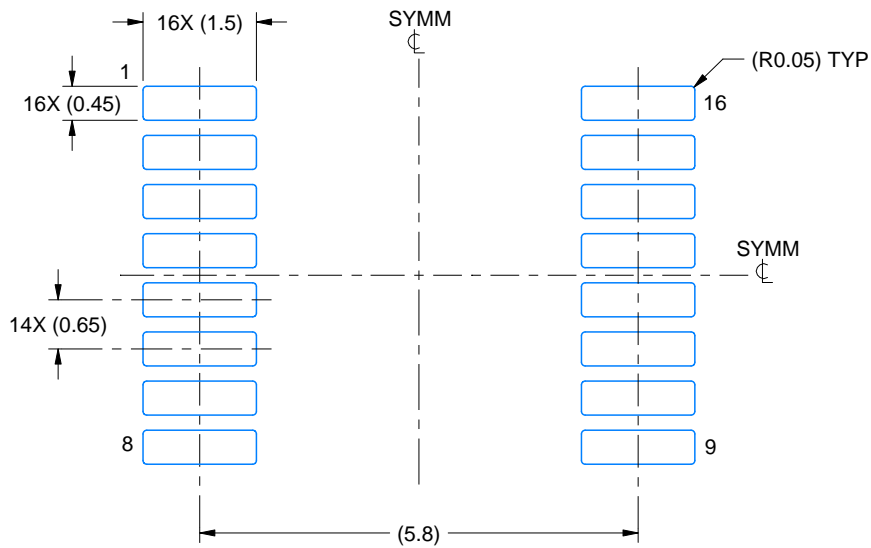

LAND PATTERN EXAMPLE
EXPOSED METAL SHOWN
SCALE: 10X

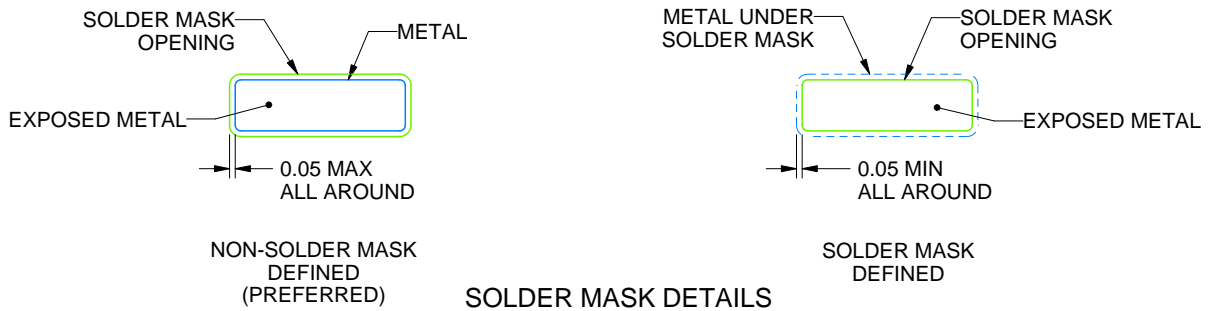

4220204/B 12/2023

NOTES: (continued)

6. Publication IPC-7351 may have alternate designs.
7. Solder mask tolerances between and around signal pads can vary based on board fabrication site.

EXAMPLE STENCIL DESIGN

PW0016A

TSSOP - 1.2 mm max height

SMALL OUTLINE PACKAGE

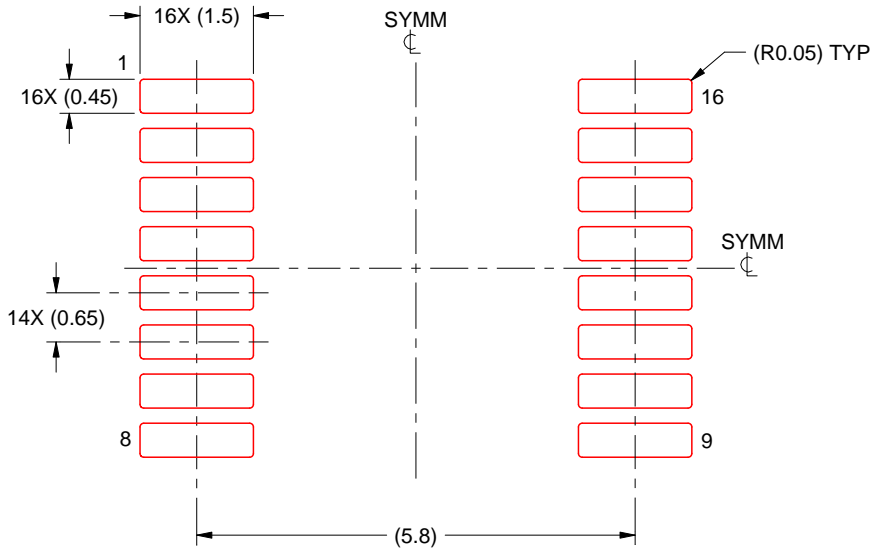

SOLDER PASTE EXAMPLE
BASED ON 0.125 mm THICK STENCIL
SCALE: 10X

4220204/B 12/2023

NOTES: (continued)

8. Laser cutting apertures with trapezoidal walls and rounded corners may offer better paste release. IPC-7525 may have alternate design recommendations.
9. Board assembly site may have different recommendations for stencil design.



D0008A

PACKAGE OUTLINE

SOIC - 1.75 mm max height

SMALL OUTLINE INTEGRATED CIRCUIT



4214825/C 02/2019

NOTES:

1. Linear dimensions are in inches [millimeters]. Dimensions in parenthesis are for reference only. Controlling dimensions are in inches. Dimensioning and tolerancing per ASME Y14.5M.
2. This drawing is subject to change without notice.
3. This dimension does not include mold flash, protrusions, or gate burrs. Mold flash, protrusions, or gate burrs shall not exceed .006 [0.15] per side.
4. This dimension does not include interlead flash.
5. Reference JEDEC registration MS-012, variation AA.

EXAMPLE BOARD LAYOUT

D0008A

SOIC - 1.75 mm max height

SMALL OUTLINE INTEGRATED CIRCUIT



LAND PATTERN EXAMPLE
EXPOSED METAL SHOWN
SCALE:8X



SOLDER MASK DETAILS

4214825/C 02/2019

NOTES: (continued)

6. Publication IPC-7351 may have alternate designs.

7. Solder mask tolerances between and around signal pads can vary based on board fabrication site.

EXAMPLE STENCIL DESIGN

D0008A

SOIC - 1.75 mm max height

SMALL OUTLINE INTEGRATED CIRCUIT



SOLDER PASTE EXAMPLE
BASED ON .005 INCH [0.125 MM] THICK STENCIL
SCALE:8X

4214825/C 02/2019

NOTES: (continued)

8. Laser cutting apertures with trapezoidal walls and rounded corners may offer better paste release. IPC-7525 may have alternate design recommendations.
9. Board assembly site may have different recommendations for stencil design.

P (R-PDIP-T8)

PLASTIC DUAL-IN-LINE PACKAGE



- NOTES:
- A. All linear dimensions are in inches (millimeters).
 - B. This drawing is subject to change without notice.
 - C. Falls within JEDEC MS-001 variation BA.

N (R-PDIP-T**)

PLASTIC DUAL-IN-LINE PACKAGE

16 PINS SHOWN



- NOTES:
- A. All linear dimensions are in inches (millimeters).
 - B. This drawing is subject to change without notice.
 - Falls within JEDEC MS-001, except 18 and 20 pin minimum body length (Dim A).
 - The 20 pin end lead shoulder width is a vendor option, either half or full width.

PACKAGE OUTLINE

JG0008A

CDIP - 5.08 mm max height

CERAMIC DUAL IN-LINE PACKAGE

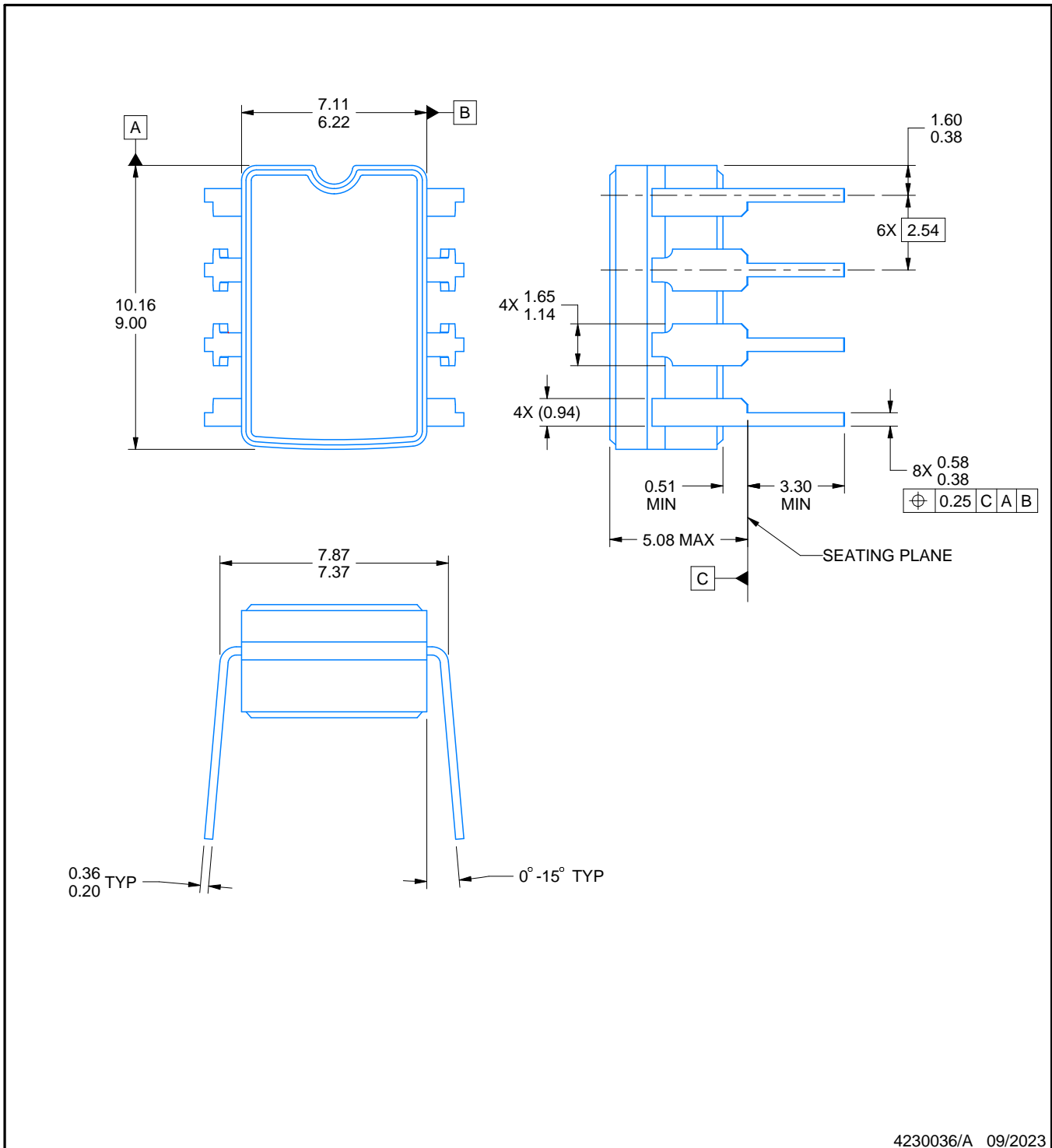

4230036/A 09/2023

NOTES:

1. All linear dimensions are in millimeters. Any dimensions in parenthesis are for reference only. Dimensioning and tolerancing per ASME Y14.5M.
2. This drawing is subject to change without notice.
3. This package can be hermetically sealed with a ceramic lid using glass frit.
4. Index point is provided on cap for terminal identification.
5. Falls within MIL STD 1835 GDIP1-T8

重要通知和免责声明

TI“按原样”提供技术和可靠性数据（包括数据表）、设计资源（包括参考设计）、应用或其他设计建议、网络工具、安全信息和其他资源，不保证没有瑕疵且不做任何明示或暗示的担保，包括但不限于对适销性、与某特定用途的适用性或不侵犯任何第三方知识产权的暗示担保。

这些资源可供使用 TI 产品进行设计的熟练开发人员使用。您将自行承担以下全部责任：(1) 针对您的应用选择合适的 TI 产品，(2) 设计、验证并测试您的应用，(3) 确保您的应用满足相应标准以及任何其他安全、安保法规或其他要求。

这些资源如有变更，恕不另行通知。TI 授权您仅可将这些资源用于研发本资源所述的 TI 产品的相关应用。严禁以其他方式对这些资源进行复制或展示。您无权使用任何其他 TI 知识产权或任何第三方知识产权。对于因您对这些资源的使用而对 TI 及其代表造成的任何索赔、损害、成本、损失和债务，您将全额赔偿，TI 对此概不负责。

TI 提供的产品受 [TI 销售条款](#)、[TI 通用质量指南](#) 或 [ti.com](#) 上其他适用条款或 TI 产品随附的其他适用条款的约束。TI 提供这些资源并不会扩展或以其他方式更改 TI 针对 TI 产品发布的适用的担保或担保免责声明。除非德州仪器 (TI) 明确将某产品指定为定制产品或客户特定产品，否则其产品均为按确定价格收入目录的标准通用器件。

TI 反对并拒绝您可能提出的任何其他或不同的条款。

版权所有 © 2026，德州仪器 (TI) 公司

最后更新日期：2025 年 10 月