

## TPS22917x 1V 至 5.5V、2A、80mΩ 超低泄漏负载开关

### 1 特性

- 输入电压范围 ( $V_{IN}$ ) : 1V 至 5.5V
- 最大持续电流 ( $I_{MAX}$ ) : 2A
- 导通电阻 ( $R_{ON}$ )
  - 5V  $V_{IN} = 80m\Omega$  (典型值)
  - 1.8V  $V_{IN} = 120m\Omega$  (典型值)
  - 1V  $V_{IN} = 220m\Omega$  (典型值)
- 超低功耗 :
  - 导通状态 ( $I_Q$ ) : 0.5 $\mu A$  (典型值)
  - 关闭状态 ( $I_{SD}$ ) : 10nA (典型值)
- ON 引脚智能下拉电阻 ( $R_{PD}$ ) :
  - $ON \geq V_{IH}$  ( $I_{ON}$ ) : 10nA (最大值)
  - $ON \leq V_{IL}$  ( $R_{PD}$ ) : 750k $\Omega$  (典型值)
- 可调节开通时序可限制浪涌电流 ( $t_{ON}$ ) :
  - 在 72mV/ $\mu s$  ( $C_T =$  开路) 下, 5V  $t_{ON} = 100 \mu s$
  - 5V  $t_{ON} = 4000 \mu s$ , 2.3mV/ $\mu s$  ( $C_T = 1000pF$ )
- 可调节输出放电和下降时间 :
  - 可选 QOD 电阻  $\geq 150 \Omega$  (内部)
- 常开的真反向电流阻断 (RCB) :
  - 激活电流 ( $I_{RCB}$ ) : -500mA (典型值)
  - 反向泄漏电流 ( $I_{IN,RCB}$ ) : -1 $\mu A$  (最大值)

### 2 应用

- 工业系统
- 机顶盒
- 血糖仪
- 电子销售终端

### 3 说明

TPS22917x 器件是一款小型单通道负载开关, 采用低泄漏电流 P 沟道 MOSFET 实现超小的功率损耗。高级栅极控制设计支持低至 1V 的工作电压, 且增加超小的导通电阻和功率损耗。

可以使用外部组件独立调节上升和下降时间, 以实现系统级优化。可通过调节计时电容器 ( $C_T$ ) 和开通时间来管理浪涌电流, 且不会增加不必要的系统延迟。输出放电电阻 (QOD) 用来调节输出下降时间。将 QOD 引脚直接连接到输出端可获得最快的下降时间, 或使其保持开路以获得最慢的下降时间。

开关导通状态由数字输入控制, 此输入可与低压控制信号直接连接。TPS22917 采用高电平有效使能逻辑, 而 TPS22917L 低电平有效使能逻辑。首次加电时, 此器件使用智能下拉电阻来保持 ON 引脚不悬空, 直到系统时序控制完成。ON 引脚故意驱动为高电平 ( $\geq V_{IH}$ ) 后, 便会断开智能下拉电阻 ( $R_{PD}$ ), 从而防止不必要的功率损耗。

TPS22917x 器件采用支持目测检查焊点的带引线 SOT-23 封装 (DBV)。此器件的工作温度范围为 -40 $^{\circ}C$  至 125 $^{\circ}C$ 。

#### 器件信息<sup>(1)</sup>

器件型号	封装	封装尺寸 (标称值)
TPS22917x	SOT-23 (6)	2.90mm × 1.60mm

(1) 如需了解所有可用封装, 请参阅数据表末尾的可订购产品附录。

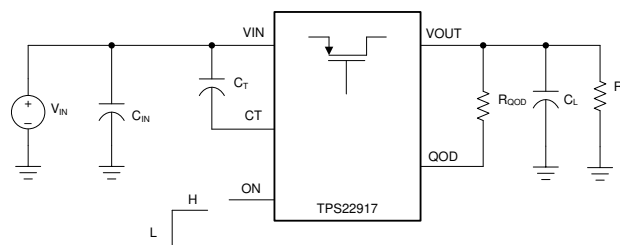

Copyright © 2018, Texas Instruments Incorporated

简化版原理图



## Table of Contents

<b>1 特性</b> .....	1	9.3 Feature Description.....	15
<b>2 应用</b> .....	1	9.4 Full-Time Reverse Current Blocking.....	16
<b>3 说明</b> .....	1	9.5 Device Functional Modes.....	16
<b>4 Revision History</b> .....	2	<b>10 Application and Implementation</b> .....	17
<b>5 Device Comparison Table</b> .....	3	10.1 Application Information.....	17
<b>6 Pin Configuration and Functions</b> .....	4	10.2 Typical Application.....	17
<b>7 Specifications</b> .....	5	<b>11 Power Supply Recommendations</b> .....	19
7.1 Absolute Maximum Ratings.....	5	<b>12 Layout</b> .....	20
7.2 ESD Ratings.....	5	12.1 Layout Guidelines.....	20
7.3 Recommended Operating Conditions.....	5	12.2 Layout Example.....	20
7.4 Thermal Information.....	5	12.3 Thermal Considerations.....	20
7.5 Electrical Characteristics.....	6	<b>13 Device and Documentation Support</b> .....	21
7.6 Switching Characteristics.....	7	13.1 接收文档更新通知.....	21
7.7 Typical Characteristics.....	8	13.2 支持资源.....	21
<b>8 Parameter Measurement Information</b> .....	13	13.3 Trademarks.....	21
8.1 Test Circuit and Timing Waveforms Diagrams.....	13	13.4 Electrostatic Discharge Caution.....	21
<b>9 Detailed Description</b> .....	14	13.5 术语表.....	21
9.1 Overview.....	14	<b>14 Mechanical, Packaging, and Orderable Information</b> .....	21
9.2 Functional Block Diagram.....	14		

## 4 Revision History

注：以前版本的页码可能与当前版本的页码不同

<b>Changes from Revision A (February 2018) to Revision B (December 2021)</b>	<b>Page</b>
• 更新了整个文档中的表格、图和交叉参考的编号格式.....	1
• 向数据表添加了 TPS22917L 可订购信息.....	1

---

<b>Changes from Revision * (September 2017) to Revision A (February 2018)</b>	<b>Page</b>
• 将产品状态从“预告信息”更改为“量产数据”.....	1

## 5 Device Comparison Table

Device	ON Pin Logic
TPS22917	Active High
TPS22917L	Active Low

## 6 Pin Configuration and Functions



图 6-1. DBV Package 6-Pin SOT-23 Top View

表 6-1. Pin Functions

PIN		I/O	DESCRIPTION
NO.	NAME		
1	VIN	I	Switch input
2	GND	—	Device ground
3	ON	I	Active high switch control input. Do not leave floating.
4	CT	O	Switch slew rate control. Connect capacitor from this pin to VIN to increase output slew rate and turn-on time. Can be left floating for fastest timing.
5	QOD	O	Quick Output Discharge pin. This functionality can be enabled in one of three ways. <ul style="list-style-type: none"> <li>Placing an external resistor between VOUT and QOD</li> <li>Tying QOD directly to VOUT and using the internal resistor value (<math>R_{PD}</math>)</li> <li>Disabling QOD by leaving pin floating</li> </ul> See the <i>Fall Time (<math>t_{FALL}</math>) and Quick Output Discharge (QOD)</i> section for more information.
6	VOUT	O	Switch output

## 7 Specifications

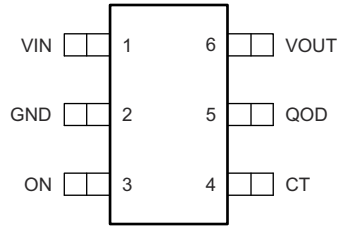
### 7.1 Absolute Maximum Ratings

Over operating free-air temperature range (unless otherwise noted)<sup>(1)</sup>

		MIN	MAX	UNIT
V <sub>IN</sub>	Input voltage	- 0.3	6	V
V <sub>OUT</sub>	Output voltage	- 0.3	6	V
V <sub>ON</sub>	Enable voltage	- 0.3	6	V
V <sub>QOD</sub>	QOD pin voltage	- 0.3	6	V
I <sub>MAX</sub>	Maximum continuous switch current		2	A
I <sub>PLS</sub>	Maximum pulsed switch current, pulse < 300- $\mu$ s, 2% duty cycle		2.5	A
T <sub>J,MAX</sub>	Maximum junction temperature		125	°C
T <sub>STG</sub>	Storage temperature	- 65	150	°C
T <sub>LEAD</sub>	Maximum Lead temperature (10-s soldering time)		300	°C

- (1) Stresses beyond those listed under *Absolute Maximum Ratings* may cause permanent damage to the device. These are stress ratings only, which do not imply functional operation of the device at these or any other conditions beyond those indicated under *Recommended Operating Conditions*. Exposure to absolute-maximum-rated conditions for extended periods may affect device reliability.

### 7.2 ESD Ratings

		VALUE	UNIT
V <sub>(ESD)</sub>	Electrostatic discharge	Human-body model (HBM), per ANSI/ESDA/JEDEC JS-001 <sup>(1)</sup>	V
		Charged-device model (CDM), per JEDEC specification JESD22-C101 <sup>(2)</sup>	

- (1) JEDEC document JEP155 states that 500-V HBM allows safe manufacturing with a standard ESD control process. Manufacturing with less than 500-V HBM is possible with the necessary precautions. Pins listed as  $\pm 2000$  V may actually have higher performance.
- (2) JEDEC document JEP157 states that 250-V CDM allows safe manufacturing with a standard ESD control process. Manufacturing with less than 250-V CDM is possible with the necessary precautions. Pins listed as  $\pm 500$  V may actually have higher performance.

### 7.3 Recommended Operating Conditions

Over operating free-air temperature range (unless otherwise noted)

		MIN	MAX	UNIT
V <sub>IN</sub>	Input voltage	1	5.5	V
V <sub>OUT</sub>	Output voltage	0	5.5	V
V <sub>IH</sub>	High-level input voltage, ON	1	5.5	V
V <sub>IL</sub>	Low-level input voltage, ON	0	0.35	V
V <sub>QOD</sub>	QOD Pin Voltage	0	5.5	V
V <sub>CT</sub>	Timing Capacitor Voltage Rating	7		V

### 7.4 Thermal Information

Thermal Parameters <sup>(1)</sup>	TPS22917	UNIT
	DBV (SOT-23)	
	6 PINS	
$\theta_{JA}$ Junction-to-ambient thermal resistance	183	°C/W
$\theta_{JCTop}$ Junction-to-case (top) thermal resistance	152	°C/W
$\theta_{JB}$ Junction-to-board thermal resistance	34	°C/W
$\psi_{JT}$ Junction-to-top characterization parameter	37	°C/W
$\psi_{JB}$ Junction-to-board characterization parameter	33	°C/W

- (1) For more information about traditional and new thermal metrics, see the [Semiconductor and IC Package Thermal Metrics](#) application report.

## 7.5 Electrical Characteristics

Unless otherwise noted, the specification in the following table applies for all variants over the entire recommended power supply voltage range of 1 V to 5.5 V. Typical Values are at 25°C.

PARAMETER		TEST CONDITIONS	T <sub>J</sub>	MIN	TYP	MAX	UNIT	
<b>INPUT SUPPLY(V<sub>IN</sub>)</b>								
I <sub>Q,VIN</sub>	V <sub>IN</sub> Quiescent current	Enabled, V <sub>OUT</sub> = Open	-40°C to +85°C	0.5	1.0		μA	
			-40°C to +125°C			1.2	μA	
I <sub>SD,VIN</sub>	V <sub>IN</sub> Shutdown current	Disabled, V <sub>OUT</sub> = GND (TPS22917)	-40°C to +85°C	10	100		nA	
			-40°C to +105°C			250	nA	
		Disabled, V <sub>OUT</sub> = GND (TPS22917L)	-40°C to +85°C	175	300		nA	
			-40°C to +105°C			400	nA	
<b>ON-RESISTANCE(R<sub>ON</sub>)</b>								
R <sub>ON</sub>	ON-Resistance	I <sub>OUT</sub> = 200 mA	V <sub>IN</sub> = 5 V	25°C	80	100	mΩ	
				-40°C to +85°C				120
				-40°C to +105°C				130
				-40°C to +125°C				140
			V <sub>IN</sub> = 3.6 V	25°C	90	110		
				-40°C to +85°C				140
				-40°C to +105°C				150
				-40°C to +125°C				160
			V <sub>IN</sub> = 1.8 V	25°C	120	150		
				-40°C to +85°C				175
				-40°C to +105°C				185
				-40°C to +125°C				200
			V <sub>IN</sub> = 1.2 V	25°C	170	220		
				-40°C to +85°C				265
				-40°C to +105°C				280
				-40°C to +125°C				300
			V <sub>IN</sub> = 1.0 V	25°C	220	300		
				-40°C to +85°C				350
				-40°C to +105°C				370
				-40°C to +125°C				390
<b>ENABLE PIN(ON)</b>								
I <sub>ON</sub>	ON Pin leakage	Enabled (TPS22917)	-40°C to +125°C	-10		10	nA	
		Enabled (TPS22917L)	-40°C to +125°C	-20		20	nA	
R <sub>PD</sub>	Smart Pull Down Resistance	V <sub>ON</sub> ≤ V <sub>IL</sub>	-40°C to +105°C		750		kΩ	
<b>REVERSE CURRENT BLOCKING(RCB)</b>								
I <sub>RCB</sub>	RCB Activation Current	Enabled, V <sub>OUT</sub> > V <sub>IN</sub>	-40°C to +125°C	-0.5	-1		A	
t <sub>RCB</sub>	RCB Activation time	Enabled, V <sub>OUT</sub> > V <sub>IN</sub> + 200mV	-40°C to +125°C		10		μs	
V <sub>RCB</sub>	RCB Release Voltage	Enabled, V <sub>OUT</sub> > V <sub>IN</sub>	-40°C to +125°C		25		mV	
I <sub>IN,RCB</sub>	V <sub>IN</sub> Reverse Leakage Current	0 V ≤ V <sub>IN</sub> + V <sub>RCB</sub> ≤ V <sub>OUT</sub> ≤ 5.5 V	-40°C to +105°C	-1			μA	
<b>QUICK OUTPUT DISCHARGE(QOD)</b>								
QOD	Output discharge resistance	Disabled	-40°C to +105°C		150		Ω	

## 7.6 Switching Characteristics

Unless otherwise noted, the typical characteristics in the following table applies over the entire recommended power supply voltage range of 1 V to 5.5 V at 25°C with a load of  $C_L = 1 \mu\text{F}$ ,  $R_L = 10 \Omega$

PARAMETER		TEST CONDITIONS		MIN	TYP	MAX	UNIT		
$t_{\text{ON}}$	Turn ON Time	$V_{\text{IN}} = 5.0 \text{ V}$	$C_T = \text{Open}$		100		$\mu\text{s}$		
			$C_T \geq 100 \text{ pF}$		4		$\mu\text{s/pF}$		
		$V_{\text{IN}} = 3.6 \text{ V}$	$C_T = \text{Open}$		120		$\mu\text{s}$		
			$C_T \geq 100 \text{ pF}$		3.8		$\mu\text{s/pF}$		
		$V_{\text{IN}} = 1.8 \text{ V}$	$C_T = \text{Open}$		200		$\mu\text{s}$		
			$C_T \geq 100 \text{ pF}$		3.6		$\mu\text{s/pF}$		
		$V_{\text{IN}} = 1.2 \text{ V}$	$C_T = \text{Open}$		300		$\mu\text{s}$		
			$C_T \geq 200 \text{ pF}$		3.4		$\mu\text{s/pF}$		
		$V_{\text{IN}} = 1.0 \text{ V}$	$C_T = \text{Open}$		400		$\mu\text{s}$		
			$C_T \geq 400 \text{ pF}$		3		$\mu\text{s/pF}$		
		$t_{\text{R}}$	Output Rise Time	$V_{\text{IN}} = 5.0 \text{ V}$	$C_T = \text{Open}$		55		$\mu\text{s}$
					$C_T \geq 100 \text{ pF}$		1.8		$\mu\text{s/pF}$
$V_{\text{IN}} = 3.6 \text{ V}$	$C_T = \text{Open}$				65		$\mu\text{s}$		
	$C_T \geq 100 \text{ pF}$				1.6		$\mu\text{s/pF}$		
$V_{\text{IN}} = 1.8 \text{ V}$	$C_T = \text{Open}$				100		$\mu\text{s}$		
	$C_T \geq 100 \text{ pF}$				1.2		$\mu\text{s/pF}$		
$V_{\text{IN}} = 1.2 \text{ V}$	$C_T = \text{Open}$				150		$\mu\text{s}$		
	$C_T \geq 200 \text{ pF}$				0.95		$\mu\text{s/pF}$		
$V_{\text{IN}} = 1.0 \text{ V}$	$C_T = \text{Open}$				200		$\mu\text{s}$		
	$C_T \geq 400 \text{ pF}$				0.6		$\mu\text{s/pF}$		
$\text{SR}_{\text{ON}}$	Turn ON Slew Rate <sup>(1)</sup>			$V_{\text{IN}} = 5.0 \text{ V}$	$C_T = \text{Open}$		72		$\text{mV}/\mu\text{s}$
					$C_T \geq 100 \text{ pF}$		2300		$(\text{mV}/\mu\text{s}) \cdot \text{pF}$
		$V_{\text{IN}} = 3.6 \text{ V}$	$C_T = \text{Open}$		44		$\text{mV}/\mu\text{s}$		
			$C_T \geq 100 \text{ pF}$		1900		$(\text{mV}/\mu\text{s}) \cdot \text{pF}$		
		$V_{\text{IN}} = 1.8 \text{ V}$	$C_T = \text{Open}$		14		$\text{mV}/\mu\text{s}$		
			$C_T \geq 100 \text{ pF}$		1100		$(\text{mV}/\mu\text{s}) \cdot \text{pF}$		
		$V_{\text{IN}} = 1.2 \text{ V}$	$C_T = \text{Open}$		6.2		$\text{mV}/\mu\text{s}$		
			$C_T \geq 200 \text{ pF}$		1000		$(\text{mV}/\mu\text{s}) \cdot \text{pF}$		
		$V_{\text{IN}} = 1.0 \text{ V}$	$C_T = \text{Open}$		3.9		$\text{mV}/\mu\text{s}$		
			$C_T \geq 400 \text{ pF}$		1100		$(\text{mV}/\mu\text{s}) \cdot \text{pF}$		
		$t_{\text{OFF}}$	Turn OFF Time				10		$\mu\text{s}$
		$t_{\text{FALL}}$	Output Fall Time <sup>(2)</sup>	$R_L = 10 \Omega$	$C_L = 1\mu\text{F}, R_{\text{QOD}} = \text{Short}$		22		$\mu\text{s}$
$C_L = 10\mu\text{F}, R_{\text{QOD}} = \text{Short}$					3.8		ms		
$R_L = \text{Open}$	$C_L = 10\mu\text{F}, R_{\text{QOD}} = 100 \Omega$				5.9		ms		
	$C_L = 220\mu\text{F}, R_{\text{QOD}} = \text{Short}$				72		ms		

(1)  $\text{SR}_{\text{ON}}$  is the fastest Slew Rate during the turn on time ( $t_{\text{ON}}$ )

(2) Output may not discharge completely if QOD is not connected to VOUT.

## 7.7 Typical Characteristics

### 7.7.1 Typical Electrical Characteristics

The typical characteristics curves in this section apply at 25°C unless otherwise noted.



图 7-1. Shutdown Current ( $I_{SD}$ )



图 7-2. Quiescent Current ( $I_Q$ )

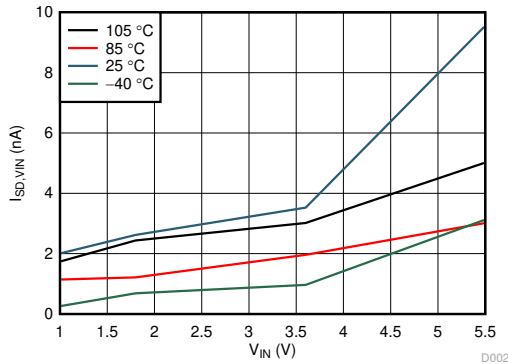

图 7-3. ON-Resistance ( $R_{ON}$ )

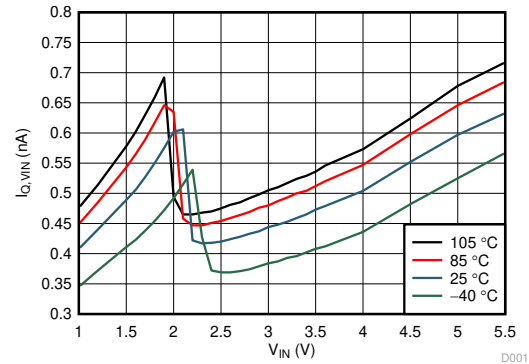

图 7-4. Quick Output Discharge (QOD)

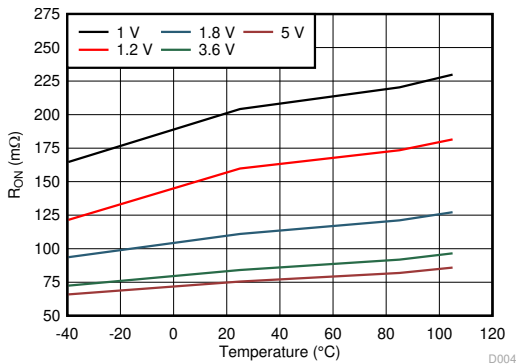

图 7-5. ON Pin Threshold

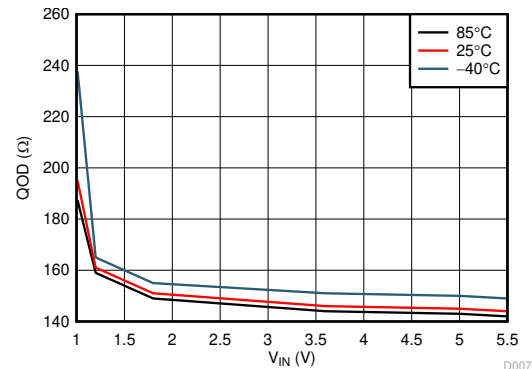

图 7-6. ON Pin Smart Pulldown ( $R_{PD}$ )

### 7.7.2 Typical Switching Characteristics

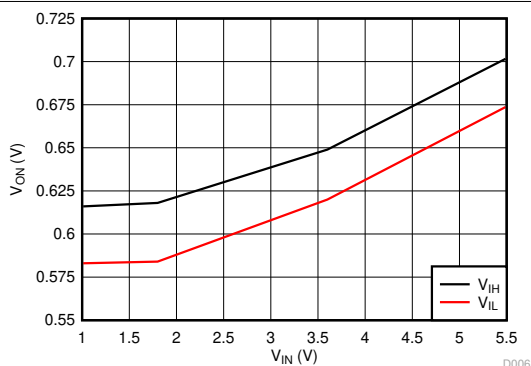
The typical data in this section apply at 25°C with a load of  $C_L = 1 \mu F$ ,  $R_L = 10 \Omega$ , and QOD shorted to VOUT unless otherwise noted.

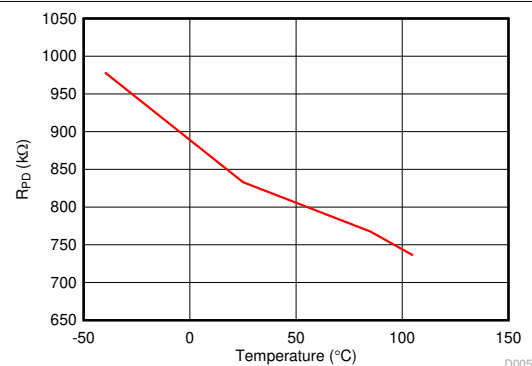

图 7-7. Turn-On Time (CT = Open)



图 7-8. Turn-On at 5 V (CT = Open)

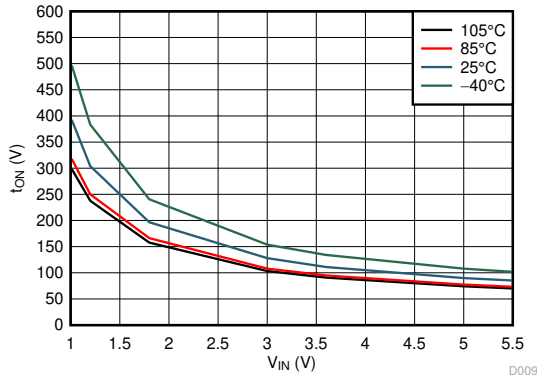

图 7-9. Rise Time (CT = Open)

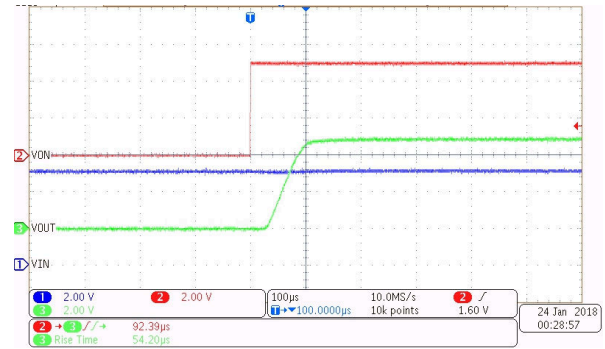

图 7-10. Turn-On at 3.6 V (CT = Open)

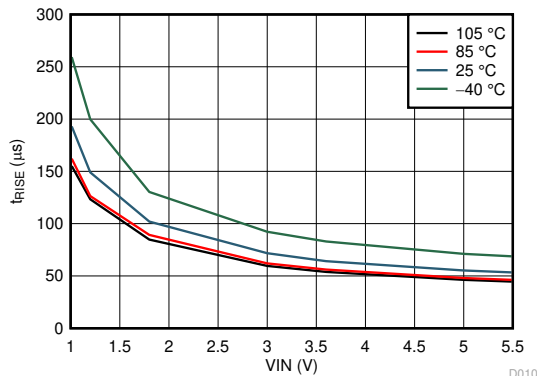

图 7-11. Slew Rate (CT = Open)

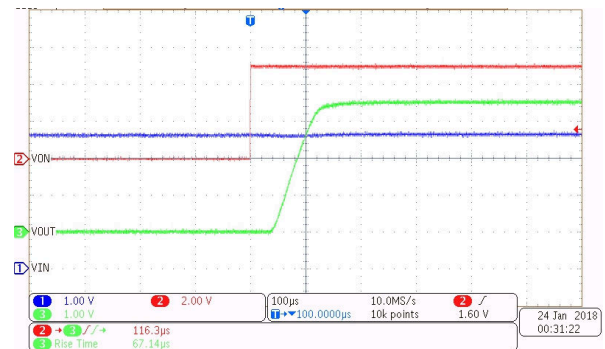

图 7-12. Turn On at 1 V (CT = Open)

7.7.2 Typical Switching Characteristics (continued)

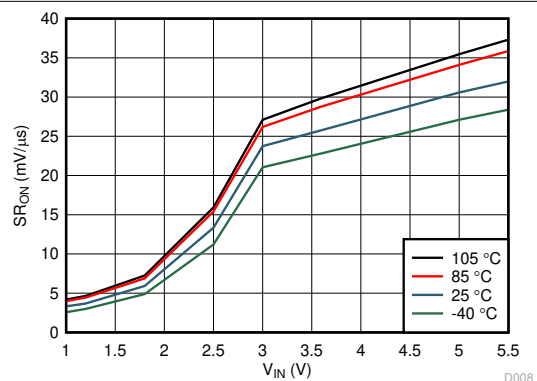

图 7-13. Turn On Time (CT = 1000 pF)

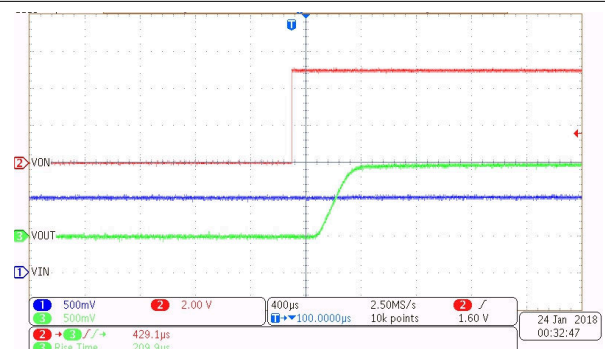

图 7-14. Turn-On at 5 V (CT = 1000 pF)

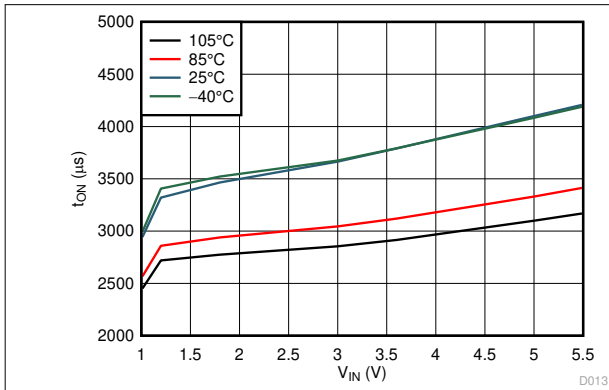

图 7-15. Rise Time (CT = 1000 pF)



图 7-16. Turn-On at 3.6 V (CT = 1000 pF)

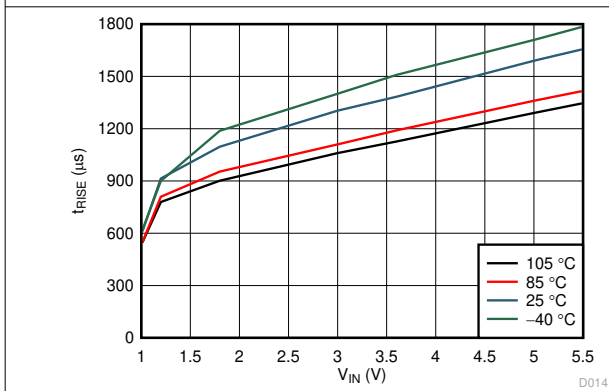

图 7-17. Slow Slew Rate (CT = 1000 pF)

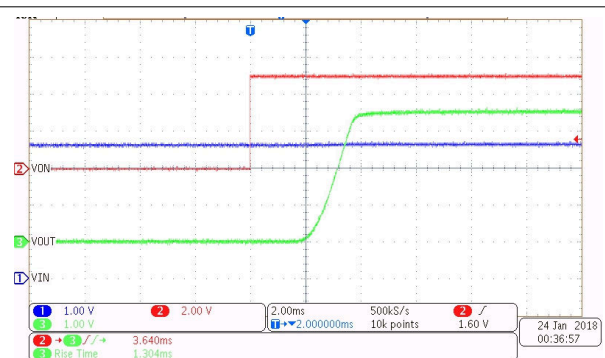

图 7-18. Turn-On at 1 V (CT = 1000 pF)

### 7.7.2 Typical Switching Characteristics (continued)

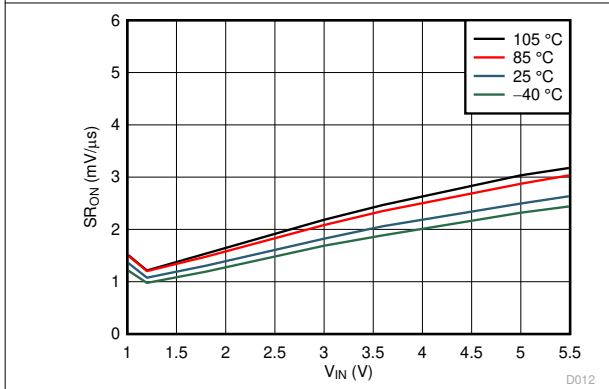

$R_L = 10 \Omega$

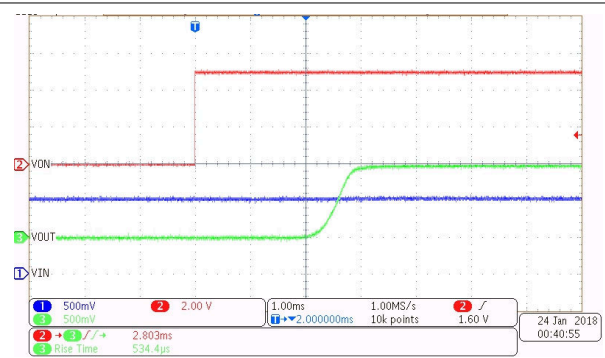
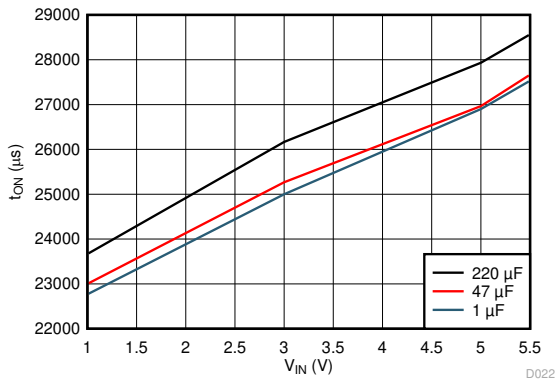
图 7-19. Turn-On vs Load Capacitance (CT = 10000 pF)

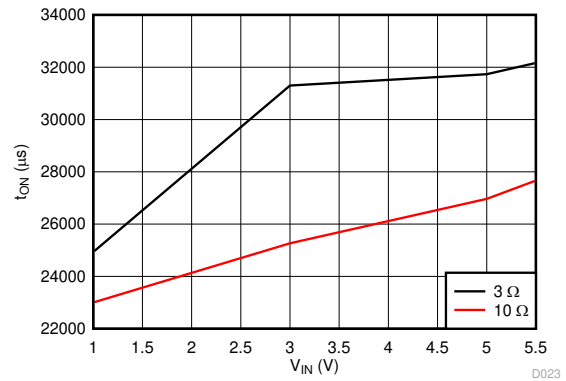

$C_L = 47 \mu\text{F}$

图 7-20. Turn-On vs Load Resistance (CT = 10000 pF)

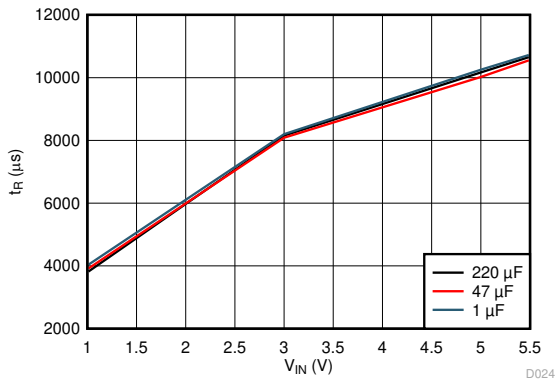

$R_L = 10 \Omega$

图 7-21. Rise Time vs Load Capacitance (CT = 10000 pF)

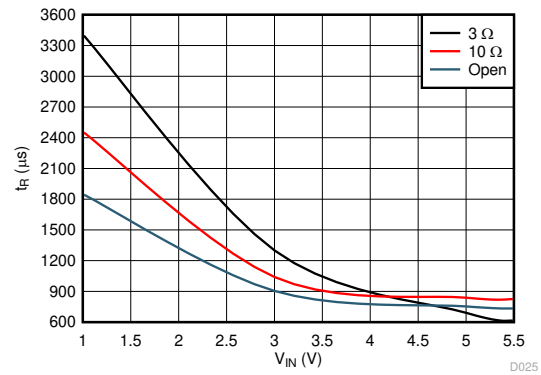

$C_L = 47 \mu\text{F}$

图 7-22. Rise Time vs Load Resistance (CT = 10000 pF)

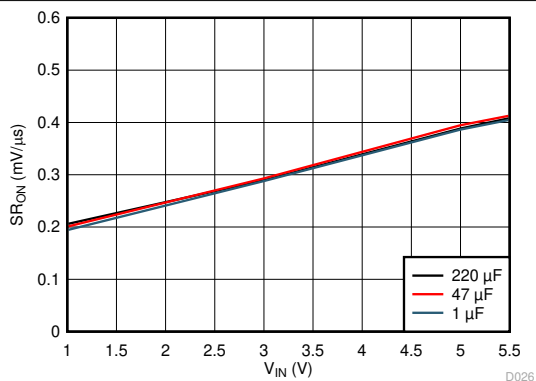

$R_L = 10 \Omega$

图 7-23. Slew Rate vs Load Capacitance (CT = 10000 pF)

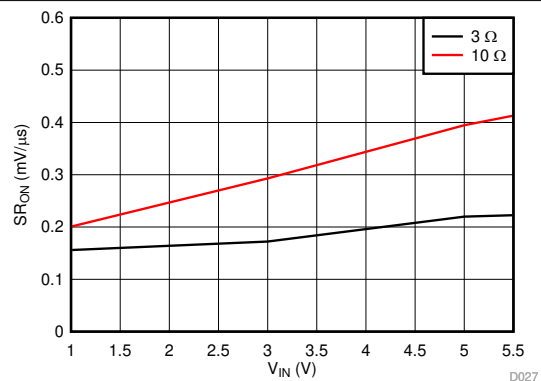

$C_L = 47 \mu\text{F}$

图 7-24. Slew Rate vs Load Resistance (CT = 10000 pF)

7.7.2 Typical Switching Characteristics (continued)



图 7-25. Turn-Off at 3.6 V



$R_L = \text{Open}$        $C_L = 47 \mu\text{F}$

图 7-26. Turn-Off at 3.6 V (Open Load)

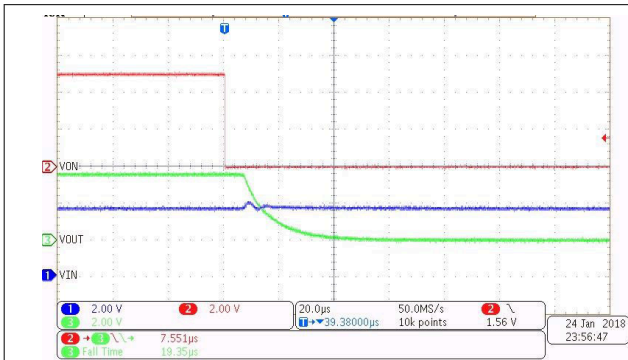
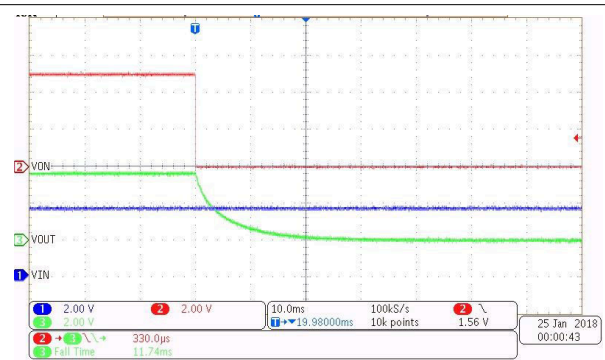
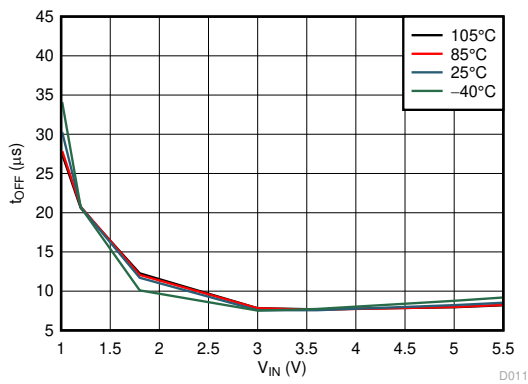

$V_{IN} = 1\text{ V to } 5.5\text{ V}$

图 7-27. Turn-Off Time

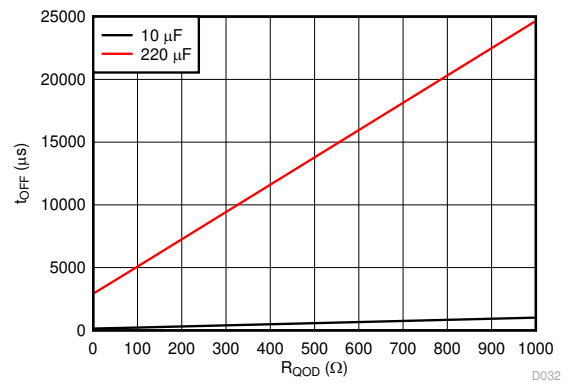

$V_{IN} = 1\text{ V to } 5.5\text{ V}$

$R_L = \text{Open}$

图 7-28. Turn-Off Time (Open Load)

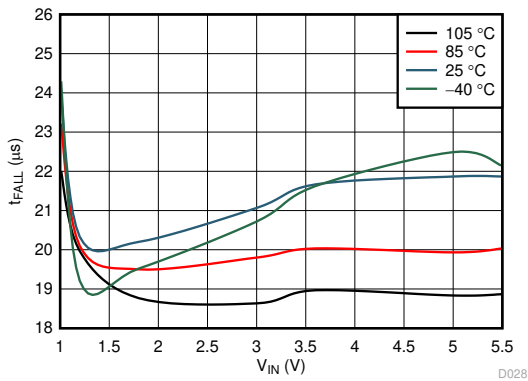

$V_{IN} = 1\text{ V to } 5.5\text{ V}$

图 7-29. Fall Time

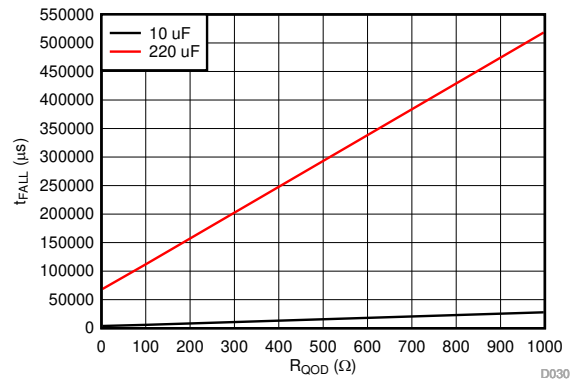

$V_{IN} = 1\text{ V to } 5.5\text{ V}$

$R_L = \text{Open}$

图 7-30. Fall Time (Open Load)

## 8 Parameter Measurement Information

### 8.1 Test Circuit and Timing Waveforms Diagrams

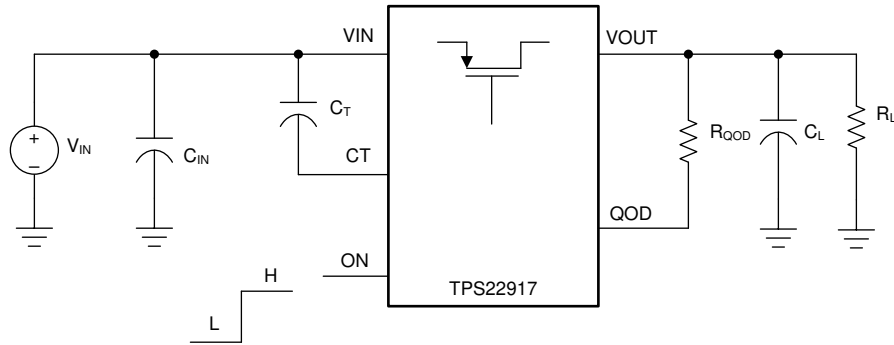

Copyright © 2018, Texas Instruments Incorporated

- A. Rise and fall times of the control signal are 100 ns.
- B. Turn-off times and fall times are dependent on the time constant at the load. For TPS22917x, the internal pull-down resistance QOD is enabled when the switch is disabled. The time constant is  $(R_{QOD} + QOD \parallel R_L) \times C_L$ .

图 8-1. Test Circuit



图 8-2. Timing Waveforms

## 9 Detailed Description

### 9.1 Overview

The TPS22917x device is a 5.5-V, 2-A load switch in a 6-pin SOT-23 package. To reduce voltage drop for low voltage and high current rails, the device implements a low resistance P-channel MOSFET which reduces the drop out voltage across the device.

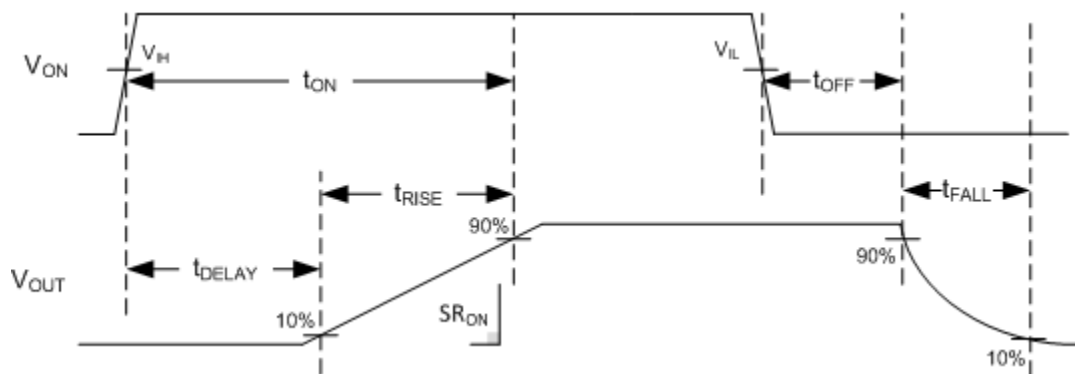
The TPS22917x device has a configurable slew rate which helps reduce or eliminate power supply droop because of large inrush currents. Furthermore, the device features a QOD pin, which allows the configuration of the discharge rate of VOUT after the switch is disabled. During shutdown, the device has very low leakage currents, thereby reducing unnecessary leakages for downstream modules during standby. Integrated control logic, driver, charge pump, and output discharge FET eliminates the need for any external components which reduces solution size and bill of materials (BOM) count.

### 9.2 Functional Block Diagram



## 9.3 Feature Description

### 9.3.1 On and Off Control

The ON pin controls the state of the switch. The ON pin is compatible with standard GPIO logic threshold so it can be used in a wide variety of applications. The TPS22917 is enabled when the voltage applied to the ON pin is pulled above  $V_{IH}$ , while the TPS22917L is enabled when the voltage is below  $V_{IL}$ .

When power is first applied to VIN, a Smart Pulldown is used to keep the ON pin from floating until system sequencing is complete. After the ON pin is deliberately driven high ( $\geq V_{IH}$ ), the Smart Pulldown is disconnected to prevent unnecessary power loss. 表 9-1 shown then the ON Pin Smart Pulldown is active.

表 9-1. Smart-ON Pulldown

VON	Pulldown
$\leq V_{IL}$	Connected
$\geq V_{IH}$	Disconnected

### 9.3.2 Turn-On Time ( $t_{ON}$ ) and Adjustable Slew Rate (CT)

A capacitor to VIN on the CT pin sets the slew rate of  $V_{OUT}$ . The CT capacitor voltage ramps until shortly after the switch is turned on and  $V_{OUT}$  becomes stable.

Leaving the CT pin open results in the highest slew rate and fastest turn-on time. These values can be found in the Switching Characteristics Table. For slower slew rates the required CT capacitor can be found using 方程式 1:

$$CT = (\text{Slew Rate}) \div SR_{ON} \quad (1)$$

where

- Slew Rate = desired slew rate (mV/us)
- CT = the capacitance value on the CT pin (pF)
- $SR_{ON}$  = slew rate constant from table [(mV/ $\mu$ s)  $\times$  pF]

The total turn-on time has a direct correlation to the output slew rate. The fastest turn on times ( $t_{ON}$ ), with CT pin open, can be found in the [Switching Characteristics](#). For slower slew rates, the resulting turn-on time can be found with 方程式 2:

$$\text{Turn-On time} = CT \times t_{ON} \quad (2)$$

where

- Turn-On Time = total time from enable until  $V_{OUT}$  rises to 90% of  $V_{IN}$  ( $\mu$ s)
- CT = the capacitance value on the CT pin (pF)
- $t_{ON}$  = Turn-On time constant ( $\mu$ s/pF)

### 9.3.3 Fall Time ( $t_{FALL}$ ) and Quick Output Discharge (QOD)

The TPS22917x device includes a QOD pin that can be configured in one of three ways:

- QOD pin shorted to VOUT pin. Using this method, the discharge rate after the switch becomes disabled is controlled with the value of the internal resistance QOD.
- QOD pin connected to VOUT pin using an external resistor  $R_{QOD}$ . After the switch becomes disabled, the discharge rate is controlled by the value of the total discharge resistance. To adjust the total discharge resistance, 方程式 3 can be used:

$$R_{DIS} = QOD + R_{QOD} \quad (3)$$

- Where:
- $R_{DIS}$  = total output discharge resistance ( $\Omega$ )
- QOD = internal pulldown resistance ( $\Omega$ )

- $R_{QOD}$  = external resistance placed between the VOUT and QOD pins ( $\Omega$ )
- QOD pin is unused and left floating. Using this method, there is no quick output discharge functionality, and the output remains floating after the switch is disabled.

The fall times of the device depend on many factors including the total discharge resistance ( $R_{DIS}$ ) and the output capacitance ( $C_L$ ). To calculate the approximate fall time of  $V_{OUT}$  use [方程式 4](#).

$$t_{FALL} = 2.2 \times (R_{DIS} \parallel R_L) \times C_L \quad (4)$$

Where:

- $t_{FALL}$  = output fall time from 90% to 10% ( $\mu s$ )
- $R_{DIS}$  = total QOD +  $R_{QOD}$  resistance ( $\Omega$ )
- $R_L$  = output load resistance ( $\Omega$ )
- $C_L$  = output load capacitance ( $\mu F$ )

### 9.3.3.1 QOD When System Power is Removed

The adjustable QOD can be used to control the power down sequencing of a system even when the system power supply is removed. When the power is removed, the input capacitor discharges at  $V_{IN}$ . Past a certain  $V_{IN}$  level, the strength of the  $R_{PD}$  is reduced. If there is still remaining charge on the output capacitor, this results in longer fall times. For further information regarding this condition, see the [Setting Fall Time for Shutdown Power Sequencing](#) section.

## 9.4 Full-Time Reverse Current Blocking

In a scenario where the device is enabled and  $V_{OUT}$  is greater than  $V_{IN}$  there is potential for reverse current to flow through the pass FET or the body diode. When the reverse current threshold ( $I_{RCB}$ ) is exceeded, the switch is disabled within  $t_{RCB}$ . The Switch remains off and block reverse current as long as the reverse voltage condition exists. After  $V_{OUT}$  has dropped below the  $V_{RCB}$  release threshold the device turns back on with slew rate control.

## 9.5 Device Functional Modes

[表 9-2](#) describes the connection of the VOUT pin depending on the state of the ON pin as well as the various QOD pin configurations.

**表 9-2. VOUT Connection**

ON	QOD CONFIGURATION	TPS22917 VOUT	TPS22917L VOUT
L	QOD pin connected to VOUT with $R_{QOD}$	GND (via QOD + $R_{QOD}$ )	VIN
L	QOD pin tied to VOUT directly	GND (via QOD)	VIN
L	QOD pin left open	Floating	VIN
H	QOD pin connected to VOUT with $R_{QOD}$	VIN	GND (via QOD + $R_{QOD}$ )
H	QOD pin tied to VOUT directly	VIN	GND (via QOD)
H	QOD pin left open	VIN	Floating

## 10 Application and Implementation

### 备注

以下应用部分中的信息不属于 TI 器件规格的范围，TI 不担保其准确性和完整性。TI 的客户应负责确定器件是否适用于其应用。客户应验证并测试其设计，以确保系统功能。

### 10.1 Application Information

This section highlights some of the design considerations when implementing this device in various applications.

### 10.2 Typical Application

This typical application demonstrates how the TPS22917x device can be used to power downstream modules.

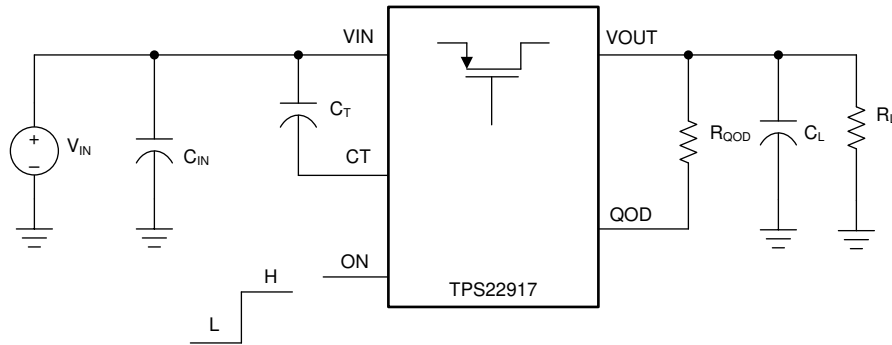

Copyright © 2018, Texas Instruments Incorporated

图 10-1. Typical Application Schematic

#### 10.2.1 Design Requirements

For this design example, use the values listed in 表 10-1 as the design parameters:

表 10-1. Design Parameters

DESIGN PARAMETER	EXAMPLE VALUE
Input voltage ( $V_{IN}$ )	3.6 V
Load current / resistance ( $R_L$ )	1 k $\Omega$
Load capacitance ( $C_L$ )	47 $\mu$ F
Minimum fall time ( $t_F$ )	40 ms
Maximum inrush current ( $I_{RUSH}$ )	150 mA

## 10.2.2 Detailed Design Procedure

### 10.2.2.1 Limiting Inrush Current

Use 方程式 5 to find the maximum slew rate value to limit inrush current for a given capacitance:

$$(\text{Slew Rate}) = I_{\text{RUSH}} \div C_L \quad (5)$$

where

- $I_{\text{INRUSH}}$  = maximum acceptable inrush current (mA)
- $C_L$  = capacitance on VOUT (μF)
- Slew Rate = Output Slew Rate during turn on (mV/μs)

After the required slew rate shown in 方程式 1 can be used to find the minimum CT capacitance

$$CT = SR_{\text{ON}} \div (\text{Slew Rate}) \quad (6)$$

$$CT = 1900 \div 3.2 = 594 \text{ pF} \quad (7)$$

To ensure an inrush current of less than 150 mA, choose a CT value greater than 594 pF. An appropriate value must be placed on such that the  $I_{\text{MAX}}$  and  $I_{\text{PLS}}$  specifications of the device are not violated.

### 10.2.2.2 Application Curves

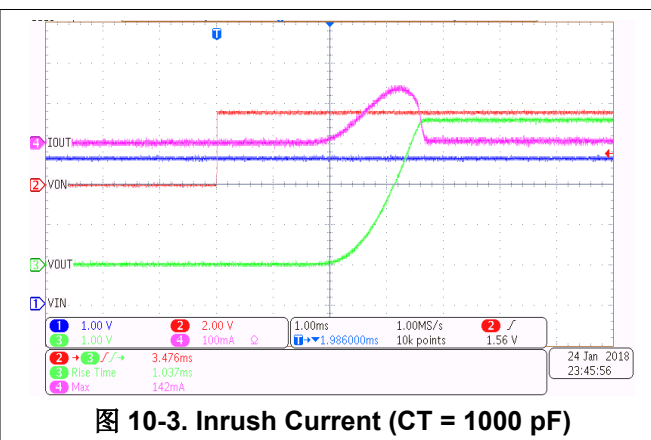
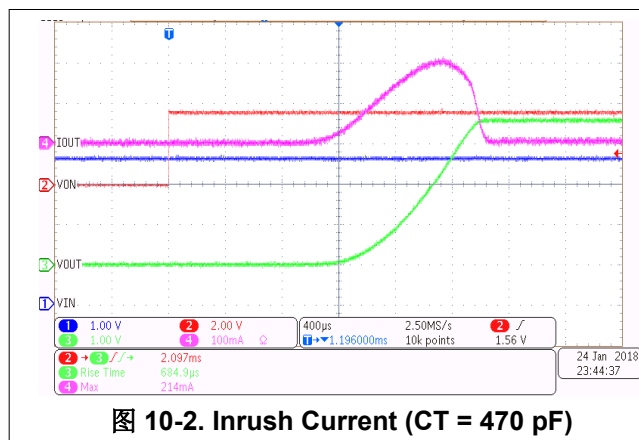

### 10.2.2.3 Setting Fall Time for Shutdown Power Sequencing

Microcontrollers and processors often have a specific shutdown sequence in which power must be removed. Using the adjustable Quick Output Discharge function of the TPS22917x, adding a load switch to each power rail can be used to manage the power down sequencing. To determine the QOD values for each load switch, first confirm the power down order of the device you wish to power sequence. Be sure to check if there are voltage or timing margins that must be maintained during power down.

After the required fall time is determined, the maximum external discharge resistance ( $R_{\text{DIS}}$ ) value can be found using 方程式 4:

$$t_{\text{FALL}} = 2.2 \times (R_{\text{DIS}} \parallel R_L) \times C_L \quad (8)$$

$$R_{\text{DIS}} = 630 \ \Omega \quad (9)$$

方程式 3 can then be used to calculate the  $R_{\text{QOD}}$  resistance needed to achieve a particular discharge value:

$$R_{\text{DIS}} = QOD + R_{\text{QOD}} \quad (10)$$

$$R_{\text{QOD}} = 480 \ \Omega \quad (11)$$

To ensure a fall time greater than, choose an  $R_{QOD}$  value greater than  $480 \Omega$ .

### 10.2.2.4 Application Curves

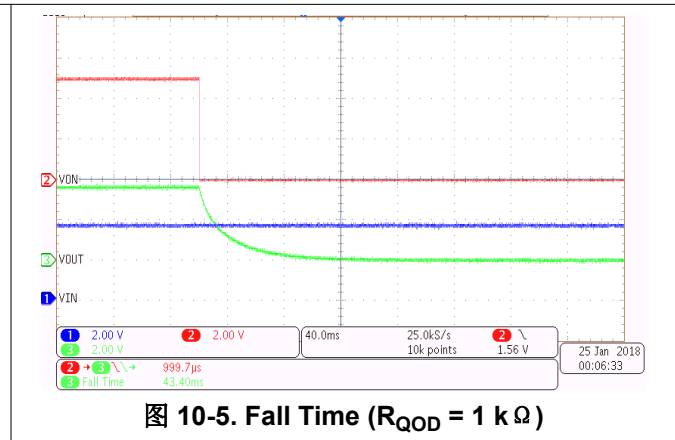
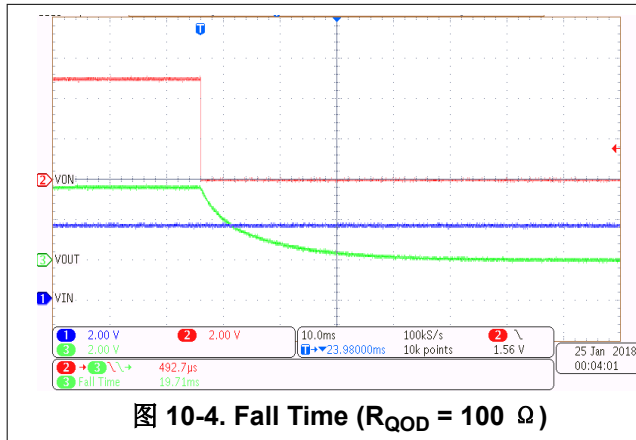

## 11 Power Supply Recommendations

The device is designed to operate with a  $V_{IN}$  range of 1 V to 5.5 V. The  $V_{IN}$  power supply must be well regulated and placed as close to the device terminal as possible. The power supply must be able to withstand all transient load current steps. In most situations, using an input capacitance ( $C_{IN}$ ) of  $1 \mu\text{F}$  is sufficient to prevent the supply voltage from dipping when the switch is turned on. In cases where the power supply is slow to respond to a large transient current or large load current step, additional bulk capacitance can be required on the input.

## 12 Layout

### 12.1 Layout Guidelines

For best performance, all traces must be as short as possible. To be most effective, the input and output capacitors must be placed close to the device to minimize the effects that parasitic trace inductances can have on normal operation. Using wide traces for VIN, VOUT, and GND helps minimize the parasitic electrical effects.

### 12.2 Layout Example



图 12-1. Recommended Board Layout

### 12.3 Thermal Considerations

The maximum IC junction temperature must be restricted to 125°C under normal operating conditions. To calculate the maximum allowable dissipation,  $P_{D(max)}$  for a given output current and ambient temperature, use 方程式 12:

$$P_{D(MAX)} = \frac{T_{J(MAX)} - T_A}{\theta_{JA}} \quad (12)$$

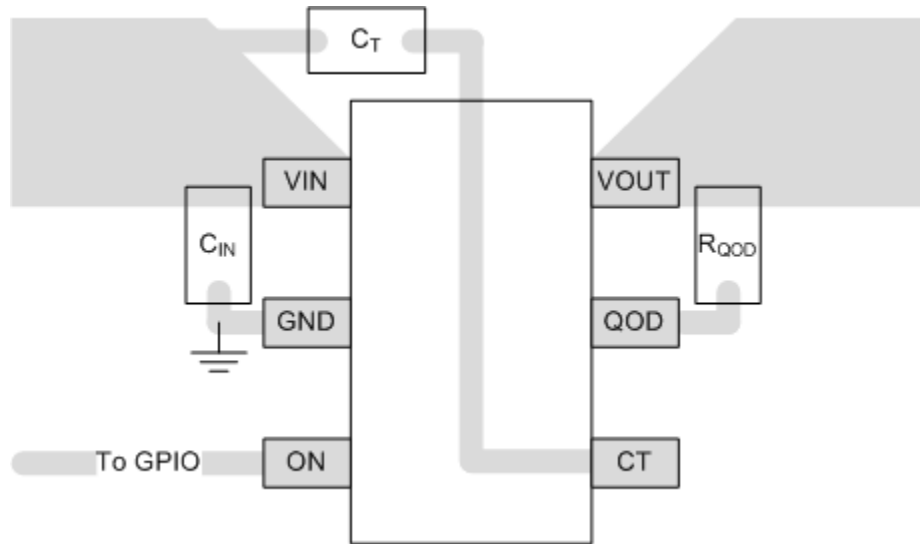
where

- $P_{D(MAX)}$  = maximum allowable power dissipation
- $T_{J(MAX)}$  = maximum allowable junction temperature (125°C for the TPS22917x)
- $T_A$  = ambient temperature of the device
- $\theta_{JA}$  = junction to air thermal impedance. Refer to the [Thermal Information](#) section. This parameter is highly dependent upon board layout.

## 13 Device and Documentation Support

### 13.1 接收文档更新通知

要接收文档更新通知，请导航至 [ti.com](http://ti.com) 上的器件产品文件夹。点击 [订阅更新](#) 进行注册，即可每周接收产品信息更改摘要。有关更改的详细信息，请查看任何已修订文档中包含的修订历史记录。

### 13.2 支持资源

**TI E2E™ 支持论坛**是工程师的重要参考资料，可直接从专家获得快速、经过验证的解答和设计帮助。搜索现有解答或提出自己的问题可获得所需的快速设计帮助。

链接的内容由各个贡献者“按原样”提供。这些内容并不构成 TI 技术规范，并且不一定反映 TI 的观点；请参阅 TI 的《[使用条款](#)》。

### 13.3 Trademarks

TI E2E™ is a trademark of Texas Instruments.  
所有商标均为其各自所有者的财产。

### 13.4 Electrostatic Discharge Caution



This integrated circuit can be damaged by ESD. Texas Instruments recommends that all integrated circuits be handled with appropriate precautions. Failure to observe proper handling and installation procedures can cause damage.

ESD damage can range from subtle performance degradation to complete device failure. Precision integrated circuits may be more susceptible to damage because very small parametric changes could cause the device not to meet its published specifications.

### 13.5 术语表

**TI 术语表** 本术语表列出并解释了术语、首字母缩略词和定义。

## 14 Mechanical, Packaging, and Orderable Information

The following pages include mechanical, packaging, and orderable information. This information is the most current data available for the designated devices. This data is subject to change without notice and revision of this document. For browser-based versions of this data sheet, refer to the left-hand navigation.

**PACKAGING INFORMATION**

Orderable part number	Status (1)	Material type (2)	Package   Pins	Package qty   Carrier	RoHS (3)	Lead finish/ Ball material (4)	MSL rating/ Peak reflow (5)	Op temp (°C)	Part marking (6)
<a href="#">TPS22917DBVR</a>	Active	Production	SOT-23 (DBV)   6	3000   LARGE T&R	Yes	NIPDAU   SN	Level-1-260C-UNLIM	-40 to 125	11AF
TPS22917DBVR.A	Active	Production	SOT-23 (DBV)   6	3000   LARGE T&R	Yes	NIPDAU	Level-1-260C-UNLIM	-40 to 125	11AF
TPS22917DBVRG4	Active	Production	SOT-23 (DBV)   6	3000   LARGE T&R	Yes	NIPDAU	Level-1-260C-UNLIM	-40 to 125	11AF
TPS22917DBVRG4.A	Active	Production	SOT-23 (DBV)   6	3000   LARGE T&R	Yes	NIPDAU	Level-1-260C-UNLIM	-40 to 125	11AF
<a href="#">TPS22917DBVT</a>	Active	Production	SOT-23 (DBV)   6	250   SMALL T&R	Yes	NIPDAU   SN	Level-1-260C-UNLIM	-40 to 125	11AF
TPS22917DBVT.A	Active	Production	SOT-23 (DBV)   6	250   SMALL T&R	Yes	NIPDAU	Level-1-260C-UNLIM	-40 to 125	11AF
<a href="#">TPS22917LDBVR</a>	Active	Production	SOT-23 (DBV)   6	3000   LARGE T&R	Yes	NIPDAU   SN	Level-1-260C-UNLIM	-45 to 125	2K7F
TPS22917LDBVR.A	Active	Production	SOT-23 (DBV)   6	3000   LARGE T&R	Yes	NIPDAU	Level-1-260C-UNLIM	-40 to 125	2K7F
TPS22917LDBVRG4	Active	Production	SOT-23 (DBV)   6	3000   LARGE T&R	Yes	NIPDAU	Level-1-260C-UNLIM	-40 to 125	2K7F
TPS22917LDBVRG4.A	Active	Production	SOT-23 (DBV)   6	3000   LARGE T&R	Yes	NIPDAU	Level-1-260C-UNLIM	-40 to 125	2K7F

(1) **Status:** For more details on status, see our [product life cycle](#).

(2) **Material type:** When designated, preproduction parts are prototypes/experimental devices, and are not yet approved or released for full production. Testing and final process, including without limitation quality assurance, reliability performance testing, and/or process qualification, may not yet be complete, and this item is subject to further changes or possible discontinuation. If available for ordering, purchases will be subject to an additional waiver at checkout, and are intended for early internal evaluation purposes only. These items are sold without warranties of any kind.

(3) **RoHS values:** Yes, No, RoHS Exempt. See the [TI RoHS Statement](#) for additional information and value definition.

(4) **Lead finish/Ball material:** Parts may have multiple material finish options. Finish options are separated by a vertical ruled line. Lead finish/Ball material values may wrap to two lines if the finish value exceeds the maximum column width.

(5) **MSL rating/Peak reflow:** The moisture sensitivity level ratings and peak solder (reflow) temperatures. In the event that a part has multiple moisture sensitivity ratings, only the lowest level per JEDEC standards is shown. Refer to the shipping label for the actual reflow temperature that will be used to mount the part to the printed circuit board.

(6) **Part marking:** There may be an additional marking, which relates to the logo, the lot trace code information, or the environmental category of the part.

Multiple part markings will be inside parentheses. Only one part marking contained in parentheses and separated by a "~" will appear on a part. If a line is indented then it is a continuation of the previous line and the two combined represent the entire part marking for that device.

**Important Information and Disclaimer:** The information provided on this page represents TI's knowledge and belief as of the date that it is provided. TI bases its knowledge and belief on information provided by third parties, and makes no representation or warranty as to the accuracy of such information. Efforts are underway to better integrate information from third parties. TI has taken and continues to take reasonable steps to provide representative

and accurate information but may not have conducted destructive testing or chemical analysis on incoming materials and chemicals. TI and TI suppliers consider certain information to be proprietary, and thus CAS numbers and other limited information may not be available for release.

In no event shall TI's liability arising out of such information exceed the total purchase price of the TI part(s) at issue in this document sold by TI to Customer on an annual basis.

**TAPE AND REEL INFORMATION**

**QUADRANT ASSIGNMENTS FOR PIN 1 ORIENTATION IN TAPE**

\*All dimensions are nominal

Device	Package Type	Package Drawing	Pins	SPQ	Reel Diameter (mm)	Reel Width W1 (mm)	A0 (mm)	B0 (mm)	K0 (mm)	P1 (mm)	W (mm)	Pin1 Quadrant
TPS22917DBVR	SOT-23	DBV	6	3000	178.0	8.4	3.2	3.2	1.4	4.0	8.0	Q3
TPS22917DBVR	SOT-23	DBV	6	3000	180.0	8.4	3.2	3.2	1.4	4.0	8.0	Q3
TPS22917DBVRG4	SOT-23	DBV	6	3000	180.0	8.4	3.2	3.2	1.4	4.0	8.0	Q3
TPS22917DBVT	SOT-23	DBV	6	250	180.0	8.4	3.2	3.2	1.4	4.0	8.0	Q3
TPS22917LDBVR	SOT-23	DBV	6	3000	180.0	8.4	3.2	3.2	1.4	4.0	8.0	Q3
TPS22917LDBVR	SOT-23	DBV	6	3000	180.0	8.4	3.2	3.2	1.4	4.0	8.0	Q3
TPS22917LDBVRG4	SOT-23	DBV	6	3000	180.0	8.4	3.2	3.2	1.4	4.0	8.0	Q3

**TAPE AND REEL BOX DIMENSIONS**

\*All dimensions are nominal

Device	Package Type	Package Drawing	Pins	SPQ	Length (mm)	Width (mm)	Height (mm)
TPS22917DBVR	SOT-23	DBV	6	3000	208.0	191.0	35.0
TPS22917DBVR	SOT-23	DBV	6	3000	210.0	185.0	35.0
TPS22917DBVRG4	SOT-23	DBV	6	3000	210.0	185.0	35.0
TPS22917DBVT	SOT-23	DBV	6	250	210.0	185.0	35.0
TPS22917LDBVR	SOT-23	DBV	6	3000	210.0	185.0	35.0
TPS22917LDBVR	SOT-23	DBV	6	3000	210.0	185.0	35.0
TPS22917LDBVRG4	SOT-23	DBV	6	3000	210.0	185.0	35.0



# EXAMPLE BOARD LAYOUT

DBV0006A

SOT-23 - 1.45 mm max height

SMALL OUTLINE TRANSISTOR



LAND PATTERN EXAMPLE  
EXPOSED METAL SHOWN  
SCALE:15X

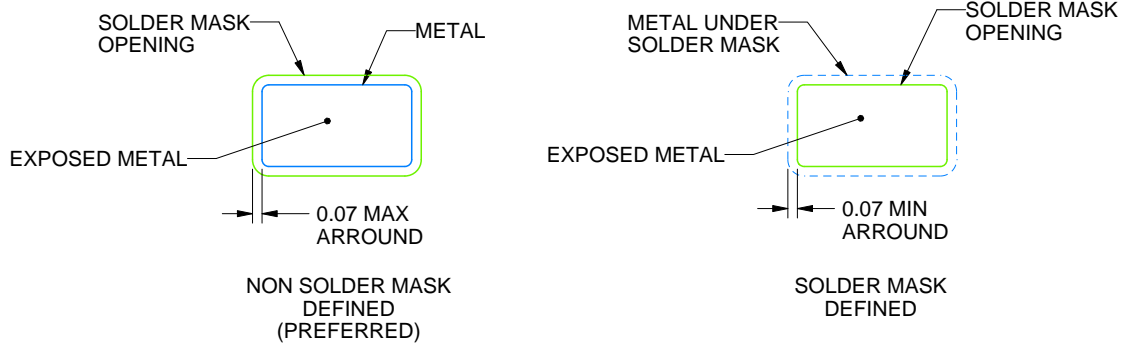

SOLDER MASK DETAILS

4214840/G 08/2024

NOTES: (continued)

6. Publication IPC-7351 may have alternate designs.
7. Solder mask tolerances between and around signal pads can vary based on board fabrication site.

# EXAMPLE STENCIL DESIGN

DBV0006A

SOT-23 - 1.45 mm max height

SMALL OUTLINE TRANSISTOR



SOLDER PASTE EXAMPLE  
BASED ON 0.125 mm THICK STENCIL  
SCALE:15X

4214840/G 08/2024

NOTES: (continued)

8. Laser cutting apertures with trapezoidal walls and rounded corners may offer better paste release. IPC-7525 may have alternate design recommendations.
9. Board assembly site may have different recommendations for stencil design.

## 重要通知和免责声明

TI“按原样”提供技术和可靠性数据（包括数据表）、设计资源（包括参考设计）、应用或其他设计建议、网络工具、安全信息和其他资源，不保证没有瑕疵且不做任何明示或暗示的担保，包括但不限于对适销性、与某特定用途的适用性或不侵犯任何第三方知识产权的暗示担保。

这些资源可供使用 TI 产品进行设计的熟练开发人员使用。您将自行承担以下全部责任：(1) 针对您的应用选择合适的 TI 产品，(2) 设计、验证并测试您的应用，(3) 确保您的应用满足相应标准以及任何其他安全、安保法规或其他要求。

这些资源如有变更，恕不另行通知。TI 授权您仅可将这些资源用于研发本资源所述的 TI 产品的相关应用。严禁以其他方式对这些资源进行复制或展示。您无权使用任何其他 TI 知识产权或任何第三方知识产权。对于因您对这些资源的使用而对 TI 及其代表造成的任何索赔、损害、成本、损失和债务，您将全额赔偿，TI 对此概不负责。

TI 提供的产品受 [TI 销售条款](#)、[TI 通用质量指南](#) 或 [ti.com](#) 上其他适用条款或 TI 产品随附的其他适用条款的约束。TI 提供这些资源并不会扩展或以其他方式更改 TI 针对 TI 产品发布的适用的担保或担保免责声明。除非德州仪器 (TI) 明确将某产品指定为定制产品或客户特定产品，否则其产品均为按确定价格收入目录的标准通用器件。

TI 反对并拒绝您可能提出的任何其他或不同的条款。

版权所有 © 2026，德州仪器 (TI) 公司

最后更新日期：2025 年 10 月