

TPS51100 3-A Sink / Source DDR Termination Regulator

1 Features

- Input Voltage Range: 4.75 V to 5.25 V
- VLDOIN Voltage Range: 1.2 V to 3.6 V
- 3-A Sink/Source Termination Regulator Includes Droop Compensation
- Requires Only 20- μ F Ceramic Output Capacitance
- Supports Hi-Z in S3 and Soft-Off in S5
- 1.2-V Input (VLDOIN) Helps Reduce Total Power Dissipation
- Integrated Divider Tracks 0.5 VDDQSNS for VTT and VTTREF
- Remote Sensing (VTTSENS)
- \pm 20-mV Accuracy for VTT and VTTREF
- 10-mA Buffered Reference (VTTREF)
- Built-In Soft-Start, UVLO, and OCL
- Thermal Shutdown
- Supports JEDEC Specifications

2 Applications

- DDR, DDR2, DDR3 Memory Termination
- SSTL-2, SSTL-18, and HSTL Termination

3 Description

The TPS51100 is a 3-A, sink/source tracking termination regulator. The device is specifically designed for low-cost and low-external component count systems where space is a premium.

The TPS51100 maintains fast transient response, only requiring 20 μ F ($2 \times 10 \mu$ F) of ceramic output capacitance. The TPS51100 supports remote sensing functions and all features required to power the DDR and DDR2 VTT bus termination according to the JEDEC specification. The part also supports DDR3 VTT termination with VDDQ at 1.5 V (typical). In addition, the TPS51100 includes integrated sleep-state controls, placing VTT in Hi-Z in S3 (suspend to RAM) and soft-off for VTT and VTTREF in S5 (suspend to disk). The TPS51100 is available in the thermally efficient 10-pin MSOP PowerPAD™ package and is specified from -40°C to 85°C .

Device Information⁽¹⁾

PART NUMBER	PACKAGE	BODY SIZE (NOM)
TPS51100	HVSSOP (10)	3.00 mm x 3.00 mm

(1) For all available packages, see the orderable addendum at the end of the datasheet.

Simplified Schematic

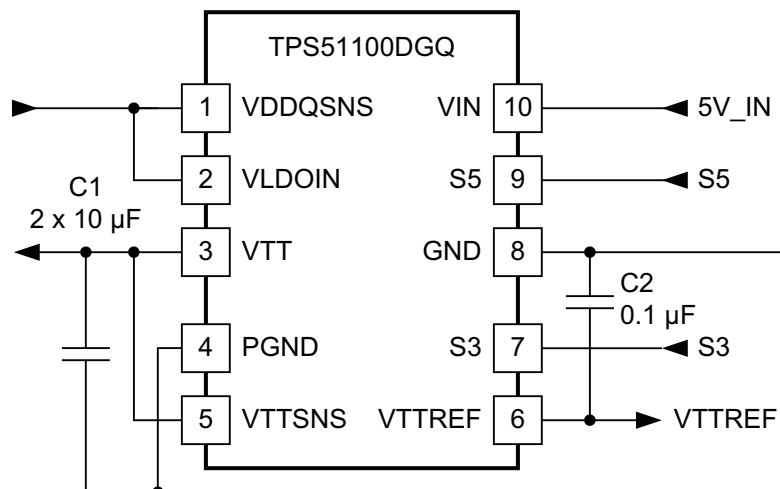

Capacitor	Manuf	Part Number
C1	TDK	C2012JB0J106K
C2	TDK	C1608JB1H104K



Table of Contents

1 Features	1	7.4 Device Functional Modes.....	12
2 Applications	1	8 Application and Implementation	13
3 Description	1	8.1 Application Information.....	13
4 Revision History	2	8.2 Typical Application	13
5 Pin Configuration and Functions	3	9 Power Supply Recommendations	16
6 Specifications	4	10 Layout	16
6.1 Absolute Maximum Ratings	4	10.1 Layout Guidelines	16
6.2 Recommended Operating Conditions.....	4	10.2 Layout Example	17
6.3 Thermal Information	4	10.3 Thermal Considerations	17
6.4 Electrical Characteristics.....	5	11 Device and Documentation Support	19
6.5 Typical Characteristics.....	7	11.1 Device Support.....	19
7 Detailed Description	11	11.2 Trademarks	19
7.1 Overview	11	11.3 Electrostatic Discharge Caution.....	19
7.2 Functional Block Diagram	11	11.4 Glossary	19
7.3 Feature Description.....	11	12 Mechanical, Packaging, and Orderable Information	19

4 Revision History

NOTE: Page numbers for previous revisions may differ from page numbers in the current version.

Changes from Revision D (May 2012) to Revision E	Page
<ul style="list-style-type: none"> Added <i>Pin Configuration and Functions</i> section, <i>Feature Description</i> section, <i>Device Functional Modes</i>, <i>Application and Implementation</i> section, <i>Power Supply Recommendations</i> section, <i>Layout</i> section, <i>Device and Documentation Support</i> section, and <i>Mechanical, Packaging, and Orderable Information</i> section 	1

Changes from Revision C (June 2008) to Revision D	Page
<ul style="list-style-type: none"> Added updated Thermal data 	4

5 Pin Configuration and Functions

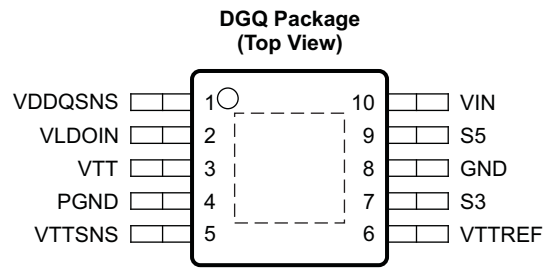

Actual Size
3,05 mm x 4,98 mm

P0083-01

NOTE: For more information on the DGQ package, see the *PowerPAD Thermally Enhanced Package* application report ([SLMA002](#)).

Pin Functions

PIN		I/O	DESCRIPTION
NAME	NO.		
GND	8	–	Signal ground. Connect to negative terminal of the output capacitor
PGND	4	–	Power ground output for the VTT LDO
S3	7	I	S3 signal input
S5	9	I	S5 signal input
VDDQSNS	1	I	VDDQ sense input
VIN	10	I	5-V power supply
VLDOIN	2	I	Power supply for the VTT LDO and VTTREF output stage
VTT	3	O	Power output for the VTT LDO
VTTREF	6	O	VTT reference output. Connect to GND through 0.1- μ F ceramic capacitor.
VTTSENS	5	I	Voltage sense input for the VTT LDO. Connect to plus terminal of the output capacitor.

6 Specifications

6.1 Absolute Maximum Ratings

over operating free-air temperature range (unless otherwise noted)⁽¹⁾

		MIN	MAX	UNIT
Input voltage ⁽²⁾	VIN, VLDOIN, VTTSNS, VDDQSNS, S3, S5	-0.3	6	V
	PGND	-0.3	0.3	
Output voltage ⁽²⁾	VTT, VTTREF	-0.3	6	V
T _A	Operating ambient temperature	-40	85	°C
T _{stg}	Storage temperature	-55	150	°C

- (1) Stresses beyond those listed under *Absolute Maximum Ratings* may cause permanent damage to the device. These are stress ratings only, and functional operation of the device at these or any other conditions beyond those indicated under *Recommended Operating Conditions* is not implied. Exposure to absolute-maximum-rated conditions for extended periods may affect device reliability.
- (2) All voltage values are with respect to the network ground terminal unless otherwise noted.

6.2 Recommended Operating Conditions

over operating free-air temperature range (unless otherwise noted)

		MIN	MAX	UNIT
V _{IN}	Supply voltage	4.75	5.25	V
Voltage range	S3, S5	-0.10	5.25	V
	VLDOIN, VDDQSNS, VTT, VTTSNS	-0.1	3.6	
	VTTREF	-0.1	1.8	
	PGND	-0.1	0.1	
T _A	Operating free-air temperature	-40	85	°C

6.3 Thermal Information

THERMAL METRIC ⁽¹⁾		TPS51100		UNIT
		DGQ		
		10 PINS		
R _{θJA}	Junction-to-ambient thermal resistance	60.3		°C/W
R _{θJC(top)}	Junction-to-case (top) thermal resistance	63.5		
R _{θJB}	Junction-to-board thermal resistance	51.6		
ψ _{JT}	Junction-to-top characterization parameter	1.5		
ψ _{JB}	Junction-to-board characterization parameter	22.3		
R _{θJC(bot)}	Junction-to-case (bottom) thermal resistance	9.5		

- (1) For more information about traditional and new thermal metrics, see the *IC Package Thermal Metrics* application report, [SPRA953](http://www.ti.com/lit/zip/spra953).

6.4 Electrical Characteristics

$T_A = -40^\circ\text{C}$ to 85°C , $V_{VIN} = 5\text{ V}$, VLDOIN and VDDQSNS are connected to 2.5 V (unless otherwise noted)

PARAMETER		TEST CONDITIONS	MIN	TYP	MAX	UNIT
SUPPLY CURRENT						
I_{VIN}	Supply current, VIN	$T_A = 25^\circ\text{C}$, $V_{VIN} = 5\text{ V}$, no load, $V_{S3} = V_{S5} = 5\text{ V}$	0.25	0.5	1	mA
I_{VINSTB}	Standby current, VIN	$T_A = 25^\circ\text{C}$, $V_{VIN} = 5\text{ V}$, no load, $V_{S3} = 0\text{ V}$, $V_{S5} = 5\text{ V}$	25	50	80	μA
I_{VINSN}	Shutdown current, VIN	$T_A = 25^\circ\text{C}$, $V_{VIN} = 5\text{ V}$, no load, $V_{S3} = V_{S5} = 0\text{ V}$, $V_{VLDOIN} = V_{VDDQSNS} = 0\text{ V}$		0.3	1	μA
I_{VLDOIN}	Supply current, VLDOIN	$T_A = 25^\circ\text{C}$, $V_{VIN} = 5\text{ V}$, no load, $V_{S3} = V_{S5} = 5\text{ V}$	0.7	1.2	2	mA
$I_{VLDOINSTB}$	Standby current, VLDOIN	$T_A = 25^\circ\text{C}$, $V_{VIN} = 5\text{ V}$, no load, $V_{S3} = 0\text{ V}$, $V_{S5} = 5\text{ V}$		6	10	μA
$I_{VLDOINSN}$	Shutdown current, VLDOIN	$T_A = 25^\circ\text{C}$, $V_{VIN} = 5\text{ V}$, no load, $V_{S3} = V_{S5} = 0\text{ V}$		0.3	1	μA
INPUT CURRENT						
$I_{VDDQSNS}$	Input current, VDDQSNS	$V_{VIN} = 5\text{ V}$, $V_{S3} = V_{S5} = 5\text{ V}$	1	3	5	μA
I_{VTTSNS}	Input current, VTTSNS	$V_{VIN} = 5\text{ V}$, $V_{S3} = V_{S5} = 5\text{ V}$	-1	-0.25	1	μA
VTT OUTPUT						
V_{VTTSNS}	Output voltage, VTT	$V_{VLDOIN} = V_{VDDQSNS} = 2.5\text{ V}$		1.25		V
		$V_{VLDOIN} = V_{VDDQSNS} = 1.8\text{ V}$		0.9		
		$V_{VLDOIN} = V_{VDDQSNS} = 1.5\text{ V}$		0.75		
$V_{VTTOL25}$	Output voltage tolerance to VTTREF, VTT	$V_{VLDOIN} = V_{VDDQSNS} = 2.5\text{ V}$, $ I_{VTT} = 0\text{ A}$	-20		20	mV
		$V_{VLDOIN} = V_{VDDQSNS} = 2.5\text{ V}$, $ I_{VTT} = 1.5\text{ A}$	-30		30	
		$V_{VLDOIN} = V_{VDDQSNS} = 2.5\text{ V}$, $ I_{VTT} = 3\text{ A}$	-40		40	
$V_{VLDOIN} = V_{VDDQSNS} = 1.8\text{ V}$, $ I_{VTT} = 0\text{ A}$		-20		20		
$V_{VLDOIN} = V_{VDDQSNS} = 1.8\text{ V}$, $ I_{VTT} = 1\text{ A}$		-30		30		
$V_{VLDOIN} = V_{VDDQSNS} = 1.8\text{ V}$, $ I_{VTT} = 2\text{ A}$		-40		40		
$V_{VLDOIN} = V_{VDDQSNS} = 1.5\text{ V}$, $ I_{VTT} = 0\text{ A}$		-20		20		
$V_{VLDOIN} = V_{VDDQSNS} = 1.5\text{ V}$, $ I_{VTT} = 1\text{ A}$		-30		30		
$V_{VTTOL18}$						
$V_{VTTOL15}$						
$I_{VTTCLSRC}$	Source current limit, VTT	$V_{TT} = \left(\frac{V_{VDDQSNS}}{2}\right) \times 0.95$, PGOOD = High	3	3.8	6	A
		$V_{VTT} = 0\text{ V}$	1.5	2.2	3	
$I_{VTTCLSNK}$	Sink current limit, VTT	$V_{TT} = \left(\frac{V_{VDDQSNS}}{2}\right) \times 1.05$, PGOOD = High	3	3.6	6	A
		$V_{VTT} = V_{VDDQ}$	1.5	2.2	3	
I_{VTTCLK}	Leakage current, VTT	$V_{TT} = \left(\frac{V_{VDDQSNS}}{2}\right) \times 1.25\text{ V}$, $T_A = 25^\circ\text{C}$	-1	0.5	10	μA
		$V_{S3} = 0\text{ V}$, $V_{S5} = 5\text{ V}$				
$I_{VTTSNSLK}$	Leakage current, VTTSNS	$V_{TT} = \left(\frac{V_{VDDQSNS}}{2}\right) \times 1.25\text{ V}$, $T_A = 25^\circ\text{C}$	-1	0.01	1	μA
I_{DSCHRG}	Discharge current, VTT	$T_A = 25^\circ\text{C}$, $V_{VDDQSNS} = 0\text{ V}$, $V_{S3} = V_{S5} = 0\text{ V}$, $V_{VTT} = 0.5\text{ V}$	10	17		mA
VTTREF OUTPUT						
V_{VTTREF}	Output voltage, VTTREF			$\frac{V_{VDDQSNS}}{2}$		V
$V_{VTTREFOL25}$	Output voltage tolerance to VDDQSNS/2, VTTREF	$V_{VLDOIN} = V_{VDDQSNS} = 2.5\text{ V}$, $I_{VTTREF} < 10\text{ mA}$	-20		20	mV
$V_{VTTREFOL18}$		$V_{VLDOIN} = V_{VDDQSNS} = 1.8\text{ V}$, $I_{VTTREF} < 10\text{ mA}$	-17		17	
$V_{VTTREFOL15}$		$V_{VLDOIN} = V_{VDDQSNS} = 1.5\text{ V}$, $I_{VTTREF} < 10\text{ mA}$	-15		15	
$I_{VTTREFOCL}$	Source current limit, VTTREF	$V_{VTTREF} = 0\text{ V}$	10	20	30	mA

Electrical Characteristics (continued)
 $T_A = -40^{\circ}\text{C}$ to 85°C , $V_{\text{VIN}} = 5\text{ V}$, VLDOIN and VDDQSNS are connected to 2.5 V (unless otherwise noted)

PARAMETER		TEST CONDITIONS	MIN	TYP	MAX	UNIT
UVLO/LOGIC THRESHOLD						
V_{VINUV}	UVLO threshold voltage, VIN	Wake up	3.4	3.7	4	V
		Hysteresis	0.15	0.25	0.35	
V_{IH}	High-level input voltage	S3, S5	1.6			V
V_{IL}	Low-level input voltage	S3, S5			0.3	V
V_{IHYST}	Hysteresis voltage	S3, S5		0.2		V
I_{LEAK}	Logic input leakage current	S2, S5, $T_A = 25^{\circ}\text{C}$	-1		1	μA
THERMAL SHUTDOWN						
T_{SDN}	Thermal shutdown threshold	Shutdown temperature		160		$^{\circ}\text{C}$
		Hysteresis		10		

6.5 Typical Characteristics

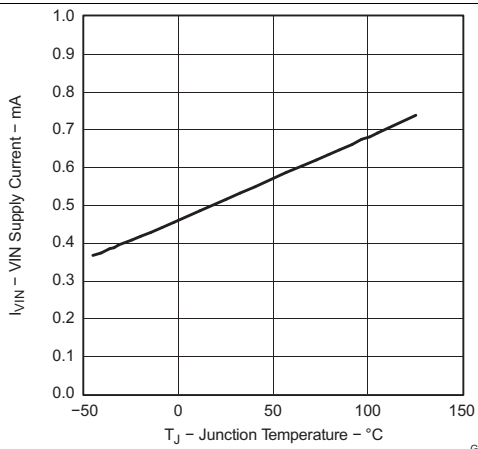

Figure 1. VIN Supply Current vs Temperature

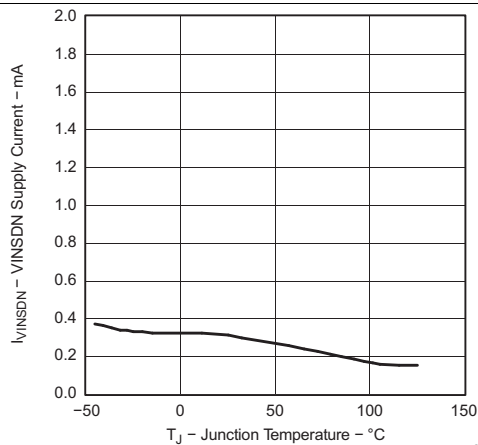

Figure 2. VIN Shutdown Current vs Temperature

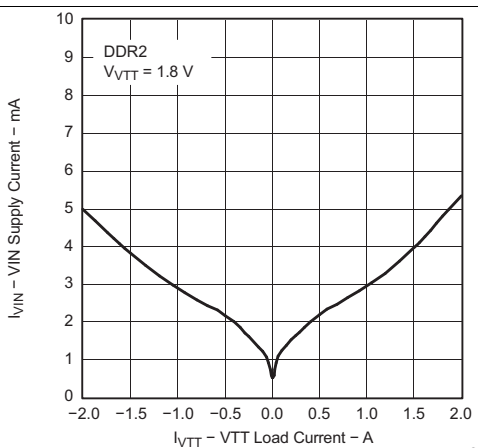

Figure 3. VIN Supply Current vs VTT Load Current

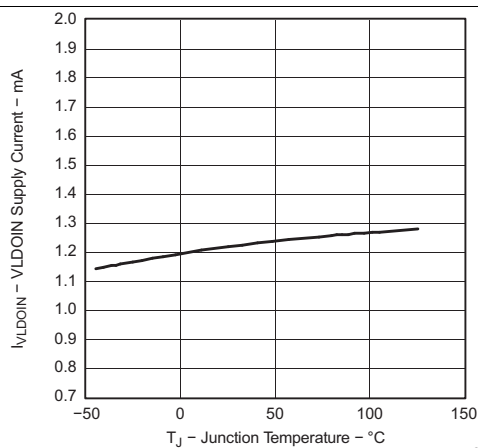

Figure 4. VLDOIN Supply Current vs Temperature

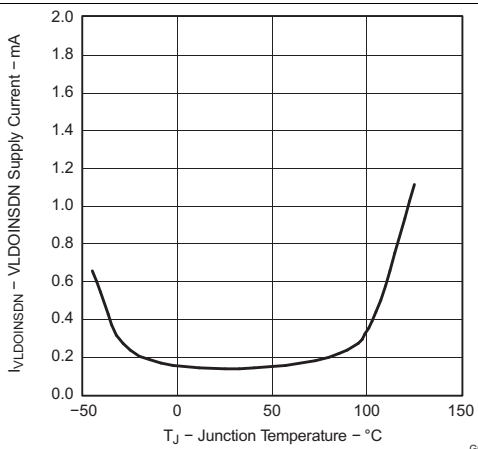

Figure 5. VLDOIN Shutdown Current vs Temperature

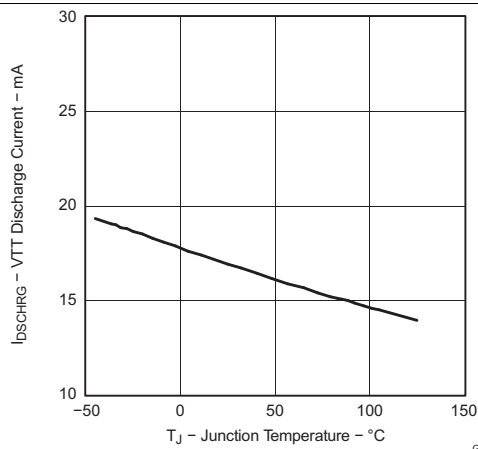

Figure 6. Discharge Current vs Temperature

Typical Characteristics (continued)

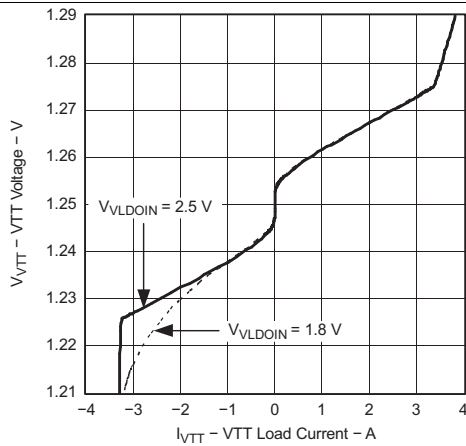

Figure 7. VTT Voltage Load Regulation vs VTT Load Current (DDR)

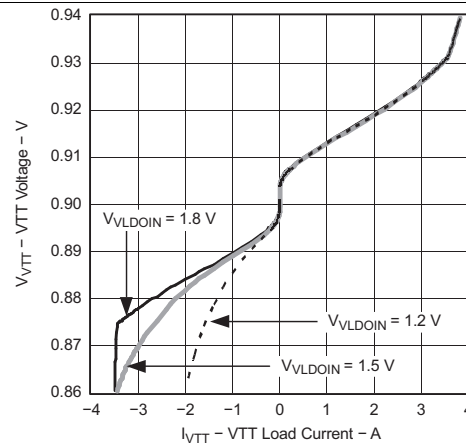

Figure 8. VTT Voltage Load Regulation vs VTT Load Current (DDR2)

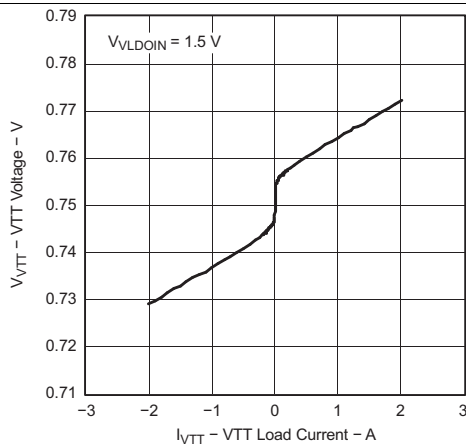

Figure 9. VTT Voltage Load Regulation vs VTT Load Current (DDR3)

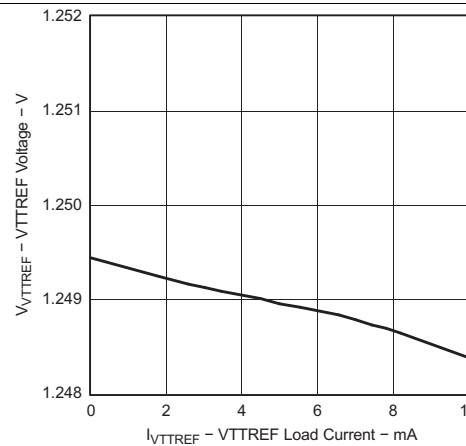

Figure 10. VTTREF Voltage Load Regulation vs VTTREF Load Current (DDR)

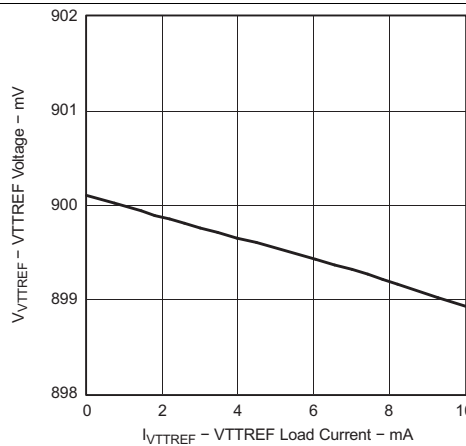

Figure 11. VTTREF Voltage Load Regulation vs VTTREF Load Current (DDR2)

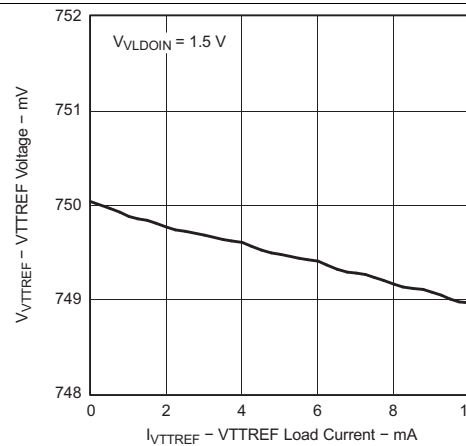

Figure 12. VTTREF Voltage Load Regulation vs VTTREF Load Current (DDR3)

Typical Characteristics (continued)

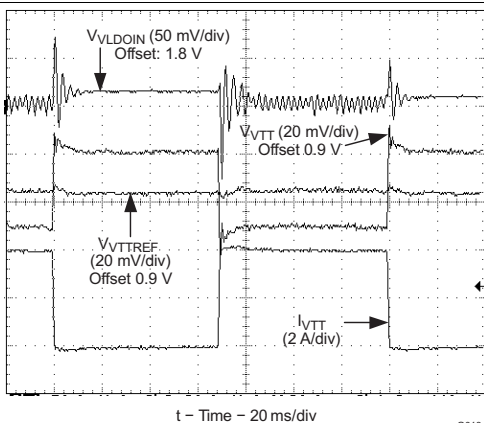

Figure 13. VTT Voltage Load Transient Response

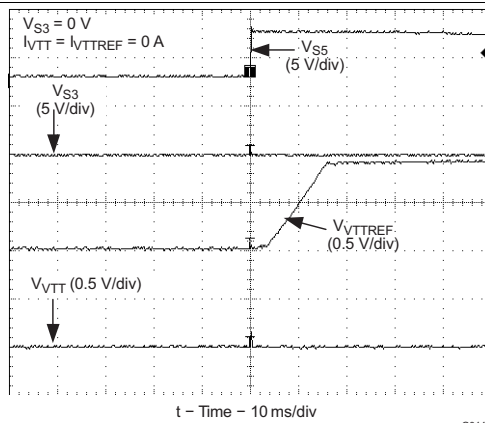

Figure 14. Startup Waveforms S5 Low-to-High

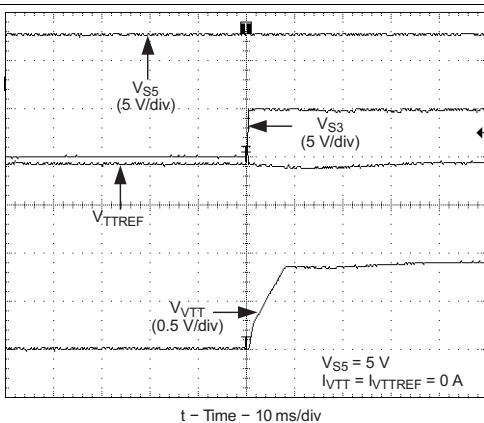

Figure 15. Startup Waveforms S3 Low-to-High

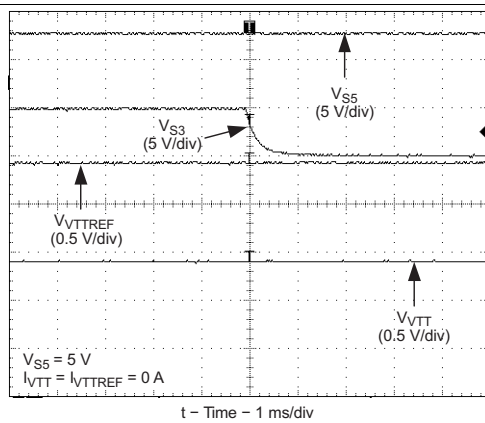

Figure 16. Shutdown Waveforms S3 High-to-Low

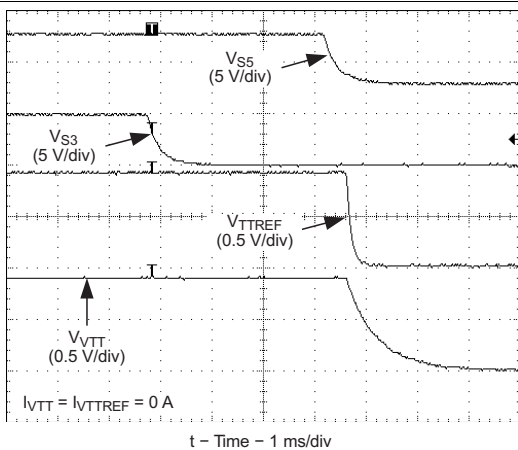

Figure 17. Shutdown Waveforms S3 and S5 High-to-Low

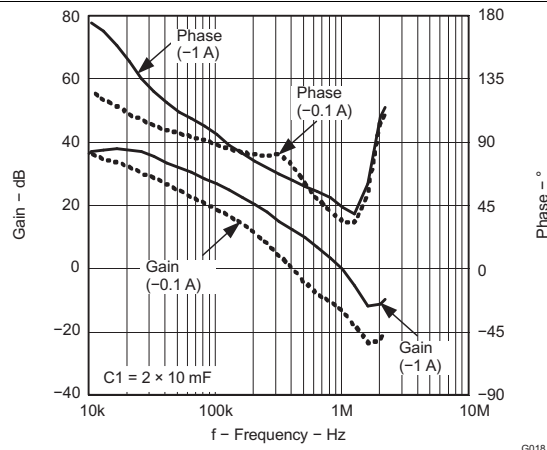
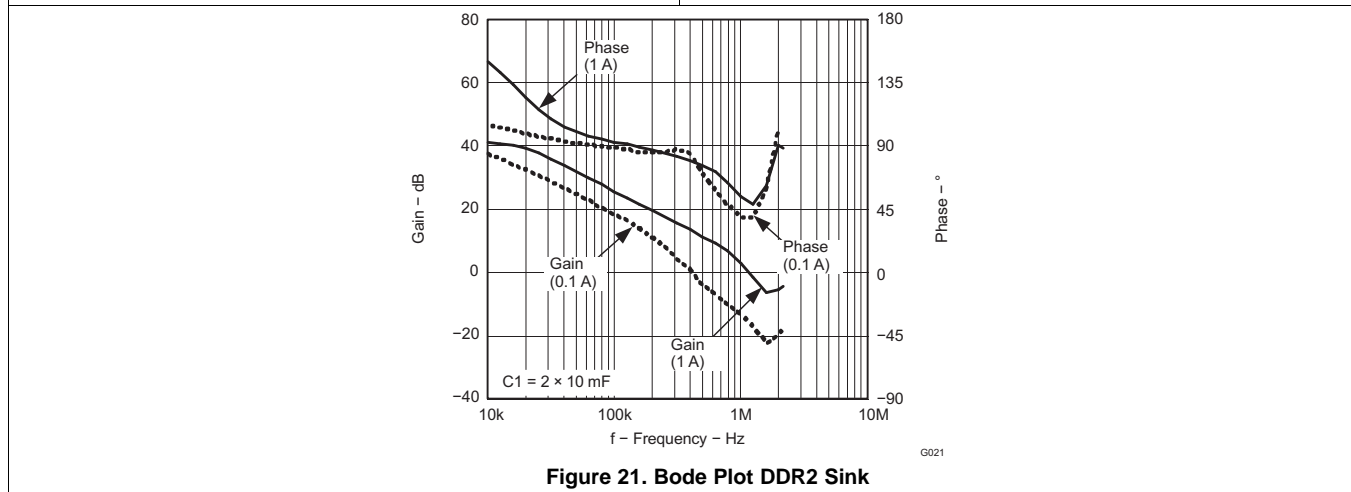
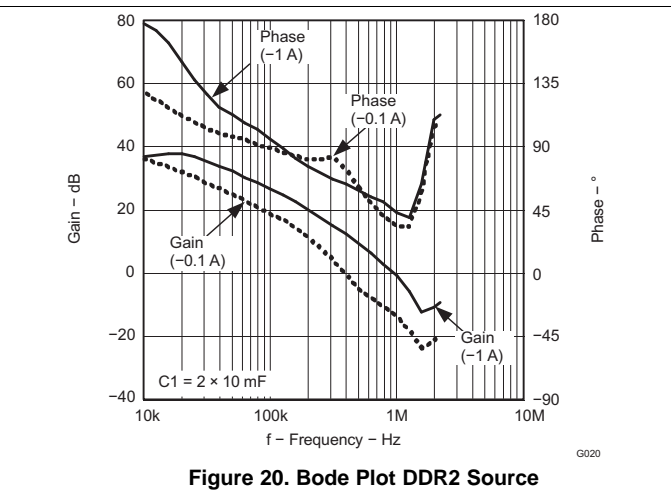
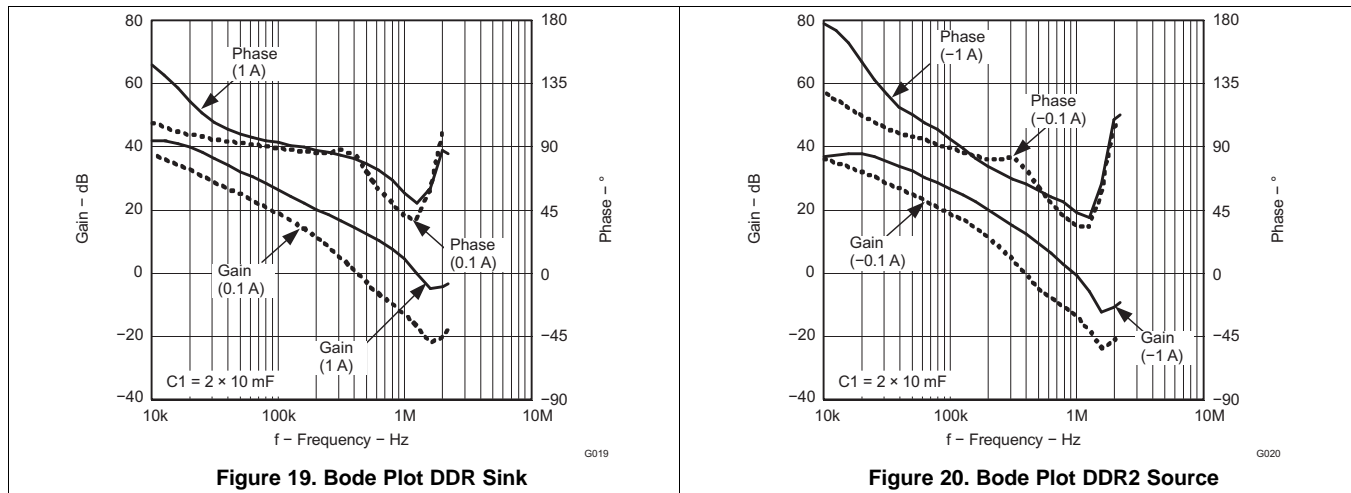

Figure 18. Bode Plot DDR Source

Typical Characteristics (continued)



7 Detailed Description

7.1 Overview

The TPS51100 is a sink / source double data rate (DDR) termination regulator with VTTREF buffered reference output.

7.2 Functional Block Diagram

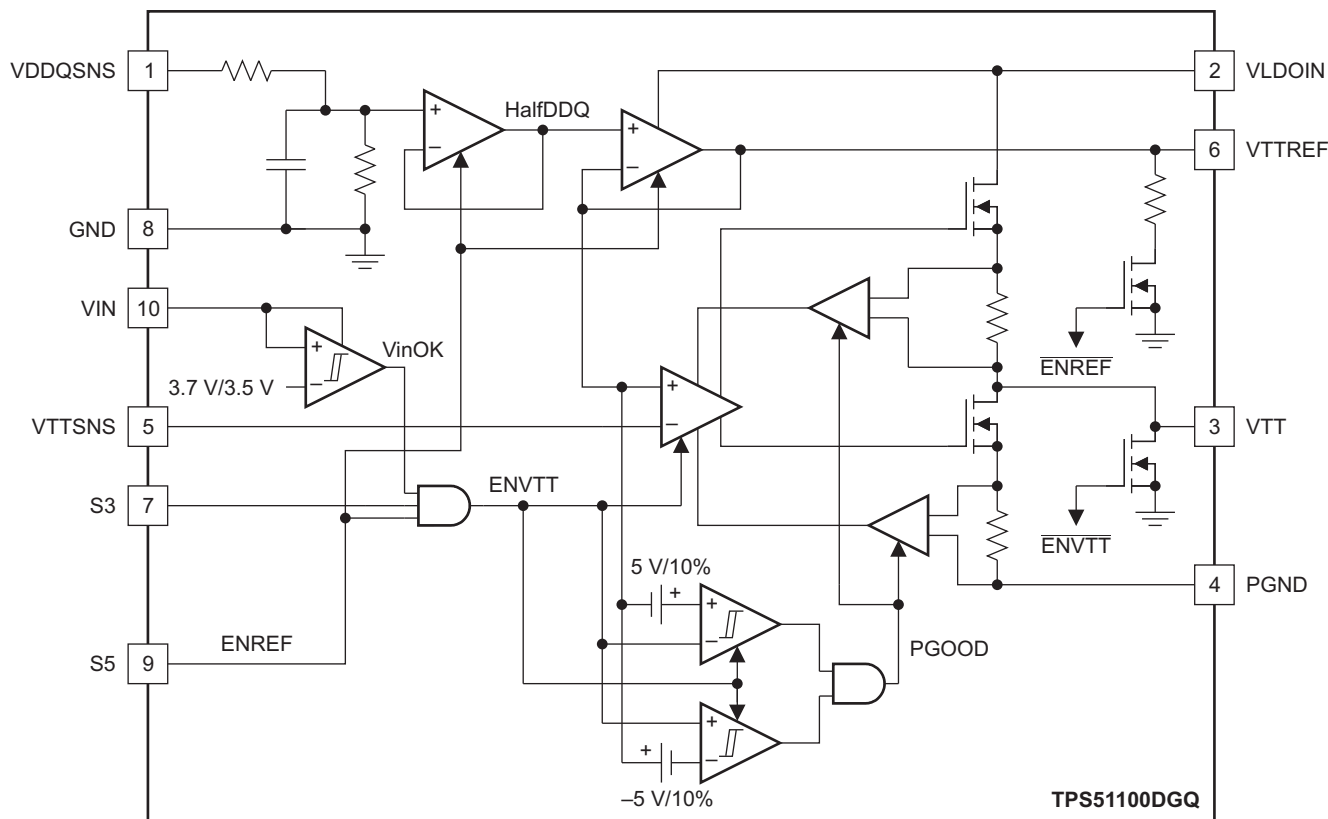

B0319-01

Figure 22. Simplified Block Diagram

7.3 Feature Description

7.3.1 VTT Sink/Source Regulator

The TPS51100 is a 3-A sink/source tracking termination regulator designed specially for low-cost, low-external-components systems where space is at premium, such as notebook PC applications. The TPS51100 integrates a high-performance, low-dropout linear regulator that is capable of sourcing and sinking current up to 3 A. This VTT linear regulator employs an ultimate fast-response feedback loop so that small ceramic capacitors are enough to keep tracking to the VTTREF within ± 40 mV under all conditions, including fast load transient. To achieve tight regulation with minimum effect of trace resistance, a remote sensing terminal, VTTSENS, should be connected to the positive node of the VTT output capacitor(s) as a separate trace from the high-current line from VTT.

7.3.2 VTTREF Regulator

The VTTREF block consists of an on-chip 1/2 divider, low-pass filter (LPF), and buffer. This regulator can source current up to 10 mA. Bypass VTTREF to GND using a 0.1- μ F ceramic capacitor to ensure stable operation.

Feature Description (continued)

7.3.3 Soft-Start

The soft-start function of the VTT is achieved via a current clamp, allowing the output capacitors to be charged with low and constant current that gives linear ramp-up of the output voltage. The current-limit threshold is changed in two stages using an internal powergood signal. When VTT is outside the powergood threshold, the current limit level is 2.2 A. When VTT rises above (VTTREF – 5%) or falls below (VTTREF + 5%), the current limit level switches to 3.8 A. The thresholds are typically VTTREF ±5% (from outside regulation to inside) and ±10% (when it falls outside). The soft-start function is completely symmetrical, and it works not only from GND to VTTREF voltage, but also from VDDQ to VTTREF voltage. Note that the VTT output is in a high-impedance state during the S3 state (S3 = low, S5 = high), and its voltage can be up to VDDQ voltage, depending on the external condition. Note that VTT does not start under a full-load condition.

7.3.4 VTT Current Protection

The LDO has a constant overcurrent limit (OCL) at 3.8 A. This trip point is reduced to 2.2 A before the output voltage comes within ±5% of the target voltage or goes outside of ±10% of the target voltage.

7.3.5 VIN UVLO Protection

For VIN undervoltage lockout (UVLO) protection, the TPS51100 monitors VIN voltage. When the VIN voltage is lower than UVLO threshold voltage, the VTT regulator is shut off. This is a non-latch protection.

7.3.6 Thermal Shutdown

TPS51100 monitors its temperature. If the temperature exceeds the threshold value, typically 160°C, the VTT and VTTREF regulators are shut off. This is also a non-latch protection.

7.4 Device Functional Modes

7.4.1 S5 Control and Soft-Off

The S3 and S5 terminals should be connected to SLP_S3 and SLP_S5 signals, respectively. Both VTTREF and VTT are turned on at the S0 state (S3 = high, S5 = high). VTTREF is kept alive while VTT is turned off and left high-impedance in the S3 state (S3 = low, S5 = high). Both VTT and VTTREF outputs are turned off and discharged to ground through internal MOSFETs during S4/S5 state (both S3 and S5 are low).

Table 1. S3 and S5 Control Table

STATE	S3	S5	VTTREF	VTT
S0	H	H	1	1
S3 ⁽¹⁾	L	H	1	0 (Hi-Z)
S4/S5 ⁽¹⁾	L	L	0 (discharge)	0 (discharge)

(1) In case S3 is forced to H and S5 to L, VTTREF is discharged and VTT is at Hi-Z state. This condition is not recommended.

8 Application and Implementation

NOTE

Information in the following applications sections is not part of the TI component specification, and TI does not warrant its accuracy or completeness. TI's customers are responsible for determining suitability of components for their purposes. Customers should validate and test their design implementation to confirm system functionality.

8.1 Application Information

The TPS51100 is typically used as a sink / source tracking termination regulator, which converter a voltage from VTT.

8.2 Typical Application

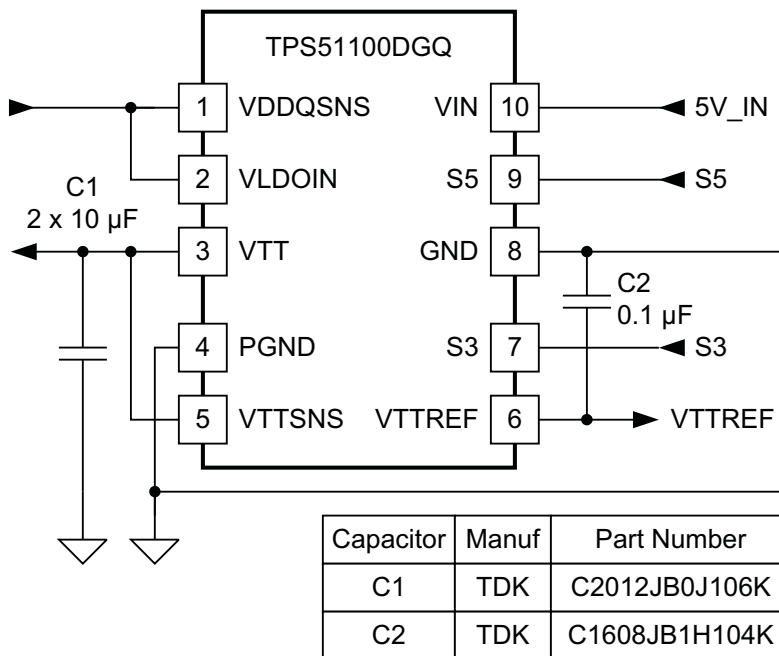

Figure 23. TPS51100 5-V Input / 1.8-V Output Reference Design

8.2.1 Design Requirements

Table 2. Design Parameters

DESIGN PARAMETERS	EXAMPLE VALUE
VIN	4.75 V to 5.25 V
VDDQSNS, VLDOIN	1.8 V
Output Current	±3 A

8.2.2 Detailed Design Procedure

Table 3. Design Specifications

REFERENCE DESIGNATOR	SPECIFICATION	MANUFACTURER	PART NUMBER
C1	10-µf, 6.3-V, X5R, 1212 (0805)	TDK	C2012JB0J106K
C2	0.1-µf, 50-V, X5R, 1608 (0603)	TDK	C1608JB1H104K

8.2.2.1 Output Capacitor

For stable operation, total capacitance of the VTT output terminal can be equal to or greater than 20 μF . Attach two 10- μF ceramic capacitors in parallel to minimize the effect of ESR and ESL. If the ESR is greater than 2 $\text{m}\Omega$, insert an R-C filter between the output and the VTTSENS input to achieve loop stability. The R-C filter time constant should be almost the same or slightly lower than the time constant of the output capacitor and its ESR.

Soft-start duration, t_{SS} , is also a function of this output capacitance. Where $I_{\text{TTOCL}} = 2.2 \text{ A}$ (typ), t_{SS} can be calculated as,

$$t_{\text{SS}} = \left(\frac{C_{\text{OUT}} \times V_{\text{VTT}}}{I_{\text{TTOCL}}} \right) \tag{1}$$

8.2.2.2 Input Capacitor

Depending on the trace impedance between the VLDOIN bulk power supply to the part, transient increase of source current is supplied mostly by the charge from the VLDOIN input capacitor. Use a 10- μF (or more) ceramic capacitor to supply this transient charge. Provide more input capacitance as more output capacitance is used at VTT. In general, use $1/2 C_{\text{OUT}}$ for the input.

8.2.2.3 VIN Capacitor

Add a ceramic capacitor with a value between 1 μF and 4.7 μF placed close to the VIN pin, to stabilize 5 V from any parasitic impedance from the supply.

8.2.3 Application Curves

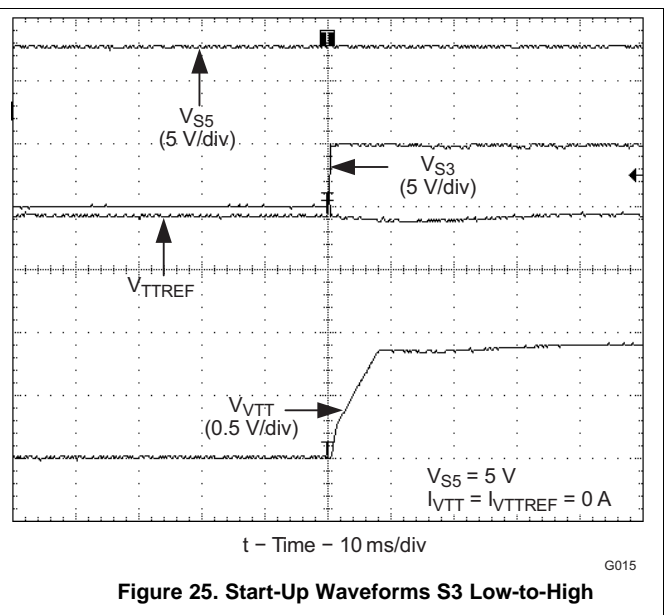
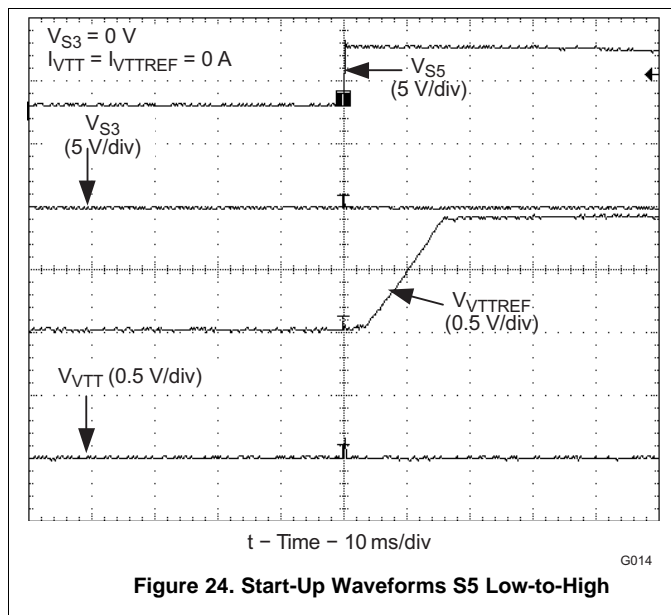

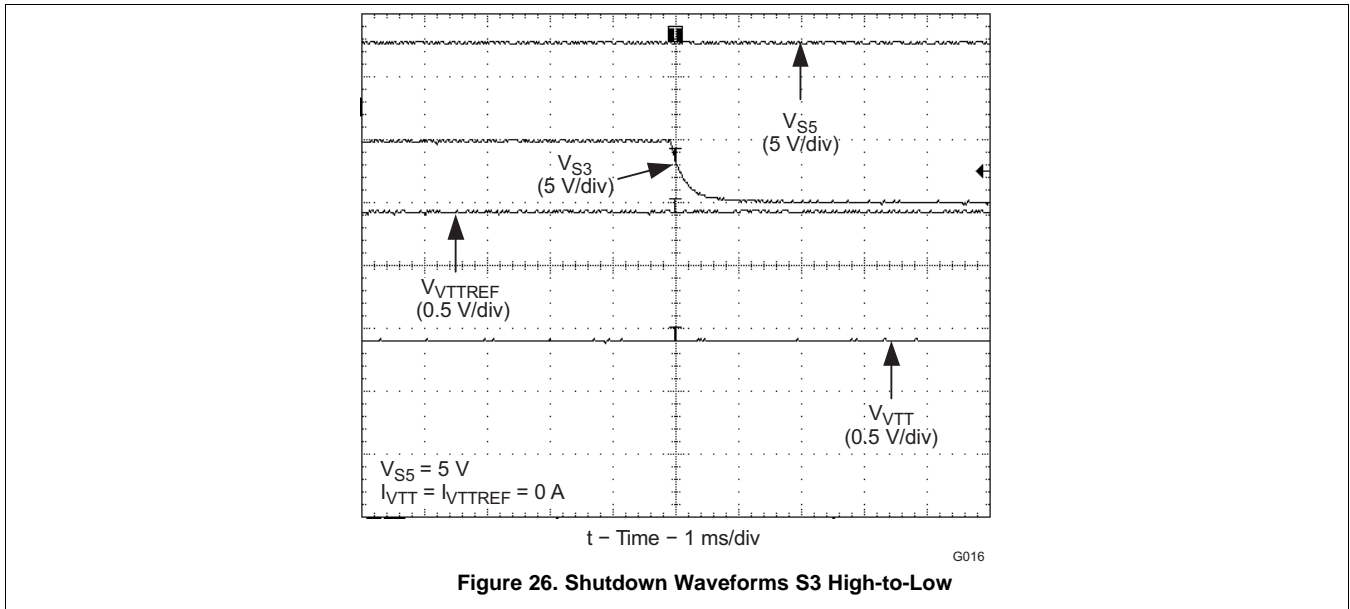

9 Power Supply Recommendations

TPS51100 is designed for a sink / source double data rate (DDR) termination regulator with VTTREF buffered reference output. Supply input voltage (VIN) support voltage from 4.75 V to 5.25 V; VLDOIN input voltage supports from 1.2 V to 3.6 V.

10 Layout

10.1 Layout Guidelines

Consider the following points before the layout of TPS51100 design begins.

- The input bypass capacitor for VLDOIN should be placed to the pin as close as possible with a short and wide connection.
- The output capacitor for VTT should be placed close to the pin with a short and wide connection in order to avoid additional ESR and/or ESL of the trace.
- VTTSNS should be connected to the positive node of VTT output capacitor(s) as a separate trace from the high current power line and is strongly recommended to avoid additional ESR and/or ESL. If it is needed to sense the voltage of the point of the load, it is recommended to attach the output capacitor(s) at that point. Also, it is recommended to minimize any additional ESR and/or ESL of the ground trace between the GND pin and the output capacitor(s).
- Consider adding an LPF at VTTSNS in case the ESR of the VTT output capacitor(s) is larger than 2 mΩ.
- VDDQSNS can be connected separately from VLDOIN. Remember that this sensing potential is the reference voltage of VTTREF. Avoid any noise generative lines.
- The negative node of the VTT output capacitor(s) and the VTTREF capacitor should be tied together, avoiding common impedance to the high-current path of the VTT source/sink current.
- The GND (signal GND) pin node represents the reference potential for the VTTREF and VTT outputs. Connect GND to the negative nodes of the VTT capacitor(s), VTTREF capacitor, and VDDQ capacitor(s) with care to avoid additional ESR and/or ESL. GND and PGND (Power GND) should be isolated, with a single point connection between them.
- In order to remove heat from the package effectively, prepare the thermal land and solder to the package thermal pad. The wide trace of the component-side copper, connected to this thermal land, helps heat spreading. Numerous vias 0.33 mm in diameter connected from the thermal land to the internal/solder-side ground plane(s) should be used to help dissipation.

10.2 Layout Example

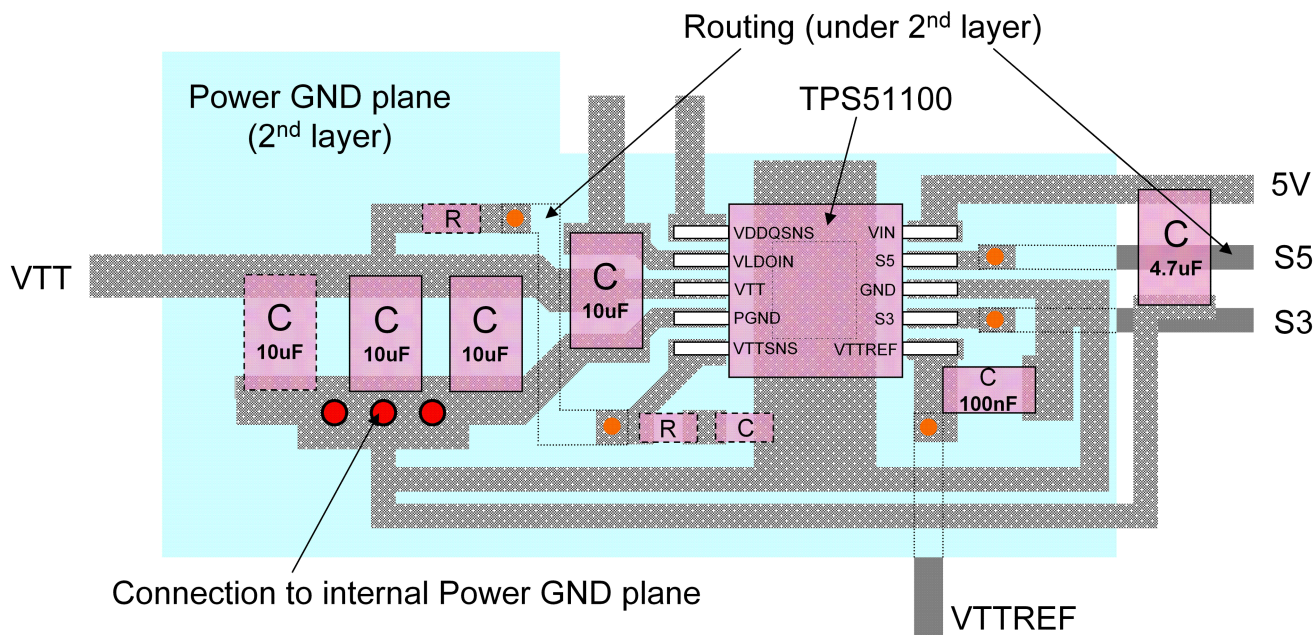

M0118-01

- NOTES:
1. The positive terminal of each output capacitor should be directly connected to VTT of the IC; do not use a VIA.
 2. The negative terminal of each output capacitor should be directly connected to GND of the IC; do not use a VIA.
 3. VIAs
 - VIA between 1st and 2nd layers
 - VIA between 1st and other layers under 2nd
 4. Rs and Cs with dotted outlines are options.

Figure 27. TPS51100 PCB Layout Guideline

10.3 Thermal Considerations

As the TPS51100 is a linear regulator, the VTT current flow in both source and sink directions generates power dissipation from the device. In the source phase, the potential difference between V_{VLDOIN} and V_{VTT} times VTT current becomes the power dissipation, W_{DSRC} .

$$W_{DSRC} = (V_{VLDOIN} - V_{VTT}) \times I_{VTT} \quad (2)$$

In this case, if VLDOIN is connected to an alternative power supply lower than V_{DDQ} voltage, power loss can be decreased.

For the sink phase, VTT voltage is applied across the internal LDO regulator, and the power dissipation, and W_{DSNK} , is calculated by:

$$W_{DSNK} = V_{VTT} \times I_{VTT} \quad (3)$$

Because the device does not sink and source the current at the same time and I_{VTT} varies rapidly with time, the actual power dissipation that must be considered for thermal design is an average over the thermal relaxation duration of the system. Another power consumption is the current used for internal control circuitry from the VIN supply and VLDOIN supply. This can be estimated as 20 mW or less at normal operational conditions. This power must be effectively dissipated from the package. Maximum power dissipation allowed to the package is calculated by,

$$W_{PKG} = \frac{(T_{J(max)} - T_{A(max)})}{\theta_{JA}} \quad (4)$$

where

$T_{J(max)}$ is 125°C

Thermal Considerations (continued)

$T_{A(max)}$ is the maximum ambient temperature in the system

θ_{JA} is the thermal resistance from the silicon junction to the ambient

This thermal resistance strongly depends on the board layout. TPS51100 is assembled in a thermally enhanced PowerPAD package that has an exposed die pad underneath the body. For improved thermal performance, this die pad must be attached to the ground trace via thermal land on the PCB. This ground trace acts as a heat sink/spread. The typical thermal resistance, 57.7°C/W, is achieved based on a 3 mm × 2 mm thermal land with two vias without air flow. It can be improved by using larger thermal land and/or increasing the number of vias. For example, assuming a 3 mm × 3 mm thermal land with four vias without air flow, it is 45.4°C/W. Further information about the PowerPAD package and its recommended board layout is described in the *PowerPAD Thermally Enhanced Package* application report (SLMA002). This document is available at www.ti.com.

11 Device and Documentation Support

11.1 Device Support

11.1.1 Third-Party Products Disclaimer

TI'S PUBLICATION OF INFORMATION REGARDING THIRD-PARTY PRODUCTS OR SERVICES DOES NOT CONSTITUTE AN ENDORSEMENT REGARDING THE SUITABILITY OF SUCH PRODUCTS OR SERVICES OR A WARRANTY, REPRESENTATION OR ENDORSEMENT OF SUCH PRODUCTS OR SERVICES, EITHER ALONE OR IN COMBINATION WITH ANY TI PRODUCT OR SERVICE.

11.2 Trademarks

PowerPAD is a trademark of Texas Instruments.
All other trademarks are the property of their respective owners.

11.3 Electrostatic Discharge Caution



These devices have limited built-in ESD protection. The leads should be shorted together or the device placed in conductive foam during storage or handling to prevent electrostatic damage to the MOS gates.

11.4 Glossary

[SLYZ022](#) — *TI Glossary*.

This glossary lists and explains terms, acronyms, and definitions.

12 Mechanical, Packaging, and Orderable Information

The following pages include mechanical, packaging, and orderable information. This information is the most current data available for the designated devices. This data is subject to change without notice and revision of this document. For browser-based versions of this data sheet, refer to the left-hand navigation.

PACKAGING INFORMATION

Orderable part number	Status (1)	Material type (2)	Package Pins	Package qty Carrier	RoHS (3)	Lead finish/ Ball material (4)	MSL rating/ Peak reflow (5)	Op temp (°C)	Part marking (6)
TPS51100DGQ	Active	Production	HVSSOP (DGQ) 10	80 TUBE	Yes	NIPDAU NIPDAUAG	Level-1-260C-UNLIM	-40 to 85	51100
TPS51100DGQ.A	Active	Production	HVSSOP (DGQ) 10	80 TUBE	Yes	NIPDAU	Level-1-260C-UNLIM	-40 to 85	51100
TPS51100DGQ.B	Active	Production	HVSSOP (DGQ) 10	80 TUBE	Yes	NIPDAU	Level-1-260C-UNLIM	-40 to 85	51100
TPS51100DGQG4	Active	Production	HVSSOP (DGQ) 10	80 TUBE	Yes	NIPDAU	Level-1-260C-UNLIM	-40 to 85	51100
TPS51100DGQR	Active	Production	HVSSOP (DGQ) 10	2500 LARGE T&R	Yes	NIPDAU NIPDAUAG	Level-1-260C-UNLIM	-40 to 85	51100
TPS51100DGQR.A	Active	Production	HVSSOP (DGQ) 10	2500 LARGE T&R	Yes	NIPDAU	Level-1-260C-UNLIM	-40 to 85	51100
TPS51100DGQR.B	Active	Production	HVSSOP (DGQ) 10	2500 LARGE T&R	Yes	NIPDAU	Level-1-260C-UNLIM	-40 to 85	51100
TPS51100DGQRG4	Active	Production	HVSSOP (DGQ) 10	2500 LARGE T&R	Yes	NIPDAU	Level-1-260C-UNLIM	-40 to 85	51100

(1) **Status:** For more details on status, see our [product life cycle](#).

(2) **Material type:** When designated, preproduction parts are prototypes/experimental devices, and are not yet approved or released for full production. Testing and final process, including without limitation quality assurance, reliability performance testing, and/or process qualification, may not yet be complete, and this item is subject to further changes or possible discontinuation. If available for ordering, purchases will be subject to an additional waiver at checkout, and are intended for early internal evaluation purposes only. These items are sold without warranties of any kind.

(3) **RoHS values:** Yes, No, RoHS Exempt. See the [TI RoHS Statement](#) for additional information and value definition.

(4) **Lead finish/Ball material:** Parts may have multiple material finish options. Finish options are separated by a vertical ruled line. Lead finish/Ball material values may wrap to two lines if the finish value exceeds the maximum column width.

(5) **MSL rating/Peak reflow:** The moisture sensitivity level ratings and peak solder (reflow) temperatures. In the event that a part has multiple moisture sensitivity ratings, only the lowest level per JEDEC standards is shown. Refer to the shipping label for the actual reflow temperature that will be used to mount the part to the printed circuit board.

(6) **Part marking:** There may be an additional marking, which relates to the logo, the lot trace code information, or the environmental category of the part.

Multiple part markings will be inside parentheses. Only one part marking contained in parentheses and separated by a "-" will appear on a part. If a line is indented then it is a continuation of the previous line and the two combined represent the entire part marking for that device.

Important Information and Disclaimer:The information provided on this page represents TI's knowledge and belief as of the date that it is provided. TI bases its knowledge and belief on information provided by third parties, and makes no representation or warranty as to the accuracy of such information. Efforts are underway to better integrate information from third parties. TI has taken and continues to take reasonable steps to provide representative and accurate information but may not have conducted destructive testing or chemical analysis on incoming materials and chemicals. TI and TI suppliers consider certain information to be proprietary, and thus CAS numbers and other limited information may not be available for release.

In no event shall TI's liability arising out of such information exceed the total purchase price of the TI part(s) at issue in this document sold by TI to Customer on an annual basis.

TAPE AND REEL INFORMATION

QUADRANT ASSIGNMENTS FOR PIN 1 ORIENTATION IN TAPE

*All dimensions are nominal

Device	Package Type	Package Drawing	Pins	SPQ	Reel Diameter (mm)	Reel Width W1 (mm)	A0 (mm)	B0 (mm)	K0 (mm)	P1 (mm)	W (mm)	Pin1 Quadrant
TPS51100DGQR	HVSSOP	DGQ	10	2500	330.0	12.4	5.3	3.4	1.4	8.0	12.0	Q1
TPS51100DGQR	HVSSOP	DGQ	10	2500	330.0	12.4	5.3	3.3	1.3	8.0	12.0	Q1

TAPE AND REEL BOX DIMENSIONS

*All dimensions are nominal

Device	Package Type	Package Drawing	Pins	SPQ	Length (mm)	Width (mm)	Height (mm)
TPS51100DGQR	HVSSOP	DGQ	10	2500	364.0	364.0	27.0
TPS51100DGQR	HVSSOP	DGQ	10	2500	346.0	346.0	35.0

TUBE

*All dimensions are nominal

Device	Package Name	Package Type	Pins	SPQ	L (mm)	W (mm)	T (μm)	B (mm)
TPS51100DGQ	DGQ	HVSSOP	10	80	330	6.55	500	2.88
TPS51100DGQ	DGQ	HVSSOP	10	80	322	6.55	1000	3.01
TPS51100DGQ.A	DGQ	HVSSOP	10	80	322	6.55	1000	3.01
TPS51100DGQ.A	DGQ	HVSSOP	10	80	330	6.55	500	2.88
TPS51100DGQ.B	DGQ	HVSSOP	10	80	322	6.55	1000	3.01
TPS51100DGQ.B	DGQ	HVSSOP	10	80	330	6.55	500	2.88
TPS51100DGQG4	DGQ	HVSSOP	10	80	322	6.55	1000	3.01
TPS51100DGQG4	DGQ	HVSSOP	10	80	330	6.55	500	2.88

GENERIC PACKAGE VIEW

DGQ 10

PowerPAD™ HVSSOP - 1.1 mm max height

3 x 3, 0.5 mm pitch

PLASTIC SMALL OUTLINE

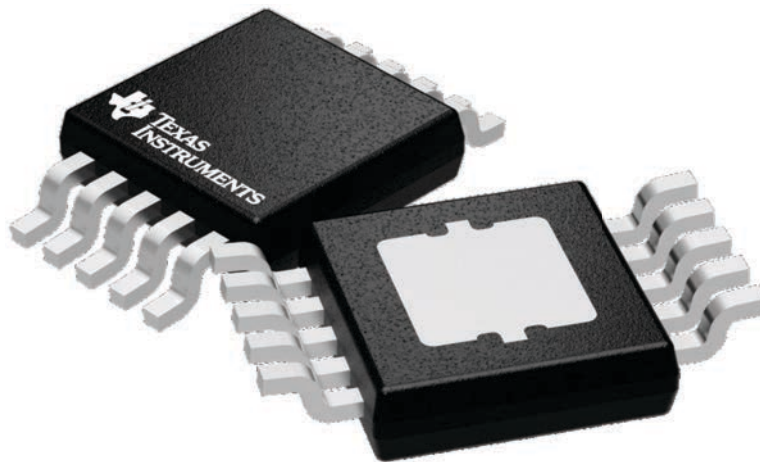

Images above are just a representation of the package family, actual package may vary.
Refer to the product data sheet for package details.

4224775/A

DGQ0010D



PACKAGE OUTLINE

PowerPAD™ - 1.1 mm max height

PLASTIC SMALL OUTLINE

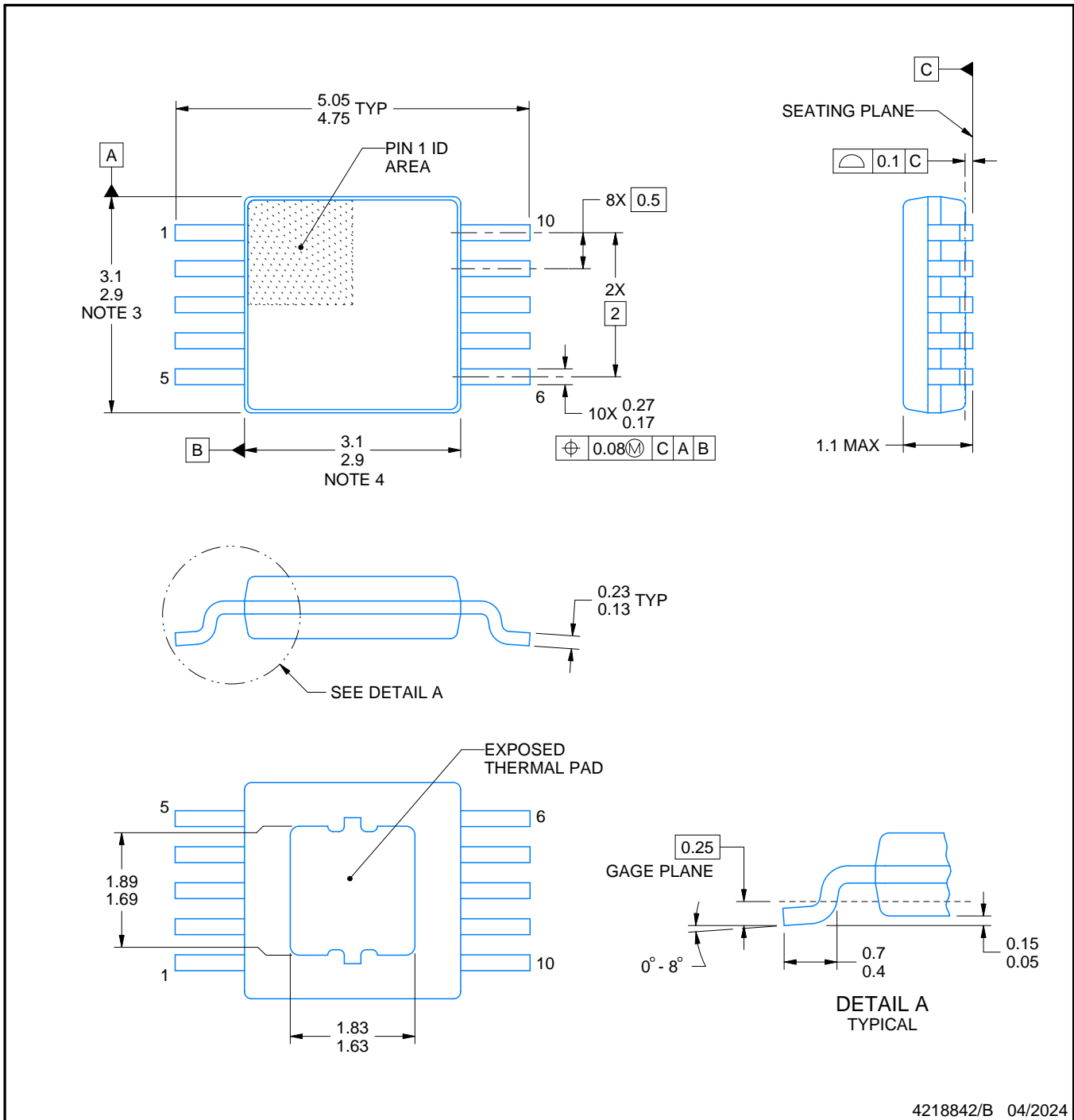

4218842/B 04/2024

PowerPAD is a trademark of Texas Instruments.

NOTES:

1. All linear dimensions are in millimeters. Any dimensions in parenthesis are for reference only. Dimensioning and tolerancing per ASME Y14.5M.
2. This drawing is subject to change without notice.
3. This dimension does not include mold flash, protrusions, or gate burrs. Mold flash, protrusions, or gate burrs shall not exceed 0.15 mm per side.
4. This dimension does not include interlead flash. Interlead flash shall not exceed 0.25 mm per side.
5. Reference JEDEC registration MO-187, variation BA-T.

EXAMPLE BOARD LAYOUT

DGQ0010D

PowerPAD™ - 1.1 mm max height

PLASTIC SMALL OUTLINE

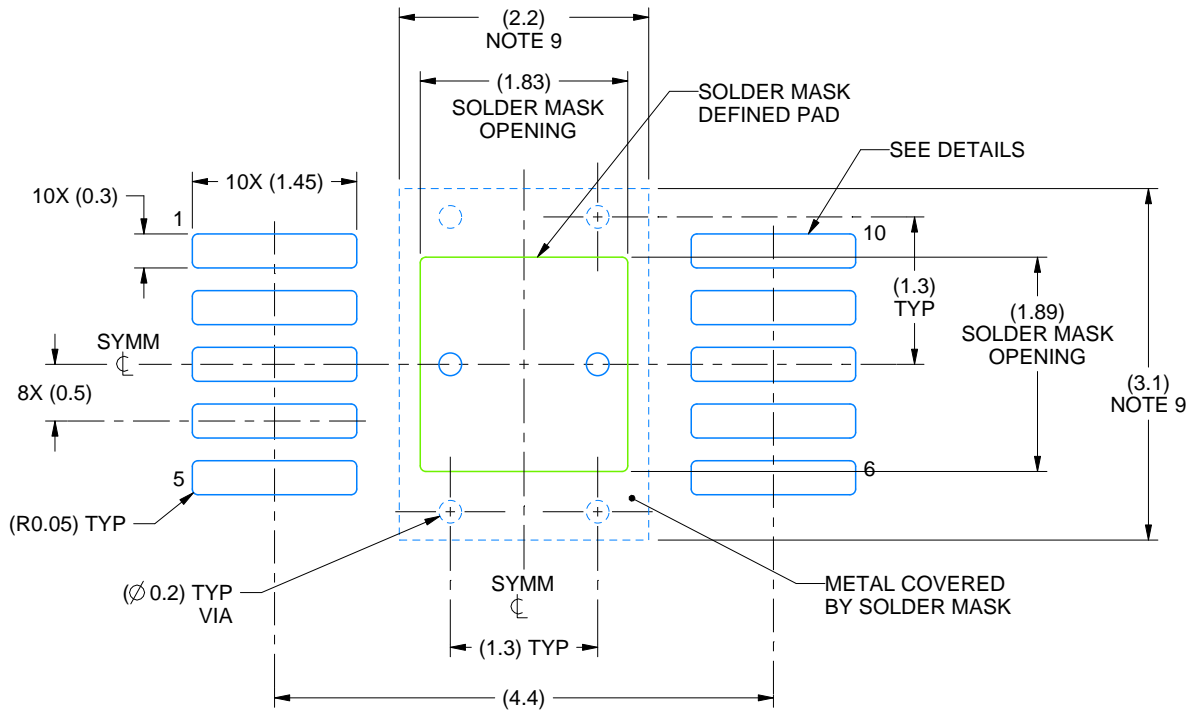

LAND PATTERN EXAMPLE
SCALE:15X

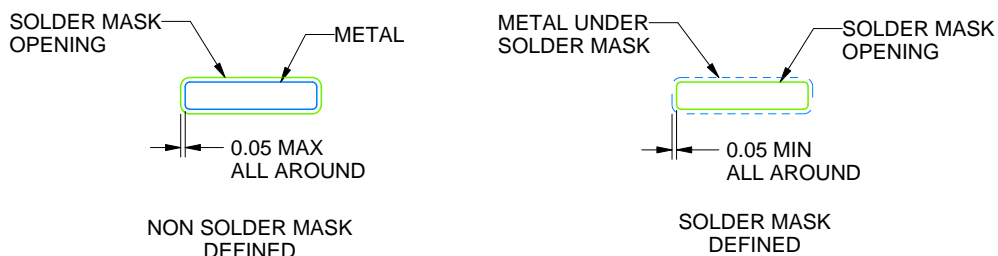

SOLDER MASK DETAILS

4218842/B 04/2024

NOTES: (continued)

6. Publication IPC-7351 may have alternate designs.
7. Solder mask tolerances between and around signal pads can vary based on board fabrication site.
8. This package is designed to be soldered to a thermal pad on the board. For more information, see Texas Instruments literature numbers SLMA002 (www.ti.com/lit/slma002) and SLMA004 (www.ti.com/lit/slma004).
9. Size of metal pad may vary due to creepage requirement.

EXAMPLE STENCIL DESIGN

DGQ0010D

PowerPAD™ - 1.1 mm max height

PLASTIC SMALL OUTLINE

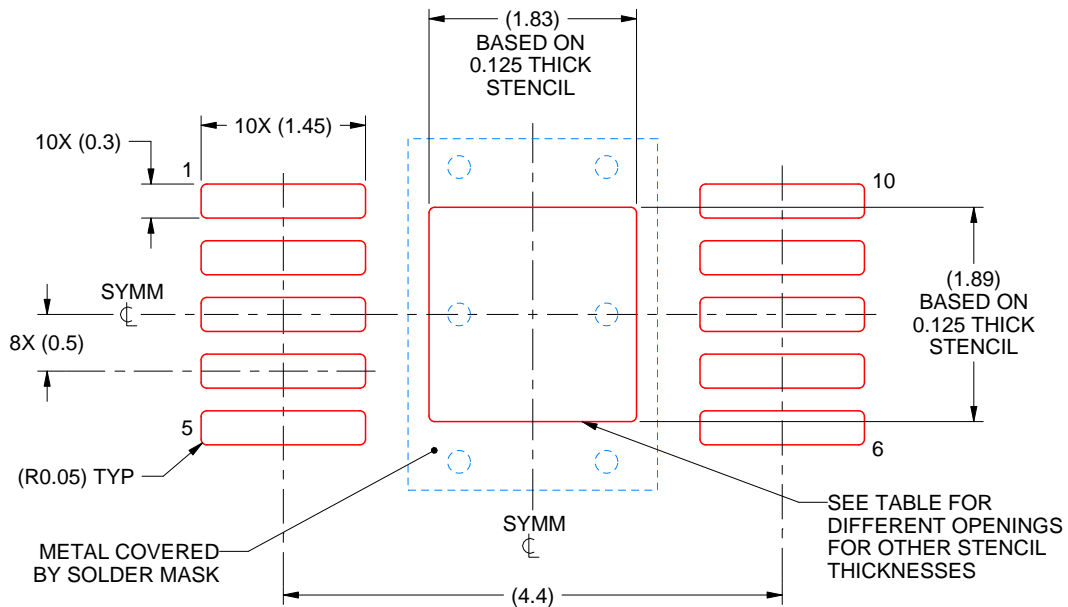

SOLDER PASTE EXAMPLE
EXPOSED PAD
100% PRINTED SOLDER COVERAGE BY AREA
SCALE:15X

STENCIL THICKNESS	SOLDER STENCIL OPENING
0.1	2.05 X 2.11
0.125	1.83 X 1.89 (SHOWN)
0.150	1.67 X 1.73
0.175	1.55 X 1.60

4218842/B 04/2024

NOTES: (continued)

10. Laser cutting apertures with trapezoidal walls and rounded corners may offer better paste release. IPC-7525 may have alternate design recommendations.
11. Board assembly site may have different recommendations for stencil design.

IMPORTANT NOTICE AND DISCLAIMER

TI PROVIDES TECHNICAL AND RELIABILITY DATA (INCLUDING DATASHEETS), DESIGN RESOURCES (INCLUDING REFERENCE DESIGNS), APPLICATION OR OTHER DESIGN ADVICE, WEB TOOLS, SAFETY INFORMATION, AND OTHER RESOURCES "AS IS" AND WITH ALL FAULTS, AND DISCLAIMS ALL WARRANTIES, EXPRESS AND IMPLIED, INCLUDING WITHOUT LIMITATION ANY IMPLIED WARRANTIES OF MERCHANTABILITY, FITNESS FOR A PARTICULAR PURPOSE OR NON-INFRINGEMENT OF THIRD PARTY INTELLECTUAL PROPERTY RIGHTS.

These resources are intended for skilled developers designing with TI products. You are solely responsible for (1) selecting the appropriate TI products for your application, (2) designing, validating and testing your application, and (3) ensuring your application meets applicable standards, and any other safety, security, regulatory or other requirements.

These resources are subject to change without notice. TI grants you permission to use these resources only for development of an application that uses the TI products described in the resource. Other reproduction and display of these resources is prohibited. No license is granted to any other TI intellectual property right or to any third party intellectual property right. TI disclaims responsibility for, and you fully indemnify TI and its representatives against any claims, damages, costs, losses, and liabilities arising out of your use of these resources.

TI's products are provided subject to [TI's Terms of Sale](#), [TI's General Quality Guidelines](#), or other applicable terms available either on [ti.com](#) or provided in conjunction with such TI products. TI's provision of these resources does not expand or otherwise alter TI's applicable warranties or warranty disclaimers for TI products. Unless TI explicitly designates a product as custom or customer-specified, TI products are standard, catalog, general purpose devices.

TI objects to and rejects any additional or different terms you may propose.

Copyright © 2025, Texas Instruments Incorporated

Last updated 10/2025