

采用 6 引脚 SOT-23 封装的 TPS56120x 4.5V 至 17V 输入、1A 同步降压稳压器

1 特性

- TPS561201 和 TPS561208 1A 转换器集成了 140mΩ 和 84mΩ FET
- {1}D-CAP2{2} 模式控制，用于快速瞬态响应
- 输入电压范围：4.5V 至 17V
- 输出电压范围：0.76V 至 7V
- 脉冲跳跃模式 (TPS561201) 或持续电流模式 (TPS561208)
- 580kHz 开关频率
- 低关断电流 (低于 10μA)
- 2% 反馈电压精度 (25°C)
- 从预偏置输出电压启动
- 逐周期过流限制
- 断续模式过流保护
- 非锁存欠压保护 (UVP) 和热关断 (TSD) 保护
- 固定软启动：1.0ms
- 使用 TPS56120x 并借助 WEBENCH® 电源设计器 创建定制设计方案

2 应用

- 数字电视电源
- 高清蓝光™光盘播放器
- 网络家庭终端设备

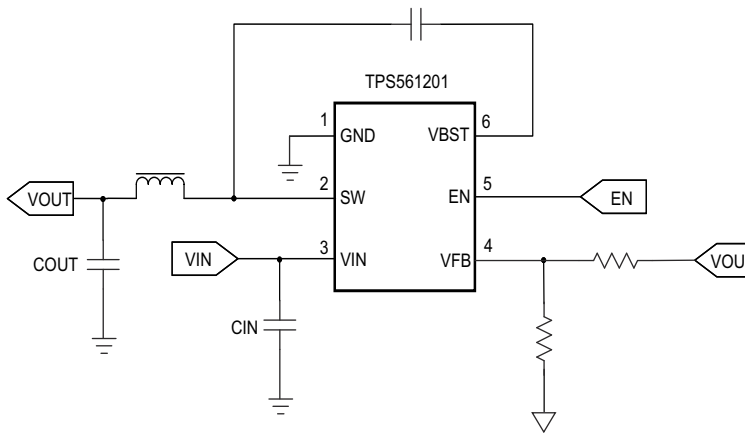

简化原理图

- 数字机顶盒 (STB)
- 监控

3 说明

TPS561201 和 TPS561208 是采用 SOT-23 封装的简单易用型 1A 同步降压转换器。

此器件被优化为使用尽可能少的外部组件即可运行，并且可以实现低待机电流。

这些开关模式电源 (SMPS) 器件采用 D-CAP2 模式控制，从而提供快速瞬态响应，并且在无需外部补偿组件的情况下支持专用聚合物等低等效串联电阻 (ESR) 输出电容器以及超低 ESR 陶瓷电容器。

TPS561201 可在脉冲跳跃模式下运行，从而能在轻载运行期间保持高效率。TPS561201 和 TPS561208 可提供 6 引脚 1.6 × 2.9 (mm) SOT (DDC) 封装，额定结温范围为 -40°C 至 125°C。

器件信息

器件型号	封装 ⁽¹⁾	封装尺寸 (标称值)
TPS561201	SOT (6)	1.60mm x 2.90mm
TPS561208		

(1) 如需了解所有可用封装，请参阅数据表末尾的可订购产品附录。

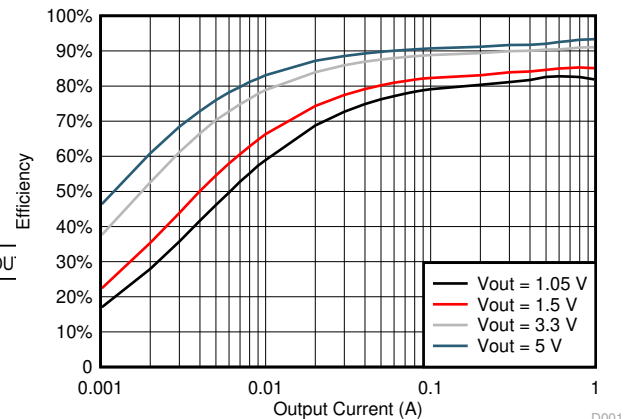

TPS561201 效率

D001



Table of Contents

1 特性	1	7.4 Device Functional Modes.....	10
2 应用	1	8 Application and Implementation	12
3 说明	1	8.1 Application Information.....	12
4 Revision History	2	8.2 Typical Application.....	12
5 Pin Configuration and Functions	3	9 Power Supply Recommendations	18
Pin Functions.....	3	10 Layout	19
6 Specifications	4	10.1 Layout Guidelines.....	19
6.1 Absolute Maximum Ratings.....	4	10.2 Layout Example.....	19
6.2 ESD Ratings.....	4	11 Device and Documentation Support	20
6.3 Recommended Operating Conditions.....	4	11.1 Device Support.....	20
6.4 Thermal Information.....	4	11.2 Receiving Notification of Documentation Updates..	20
6.5 Electrical Characteristics.....	5	11.3 Support Resources.....	20
6.6 Typical Characteristics.....	6	11.4 Trademarks.....	20
7 Detailed Description	9	11.5 Electrostatic Discharge Caution.....	20
7.1 Overview.....	9	11.6 Glossary.....	20
7.2 Functional Block Diagram.....	9	12 Mechanical, Packaging, and Orderable Information	20
7.3 Feature Description.....	9		

4 Revision History

Changes from Revision * (April 2017) to Revision A (September 2020)	Page
• 更新了整个文档的表、图和交叉参考的编号格式.....	1
• Replaced 图 6-5 and 图 6-6	6

5 Pin Configuration and Functions



图 5-1. 6-Pin SOTDDC Package (Top View)

Pin Functions

PIN		DESCRIPTION
NAME	NO.	
GND	1	Ground pin source terminal of low-side power NFET as well as the ground terminal for controller circuit. Connect sensitive VFB to this GND at a single point.
SW	2	Switch node connection between high-side NFET and low-side NFET
VIN	3	Input voltage supply pin. The drain terminal of high-side power NFET
VFB	4	Converter feedback input. Connect to output voltage with feedback resistor divider.
EN	5	Enable input control. Active high and must be pulled up to enable the device.
VBST	6	Supply input for the high-side NFET gate drive circuit. Connect 0.1- μ F capacitor between VBST and SW pins.

6 Specifications

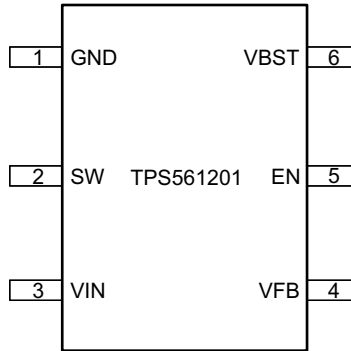
6.1 Absolute Maximum Ratings

over operating free-air temperature range (unless otherwise noted)⁽¹⁾

		MIN	MAX	UNIT
Input voltage	VIN, EN	- 0.3	19	V
	VBST	- 0.3	25	V
	VBST (10-ns transient)	- 0.3	27	V
	VBST (vs SW)	- 0.3	6.5	V
	VFB	- 0.3	6.5	V
	SW	- 2	19	V
	SW (10 ns transient)	- 3.5	21	V
Operating junction temperature, T _J		- 40	150	°C
Storage temperature, T _{stg}		- 55	150	°C

- (1) Stresses beyond those listed under *Absolute Maximum Ratings* may cause permanent damage to the device. These are stress ratings only, which do not imply functional operation of the device at these or any other conditions beyond those indicated under *Recommended Operating Conditions*. Exposure to absolute-maximum-rated conditions for extended periods may affect device reliability.

6.2 ESD Ratings

			VALUE	UNIT
V _(ESD)	Electrostatic discharge	Human-body model (HBM), per ANSI/ESDA/JEDEC JS-001 ⁽¹⁾	±3000	V
		Charged-device model (CDM), per JEDEC specification JESD22-C101 ⁽²⁾	±1500	

- (1) JEDEC document JEP155 states that 500-V HBM allows safe manufacturing with a standard ESD control process.

- (2) JEDEC document JEP157 states that 250-V CDM allows safe manufacturing with a standard ESD control process.

6.3 Recommended Operating Conditions

over operating free-air temperature range (unless otherwise noted)

		MIN	MAX	UNIT	
V _{IN}	Supply input voltage	4.5	17	V	
V _I	Input voltage	VBST	- 0.1	23	V
		VBST (10-ns transient)	- 0.1	26	
		VBST(vs SW)	- 0.1	6.0	
		EN	- 0.1	17	
		VFB	- 0.1	5.5	
		SW	- 1.8	17	
		SW (10 ns transient)	- 3.5	20	
T _J	Operating junction temperature	- 40	125	°C	

6.4 Thermal Information

THERMAL METRIC ⁽¹⁾		TPS561201 and TPS561208	UNIT
		DDC (SOT)	
		6 PINS	
R _{θJA}	Junction-to-ambient thermal resistance	90.8	°C/W
R _{θJC(top)}	Junction-to-case (top) thermal resistance	42.3	°C/W
R _{θJB}	Junction-to-board thermal resistance	16.3	°C/W

THERMAL METRIC ⁽¹⁾		TPS561201 and TPS561208		UNIT
		DDC (SOT)		
		6 PINS		
ψ_{JT}	Junction-to-top characterization parameter	2.6		°C/W
ψ_{JB}	Junction-to-board characterization parameter	16.3		°C/W

(1) For more information about traditional and new thermal metrics, see the *Semiconductor and IC Package Thermal Metrics* application report, [SPRA953](#).

6.5 Electrical Characteristics

$T_J = -40^{\circ}\text{C}$ to 125°C , $V = 12\text{ V}$ (unless otherwise noted)

PARAMETER		TEST CONDITIONS	MIN	TYP	MAX	UNIT
SUPPLY CURRENT						
I_{VIN}	Operating - non-switching supply current	V_{IN} current, EN = 5 V, VFB = 0.8 V	TPS561201	380	520	μA
			TPS561208	590	750	
$I_{VINSNDN}$	Shutdown supply current	V_{IN} current, EN = 0 V		1	10	μA
LOGIC THRESHOLD						
V_{ENH}	EN high-level input voltage	EN	1.6			V
V_{ENL}	EN low-level input voltage	EN			0.8	V
R_{EN}	EN pin resistance to GND	$V_{EN} = 12\text{ V}$	225	400	900	$\text{k}\Omega$
VFB VOLTAGE AND DISCHARGE RESISTANCE						
	VFB threshold voltage	$V_O = 1.05\text{ V}$, $I_O = 10\text{ mA}$, Eco-mode™ operation		774		mV
V_{FBTH}	VFB threshold voltage	$V_O = 1.05\text{ V}$, continuous mode operation	749	768	787	mV
I_{VFB}	VFB input current	$V_{FB} = 0.8\text{ V}$		0	± 0.1	μA
MOSFET						
$R_{DS(on)h}$	High-side switch resistance	$T_A = 25^{\circ}\text{C}$, $V_{BST} - SW = 5.5\text{ V}$		140		$\text{m}\Omega$
$R_{DS(on)l}$	Low-side switch resistance	$T_A = 25^{\circ}\text{C}$		84		$\text{m}\Omega$
CURRENT LIMIT						
I_{ocl}	Current limit	DC current, $V_{OUT} = 1.05\text{ V}$, $L1 = 2.2\text{ }\mu\text{H}$	1.2	1.6	2.0	A
THERMAL SHUTDOWN						
T_{SDN}	Thermal shutdown threshold ⁽¹⁾	Shutdown temperature		160		°C
		Hysteresis		25		
ON-TIME TIMER CONTROL						
$t_{OFF(MIN)}$	Minimum off time	VFB = 0.5 V		220	310	ns
SOFT START						
t_{ss}	Soft-start time	Internal soft-start time		1.0		ms
	Frequency					
F_{sw}	Switching frequency	$V_{IN} = 12\text{ V}$, $V_O = 1.05\text{ V}$, FCCM mode		580		kHz
OUTPUT UNDERVOLTAGE AND OVERVOLTAGE PROTECTION						
V_{UVP}	Output UVP threshold	Hiccup detect ($H > L$)		65%		
T_{HICCUP_WAIT}	Hiccup wait time			1.8		ms
T_{HICCUP_RE}	Hiccup time before restart			15		ms
UVLO						

$T_J = -40^{\circ}\text{C}$ to 125°C , $V = 12\text{ V}$ (unless otherwise noted)

PARAMETER		TEST CONDITIONS	MIN	TYP	MAX	UNIT
UVLO	UVLO threshold	Wake up VIN voltage		4.0	4.3	V
		Shut down VIN voltage	3.3	3.6		
		Hysteresis VIN voltage		0.4		

(1) Not production tested

6.6 Typical Characteristics

$V_{IN} = 12\text{ V}$ (unless otherwise noted)



图 6-1. TPS561201 Supply Current vs Junction Temperature



图 6-2. VFB Voltage vs Junction Temperature

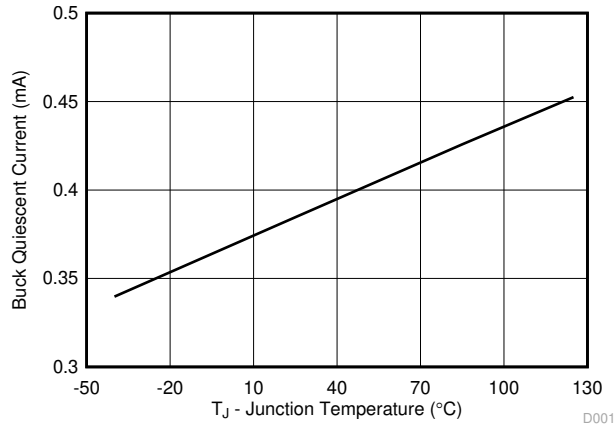

图 6-3. EN Pin UVLO Low Voltage vs Junction Temperature

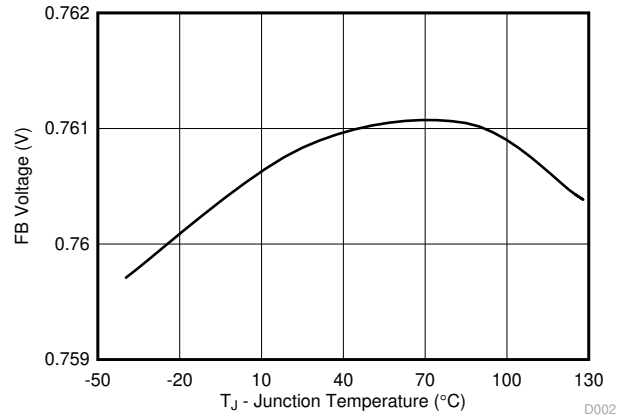

图 6-4. EN Pin UVLO High Voltage vs Junction Temperature

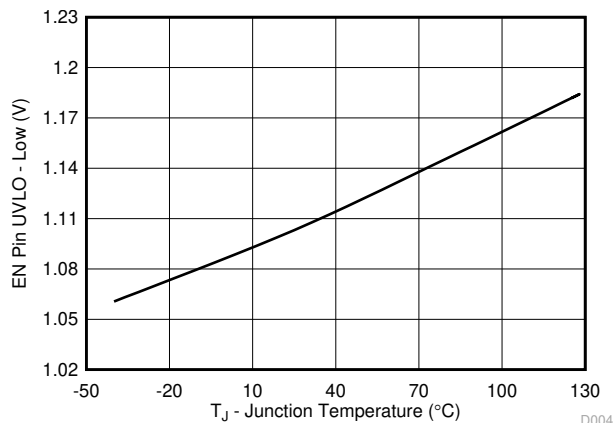

图 6-5. High-Side R_{ds-on} vs Junction Temperature

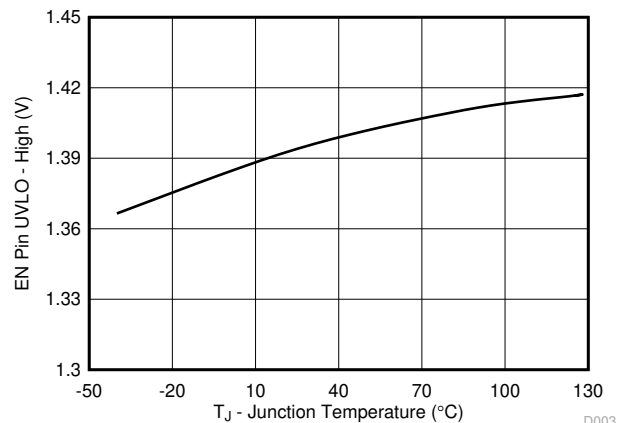

图 6-6. Low-Side R_{ds-on} vs Junction Temperature

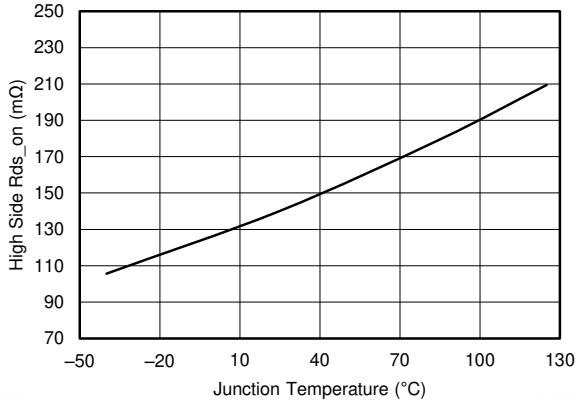

图 6-7. TPS561208 Switching Frequency vs Input Voltage

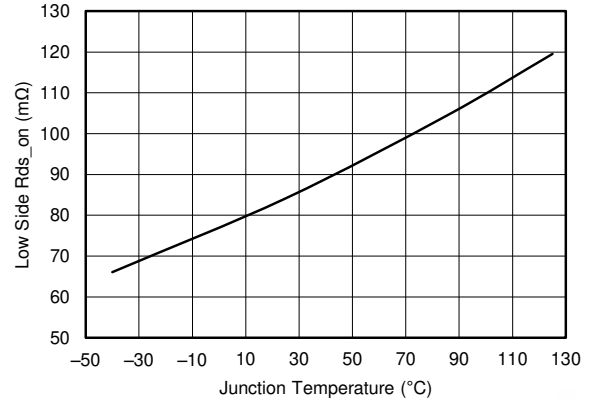

图 6-8. TPS561201 Switching Frequency vs Output Current

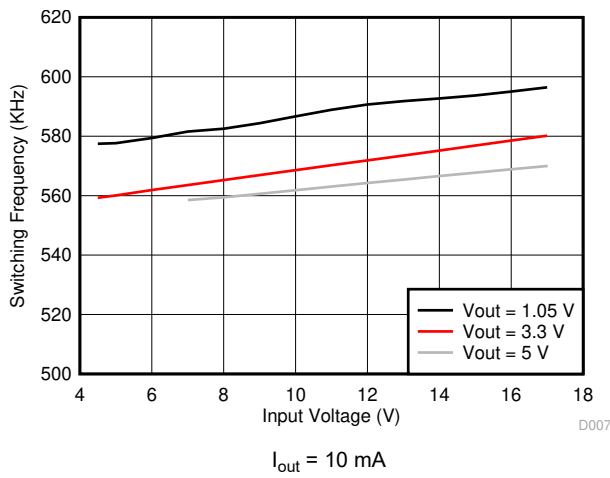

图 6-9. TPS561201 $V_{OUT} = 1.05$ V, Efficiency, $L = 2.2$ μ H

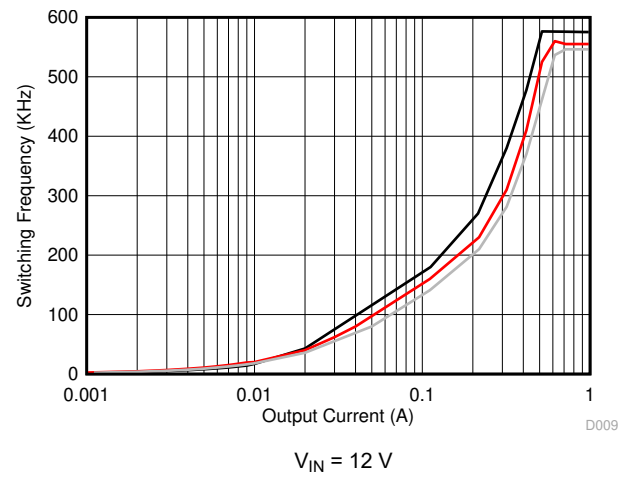

图 6-10. TPS561201 $V_{OUT} = 1.5$ V, Efficiency, $L = 2.2$ μ H

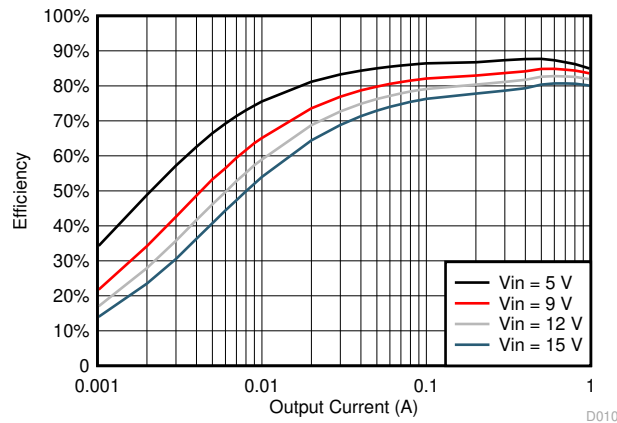

图 6-11. TPS561201 $V_{OUT} = 3.3\text{ V}$, Efficiency, $L = 3.3\ \mu\text{H}$

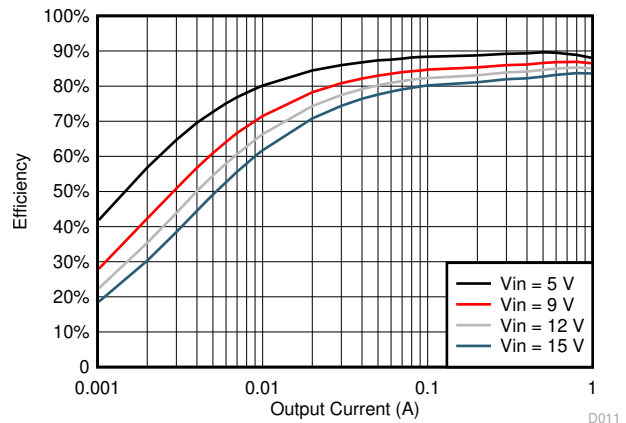

图 6-12. TPS561201 $V_{OUT} = 5\text{ V}$, Efficiency, $L = 4.7\ \mu\text{H}$

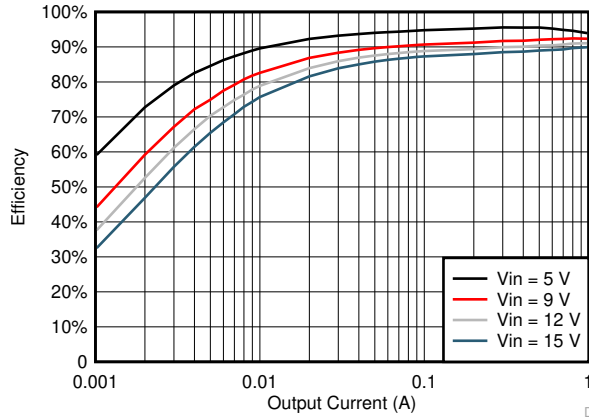

图 6-13. TPS561208 $V_{OUT} = 1.05\text{ V}$, Efficiency, $L = 2.2\ \mu\text{H}$

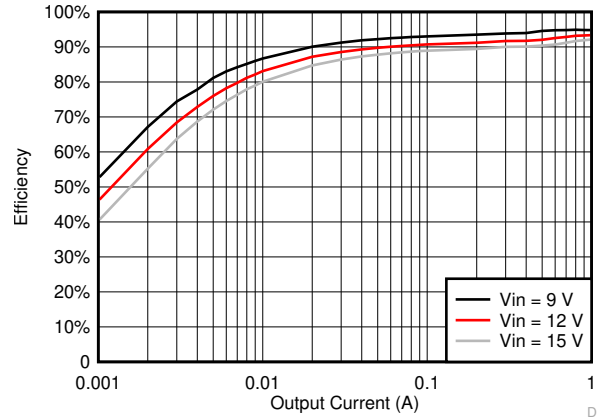

图 6-14. TPS561208 $V_{OUT} = 1.5\text{ V}$, Efficiency, $L = 2.2\ \mu\text{H}$

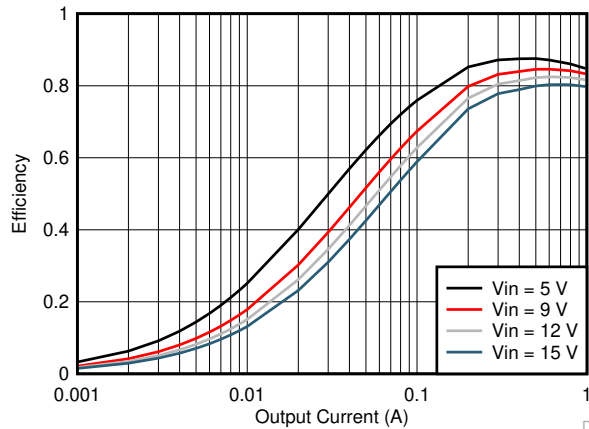

图 6-15. TPS561208 $V_{OUT} = 3.3\text{ V}$, Efficiency, $L = 3.3\ \mu\text{H}$

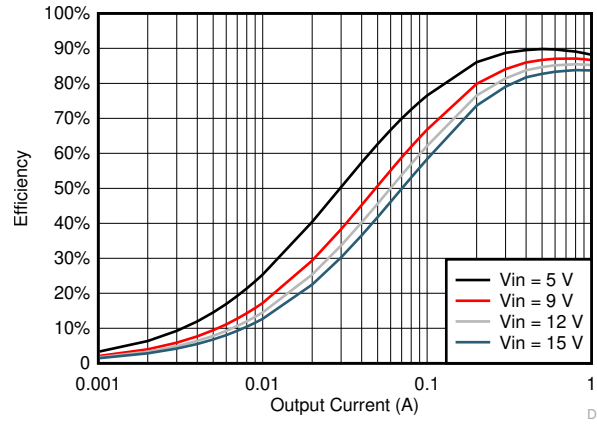

图 6-16. TPS561208 $V_{OUT} = 5\text{ V}$, Efficiency, $L = 4.7\ \mu\text{H}$

7 Detailed Description

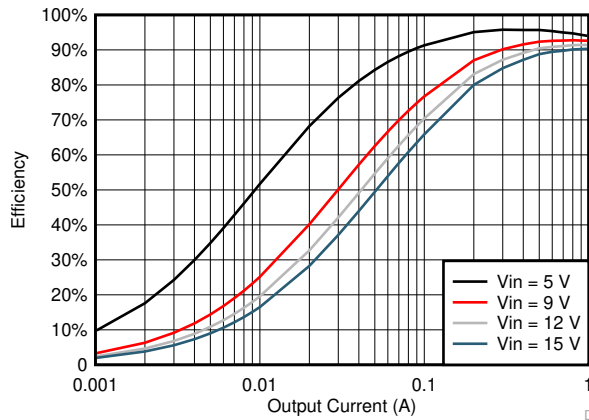
7.1 Overview

The TPS561201 and TPS561208 are 1-A synchronous step-down converters. The proprietary D-CAP2 mode control supports low-ESR output capacitors such as specialty polymer capacitors and multi-layer ceramic capacitors without complex external compensation circuits. The fast transient response of D-CAP2 mode control can reduce the output capacitance required to meet a specific level of performance.

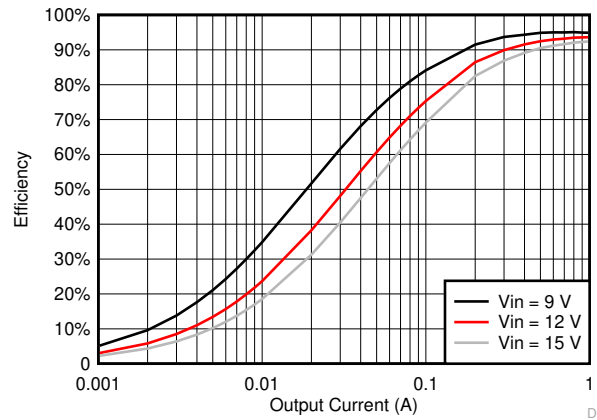
7.2 Functional Block Diagram

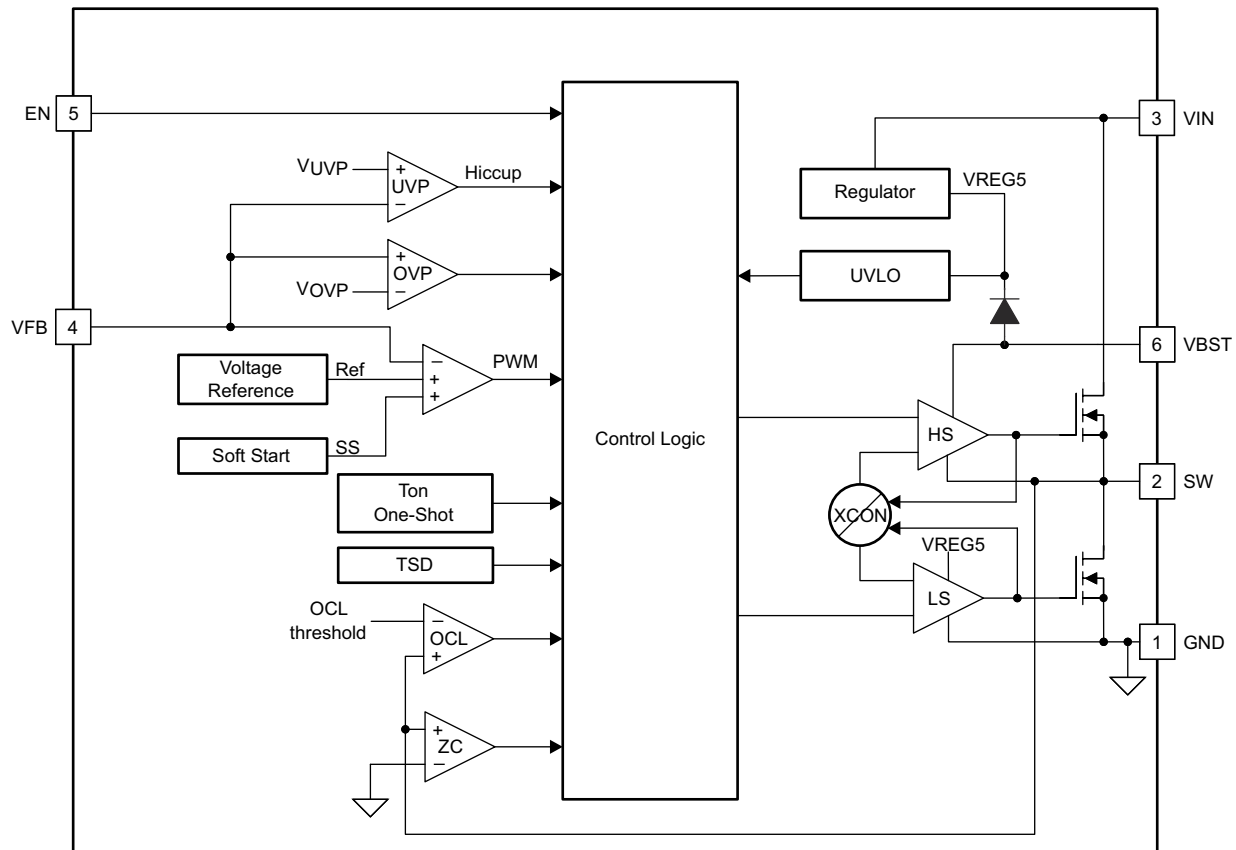

7.3 Feature Description

7.3.1 Adaptive On-Time Control and PWM Operation

The main control loop of the TPS561201 is adaptive on-time pulse width modulation (PWM) controller that supports a proprietary D-CAP2 mode control. The D-CAP2 mode control combines adaptive on-time control with an internal compensation circuit for pseudo-fixed frequency and low external component count configuration with both low ESR and ceramic output capacitors. It is stable even with virtually no ripple at the output.

At the beginning of each cycle, the high-side MOSFET is turned on. This MOSFET is turned off after internal one shot timer expires. This one shot duration is set proportional to the converter input voltage, V_{IN} , and inversely proportional to the output voltage, V_O , to maintain a pseudo-fixed frequency over the input voltage range, hence it is called adaptive on-time control. The one-shot timer is reset and the high-side MOSFET is turned on again when the feedback voltage falls below the reference voltage. An internal ramp is added to reference voltage to simulate output ripple, eliminating the need for ESR induced output ripple from D-CAP2 mode control.

7.3.2 Pulse Skip Control (TPS561201)

The TPS561201 and TPS561208 are designed with Advanced Eco-mode to maintain high light load efficiency. As the output current decreases from heavy load condition, the inductor current is also reduced and eventually comes to point that the rippled valley touches zero level, which is the boundary between continuous conduction

and discontinuous conduction modes. The rectifying MOSFET is turned off when the zero inductor current is detected. As the load current further decreases, the converter runs into discontinuous conduction mode. The on-time is kept almost the same as it was in continuous conduction mode so that it takes longer time to discharge the output capacitor with smaller load current to the level of the reference voltage. This makes the switching frequency lower and proportional to the load current, and keeps the light load efficiency high. The transition point to the light load operation $I_{OUT(LL)}$ current can be calculated in [方程式 1](#).

$$I_{OUT(LL)} = \frac{1}{2 \times L \times f_{SW}} \times \frac{(V_{IN} - V_{OUT}) \times V_{OUT}}{V_{IN}} \quad (1)$$

7.3.3 Soft Start and Pre-Biased Soft Start

The TPS561201 and TPS561208 have an internal 1.0-ms soft start. When the EN pin becomes high, the internal soft-start function begins ramping up the reference voltage to the PWM comparator. If the output capacitor is pre-biased at start-up, the devices initiate switching and start ramping up only after the internal reference voltage becomes greater than the feedback voltage VFB. This scheme ensures that the converters ramp up smoothly into regulation point.

7.3.4 Current Protection

The output overcurrent limit (OCL) is implemented using a cycle-by-cycle valley detect control circuit. The switch current is monitored during the OFF state by measuring the low-side FET drain to source voltage. This voltage is proportional to the switch current. To improve accuracy, the voltage sensing is temperature compensated.

During the on-time of the high-side FET switch, the switch current increases at a linear rate determined by V_{in} , V_{out} , the on-time, and the output inductor value. During the on-time of the low-side FET switch, this current decreases linearly. The average value of the switch current is the load current I_{out} . If the monitored current is above the OCL level, the converter maintains low-side FET on and delays the creation of a new set pulse, even the voltage feedback loop requires one, until the current level becomes OCL level or lower. In subsequent switching cycles, the on-time is set to a fixed value and the current is monitored in the same manner.

There are some important considerations for this type of over-current protection. The load current is higher than the overcurrent threshold by one half of the peak-to-peak inductor ripple current. Also, when the current is being limited, the output voltage tends to fall as the demanded load current can be higher than the current available from the converter. This can cause the output voltage to fall. When the VFB voltage falls below the UVP threshold voltage, the UVP comparator detects it. And then, the device will shut down after the UVP delay time (typically 24 μ s) and restart after the hiccup time (typically 15 ms).

When the overcurrent condition is removed, the output voltage returns to the regulated value.

7.3.5 Undervoltage Lockout (UVLO) Protection

UVLO protection monitors the internal regulator voltage. When the voltage is lower than UVLO threshold voltage, the device is shut off. This protection is non-latching.

7.3.6 Thermal Shutdown

The device monitors the temperature of itself. If the temperature exceeds the threshold value (typically 160°C), the device is shut off. This is a non-latch protection.

7.4 Device Functional Modes

7.4.1 Normal Operation

When the input voltage is above the UVLO threshold and the EN voltage is above the enable threshold, the TPS561208 can operate in their normal switching modes. Normal continuous conduction mode (CCM) occurs when the minimum switch current is above 0 A. In CCM, the TPS561208 operates at a quasi-fixed frequency of 580 kHz.

7.4.2 Eco-mode Operation

When the TPS561201 and TPS561208 are in the normal CCM operating mode and the switch current falls to 0 A, the TPS561201 begins operating in pulse skipping Eco-mode. Each switching cycle is followed by a period of

energy saving sleep time. The sleep time ends when the VFB voltage falls below the Eco-mode threshold voltage. As the output current decreases, the perceived time between switching pulses increases.

7.4.3 Standby Operation

When the TPS561201 and TPS561208 are operating in either normal CCM or Eco-mode, they can be placed in standby by asserting the EN pin low.

8 Application and Implementation

Note

Information in the following applications sections is not part of the TI component specification, and TI does not warrant its accuracy or completeness. TI's customers are responsible for determining suitability of components for their purposes. Customers should validate and test their design implementation to confirm system functionality.

8.1 Application Information

The devices are typical step-down DC-DC converters. It typically uses to convert a higher dc voltage to a lower dc voltage with a maximum available output current of 1 A. The following design procedure can be used to select component values for the TPS561201 and TPS561208. Alternately, the WEBENCH® software can be used to generate a complete design. The WEBENCH software uses an iterative design procedure and accesses a comprehensive database of components when generating a design. This section presents a simplified discussion of the design process.

8.2 Typical Application

The application schematic in 图 8-1 was developed to meet the previous requirements. This circuit is available as the evaluation module (EVM). The sections provide the design procedure.

图 8-1 shows the TPS561201 and TPS561208 4.5-V to 17-V Input, 1.05-V output converter schematics.



图 8-1. TPS561201 and TPS561208 1.05-V/1-A Reference Design

8.2.1 Design Requirements

表 8-1 shows the design parameters.

表 8-1. Design Parameters

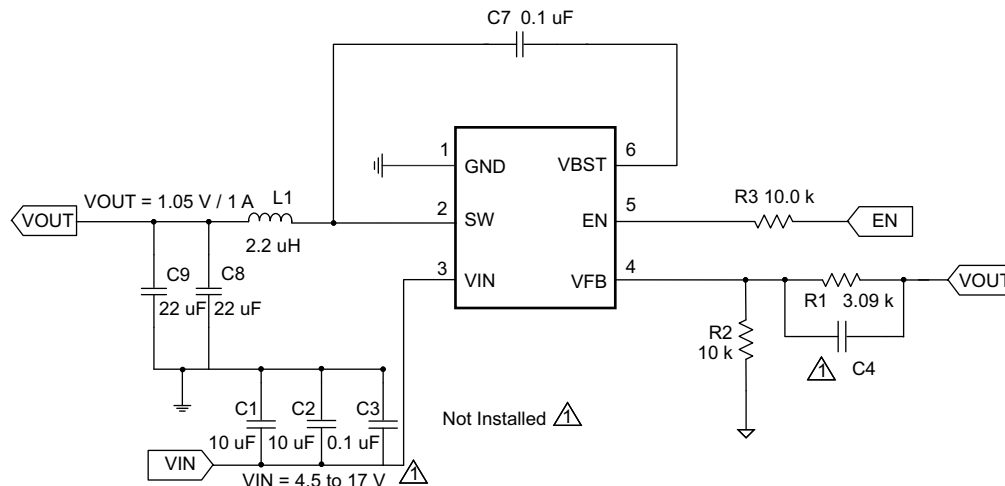
PARAMETER	EXAMPLE VALUE
Input voltage range	4.5 to 17 V
Output voltage	1.05 V
Transient response, 1-A load step	$\Delta V_{out} = \pm 5\%$
Input ripple voltage	400 mV
Output ripple voltage	30 mV
Output current rating	1A
Operating frequency	580 kHz

8.2.2 Detailed Design Procedure

8.2.2.1 Custom Design With WEBENCH® Tools

[Click here](#) to create a custom design using the TPS56120x device with the WEBENCH® Power Designer.

1. Start by entering the input voltage (V_{IN}), output voltage (V_{OUT}), and output current (I_{OUT}) requirements.
2. Optimize the design for key parameters such as efficiency, footprint, and cost using the optimizer dial.
3. Compare the generated design with other possible solutions from Texas Instruments.

The WEBENCH Power Designer provides a customized schematic along with a list of materials with real-time pricing and component availability.

In most cases, these actions are available:

- Run electrical simulations to see important waveforms and circuit performance
- Run thermal simulations to understand board thermal performance
- Export customized schematic and layout into popular CAD formats
- Print PDF reports for the design, and share the design with colleagues

Get more information about WEBENCH tools at www.ti.com/WEBENCH.

8.2.2.2 Output Voltage Resistors Selection

The output voltage is set with a resistor divider from the output node to the VFB pin. TI recommends to use 1% tolerance or better divider resistors. Start by using [方程式 2](#) to calculate V_{OUT} .

To improve efficiency at very light loads, consider using larger value resistors. Too high of resistance will be more susceptible to noise and voltage errors from the VFB input current will be more noticeable.

$$V_{OUT} = 0.768 \times \left(1 + \frac{R1}{R2} \right) \quad (2)$$

8.2.2.3 Output Filter Selection

The LC filter used as the output filter has double pole at:

$$F_P = \frac{1}{2\pi\sqrt{L_{OUT} \times C_{OUT}}} \quad (3)$$

At low frequencies, the overall loop gain is set by the output set-point resistor divider network and the internal gain of the device. The low frequency phase is 180 degrees. At the output filter pole frequency, the gain rolls off at a -40 dB per decade rate and the phase drops rapidly. D-CAP2 introduces a high frequency zero that reduces the gain roll off to -20 dB per decade and increases the phase to 90 degrees one decade above the zero frequency. The inductor and capacitor for the output filter must be selected so that the double pole of [方程式 3](#) is located below the high frequency zero but close enough that the phase boost provided by the high frequency zero provides adequate phase margin for a stable circuit. To meet this requirement use the values recommended in [表 8-2](#).

表 8-2. Recommended Component Values

OUTPUT VOLTAGE (V)	R1 (kΩ)	R2 (kΩ)	L1 (μH)			C8 + C9 (μF)
			MIN	TYP	MAX	
1	3.09	10.0	2.2	2.2	4.7	20 to 68
1.05	3.74	10.0	2.2	2.2	4.7	20 to 68
1.2	5.76	10.0	2.2	2.2	4.7	20 to 68
1.5	9.53	10.0	2.2	2.2	4.7	20 to 68
1.8	13.7	10.0	2.2	2.2	4.7	20 to 68
2.5	22.6	10.0	3.3	3.3	4.7	20 to 68

表 8-2. Recommended Component Values (continued)

OUTPUT VOLTAGE (V)	R1 (kΩ)	R2 (kΩ)	L1 (μH)			C8 + C9 (μF)
			MIN	TYP	MAX	
3.3	33.2	10.0	3.3	3.3	4.7	20 to 68
5	54.9	10.0	3.3	4.7	4.7	20 to 68
6.5	75	10.0	3.3	4.7	4.7	20 to 68

The inductor peak-to-peak ripple current, peak current and RMS current are calculated using 方程式 4, 方程式 5, and 方程式 6. The inductor saturation current rating must be greater than the calculated peak current and the RMS or heating current rating must be greater than the calculated RMS current.

Use 580 kHz for f_{SW} . Make sure the chosen inductor is rated for the peak current of 方程式 5 and the RMS current of 方程式 6.

$$I_{P-P} = \frac{V_{OUT}}{V_{IN(MAX)}} \times \frac{V_{IN(MAX)} - V_{OUT}}{L_O \times f_{SW}} \quad (4)$$

$$I_{PEAK} = I_O + \frac{I_{P-P}}{2} \quad (5)$$

$$I_{LO(RMS)} = \sqrt{I_O^2 + \frac{1}{12} I_{P-P}^2} \quad (6)$$

For this design example, the calculated peak current is 1.69 A and the calculated RMS current is 1.11 A. The inductor used is a WE 744311330 with a peak current rating of 11 A and an RMS current rating of 6.5 A.

The capacitor value and ESR determines the amount of output voltage ripple. The TPS561201 and TPS561208 are intended for use with ceramic or other low-ESR capacitors. Recommended values range from 20 μF to 68 μF. Use 方程式 7 to determine the required RMS current rating for the output capacitor.

$$I_{CO(RMS)} = \frac{V_{OUT} \times (V_{IN} - V_{OUT})}{\sqrt{12} \times V_{IN} \times L_O \times f_{SW}} \quad (7)$$

For this design, two TDK C3216X5R0J226M 22-μF output capacitors are used. The typical ESR is 2 mΩ each. The calculated RMS current is 0.286 A.

8.2.2.4 Input Capacitor Selection

The TPS561201 and TPS561208 require an input decoupling capacitor and a bulk capacitor is needed depending on the application. TI recommends a ceramic capacitor over 10 μF for the decoupling capacitor. An additional 0.1-μF capacitor (C3) from pin 3 to ground is optional to provide additional high frequency filtering. The capacitor voltage rating needs to be greater than the maximum input voltage.

8.2.2.5 Bootstrap Capacitor Selection

A 0.1-μF ceramic capacitor must be connected between the VBST to SW pin for proper operation. TI recommends to use a ceramic capacitor.

8.2.3 Application Curves



图 8-2. Load Regulation $V_{IN} = 5\text{ V}$



图 8-3. Load Regulation $V_{IN} = 12\text{ V}$

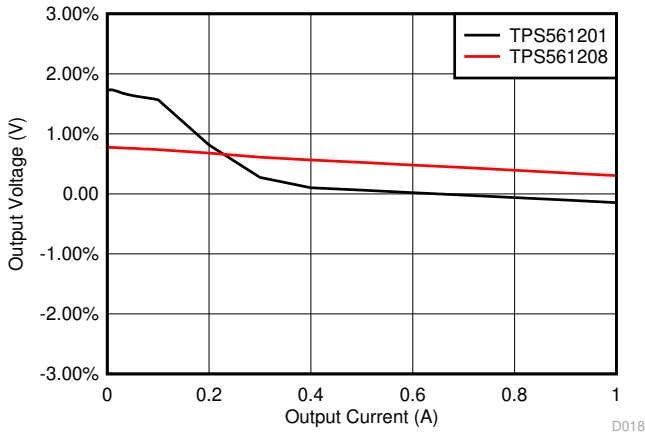

TPS56201 $I_{OUT} = 0.5\text{ A}$ TPS56208 $I_{OUT} = 10\text{ mA}$

图 8-4. Line Regulation

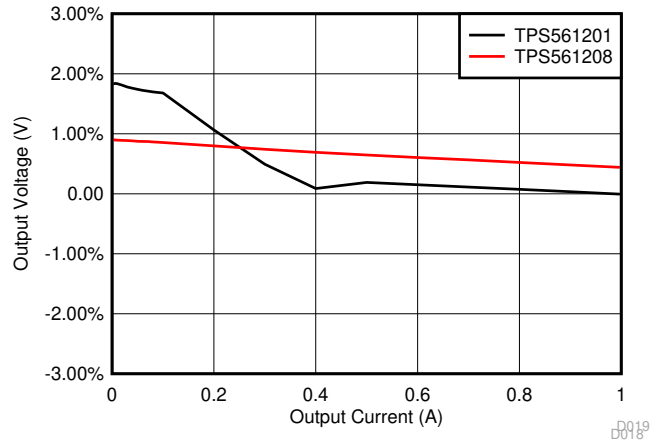
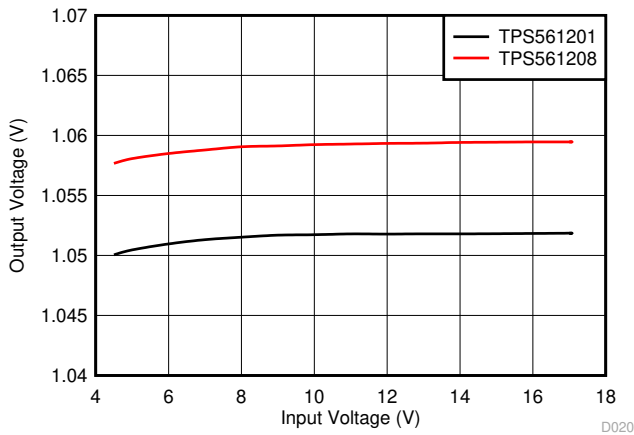

图 8-5. TPS561201 $V_{OUT} = 1.05\text{ V}$, Efficiency $L = 2.2\ \mu\text{H}$



图 8-6. TPS561201 Input Voltage Ripple

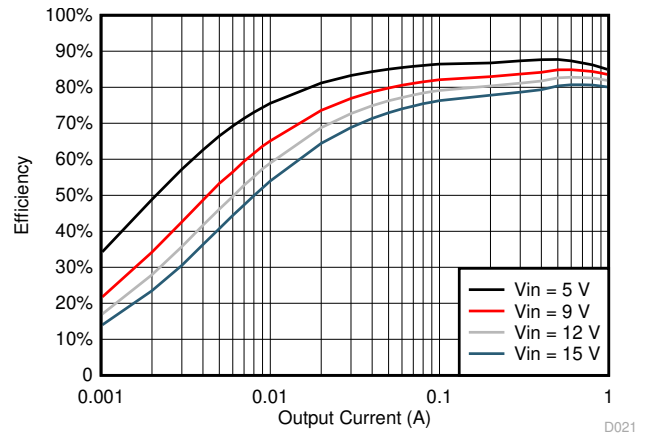

图 8-7. TPS561201 Output Voltage Ripple, $I_{OUT} = 10\text{ mA}$

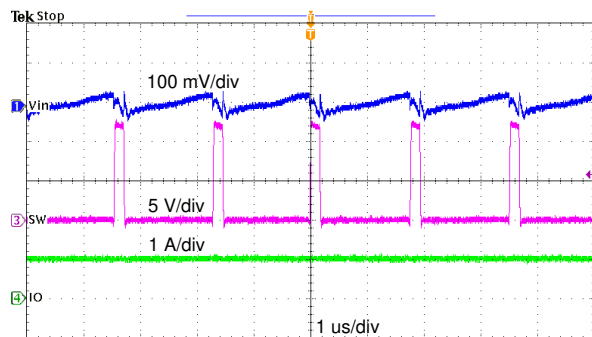

图 8-8. TPS561201 Output Voltage Ripple, $I_{OUT} = 0.25$ A

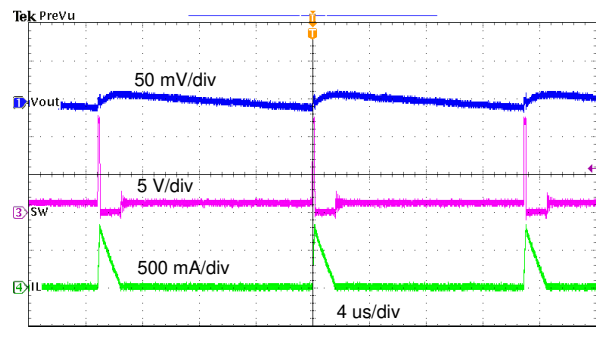

图 8-9. TPS561201 Output Voltage Ripple, $I_{OUT} = 1$ A

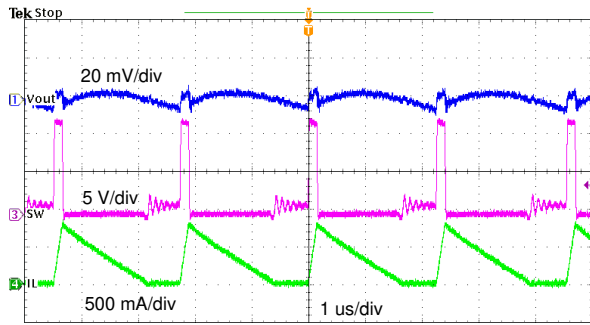

图 8-10. TPS561208 Output Voltage Ripple, $I_{OUT} = 0$ A

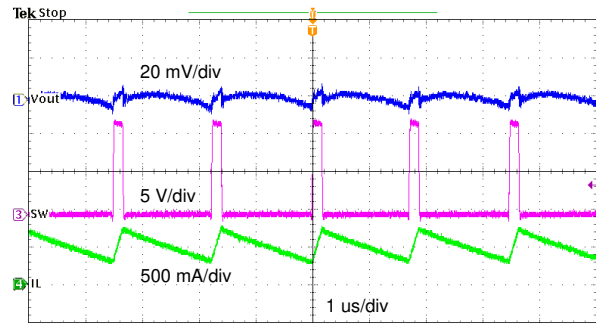

图 8-11. TPS561201 Transient Response, 0.1 to 1 A

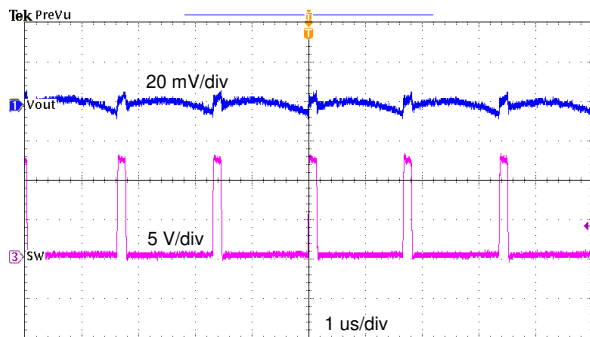

图 8-12. TPS561201 Transient Response, 0.5 to 1.5 A

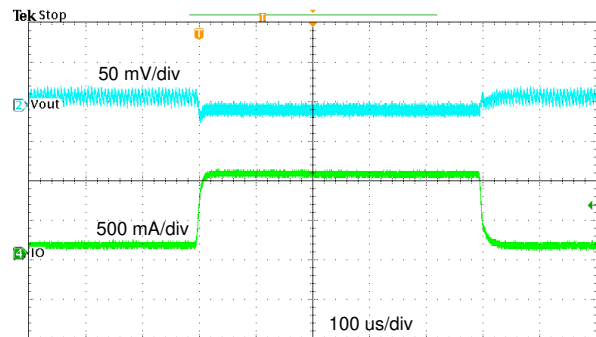

图 8-13. TPS561208 Transient Response 0.1 to 1 A

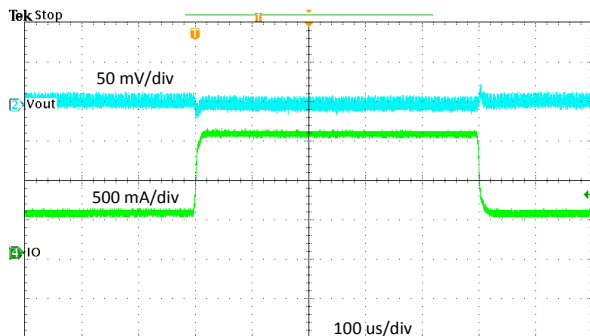

图 8-14. TPS561201 Start-Up Relative to V_I

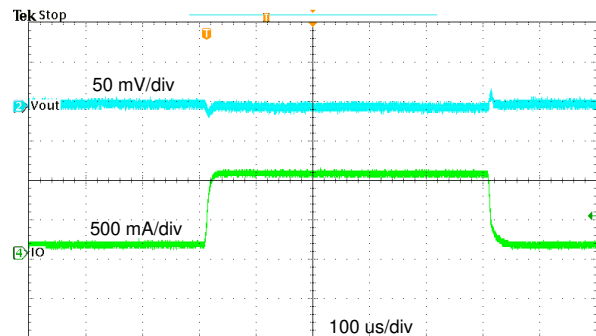

图 8-15. TPS561201 Start-Up Relative to EN

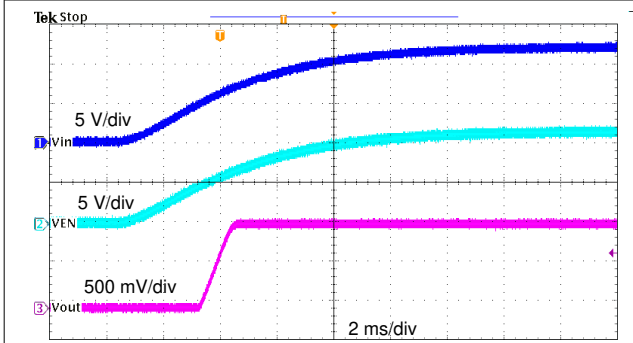

图 8-16. TPS561201 Shutdown Relative to V_I

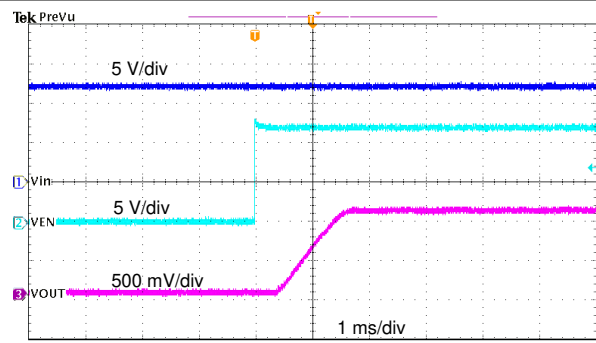

图 8-17. TPS561201 Shutdown Relative to EN

9 Power Supply Recommendations

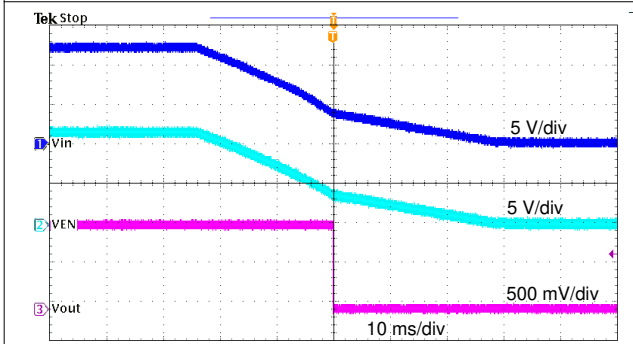
The TPS561201 and TPS561208 are designed to operate from input supply voltage in the range of 4.5 V to 17 V. Buck converters require the input voltage to be higher than the output voltage for proper operation. The maximum recommended operating duty cycle is 75%. Using that criteria, the minimum recommended input voltage is $V_O / 0.75$.

10 Layout

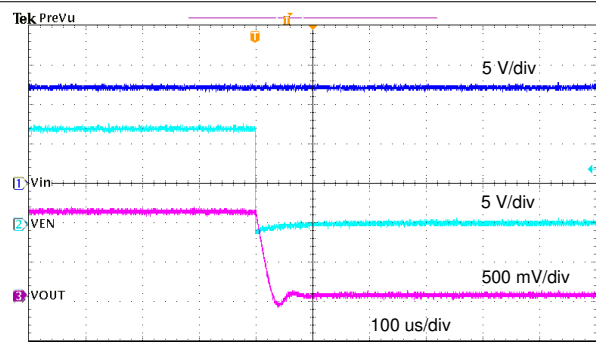
10.1 Layout Guidelines

1. VIN and GND traces should be as wide as possible to reduce trace impedance. The wide areas are also of advantage from the view point of heat dissipation.
2. The input capacitor and output capacitor should be placed as close to the device as possible to minimize trace impedance.
3. Provide sufficient vias for the input capacitor and output capacitor.
4. Keep the SW trace as physically short and wide as practical to minimize radiated emissions.
5. Do not allow switching current to flow under the device.
6. A separate VOUT path should be connected to the upper feedback resistor.
7. Make a Kelvin connection to the GND pin for the feedback path.
8. Voltage feedback loop should be placed away from the high-voltage switching trace, and preferably has ground shield.
9. The trace of the VFB node should be as small as possible to avoid noise coupling.
10. The GND trace between the output capacitor and the GND pin should be as wide as possible to minimize its trace impedance.

10.2 Layout Example



图 10-1. TPS561201 and TPS561208 Layout

11 Device and Documentation Support

11.1 Device Support

11.1.1 Development Support

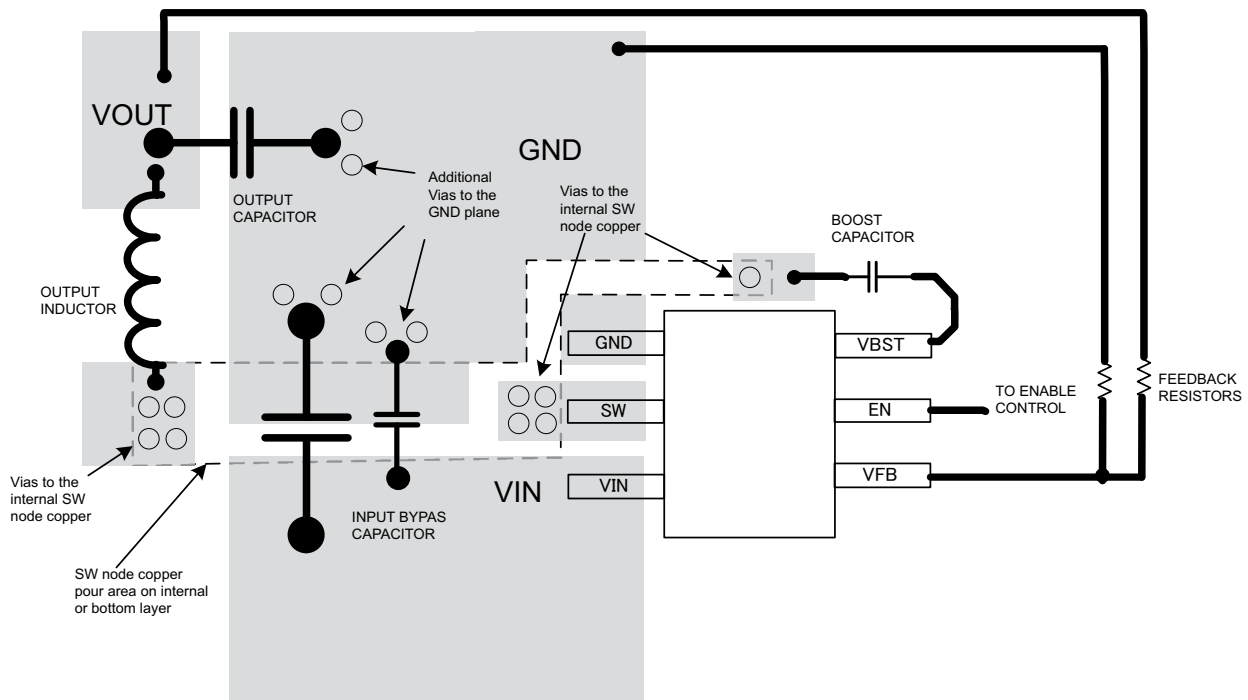
11.1.1.1 Custom Design With WEBENCH® Tools

[Click here](#) to create a custom design using the TPS56120x device with the WEBENCH® Power Designer.

1. Start by entering the input voltage (V_{IN}), output voltage (V_{OUT}), and output current (I_{OUT}) requirements.
2. Optimize the design for key parameters such as efficiency, footprint, and cost using the optimizer dial.
3. Compare the generated design with other possible solutions from Texas Instruments.

The WEBENCH Power Designer provides a customized schematic along with a list of materials with real-time pricing and component availability.

In most cases, these actions are available:

- Run electrical simulations to see important waveforms and circuit performance
- Run thermal simulations to understand board thermal performance
- Export customized schematic and layout into popular CAD formats
- Print PDF reports for the design, and share the design with colleagues

Get more information about WEBENCH tools at www.ti.com/WEBENCH.

11.2 Receiving Notification of Documentation Updates

To receive notification of documentation updates, navigate to the device product folder on ti.com. Click on *Subscribe to updates* to register and receive a weekly digest of any product information that has changed. For change details, review the revision history included in any revised document.

11.3 Support Resources

[TI E2E™ support forums](#) are an engineer's go-to source for fast, verified answers and design help — straight from the experts. Search existing answers or ask your own question to get the quick design help you need.

Linked content is provided "AS IS" by the respective contributors. They do not constitute TI specifications and do not necessarily reflect TI's views; see TI's [Terms of Use](#).

11.4 Trademarks

蓝光™ is a trademark of Blu-ray Disc Association.

Eco-mode™ and TI E2E™ are trademarks of Texas Instruments.

WEBENCH® is a registered trademark of Texas Instruments.

is a registered trademark of Texas Instruments.

所有商标均为其各自所有者的财产。

11.5 Electrostatic Discharge Caution



This integrated circuit can be damaged by ESD. Texas Instruments recommends that all integrated circuits be handled with appropriate precautions. Failure to observe proper handling and installation procedures can cause damage.

ESD damage can range from subtle performance degradation to complete device failure. Precision integrated circuits may be more susceptible to damage because very small parametric changes could cause the device not to meet its published specifications.

11.6 Glossary

[TI Glossary](#) This glossary lists and explains terms, acronyms, and definitions.

12 Mechanical, Packaging, and Orderable Information

The following pages include mechanical, packaging, and orderable information. This information is the most current data available for the designated devices. This data is subject to change without notice and revision of this document. For browser-based versions of this data sheet, refer to the left-hand navigation.

PACKAGING INFORMATION

Orderable part number	Status (1)	Material type (2)	Package Pins	Package qty Carrier	RoHS (3)	Lead finish/ Ball material (4)	MSL rating/ Peak reflow (5)	Op temp (°C)	Part marking (6)
TPS561201DDCR	Active	Production	SOT-23-THIN (DDC) 6	3000 LARGE T&R	Yes	SN	Level-1-260C-UNLIM	-40 to 125	1201
TPS561201DDCR.B	Active	Production	SOT-23-THIN (DDC) 6	3000 LARGE T&R	Yes	SN	Level-1-260C-UNLIM	-40 to 125	1201
TPS561201DDCT	Active	Production	SOT-23-THIN (DDC) 6	250 SMALL T&R	Yes	SN	Level-1-260C-UNLIM	-40 to 125	1201
TPS561201DDCT.B	Active	Production	SOT-23-THIN (DDC) 6	250 SMALL T&R	Yes	SN	Level-1-260C-UNLIM	-40 to 125	1201
TPS561208DDCR	Active	Production	SOT-23-THIN (DDC) 6	3000 LARGE T&R	Yes	SN	Level-1-260C-UNLIM	-40 to 125	1208
TPS561208DDCR.B	Active	Production	SOT-23-THIN (DDC) 6	3000 LARGE T&R	Yes	SN	Level-1-260C-UNLIM	-40 to 125	1208
TPS561208DDCT	Active	Production	SOT-23-THIN (DDC) 6	250 SMALL T&R	Yes	SN	Level-1-260C-UNLIM	-40 to 125	1208
TPS561208DDCT.B	Active	Production	SOT-23-THIN (DDC) 6	250 SMALL T&R	Yes	SN	Level-1-260C-UNLIM	-40 to 125	1208

(1) **Status:** For more details on status, see our [product life cycle](#).

(2) **Material type:** When designated, preproduction parts are prototypes/experimental devices, and are not yet approved or released for full production. Testing and final process, including without limitation quality assurance, reliability performance testing, and/or process qualification, may not yet be complete, and this item is subject to further changes or possible discontinuation. If available for ordering, purchases will be subject to an additional waiver at checkout, and are intended for early internal evaluation purposes only. These items are sold without warranties of any kind.

(3) **RoHS values:** Yes, No, RoHS Exempt. See the [TI RoHS Statement](#) for additional information and value definition.

(4) **Lead finish/Ball material:** Parts may have multiple material finish options. Finish options are separated by a vertical ruled line. Lead finish/Ball material values may wrap to two lines if the finish value exceeds the maximum column width.

(5) **MSL rating/Peak reflow:** The moisture sensitivity level ratings and peak solder (reflow) temperatures. In the event that a part has multiple moisture sensitivity ratings, only the lowest level per JEDEC standards is shown. Refer to the shipping label for the actual reflow temperature that will be used to mount the part to the printed circuit board.

(6) **Part marking:** There may be an additional marking, which relates to the logo, the lot trace code information, or the environmental category of the part.

Multiple part markings will be inside parentheses. Only one part marking contained in parentheses and separated by a "~" will appear on a part. If a line is indented then it is a continuation of the previous line and the two combined represent the entire part marking for that device.

Important Information and Disclaimer: The information provided on this page represents TI's knowledge and belief as of the date that it is provided. TI bases its knowledge and belief on information provided by third parties, and makes no representation or warranty as to the accuracy of such information. Efforts are underway to better integrate information from third parties. TI has taken and continues to take reasonable steps to provide representative and accurate information but may not have conducted destructive testing or chemical analysis on incoming materials and chemicals. TI and TI suppliers consider certain information to be proprietary, and thus CAS numbers and other limited information may not be available for release.

In no event shall TI's liability arising out of such information exceed the total purchase price of the TI part(s) at issue in this document sold by TI to Customer on an annual basis.

TAPE AND REEL INFORMATION

QUADRANT ASSIGNMENTS FOR PIN 1 ORIENTATION IN TAPE



*All dimensions are nominal

Device	Package Type	Package Drawing	Pins	SPQ	Reel Diameter (mm)	Reel Width W1 (mm)	A0 (mm)	B0 (mm)	K0 (mm)	P1 (mm)	W (mm)	Pin1 Quadrant
TPS561201DDCR	SOT-23-THIN	DDC	6	3000	180.0	8.4	3.2	3.2	1.4	4.0	8.0	Q3
TPS561201DDCT	SOT-23-THIN	DDC	6	250	180.0	8.4	3.2	3.2	1.4	4.0	8.0	Q3
TPS561208DDCR	SOT-23-THIN	DDC	6	3000	180.0	9.5	3.17	3.1	1.1	4.0	8.0	Q3
TPS561208DDCR	SOT-23-THIN	DDC	6	3000	180.0	8.4	3.2	3.2	1.4	4.0	8.0	Q3
TPS561208DDCT	SOT-23-THIN	DDC	6	250	180.0	8.4	3.2	3.2	1.4	4.0	8.0	Q3

TAPE AND REEL BOX DIMENSIONS

*All dimensions are nominal

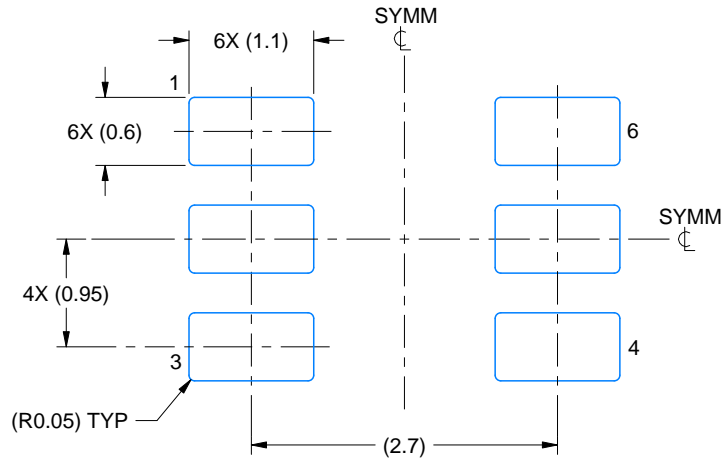
Device	Package Type	Package Drawing	Pins	SPQ	Length (mm)	Width (mm)	Height (mm)
TPS561201DDCR	SOT-23-THIN	DDC	6	3000	210.0	185.0	35.0
TPS561201DDCT	SOT-23-THIN	DDC	6	250	210.0	185.0	35.0
TPS561208DDCR	SOT-23-THIN	DDC	6	3000	205.0	200.0	30.0
TPS561208DDCR	SOT-23-THIN	DDC	6	3000	210.0	185.0	35.0
TPS561208DDCT	SOT-23-THIN	DDC	6	250	210.0	185.0	35.0



LAND PATTERN EXAMPLE
EXPLODED METAL SHOWN
SCALE:15X



SOLDEMASK DETAILS

4214841/E 08/2024

NOTES: (continued)

- 4. Publication IPC-7351 may have alternate designs.
- 5. Solder mask tolerances between and around signal pads can vary based on board fabrication site.

EXAMPLE STENCIL DESIGN

DDC0006A

SOT-23 - 1.1 max height

SMALL OUTLINE TRANSISTOR



SOLDER PASTE EXAMPLE
BASED ON 0.125 THICK STENCIL
SCALE:15X

4214841/E 08/2024

NOTES: (continued)

6. Laser cutting apertures with trapezoidal walls and rounded corners may offer better paste release. IPC-7525 may have alternate design recommendations.
7. Board assembly site may have different recommendations for stencil design.

重要通知和免责声明

TI“按原样”提供技术和可靠性数据（包括数据表）、设计资源（包括参考设计）、应用或其他设计建议、网络工具、安全信息和其他资源，不保证没有瑕疵且不做任何明示或暗示的担保，包括但不限于对适销性、与某特定用途的适用性或不侵犯任何第三方知识产权的暗示担保。

这些资源可供使用 TI 产品进行设计的熟练开发人员使用。您将自行承担以下全部责任：(1) 针对您的应用选择合适的 TI 产品，(2) 设计、验证并测试您的应用，(3) 确保您的应用满足相应标准以及任何其他安全、安保法规或其他要求。

这些资源如有变更，恕不另行通知。TI 授权您仅可将这些资源用于研发本资源所述的 TI 产品的相关应用。严禁以其他方式对这些资源进行复制或展示。您无权使用任何其他 TI 知识产权或任何第三方知识产权。对于因您对这些资源的使用而对 TI 及其代表造成的任何索赔、损害、成本、损失和债务，您将全额赔偿，TI 对此概不负责。

TI 提供的产品受 [TI 销售条款](#)、[TI 通用质量指南](#) 或 [ti.com](#) 上其他适用条款或 TI 产品随附的其他适用条款的约束。TI 提供这些资源并不会扩展或以其他方式更改 TI 针对 TI 产品发布的适用的担保或担保免责声明。除非德州仪器 (TI) 明确将某产品指定为定制产品或客户特定产品，否则其产品均为按确定价格收入目录的标准通用器件。

TI 反对并拒绝您可能提出的任何其他或不同的条款。

版权所有 © 2026，德州仪器 (TI) 公司

最后更新日期：2025 年 10 月