

## 具有 DCS-Control™ 的 TPS6217x 3V 至 17V 0.5A 降压转换器

### 1 特性

- DCS-Control™ 拓扑技术
- 输入电压范围为 3V 至 17V
- 输出电流高达 500mA
- 可调输出电压范围为 0.9V 至 6V
- 固定输出电压版本
- 无缝省电模式转换
- 静态电流典型值为 17 $\mu$ A
- 电源正常输出
- 100% 占空比模式
- 短路保护
- 过热保护
- 与 TPS62160 和 TPS62125 引脚兼容
- 采用 2mm x 2mm、8 引脚晶圆级小外形无引线 (WSON) 封装
- 结合使用 TPS62170 和 WEBENCH® 电源设计器 创建定制设计方案

### 2 应用

- 标准 12V 导轨式电源
- 单一或者多个锂离子电池供电的负载点 (POL) 电源
- 低压降稳压器 (LDO) 替代产品
- 嵌入式系统
- 数码相机、数码摄像机
- 移动电脑、平板电脑、调制解调器

### 3 说明

TPS6217x 器件系列是易于使用的同步降压 DC-DC 转换器，针对高功率密度的应用进行了优化。该系列器件的开关频率典型值高达 2.25MHz，允许使用小型电感器，通过利用 DCS-Control™ 拓扑技术提供快速瞬态响应并实现高输出电压精度。

该系列器件具有 3V 至 17V 宽运行输入电压范围，非常适用于由锂离子或其他电池以及 12V 中间电源轨供电的系统。其输出电压为 0.9V 至 6V，支持高达 0.5A 的持续输出电流（使用 100% 占空比模式）。

此外，还可以通过配置使能引脚和开漏电源正常状态引脚实现电源排序。

在节能模式下，器件可根据输入电压 (VIN) 生成约 17 $\mu$ A 的静态电流。负载较小时可自动且无缝进入节能模式，同时该模式可保持整个负载范围内的高效率。该器件在关断模式下处于关断状态，期间的流耗低于 2 $\mu$ A。

此器件提供了可调节输出电压和固定输出电压版本，采用 2mm x 2mm 8 引脚 WSON 封装 (DSG)。

#### 器件信息(1)

器件型号	封装	封装尺寸 (标称值)
TPS6217x	WSON (8)	2.00mm x 2.00mm

(1) 如需了解所有可用封装，请参阅数据表末尾的可订购产品附录。

典型应用电路原理图

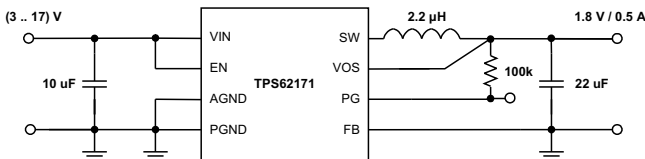

效率与输出电流间的关系

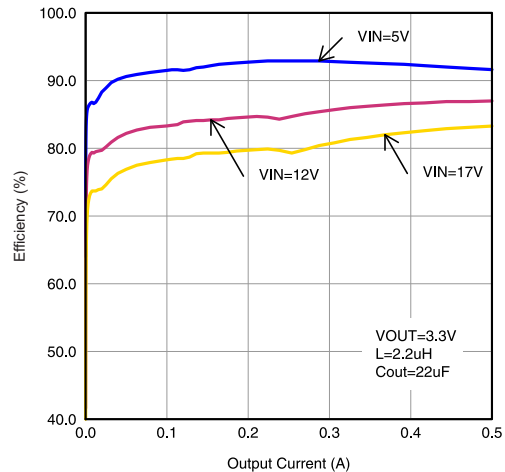

## 目录

<b>1</b>	特性 .....	<b>1</b>	<b>9</b>	<b>Application and Implementation</b> .....	<b>12</b>
<b>2</b>	应用 .....	<b>1</b>	9.1	Application Information.....	12
<b>3</b>	说明 .....	<b>1</b>	9.2	Typical Application .....	12
<b>4</b>	修订历史记录 .....	<b>2</b>	9.3	System Examples .....	21
<b>5</b>	<b>Device Voltage Options</b> .....	<b>3</b>	<b>10</b>	<b>Power Supply Recommendations</b> .....	<b>24</b>
<b>6</b>	<b>Pin Configuration and Functions</b> .....	<b>3</b>	<b>11</b>	<b>Layout</b> .....	<b>25</b>
<b>7</b>	<b>Specifications</b> .....	<b>4</b>	11.1	Layout Guidelines .....	25
7.1	Absolute Maximum Ratings .....	4	11.2	Layout Example .....	25
7.2	ESD Ratings.....	4	11.3	Thermal Considerations .....	26
7.3	Recommended Operating Conditions.....	4	<b>12</b>	<b>器件和文档支持</b> .....	<b>27</b>
7.4	Thermal Information .....	4	12.1	器件支持 .....	27
7.5	Electrical Characteristics.....	5	12.2	文档支持 .....	27
7.6	Typical Characteristics .....	6	12.3	相关链接 .....	27
<b>8</b>	<b>Detailed Description</b> .....	<b>7</b>	12.4	社区资源 .....	28
8.1	Overview .....	7	12.5	商标 .....	28
8.2	Functional Block Diagram .....	7	12.6	静电放电警告 .....	28
8.3	Feature Description.....	8	12.7	Glossary .....	28
8.4	Device Functional Modes.....	10	<b>13</b>	<b>机械、封装和可订购信息</b> .....	<b>29</b>

## 4 修订历史记录

注：之前版本的页码可能与当前版本有所不同。

Changes from Revision D (October 2014) to Revision E	Page
• 已添加 WEBENCH® 设计器链接 .....	1
• Added "SW (AC), less than 10ns" specification to Absolute Maximum Ratings table .....	4
• Changed T <sub>J</sub> MAX spec from "125" to "150" .....	4
• Changed <a href="#">Electrical Characteristics</a> Conditions from "free-air temperature range" to "junction temperature range" .....	5
• Added I <sub>Q</sub> and I <sub>SD</sub> specifications .....	5
• Added 125°C plot line in <a href="#">Figure 1</a> and <a href="#">Figure 4</a> Typical Characteristics graphic entities. ....	6
• Added <a href="#">Power Good Pin Logic Table</a> .....	9

Changes from Revision C (August 2013) to Revision D	Page
• 已添加 引脚配置和功能部分, <a href="#">ESD</a> 额定值表, 特性 说明 部分、器件功能模式、应用和 实施 部分、电源相关建议 部 分、布局 部分、器件和文档支持 部分以及机械、封装和可订购信息 部分 .....	1

Changes from Revision B (August 2013) to Revision C	Page
• Changed 50mV/μs to 50mV/s in Enable and Shutdown (EN) section .....	8

Changes from Revision A (April 2012) to Revision B	Page
• Added diode to <a href="#">Figure 41</a> .....	24

Changes from Original (November 2011) to Revision A	Page
• Changed <a href="#">Table 2</a> .....	13

## 5 Device Voltage Options

OUTPUT VOLTAGE <sup>(1)</sup>	PART NUMBER	PACKAGE
adjustable	TPS62170	WSON (8)
1.8 V	TPS62171	
3.3 V	TPS62172	
5.0 V	TPS62173	

(1) Contact the factory to check availability of other fixed output voltage versions.

## 6 Pin Configuration and Functions

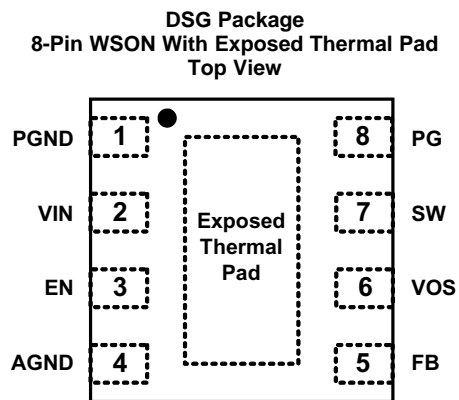

**Pin Functions**

PIN <sup>(1)</sup>		I/O	DESCRIPTION
NAME	NO.		
PGND	1	—	Power ground
VIN	2	IN	Supply voltage
EN	3	IN	Enable input (High = enabled, Low = disabled)
AGND	4	—	Analog ground
FB	5	IN	Voltage feedback of adjustable version. Connect resistive voltage divider to this pin. It is recommended to connect FB to AGND on fixed output voltage versions for improved thermal performance.
VOS	6	IN	Output voltage sense pin and connection for the control loop circuitry.
SW	7	OUT	Switch node, which is connected to the internal MOSFET switches. Connect inductor between SW and output capacitor.
PG	8	OUT	Output power good (High = VOUT ready, Low = VOUT below nominal regulation); open drain (requires pull-up resistor; goes high impedance, when device is switched off)
Exposed Thermal Pad		—	Must be connected to AGND. Must be soldered to achieve appropriate power dissipation and mechanical reliability.

(1) For more information about connecting pins, see [Detailed Description](#) and [Application Information](#) sections.

## 7 Specifications

### 7.1 Absolute Maximum Ratings<sup>(1)</sup>

		MIN	MAX	UNIT
Pin voltage range <sup>(2)</sup>	VIN	-0.3	20	V
	EN, SW (DC)	-0.3	V <sub>IN</sub> + 0.3	V
	SW (AC), less than 10ns <sup>(3)</sup>	-2	24.5	
	FB, PG, VOS	-0.3	7	V
Power good sink current	PG		10	mA
Operating junction temperature, T <sub>J</sub>		-40	150	°C
Storage temperature, T <sub>stg</sub>		-65	150	°C

- (1) Stresses beyond those listed under *Absolute Maximum Ratings* may cause permanent damage to the device. These are stress ratings only, which do not imply functional operation of the device at these or any other conditions beyond those indicated under *Recommended Operating Conditions*. Exposure to absolute-maximum-rated conditions for extended periods may affect device reliability.
- (2) All voltages are with respect to network ground terminal.
- (3) While switching.

### 7.2 ESD Ratings

		VALUE	UNIT
V <sub>(ESD)</sub> Electrostatic discharge	Human body model (HBM), per ANSI/ESDA/JEDEC JS-001 <sup>(1)</sup>	±2000	V
	Charged device model (CDM), per JEDEC specification JESD22-C101 <sup>(2)</sup>	±500	

- (1) JEDEC document JEP155 states that 500-V HBM allows safe manufacturing with a standard ESD control process.
- (2) JEDEC document JEP157 states that 250-V CDM allows safe manufacturing with a standard ESD control process.

### 7.3 Recommended Operating Conditions

	MIN	NOM	MAX	UNIT
Supply Voltage, V <sub>IN</sub>	3		17	V
Output Voltage, V <sub>OUT</sub>	0.9		6	V
Operating junction temperature, T <sub>J</sub>	-40		125	°C

### 7.4 Thermal Information

THERMAL METRIC <sup>(1)</sup>		TPS6217x	UNIT
		DSG (WS0N)	
		8 PINS	
R <sub>θJA</sub>	Junction-to-ambient thermal resistance	61.8	°C/W
R <sub>θJC(top)</sub>	Junction-to-case (top) thermal resistance	61.3	°C/W
R <sub>θJB</sub>	Junction-to-board thermal resistance	15.5	°C/W
ψ <sub>JT</sub>	Junction-to-top characterization parameter	0.4	°C/W
ψ <sub>JB</sub>	Junction-to-board characterization parameter	15.4	°C/W
R <sub>θJC(bot)</sub>	Junction-to-case (bottom) thermal resistance	8.6	°C/W

- (1) For more information about traditional and new thermal metrics, see the *Semiconductor and IC Package Thermal Metrics* application report, [SPRA953](#).

## 7.5 Electrical Characteristics

Over junction temperature range ( $T_J = -40^{\circ}\text{C}$  to  $+125^{\circ}\text{C}$ ), typical values at  $V_{IN} = 12\text{ V}$  and  $T_J = 25^{\circ}\text{C}$  (unless otherwise noted)

PARAMETER		TEST CONDITIONS	MIN	TYP	MAX	UNIT	
<b>SUPPLY</b>							
$V_{IN}$	Input voltage range <sup>(1)</sup>		3		17	V	
$I_Q$	Operating quiescent current	EN = High, $I_{OUT} = 0\text{ mA}$ , device not switching		17	30	$\mu\text{A}$	
			$T_J = -40^{\circ}\text{C}$ to $+85^{\circ}\text{C}$	17	25		
$I_{SD}$	Shutdown current <sup>(2)</sup>	EN = Low		1.5	25	$\mu\text{A}$	
			$T_J = -40^{\circ}\text{C}$ to $+85^{\circ}\text{C}$	1.5	4		
$V_{UVLO}$	Undervoltage lockout threshold	Falling input voltage	2.6	2.7	2.82	V	
		Hysteresis		180		mV	
$T_{SD}$	Thermal shutdown temperature	rising temperature		160		$^{\circ}\text{C}$	
	Thermal shutdown hysteresis	falling temperature		20			
<b>CONTROL (EN, PG)</b>							
$V_{EN\_H}$	High level input threshold voltage (EN)		0.9	0.6		V	
$V_{EN\_L}$	Low level input threshold voltage (EN)			0.56	0.3	V	
$I_{LKG\_EN}$	Input leakage current (EN)	EN = $V_{IN}$ or GND		0.01	1	$\mu\text{A}$	
$V_{TH\_PG}$	Power good threshold voltage	Rising (% $V_{OUT}$ )	92%	95%	98%		
		Falling (% $V_{OUT}$ )	87%	90%	93%		
$V_{OL\_PG}$	Power good output low voltage	$I_{PG} = -2\text{ mA}$		0.07	0.3	V	
$I_{LKG\_PG}$	Input leakage current (PG)	$V_{PG} = 1.8\text{ V}$		1	400	nA	
<b>POWER SWITCH</b>							
$R_{DS(ON)}$	High-side MOSFET ON-resistance	$V_{IN} \geq 6\text{ V}$		300	600	m $\Omega$	
		$V_{IN} = 3\text{ V}$		430			
	Low-side MOSFET ON-resistance	$V_{IN} \geq 6\text{ V}$		120	200	m $\Omega$	
		$V_{IN} = 3\text{ V}$		165			
$I_{LIMF}$	High-side MOSFET forward current limit <sup>(3)</sup>	$V_{IN} = 12\text{ V}$ , $T_J = 25^{\circ}\text{C}$	0.85	1.05	1.35	A	
<b>OUTPUT</b>							
$V_{REF}$	Internal reference voltage <sup>(4)</sup>			0.8		V	
$I_{LKG\_FB}$	Pin leakage current (FB)	TPS62170, $V_{FB} = 1.2\text{ V}$		5	400	nA	
$V_{OUT}$	Output voltage range (TPS62170)	$V_{IN} \geq V_{OUT}$		0.9	6.0	V	
		PWM mode operation, $V_{IN} \geq V_{OUT} + 1\text{ V}$		-3%	3%		
	Initial output voltage accuracy <sup>(5)</sup>	Power save mode operation, $C_{OUT} = 22\text{ }\mu\text{F}$		-3.5%		4%	
		DC output voltage load regulation	$V_{IN} = 12\text{ V}$ , $V_{OUT} = 3.3\text{ V}$ , PWM mode operation		0.05		%/A
	DC output voltage line regulation	$3\text{ V} \leq V_{IN} \leq 17\text{ V}$ , $V_{OUT} = 3.3\text{ V}$ , $I_{OUT} = 0.5\text{ A}$ , PWM mode operation			0.02		%/V

(1) The device is still functional down to under voltage lockout (see parameter  $V_{UVLO}$ ).

(2) Current into  $V_{IN}$  pin.

(3) This is the static current limit. It can be temporarily higher in applications due to internal propagation delay (see [Current Limit and Short Circuit Protection](#)).

(4) This is the voltage regulated at the FB pin.

(5) This is the accuracy provided by the device itself (line and load regulation effects are not included). For fixed voltage versions, the (internal) resistive feedback divider is included.

## 7.6 Typical Characteristics

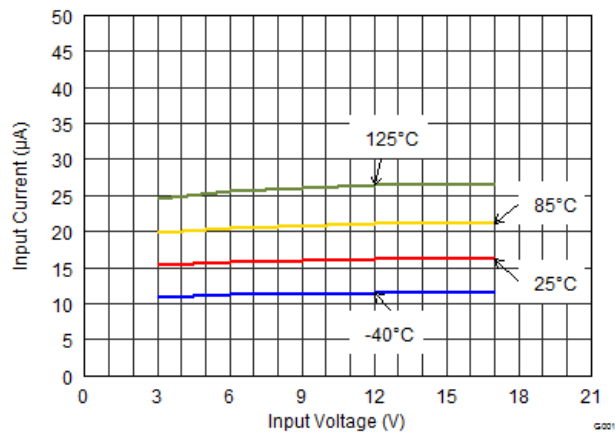

**Figure 1. Quiescent Current**

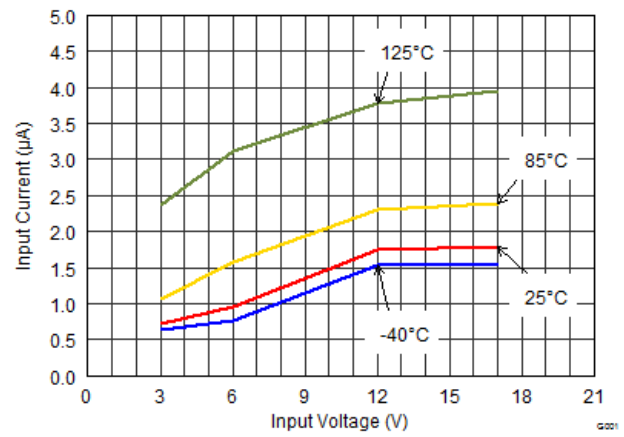

**Figure 2. Shutdown Current**

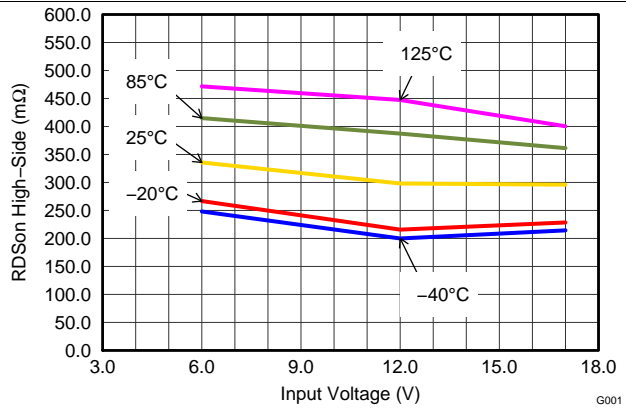

**Figure 3. High-Side Switch**

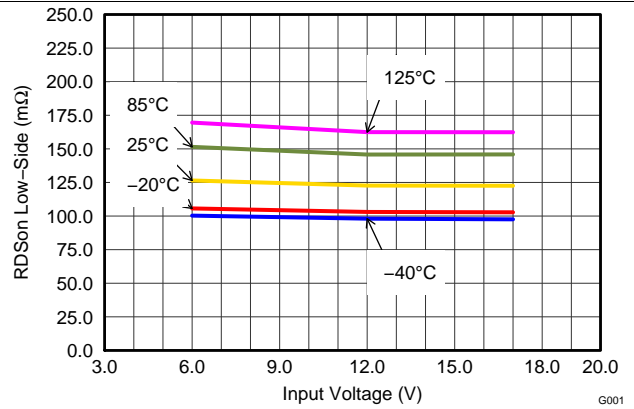

**Figure 4. Low-Side Switch**

## 8 Detailed Description

### 8.1 Overview

The TPS6217x synchronous step-down DC-DC converters are based on DCS-Control™ (Direct Control with Seamless transition into power save mode), an advanced regulation topology, that combines the advantages of hysteretic, voltage mode and current mode control including an AC loop directly associated to the output voltage. This control loop takes information about output voltage changes and feeds it directly to a fast comparator stage. It sets the switching frequency, which is constant for steady state operating conditions, and provides immediate response to dynamic load changes. To get accurate DC load regulation, a voltage feedback loop is used. The internally compensated regulation network achieves fast and stable operation with small external components and low ESR capacitors.

The DCS-Control™ topology supports pulse width modulation (PWM) mode for medium and heavy load conditions and a power save mode at light loads. During PWM mode, it operates at its nominal switching frequency in continuous conduction mode. This frequency is typically about 2.25 MHz with a controlled frequency variation depending on the input voltage. If the load current decreases, the converter enters power save mode to sustain high efficiency down to very light loads. In power save mode, the switching frequency decreases linearly with the load current. Since DCS-Control™ supports both operation modes within one single building block, the transition from PWM to power save mode is seamless without effects on the output voltage.

Fixed output voltage versions provide smallest solution size and lowest current consumption, requiring only 3 external components. An internal current limit supports nominal output currents of up to 500 mA.

The TPS6217x family offers both excellent DC voltage and superior load transient regulation, combined with very low output voltage ripple, minimizing interference with RF circuits.

### 8.2 Functional Block Diagram

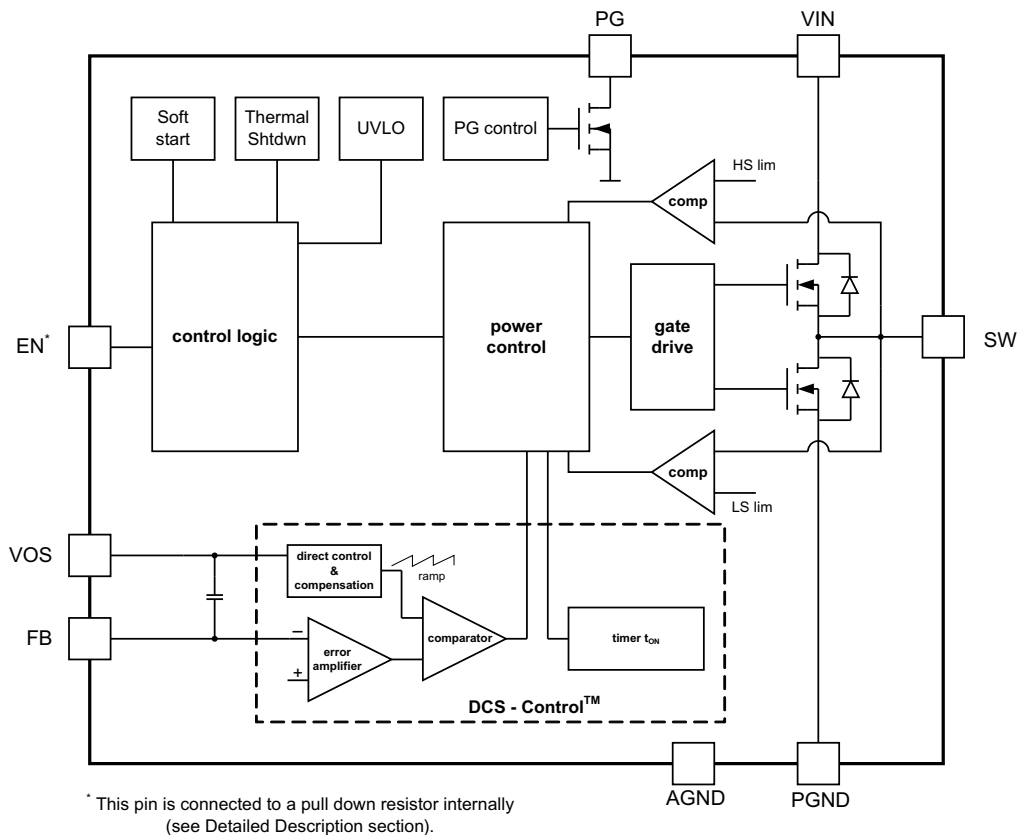
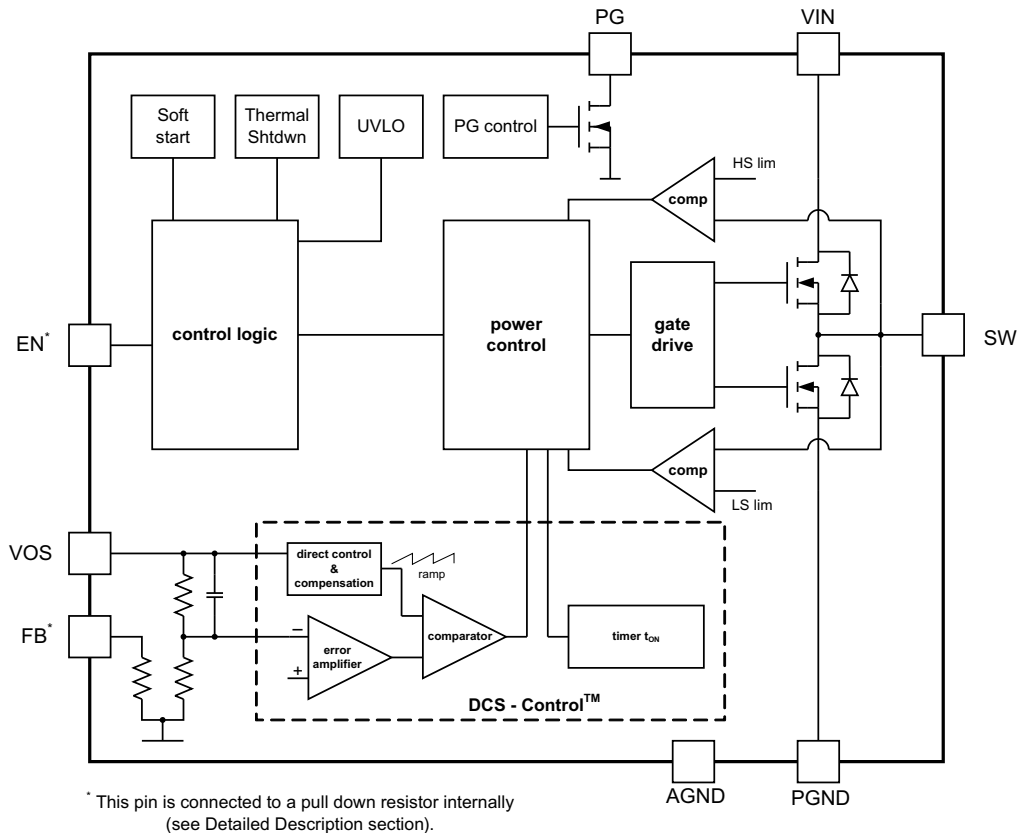

Figure 5. TPS62170 (Adjustable Output Voltage)

**Functional Block Diagram (continued)**

**Figure 6. TPS62171/TPS62172/TPS62173 (Fixed Output Voltage)**
**8.3 Feature Description**
**8.3.1 Enable and Shutdown (EN)**

When enable (EN) is set high, the device starts operation.

Shutdown is forced if EN is pulled low with a shutdown current of typically 1.5  $\mu$ A. During shutdown, the internal power MOSFETs as well as the entire control circuitry are turned off. The internal resistive divider pulls down the output voltage smoothly. If the EN pin is low, an internal pull-down resistor of about 400 k $\Omega$  is connected and keeps it low, to avoid bouncing.

Connecting the EN pin to an appropriate output signal of another power rail provides sequencing of multiple power rails.

**8.3.2 Current Limit and Short Circuit Protection**

The TPS6217x devices are protected against heavy load and short circuit events. At heavy loads, the current limit determines the maximum output current. If the current limit is reached, the high-side FET is turned off. Avoiding shoot-through current, the low-side FET is switched on to allow the inductor current to decrease. The high-side FET turns on again, only if the current in the low-side FET decreases below the low-side current limit threshold of typically 0.7A.

The output current of the device is limited by the current limit (see [Electrical Characteristics](#)). Due to internal propagation delay, the actual current can exceed the static current limit during that time. The dynamic current limit is calculated as follows:

## Feature Description (continued)

$$I_{peak(typ)} = I_{LIMF} + \frac{V_L}{L} \cdot t_{PD}$$

where

- $I_{LIMF}$  is the static current limit, specified in [Electrical Characteristics](#)
- $L$  is the inductor value
- $V_L$  is the voltage across the inductor
- $t_{PD}$  is the internal propagation delay

(1)

The dynamic high-side switch peak current is calculated as follows:

$$I_{peak(typ)} = I_{LIMF} + \frac{(V_{IN} - V_{OUT})}{L} \cdot 30ns$$

(2)

Take care with the current limit, if the input voltage is high and very small inductances are used.

### 8.3.3 Power Good (PG)

The TPS6217x has a built in power good (PG) function to indicate whether the output voltage has reached its appropriate level or not. The PG signal can be used for startup sequencing of multiple rails. The PG pin is an open-drain output that requires a pull-up resistor (to any voltage below 7 V). It can sink 2 mA of current and maintain its specified logic low level. It is high impedance when the device is turned off due to EN, UVLO or thermal shutdown. If not used, the PG pin should be connected to GND but may be left floating.

**Table 1. Power Good Pin Logic Table**

Device State		PG Logic Status	
		High Impedance	Low
Enable (EN=High)	$V_{FB} \geq V_{TH\_PG}$	√	
	$V_{FB} \leq V_{TH\_PG}$		√
Shutdown (EN=Low)		√	
UVLO	$0.7\text{ V} < V_{IN} < V_{UVLO}$	√	
Thermal Shutdown	$T_J > T_{SD}$	√	
Power Supply Removal	$V_{IN} < 0.7\text{ V}$	√	

### 8.3.4 Undervoltage Lockout (UVLO)

If the input voltage drops, the under voltage lockout prevents misoperation of the device by switching off both the power FETs. The under voltage lockout threshold is set typically to 2.7 V. The device is fully operational for voltages above the UVLO threshold and turns off if the input voltage trips the threshold. The converter starts operation again once the input voltage exceeds the threshold by a hysteresis of typically 180 mV.

### 8.3.5 Thermal Shutdown

The junction temperature ( $T_j$ ) of the device is monitored by an internal temperature sensor. If  $T_j$  exceeds 160°C (typical), the device goes into thermal shut down. Both the high-side and low-side power FETs are turned off and PG goes high impedance. When  $T_j$  decreases below the hysteresis amount, the converter resumes normal operation, beginning with soft start. To avoid unstable conditions, a hysteresis of typically 20°C is implemented on the thermal shut down temperature.

## 8.4 Device Functional Modes

### 8.4.1 Soft Start

The internal soft start circuitry controls the output voltage slope during startup. This avoids excessive inrush current and ensures a controlled output voltage rise time. It also prevents unwanted voltage drops from high-impedance power sources or batteries. When EN is set to start device operation, the device starts switching after a delay of about 50  $\mu\text{s}$  and  $V_{\text{OUT}}$  rises with a slope of about 25 mV/ $\mu\text{s}$ . See [Figure 30](#) and [Figure 31](#) for typical startup operation.

The TPS6217x can start into a pre-biased output. During monotonic pre-biased startup, the low-side MOSFET is not allowed to turn on until the device's internal ramp sets an output voltage above the pre-bias voltage.

### 8.4.2 Pulse Width Modulation (PWM) Operation

The TPS6217x operates with pulse width modulation in continuous conduction mode (CCM) with a nominal switching frequency of about 2.25 MHz. The frequency variation in PWM is controlled and depends on  $V_{\text{IN}}$ ,  $V_{\text{OUT}}$  and the inductance. The device operates in PWM mode as long the output current is higher than half the inductor's ripple current. To maintain high efficiency at light loads, the device enters power save mode at the boundary to discontinuous conduction mode (DCM). This happens if the output current becomes smaller than half the inductor's ripple current.

### 8.4.3 Power Save Mode Operation

The TPS6217x's built in power save mode is entered seamlessly, if the load current decreases. This secures a high efficiency in light load operation. The device remains in power save mode as long as the inductor current is discontinuous.

In power save mode the switching frequency decreases linearly with the load current maintaining high efficiency. The transition into and out of power save mode happens within the entire regulation scheme and is seamless in both directions.

TPS6217x includes a fixed on-time circuitry. This on-time, in steady-state operation, is estimated as:

$$t_{\text{ON}} = \frac{V_{\text{OUT}}}{V_{\text{IN}}} \cdot 420\text{ns} \quad (3)$$

For very small output voltages, the on-time increases beyond the result of [Equation 3](#), to stay above an absolute minimum on-time,  $t_{\text{ON}(\text{min})}$ , which is around 80 ns, to limit switching losses. The peak inductor current in PSM is approximated by:

$$I_{\text{LPSM}(\text{peak})} = \frac{(V_{\text{IN}} - V_{\text{OUT}})}{L} \cdot t_{\text{ON}} \quad (4)$$

When  $V_{\text{IN}}$  decreases to typically 15% above  $V_{\text{OUT}}$ , the TPS6217x does not enter power save mode, regardless of the load current. The device maintains output regulation in PWM mode.

### 8.4.4 100% Duty-Cycle Operation

The duty cycle of the buck converter is given by  $D = V_{\text{OUT}}/V_{\text{IN}}$  and increases as the input voltage comes close to the output voltage. In this case, the device starts 100% duty cycle operation turning on the high-side switch 100% of the time. The high-side switch stays turned on as long as the output voltage is below the internal setpoint. This allows the conversion of small input to output voltage differences, such as for the longest operation time of battery-powered applications. In 100% duty cycle mode, the low-side FET is switched off.

The minimum input voltage to maintain output voltage regulation, depending on the load current and the output voltage level, is calculated as:

**Device Functional Modes (continued)**

$$V_{IN(min)} = V_{OUT(min)} + I_{OUT} (R_{DS(on)} + R_L)$$

where

- $I_{OUT}$  is the output current
- $R_{DS(on)}$  is the  $R_{DS(on)}$  of the high-side FET
- $R_L$  is the DC resistance of the inductor used

(5)

## 9 Application and Implementation

### NOTE

Information in the following applications sections is not part of the TI component specification, and TI does not warrant its accuracy or completeness. TI's customers are responsible for determining suitability of components for their purposes. Customers should validate and test their design implementation to confirm system functionality.

### 9.1 Application Information

The TPS6217x device family are easy to use synchronous step-down DC-DC converters optimized for applications with high power density. A high switching frequency of typically 2.25 MHz allows the use of small inductors and provides fast transient response as well as high output voltage accuracy by utilization of the DCS-Control™ topology. With its wide operating input voltage range of 3 V to 17 V, the devices are ideally suited for systems powered from either a Li-Ion or other battery as well as from 12-V intermediate power rails. It supports up to 0.5-A continuous output current at output voltages between 0.9 V and 6 V (with 100% duty cycle mode).

### 9.2 Typical Application

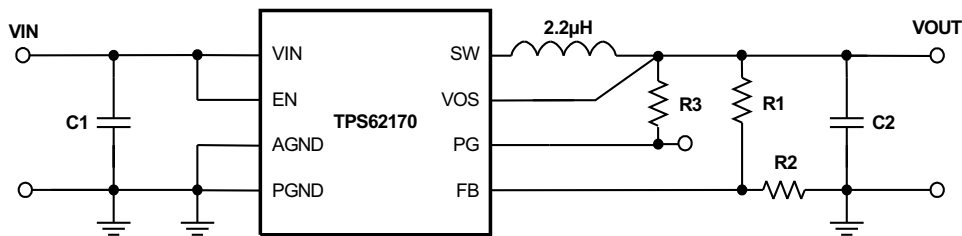

Figure 7. TPS62170 Adjustable Power Supply

#### 9.2.1 Design Requirements

The design guideline provides a component selection to operate the device within the [Recommended Operating Conditions](#).

#### 9.2.2 Detailed Design Procedure

##### 9.2.2.1 Custom Design with WEBENCH® Tools

[Click here](#) to create a custom design using the TPS62170 device with the WEBENCH® Power Designer.

1. Start by entering your  $V_{IN}$ ,  $V_{OUT}$ , and  $I_{OUT}$  requirements.
2. Optimize your design for key parameters like efficiency, footprint and cost using the optimizer dial and compare this design with other possible solutions from Texas Instruments.
3. The WEBENCH Power Designer provides you with a customized schematic along with a list of materials with real time pricing and component availability.
4. In most cases, you will also be able to:
  - Run electrical simulations to see important waveforms and circuit performance
  - Run thermal simulations to understand the thermal performance of your board
  - Export your customized schematic and layout into popular CAD formats
  - Print PDF reports for the design, and share your design with colleagues
5. Get more information about WEBENCH tools at [www.ti.com/WEBENCH](http://www.ti.com/WEBENCH).

## Typical Application (continued)

### 9.2.2.2 Programming the Output Voltage

While the output voltage of the TPS62170 is adjustable, the TPS62171/TPS62172/TPS62173 are programmed to fixed output voltages. For fixed output versions, the FB pin is pulled down internally and may be left floating. It is recommended to connect it to AGND to improve thermal resistance. The adjustable version can be programmed for output voltages from 0.9 V to 6 V by using a resistive divider from VOUT to AGND. The voltage at the FB pin is regulated to 800 mV. The value of the output voltage is set by the selection of the resistive divider from [Equation 6](#). It is recommended to choose resistor values which allow a current of at least 2 uA, meaning the value of R2 should not exceed 400 kΩ. Lower resistor values are recommended for highest accuracy and most robust design. For applications requiring lowest current consumption, the use of fixed output voltage versions is recommended.

$$R_1 = R_2 \left( \frac{V_{OUT}}{0.8V} - 1 \right) \quad (6)$$

In case the FB pin gets opened, the device clamps the output voltage at the VOS pin to about 7.4 V.

### 9.2.2.3 External Component Selection

The external components have to fulfill the needs of the application, but also the stability criteria of the devices control loop. The TPS6217x is optimized to work within a range of external components. The LC output filter's inductance and capacitance have to be considered together, creating a double pole, responsible for the corner frequency of the converter (see [Output Filter and Loop Stability](#)). [Table 2](#) can be used to simplify the output filter component selection. Checked cells represent combinations that are proven for stability by simulation and lab test. Further combinations should be checked for each individual application.

**Table 2. Recommended LC Output Filter Combinations<sup>(1)</sup>**

	4.7μF	10μF	22μF	47μF	100μF	200μF	400μF
1μH							
2.2μH		√	√ <sup>(2)</sup>	√	√	√	
3.3μH		√	√	√	√		
4.7μH							

(1) The values in the table are nominal values. Variations of typically ±20% due to tolerance, saturation and DC bias are assumed.

(2) This LC combination is the standard value and recommended for most applications.

More detailed information on further LC combinations can be found in [SLVA463](#).

#### 9.2.2.3.1 Inductor Selection

The inductor selection is affected by several effects like inductor ripple current, output ripple voltage, PWM-to-PSM transition point and efficiency. In addition, the inductor selected has to be rated for appropriate saturation current and DC resistance (DCR). [Equation 7](#) and [Equation 8](#) calculate the maximum inductor current under static load conditions.

$$I_{L(max)} = I_{OUT(max)} + \frac{\Delta I_{L(max)}}{2} \quad (7)$$

$$\Delta I_{L(\max)} = V_{OUT} \cdot \left( \frac{1 - \frac{V_{OUT}}{V_{IN(\max)}}}{L_{(\min)} \cdot f_{SW}} \right)$$

where

- $I_L(\max)$  is the maximum inductor current
- $\Delta I_L$  is the peak-to-peak inductor ripple current
- $L(\min)$  is the minimum effective inductor value
- $f_{SW}$  is the actual PWM switching frequency

(8)

Calculating the maximum inductor current using the actual operating conditions gives the minimum saturation current of the inductor needed. A margin of about 20% is recommended to add. A larger inductor value is also useful to get lower ripple current, but increases the transient response time and size as well. [Table 3](#) lists inductors that are recommended for use with the TPS6217x.

**Table 3. List of Inductors**

Type	Inductance [ $\mu\text{H}$ ]	Current [A] <sup>(1)</sup>	Dimensions [L x B x H] mm	MANUFACTURER
VLF3012ST-2R2M1R4	2.2 $\mu\text{H}$ , $\pm 20\%$	1.9 A	3.0 x 2.8 x 1.2	TDK
VLF302512MT-2R2M	2.2 $\mu\text{H}$ , $\pm 20\%$	1.9 A	3.0 x 2.5 x 1.2	TDK
VLS252012-2R2	2.2 $\mu\text{H}$ , $\pm 20\%$	1.3 A	2.5 x 2.0 x 1.2	TDK
XFL3012-222MEC	2.2 $\mu\text{H}$ , $\pm 20\%$	1.9 A	3.0 x 3.0 x 1.2	Coilcraft
XFL3012-332MEC	3.3 $\mu\text{H}$ , $\pm 20\%$	1.6 A	3.0 x 3.0 x 1.2	Coilcraft
XPL2010-222MLC	2.2 $\mu\text{H}$ , $\pm 20\%$	1.3 A	1.9 x 2.0 x 1.0	Coilcraft
XPL2010-332MLC	3.3 $\mu\text{H}$ , $\pm 20\%$	1.1 A	1.9 x 2.0 x 1.0	Coilcraft
LPS3015-332ML	3.3 $\mu\text{H}$ , $\pm 20\%$	1.4 A	3.0 x 3.0 x 1.4	Coilcraft
PFL2512-222ME	2.2 $\mu\text{H}$ , $\pm 20\%$	1.0 A	2.8 x 2.3 x 1.2	Coilcraft
PFL2512-333ME	3.3 $\mu\text{H}$ , $\pm 20\%$	0.78 A	2.8 x 2.3 x 1.2	Coilcraft
744028003	3.3 $\mu\text{H}$ , $\pm 30\%$	1.0 A	2.8 x 2.8 x 1.1	Wuerth
PSI25201B-2R2MS	2.2 $\mu\text{H}$ , $\pm 20\%$	1.3 A	2.0 x 2.5 x 1.2	Cyntec
NR3015T-2R2M	2.2 $\mu\text{H}$ , $\pm 20\%$	1.5 A	3.0 x 3.0 x 1.5	Taiyo Yuden
BRC2012T2R2MD	2.2 $\mu\text{H}$ , $\pm 20\%$	1.0 A	2.0 x 1.25 x 1.4	Taiyo Yuden
BRC2012T3R3MD	3.3 $\mu\text{H}$ , $\pm 20\%$	0.87 A	2.0 x 1.25 x 1.4	Taiyo Yuden

(1)  $I_{RMS}$  at 40°C rise or  $I_{SAT}$  at 30% drop.

TPS6217x can operate with an inductor as low as 2.2  $\mu\text{H}$ . However, for applications running with low input voltages, 3.3  $\mu\text{H}$  is recommended, to allow the full output current. The inductor value also determines the load current at which power save mode is entered:

$$I_{load(PSM)} = \frac{1}{2} \Delta I_L$$

(9)

Using [Equation 8](#), this current level is adjusted by changing the inductor value.

### 9.2.2.4 Capacitor Selection

#### 9.2.2.4.1 Output Capacitor

The recommended value for the output capacitor is 22  $\mu\text{F}$ . The architecture of the TPS6217x allows the use of tiny ceramic output capacitors with low equivalent series resistance (ESR). These capacitors provide low output voltage ripple and are recommended. To keep its low resistance up to high frequencies and to get narrow capacitance variation with temperature, it is recommended to use an X7R or X5R dielectric. Using a higher value can have some advantages like smaller voltage ripple and a tighter DC output accuracy in power save mode (see [SLVA463](#)).

Note: In power save mode, the output voltage ripple depends on the output capacitance, its ESR and the peak inductor current. Using ceramic capacitors provides small ESR and low ripple.

#### 9.2.2.4.2 Input Capacitor

For most applications, 10  $\mu\text{F}$  is sufficient and is recommended, though a larger value reduces input current ripple further. The input capacitor buffers the input voltage for transient events and also decouples the converter from the supply. A low ESR multilayer ceramic capacitor is recommended for best filtering and should be placed between VIN and PGND as close as possible to those pins.

---

#### NOTE

**DC bias effect:** High capacitance ceramic capacitors have a DC bias effect, which has a strong influence on the final effective capacitance. Therefore the right capacitor value has to be chosen carefully. Package size and voltage rating in combination with dielectric material are responsible for differences between the rated capacitor value and the effective capacitance.

---

### 9.2.2.5 Output Filter and Loop Stability

The devices of the TPS6217x family are internally compensated to be stable with L-C filter combinations corresponding to a corner frequency calculated with [Equation 10](#):

$$f_{LC} = \frac{1}{2\pi \sqrt{L \cdot C}} \quad (10)$$

Proven nominal values for inductance and ceramic capacitance are given in [Table 2](#) and are recommended for use. Different values may work, but care has to be taken on the loop stability which is affected. More information including a detailed L-C stability matrix is found in [SLVA463](#).

The TPS6217x devices, both fixed and adjustable versions, include an internal 25 pF feed forward capacitor, connected between the VOS and FB pins. This capacitor impacts the frequency behavior and sets a pole and zero in the control loop with the resistors of the feedback divider, per [Equation 11](#) and [Equation 12](#):

$$f_{zero} = \frac{1}{2\pi \cdot R_1 \cdot 25 \text{ pF}} \quad (11)$$

$$f_{pole} = \frac{1}{2\pi \cdot 25 \text{ pF}} \cdot \left( \frac{1}{R_1} + \frac{1}{R_2} \right) \quad (12)$$

Though the TPS6217x devices are stable without the pole and zero being in a particular location, adjusting their location to the specific needs of the application can provide better performance in power save mode and/or improved transient response. An external feed-forward capacitor can also be added. A more detailed discussion on the optimization for stability vs. transient response can be found in [SLVA289](#) and [SLVA466](#).

If using ceramic capacitors, the DC bias effect has to be considered. The DC bias effect results in a drop in effective capacitance as the voltage across the capacitor increases (see **NOTE** in Capacitor selection section).

### 9.2.2.6 TPS6216x Components List

Table 4 shows the list of components for the [Application Curves](#).

**Table 4. List of Components**

REFERENCE	DESCRIPTION	MANUFACTURER
IC	17 V, 0.5A Step-Down Converter, WSON	TPS62170DSG, Texas Instruments
L1	2.2 $\mu$ H, 1.4 A, 3 mm x 2.8 mm x 1.2 mm	VLF3012ST-2R2M1R4, TDK
C1	10 $\mu$ F, 25 V, Ceramic, 0805	Standard
C2	22 $\mu$ F, 6.3 V, Ceramic, 0805	Standard
R1	depending on $V_{OUT}$	
R2	depending on $V_{OUT}$	
R3	100 k $\Omega$ , Chip, 0603, 1/16 W, 1%	Standard

### 9.2.3 Application Curves

$V_{IN} = 12V$ ,  $V_{OUT} = 3.3V$ ,  $T_A = 25^\circ C$ , (unless otherwise noted)

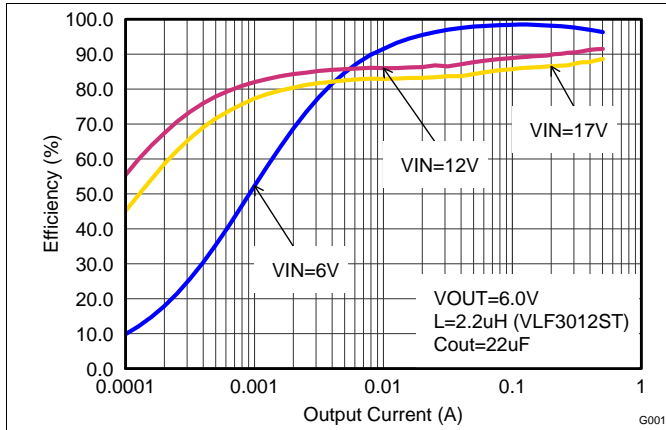

Figure 8. Efficiency vs Output Current,  $V_{OUT} = 6 V$

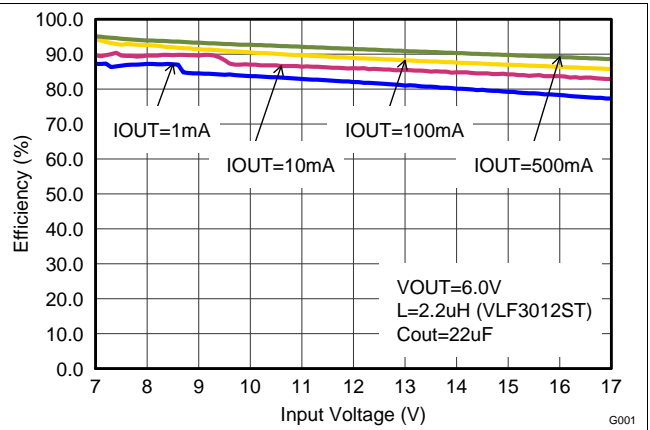

Figure 9. Efficiency vs Input Voltage,  $V_{OUT} = 6 V$

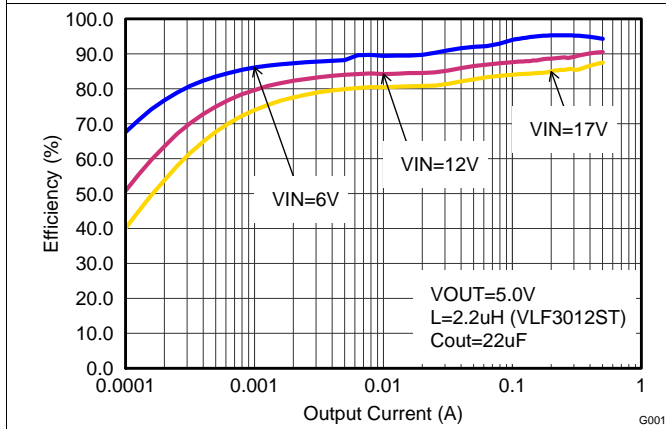

Figure 10. Efficiency vs Output Current,  $V_{OUT} = 5 V$

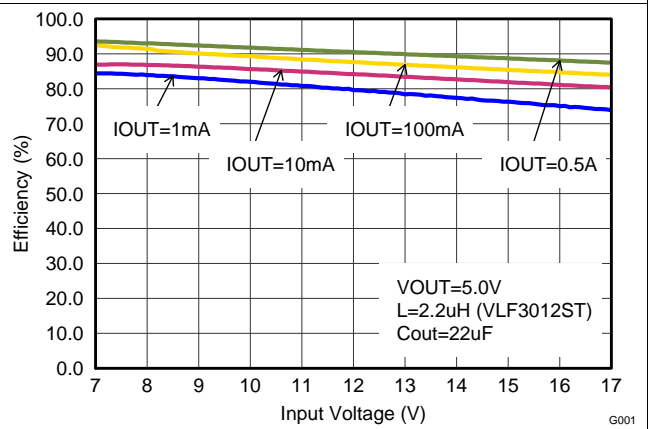

Figure 11. Efficiency vs Input Voltage,  $V_{OUT} = 5 V$

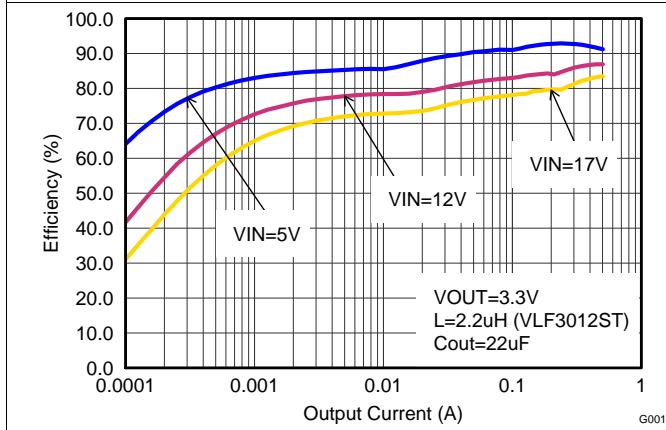

Figure 12. Efficiency vs Output Current,  $V_{OUT} = 3.3 V$

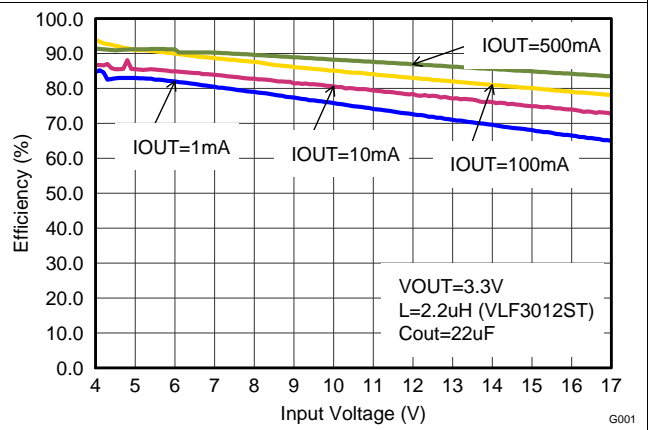

Figure 13. Efficiency vs Input Voltage,  $V_{OUT} = 3.3 V$

$V_{IN} = 12V$ ,  $V_{OUT} = 3.3V$ ,  $T_A = 25^\circ C$ , (unless otherwise noted)

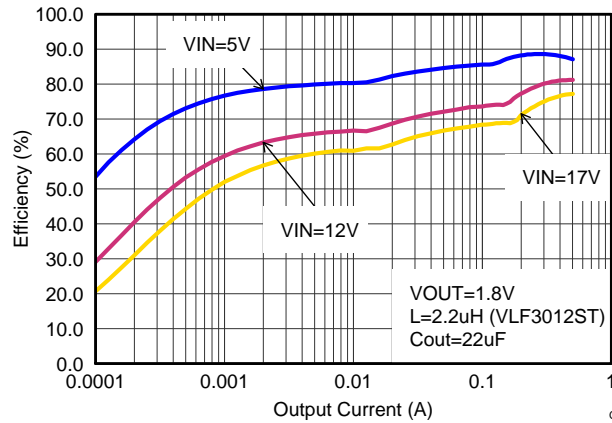

Figure 14. Efficiency vs Output Current,  $V_{OUT} = 1.8 V$

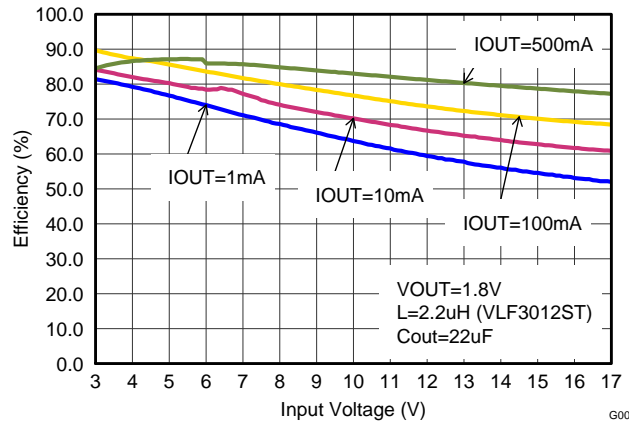

Figure 15. Efficiency vs Input Voltage,  $V_{OUT} = 1.8 V$

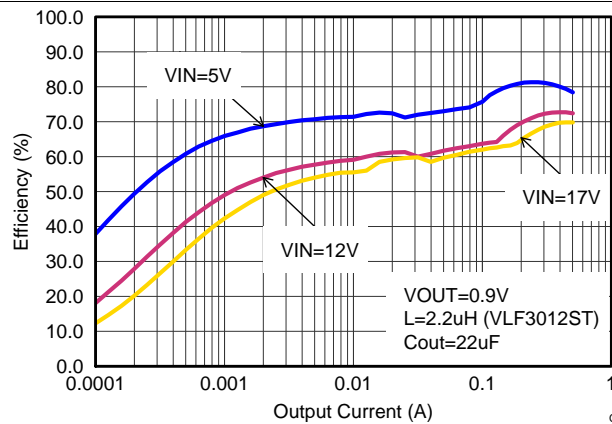

Figure 16. Efficiency vs Output Current,  $V_{OUT} = 0.9 V$

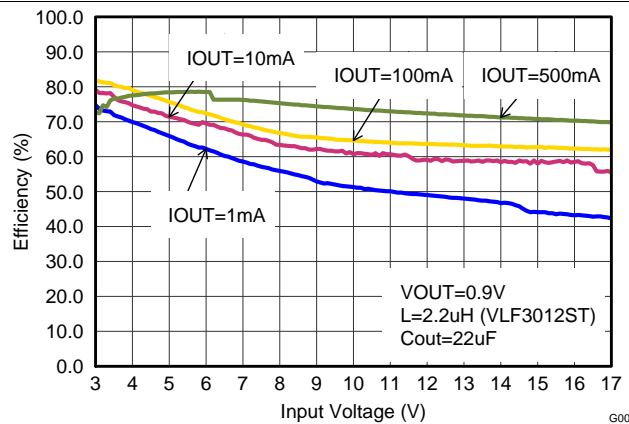

Figure 17. Efficiency vs Input Voltage,  $V_{OUT} = 0.9 V$

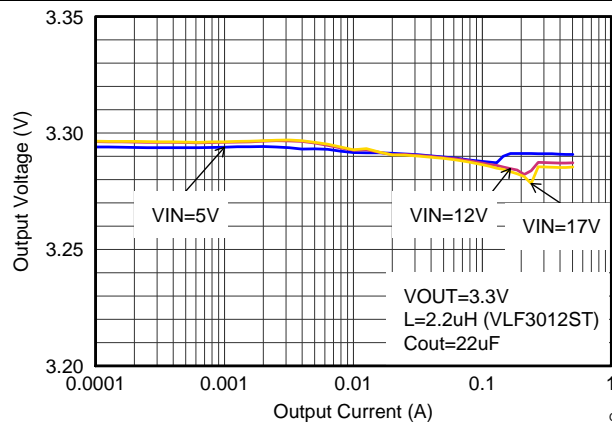

Figure 18. Output Voltage Accuracy (Load Regulation)

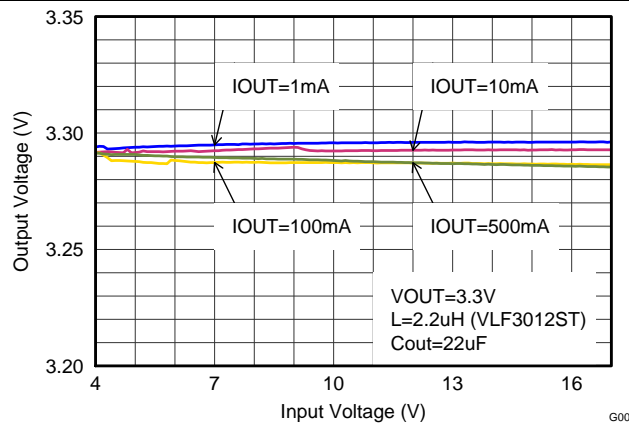
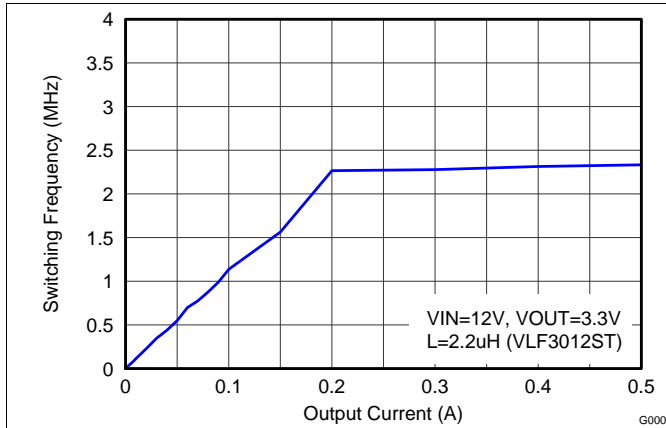
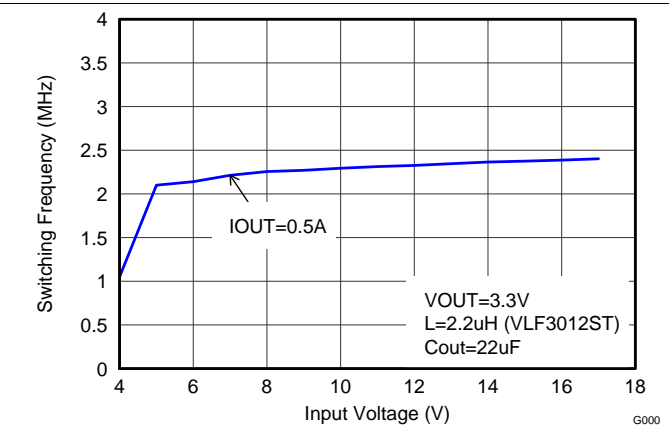

Figure 19. Output Voltage Accuracy (Line Regulation)

$V_{IN} = 12V$ ,  $V_{OUT} = 3.3V$ ,  $T_A = 25^\circ C$ , (unless otherwise noted)



**Figure 20. Switching Frequency vs Output Current**



**Figure 21. Switching Frequency vs Input Voltage**

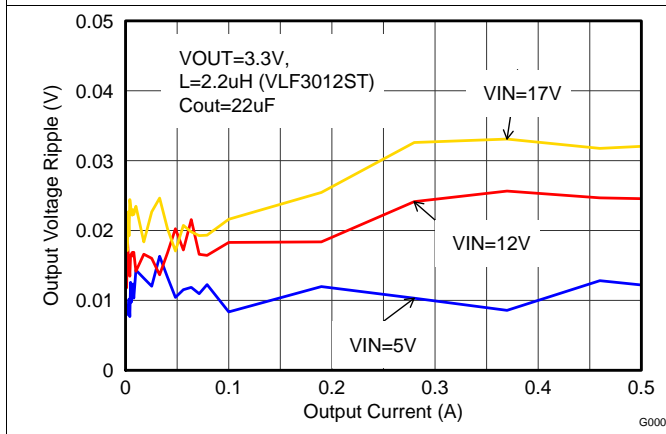

**Figure 22. Output Voltage Ripple**

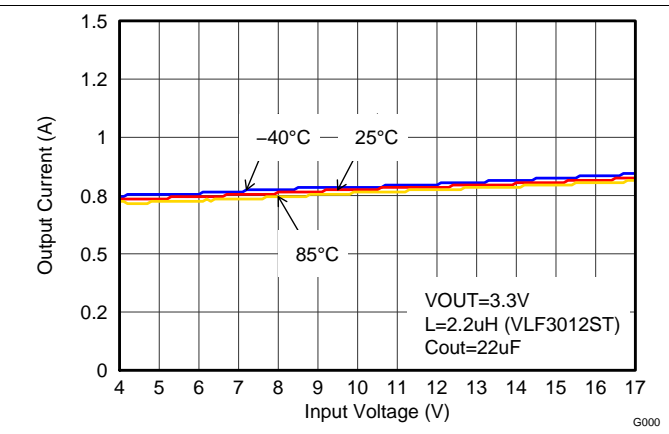

**Figure 23. Maximum Output Current**

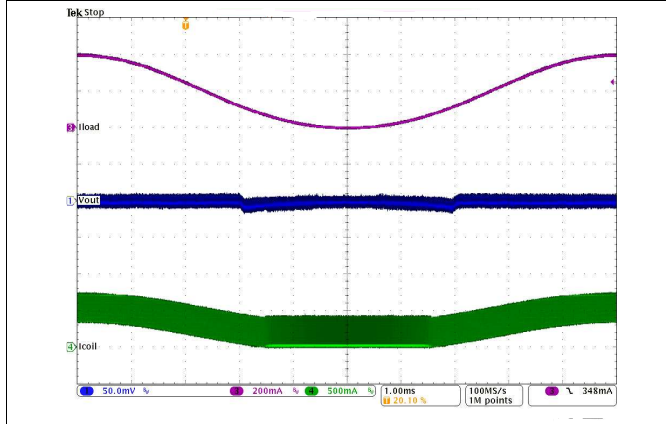

**Figure 24. PWM to PSM Mode Transition**

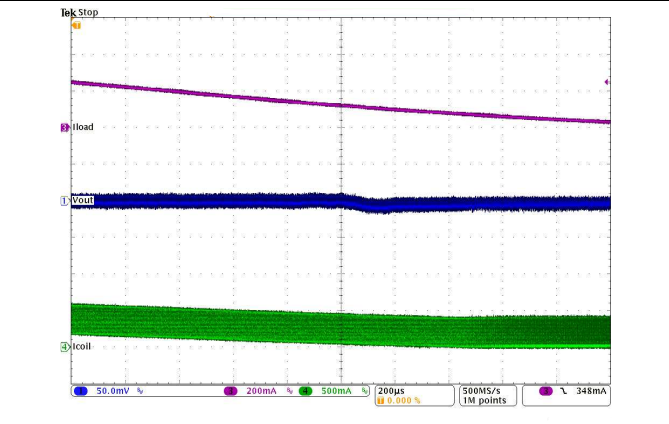

**Figure 25. PSM to PWM Mode Transition**

$V_{IN} = 12V$ ,  $V_{OUT} = 3.3V$ ,  $T_A = 25^\circ C$ , (unless otherwise noted)

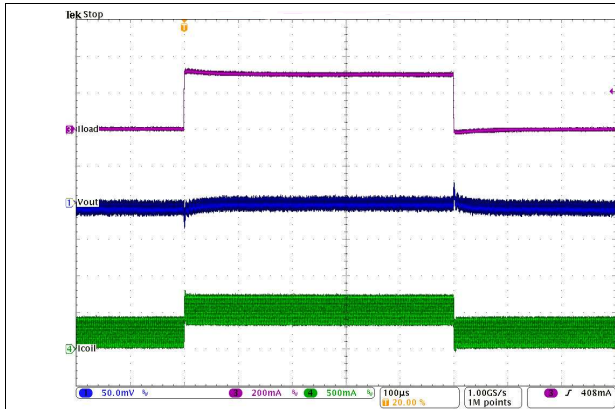

Figure 26. Load Transient Response in PWM Mode (200 mA to 500 mA)

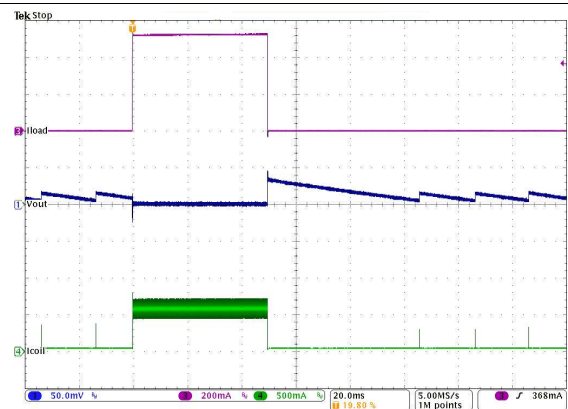

Figure 27. Load Transient Response from Power Save Mode (100 mA to 500 mA)

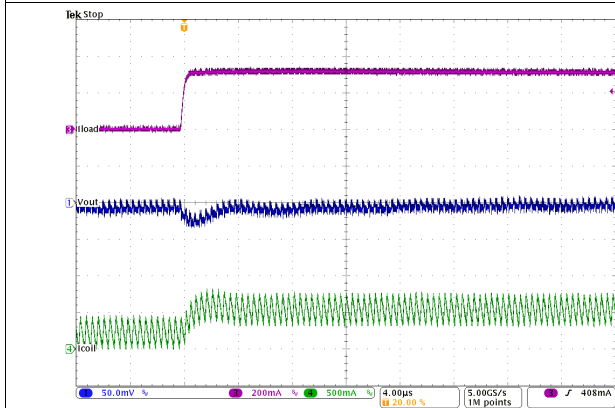

Figure 28. Load Transient Response in PWM Mode (200 mA to 500 mA), Rising Edge

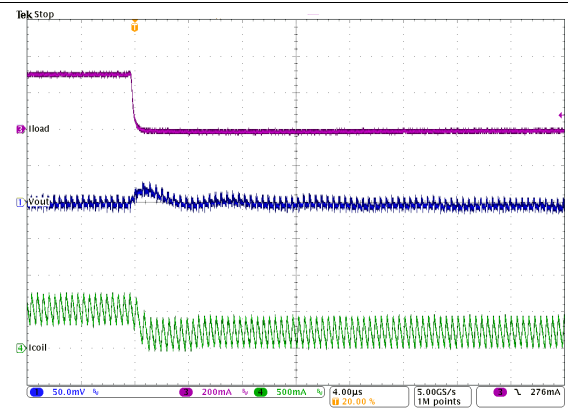

Figure 29. Load Transient Response in PWM Mode (200 mA to 500 mA), Falling Edge

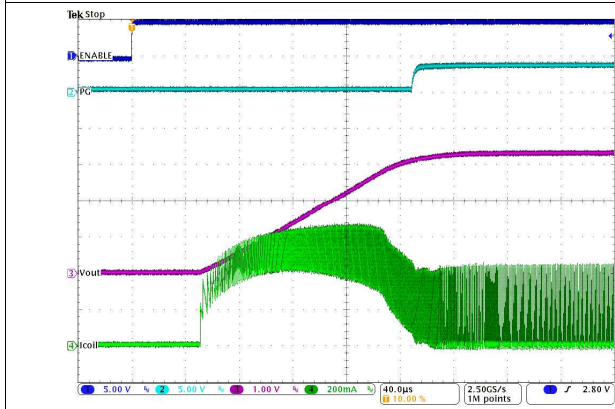

Figure 30. Startup with  $I_{OUT} = 500\text{ mA}$ ,  $V_{OUT} = 3.3\text{ V}$

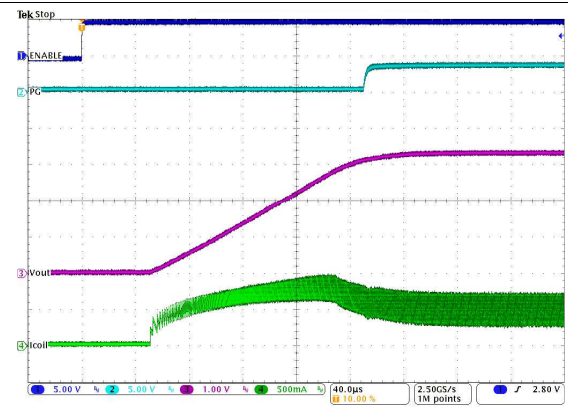
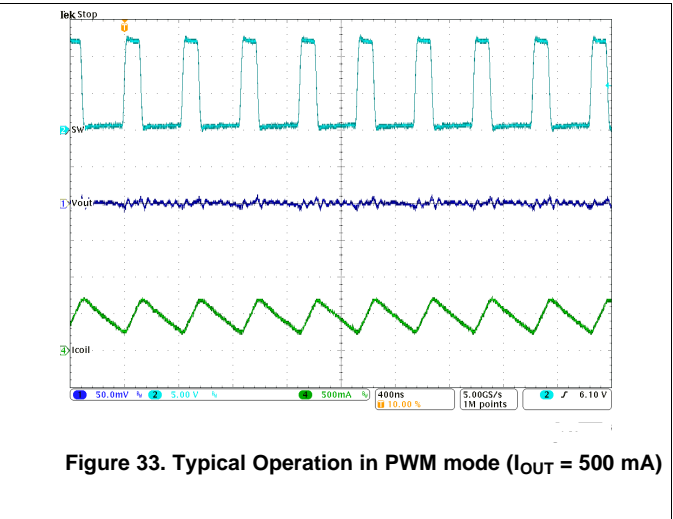
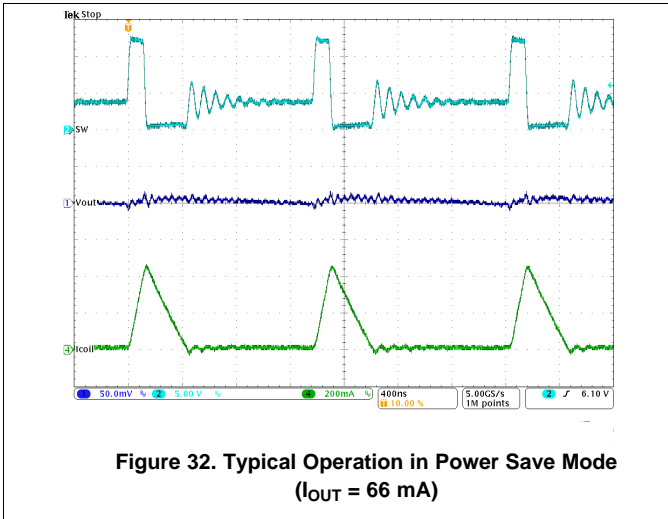

Figure 31. Startup with  $I_{OUT} = 500\text{ mA}$ ,  $V_{OUT} = 3.3\text{ V}$

$V_{IN} = 12V$ ,  $V_{OUT} = 3.3V$ ,  $T_A = 25^\circ C$ , (unless otherwise noted)



### 9.3 System Examples

Figure 34 through Figure 40 show various TPS6217x devices and input voltages that provide a 0.5-A power supply with output voltage options.

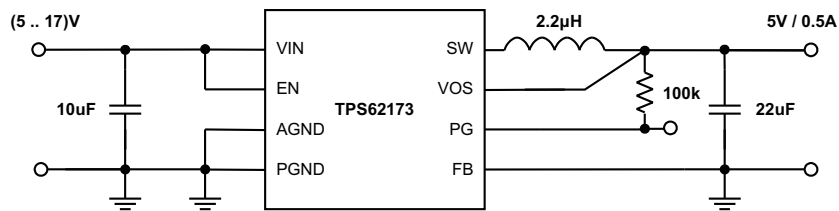

**Figure 34. 5-V and 0.5-A Power Supply**

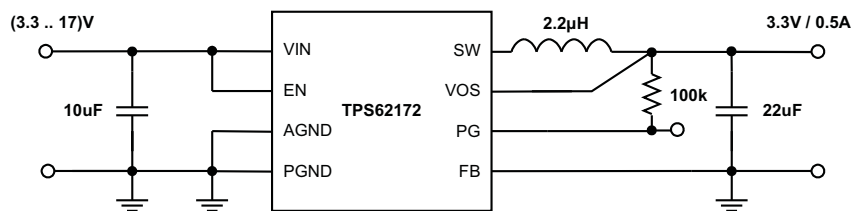

**Figure 35. 3.3-V and 0.5-A Power Supply**

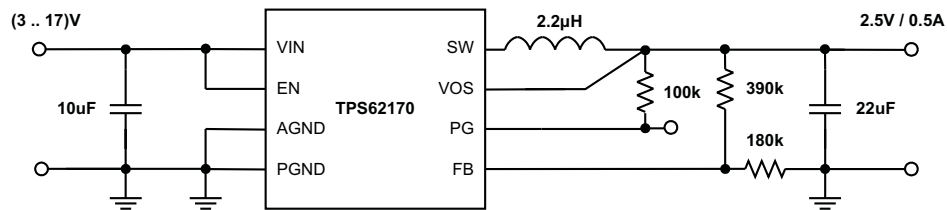
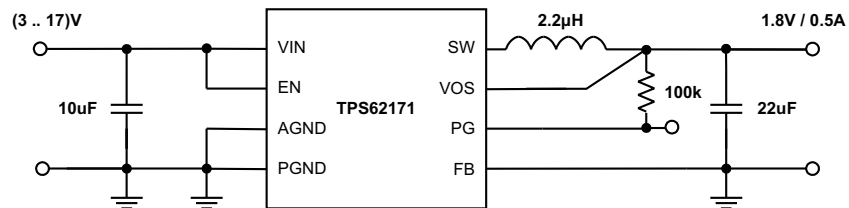
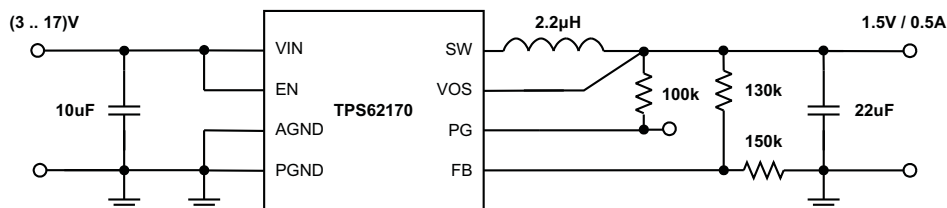
**System Examples (continued)**

**Figure 36. 2.5-V and 0.5-A Power Supply**

**Figure 37. 1.8-V and 0.5-A Power Supply**

**Figure 38. 1.5-V and 0.5-A Power Supply**

System Examples (continued)

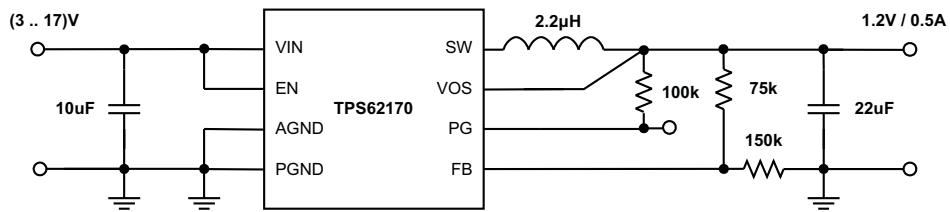

Figure 39. 1.2-V and 0.5-A Power Supply

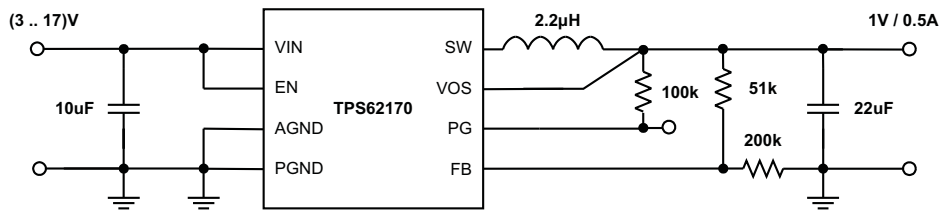

Figure 40. 1-V and 0.5-A Power Supply

## System Examples (continued)

### 9.3.1 Inverting Power Supply

The TPS6217x can be used as inverting power supply by rearranging external circuitry as shown in [Figure 41](#). As the former GND node now represents a voltage level below system ground, the voltage difference between  $V_{IN}$  and  $V_{OUT}$  has to be limited for operation to the maximum supply voltage of 17 V (see [Equation 13](#)).

$$V_{IN} + |V_{OUT}| \leq V_{INmax} \quad (13)$$

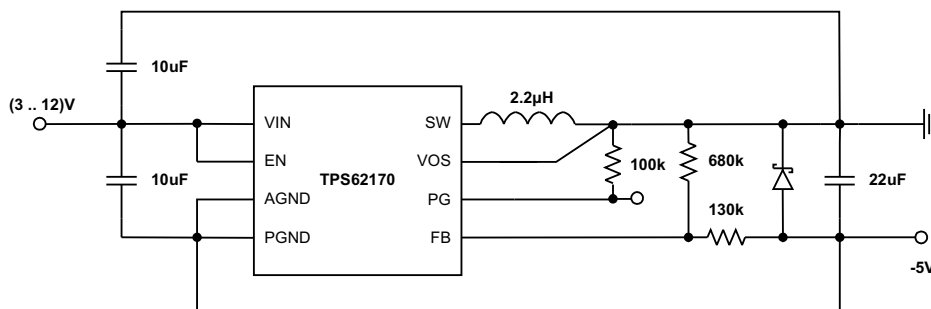

**Figure 41. -5-V Inverting Power Supply**

The transfer function of the inverting power supply configuration differs from the buck mode transfer function, incorporating a right half plane zero additionally. The loop stability has to be adapted and an output capacitance of at least 22 µF is recommended. A detailed design example is given in [SLVA469](#).

## 10 Power Supply Recommendations

The TPS6217x device family has no special requirements for its input power supply. The input power supply's output current needs to be rated according to the supply voltage, output voltage and output current of the TPS6217x.

## 11 Layout

### 11.1 Layout Guidelines

A proper layout is critical for the operation of a switched mode power supply, even more at high switching frequencies. Therefore the PCB layout of the TPS6217x demands careful attention to ensure operation and to get the performance specified. A poor layout can lead to issues like poor regulation (both line and load), stability and accuracy weaknesses, increased EMI radiation and noise sensitivity.

Provide low inductive and resistive paths to ground for loops with high  $di/dt$ . Therefore paths conducting the switched load current should be as short and wide as possible. Provide low capacitive paths (with respect to all other nodes) for wires with high  $dv/dt$ . Therefore the input and output capacitance should be placed as close as possible to the IC pins and parallel wiring over long distances as well as narrow traces should be avoided. Loops which conduct an alternating current should outline an area as small as possible, as this area is proportional to the energy radiated.

Also sensitive nodes like FB and VOS should be connected with short wires, not nearby high  $dv/dt$  signals (such as SW). As they carry information about the output voltage, they should be connected as close as possible to the actual output voltage (at the output capacitor). Signals not assigned to power transmission (such as the feedback divider) should refer to the signal ground (AGND) and always be separated from the power ground (PGND).

In summary, the input capacitor should be placed as close as possible to the VIN and PGND pin of the IC. This connections should be done with wide and short traces. The output capacitor should be placed such that its ground is as close as possible to the IC's PGND pins - avoiding additional voltage drop in traces. This connection should also be made short and wide. The inductor should be placed close to the SW pin and connect directly to the output capacitor - minimizing the loop area between the SW pin, inductor, output capacitor and PGND pin. The feedback resistors,  $R_1$  and  $R_2$ , should be placed close to the IC and connect directly to the AGND and FB pins. Those connections (including VOUT) to the resistors and even more to the VOS pin should stay away from noise sources, such as the inductor. The VOS pin should connect in the shortest way to VOUT at the output capacitor, while the VOUT connection to the feedback divider can connect at the load.

A single point grounding scheme should be implemented with all grounds (AGND, PGND and the thermal pad) connecting at the IC's exposed thermal pad. See [Figure 42](#) for the recommended layout of the TPS6217x. More detailed information can be found in the EVM Users Guide, [SLVU483](#).

The exposed thermal pad must be soldered to the circuit board for mechanical reliability and to achieve appropriate power dissipation. Although the exposed thermal pad can be connected to a floating circuit board trace, the device has better thermal performance if it is connected to a larger ground plane. The exposed thermal pad is electrically connected to AGND.

### 11.2 Layout Example

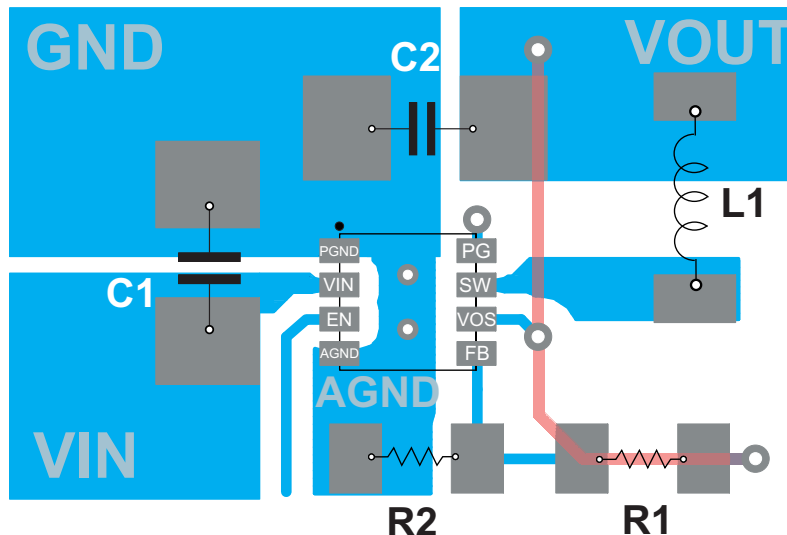

**Figure 42. Layout Example**

### 11.3 Thermal Considerations

Implementation of integrated circuits in low-profile and fine-pitch surface-mount packages typically requires special attention to power dissipation. Many system-dependent issues such as thermal coupling, airflow, added heat sinks and convection surfaces, and the presence of other heat-generating components affect the power-dissipation limits of a given component.

Three basic approaches for enhancing thermal performance are listed below:

- Improving the power dissipation capability of the PCB design
- Improving the thermal coupling of the component to the PCB by soldering the exposed thermal pad
- Introducing airflow in the system

For more details on how to use the thermal parameters, see the application notes: Thermal Characteristics Application Note [SZZA017](#), and [SPRA953](#).

The TPS6217x is designed for a maximum operating junction temperature ( $T_j$ ) of 125°C. Therefore the maximum output power is limited by the power losses that can be dissipated over the actual thermal resistance, given by the package and the surrounding PCB structures. If the thermal resistance of the package is given, the size of the surrounding copper area and a proper thermal connection of the IC can reduce the thermal resistance. To get an improved thermal behavior, it is recommended to use top layer metal to connect the device with wide and thick metal lines. Internal ground layers can connect to vias directly under the IC for improved thermal performance.

If short circuit or overload conditions are present, the device is protected by limiting internal power dissipation.

## 12 器件和文档支持

### 12.1 器件支持

#### 12.1.1 Third-Party Products Disclaimer

TI'S PUBLICATION OF INFORMATION REGARDING THIRD-PARTY PRODUCTS OR SERVICES DOES NOT CONSTITUTE AN ENDORSEMENT REGARDING THE SUITABILITY OF SUCH PRODUCTS OR SERVICES OR A WARRANTY, REPRESENTATION OR ENDORSEMENT OF SUCH PRODUCTS OR SERVICES, EITHER ALONE OR IN COMBINATION WITH ANY TI PRODUCT OR SERVICE.

#### 12.1.2 开发支持

##### 12.1.2.1 使用 **WEBENCH®** 工具定制设计方案

请单击[此处](#)，结合使用 TPS6217x 器件和 WEBENCH® 电源设计器创建定制设计方案。

1. 在开始阶段键入输出电压 ( $V_{IN}$ )、输出电压 ( $V_{OUT}$ ) 和输出电流 ( $I_{OUT}$ ) 要求。
2. 使用优化器拨盘优化关键设计参数，如效率、封装和成本。
3. 将生成的设计与德州仪器 (TI) 的其他解决方案进行比较。

WEBENCH Power Designer 提供一份定制原理图以及罗列实时价格和组件可用性的物料清单。

在多数情况下，可执行以下操作：

- 运行电气仿真，观察重要波形以及电路性能
- 运行热性能仿真，了解电路板热性能
- 将定制原理图和布局方案导出至常用 CAD 格式
- 打印设计方案的 PDF 报告并与同事共享

有关 WEBENCH 工具的详细信息，请访问 [www.ti.com/WBENCH](http://www.ti.com/WBENCH)。

### 12.2 文档支持

#### 12.2.1 相关文档

请参阅如下相关文档：

- 《具有 DCS-Control™ 的 TPS62160 3V 至 17V 1A 降压转换器》，[TPS62160](#)
- 《具有可调节启用阈值和迟滞的 TPS62125 3V 至 17V 300mA 降压转换器》，[TPS62125](#)
- 《优化 TPS62130/40/50/60/70 输出滤波器》，[SLVA463](#)
- 《采用前馈电容优化内部补偿 DC-DC 转换器的瞬态响应》，[SLVA289](#)
- 《采用前馈电容提升 TPS62130/40/50/60/70 的稳定性和带宽》，[SLVA466](#)
- 《在反向降压-升压拓扑中使用 TPS6215x》，[SLVA469](#)
- 《TPS62160EVM 和 TPS62170EVM-627 评估模块》，[SLVU483](#)
- 《采用 JEDEC PCB 设计的线性和逻辑封装散热特性》，[SZZA017](#)

#### 12.3 相关链接

下面的表格列出了快速访问链接。类别包括技术文档、支持与社区资源、工具和软件，以及申请样片或购买产品的快速链接。

表 5. 相关链接

器件	产品文件夹	样片与购买	技术文档	工具和软件	支持和社区
TPS62170	<a href="#">请单击此处</a>	<a href="#">请单击此处</a>	<a href="#">请单击此处</a>	<a href="#">请单击此处</a>	<a href="#">请单击此处</a>
TPS62171	<a href="#">请单击此处</a>	<a href="#">请单击此处</a>	<a href="#">请单击此处</a>	<a href="#">请单击此处</a>	<a href="#">请单击此处</a>
TPS62172	<a href="#">请单击此处</a>	<a href="#">请单击此处</a>	<a href="#">请单击此处</a>	<a href="#">请单击此处</a>	<a href="#">请单击此处</a>
TPS62173	<a href="#">请单击此处</a>	<a href="#">请单击此处</a>	<a href="#">请单击此处</a>	<a href="#">请单击此处</a>	<a href="#">请单击此处</a>

## 12.4 社区资源

下列链接提供到 TI 社区资源的连接。链接的内容由各个分销商“按照原样”提供。这些内容并不构成 TI 技术规范，并且不一定反映 TI 的观点；请参阅 TI 的《[使用条款](#)》。

**TI E2E™ 在线社区** *TI 的工程师对工程师 (E2E) 社区*。此社区的创建目的在于促进工程师之间的协作。在 [e2e.ti.com](http://e2e.ti.com) 中，您可以咨询问题、分享知识、拓展思路并与同行工程师一道帮助解决问题。

**设计支持** *TI 参考设计支持* 可帮助您快速查找有帮助的 E2E 论坛、设计支持工具以及技术支持的联系信息。

## 12.5 商标

DCS-Control, E2E are trademarks of Texas Instruments.

WEBENCH is a registered trademark of Texas Instruments.

All other trademarks are the property of their respective owners.

## 12.6 静电放电警告



这些装置包含有限的内置 ESD 保护。存储或装卸时，应将导线一起截短或将装置放置于导电泡棉中，以防止 MOS 门极遭受静电损伤。

## 12.7 Glossary

[SLYZ022](#) — *TI Glossary*.

This glossary lists and explains terms, acronyms, and definitions.

### **13 机械、封装和可订购信息**

以下页面包括机械、封装和可订购信息。这些信息是指定器件的最新可用数据。这些数据发生变化时，我们可能不会另行通知或修订此文档。如欲获取此产品说明书的浏览器版本，请参见左侧的导航栏。

**DSG0008A**
**PACKAGE OUTLINE**
**WSON - 0.8 mm max height**

PLASTIC SMALL OUTLINE - NO LEAD

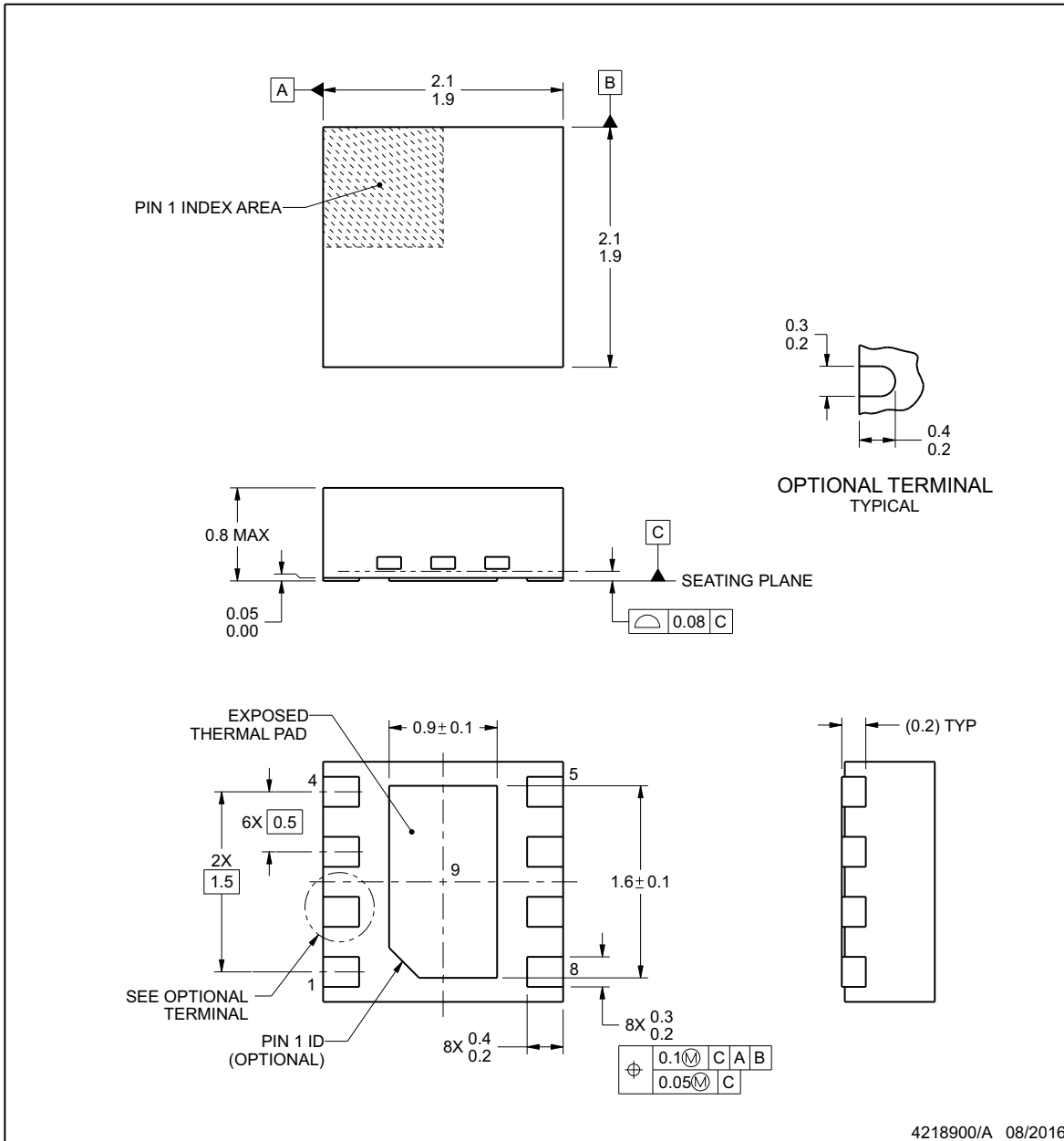

4218900/A 08/2016

**NOTES:**

1. All linear dimensions are in millimeters. Any dimensions in parenthesis are for reference only. Dimensioning and tolerancing per ASME Y14.5M.
2. This drawing is subject to change without notice.
3. The package thermal pad must be soldered to the printed circuit board for thermal and mechanical performance.

## EXAMPLE BOARD LAYOUT

DSG0008A

WSON - 0.8 mm max height

PLASTIC SMALL OUTLINE - NO LEAD

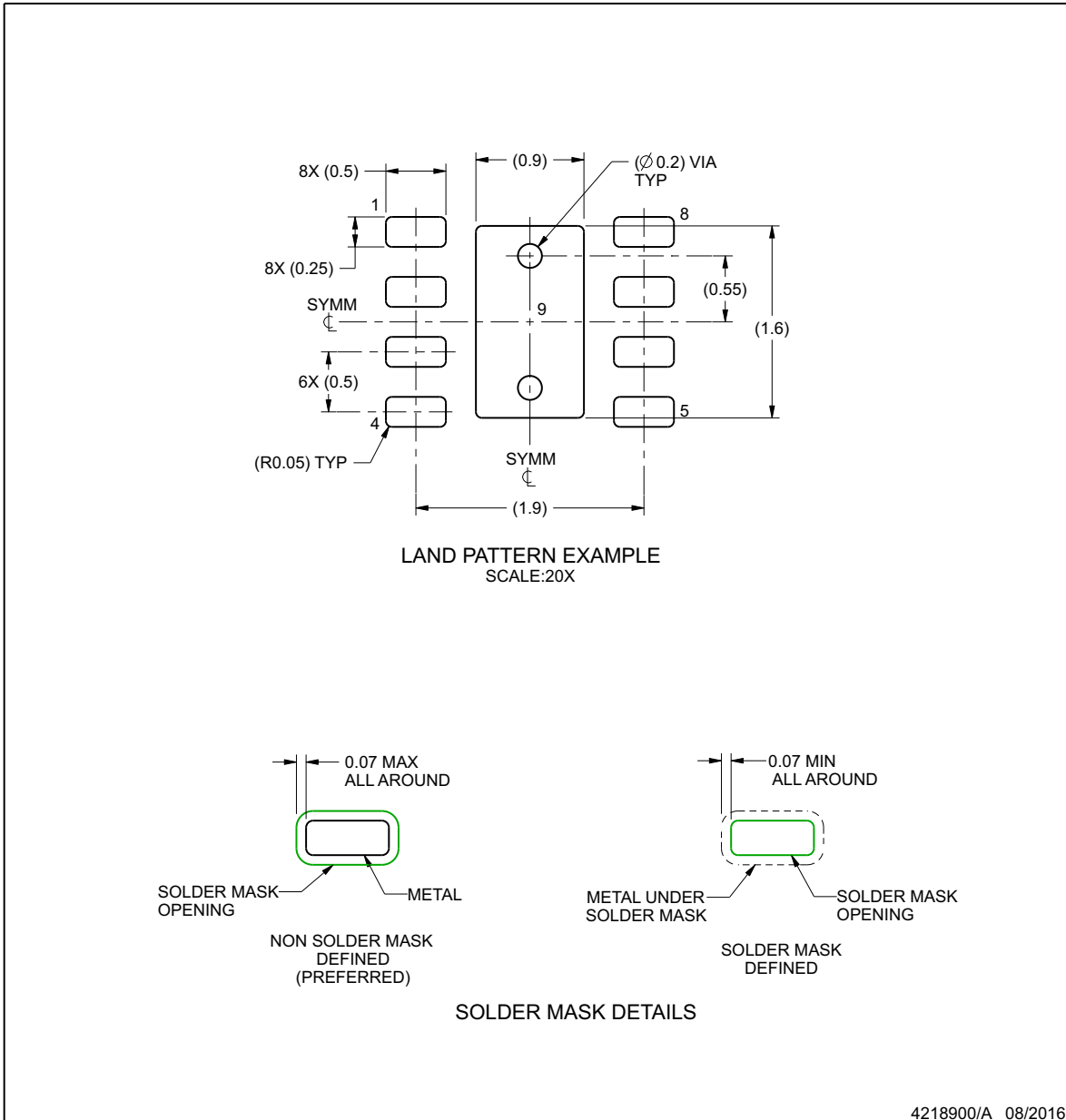

NOTES: (continued)

- This package is designed to be soldered to a thermal pad on the board. For more information, see Texas Instruments literature number SLUA271 ([www.ti.com/lit/slua271](http://www.ti.com/lit/slua271)).
- Vias are optional depending on application, refer to device data sheet. If any vias are implemented, refer to their locations shown on this view. It is recommended that vias under paste be filled, plugged or tented.

**EXAMPLE STENCIL DESIGN**

**DSG0008A**

**WSON - 0.8 mm max height**

PLASTIC SMALL OUTLINE - NO LEAD

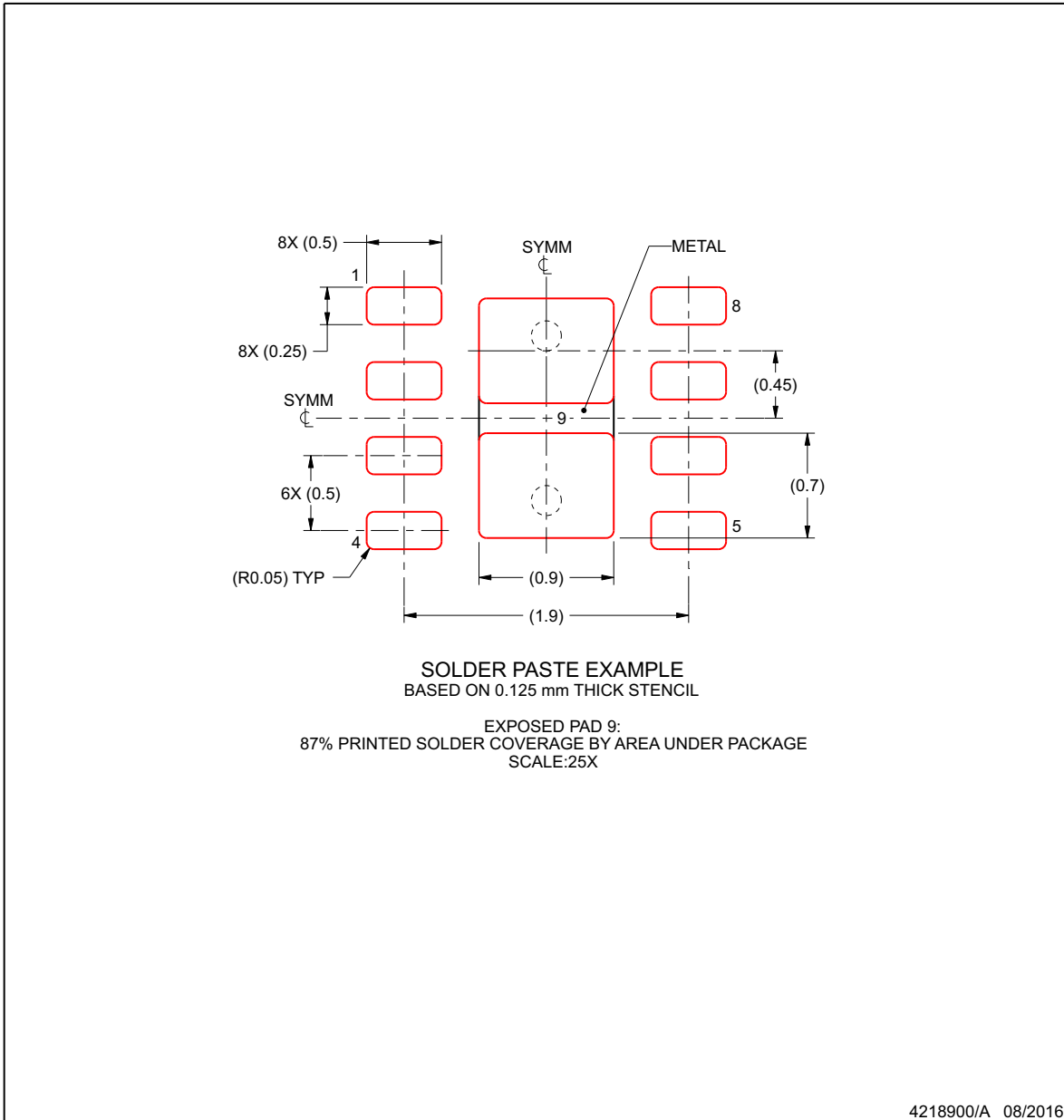

NOTES: (continued)

6. Laser cutting apertures with trapezoidal walls and rounded corners may offer better paste release. IPC-7525 may have alternate design recommendations.

**PACKAGING INFORMATION**

Orderable part number	Status (1)	Material type (2)	Package   Pins	Package qty   Carrier	RoHS (3)	Lead finish/ Ball material (4)	MSL rating/ Peak reflow (5)	Op temp (°C)	Part marking (6)
<a href="#">TPS62170DSGR</a>	Active	Production	WSON (DSG)   8	3000   LARGE T&R	Yes	NIPDAU	Level-2-260C-1 YEAR	-40 to 125	QUE
TPS62170DSGR.A	Active	Production	WSON (DSG)   8	3000   LARGE T&R	Yes	NIPDAU	Level-2-260C-1 YEAR	-40 to 125	QUE
TPS62170DSGR.B	Active	Production	WSON (DSG)   8	3000   LARGE T&R	Yes	NIPDAU	Level-2-260C-1 YEAR	-40 to 125	QUE
TPS62170DSGRG4	Active	Production	WSON (DSG)   8	3000   LARGE T&R	Yes	NIPDAU	Level-2-260C-1 YEAR	-40 to 125	QUE
TPS62170DSGRG4.A	Active	Production	WSON (DSG)   8	3000   LARGE T&R	Yes	NIPDAU	Level-2-260C-1 YEAR	-40 to 125	QUE
TPS62170DSGRG4.B	Active	Production	WSON (DSG)   8	3000   LARGE T&R	Yes	NIPDAU	Level-2-260C-1 YEAR	-40 to 125	QUE
<a href="#">TPS62170DSGT</a>	Active	Production	WSON (DSG)   8	250   SMALL T&R	Yes	NIPDAU	Level-2-260C-1 YEAR	-40 to 125	QUE
TPS62170DSGT.A	Active	Production	WSON (DSG)   8	250   SMALL T&R	Yes	NIPDAU	Level-2-260C-1 YEAR	-40 to 125	QUE
TPS62170DSGT.B	Active	Production	WSON (DSG)   8	250   SMALL T&R	Yes	NIPDAU	Level-2-260C-1 YEAR	-40 to 125	QUE
<a href="#">TPS62171DSGR</a>	Active	Production	WSON (DSG)   8	3000   LARGE T&R	Yes	NIPDAU	Level-2-260C-1 YEAR	-40 to 125	QUF
TPS62171DSGR.B	Active	Production	WSON (DSG)   8	3000   LARGE T&R	Yes	NIPDAU	Level-2-260C-1 YEAR	-40 to 125	QUF
<a href="#">TPS62171DSGT</a>	Active	Production	WSON (DSG)   8	250   SMALL T&R	Yes	NIPDAU	Level-2-260C-1 YEAR	-40 to 125	QUF
TPS62171DSGT.B	Active	Production	WSON (DSG)   8	250   SMALL T&R	Yes	NIPDAU	Level-2-260C-1 YEAR	-40 to 125	QUF
<a href="#">TPS62172DSGR</a>	Active	Production	WSON (DSG)   8	3000   LARGE T&R	Yes	NIPDAU	Level-2-260C-1 YEAR	-40 to 125	QUG
TPS62172DSGR.B	Active	Production	WSON (DSG)   8	3000   LARGE T&R	Yes	NIPDAU	Level-2-260C-1 YEAR	-40 to 125	QUG
TPS62172DSGRG4	Active	Production	WSON (DSG)   8	3000   LARGE T&R	Yes	NIPDAU	Level-2-260C-1 YEAR	-40 to 125	QUG
TPS62172DSGRG4.B	Active	Production	WSON (DSG)   8	3000   LARGE T&R	Yes	NIPDAU	Level-2-260C-1 YEAR	-40 to 125	QUG
<a href="#">TPS62172DSGT</a>	Active	Production	WSON (DSG)   8	250   SMALL T&R	Yes	NIPDAU	Level-2-260C-1 YEAR	-40 to 125	QUG
TPS62172DSGT.B	Active	Production	WSON (DSG)   8	250   SMALL T&R	Yes	NIPDAU	Level-2-260C-1 YEAR	-40 to 125	QUG
<a href="#">TPS62173DSGR</a>	Active	Production	WSON (DSG)   8	3000   LARGE T&R	Yes	NIPDAU	Level-2-260C-1 YEAR	-40 to 125	QUH
TPS62173DSGR.B	Active	Production	WSON (DSG)   8	3000   LARGE T&R	Yes	NIPDAU	Level-2-260C-1 YEAR	-40 to 125	QUH
TPS62173DSGRG4	Active	Production	WSON (DSG)   8	3000   LARGE T&R	Yes	NIPDAU	Level-2-260C-1 YEAR	-40 to 125	QUH
TPS62173DSGRG4.B	Active	Production	WSON (DSG)   8	3000   LARGE T&R	Yes	NIPDAU	Level-2-260C-1 YEAR	-40 to 125	QUH
<a href="#">TPS62173DSGT</a>	Active	Production	WSON (DSG)   8	250   SMALL T&R	Yes	NIPDAU	Level-2-260C-1 YEAR	-40 to 125	QUH
TPS62173DSGT.B	Active	Production	WSON (DSG)   8	250   SMALL T&R	Yes	NIPDAU	Level-2-260C-1 YEAR	-40 to 125	QUH

<sup>(1)</sup> **Status:** For more details on status, see our [product life cycle](#).

(2) **Material type:** When designated, preproduction parts are prototypes/experimental devices, and are not yet approved or released for full production. Testing and final process, including without limitation quality assurance, reliability performance testing, and/or process qualification, may not yet be complete, and this item is subject to further changes or possible discontinuation. If available for ordering, purchases will be subject to an additional waiver at checkout, and are intended for early internal evaluation purposes only. These items are sold without warranties of any kind.

(3) **RoHS values:** Yes, No, RoHS Exempt. See the [TI RoHS Statement](#) for additional information and value definition.

(4) **Lead finish/Ball material:** Parts may have multiple material finish options. Finish options are separated by a vertical ruled line. Lead finish/Ball material values may wrap to two lines if the finish value exceeds the maximum column width.

(5) **MSL rating/Peak reflow:** The moisture sensitivity level ratings and peak solder (reflow) temperatures. In the event that a part has multiple moisture sensitivity ratings, only the lowest level per JEDEC standards is shown. Refer to the shipping label for the actual reflow temperature that will be used to mount the part to the printed circuit board.

(6) **Part marking:** There may be an additional marking, which relates to the logo, the lot trace code information, or the environmental category of the part.

Multiple part markings will be inside parentheses. Only one part marking contained in parentheses and separated by a "~" will appear on a part. If a line is indented then it is a continuation of the previous line and the two combined represent the entire part marking for that device.

**Important Information and Disclaimer:** The information provided on this page represents TI's knowledge and belief as of the date that it is provided. TI bases its knowledge and belief on information provided by third parties, and makes no representation or warranty as to the accuracy of such information. Efforts are underway to better integrate information from third parties. TI has taken and continues to take reasonable steps to provide representative and accurate information but may not have conducted destructive testing or chemical analysis on incoming materials and chemicals. TI and TI suppliers consider certain information to be proprietary, and thus CAS numbers and other limited information may not be available for release.

In no event shall TI's liability arising out of such information exceed the total purchase price of the TI part(s) at issue in this document sold by TI to Customer on an annual basis.

**OTHER QUALIFIED VERSIONS OF TPS62170, TPS62171, TPS62172 :**

- Automotive : [TPS62170-Q1](#), [TPS62171-Q1](#), [TPS62172-Q1](#)

NOTE: Qualified Version Definitions:

- Automotive - Q100 devices qualified for high-reliability automotive applications targeting zero defects

**TAPE AND REEL INFORMATION**

**QUADRANT ASSIGNMENTS FOR PIN 1 ORIENTATION IN TAPE**

\*All dimensions are nominal

Device	Package Type	Package Drawing	Pins	SPQ	Reel Diameter (mm)	Reel Width W1 (mm)	A0 (mm)	B0 (mm)	K0 (mm)	P1 (mm)	W (mm)	Pin1 Quadrant
TPS62170DSGR	WSO	DSG	8	3000	178.0	8.4	2.25	2.25	1.0	4.0	8.0	Q2
TPS62170DSGR	WSO	DSG	8	3000	180.0	8.4	2.3	2.3	1.15	4.0	8.0	Q2
TPS62170DSGRG4	WSO	DSG	8	3000	180.0	8.4	2.3	2.3	1.15	4.0	8.0	Q2
TPS62170DSGT	WSO	DSG	8	250	180.0	8.4	2.3	2.3	1.15	4.0	8.0	Q2
TPS62170DSGT	WSO	DSG	8	250	178.0	8.4	2.25	2.25	1.0	4.0	8.0	Q2
TPS62171DSGR	WSO	DSG	8	3000	180.0	8.4	2.3	2.3	1.15	4.0	8.0	Q2
TPS62171DSGT	WSO	DSG	8	250	180.0	8.4	2.3	2.3	1.15	4.0	8.0	Q2
TPS62172DSGR	WSO	DSG	8	3000	180.0	8.4	2.3	2.3	1.15	4.0	8.0	Q2
TPS62172DSGRG4	WSO	DSG	8	3000	180.0	8.4	2.3	2.3	1.15	4.0	8.0	Q2
TPS62172DSGT	WSO	DSG	8	250	180.0	8.4	2.3	2.3	1.15	4.0	8.0	Q2
TPS62173DSGR	WSO	DSG	8	3000	178.0	8.4	2.25	2.25	1.0	4.0	8.0	Q2
TPS62173DSGR	WSO	DSG	8	3000	180.0	8.4	2.3	2.3	1.15	4.0	8.0	Q2
TPS62173DSGRG4	WSO	DSG	8	3000	180.0	8.4	2.3	2.3	1.15	4.0	8.0	Q2
TPS62173DSGT	WSO	DSG	8	250	178.0	8.4	2.25	2.25	1.0	4.0	8.0	Q2
TPS62173DSGT	WSO	DSG	8	250	180.0	8.4	2.3	2.3	1.15	4.0	8.0	Q2

**TAPE AND REEL BOX DIMENSIONS**

\*All dimensions are nominal

Device	Package Type	Package Drawing	Pins	SPQ	Length (mm)	Width (mm)	Height (mm)
TPS62170DSGR	WSON	DSG	8	3000	205.0	200.0	33.0
TPS62170DSGR	WSON	DSG	8	3000	213.0	191.0	35.0
TPS62170DSGRG4	WSON	DSG	8	3000	213.0	191.0	35.0
TPS62170DSGT	WSON	DSG	8	250	213.0	191.0	35.0
TPS62170DSGT	WSON	DSG	8	250	205.0	200.0	33.0
TPS62171DSGR	WSON	DSG	8	3000	213.0	191.0	35.0
TPS62171DSGT	WSON	DSG	8	250	213.0	191.0	35.0
TPS62172DSGR	WSON	DSG	8	3000	210.0	185.0	35.0
TPS62172DSGRG4	WSON	DSG	8	3000	210.0	185.0	35.0
TPS62172DSGT	WSON	DSG	8	250	210.0	185.0	35.0
TPS62173DSGR	WSON	DSG	8	3000	205.0	200.0	33.0
TPS62173DSGR	WSON	DSG	8	3000	213.0	191.0	35.0
TPS62173DSGRG4	WSON	DSG	8	3000	213.0	191.0	35.0
TPS62173DSGT	WSON	DSG	8	250	205.0	200.0	33.0
TPS62173DSGT	WSON	DSG	8	250	213.0	191.0	35.0

## GENERIC PACKAGE VIEW

**DSG 8**

**WSON - 0.8 mm max height**

2 x 2, 0.5 mm pitch

PLASTIC SMALL OUTLINE - NO LEAD

This image is a representation of the package family, actual package may vary.  
Refer to the product data sheet for package details.

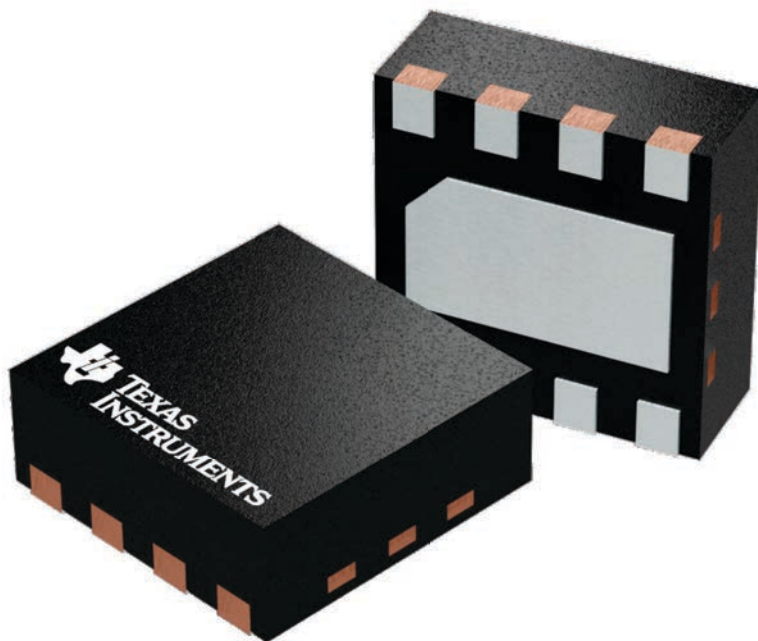

4224783/A

# DSG0008A

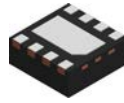

# PACKAGE OUTLINE

## WSON - 0.8 mm max height

PLASTIC SMALL OUTLINE - NO LEAD

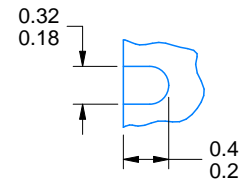
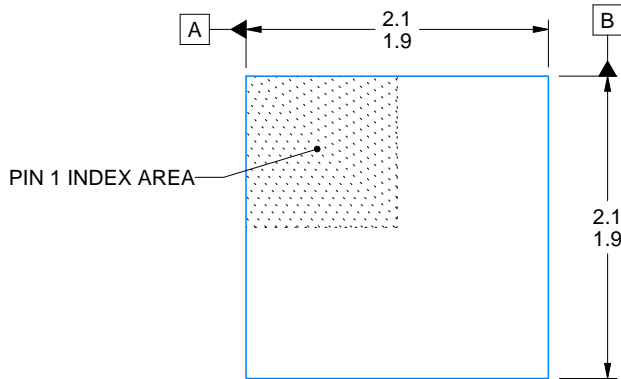

ALTERNATIVE TERMINAL SHAPE TYPICAL

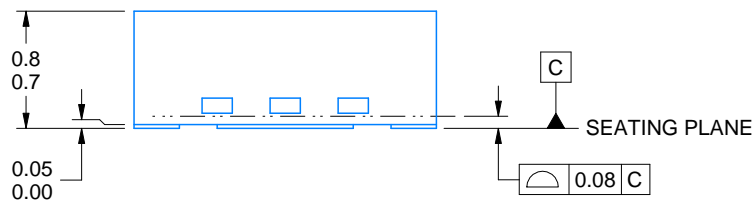

SIDE WALL METAL THICKNESS DIM A	
OPTION 1	OPTION 2
0.1	0.2

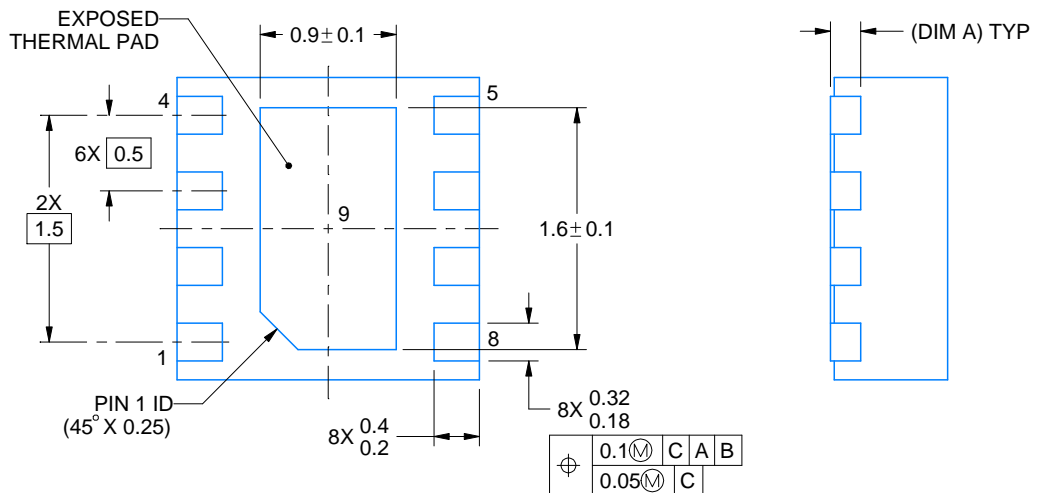

4218900/E 08/2022

### NOTES:

1. All linear dimensions are in millimeters. Any dimensions in parenthesis are for reference only. Dimensioning and tolerancing per ASME Y14.5M.
2. This drawing is subject to change without notice.
3. The package thermal pad must be soldered to the printed circuit board for thermal and mechanical performance.

# EXAMPLE BOARD LAYOUT

DSG0008A

WSON - 0.8 mm max height

PLASTIC SMALL OUTLINE - NO LEAD

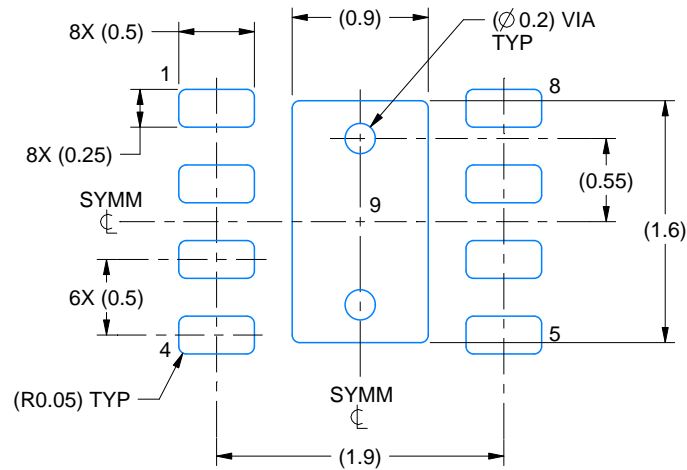

LAND PATTERN EXAMPLE  
SCALE:20X

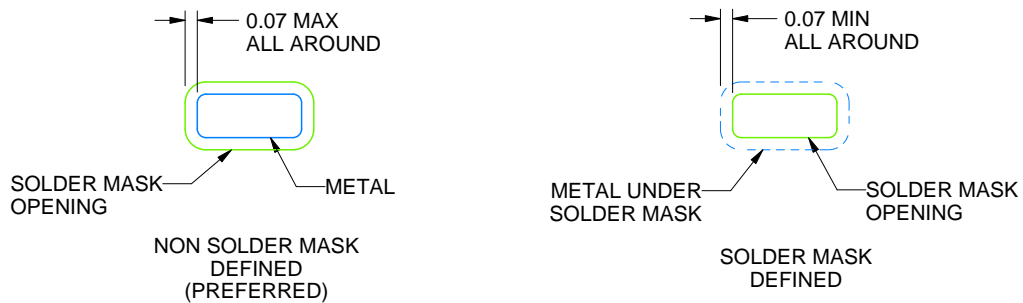

SOLDER MASK DETAILS

4218900/E 08/2022

NOTES: (continued)

4. This package is designed to be soldered to a thermal pad on the board. For more information, see Texas Instruments literature number SLUA271 ([www.ti.com/lit/slua271](http://www.ti.com/lit/slua271)).
5. Vias are optional depending on application, refer to device data sheet. If any vias are implemented, refer to their locations shown on this view. It is recommended that vias under paste be filled, plugged or tented.

# EXAMPLE STENCIL DESIGN

DSG0008A

WSON - 0.8 mm max height

PLASTIC SMALL OUTLINE - NO LEAD

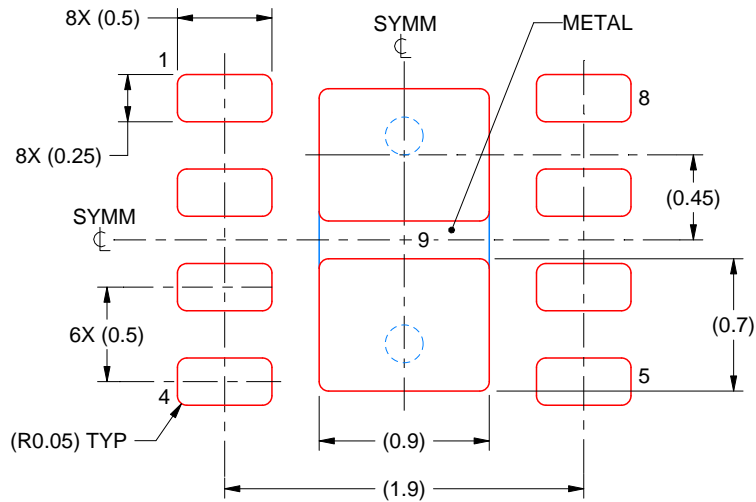

SOLDER PASTE EXAMPLE  
BASED ON 0.125 mm THICK STENCIL

EXPOSED PAD 9:  
87% PRINTED SOLDER COVERAGE BY AREA UNDER PACKAGE  
SCALE:25X

4218900/E 08/2022

NOTES: (continued)

6. Laser cutting apertures with trapezoidal walls and rounded corners may offer better paste release. IPC-7525 may have alternate design recommendations.

## 重要通知和免责声明

TI“按原样”提供技术和可靠性数据（包括数据表）、设计资源（包括参考设计）、应用或其他设计建议、网络工具、安全信息和其他资源，不保证没有瑕疵且不做任何明示或暗示的担保，包括但不限于对适销性、与某特定用途的适用性或不侵犯任何第三方知识产权的暗示担保。

这些资源可供使用 TI 产品进行设计的熟练开发人员使用。您将自行承担以下全部责任：(1) 针对您的应用选择合适的 TI 产品，(2) 设计、验证并测试您的应用，(3) 确保您的应用满足相应标准以及任何其他安全、安保法规或其他要求。

这些资源如有变更，恕不另行通知。TI 授权您仅可将这些资源用于研发本资源所述的 TI 产品的相关应用。严禁以其他方式对这些资源进行复制或展示。您无权使用任何其他 TI 知识产权或任何第三方知识产权。对于因您对这些资源的使用而对 TI 及其代表造成的任何索赔、损害、成本、损失和债务，您将全额赔偿，TI 对此概不负责。

TI 提供的产品受 [TI 销售条款](#)、[TI 通用质量指南](#) 或 [ti.com](#) 上其他适用条款或 TI 产品随附的其他适用条款的约束。TI 提供这些资源并不会扩展或以其他方式更改 TI 针对 TI 产品发布的适用的担保或担保免责声明。除非德州仪器 (TI) 明确将某产品指定为定制产品或客户特定产品，否则其产品均为按确定价格收入目录的标准通用器件。

TI 反对并拒绝您可能提出的任何其他或不同的条款。

版权所有 © 2026，德州仪器 (TI) 公司

最后更新日期：2025 年 10 月