

超低功率、轨到轨输出、完全差分放大器

 查询样品: **THS4531**

特性

- 超低功耗
 - 电压: **2.5V 至 5.5V**
 - 电流: **250µA**
 - 断电模式 **0.5µA** (典型值)
- 完全差分架构
- 带宽: **36MHz**
- 转换速率: **200V/µs**
- 总谐波失真: **1kHz (1V_{RMS}, R_L = 2kΩ) 时为-120dBc**
- 输入电压噪声: **10nV/√Hz (f=1 kHz)**
- 高 DC 精度
 - V_{OS} 偏移 = **±4µV/°C (-40°C 至 +125°C)**
 - A_{OL}: **114 dB**
- **RRO** - 轨至轨输出
- **NRI** - 负电源轨输入
- 输出共模控制

应用范围

- 低功耗逐次逼近式 (**SAR**)、三角积分模数转换器 (**ΔΣ ADC**) 驱动器
- 低功耗、高性能
 - 差分到差分放大器
 - 单端至差分放大器
- 低功耗、宽带宽差分驱动器
- 低功耗、宽带宽差分信号调节
- 高通道数量和功率密集系统

说明

THS4531 是一款低功耗、完全差分运算放大器，此放大器具有 低于负电源轨和轨到轨输出的输入共模范围。此器件设计用于能耗和功率耗散都十分关键的低功率数据采集系统和高密度应用。

此器件特有精确输出共模控制，此控制可实现驱动 ADC 时的 dc 耦合。与低于负电源轨和轨到轨输出的输入共模范围相耦合可轻松实现来自单端接地基准信号源的接口与 SAR 的连接，并允许 ΔΣ ADC 只使用 2.5V 至 5V 的单一电源。它也是一个针对通用低功耗差分信号调节应用的有用的工具。

THS4531 可在介于 -40°C 至 +125°C 的扩展温度范围内运行。可提供下列封装选项：

- 8 引脚小尺寸集成电路 (SOIC) / 超小型小尺寸封装 (VSSOP) (微型小尺寸封装 (MSOP)) (D/DGK)
- 10 引脚方形扁平无引脚封装 (WQFN) (RUN) 封装



图 1. 音频分析仪上的 1kHz 快速傅里叶变换(FFT) 幅值频率

表 1. 相关产品

器件	带宽 (BW) (MHz)	I _Q (mA)	100kHz 下的总谐波失真 (dBc)	V _N (nV/√Hz)	轨到轨
THS4521	145	1.14	-120	4.6	输出
THS4520	570	15.3	-114	2	输出
THS4121	100	16	-79	5.4	输入/输出
THS4131	150	16	-107	1.3	否

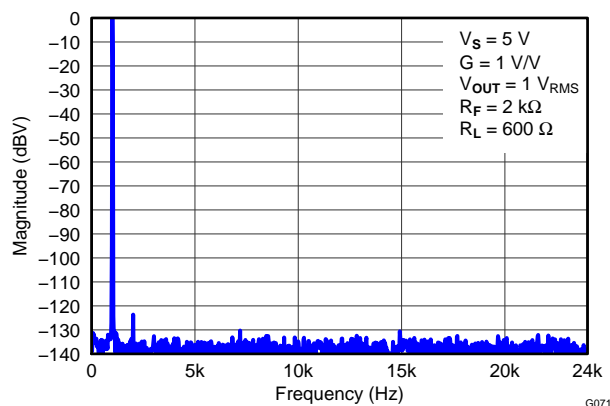

Please be aware that an important notice concerning availability, standard warranty, and use in critical applications of Texas Instruments semiconductor products and disclaimers thereto appears at the end of this data sheet.



This integrated circuit can be damaged by ESD. Texas Instruments recommends that all integrated circuits be handled with appropriate precautions. Failure to observe proper handling and installation procedures can cause damage.

ESD damage can range from subtle performance degradation to complete device failure. Precision integrated circuits may be more susceptible to damage because very small parametric changes could cause the device not to meet its published specifications.

PACKAGING/ORDERING INFORMATION⁽¹⁾

PRODUCT	CHANNEL COUNT	PACKAGE-LEAD	PACKAGE DESIGNATOR	SPECIFIED TEMPERATURE RANGE	PACKAGE MARKING	ORDERING NUMBER	TRANSPORT MEDIA, QUANTITY
THS4531	1	SOIC-8	D	-40°C to +125°C	T4531	THS4531ID	Rails, 75
	1				T4531	THS4531IDR	Tape and reel, 2500
	1	VSSOP-8	DGK	-40°C to +125°C	4531	THS4531IDGK	Rails, 80
	1				4531	THS4531IDGKR	Tape and reel, 2500
	1	WQFN-10	RUN	-40°C to +125°C	4531	THS4531IRUNT	Tape and reel, 250
	1				4531	THS4531IRUNR	Tape and reel, 3000

(1) For the most current package and ordering information, see the Package Option Addendum at the end of this document, or see the TI web site at www.ti.com.

ABSOLUTE MAXIMUM RATINGS

	VALUE	UNITS	
Supply voltage, V_{S-} to V_{S+}	5.5		
Input/output voltage, $V_{IN\pm}$, $V_{OUT\pm}$, and V_{OCM} pins	$(V_{S-}) - 0.7$ to $(V_{S+}) + 0.7$	V	
Differential input voltage, V_{ID}	1	V	
Continuous output current, I_O	50	mA	
Continuous input current, I_i	0.75	mA	
Continuous power dissipation	See Thermal Information		
Maximum junction temperature, T_J	150	°C	
Operating free-air temperature range, T_A	-40 to +125	°C	
Storage temperature range, T_{stg}	-65 to +150	°C	
Electrostatic discharge (ESD) ratings:	Human body model (HBM)	3000	V
	Charge device model (CDM)	500	V
	Machine model (MM)	200	V

THERMAL INFORMATION

THERMAL METRIC ⁽¹⁾		THS4531	THS4531	THS4531	UNITS
		SOIC (P)	VSSOP (MSOP) (DGK)	WQFN (RUN)	
		8 PINS	8 PINS	10 PINS	
θ_{JA}	Junction-to-ambient thermal resistance	133	198	163	°C/W
θ_{JcTop}	Junction-to-case (top) thermal resistance	78	84	66	
θ_{JB}	Junction-to-board thermal resistance	73	120	113	
ψ_{JT}	Junction-to-top characterization parameter	26	19	17	
ψ_{JB}	Junction-to-board characterization parameter	73	118	113	
θ_{JcBot}	Junction-to-case (bottom) thermal resistance	N/A	N/A	N/A	

(1) 有关传统和新的热度的更多信息，请参阅 IC 封装热量应用报告 [SPRA953](#)。

ELECTRICAL CHARACTERISTICS: $V_S = 2.7\text{ V}$

Test conditions at $T_A = 25^\circ\text{C}$, $V_{S+} = 2.7\text{ V}$, $V_{S-} = 0\text{ V}$, $V_{OCM} = \text{open}$, $V_{OUT} = 2\text{ V}_{PP}$, $R_F = 2\text{ k}\Omega$, $R_L = 2\text{ k}\Omega$ differential, $G = 1\text{ V/V}$, single-ended input, differential output, and input and output referenced to mid-supply, unless otherwise noted.

PARAMETER	CONDITIONS	MIN	TYP	MAX	UNITS	TEST LEVEL ⁽¹⁾
AC PERFORMANCE						
Small-signal bandwidth	$V_{OUT} = 100\text{ mV}_{PP}$, $G = 1$		34		MHz	C
	$V_{OUT} = 100\text{ mV}_{PP}$, $G = 2$		16			
	$V_{OUT} = 100\text{ mV}_{PP}$, $G = 5$		6			
	$V_{OUT} = 100\text{ mV}_{PP}$, $G = 10$		2.7			
Gain-bandwidth product	$V_{OUT} = 100\text{ mV}_{PP}$, $G = 10$		27		MHz	
Large-signal bandwidth	$V_{OUT} = 2\text{ V}_{PP}$, $G = 1$		34		MHz	
Bandwidth for 0.1-dB flatness	$V_{OUT} = 2\text{ V}_{PP}$, $G = 1$		12		MHz	
Slew rate, rise/fall, 25% to 75%	$V_{OUT} = 2\text{-V step}$		190/320		V/ μs	
Rise/fall time, 10% to 90%			5.2/6.1		ns	
Settling time to 1%, rise/fall			25/20		ns	
Settling time to 0.1%, rise/fall			60/60		ns	
Settling time to 0.01%, rise/fall			150/110		ns	
Overshoot/undershoot, rise/fall				1/1		%
2nd-order harmonic distortion	$f = 1\text{ kHz}$, $V_{OUT} = 1\text{ V}_{RMS}$		-122		dBc	
	$f = 10\text{ kHz}$		-127			
	$f = 1\text{ MHz}$		-59			
3rd-order harmonic distortion	$f = 1\text{ kHz}$, $V_{OUT} = 1\text{ V}_{RMS}$		-130		dBc	
	$f = 10\text{ kHz}$		-135			
	$f = 1\text{ MHz}$		-70			
2nd-order intermodulation distortion	$f = 1\text{ MHz}$, 200-Hz tone spacing, V_{OUT} envelope = 1 V_{PP}		-83		dBc	
3rd-order intermodulation distortion			-81			
Input voltage noise	$f = 1\text{ kHz}$		10		nV/ $\sqrt{\text{Hz}}$	
Voltage noise 1/f corner frequency			45		Hz	
Input current noise	$f = 100\text{ kHz}$		0.25		pA/ $\sqrt{\text{Hz}}$	
Current noise 1/f corner frequency			6.5		kHz	
Overdrive recovery time	Overdrive = 0.5 V		65		ns	
Output balance error	$V_{OUT} = 100\text{ mV}$, $f = 1\text{ MHz}$		-65		dB	
Closed-loop output impedance	$f = 1\text{ MHz}$ (differential)		2.5		Ω	

(1) Test levels (all values set by characterization and simulation): (A) 100% tested at $+25^\circ\text{C}$; over temperature limits by characterization and simulation. (B) Not tested in production; limits set by characterization and simulation. (C) Typical value only for information.

ELECTRICAL CHARACTERISTICS: $V_S = 2.7\text{ V}$ (continued)

Test conditions at $T_A = 25^\circ\text{C}$, $V_{S+} = 2.7\text{ V}$, $V_{S-} = 0\text{ V}$, $V_{OCM} = \text{open}$, $V_{OUT} = 2 V_{PP}$, $R_F = 2\text{ k}\Omega$, $R_L = 2\text{ k}\Omega$ differential, $G = 1\text{ V/V}$, single-ended input, differential output, and input and output referenced to mid-supply, unless otherwise noted.

PARAMETER	CONDITIONS	MIN	TYP	MAX	UNITS	TEST LEVEL ⁽¹⁾
DC PERFORMANCE						
Open-loop voltage gain (A_{OL})		100	113		dB	A
Input-referred offset voltage	$T_A = +25^\circ\text{C}$		± 200	± 1000	μV	A
	$T_A = 0^\circ\text{C}$ to $+70^\circ\text{C}$			± 1405		B
	$T_A = -40^\circ\text{C}$ to $+85^\circ\text{C}$			± 1585		
	$T_A = -40^\circ\text{C}$ to $+125^\circ\text{C}$			± 2000		
Input offset voltage drift ⁽²⁾	$T_A = 0^\circ\text{C}$ to $+70^\circ\text{C}$		± 1.7	± 9	$\mu\text{V}/^\circ\text{C}$	B
	$T_A = -40^\circ\text{C}$ to $+85^\circ\text{C}$		± 1.8	± 9		
	$T_A = -40^\circ\text{C}$ to $+125^\circ\text{C}$		± 2	± 10		
Input bias current	$T_A = +25^\circ\text{C}$		160	210	nA	A
	$T_A = 0^\circ\text{C}$ to $+70^\circ\text{C}$			221		B
	$T_A = -40^\circ\text{C}$ to $+85^\circ\text{C}$			222		
	$T_A = -40^\circ\text{C}$ to $+125^\circ\text{C}$			233		
Input bias current drift ⁽²⁾	$T_A = 0^\circ\text{C}$ to $+70^\circ\text{C}$			0.25	nA/ $^\circ\text{C}$	B
	$T_A = -40^\circ\text{C}$ to $+85^\circ\text{C}$			0.25		
	$T_A = -40^\circ\text{C}$ to $+125^\circ\text{C}$			0.25		
Input offset current	$T_A = +25^\circ\text{C}$		± 5	± 50	nA	A
	$T_A = 0^\circ\text{C}$ to $+70^\circ\text{C}$			± 59		B
	$T_A = -40^\circ\text{C}$ to $+85^\circ\text{C}$			± 60		
	$T_A = -40^\circ\text{C}$ to $+125^\circ\text{C}$			± 75		
Input offset current drift ⁽²⁾	$T_A = 0^\circ\text{C}$ to $+70^\circ\text{C}$		± 0.05	± 0.2	nA/ $^\circ\text{C}$	B
	$T_A = -40^\circ\text{C}$ to $+85^\circ\text{C}$		± 0.05	± 0.2		
	$T_A = -40^\circ\text{C}$ to $+125^\circ\text{C}$		± 0.05	± 0.2		
INPUT						
Common-mode input low	$T_A = +25^\circ\text{C}$, CMRR > 87 dB		$V_{S-} - 0.2$	V_{S-}	V	A
	$T_A = -40^\circ\text{C}$ to $+125^\circ\text{C}$, CMRR > 87 dB		$V_{S-} - 0.2$	V_{S-}		B
Common-mode input high	$T_A = +25^\circ\text{C}$, CMRR > 87 dB	$V_{S+} - 1.2$	$V_{S+} - 1.1$		V	A
	$T_A = -40^\circ\text{C}$ to $+125^\circ\text{C}$, CMRR > 87 dB	$V_{S+} - 1.2$	$V_{S+} - 1.1$			B
Common-mode rejection ratio		90	116		dB	A
Input impedance common-mode			$200 \parallel 1.2$		k Ω pF	C
Input impedance differential mode			$200 \parallel 1$			C
OUTPUT						
Single-ended output voltage: low	$T_A = +25^\circ\text{C}$		$V_{S-} + 0.06$	$V_{S-} + 0.2$	V	A
	$T_A = -40^\circ\text{C}$ to $+125^\circ\text{C}$		$V_{S-} + 0.06$	$V_{S-} + 0.2$		B
Single-ended output voltage: high	$T_A = +25^\circ\text{C}$	$V_{S+} - 0.2$	$V_{S+} - 0.11$		V	A
	$T_A = -40^\circ\text{C}$ to $+125^\circ\text{C}$	$V_{S+} - 0.2$	$V_{S+} - 0.11$			B
Output saturation voltage: high/low			$110/60$		mV	C
Linear output current drive	$T_A = +25^\circ\text{C}$	± 15	± 22		mA	A
	$T_A = -40^\circ\text{C}$ to $+125^\circ\text{C}$	± 15				B

(2) Input offset voltage drift, input bias current drift, and input offset current drift are average values calculated by taking data at the end points, computing the difference, and dividing by the temperature range.

ELECTRICAL CHARACTERISTICS: $V_S = 2.7\text{ V}$ (continued)

Test conditions at $T_A = 25^\circ\text{C}$, $V_{S+} = 2.7\text{ V}$, $V_{S-} = 0\text{ V}$, $V_{OCM} = \text{open}$, $V_{OUT} = 2 V_{PP}$, $R_F = 2\text{ k}\Omega$, $R_L = 2\text{ k}\Omega$ differential, $G = 1\text{ V/V}$, single-ended input, differential output, and input and output referenced to mid-supply, unless otherwise noted.

PARAMETER	CONDITIONS	MIN	TYP	MAX	UNITS	TEST LEVEL ⁽¹⁾
POWER SUPPLY						
Specified operating voltage		2.5		5.5	V	B
Quiescent operating current/ch	$T_A = +25^\circ\text{C}$, $\overline{PD} = V_{S+}$		230	330	μA	A
	$T_A = -40^\circ\text{C}$ to $+125^\circ\text{C}$, $\overline{PD} = V_{S+}$		270	370		B
Power-supply rejection ($\pm\text{PSRR}$)		87	108		dB	A
POWER DOWN						
Enable voltage threshold	Specified on above 2.1 V			2.1	V	A
Disable voltage threshold	Specified off below 0.7 V	0.7				A
Disable pin bias current	$\overline{PD} = V_{S-} + 0.5\text{ V}$		50	500	nA	A
Power-down quiescent current	$\overline{PD} = V_{S-} + 0.5\text{ V}$		0.5	2	μA	A
Turn-on time delay	Time from $\overline{PD} = \text{high}$ to $V_{OUT} = 90\%$ of final value, $R_L = 200\ \Omega$		650		ns	C
Turn-off time delay	Time from $\overline{PD} = \text{low}$ to $V_{OUT} = 10\%$ of original value, $R_L = 200\ \Omega$		20			
OUTPUT COMMON-MODE VOLTAGE CONTROL (V_{OCM})						
Small-signal bandwidth	V_{OCM} input = 100 mV _{PP}		23		MHz	C
Slew rate	V_{OCM} input = 1 V _{STEP}		14		V/ μs	C
Gain		0.99	0.996	1.01	V/V	A
Common-mode offset voltage	Offset = output common-mode voltage – V_{OCM} input voltage		± 1	± 5	mV	A
V_{OCM} input bias current	$V_{OCM} = (V_{S+} - V_{S-})/2$		± 20	± 100	nA	A
V_{OCM} input voltage range		0.8	0.75 to 1.9	1.75	V	A
V_{OCM} input impedance			100 1.6		k Ω pF	C
Default voltage offset from $(V_{S+} - V_{S-})/2$	Offset = output common-mode voltage – $(V_{S+} - V_{S-})/2$		± 3	± 10	mV	A

ELECTRICAL CHARACTERISTICS: $V_S = 5\text{ V}$

Test conditions at $T_A = +25^\circ\text{C}$, $V_{S+} = 5\text{ V}$, $V_{S-} = 0\text{ V}$, $V_{OCM} = \text{open}$, $V_{OUT} = 2\text{ V}_{PP}$, $R_F = 2\text{ k}\Omega$, $R_L = 2\text{ k}\Omega$ differential, $G = 1\text{ V/V}$, single-ended input, differential output, and input and output referenced to mid-supply, unless otherwise noted.

PARAMETER	CONDITIONS	MIN	TYP	MAX	UNITS	TEST LEVEL ⁽¹⁾
AC PERFORMANCE						
Small-signal bandwidth	$V_{OUT} = 100\text{ mV}_{PP}$, $G = 1$		36		MHz	C
	$V_{OUT} = 100\text{ mV}_{PP}$, $G = 2$		17			
	$V_{OUT} = 100\text{ mV}_{PP}$, $G = 5$		6			
	$V_{OUT} = 100\text{ mV}_{PP}$, $G = 10$		2.7			
Gain-bandwidth product	$V_{OUT} = 100\text{ mV}_{PP}$, $G = 10$		27		MHz	
Large-signal bandwidth	$V_{OUT} = 2\text{ V}_{PP}$, $G = 1$		36		MHz	
Bandwidth for 0.1-dB flatness	$V_{OUT} = 2\text{ V}_{PP}$, $G = 1$		15		MHz	
Slew rate, rise/fall, 25% to 75%	$V_{OUT} = 2\text{ V}_{Step}$		220/390		V/ μs	
Rise/fall time, 10% to 90%			4.6/5.6		ns	
Settling time to 1%, rise/fall			25/20		ns	
Settling time to 0.1%, rise/fall			60/60		ns	
Settling time to 0.01%, rise/fall			150/110		ns	
Overshoot/undershoot, rise/fall				1/1		%
2nd-order harmonic distortion	$f = 1\text{ kHz}$, $V_{OUT} = 1\text{ V}_{RMS}$		-122		dBc	
	$f = 10\text{ kHz}$		-128			
	$f = 1\text{ MHz}$		-60			
3rd-order harmonic distortion	$f = 1\text{ kHz}$, $V_{OUT} = 1\text{ V}_{RMS}$		-130		dBc	
	$f = 10\text{ kHz}$		-137			
	$f = 1\text{ MHz}$		-71			
2nd-order intermodulation distortion	$f = 1\text{ MHz}$, 200-kHz tone spacing,		-85		dBc	
3rd-order intermodulation distortion	$V_{OUT}\text{ envelope} = 2\text{ V}_{PP}$		-83			
Input voltage noise	$f = 1\text{ kHz}$		10		nV/ $\sqrt{\text{Hz}}$	
Voltage noise 1/f corner frequency			45		Hz	
Input current noise	$f = 100\text{ kHz}$		0.25		pA/ $\sqrt{\text{Hz}}$	
Current noise 1/f corner frequency			6.5		kHz	
Overdrive recovery time	Overdrive = 0.5 V		65		ns	
Output balance error	$V_{OUT} = 100\text{ mV}$, $f = 1\text{ MHz}$		-67		dB	
Closed-loop output impedance	$f = 1\text{ MHz}$ (differential)		2.5		Ω	

(1) Test levels (all values set by characterization and simulation): (A) 100% tested at $+25^\circ\text{C}$; over temperature limits by characterization and simulation. (B) Not tested in production; limits set by characterization and simulation. (C) Typical value only for information.

ELECTRICAL CHARACTERISTICS: $V_S = 5\text{ V}$ (continued)

Test conditions at $T_A = +25^\circ\text{C}$, $V_{S+} = 5\text{ V}$, $V_{S-} = 0\text{ V}$, $V_{OCM} = \text{open}$, $V_{OUT} = 2 V_{PP}$, $R_F = 2\text{ k}\Omega$, $R_L = 2\text{ k}\Omega$ differential, $G = 1\text{ V/V}$, single-ended input, differential output, and input and output referenced to mid-supply, unless otherwise noted.

PARAMETER	CONDITIONS	MIN	TYP	MAX	UNITS	TEST LEVEL ⁽¹⁾
DC PERFORMANCE						
Open-loop voltage gain (A_{OL})		100	114		dB	A
Input-referred offset voltage	$T_A = +25^\circ\text{C}$		± 200	± 1000	μV	A
	$T_A = 0^\circ\text{C}$ to $+70^\circ\text{C}$			± 1405		B
	$T_A = -40^\circ\text{C}$ to $+85^\circ\text{C}$			± 1650		
	$T_A = -40^\circ\text{C}$ to $+125^\circ\text{C}$			± 2000		
Input offset voltage drift ⁽²⁾	$T_A = 0^\circ\text{C}$ to $+70^\circ\text{C}$		± 1.7	± 9	$\mu\text{V}/^\circ\text{C}$	B
	$T_A = -40^\circ\text{C}$ to $+85^\circ\text{C}$		± 2	± 10		
	$T_A = -40^\circ\text{C}$ to $+125^\circ\text{C}$		± 2	± 10		
Input bias current	$T_A = +25^\circ\text{C}$		160	210	nA	A
	$T_A = 0^\circ\text{C}$ to $+70^\circ\text{C}$			222		B
	$T_A = -40^\circ\text{C}$ to $+85^\circ\text{C}$			223		
	$T_A = -40^\circ\text{C}$ to $+125^\circ\text{C}$			235		
Input bias current drift ⁽²⁾	$T_A = 0^\circ\text{C}$ to $+70^\circ\text{C}$		0.04	0.25	nA/ $^\circ\text{C}$	B
	$T_A = -40^\circ\text{C}$ to $+85^\circ\text{C}$		0.04	0.25		
	$T_A = -40^\circ\text{C}$ to $+125^\circ\text{C}$		0.04	0.25		
Input offset current	$T_A = +25^\circ\text{C}$		± 5	± 50	nA	A
	$T_A = 0^\circ\text{C}$ to $+70^\circ\text{C}$			± 59		B
	$T_A = -40^\circ\text{C}$ to $+85^\circ\text{C}$			± 60		
	$T_A = -40^\circ\text{C}$ to $+125^\circ\text{C}$			± 75		
Input offset current drift ⁽²⁾	$T_A = 0^\circ\text{C}$ to $+70^\circ\text{C}$		± 0.05	± 0.2	nA/ $^\circ\text{C}$	B
	$T_A = -40^\circ\text{C}$ to $+85^\circ\text{C}$		± 0.05	± 0.2		
	$T_A = -40^\circ\text{C}$ to $+125^\circ\text{C}$		± 0.05	± 0.2		
INPUT						
Common-mode input: low	$T_A = +25^\circ\text{C}$, CMRR > 87 dB		$V_{S-} - 0.2$	V_{S-}	V	A
	$T_A = -40^\circ\text{C}$ to $+125^\circ\text{C}$, CMRR > 87 dB		$V_{S-} - 0.2$	V_{S-}		B
Common-mode input: high	$T_A = +25^\circ\text{C}$, CMRR > 87 dB	$V_{S+} - 1.2$	$V_{S+} - 1.1$		V	A
	$T_A = -40^\circ\text{C}$ to $+125^\circ\text{C}$, CMRR > 87 dB	$V_{S+} - 1.2$	$V_{S+} - 1.1$			B
Common-mode rejection ratio		90	116		dB	A
Input impedance common-mode			$200 \parallel 1.2$		k Ω pF	C
Input impedance differential mode			$200 \parallel 1$			C
OUTPUT						
Linear output voltage: low	$T_A = +25^\circ\text{C}$		$V_{S-} + 0.1$	$V_{S-} + 0.2$	V	A
	$T_A = -40^\circ\text{C}$ to $+125^\circ\text{C}$		$V_{S-} + 0.1$	$V_{S-} + 0.2$		B
Linear output voltage: high	$T_A = +25^\circ\text{C}$	$V_{S+} - 0.25$	$V_{S+} - 0.12$		V	A
	$T_A = -40^\circ\text{C}$ to $+125^\circ\text{C}$	$V_{S+} - 0.25$	$V_{S+} - 0.12$			B
Output saturation voltage: high/low			120/100		mV	C
Linear output current drive	$T_A = +25^\circ\text{C}$	± 15	± 25		mA	A
	$T_A = -40^\circ\text{C}$ to $+125^\circ\text{C}$	± 15				B

(2) Input offset voltage drift, input bias current drift, and input offset current drift are average values calculated by taking data at the end points, computing the difference, and dividing by the temperature range.

ELECTRICAL CHARACTERISTICS: $V_S = 5\text{ V}$ (continued)

Test conditions at $T_A = +25^\circ\text{C}$, $V_{S+} = 5\text{ V}$, $V_{S-} = 0\text{ V}$, $V_{OCM} = \text{open}$, $V_{OUT} = 2\text{ V}_{PP}$, $R_F = 2\text{ k}\Omega$, $R_L = 2\text{ k}\Omega$ differential, $G = 1\text{ V/V}$, single-ended input, differential output, and input and output referenced to mid-supply, unless otherwise noted.

PARAMETER	CONDITIONS	MIN	TYP	MAX	UNITS	TEST LEVEL ⁽¹⁾
POWER SUPPLY						
Specified operating voltage		2.5		5.5	V	B
Quiescent operating current/ch	$T_A = 25^\circ\text{C}$, $\overline{PD} = V_{S+}$		250	350	μA	A
	$T_A = -40^\circ\text{C}$ to 125°C , $\overline{PD} = V_{S+}$		290	390		B
Power-supply rejection ($\pm\text{PSRR}$)		87	108		dB	A
POWER DOWN						
Enable voltage threshold	Specified on above 2.1 V			2.1	V	A
Disable voltage threshold	Specified off below 0.7 V	0.7				A
Disable pin bias current	$\overline{PD} = V_{S-} + 0.5\text{ V}$		50	500	nA	A
Power-down quiescent current	$\overline{PD} = V_{S-} + 0.5\text{ V}$		0.5	2	μA	A
Turn-on time delay	Time from $\overline{PD} = \text{high}$ to $V_{OUT} = 90\%$ of final value, $R_L = 200\ \Omega$		600		ns	C
Turn-off time delay	Time from $\overline{PD} = \text{low}$ to $V_{OUT} = 10\%$ of original value, $R_L = 200\ \Omega$		15			
OUTPUT COMMON-MODE VOLTAGE CONTROL (V_{OCM})						
Small-signal bandwidth	V_{OCM} input = 100 mV_{PP}		24		MHz	C
Slew rate	V_{OCM} input = 1 V_{STEP}		15		V/ μs	C
Gain		0.99	0.996	1.01	V/V	A
Common-mode offset voltage	Offset = output common-mode voltage – V_{OCM} input voltage		± 1	± 5	mV	A
V_{OCM} input bias current	$V_{OCM} = (V_{S+} - V_{S-})/2$		± 20	± 120	nA	A
V_{OCM} input voltage range		0.95	0.75 to 4.15	4.0	V	A
V_{OCM} input impedance			65 0.86		k Ω pF	C
Default voltage offset from $(V_{S+} - V_{S-})/2$	Offset = output common-mode voltage – $(V_{S+} - V_{S-})/2$		± 3	± 10	mV	A

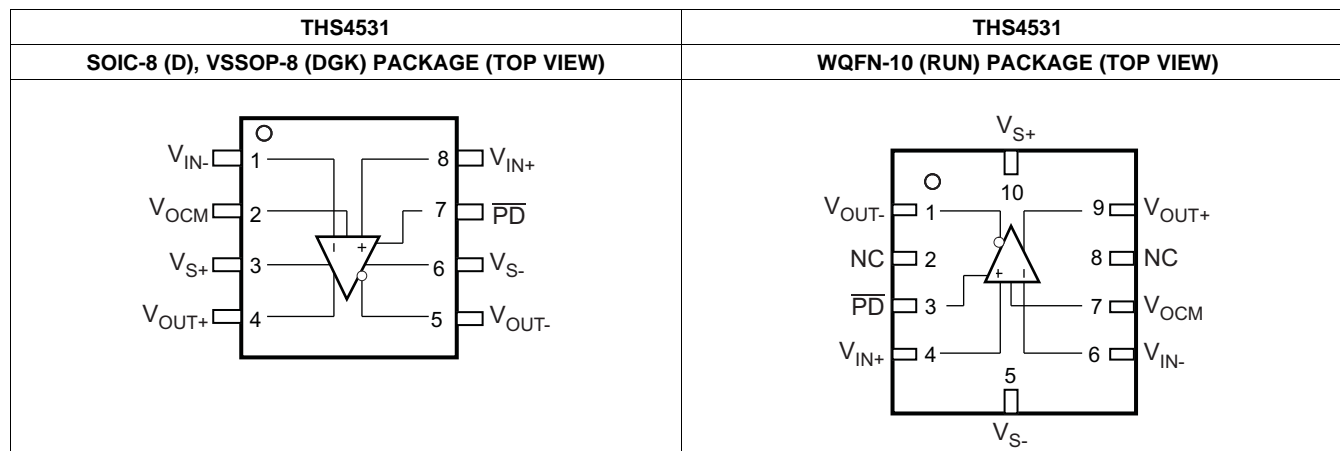
DEVICE INFORMATION
PIN CONFIGURATIONS

PIN FUNCTIONS

NUMBER	NAME	DESCRIPTION
THS4531 D, DGK PACKAGE		
1	V_{IN-}	Inverted (negative) output feedback
2	V_{OCM}	Common-mode voltage input
3	V_{S+}	Amplifier positive power-supply input
4	V_{OUT+}	Noninverted amplifier output
5	V_{OUT-}	Inverted amplifier output
6	V_{S-}	Amplifier negative power-supply input. Note V_{S-} tied together on multichannel devices.
7	\overline{PD}	Power-down, \overline{PD} = logic low = low power mode, \overline{PD} = logic high = normal operation (PIN MUST BE DRIVEN)
8	V_{IN+}	Noninverted amplifier input
THS4531 RUN PACKAGE		
1	V_{OUT-}	Inverted amplifier output
2, 8	NC	No internal connection
3	\overline{PD}	Power-down, \overline{PD} = logic low = low power mode, \overline{PD} = logic high = normal operation (PIN MUST BE DRIVEN)
4	V_{IN+}	Noninverted amplifier input
5	V_{S-}	Amplifier negative power-supply input. Note V_{S-} tied together on multichannel devices.
6	V_{IN-}	Inverting amplifier input
7	V_{OCM}	Common-mode voltage input
9	V_{OUT+}	Noninverted amplifier output
10	V_{S+}	Amplifier positive power-supply input

TABLE OF GRAPHS

Description	V _S = 2.7 V	V _S = 5 V
Small-signal frequency response	Figure 2	Figure 35
Large-signal frequency response	Figure 3	Figure 36
Large- and small- signal pulse response	Figure 4	Figure 37
Single-ended slew rate vs V _{OUT} step	Figure 5	Figure 38
Differential slew rate vs V _{OUT} step	Figure 6	Figure 39
Overdrive recovery	Figure 7	Figure 40
10-kHz FFT on audio analyzer	Figure 8	Figure 41
Harmonic distortion vs Frequency	Figure 9	Figure 42
Harmonic distortion vs Output voltage at 1 MHz	Figure 10	Figure 43
Harmonic distortion vs Gain at 1 MHz	Figure 11	Figure 44
Harmonic distortion vs Load at 1 MHz	Figure 12	Figure 45
Harmonic distortion vs V _{OCM} at 1 MHz	Figure 13	Figure 46
Two-tone, 2nd and 3rd order intermodulation distortion vs Frequency	Figure 14	Figure 47
Single-ended output voltage swing vs Load resistance	Figure 15	Figure 48
Single-ended output saturation voltage vs Load current	Figure 16	Figure 49
Main amplifier differential output impedance vs Frequency	Figure 17	Figure 50
Frequency response vs C _{LOAD}	Figure 18	Figure 51
R _O vs C _{LOAD}	Figure 19	Figure 52
Rejection ratio vs Frequency	Figure 20	Figure 53
Turn-on time	Figure 21	Figure 54
Turn-off time	Figure 22	Figure 55
Input-referred voltage noise and current noise spectral density	Figure 23	Figure 56
Main amplifier differential open-loop gain and phase vs Frequency	Figure 24	Figure 57
Output balance error vs Frequency	Figure 25	Figure 58
V _{OCM} small signal frequency response	Figure 26	Figure 59
V _{OCM} large and small signal pulse response	Figure 27	Figure 60
V _{OCM} input impedance vs frequency	Figure 28	Figure 61
Count vs input offset current	Figure 29	Figure 62
Count vs input offset current temperature drift	Figure 30	Figure 63
Input offset current vs temperature	Figure 31	Figure 64
Count vs input offset voltage	Figure 32	Figure 65
Count vs input offset voltage temperature drift	Figure 33	Figure 66
Input offset voltage vs temperature	Figure 34	Figure 67

TYPICAL CHARACTERISTICS: $V_S = 2.7V$

Test conditions unless otherwise noted: $V_{S+} = 2.7V$, $V_{S-} = 0V$, CM = open, $V_{OUT} = 2V_{pp}$, $R_F = 2k\Omega$, $R_L = 2k\Omega$ Differential, $G = 1V/V$, Single-Ended Input, Differential Output, Input and Output Referenced to mid-supply unless otherwise noted.

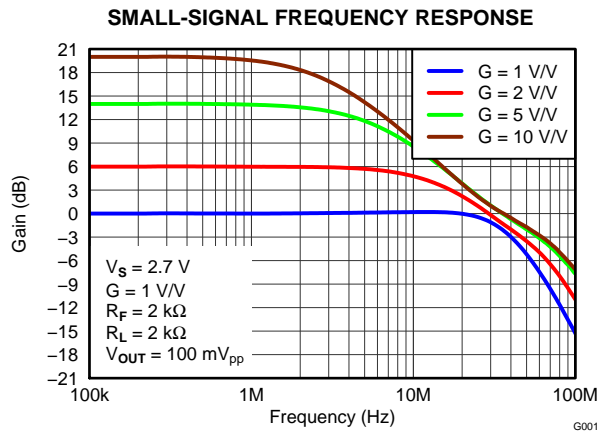

Figure 2.

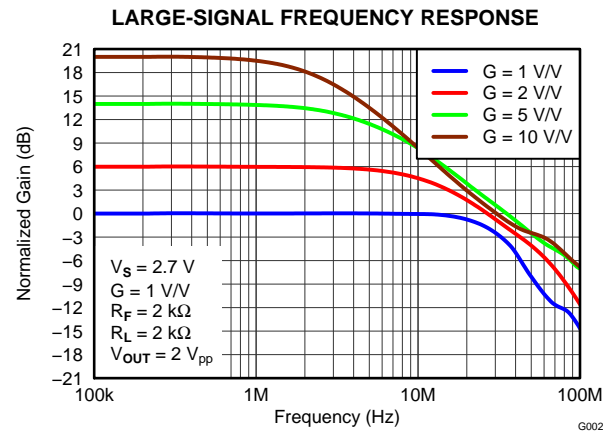

Figure 3.

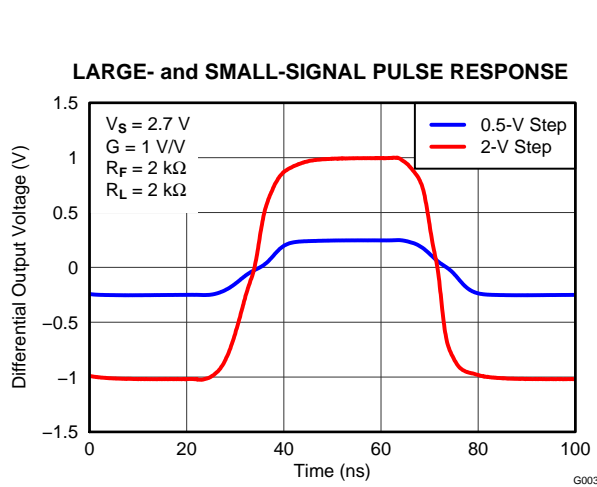

Figure 4.

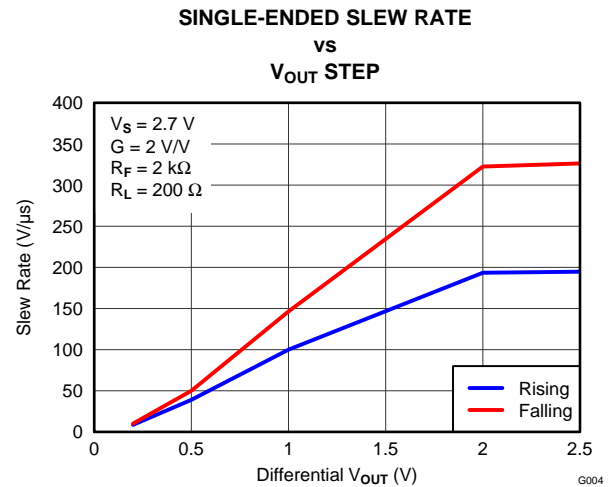

Figure 5.

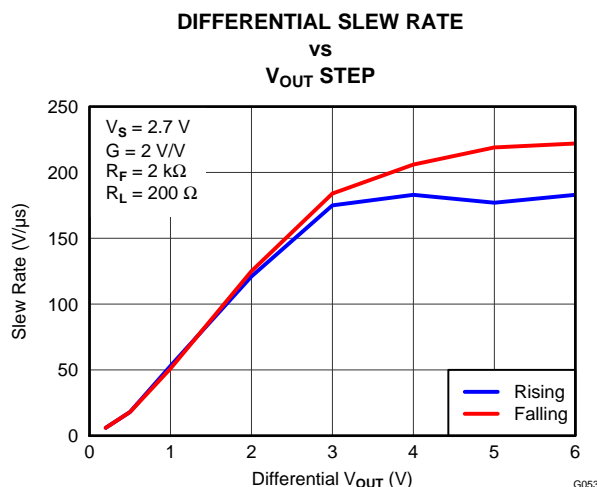

Figure 6.

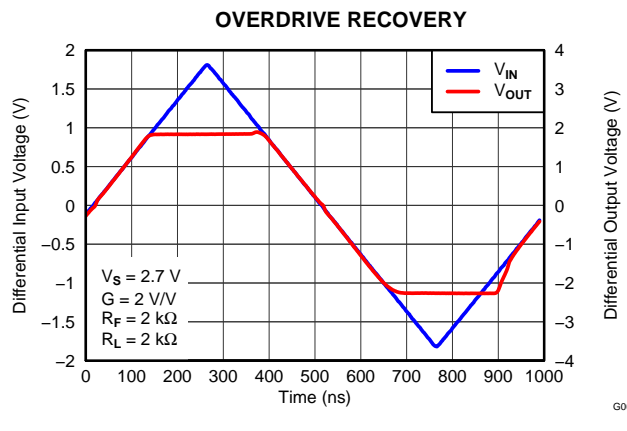

Figure 7.

TYPICAL CHARACTERISTICS: $V_S = 2.7V$ (continued)

Test conditions unless otherwise noted: $V_{S+} = 2.7V$, $V_{S-} = 0V$, CM = open, $V_{OUT} = 2V_{pp}$, $R_F = 2k\Omega$, $R_L = 2k\Omega$ Differential, $G = 1V/V$, Single-Ended Input, Differential Output, Input and Output Referenced to mid-supply unless otherwise noted.

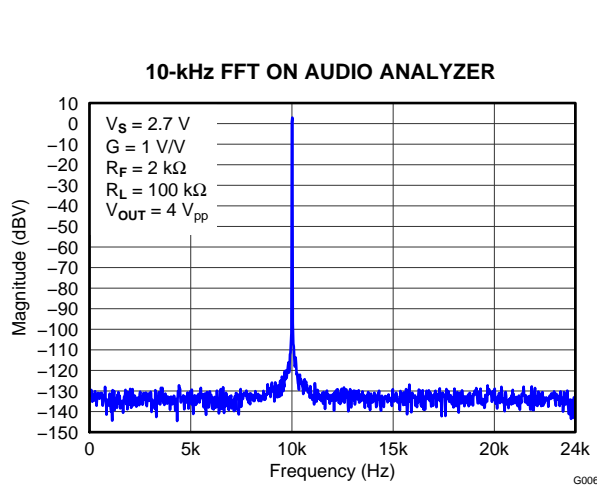

Figure 8.

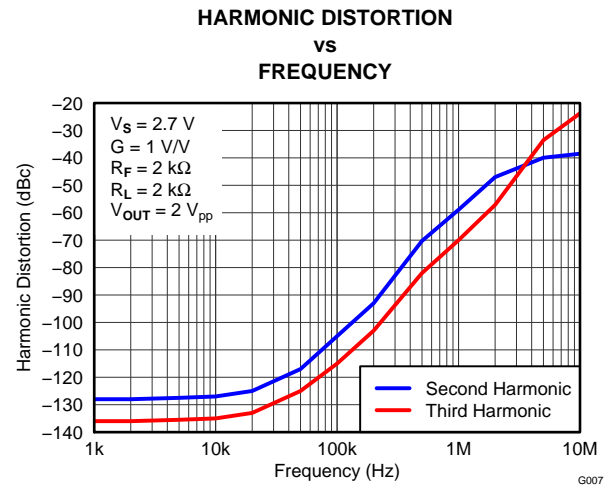

Figure 9.

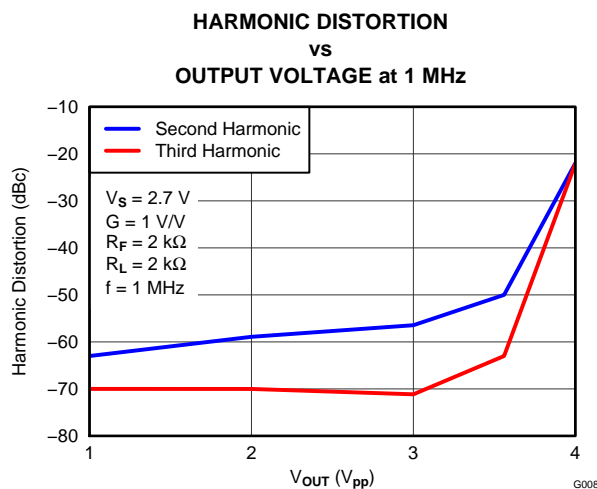

Figure 10.

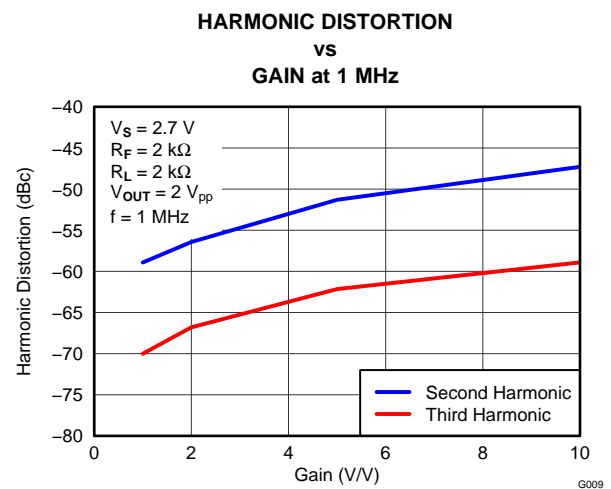

Figure 11.

TYPICAL CHARACTERISTICS: $V_S = 2.7V$ (continued)

Test conditions unless otherwise noted: $V_{S+} = 2.7V$, $V_{S-} = 0V$, CM = open, $V_{OUT} = 2V_{pp}$, $R_F = 2k\Omega$, $R_L = 2k\Omega$ Differential, $G = 1V/V$, Single-Ended Input, Differential Output, Input and Output Referenced to mid-supply unless otherwise noted.

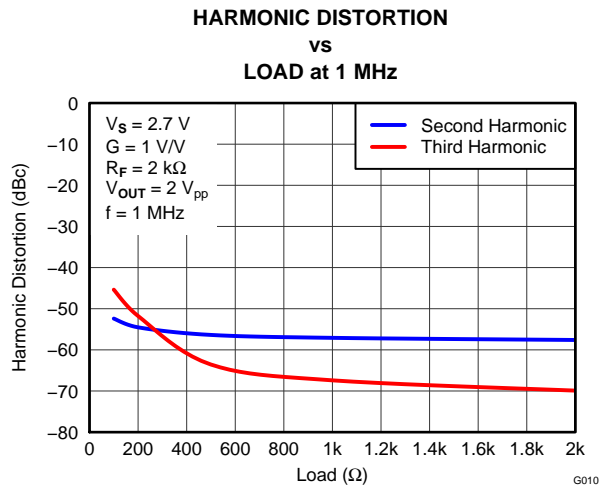

Figure 12.

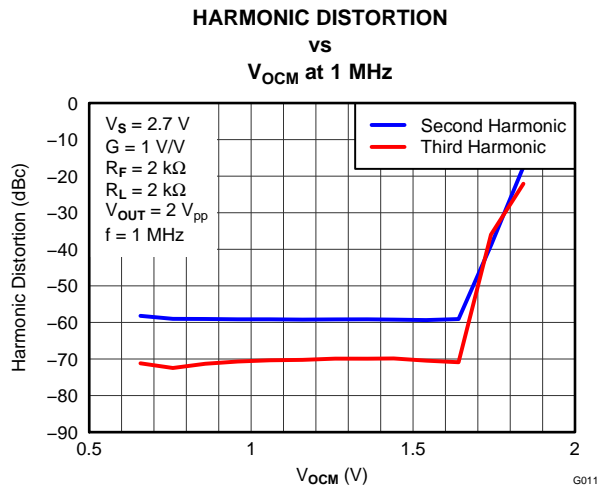

Figure 13.

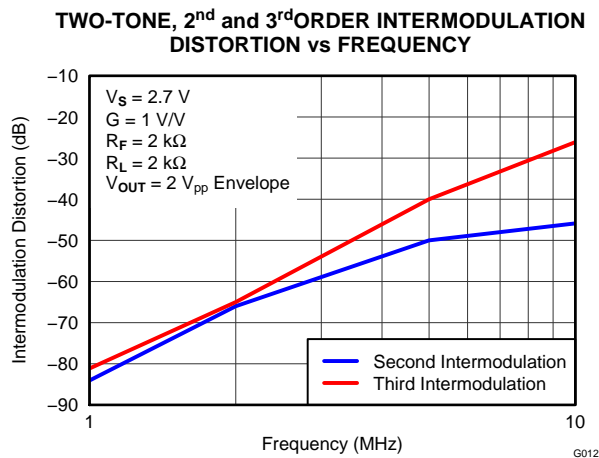

Figure 14.

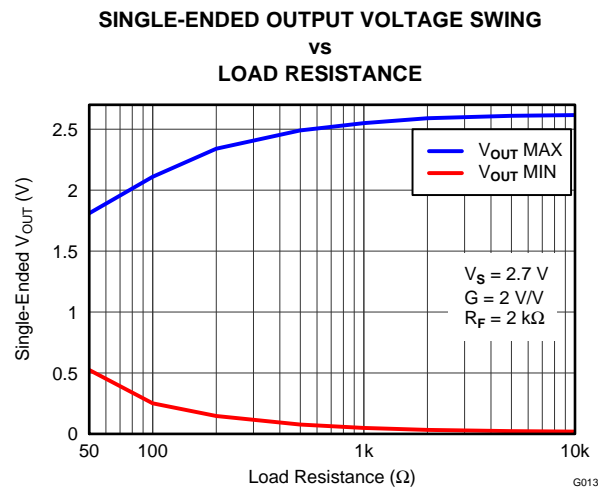

Figure 15.

TYPICAL CHARACTERISTICS: $V_S = 2.7V$ (continued)

Test conditions unless otherwise noted: $V_{S+} = 2.7V$, $V_{S-} = 0V$, CM = open, $V_{OUT} = 2V_{pp}$, $R_F = 2k\Omega$, $R_L = 2k\Omega$ Differential, $G = 1V/V$, Single-Ended Input, Differential Output, Input and Output Referenced to mid-supply unless otherwise noted.

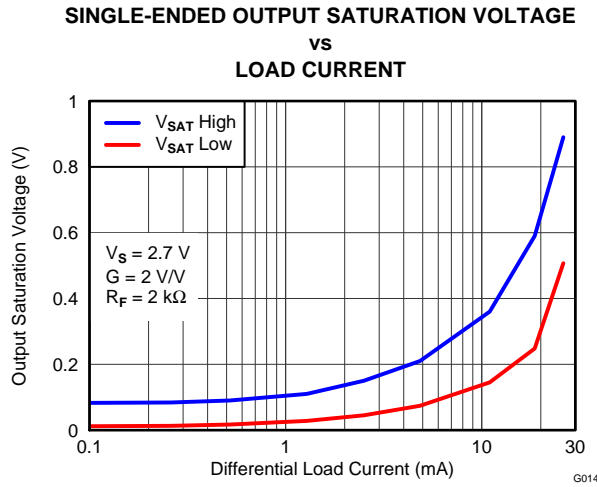

Figure 16.

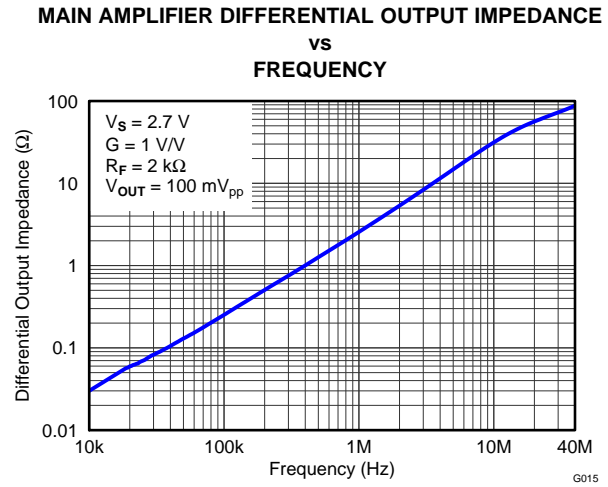

Figure 17.

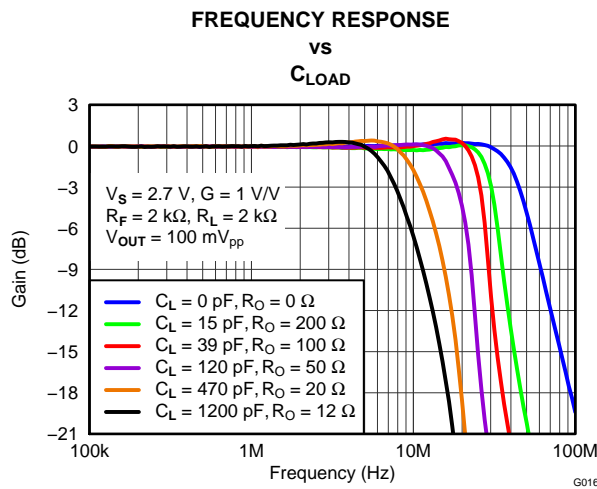

Figure 18.

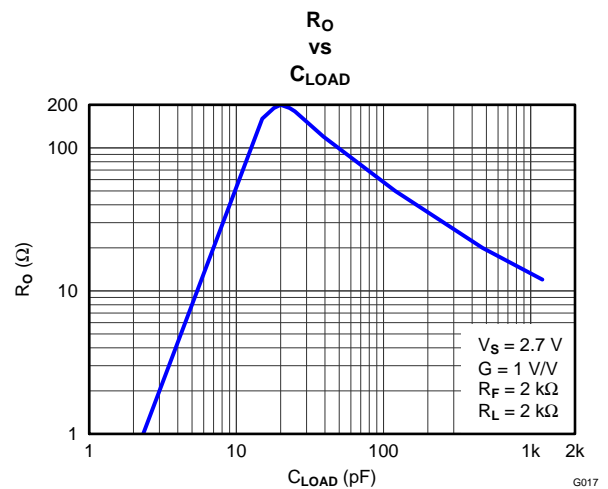

Figure 19.

TYPICAL CHARACTERISTICS: $V_S = 2.7V$ (continued)

Test conditions unless otherwise noted: $V_{S+} = 2.7V$, $V_{S-} = 0V$, CM = open, $V_{OUT} = 2V_{pp}$, $R_F = 2k\Omega$, $R_L = 2k\Omega$ Differential, $G = 1V/V$, Single-Ended Input, Differential Output, Input and Output Referenced to mid-supply unless otherwise noted.

**REJECTION RATIO
vs
FREQUENCY**

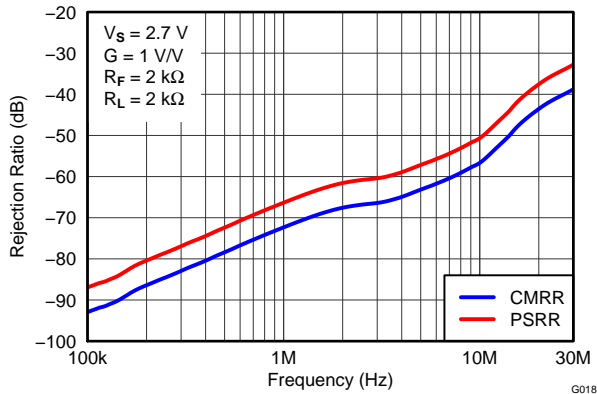

Figure 20.

TURN-ON TIME

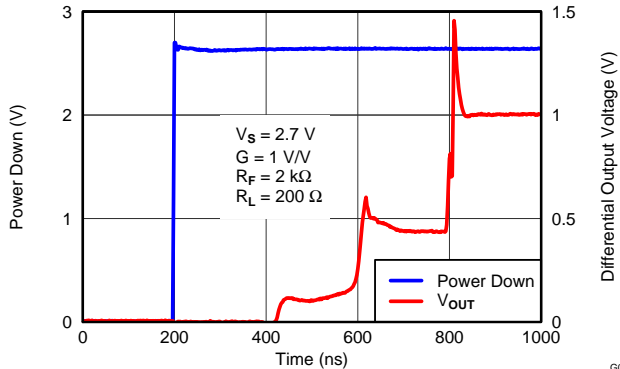

Figure 21.

TURN-OFF TIME

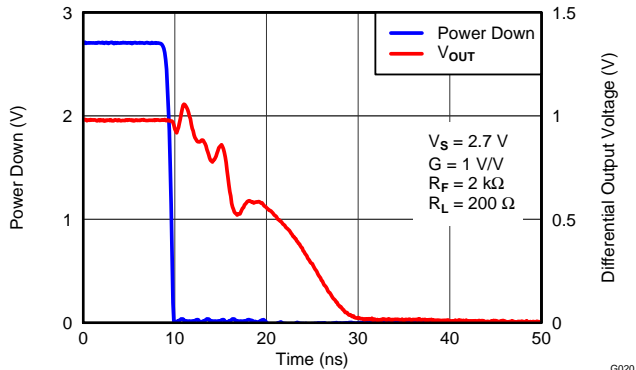

Figure 22.

**INPUT-REFERRED VOLTAGE NOISE
and
CURRENT NOISE SPECTRAL DENSITY**

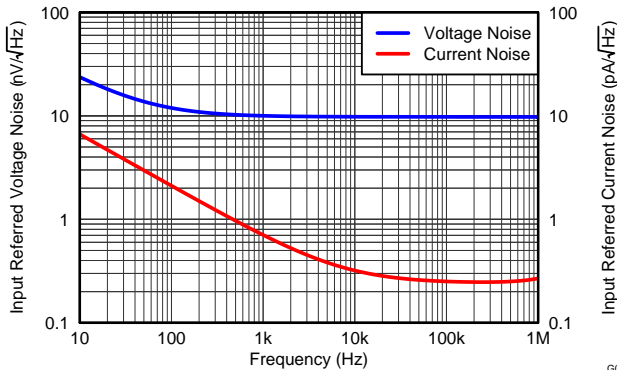

Figure 23.

TYPICAL CHARACTERISTICS: $V_S = 2.7V$ (continued)

Test conditions unless otherwise noted: $V_{S+} = 2.7V$, $V_{S-} = 0V$, CM = open, $V_{OUT} = 2V_{pp}$, $R_F = 2k\Omega$, $R_L = 2k\Omega$ Differential, $G = 1V/V$, Single-Ended Input, Differential Output, Input and Output Referenced to mid-supply unless otherwise noted.

MAIN AMPLIFIER DIFFERENTIAL OPEN-LOOP GAIN and PHASE vs FREQUENCY

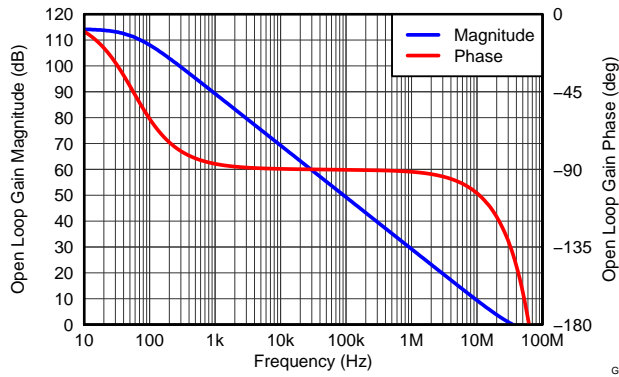

Figure 24.

OUTPUT BALANCE ERROR vs FREQUENCY

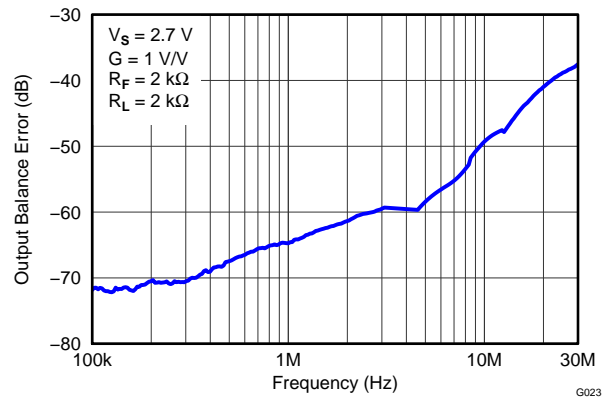

Figure 25.

V_{OCM} SMALL-SIGNAL FREQUENCY RESPONSE

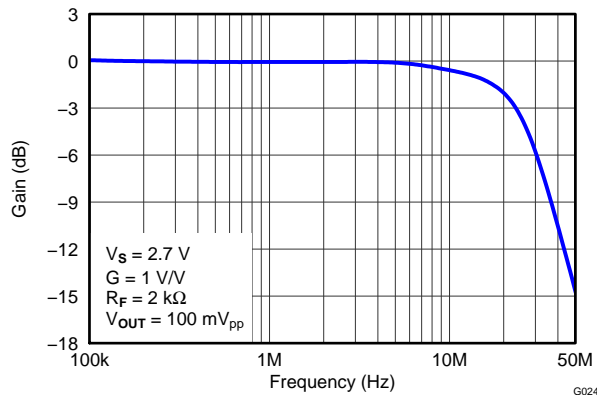

Figure 26.

V_{OCM} LARGE- and SMALL SIGNAL PULSE RESPONSE

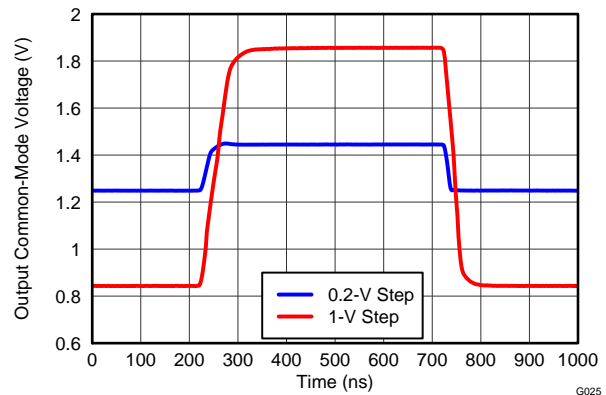

Figure 27.

TYPICAL CHARACTERISTICS: $V_S = 2.7V$ (continued)

Test conditions unless otherwise noted: $V_{S+} = 2.7V$, $V_{S-} = 0V$, CM = open, $V_{OUT} = 2V_{pp}$, $R_F = 2k\Omega$, $R_L = 2k\Omega$ Differential, G = 1V/V, Single-Ended Input, Differential Output, Input and Output Referenced to mid-supply unless otherwise noted.

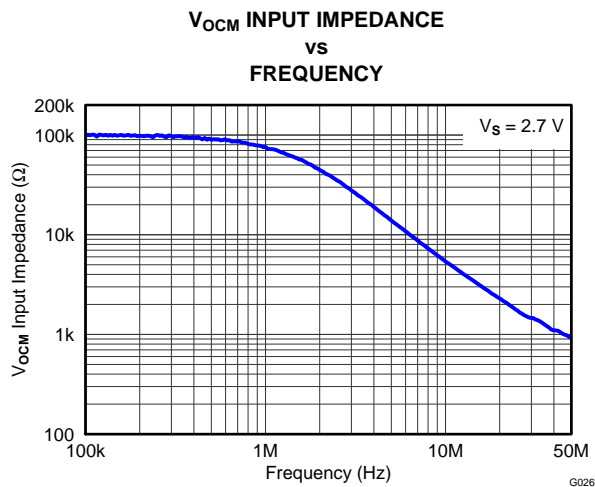

Figure 28.

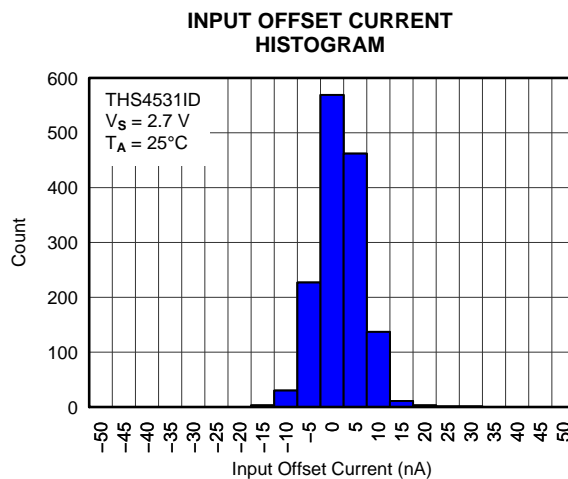

Figure 29.

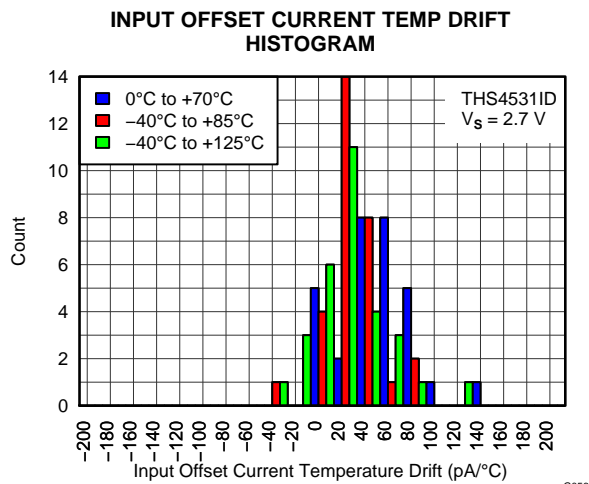

Figure 30.

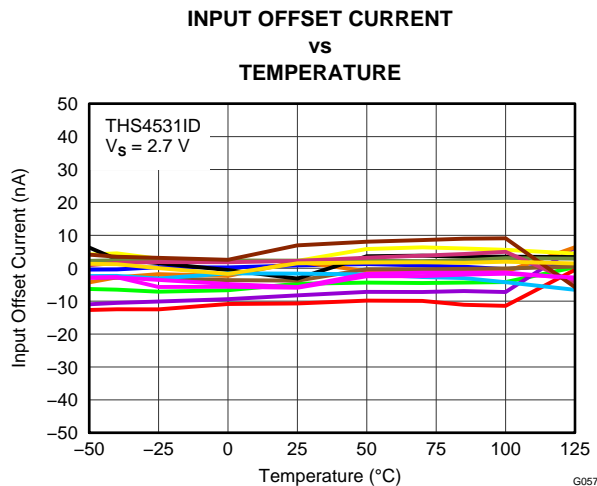

Figure 31.

TYPICAL CHARACTERISTICS: $V_S = 2.7V$ (continued)

Test conditions unless otherwise noted: $V_{S+} = 2.7V$, $V_{S-} = 0V$, CM = open, $V_{OUT} = 2V_{pp}$, $R_F = 2k\Omega$, $R_L = 2k\Omega$ Differential, G = 1V/V, Single-Ended Input, Differential Output, Input and Output Referenced to mid-supply unless otherwise noted.

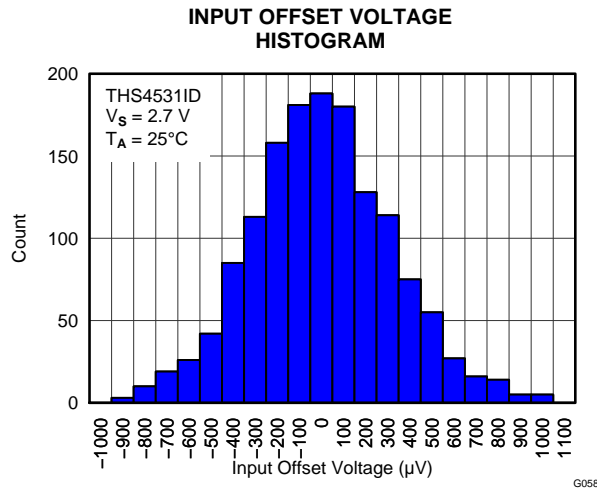

Figure 32.

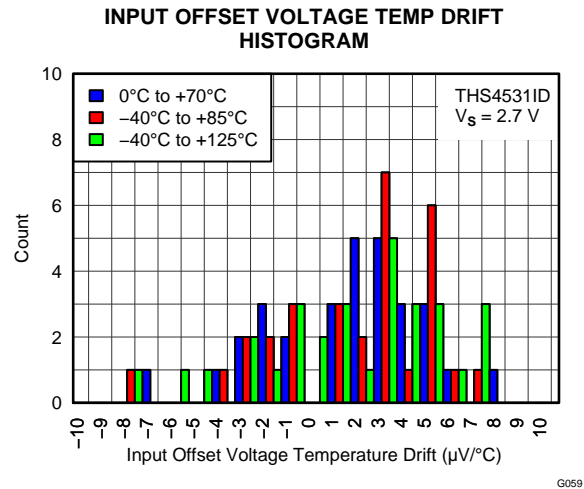

Figure 33.

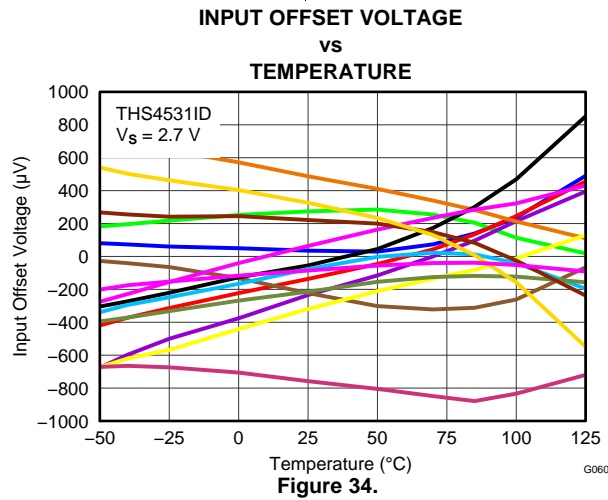

Figure 34.

TYPICAL CHARACTERISTICS: $V_S = 5V$

Test conditions unless otherwise noted: $V_{S+} = 5V$, $V_{S-} = 0V$, $V_{OCM} = \text{open}$, $V_{OUT} = 2V_{pp}$, $R_F = 2k\Omega$, $R_L = 2k\Omega$ Differential, $G = 1V/V$, Single-Ended Input, Differential Output, Input and Output Referenced to mid-supply, $T_A = 25^\circ\text{C}$ unless otherwise noted.

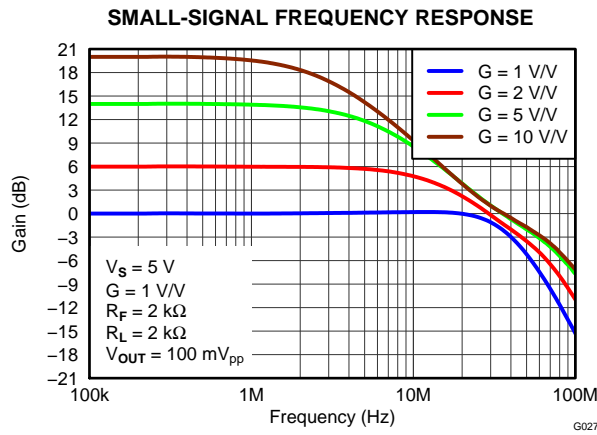

Figure 35.

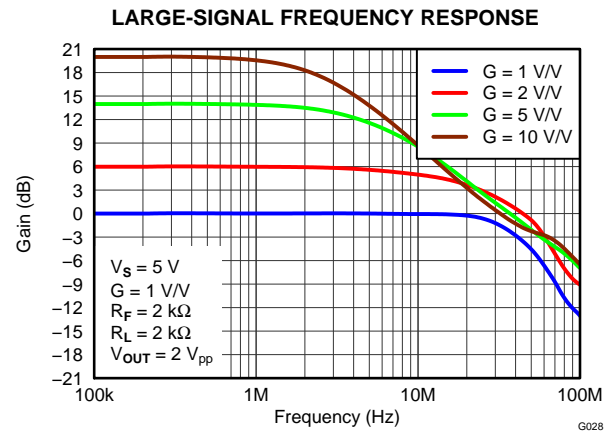

Figure 36.

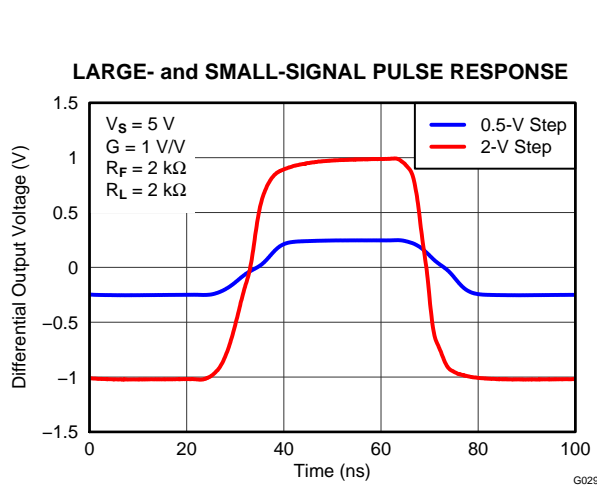

Figure 37.

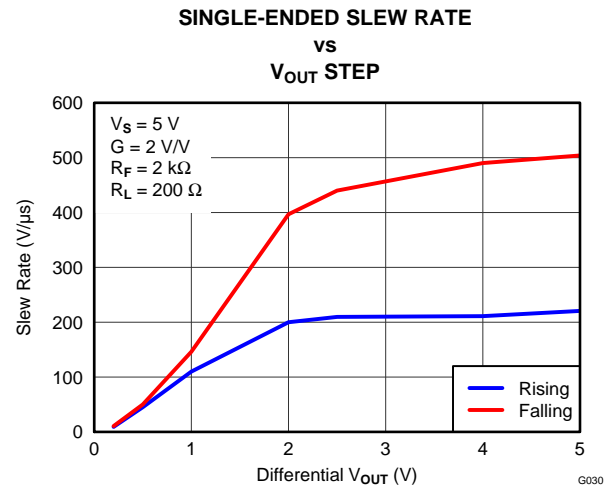

Figure 38.

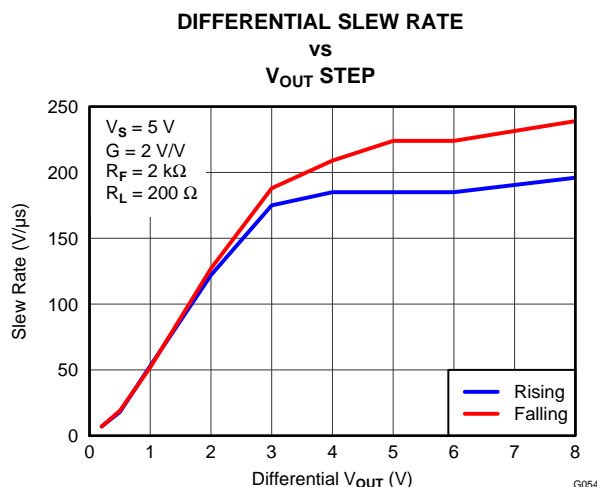

Figure 39.

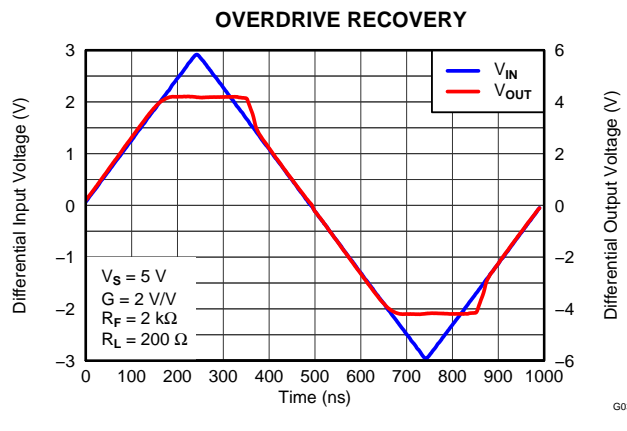

Figure 40.

TYPICAL CHARACTERISTICS: $V_S = 5V$ (continued)

Test conditions unless otherwise noted: $V_{S+} = 5V$, $V_{S-} = 0V$, V_{OCM} = open, $V_{OUT} = 2V_{pp}$, $R_F = 2k\Omega$, $R_L = 2k\Omega$ Differential, $G = 1V/V$, Single-Ended Input, Differential Output, Input and Output Referenced to mid-supply, $T_A = 25^\circ C$ unless otherwise noted.

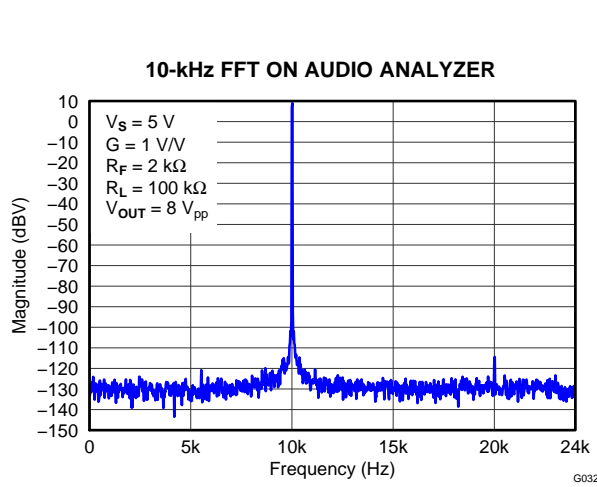

Figure 41.

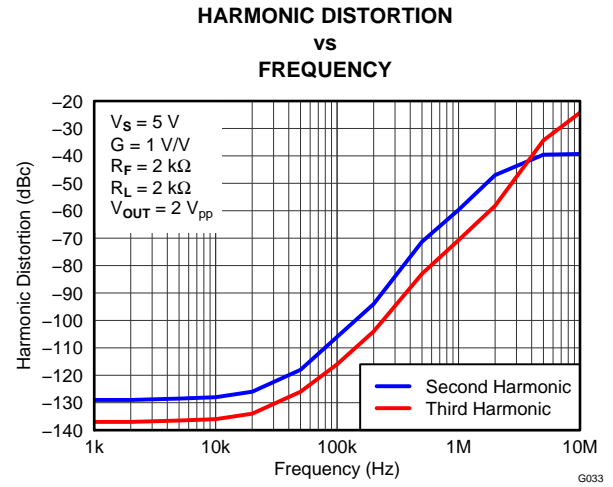

Figure 42.

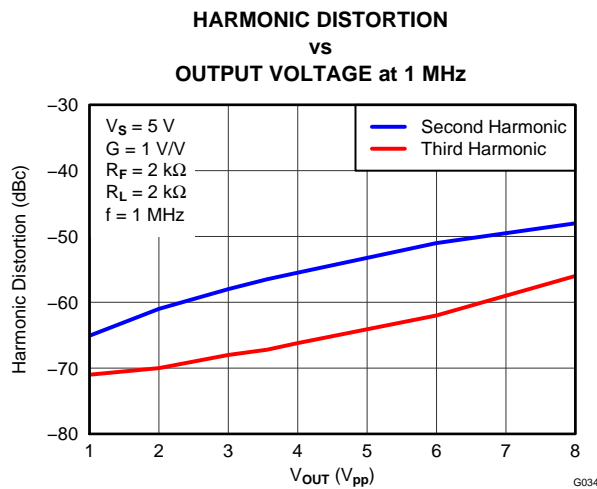

Figure 43.

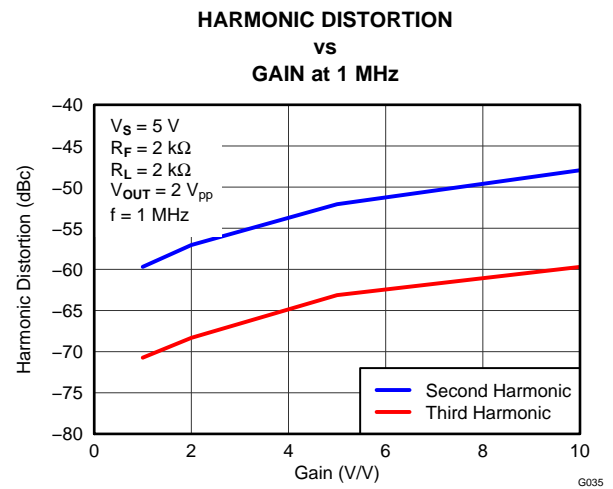

Figure 44.

TYPICAL CHARACTERISTICS: $V_S = 5V$ (continued)

Test conditions unless otherwise noted: $V_{S+} = 5V$, $V_{S-} = 0V$, V_{OCM} = open, $V_{OUT} = 2V_{pp}$, $R_F = 2k\Omega$, $R_L = 2k\Omega$ Differential, $G = 1V/V$, Single-Ended Input, Differential Output, Input and Output Referenced to mid-supply, $T_A = 25^\circ C$ unless otherwise noted.

**HARMONIC DISTORTION
vs
LOAD at 1 MHz**

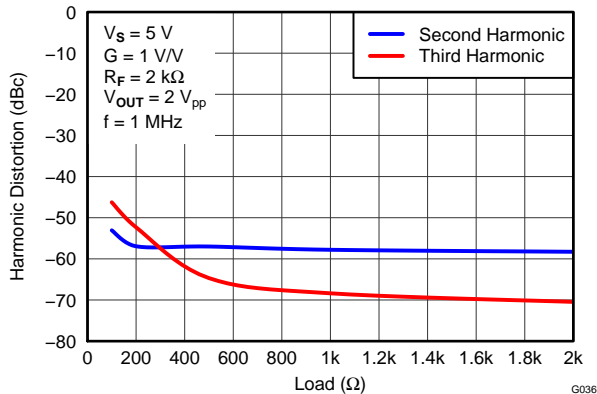

Figure 45.

**HARMONIC DISTORTION
vs
 V_{OCM} at 1 MHz**

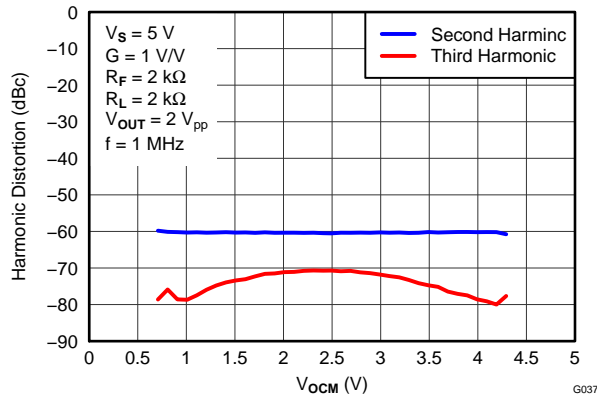

Figure 46.

**TWO-TONE, 2nd and 3rd ORDER INTERMODULATION
DISTORTION vs FREQUENCY**

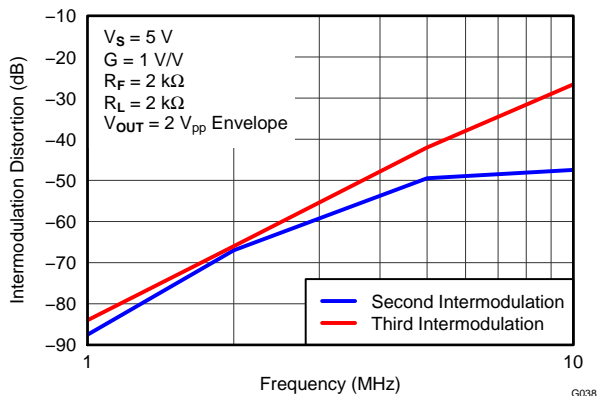

Figure 47.

**SINGLE-ENDED OUTPUT VOLTAGE SWING
vs
LOAD RESISTANCE**

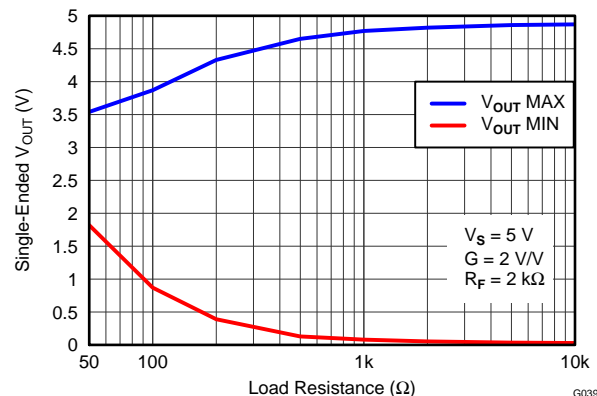

Figure 48.

TYPICAL CHARACTERISTICS: $V_S = 5V$ (continued)

Test conditions unless otherwise noted: $V_{S+} = 5V$, $V_{S-} = 0V$, $V_{OCM} = \text{open}$, $V_{OUT} = 2V_{pp}$, $R_F = 2k\Omega$, $R_L = 2k\Omega$ Differential, $G = 1V/V$, Single-Ended Input, Differential Output, Input and Output Referenced to mid-supply, $T_A = 25^\circ\text{C}$ unless otherwise noted.

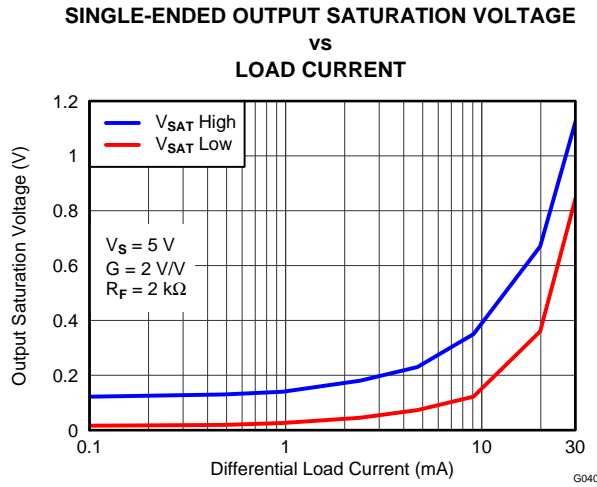

Figure 49.

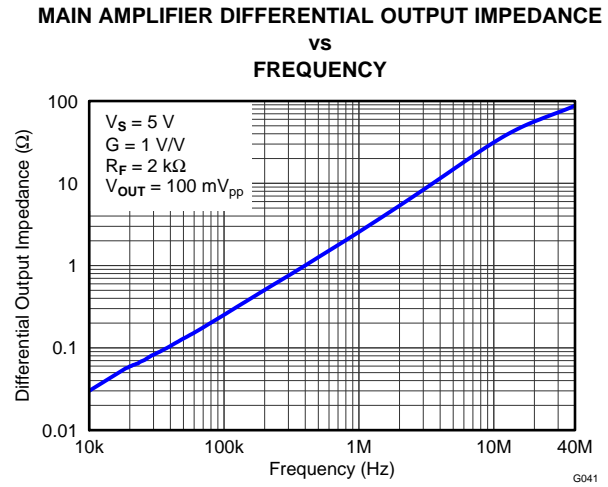

Figure 50.

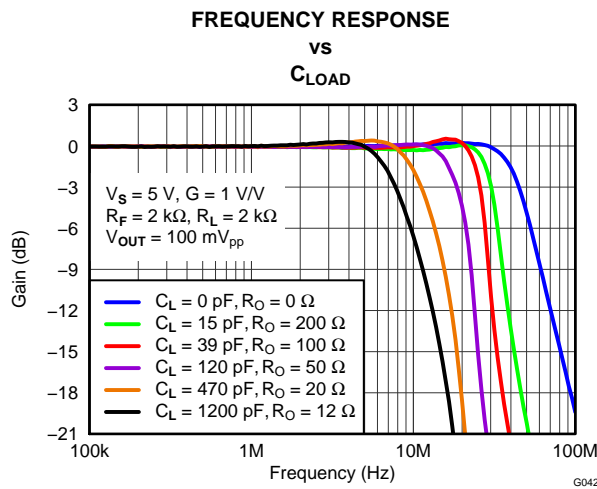

Figure 51.

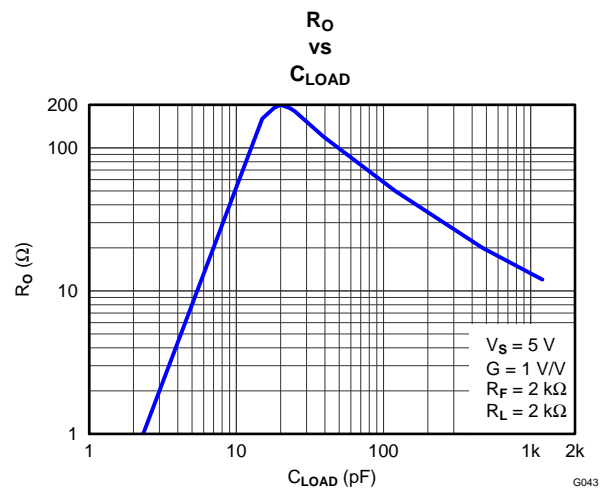

Figure 52.

TYPICAL CHARACTERISTICS: $V_S = 5V$ (continued)

Test conditions unless otherwise noted: $V_{S+} = 5V$, $V_{S-} = 0V$, $V_{OCM} = \text{open}$, $V_{OUT} = 2V_{pp}$, $R_F = 2k\Omega$, $R_L = 2k\Omega$ Differential, $G = 1V/V$, Single-Ended Input, Differential Output, Input and Output Referenced to mid-supply, $T_A = 25^\circ\text{C}$ unless otherwise noted.

**REJECTION RATIO
vs
FREQUENCY**

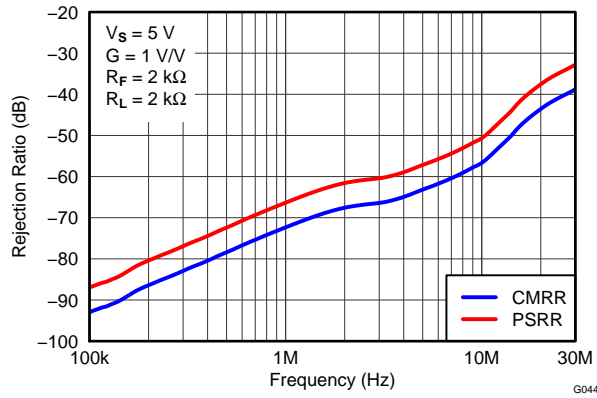

Figure 53.

TURN-ON TIME

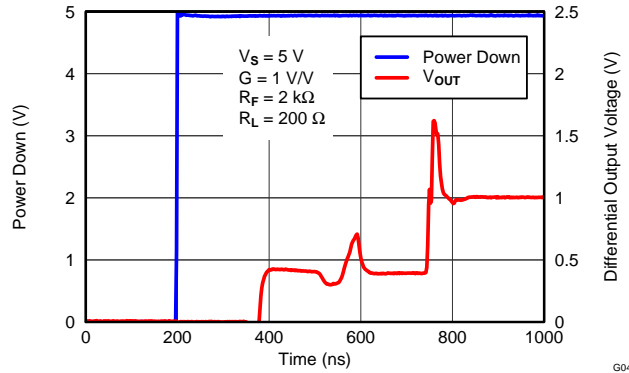

Figure 54.

TURN-OFF TIME

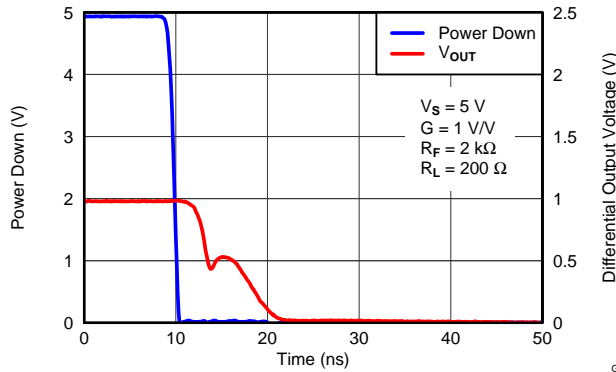

Figure 55.

**INPUT-REFERRED VOLTAGE NOISE
and
CURRENT NOISE SPECTRAL DENSITY**

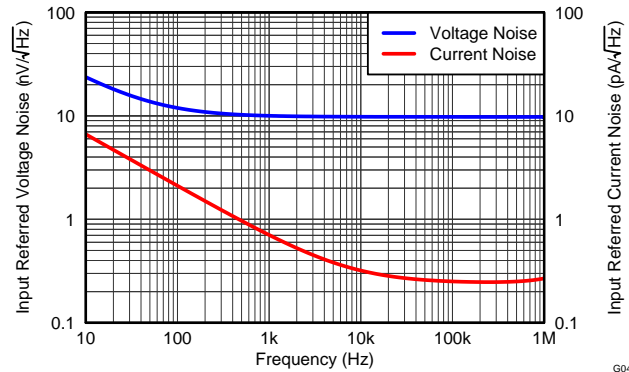

Figure 56.

TYPICAL CHARACTERISTICS: $V_S = 5V$ (continued)

Test conditions unless otherwise noted: $V_{S+} = 5V$, $V_{S-} = 0V$, V_{OCM} = open, $V_{OUT} = 2V_{pp}$, $R_F = 2k\Omega$, $R_L = 2k\Omega$ Differential, $G = 1V/V$, Single-Ended Input, Differential Output, Input and Output Referenced to mid-supply, $T_A = 25^\circ C$ unless otherwise noted.

**MAIN AMPLIFIER DIFFERENTIAL
OPEN-LOOP GAIN and PHASE
vs
FREQUENCY**

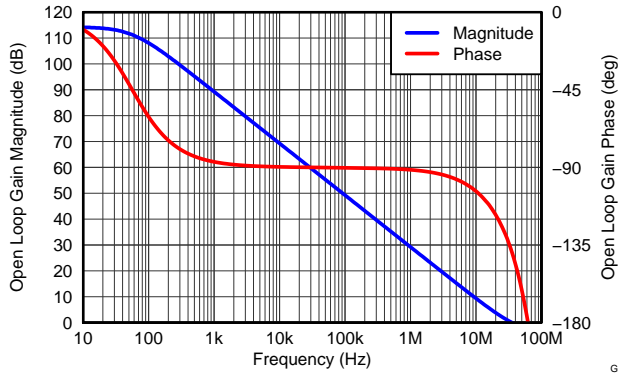

Figure 57.

**OUTPUT BALANCE ERROR
vs
FREQUENCY**

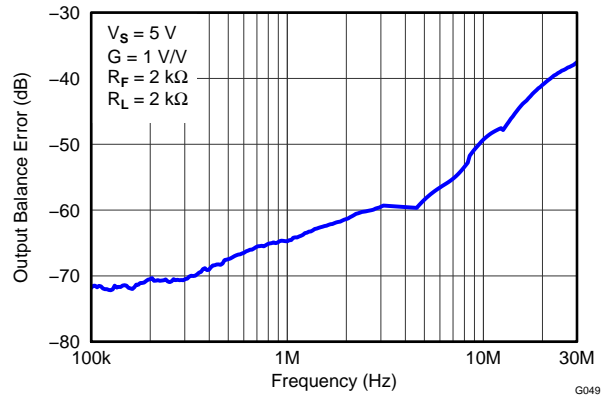

Figure 58.

V_{OCM} SMALL-SIGNAL FREQUENCY RESPONSE

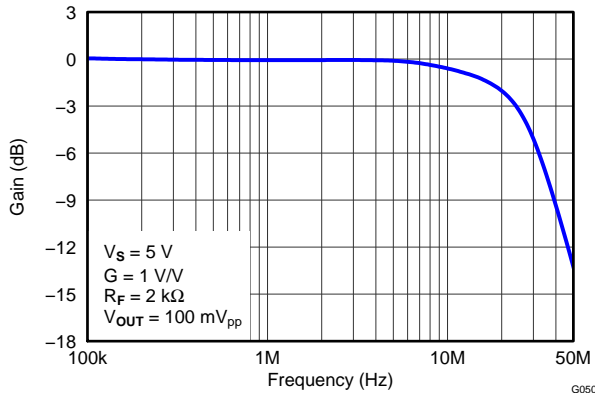

Figure 59.

V_{OCM} LARGE- and SMALL SIGNAL PULSE RESPONSE

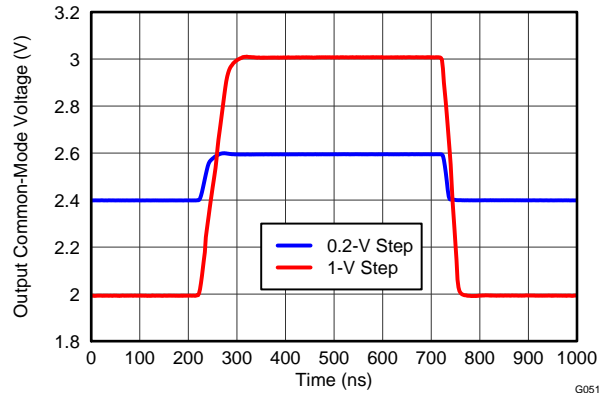

Figure 60.

TYPICAL CHARACTERISTICS: $V_S = 5V$ (continued)

Test conditions unless otherwise noted: $V_{S+} = 5V$, $V_{S-} = 0V$, $V_{OCM} = \text{open}$, $V_{OUT} = 2V_{pp}$, $R_F = 2k\Omega$, $R_L = 2k\Omega$ Differential, $G = 1V/V$, Single-Ended Input, Differential Output, Input and Output Referenced to mid-supply, $T_A = 25^\circ\text{C}$ unless otherwise noted.

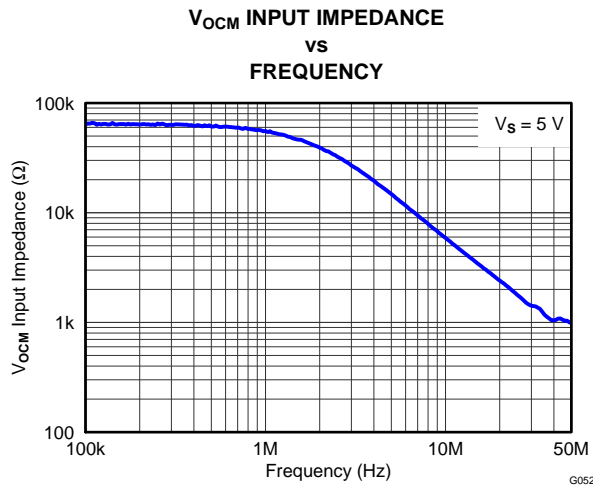

Figure 61.

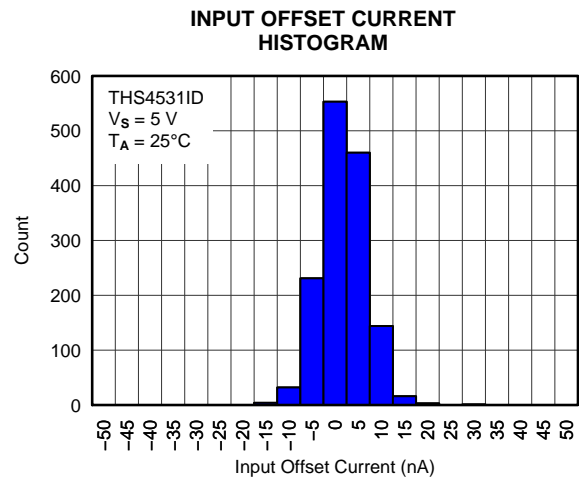

Figure 62.

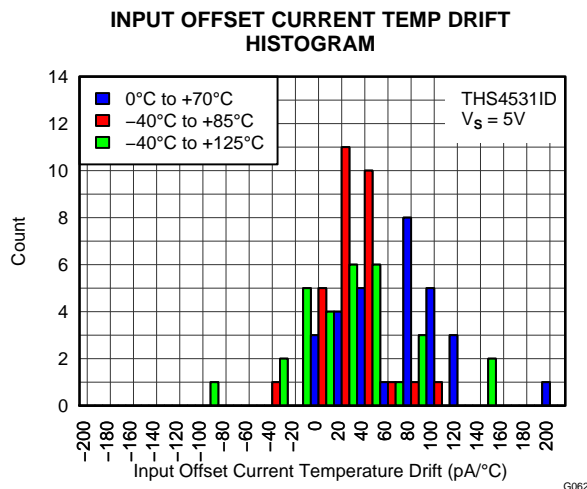

Figure 63.

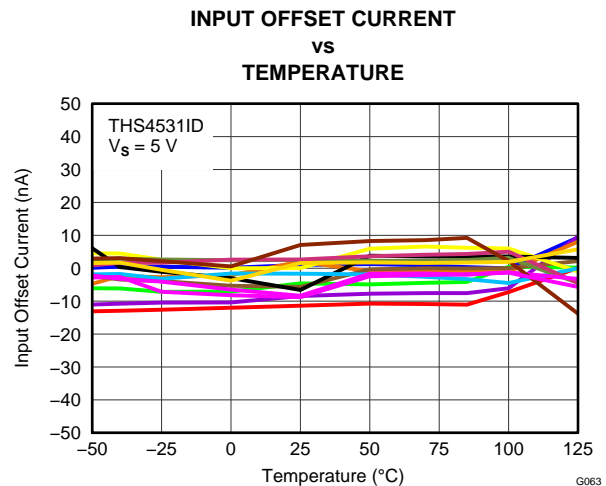

Figure 64.

TYPICAL CHARACTERISTICS: $V_S = 5V$ (continued)

Test conditions unless otherwise noted: $V_{S+} = 5V$, $V_{S-} = 0V$, $V_{OCM} = \text{open}$, $V_{OUT} = 2V_{pp}$, $R_F = 2k\Omega$, $R_L = 2k\Omega$ Differential, $G = 1V/V$, Single-Ended Input, Differential Output, Input and Output Referenced to mid-supply, $T_A = 25^\circ C$ unless otherwise noted.

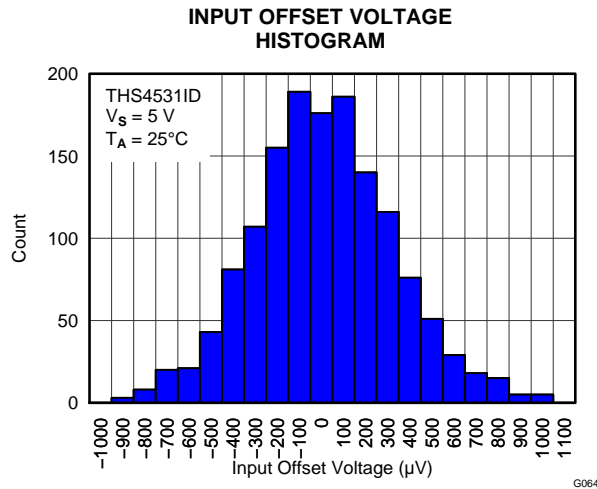

Figure 65.

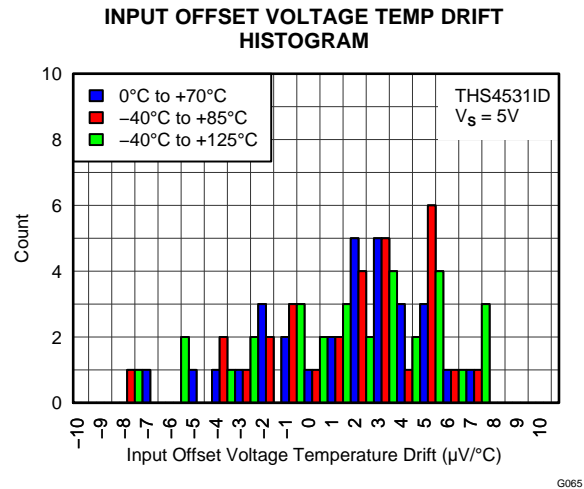

Figure 66.

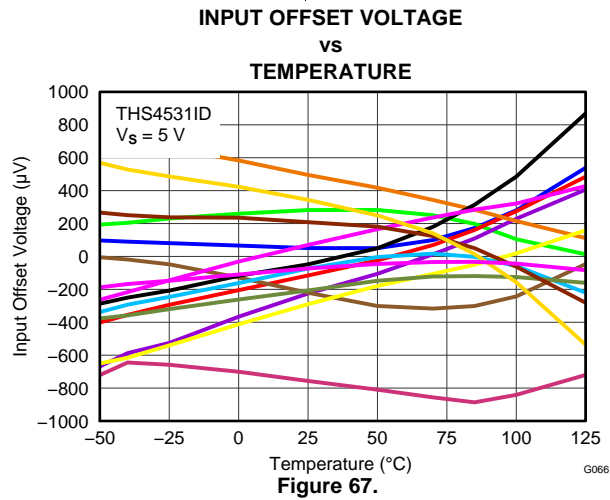

Figure 67.

APPLICATION INFORMATION

TYPICAL CHARACTERISTICS TEST CIRCUITS

Figure 68 shows the general test circuit built on the EVM that was used for testing the THS4531. For simplicity, power supply decoupling is not shown – please see layout in the applications section for recommendations. Depending on the test conditions, component values are changed per Table 2 and Table 3, or as otherwise noted. Some of the signal generators used are ac coupled 50Ω sources and a 0.22μF cap and 49.9Ω resistor to ground are inserted across R_{IT} on the un-driven or alternate input as shown to balance the circuit. Split-power supply is used to ease the interface to common lab test equipment, but if properly biased, the amplifier can be operated single-supply as described in the applications section with no impact on performance. For most of the tests, the devices are tested with single ended input and a transformer on the output to convert the differential output to single ended because common lab test equipment have single ended inputs and outputs. Performance is the same or better with differential input and differential output.

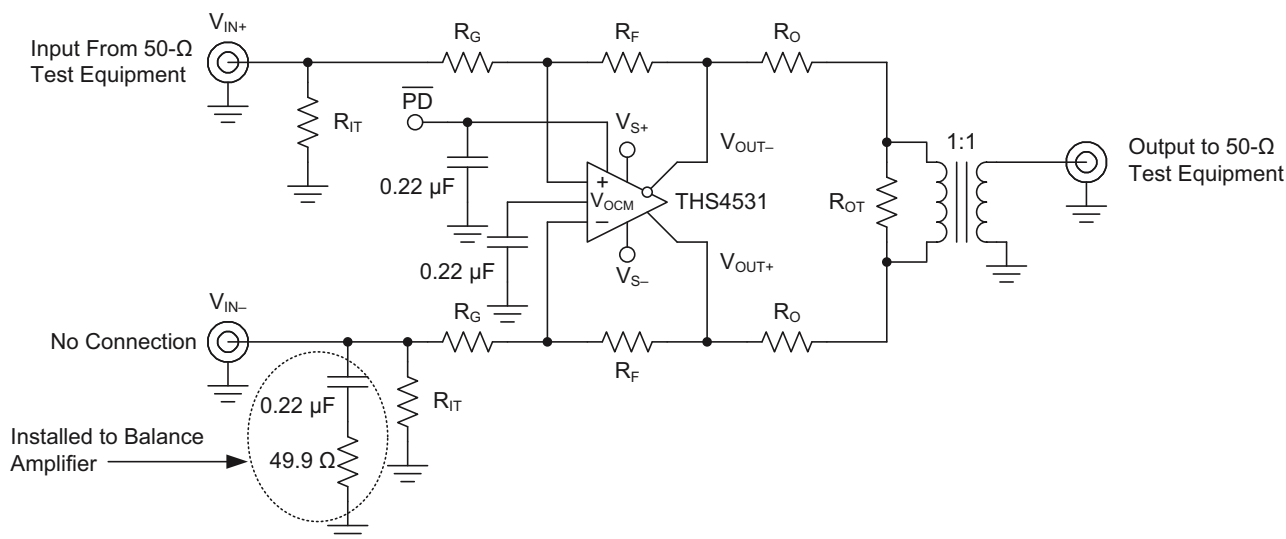

Figure 68. General Test Circuit

Table 2. Gain Component Values for Single-Ended Input⁽¹⁾

GAIN	R_F	R_G	R_{IT}
1 V/V	2kΩ	2kΩ	51.1Ω
2 V/V	2kΩ	1kΩ	52.3Ω
5 V/V	2kΩ	392Ω	53.6Ω
10 V/V	2kΩ	187kΩ	57.6Ω

(1) Note components are chosen to achieve gain and 50Ω input termination. Resistor values shown are closest standard values so gains are approximate.

Table 3. Load Component Values For 1:1 Differential to Single-Ended Output Transformer⁽¹⁾

R_L	R_O	R_{OT}	ATTEN
100Ω	25Ω	open	6
200Ω	86.6Ω	69.8Ω	16.8
499Ω	237Ω	56.2Ω	25.5
1kΩ	487Ω	52.3Ω	31.8
2kΩ	976Ω	51.1Ω	37.9

(1) Note the total load includes 50Ω termination by the test equipment. Components are chosen to achieve load and 50Ω line termination through a 1:1 transformer. Resistor values shown are closest standard values so loads are approximate.

Due to the voltage divider on the output formed by the load component values, the amplifier's output is attenuated. The column "Atten" in [Table 3](#) shows the attenuation expected from the resistor divider. When using a transformer at the output as shown in [Figure 68](#), the signal will see slightly more loss due to transformer and line loss, and these numbers will be approximate. The standard output load used for most tests is 2k Ω with associated 37.9dB of loss.

Frequency Response, and Output Impedance

The circuit shown in [Figure 68](#) is used to measure the frequency response of the amplifier.

A network analyzer is used as the signal source and the measurement device. The output impedance of the network analyzer is 50 Ω and is DC coupled. R_{IT} and R_G are chosen to impedance match to 50 Ω and maintain the proper gain. To balance the amplifier, a 49.9 Ω resistor to ground is inserted across R_{IT} on the alternate input.

The output is routed to the input of the network analyzer via 50 Ω coax. For 2k load, 37.9dB is added to the measurement to refer back to the amplifier's output per [Table 3](#).

For output impedance, the signal is injected at V_{OUT} with V_{IN} left open. The voltage drop across the 2x R_O resistors is measured with a high impedance differential probe and used to calculate the impedance seen looking into the amplifier's output.

Distortion

At 1MHz and above, the circuit shown in [Figure 68](#) is used to measure harmonic, intermodulation distortion, and output impedance of the amplifier.

A signal generator is used as the signal source and the output is measured with a spectrum analyzer. The output impedance of the signal generator is 50 Ω and is AC coupled. R_{IT} and R_G are chosen to impedance match to 50 Ω and maintain the proper gain. To balance the amplifier, a 0.22 μ F cap and 49.9 Ω resistor to ground is inserted across R_{IT} on the alternate input. A low-pass filter is inserted in series with the input to reduce harmonics generated at the signal source. The level of the fundamental is measured and then a high-pass filter is inserted at the output to reduce the fundamental so it does not generate distortion in the input of the spectrum analyzer.

Distortion in the audio band is measured using an audio analyzer. Refer to audio measurement section for detail.

Slew Rate, Transient Response, Settling Time, Overdrive, Output Voltage, and Turn-On/Off Time

The circuit shown in [Figure 69](#) is used to measure slew rate, transient response, settling time, overdrive recovery, and output voltage swing. Turn on and turn off times are measured with 50 Ω input termination on the \overline{PD} input, by replacing the 0.22 μ F capacitor with 49.9 Ω resistor.

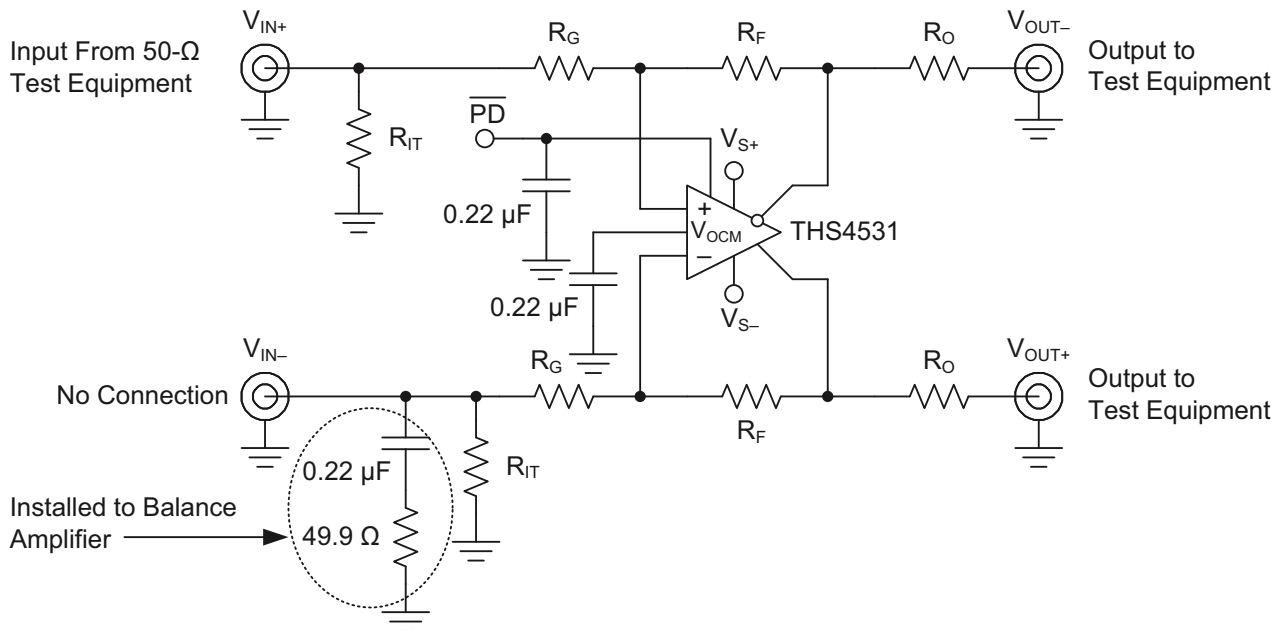

Figure 69. Slew Rate, Transient Response, Settling Time, Z_O , Overdrive Recovery, V_{OUT} Swing, and Turn-on/off Test Circuit

Common-Mode and Power Supply Rejection

The circuit shown in Figure 70 is used to measure the CMRR. The signal from the network analyzer is applied common-mode to the input.

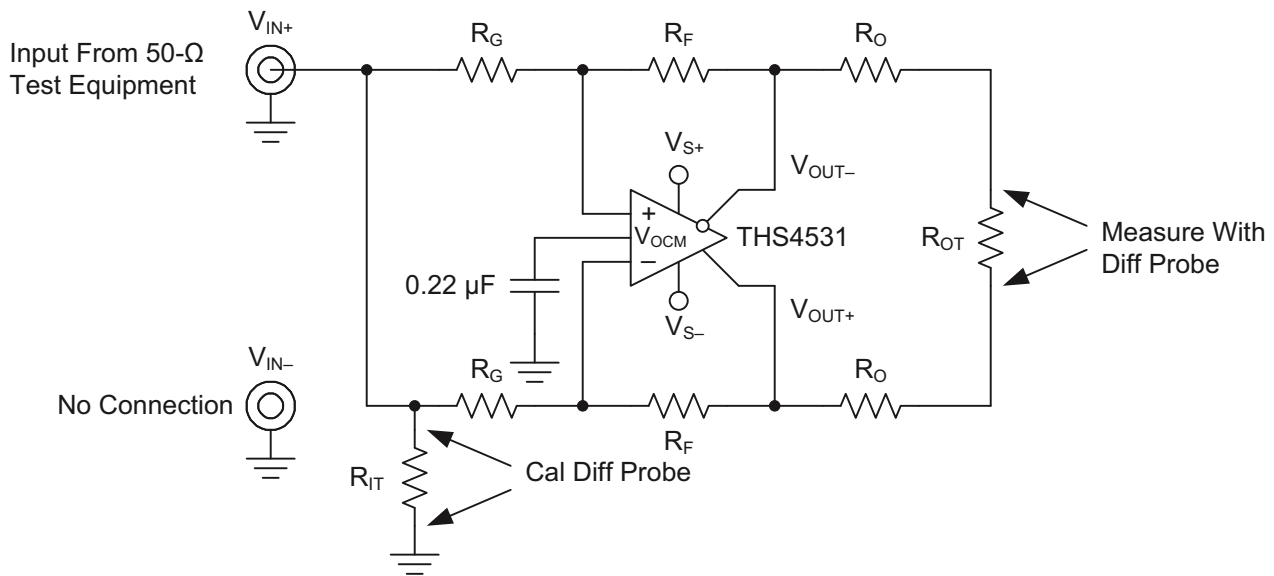

Figure 70. CMRR Test Circuit

Figure 71 is used to measure the PSRR of V_{S+} and V_{S-} . The power supply is applied to the network analyzer's DC offset input. For both CMRR and PSRR, the output is probed using a high impedance differential probe across R_{OT} .

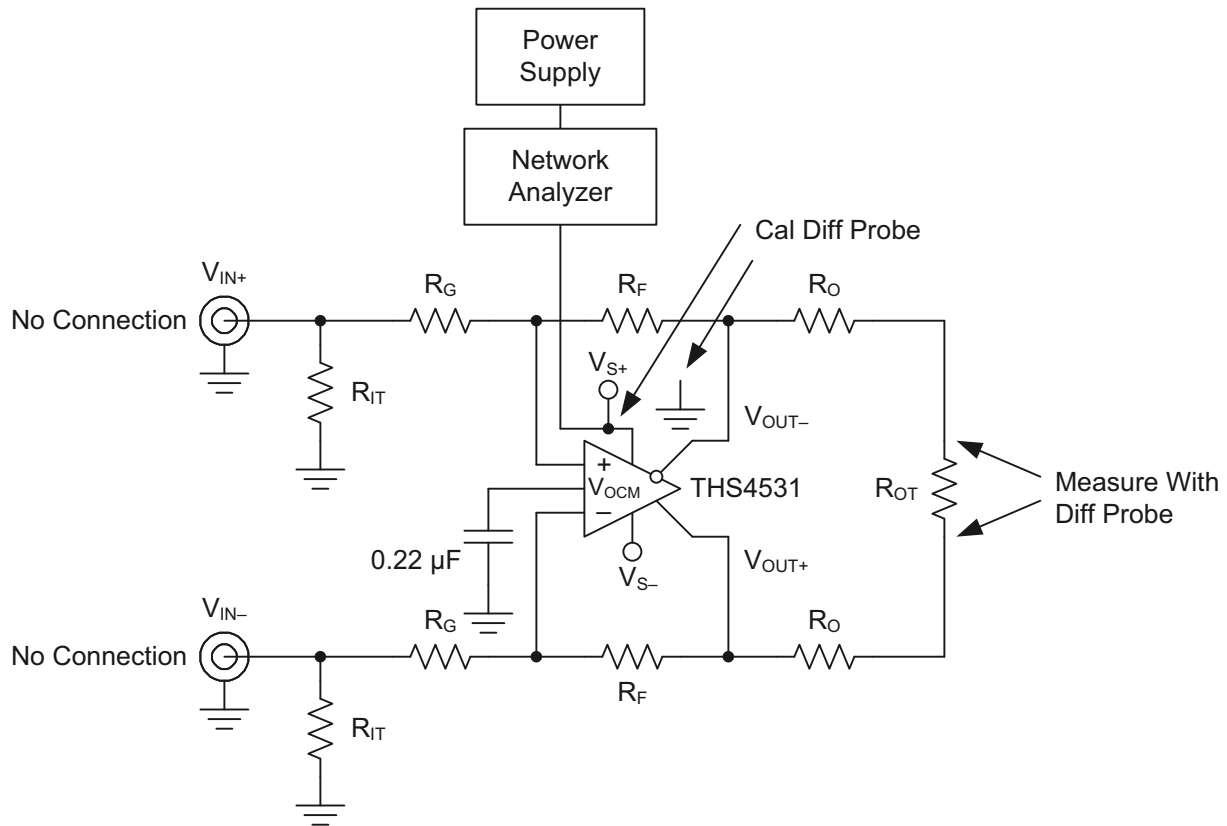

Figure 71. PSRR Test Circuit

V_{OCM} Input

The circuit shown in Figure 72 is used to measure the transient response, frequency response and input impedance of the V_{OCM} input. For these tests, the cal point is across the 49.9Ω V_{OCM} termination resistor. Transient response and frequency response are measured with R_{CM} = 0Ω and using a high impedance differential probe at the summing junction of the two R_O resistors, with respect to ground. The input impedance is measured using a high impedance differential probe at the V_{OCM} pin and the drop across R_{CM} is used to calculate the impedance seen looking into the amplifier's V_{OCM} input.

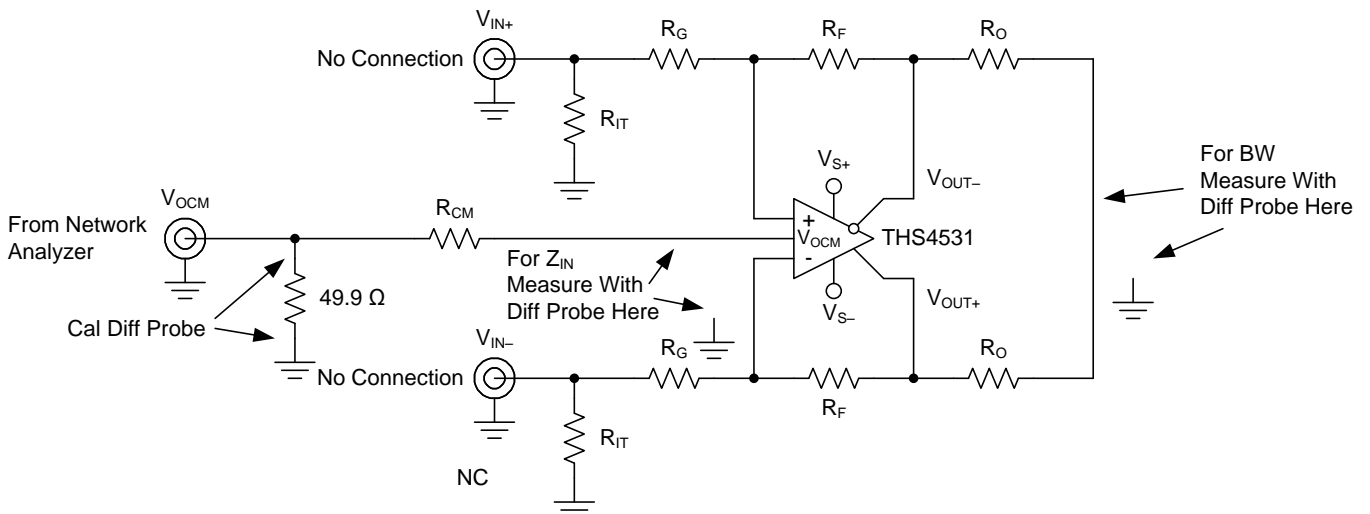

Figure 72. V_{OCM} Input Test Circuit

Balance Error

The circuit shown in Figure 73 is used to measure the balance error of the main differential amplifier. A network analyzer is used as the signal source and the measurement device. The output impedance of the network analyzer is 50Ω and is DC coupled. R_{IT} and R_G are chosen to impedance match to 50Ω and maintain the proper gain. To balance the amplifier, a 49.9Ω resistor to ground is inserted across R_{IT} on the alternate input. The output is measured using a high impedance differential probe at the summing junction of the two R_O resistors, with respect to ground.

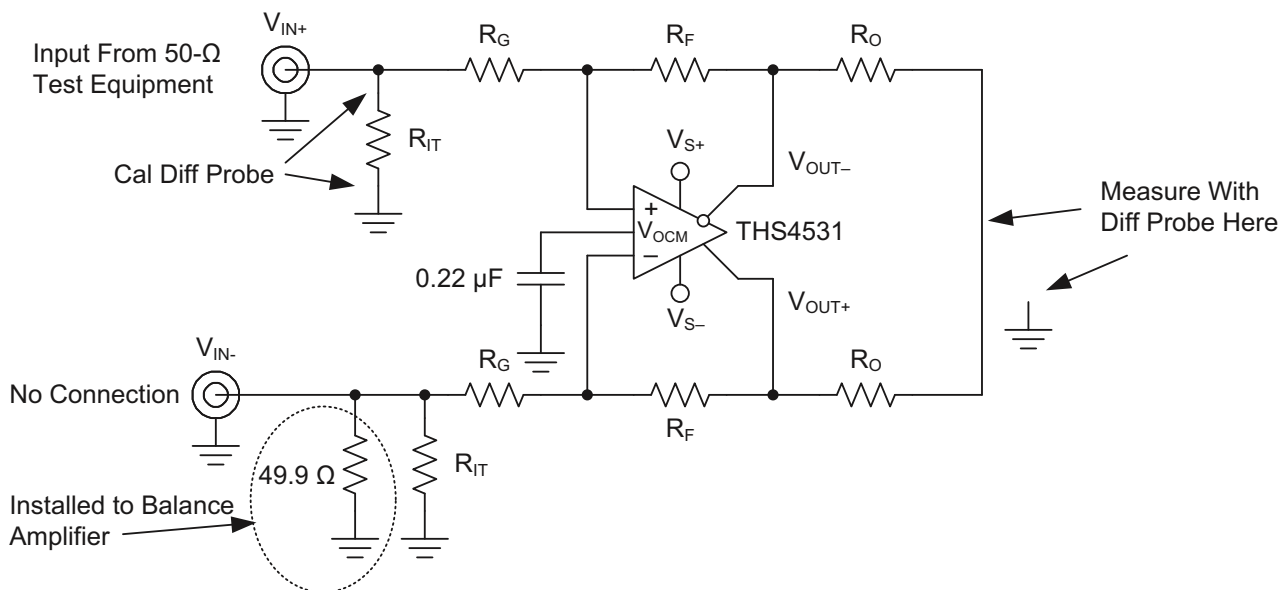

Figure 73. Balance Error Test Circuit

APPLICATION CIRCUITS

The following circuits show application information for the THS4531. For simplicity, power supply decoupling capacitors are not shown in these diagrams – please see the EVM and Layout Recommendations section for recommendations. For more detail on the use and operation of fully differential op amps refer to application report “Fully-Differential Amplifiers” [SLOA054D](#).

Differential Input to Differential Output Amplifier

The THS4531 is a fully differential op amp and can be used to amplify differential input signals to differential output signals. A basic block diagram of the circuit is shown in [Figure 74](#) (V_{OCM} and PD inputs not shown). The gain of the circuit is set by R_F divided by R_G .

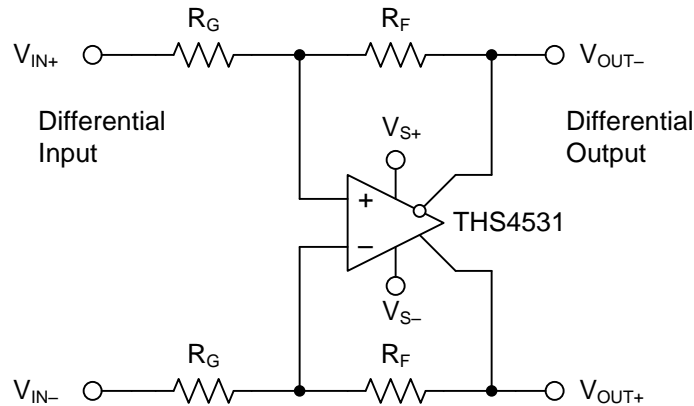

Figure 74. Differential Input to Differential Output Amplifier

Single-Ended Input to Differential Output Amplifier

The THS4531 can also be used to amplify and convert single-ended input signals to differential output signals. A basic block diagram of the circuit is shown in [Figure 75](#) (V_{OCM} and PD inputs not shown). The gain of the circuit is again set by R_F divided by R_G .

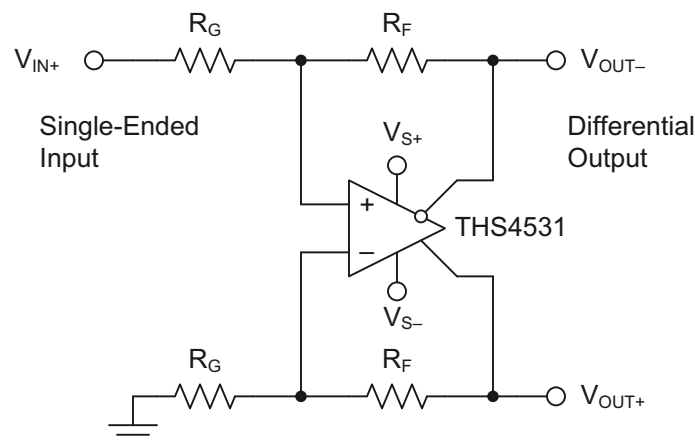

Figure 75. Single-Ended Input to Differential Output Amplifier

Differential Input to Single-Ended Output Amplifier

Fully differential op amps like the THS4531 are not recommended for differential to single-ended conversion. This application is best performed with an instrumentation amplifier or with a standard op amp configured as a classic differential amplifier. See application section of the OPA835 data sheet ([SLOS713](#)).

Input Common-Mode Voltage Range

The input common-mode voltage of a fully differential op amp is the voltage at the “+ and –” input pins of the op amp.

It is important to not violate the input common-mode voltage range (V_{ICR}) of the op amp. Assuming the op amp is in linear operation the voltage across the input pins is only a few millivolts at most. So finding the voltage at one input pin will determine the input common-mode voltage of the op amp.

Treating the negative input as a summing node, the voltage is given by:

$$\left(V_{OUT+} \times \frac{R_G}{R_G + R_F} \right) + \left(V_{IN-} \times \frac{R_F}{R_G + R_F} \right) \quad (1)$$

To determine the V_{ICR} of the op amp, the voltage at the negative input is evaluated at the extremes of V_{OUT+} .

As the gain of the op amp increases, the input common-mode voltage becomes closer and closer to the input common-mode voltage of the source.

Setting the Output Common-Mode Voltage

The output common-mode voltage is set by the voltage at the V_{OCM} pin and the internal circuit works to maintain the output common-mode voltage as close as possible to this voltage. If left unconnected, the output common-mode is set to mid-supply by internal circuitry, which may be over-driven from an external source. Figure 76 is representative of the V_{OCM} input. The internal V_{OCM} circuit has about 24MHz of -3dB bandwidth, which is required for best performance, but it is intended to be a DC bias input pin. Bypass capacitors are recommended on this pin to reduce noise. The external current required to overdrive the internal resistor divider is given approximately by the formula:

$$I_{EXT} = \frac{2V_{OCM} - (V_{S+} - V_{S-})}{60k\Omega} \quad (2)$$

where V_{OCM} is the voltage applied to the V_{OCM} pin.

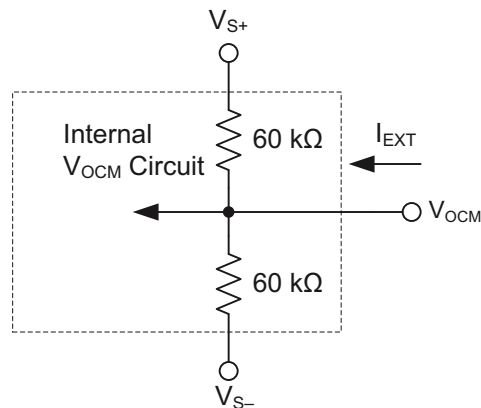

Figure 76. Simplified V_{OCM} Input Circuit

Single-Supply Operation

To facilitate testing with common lab equipment, the THS4531 EVM is built to allow for split-supply operation and most of the data presented in this data sheet was taken with split-supply power inputs. But the device is designed for use with single-supply power operation and can easily be used with single-supply power without degrading the performance. The only requirement is to bias the device properly and the specifications in this data sheet are given for single supply operation.

Low Power Applications and the Effects of Resistor Values on Bandwidth

The THS4531 is designed for the nominal value of R_F to be 2 k Ω . This gives excellent distortion performance, maximum bandwidth, best flatness, and best pulse response. It also loads the amplifier. For example; in gain of 1 with $R_F = R_G = 2$ k Ω , R_G to ground, and $V_{OUT+} = 4V$, 1mA of current will flow through the feedback path to ground. In low power applications, it is desirable to reduce this current by increasing the gain setting resistors values. Using larger value gain resistors has two primary side effects (other than lower power) due to their interaction with the device and PCB parasitic capacitance:

1. Lowers the bandwidth.
2. Lowers the phase margin
 - (a) This will cause peaking in the frequency response.
 - (b) And will cause over shoot and ringing in the pulse response.

Figure 77 shows the small signal frequency response for gain of 1 with R_F and R_G equal to 2k Ω , 10k Ω , and 100k Ω . The test was done with $R_L = 2$ k Ω . Due to loading effects of R_L , lower values may reduce the peaking, but higher values will not have a significant effect.

As expected, larger value gain resistors cause lower bandwidth and peaking in the response (peaking in frequency response is synonymous with overshoot and ringing in pulse response).

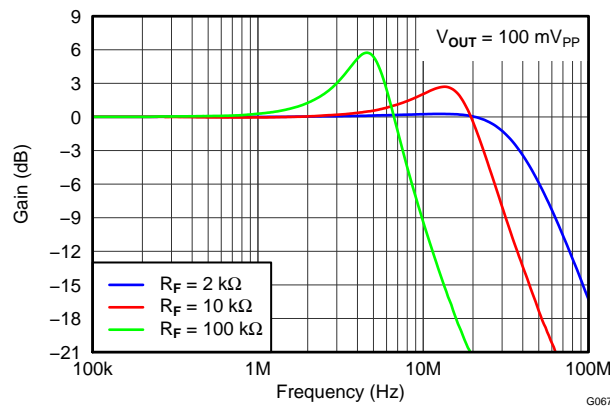

Figure 77. THS4531 Frequency Response with Various Gain Setting Resistor Values

Driving Capacitive Loads

The THS4531 is designed for a nominal capacitive load of 2pF (differentially). When driving capacitive loads greater than this, it is recommended to use small resistors (R_O) in series with the output as close to the device as possible. Without R_O , capacitance on the output will interact with the output impedance of the amplifier causing phase shift in the loop gain of the amplifier that will reduce the phase margin resulting in:

1. Peaking in the frequency response.
2. Overshoot, undershoot, and ringing in the time domain response with a pulse or square-wave signal.
3. May lead to instability or oscillation.

Inserting R_O will compensate the phase shift and restore the phase margin, but it will also limit bandwidth. The circuit shown in Figure 69 is used to test for best R_O versus capacitive loads, C_L , with a capacitance placed differential across the V_{OUT+} and V_{OUT-} along with 2k Ω load resistor, and the output is measure with a differential probe. Figure 78 shows the optimum values of R_O versus capacitive loads, C_L , and Figure 79 shows the frequency response with various values. Performance is the same on both 2.7V and 5V supply.

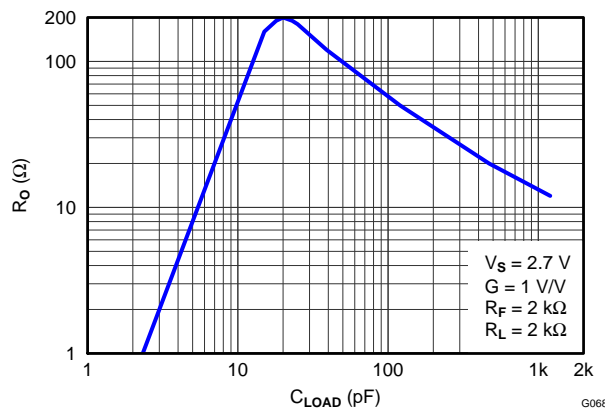

Figure 78. Recommended Series Output Resistor vs Capacitive Load for Flat Frequency Response

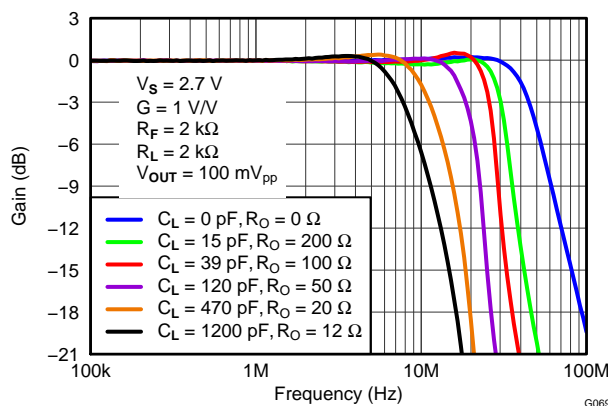

Figure 79. Frequency Response for Various R_O and C_L Values

Audio Performance

The THS4531 provides excellent audio performance with very low quiescent power. To show performance in the audio band, the device was tested with an audio analyzer. THD+N and FFT tests were run at 1V_{rms} output voltage. Performance is the same on both 2.7V and 5V supply. Figure 80 is the test circuit used, and Figure 81 and Figure 82 show performance of the analyzer. In the FFT plot the harmonic spurs are at the testing limit of the analyzer, which means the THS4531 is actually much better than can be directly measured. Because the THS4531 distortion performance cannot be directly measured in the audio band it is estimated from measurement in high noise gain configuration correlated with simulation.

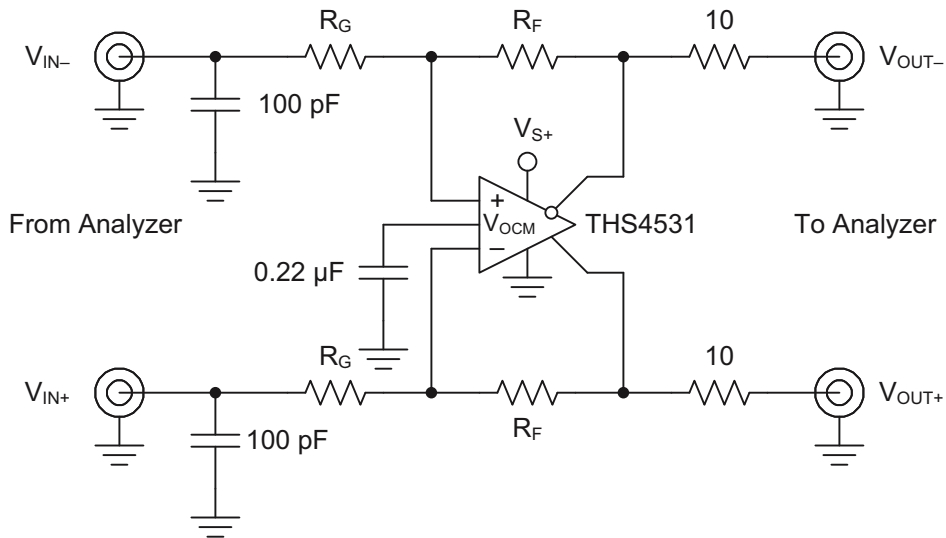

Figure 80. THS4531 Audio Analyzer Test Circuit

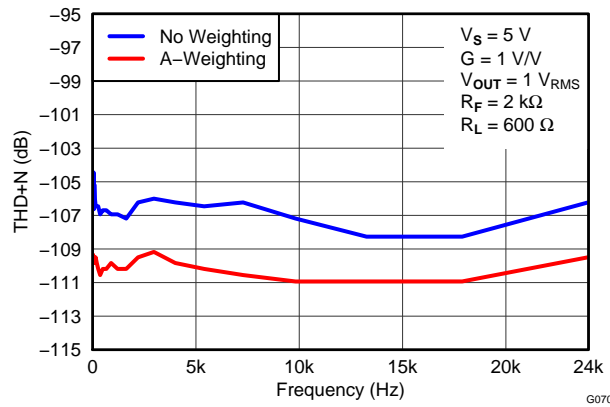

Figure 81. THD+N on Audio Analyzer, 10 Hz to 24 kHz

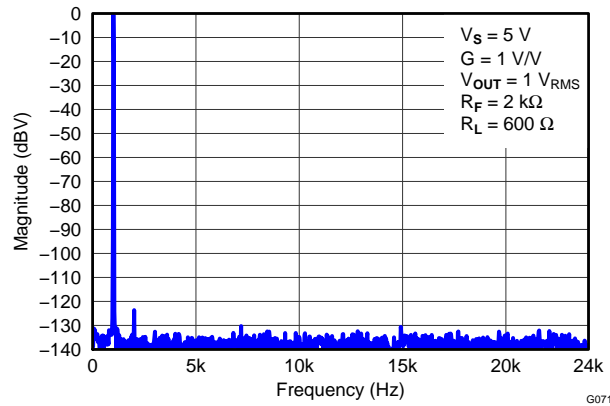

Figure 82. 1kHz FFT Plot on Audio Analyzer

Audio On/Off Pop Performance

The THS4531 is tested to show on and off pop performance by connecting a speaker between the differential outputs and switching on and off the power supply, and also by using the power down function of the THS4531. Testing was done with and without tones. During these tests no audible pop could be heard.

With no input tone, Figure 83 shows the voltage waveforms when switching power on to the THS4531 and Figure 84 shows voltage waveforms when turning power off. The transients during power on and off show no audible pop should be heard.

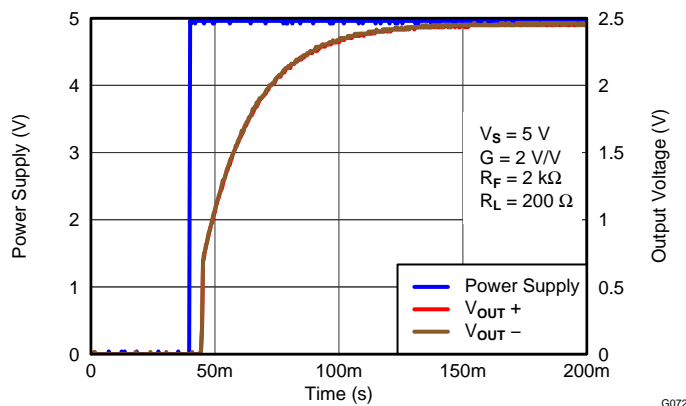

Figure 83. Power Supply Turn On Pop Performance

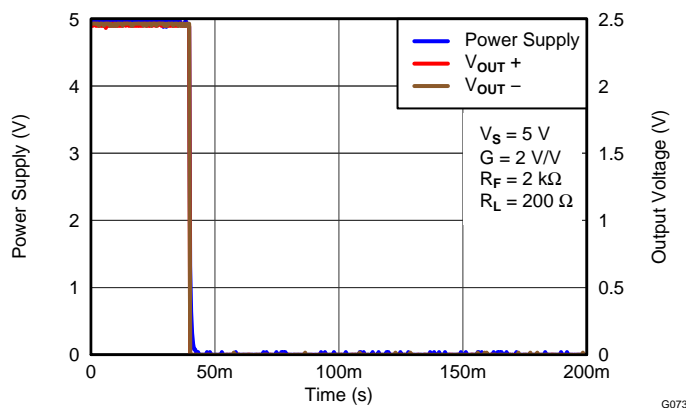

Figure 84. Power Supply Turn Off Pop Performance

With no input tone, Figure 85 shows the voltage waveforms using the $\overline{\text{PD}}$ pin to enable and disable the THS4531. The transients during power on and off show no audible pop should be heard.

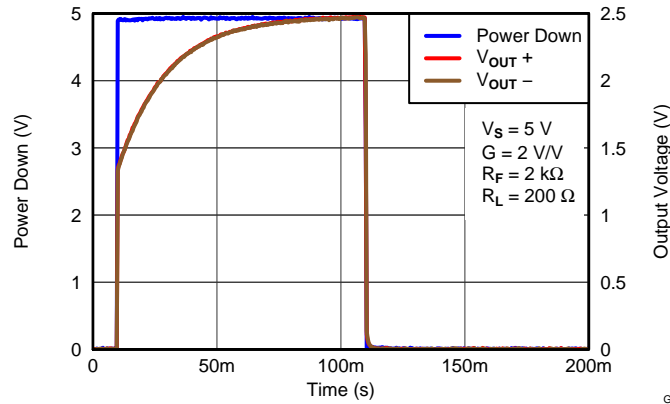

Figure 85. PD Enable Pop Performance

AUDIO ADC DRIVER PERFORMANCE: THS4531 AND PCM4204 COMBINED PERFORMANCE

To show achievable performance with a high performance audio ADC, the THS4531 is tested as the drive amplifier for the PCM4204. The PCM4204 is a high-performance, four-channel analog-to-digital (A/D) converter designed for professional and broadcast audio applications. The PCM4204 architecture utilizes a 1-bit delta-sigma modulator per channel incorporating an advanced dither scheme for improved dynamic performance, and supports PCM output data. The PCM4204 provides flexible serial port interface and many other advanced features. Please refer to its data sheet for more information.

The PCM4204 EVM is used to test the audio performance of the THS4531 as a drive amplifier. The standard PCM4204 EVM is provided with 4x OPA1632 fully differential amplifiers, which use the same pin out as the THS4531. For testing, one of these amplifiers is replaced with a THS4531 device in same package (MSOP), gain changed to 1V/V, and power supply changed to single supply +5V. Figure 86 shows the circuit. With single supply +5V supply the output common-mode of the THS4531 defaults to +2.5V as required at the input of the PCM4204. So the resistor connecting the V_{OCM} input of the THS4531 to the input common-mode drive from the PCM4204 is optional and no performance change was noted with it connected or removed. The EVM power connections were modified by connecting positive supply inputs, +15V, +5VA and +5VD, to a +5V external power supply (EXT +3.3 was not used) and connecting -15V and all ground inputs to ground on the external power supply so only one external +5V supply was needed to power all devices on the EVM.

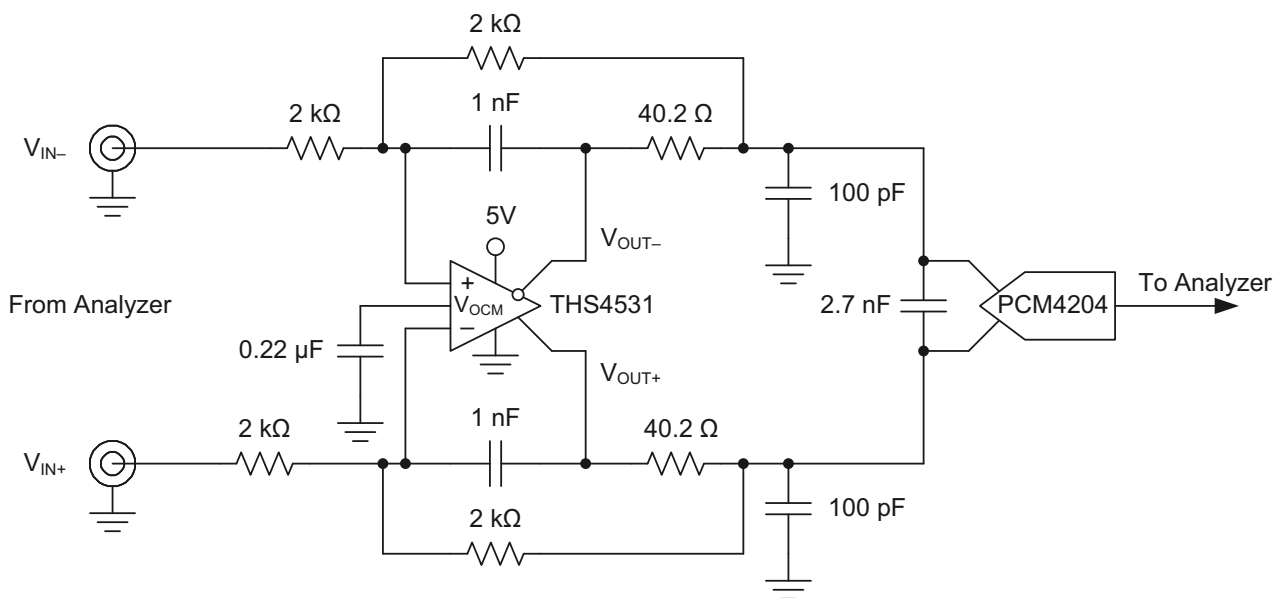

Figure 86. THS4531 and PCM4204 Test Circuit

An audio analyzer is used to provide an analog audio input to the EVM and the PCM formatted digital output is read by the digital input on the analyzer. Data was taken at $f_s = 96\text{kHz}$, and audio output uses PCM format. Other data rates and formats are expected to show similar performance in line with that shown in the data sheet.

Figure 87 shows the THD+N vs Frequency with no weighting and Figure 88 shows an FFT with 1kHz input tone. Input signal to the PCM4204 for these tests is -0.5dBFS . Table 4 summarizes results of testing using the THS4531 + PCM4204 versus typical Data Sheet performance, and show it make an excellent drive amplifier for this ADC.

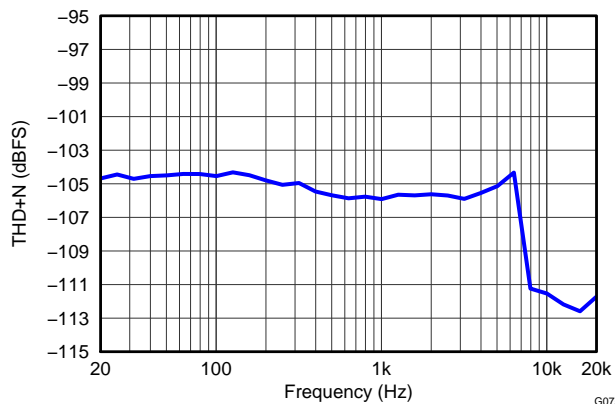

Figure 87. THS4531 + PCM4204 THD+N vs Frequency with No Weighting

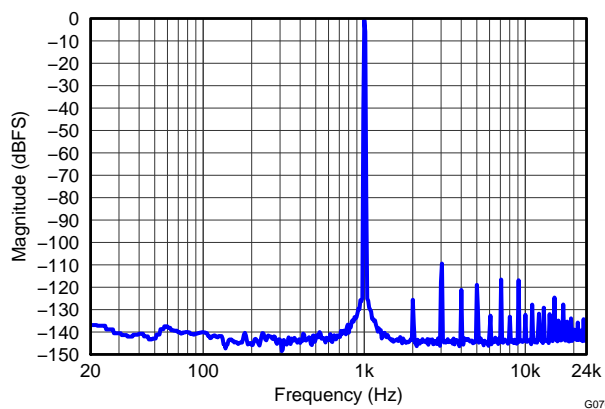

Figure 88. THS4531 + PCM4204 1kHz FFT

Table 4. 1kHz AC Analysis: Test Circuit versus PCM4204 Data Sheet Typical Specifications ($f_s = 96\text{kSPS}$)

CONFIGURATION	TONE	THD + N
THS4531 + PCM4204	1kHz	-106 dB
PCM4204 Data Sheet (typ)	1kHz	-103 dB

SAR ADC PERFORMANCE

THS4531 and ADS8321 Combined Performance

To show achievable performance with a high performance SAR ADC, the THS4531 is tested as the drive amplifier for the ADS8321. The ADS8321 is a 16-bit, SAR ADC that offers excellent AC and DC performance, with ultra-low power and small size. The circuit shown in Figure 89 is used to test the performance. Data was taken using the ADS8321 at 100kSPS with input frequency of 10 kHz and signal levels 0.5 dB below full scale. The FFT plot of the spectral performance is in Figure 90. A summary of the FFT analysis results are in Table 5 along with ADS8321 typical data sheet performance at $f_s = 100\text{kSPS}$. Please refer to its data sheet for more information.

The standard ADS8321 EVM and THS4531 EVM are modified to implement the schematic in Figure 89 and used to test the performance of the THS4531 as a drive amplifier. With single supply +5V supply the output common-mode of the THS4531 defaults to +2.5V as required at the input of the ADS8321 so the V_{OCM} input of the THS4531 simply bypassed to GND with 0.22 μ F capacitor. The summary of results of the FFT analysis versus typical data sheet performance shown in Table 5 show the THS4531 will make an excellent drive amplifier for this ADC.

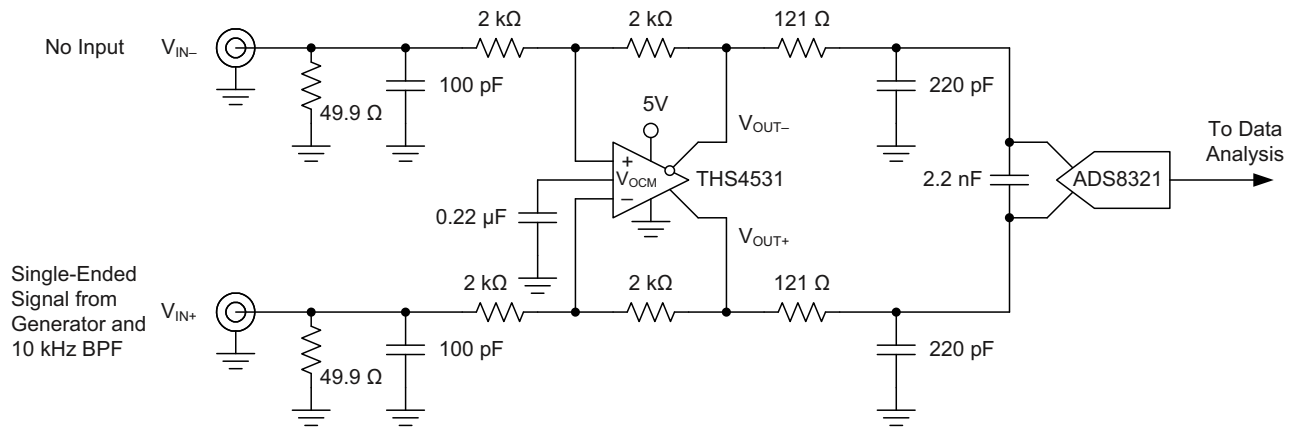

Figure 89. THS4531 and ADS8321 Test Circuit

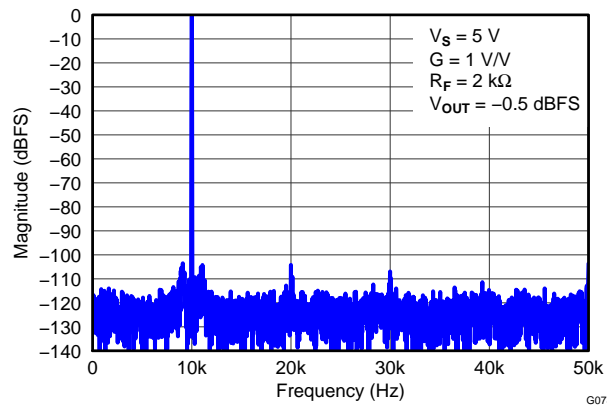

Figure 90. THS4531 + ADS8321 1kHz FFT

Table 5. 10kHz FFT Analysis Summary

CONFIGURATION	TONE	SIGNAL	SNR	THD	SINAD	SFDR
THS4531 + ADS8321	10kHz	-0.5 dBFS	87 dBc	-96 dBc	87 dBc	100 dBc
ADS8321 Data Sheet (typ)	10kHz	-0.5 dBFS	87 dBc	-86 dBc	84 dBc	86 dBc

THS4531 and ADS7945 Combined Performance

To show achievable performance with a high performance SAR ADC, the THS4531 is tested as the drive amplifier for the ADS7945. The ADS7945 is a 14-bit, SAR ADC that offers excellent AC and DC performance, with low power and small size. The circuit shown in Figure 91 is used to test the performance. Data was taken using the ADS7945 at 2MSPS with input frequency of 10 kHz and signal level 0.5 dB below full scale. The FFT plot of the spectral performance is in Figure 92. A summary of the FFT analysis results are in Table 6 along with ADS7945 typical data sheet performance at $f_s = 2$ MSPS. Please refer to its data sheet for more information.

The standard ADS7945 EVM and THS4531 EVM are modified to implement the schematic in Figure 91 and used to test the performance of the THS4531 as a drive amplifier. With single supply +5V supply the output common-mode of the THS4531 defaults to +2.5V as required at the input of the ADS7945 so the V_{OCM} input of the THS4531 simply bypassed to GND with 0.22 μ F capacitor. The summary of results of the FFT analysis versus typical data sheet performance shown in Table 6 show the THS4531 will make an excellent drive amplifier for this ADC.

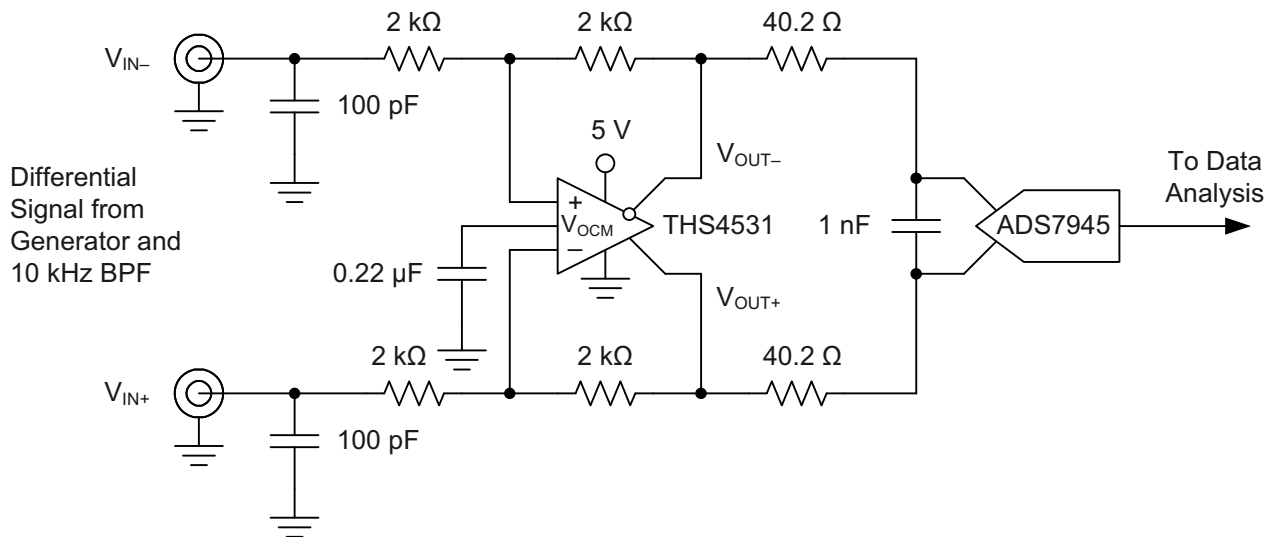

Figure 91. THS4531 and ADS7945 Test Circuit

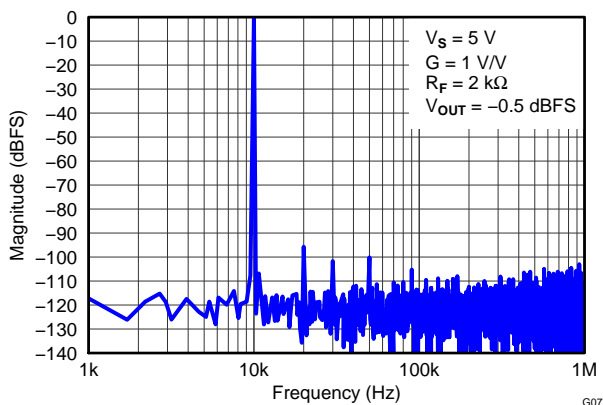

Figure 92. THS4531 and ADS7945 Test Circuit

Table 6. 10kHz FFT Analysis Summary

CONFIGURATION	TONE	SIGNAL	SNR	THD	SFDR
THS4531 + ADS7945	10kHz	-0.5 dBFS	83 dBc	-93 dBc	96 dBc
ADS7945 Data Sheet (typ)	10kHz	-0.5 dBFS	84 dBc	-92 dBc	94 dBc

EVM AND LAYOUT RECOMMENDATIONS

The THS4531 EVM ([SLOU334](#)) should be used as a reference when designing the circuit board. It is recommended to follow the EVM layout of the external components near to the amplifier, ground plane construction, and power routing as closely as possible. General guidelines are:

1. Signal routing should be direct and as short as possible into and out of the op amp.
2. The feedback path should be short and direct avoiding vias if possible.
3. Ground or power planes should be removed from directly under the amplifier's input and output pins.
4. A series output resistor is recommended to be placed as near to the output pin as possible. See [Figure 78](#) "Recommended Series Output Resistor vs. Capacitive Load" for recommended values given expected capacitive load of design.
5. A 2.2 μ F power supply decoupling capacitor should be placed within 2 inches of the device and can be shared with other op amps. For split supply, a capacitor is required for both supplies.
6. A 0.1 μ F power supply decoupling capacitor should be placed as near to the power supply pins as possible. Preferably within 0.1 inch. For split supply, a capacitor is required for both supplies.
7. The $\overline{\text{PD}}$ pin uses TTL logic levels referenced to the negative supply voltage (V_{S}). When not used it should be tied to the positive supply to enable the amplifier. When used, it must be actively driven high or low and should not be left in an indeterminate logic state. A bypass capacitor is not required, but can be used for robustness in noisy environments.

REVISION HISTORY

NOTE: Page numbers for previous revisions may differ from page numbers in the current version.

Changes from Revision A (January 2012) to Revision B	Page
• Deleted DC Performance, <i>Input-referred offset voltage</i> parameter typical specifications for $T_A = 0^\circ\text{C}$ to $+70^\circ\text{C}$, -40°C to $+85^\circ\text{C}$, and -40°C to $+125^\circ\text{C}$ in 2.7 V Electrical Characteristics table	4
• Changed DC Performance, <i>Input-referred offset voltage</i> parameter maximum specifications for $T_A = 0^\circ\text{C}$ to $+70^\circ\text{C}$, -40°C to $+85^\circ\text{C}$, and -40°C to $+125^\circ\text{C}$ in 2.7 V Electrical Characteristics table	4
• Changed DC Performance, <i>Input offset voltage drift</i> parameter typical and maximum specifications in 2.7 V Electrical Characteristics table	4
• Deleted DC Performance, <i>Input bias current</i> parameter typical specifications for $T_A = 0^\circ\text{C}$ to $+70^\circ\text{C}$, -40°C to $+85^\circ\text{C}$, and -40°C to $+125^\circ\text{C}$ in 2.7 V Electrical Characteristics table	4
• Deleted DC Performance, <i>Input bias current drift</i> parameter typical specifications in 2.7 V Electrical Characteristics table	4
• Deleted DC Performance, <i>Input offset current</i> parameter typical specifications for $T_A = 0^\circ\text{C}$ to $+70^\circ\text{C}$, -40°C to $+85^\circ\text{C}$, and -40°C to $+125^\circ\text{C}$ in 2.7 V Electrical Characteristics table	4
• Deleted DC Performance, <i>Input-referred offset voltage</i> parameter typical specifications for $T_A = 0^\circ\text{C}$ to $+70^\circ\text{C}$, -40°C to $+85^\circ\text{C}$, and -40°C to $+125^\circ\text{C}$ in 5 V Electrical Characteristics table	7
• Changed DC Performance, <i>Input-referred offset voltage</i> parameter maximum specifications for $T_A = 0^\circ\text{C}$ to $+70^\circ\text{C}$, -40°C to $+85^\circ\text{C}$, and -40°C to $+125^\circ\text{C}$ in 5 V Electrical Characteristics table	7
• Changed DC Performance, <i>Input offset voltage drift</i> parameter typical specifications in 5 V Electrical Characteristics table	7
• Deleted DC Performance, <i>Input bias current</i> parameter typical specifications for $T_A = 0^\circ\text{C}$ to $+70^\circ\text{C}$, -40°C to $+85^\circ\text{C}$, and -40°C to $+125^\circ\text{C}$ in 5 V Electrical Characteristics table	7
• Deleted DC Performance, <i>Input offset current</i> parameter typical specifications for $T_A = 0^\circ\text{C}$ to $+70^\circ\text{C}$, -40°C to $+85^\circ\text{C}$, and -40°C to $+125^\circ\text{C}$ in 5 V Electrical Characteristics table	7

Changes from Original (SEPTEMBER 2011) to Revision A	Page
• Changed 从产品预览到生产数据	1

PACKAGING INFORMATION

Orderable part number	Status (1)	Material type (2)	Package Pins	Package qty Carrier	RoHS (3)	Lead finish/ Ball material (4)	MSL rating/ Peak reflow (5)	Op temp (°C)	Part marking (6)
THS4531ID	Active	Production	SOIC (D) 8	75 TUBE	Yes	NIPDAU	Level-2-260C-1 YEAR	-40 to 125	T4531
THS4531ID.B	Active	Production	SOIC (D) 8	75 TUBE	Yes	NIPDAU	Level-2-260C-1 YEAR	-40 to 125	T4531
THS4531IDGK	Active	Production	VSSOP (DGK) 8	80 TUBE	Yes	NIPDAUAG	Level-2-260C-1 YEAR	-40 to 125	4531
THS4531IDGK.B	Active	Production	VSSOP (DGK) 8	80 TUBE	Yes	NIPDAUAG	Level-2-260C-1 YEAR	-40 to 125	4531
THS4531IDGKR	Active	Production	VSSOP (DGK) 8	2500 LARGE T&R	Yes	NIPDAU SN NIPDAUAG	Level-2-260C-1 YEAR	-40 to 125	4531
THS4531IDGKR.B	Active	Production	VSSOP (DGK) 8	2500 LARGE T&R	Yes	NIPDAU	Level-2-260C-1 YEAR	-40 to 125	4531
THS4531IDR	Active	Production	SOIC (D) 8	2500 LARGE T&R	Yes	NIPDAU	Level-2-260C-1 YEAR	-40 to 125	T4531
THS4531IDR.B	Active	Production	SOIC (D) 8	2500 LARGE T&R	Yes	NIPDAU	Level-2-260C-1 YEAR	-40 to 125	T4531
THS4531IDRG4	Active	Production	SOIC (D) 8	2500 LARGE T&R	Yes	NIPDAU	Level-2-260C-1 YEAR	-40 to 125	T4531
THS4531IDRG4.B	Active	Production	SOIC (D) 8	2500 LARGE T&R	Yes	NIPDAU	Level-2-260C-1 YEAR	-40 to 125	T4531
THS4531IRUNR	Active	Production	QFN (RUN) 10	3000 LARGE T&R	Yes	NIPDAU	Level-2-260C-1 YEAR	-40 to 125	4531
THS4531IRUNR.B	Active	Production	QFN (RUN) 10	3000 LARGE T&R	Yes	NIPDAU	Level-2-260C-1 YEAR	-40 to 125	4531
THS4531IRUNRG4	Active	Production	QFN (RUN) 10	3000 LARGE T&R	Yes	NIPDAU	Level-2-260C-1 YEAR	-40 to 125	4531
THS4531IRUNRG4.B	Active	Production	QFN (RUN) 10	3000 LARGE T&R	Yes	NIPDAU	Level-2-260C-1 YEAR	-40 to 125	4531
THS4531IRUNT	Active	Production	QFN (RUN) 10	250 SMALL T&R	Yes	NIPDAU	Level-2-260C-1 YEAR	-40 to 125	4531
THS4531IRUNT.B	Active	Production	QFN (RUN) 10	250 SMALL T&R	Yes	NIPDAU	Level-2-260C-1 YEAR	-40 to 125	4531
THS4532IPW	Active	Production	TSSOP (PW) 16	90 TUBE	Yes	NIPDAU	Level-2-260C-1 YEAR	-40 to 125	THS4532
THS4532IPWR	Active	Production	TSSOP (PW) 16	2000 LARGE T&R	Yes	NIPDAU	Level-2-260C-1 YEAR	-40 to 125	THS4532

(1) **Status:** For more details on status, see our [product life cycle](#).

(2) **Material type:** When designated, preproduction parts are prototypes/experimental devices, and are not yet approved or released for full production. Testing and final process, including without limitation quality assurance, reliability performance testing, and/or process qualification, may not yet be complete, and this item is subject to further changes or possible discontinuation. If available for ordering, purchases will be subject to an additional waiver at checkout, and are intended for early internal evaluation purposes only. These items are sold without warranties of any kind.

(3) **RoHS values:** Yes, No, RoHS Exempt. See the [TI RoHS Statement](#) for additional information and value definition.

(4) **Lead finish/Ball material:** Parts may have multiple material finish options. Finish options are separated by a vertical ruled line. Lead finish/Ball material values may wrap to two lines if the finish value exceeds the maximum column width.

(5) **MSL rating/Peak reflow:** The moisture sensitivity level ratings and peak solder (reflow) temperatures. In the event that a part has multiple moisture sensitivity ratings, only the lowest level per JEDEC standards is shown. Refer to the shipping label for the actual reflow temperature that will be used to mount the part to the printed circuit board.

(6) **Part marking:** There may be an additional marking, which relates to the logo, the lot trace code information, or the environmental category of the part.

Multiple part markings will be inside parentheses. Only one part marking contained in parentheses and separated by a "~" will appear on a part. If a line is indented then it is a continuation of the previous line and the two combined represent the entire part marking for that device.

Important Information and Disclaimer:The information provided on this page represents TI's knowledge and belief as of the date that it is provided. TI bases its knowledge and belief on information provided by third parties, and makes no representation or warranty as to the accuracy of such information. Efforts are underway to better integrate information from third parties. TI has taken and continues to take reasonable steps to provide representative and accurate information but may not have conducted destructive testing or chemical analysis on incoming materials and chemicals. TI and TI suppliers consider certain information to be proprietary, and thus CAS numbers and other limited information may not be available for release.

In no event shall TI's liability arising out of such information exceed the total purchase price of the TI part(s) at issue in this document sold by TI to Customer on an annual basis.

TAPE AND REEL INFORMATION

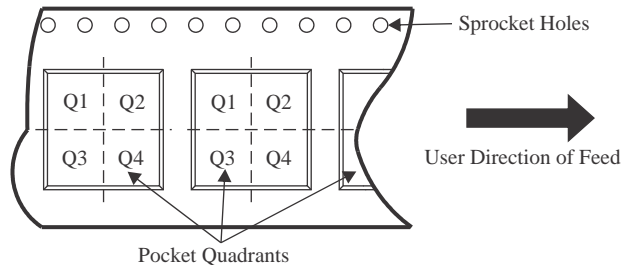
QUADRANT ASSIGNMENTS FOR PIN 1 ORIENTATION IN TAPE

*All dimensions are nominal

Device	Package Type	Package Drawing	Pins	SPQ	Reel Diameter (mm)	Reel Width W1 (mm)	A0 (mm)	B0 (mm)	K0 (mm)	P1 (mm)	W (mm)	Pin1 Quadrant
THS4531IDGKR	VSSOP	DGK	8	2500	330.0	12.4	5.25	3.35	1.25	8.0	12.0	Q1
THS4531IDR	SOIC	D	8	2500	330.0	12.4	6.4	5.2	2.1	8.0	12.0	Q1
THS4531IDRG4	SOIC	D	8	2500	330.0	12.4	6.4	5.2	2.1	8.0	12.0	Q1
THS4531IRUNR	QFN	RUN	10	3000	180.0	8.4	2.3	2.3	1.15	4.0	8.0	Q2
THS4531IRUNRG4	QFN	RUN	10	3000	180.0	8.4	2.3	2.3	1.15	4.0	8.0	Q2
THS4531IRUNT	QFN	RUN	10	250	180.0	8.4	2.3	2.3	1.15	4.0	8.0	Q2
THS4532IPWR	TSSOP	PW	16	2000	330.0	12.4	6.9	5.6	1.6	8.0	12.0	Q1

TAPE AND REEL BOX DIMENSIONS

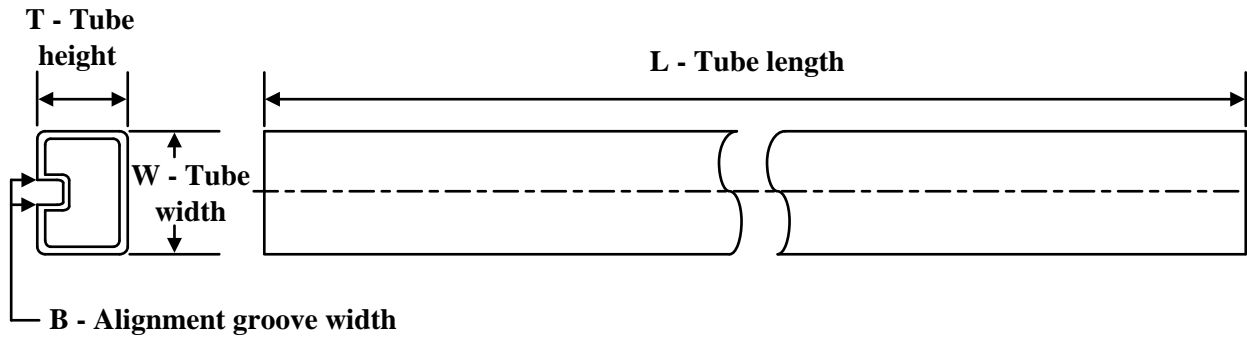

*All dimensions are nominal

Device	Package Type	Package Drawing	Pins	SPQ	Length (mm)	Width (mm)	Height (mm)
THS4531IDGKR	VSSOP	DGK	8	2500	366.0	364.0	50.0
THS4531IDR	SOIC	D	8	2500	353.0	353.0	32.0
THS4531IDRG4	SOIC	D	8	2500	353.0	353.0	32.0
THS4531IRUNR	QFN	RUN	10	3000	213.0	191.0	35.0
THS4531IRUNRG4	QFN	RUN	10	3000	213.0	191.0	35.0
THS4531IRUNT	QFN	RUN	10	250	213.0	191.0	35.0
THS4532IPWR	TSSOP	PW	16	2000	353.0	353.0	32.0

TUBE

*All dimensions are nominal

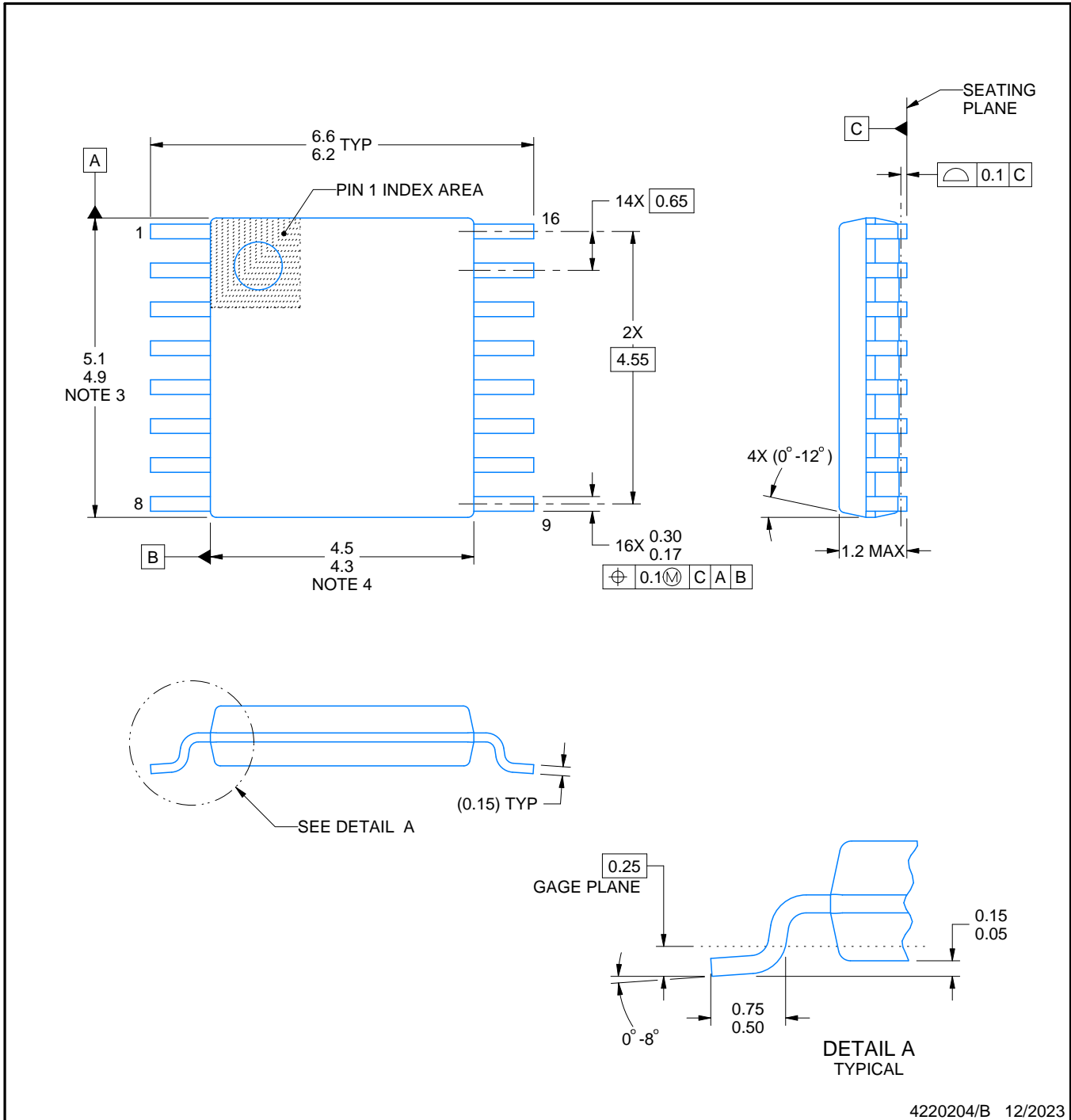
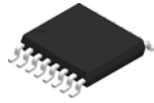
Device	Package Name	Package Type	Pins	SPQ	L (mm)	W (mm)	T (μm)	B (mm)
THS4531ID	D	SOIC	8	75	507	8	3940	4.32
THS4531ID.B	D	SOIC	8	75	507	8	3940	4.32
THS4531IDGK	DGK	VSSOP	8	80	330	6.55	500	2.88
THS4531IDGK.B	DGK	VSSOP	8	80	330	6.55	500	2.88
THS4532IPW	PW	TSSOP	16	90	530	10.2	3600	3.5



4220204/B 12/2023

NOTES:

1. All linear dimensions are in millimeters. Any dimensions in parenthesis are for reference only. Dimensioning and tolerancing per ASME Y14.5M.
2. This drawing is subject to change without notice.
3. This dimension does not include mold flash, protrusions, or gate burrs. Mold flash, protrusions, or gate burrs shall not exceed 0.15 mm per side.
4. This dimension does not include interlead flash. Interlead flash shall not exceed 0.25 mm per side.
5. Reference JEDEC registration MO-153.

EXAMPLE BOARD LAYOUT

PW0016A

TSSOP - 1.2 mm max height

SMALL OUTLINE PACKAGE

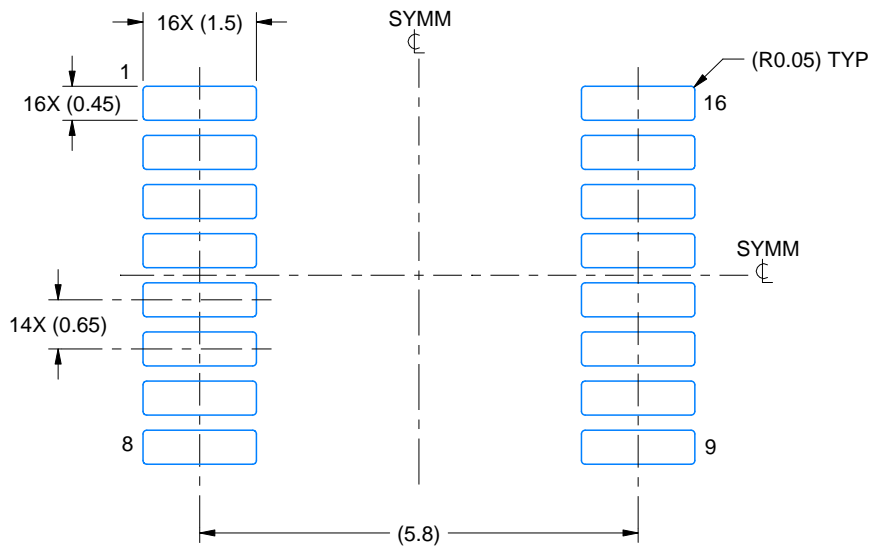

LAND PATTERN EXAMPLE
EXPOSED METAL SHOWN
SCALE: 10X

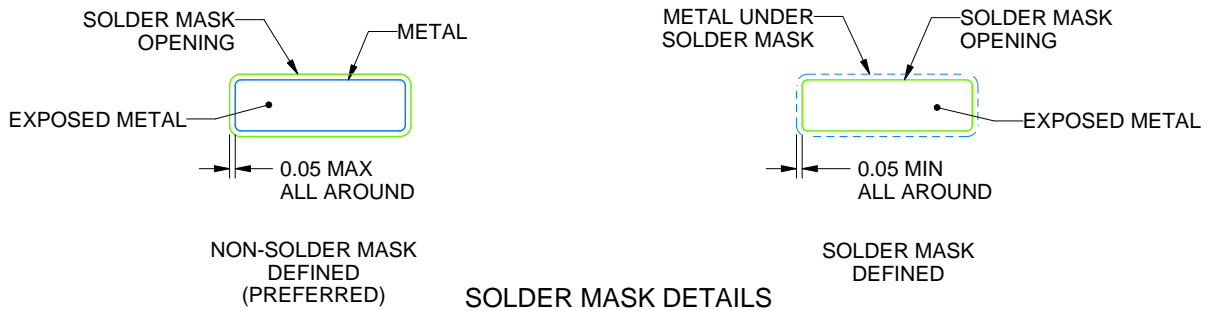

SOLDER MASK DETAILS

4220204/B 12/2023

NOTES: (continued)

- 6. Publication IPC-7351 may have alternate designs.
- 7. Solder mask tolerances between and around signal pads can vary based on board fabrication site.

EXAMPLE STENCIL DESIGN

PW0016A

TSSOP - 1.2 mm max height

SMALL OUTLINE PACKAGE

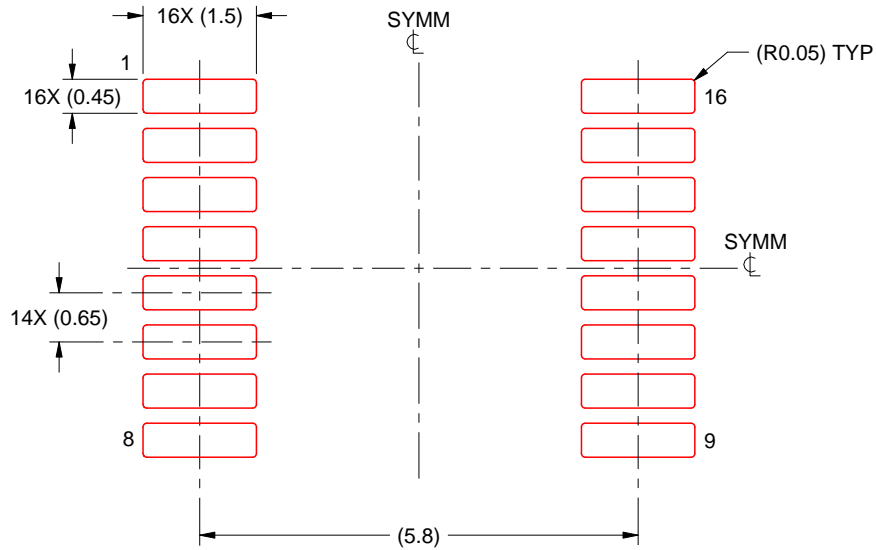

SOLDER PASTE EXAMPLE
BASED ON 0.125 mm THICK STENCIL
SCALE: 10X

4220204/B 12/2023

NOTES: (continued)

8. Laser cutting apertures with trapezoidal walls and rounded corners may offer better paste release. IPC-7525 may have alternate design recommendations.
9. Board assembly site may have different recommendations for stencil design.

GENERIC PACKAGE VIEW

RUN 10

WQFN - 0.8 mm max height

2 X 2, 0.5 mm pitch

PLASTIC QUAD FLATPACK - NO LEAD

This image is a representation of the package family, actual package may vary.
Refer to the product data sheet for package details.

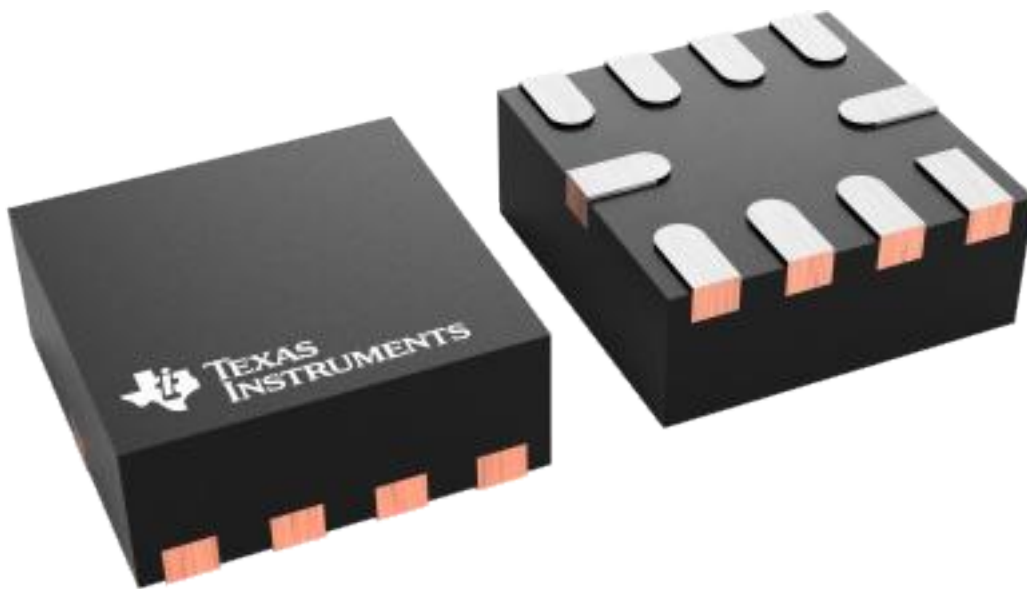

4228249/A

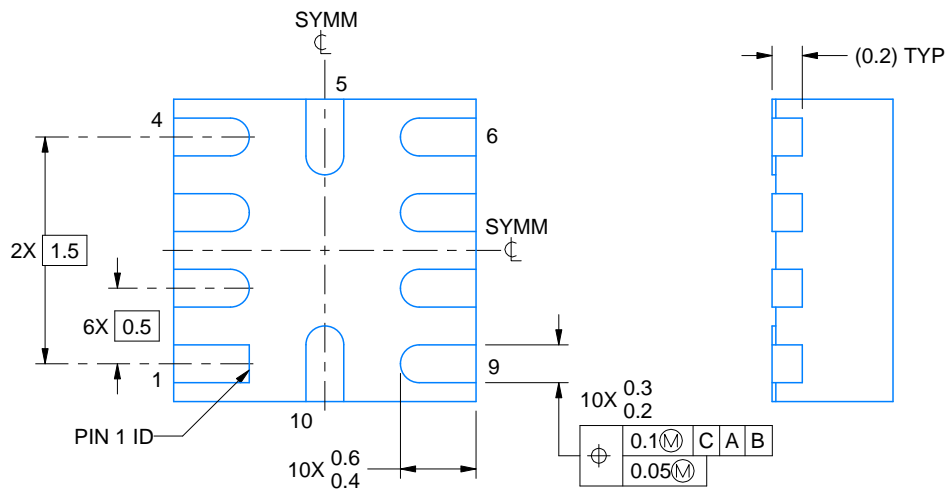
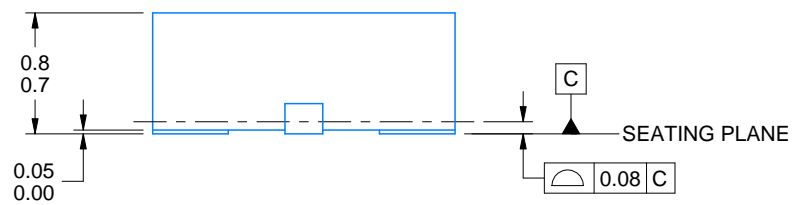
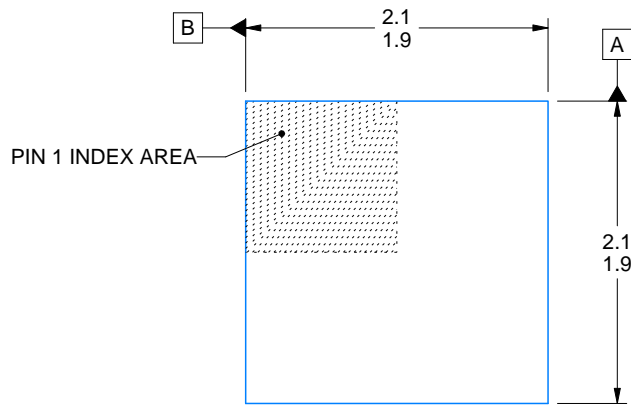
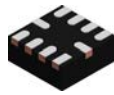

4220470/A 05/2020

NOTES:

1. All linear dimensions are in millimeters. Any dimensions in parenthesis are for reference only. Dimensioning and tolerancing per ASME Y14.5M.
2. This drawing is subject to change without notice.

EXAMPLE BOARD LAYOUT

RUN0010A

WQFN - 0.8 mm max height

PLASTIC QUAD FLATPACK - NO LEAD

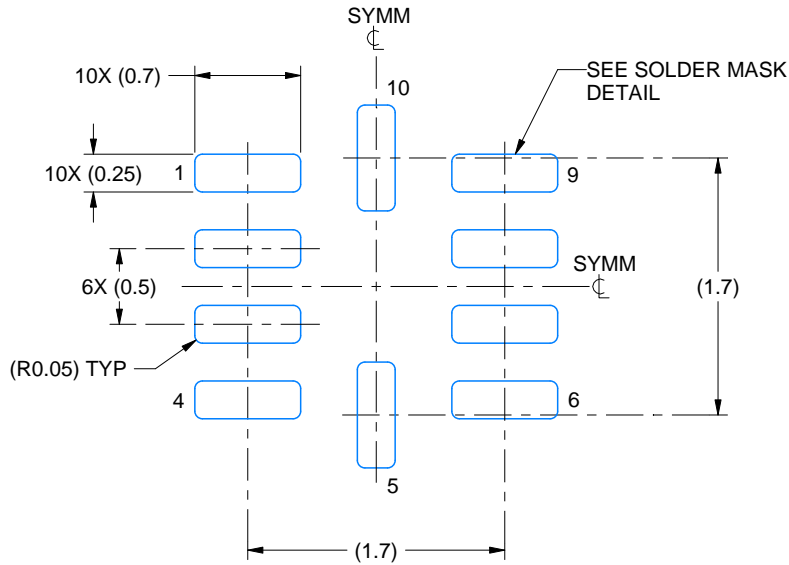

LAND PATTERN EXAMPLE
EXPOSED METAL SHOWN
SCALE: 20X

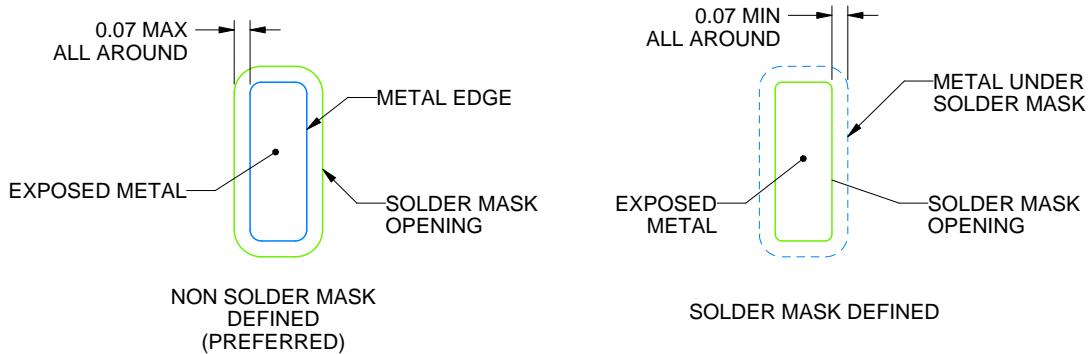

SOLDER MASK DETAILS

4220470/A 05/2020

NOTES: (continued)

3. This package is designed to be soldered to a thermal pad on the board. For more information, see Texas Instruments literature number SLUA271 (www.ti.com/lit/slua271).

EXAMPLE STENCIL DESIGN

RUN0010A

WQFN - 0.8 mm max height

PLASTIC QUAD FLATPACK - NO LEAD

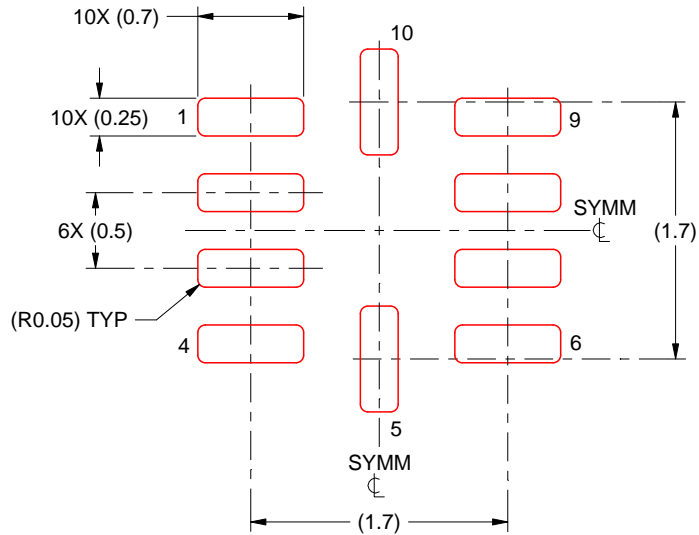

SOLDER PASTE EXAMPLE
BASED ON 0.125 MM THICK STENCIL
SCALE: 20X

4220470/A 05/2020

NOTES: (continued)

4. Laser cutting apertures with trapezoidal walls and rounded corners may offer better paste release. IPC-7525 may have alternate design recommendations.



D0008A

PACKAGE OUTLINE

SOIC - 1.75 mm max height

SMALL OUTLINE INTEGRATED CIRCUIT



4214825/C 02/2019

NOTES:

1. Linear dimensions are in inches [millimeters]. Dimensions in parenthesis are for reference only. Controlling dimensions are in inches. Dimensioning and tolerancing per ASME Y14.5M.
2. This drawing is subject to change without notice.
3. This dimension does not include mold flash, protrusions, or gate burrs. Mold flash, protrusions, or gate burrs shall not exceed $.006$ [0.15] per side.
4. This dimension does not include interlead flash.
5. Reference JEDEC registration MS-012, variation AA.

EXAMPLE BOARD LAYOUT

D0008A

SOIC - 1.75 mm max height

SMALL OUTLINE INTEGRATED CIRCUIT



LAND PATTERN EXAMPLE
EXPOSED METAL SHOWN
SCALE:8X



SOLDER MASK DETAILS

4214825/C 02/2019

NOTES: (continued)

- 6. Publication IPC-7351 may have alternate designs.
- 7. Solder mask tolerances between and around signal pads can vary based on board fabrication site.

EXAMPLE STENCIL DESIGN

D0008A

SOIC - 1.75 mm max height

SMALL OUTLINE INTEGRATED CIRCUIT



SOLDER PASTE EXAMPLE
BASED ON .005 INCH [0.125 MM] THICK STENCIL
SCALE:8X

4214825/C 02/2019

NOTES: (continued)

8. Laser cutting apertures with trapezoidal walls and rounded corners may offer better paste release. IPC-7525 may have alternate design recommendations.
9. Board assembly site may have different recommendations for stencil design.

DGK0008A

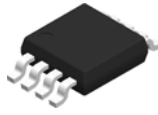

PACKAGE OUTLINE

VSSOP - 1.1 mm max height

SMALL OUTLINE PACKAGE

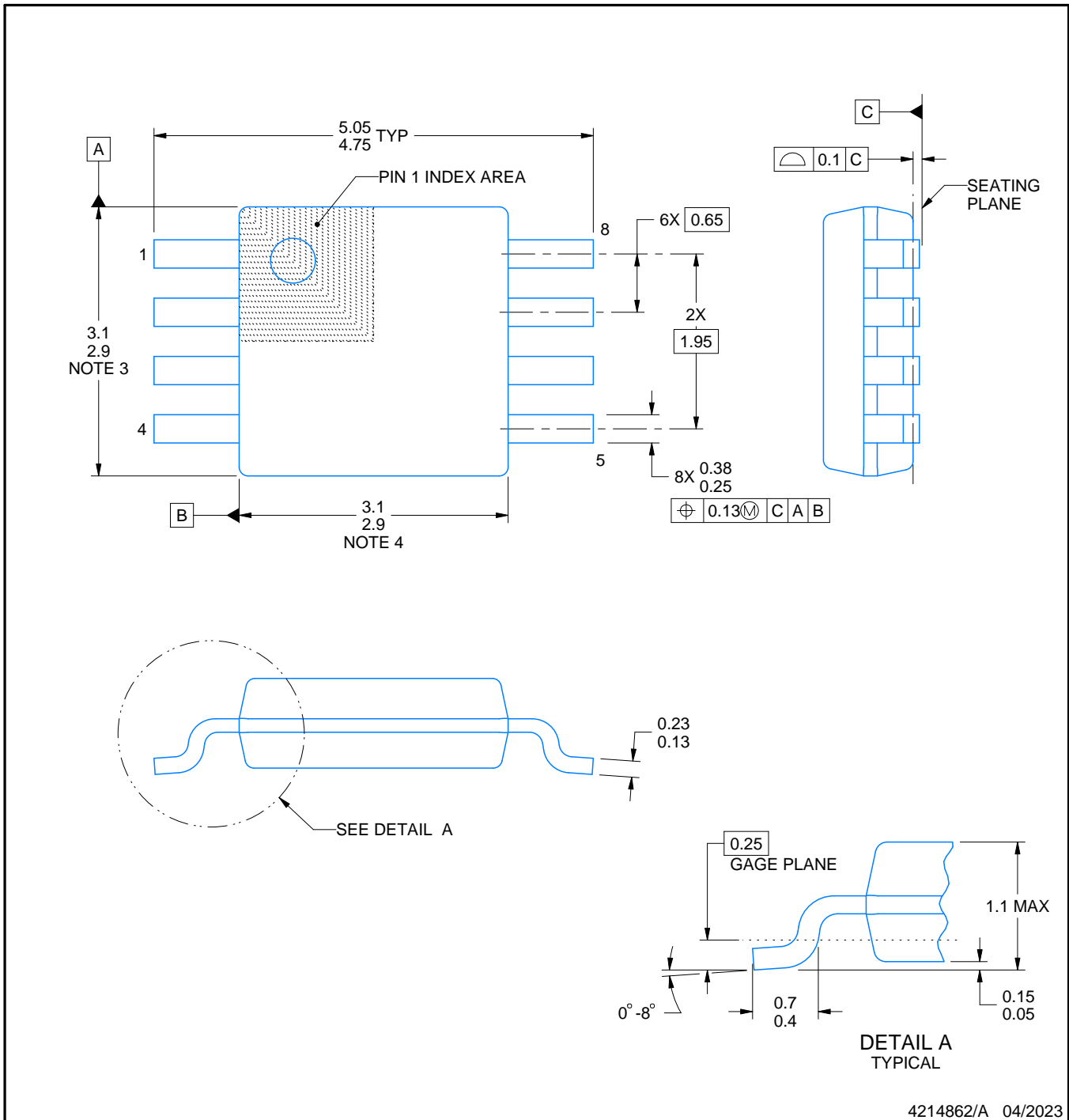

4214862/A 04/2023

NOTES:

PowerPAD is a trademark of Texas Instruments.

1. All linear dimensions are in millimeters. Any dimensions in parenthesis are for reference only. Dimensioning and tolerancing per ASME Y14.5M.
2. This drawing is subject to change without notice.
3. This dimension does not include mold flash, protrusions, or gate burrs. Mold flash, protrusions, or gate burrs shall not exceed 0.15 mm per side.
4. This dimension does not include interlead flash. Interlead flash shall not exceed 0.25 mm per side.
5. Reference JEDEC registration MO-187.

EXAMPLE BOARD LAYOUT

DGK0008A

™ VSSOP - 1.1 mm max height

SMALL OUTLINE PACKAGE

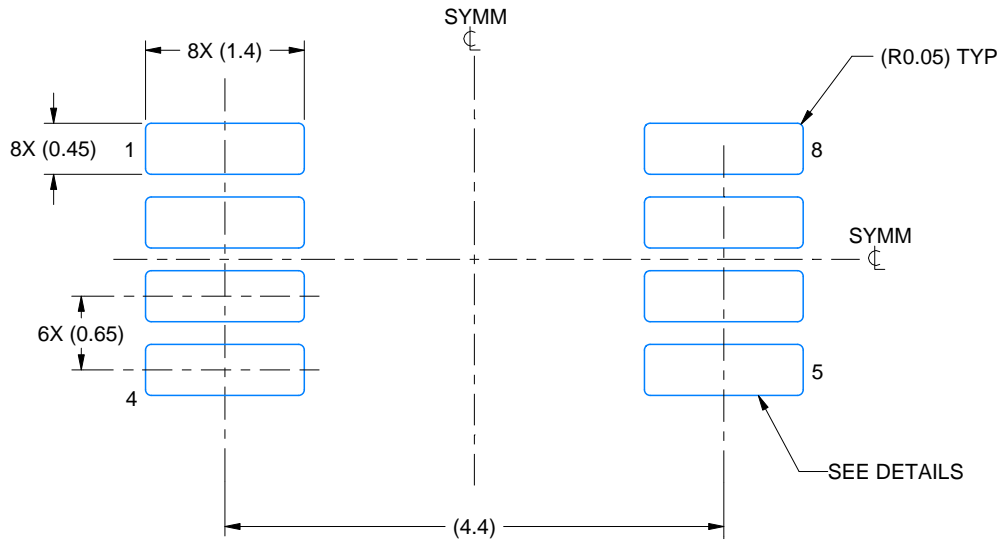

LAND PATTERN EXAMPLE
EXPOSED METAL SHOWN
SCALE: 15X

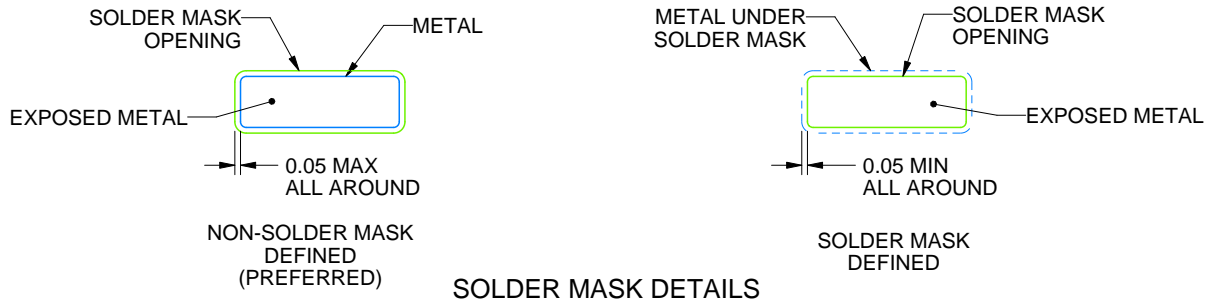

4214862/A 04/2023

NOTES: (continued)

6. Publication IPC-7351 may have alternate designs.
7. Solder mask tolerances between and around signal pads can vary based on board fabrication site.
8. Vias are optional depending on application, refer to device data sheet. If any vias are implemented, refer to their locations shown on this view. It is recommended that vias under paste be filled, plugged or tented.
9. Size of metal pad may vary due to creepage requirement.

EXAMPLE STENCIL DESIGN

DGK0008A

™ VSSOP - 1.1 mm max height

SMALL OUTLINE PACKAGE

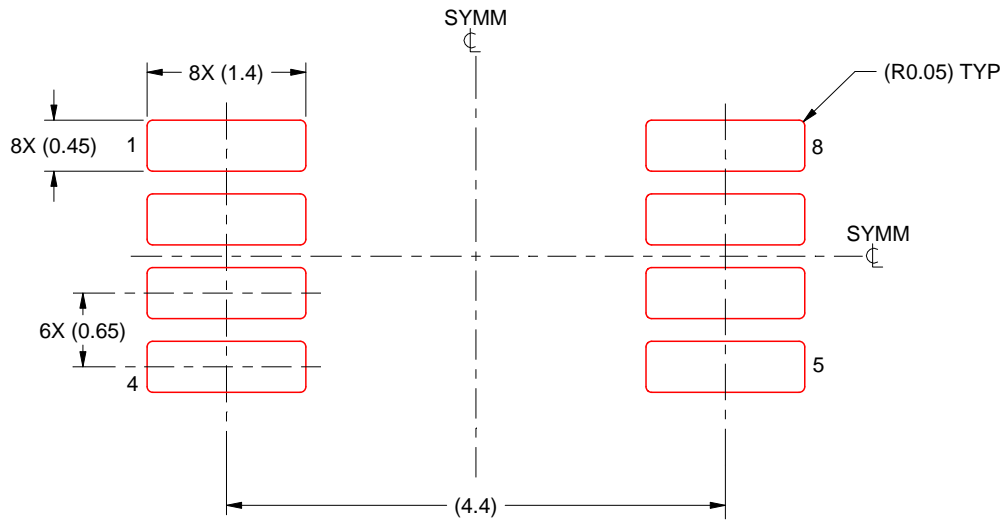

SOLDER PASTE EXAMPLE
SCALE: 15X

4214862/A 04/2023

NOTES: (continued)

11. Laser cutting apertures with trapezoidal walls and rounded corners may offer better paste release. IPC-7525 may have alternate design recommendations.
12. Board assembly site may have different recommendations for stencil design.

重要通知和免责声明

TI“按原样”提供技术和可靠性数据（包括数据表）、设计资源（包括参考设计）、应用或其他设计建议、网络工具、安全信息和其他资源，不保证没有瑕疵且不做任何明示或暗示的担保，包括但不限于对适销性、与某特定用途的适用性或不侵犯任何第三方知识产权的暗示担保。

这些资源可供使用 TI 产品进行设计的熟练开发人员使用。您将自行承担以下全部责任：(1) 针对您的应用选择合适的 TI 产品，(2) 设计、验证并测试您的应用，(3) 确保您的应用满足相应标准以及任何其他安全、安保法规或其他要求。

这些资源如有变更，恕不另行通知。TI 授权您仅可将这些资源用于研发本资源所述的 TI 产品的相关应用。严禁以其他方式对这些资源进行复制或展示。您无权使用任何其他 TI 知识产权或任何第三方知识产权。对于因您对这些资源的使用而对 TI 及其代表造成的任何索赔、损害、成本、损失和债务，您将全额赔偿，TI 对此概不负责。

TI 提供的产品受 [TI 销售条款](#)、[TI 通用质量指南](#) 或 [ti.com](#) 上其他适用条款或 TI 产品随附的其他适用条款的约束。TI 提供这些资源并不会扩展或以其他方式更改 TI 针对 TI 产品发布的适用的担保或担保免责声明。除非德州仪器 (TI) 明确将某产品指定为定制产品或客户特定产品，否则其产品均为按确定价格收入目录的标准通用器件。

TI 反对并拒绝您可能提出的任何其他或不同的条款。

版权所有 © 2026，德州仪器 (TI) 公司

最后更新日期：2025 年 10 月