

Brushless-DC Motor 4: Commutation – Trapezoidal Control

TI Precision Labs – Motor Drivers

Presented and prepared by Mostafa Shubbar

BLDC fundamentals

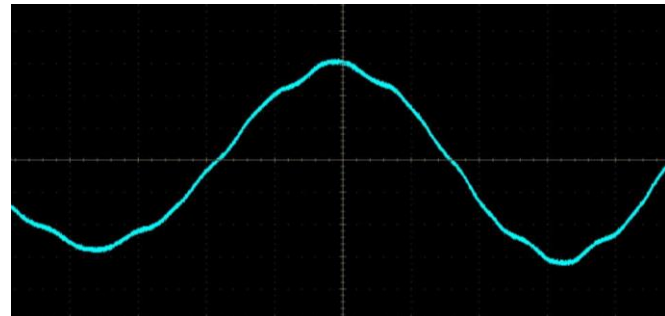
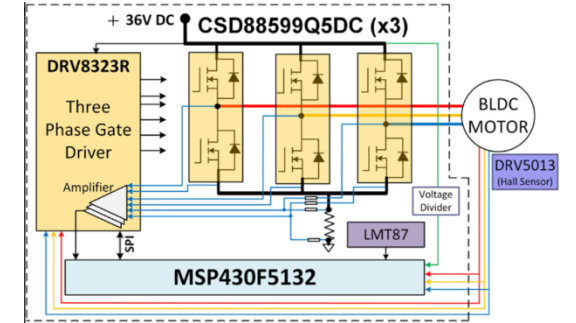
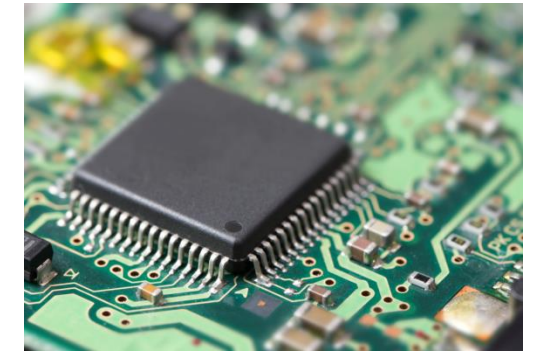
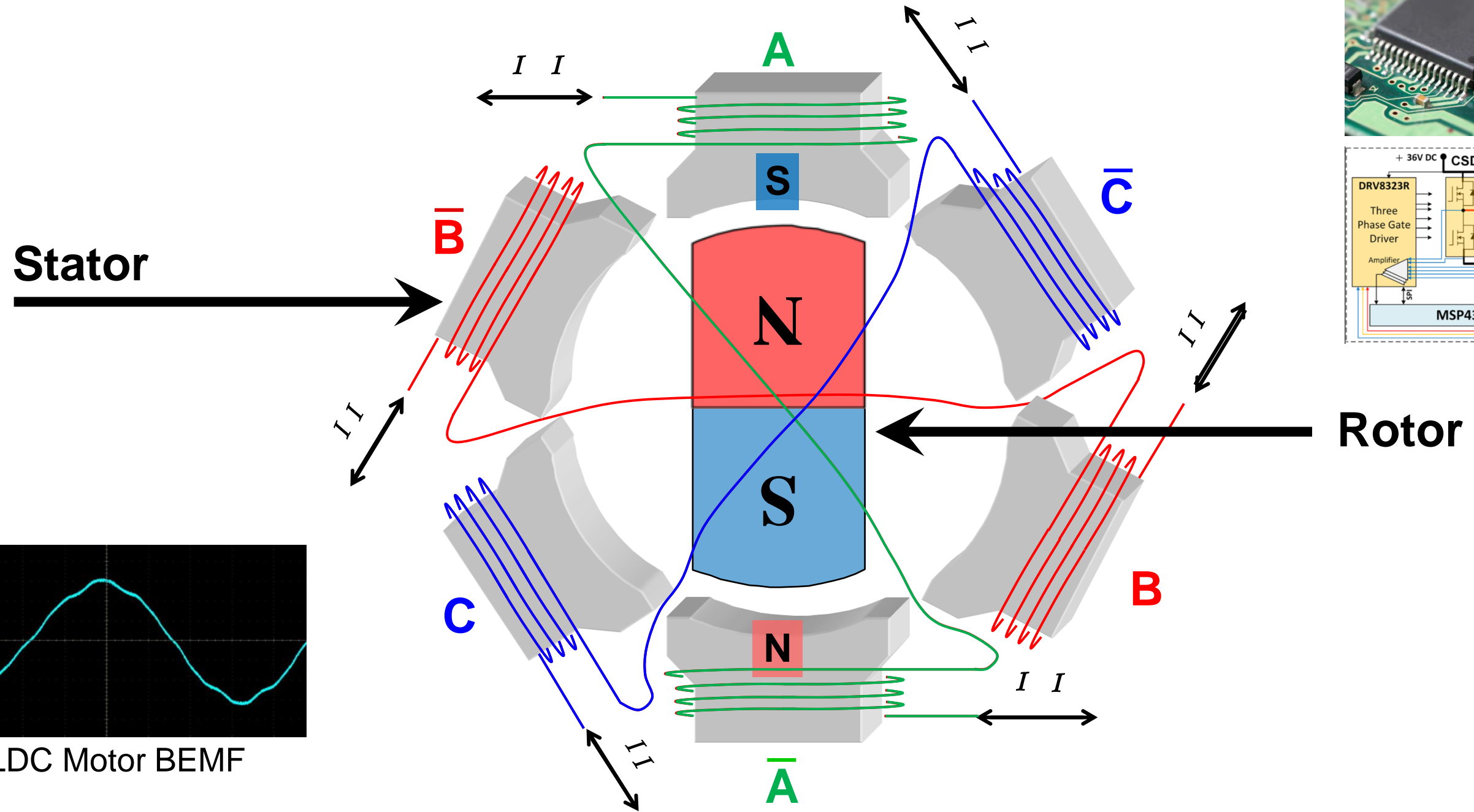

BLDC Motor BEMF

Basics of trapezoidal commutation

- + Low Cost
- + Simple to implement
- + Less processing power
- + High speed applications
- Electric and acoustic noise
- Torque ripple



Basics of trapezoidal commutation

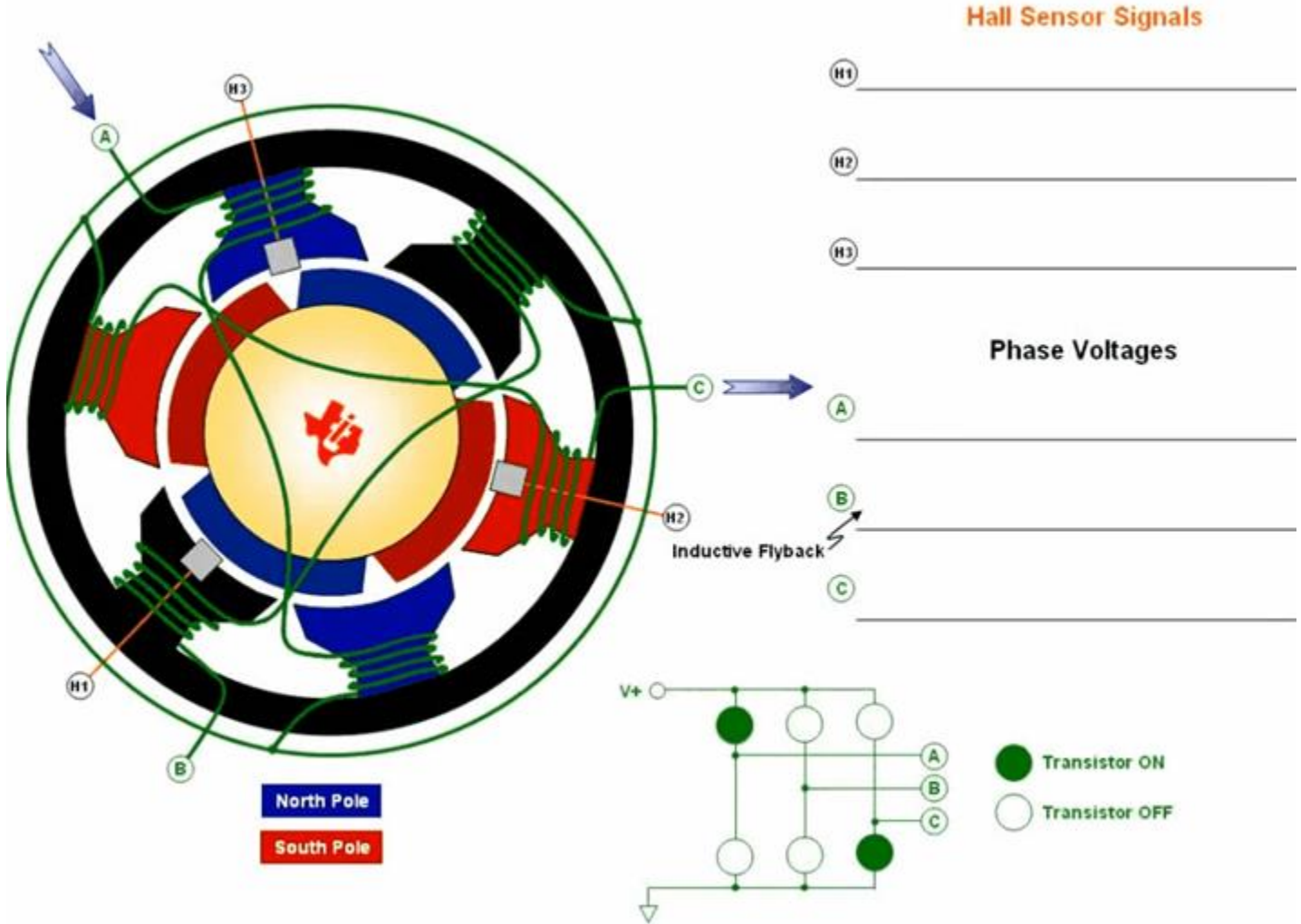
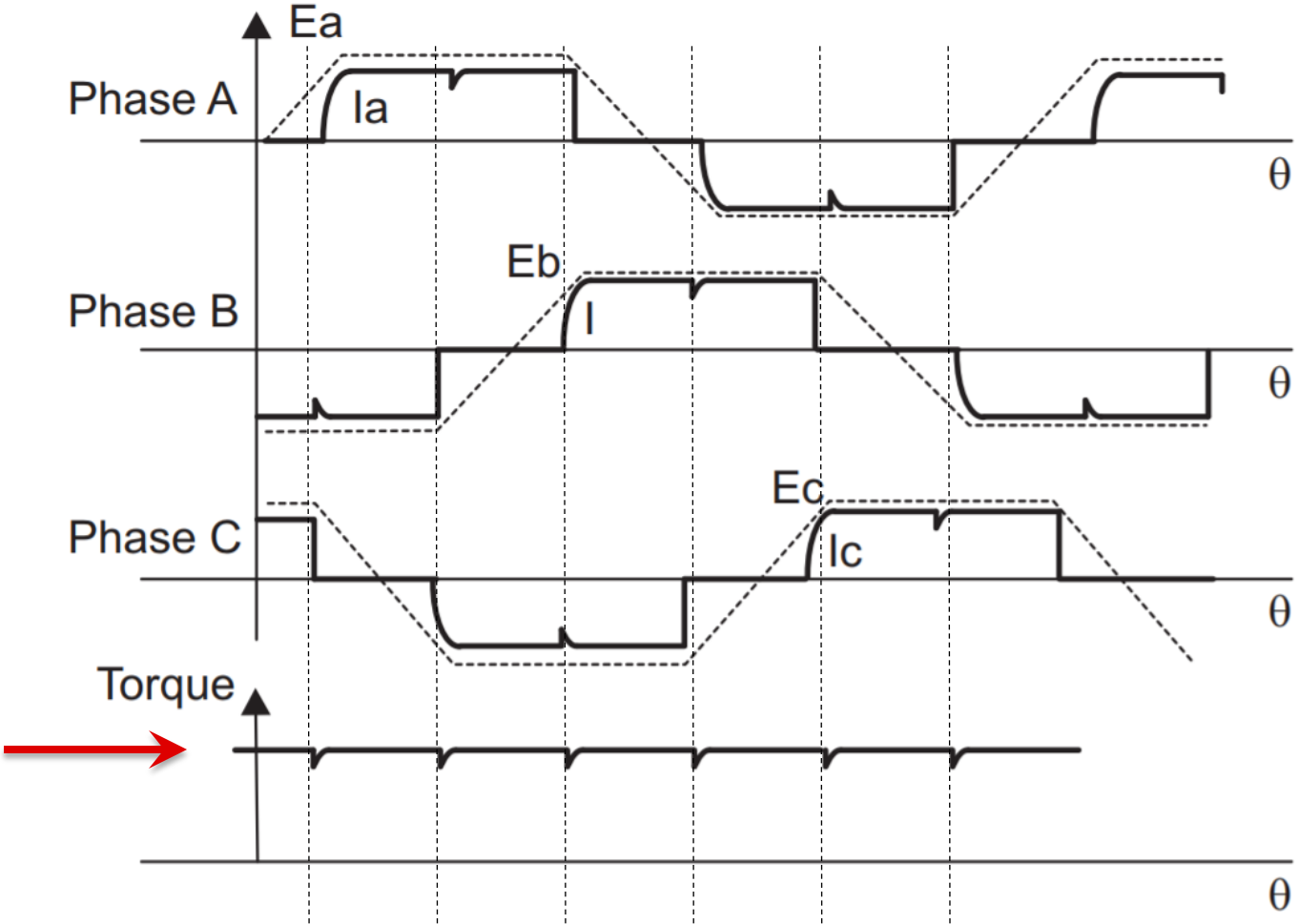

Sensored trapezoidal commutation

6-Step trapezoidal control using hall sensors

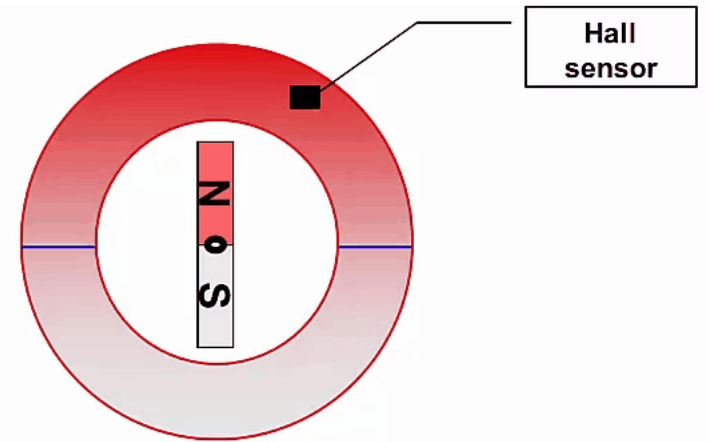
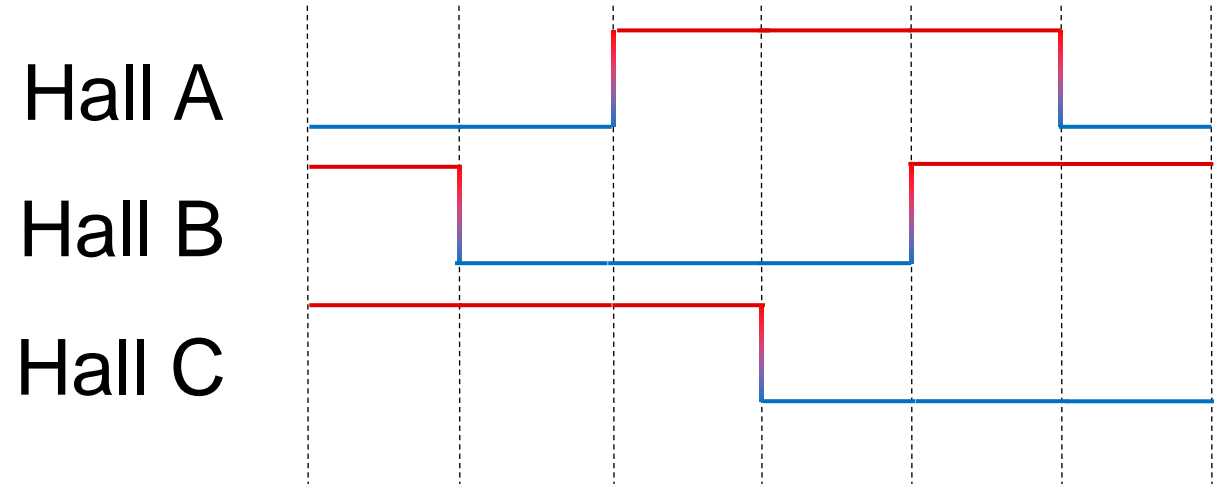

Hall sensor output

- 1 —
- 0 —

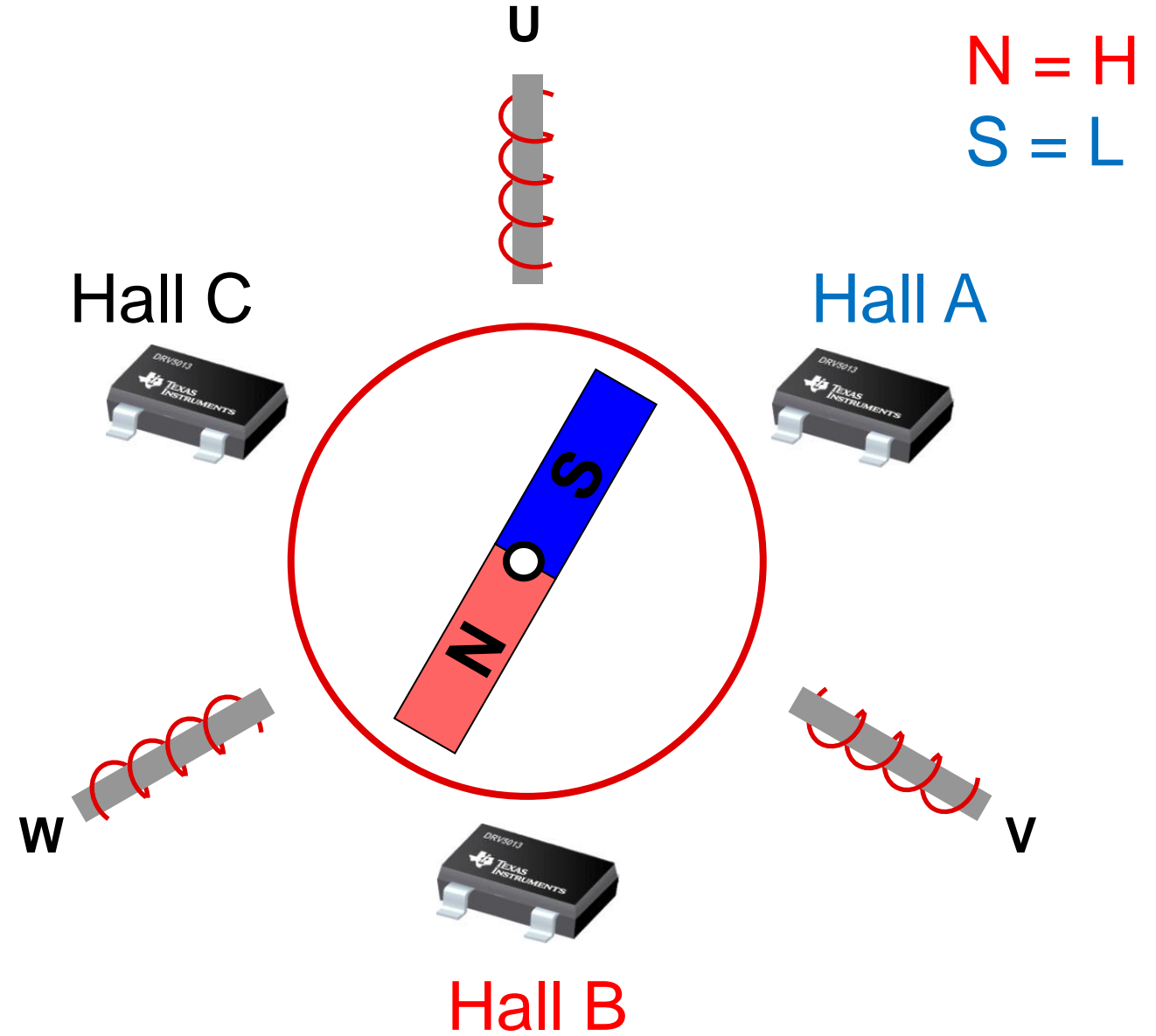

Sensored trapezoidal commutation

Rotor Position Sensing			Output State		
Hall A	Hall B	Hall C	U	V	W
0	0	0	Invalid		
0	0	1	+	Z	-
0	1	0	Z	-	+
0	1	1	+	-	Z
1	0	0	-	+	Z
1	0	1	Z	+	-
1	1	0	-	Z	+
1	1	1	Invalid		

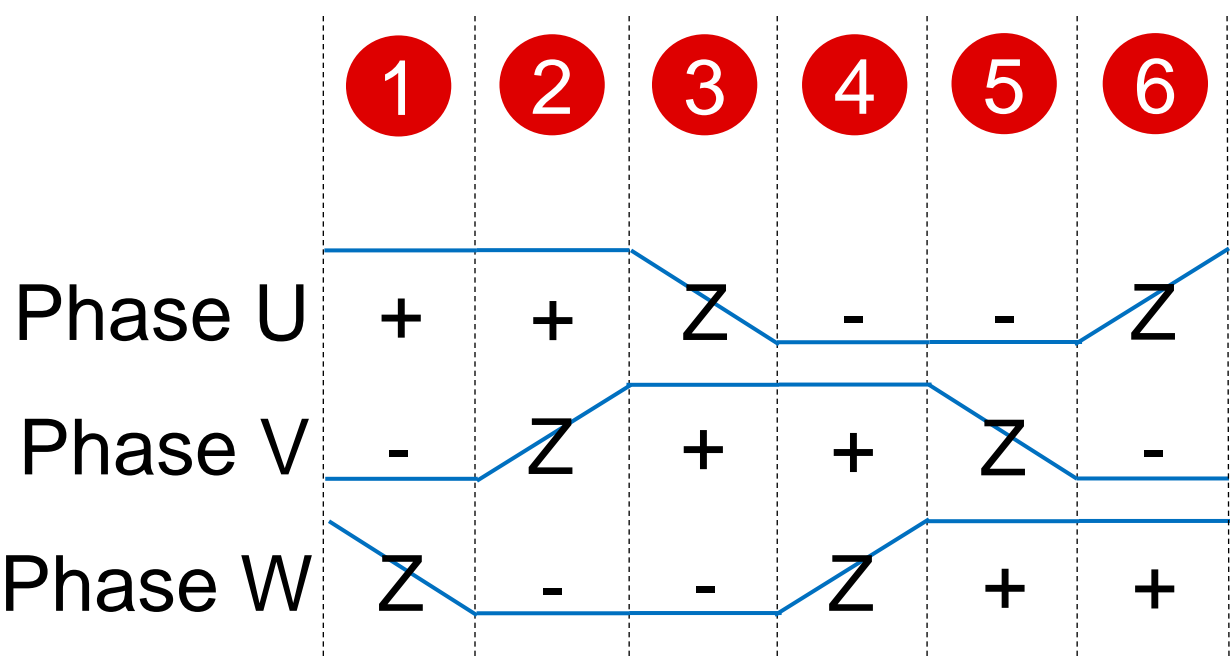
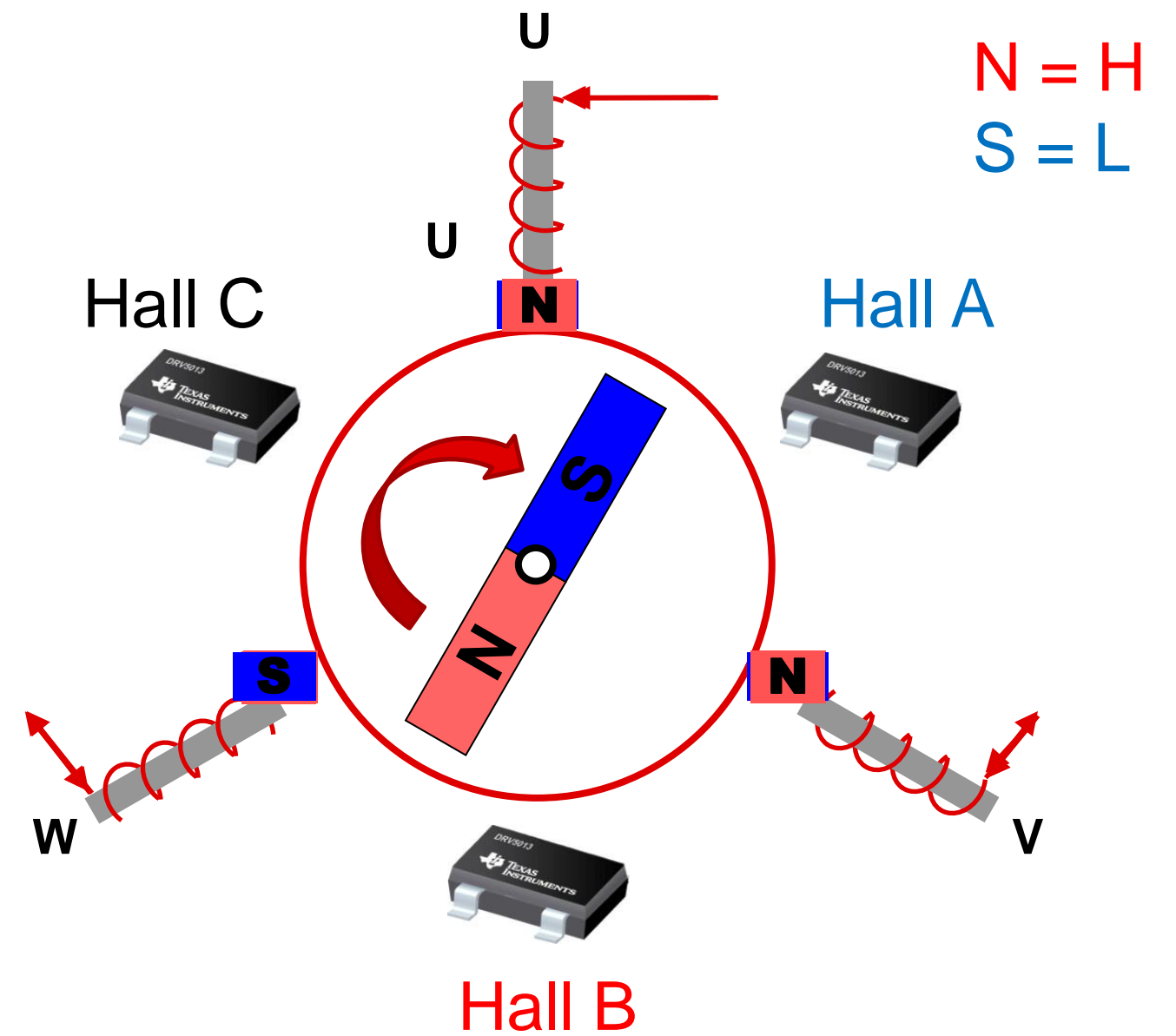

Sensorless trapezoidal commutation

6-step trapezoidal control using back-EMF

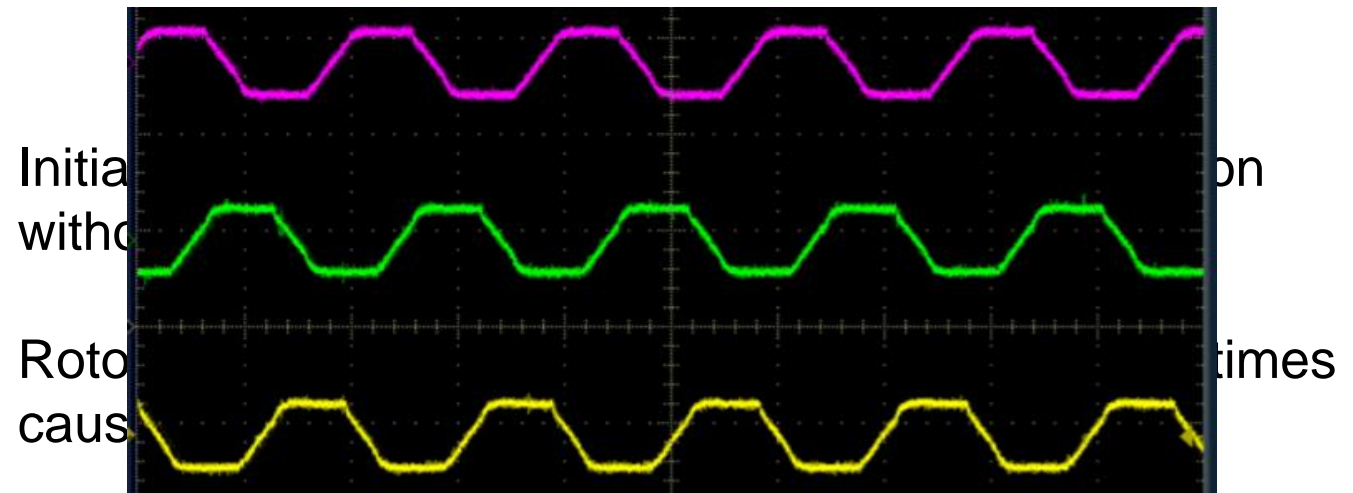
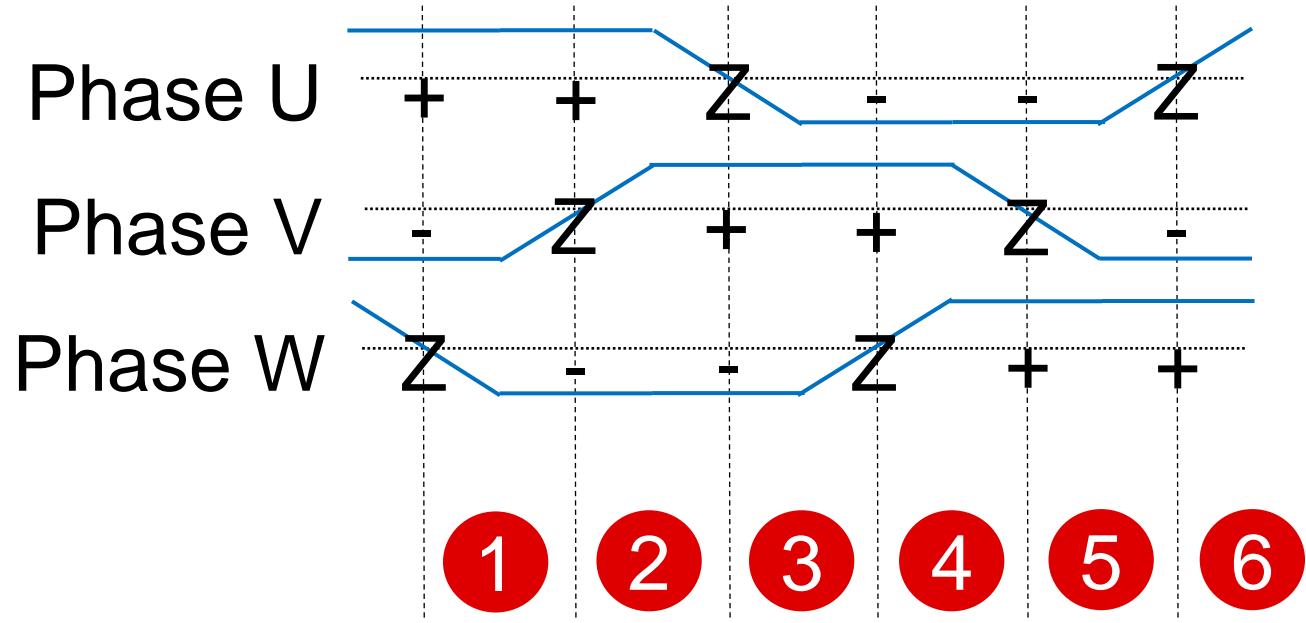

Back-EMF waveforms for 3-phase system

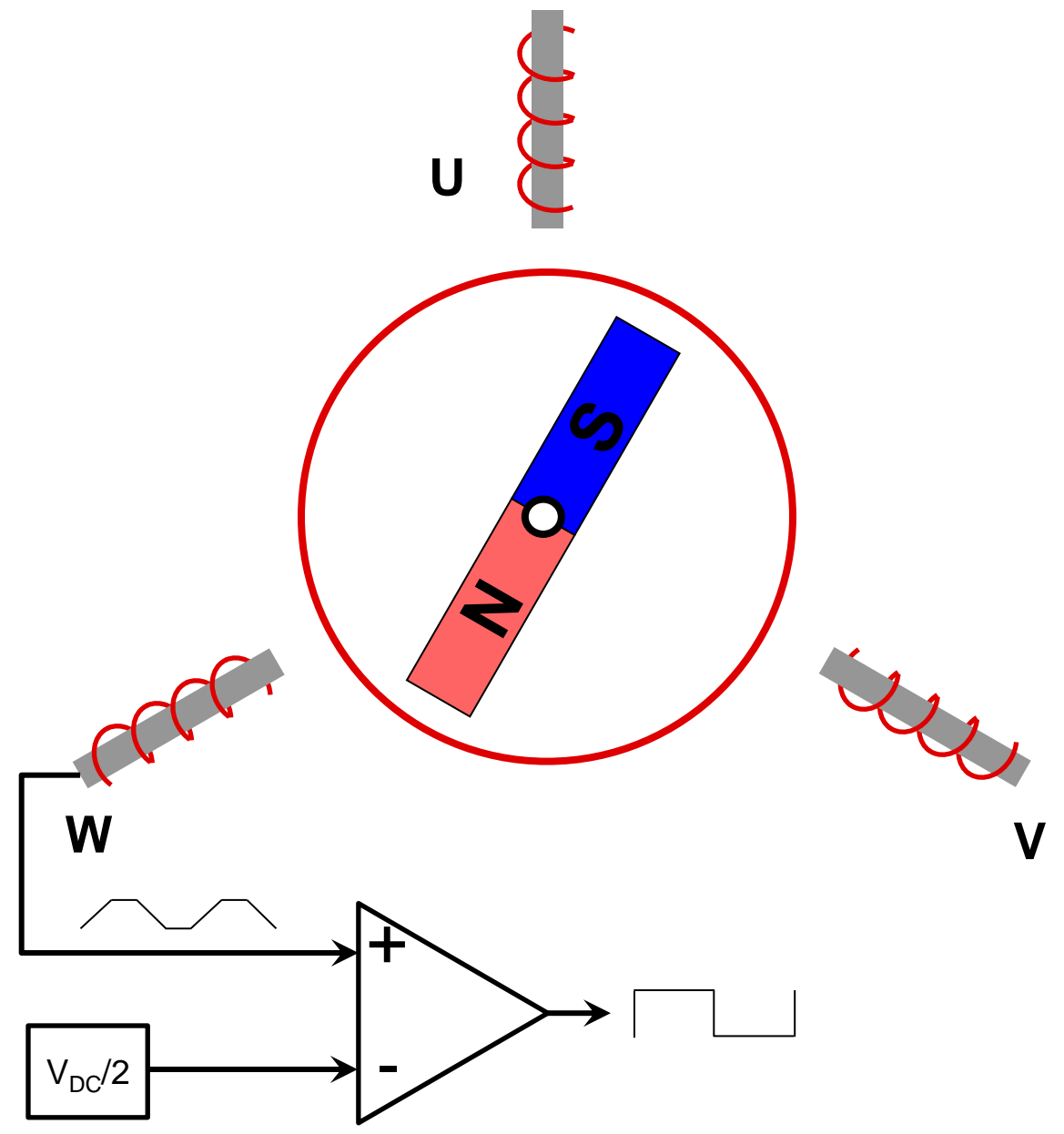

To find more motor driver technical resources and search products, visit [ti.com/motordrivers](https://www.ti.com/motordrivers)