

Passive Components and Circuits - 1

TI Precision Labs – Op Amps

Prepared and presented by Daniel Miller

Hello and welcome to the TI precision labs series on passive components and circuits. Today we'll be discussing the transient and frequency-based behavior of resistors, capacitors, and inductors.

Complex numbers

$$\begin{array}{ccc}
 & j = \sqrt{-1} & \\
 & \underbrace{\hspace{10em}} & \\
 \underbrace{\hspace{2em}} \text{Real term} & & \underbrace{\hspace{2em}} \text{Resistance} \\
 x = a + jb & & Z = R + jX \\
 \underbrace{\hspace{10em}} \text{Imaginary term} & & \underbrace{\hspace{4em}} \text{Impedance} \quad \underbrace{\hspace{4em}} \text{Reactance} \\
 \\
 \text{Magnitude } \} |x| = \sqrt{a^2 + b^2} & & \text{Magnitude } \} |Z| = \sqrt{R^2 + X^2} \\
 \\
 \text{Phase } \} \angle x = \arctan(b/a) & & \text{Phase } \} \angle Z = \arctan(X/R)
 \end{array}$$

2

Before we discuss the passive electrical components, let's review complex numbers. Recall that in mathematical nomenclature, the letter "i" is used to represent the square root of -1. Because no such real number exists, we refer to this as an "imaginary" number. Also note, that because "i" is typically used to refer to current, electrical engineers prefer to use the letter "j." So any number can be expressed as the sum of its real and imaginary parts, as shown here for "x equals a plus jb." In this equation, the term "a" is the real part of the number x and the term "b" is the imaginary part. Complex numbers can also be represented by a "magnitude" and a "phase" or "angle." Similarly, electrical impedances, denoted by the letter "Z," can have both real and imaginary parts. The real part is called "resistance" and is represented by the letter "R." The imaginary part is called "reactance" and is represented by the letter "X." The magnitude and phase of a complex number can also be used when describing the impedance of a passive component.

Resistors

Time domain

$$R(t) = \frac{V(t)}{I(t)}$$

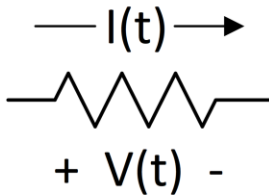

Frequency domain

$$Z_R(j\omega) = \frac{V(j\omega)}{I(j\omega)}$$

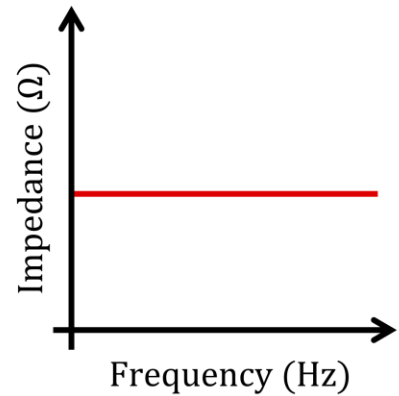
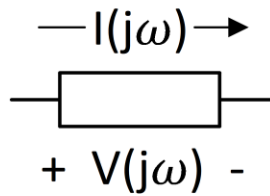

3

Let's now discuss the simplest of the passive components: the resistor. The ideal resistor has an impedance that is purely real. In the time domain, this behavior is defined by Ohm's Law, which states that the instantaneous voltage across a resistor divided by the instantaneous current through the resistor gives the component's resistance. The voltage drop across the resistor corresponds to the direction of the current flow through the resistor. Note that the impedance of a resistor in the frequency domain is found in the same manner as its resistance is independent of frequency.

Resistor transient behavior

- Voltage proportional to current
- Voltage and current can change instantaneously

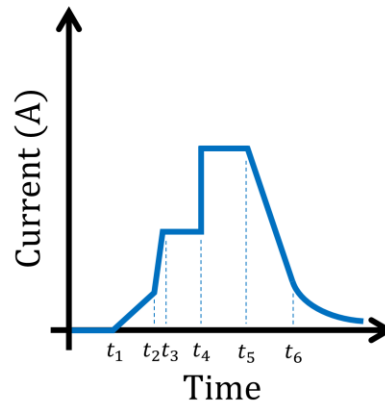
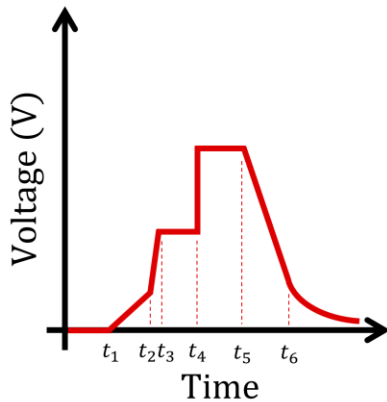

4

Because the voltage across a resistor and the current through a resistor are proportional, it is easy to visualize the current in time from the voltage in time and vice versa. In other words, the plots of voltage across time and current across time will have the same shape for an ideal resistor. They will be scaled relative to each other according to the resistance of the component. Another consequence of Ohm's Law is that both voltage across and current through a resistor can change instantaneously. This may not seem like a big deal, but it is actually not the case for the capacitor and inductor.

Capacitors

Time domain

$$I(t) = C \frac{dV}{dt}$$

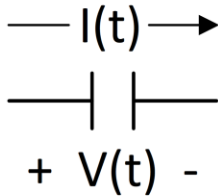

Frequency domain

$$Z_C(j\omega) = \frac{1}{j\omega C}$$

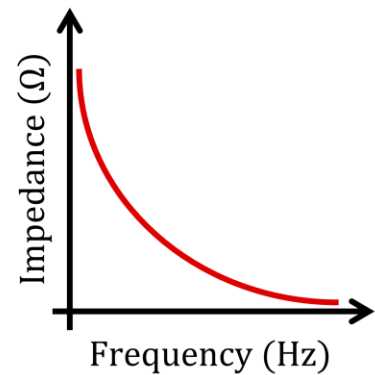
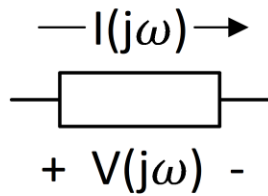

5

Let's now move on to the next passive component: the capacitor. The capacitor's behavior is noticeably different as the current through the capacitor is proportional to the derivative of the voltage across the capacitor. The formula that defines the transient behavior of the ideal capacitor is written as "I equals C dV over dt" where "I" is the current through the component in time measured in Amps, "C" is the capacitance of the component measured in Farads, and "V" is the voltage across the component in time measured in Volts. Performing a LaPlace transform gives us the impedance of the capacitor in the frequency domain. Here, "Z sub C" is the impedance of the capacitor in Ohms, "J" represents the square root of -1, omega represents the signal frequency in rad/s, and "C" is the component capacitance in Farads. Note that the impedance of the capacitor is inversely proportional to the frequency of operation. For this reason, the behavior of the capacitor can be approximated at low and high frequencies. For example, at DC or low frequencies, the impedance of the capacitor grows such that it can be treated as an open circuit. For very high frequencies, the impedance of the capacitor drops such that it can be treated as a short circuit. As with resistors, the voltage drop across a capacitor corresponds to the direction of the current flow through the capacitor.

Capacitor transient behavior

- Current proportional to derivative of voltage
- Instantaneous voltage step impossible as it would require infinite current

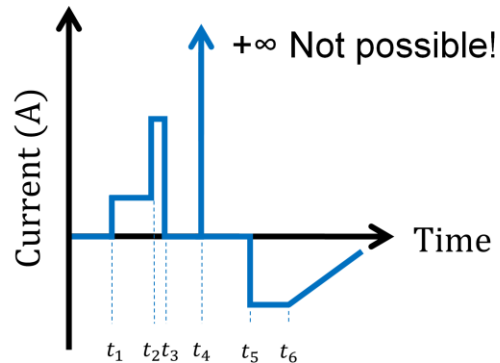
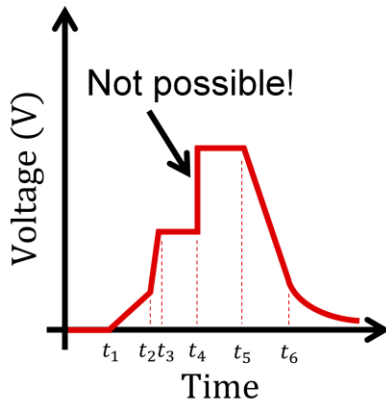

6

As mentioned in the previous slide, the current through a capacitor is proportional to the change in voltage across the capacitor. Consequently, the plot of current versus time can be ascertained from the plot of voltage versus time. An important consequence of this relation is that it is impossible for a capacitor to experience an instantaneous voltage step across its nodes. Why? Because the derivative of a line of infinite slope is an impulse. In the case of the capacitor, an instantaneous step in voltage would require an instant of infinite current through the capacitor. Clearly, this is impossible. Thus, any change in voltage across a capacitor requires a finite amount of time to take place.

Constant current through a capacitor

- Constant current means a linear change in voltage
- Corresponds to what occurs when an amplifier enters slew rate

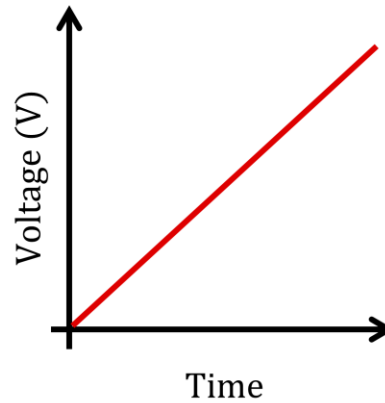
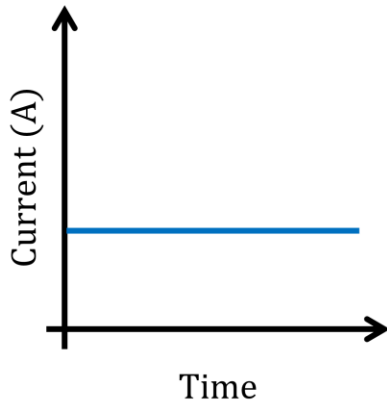

7

So far we have looked at the current through a capacitor given a voltage across the capacitor. But, what happens to the voltage across a capacitor when it is charged with a constant current? As you can see in this plot, a constant current flowing through a capacitor results in a linear change in voltage across the capacitor. This relationship is important in op amp design, specifically op amp slew rate. In the videos on slew rate, you will learn that an op amp's slew rate is determined by its Miller capacitance and the maximum current it uses to charge the capacitance. The slope of the resulting linear output is known as slew rate.

Inductors

Time domain

$$V(t) = L \frac{dI}{dt}$$

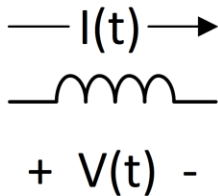

Frequency domain

$$Z_L(j\omega) = j\omega L$$

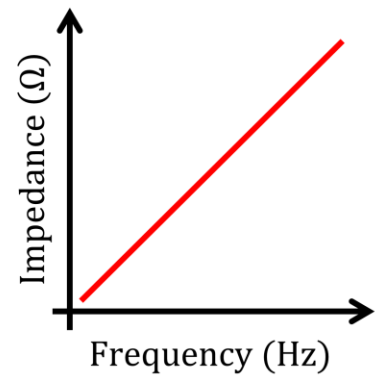
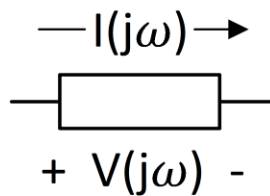

8

We now consider the final passive component: the inductor. The inductor's transient behavior is defined by the formula "V equals L di over dt" where "V" is the voltage across the component in time measured in Volts, "L" is the inductance of the component measured in Henry, and "I" is the current through the component in time measured in Amps. As with the capacitor, we can use a Laplace transform to find the impedance of the inductor in the frequency domain. Here, "Z sub L" is the impedance of the inductor in Ohms, "J" represents the square root of -1, omega represents the signal frequency in rad/s, and "L" is the component inductance in Henry. Note that the impedance of the inductor is proportional to the frequency of operation. As with the capacitor, the behavior of the inductor can be approximated at low and high frequencies. At DC or low frequencies, the impedance of the inductor is also low such that it can be treated as a short circuit. For very high frequencies, the impedance of the inductor rises such that it can be treated as an open circuit. The voltage drop across the inductor corresponds to the direction of the current flow through the component.

Inductor transient behavior

- Voltage proportional to derivative of current
- Instantaneous current step impossible as it would require infinite voltage

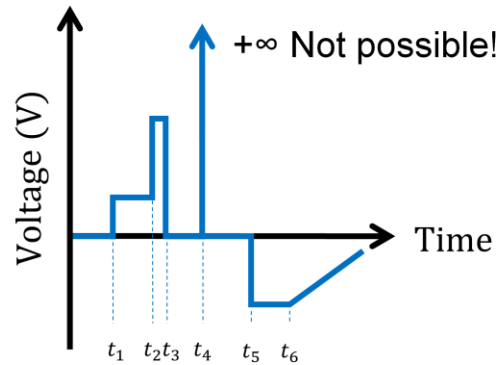
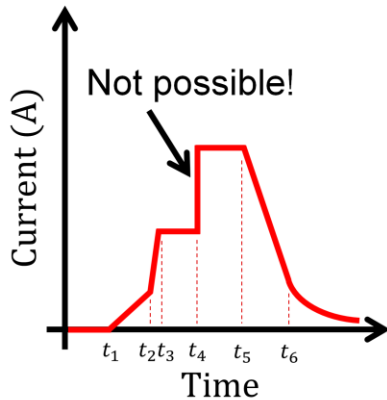

9

Because the voltage across an inductor is proportional to the change in current through the inductor, the plot of voltage versus time can be determined from the plot of current versus time. Also due to this relationship, it is impossible for an inductor to experience an instantaneous current step. An instantaneous step in current would require an instant of infinite voltage across the inductor. Clearly, this is not possible. Thus, any change in current through the inductor requires a finite amount of time to take place.

Series impedances

- Two or more passive components are in series when they share the same current
- They can be combined to form a single equivalent component

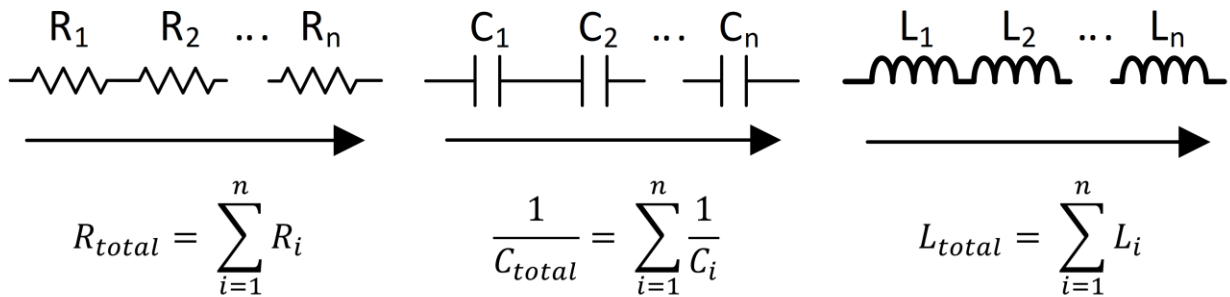

10

 TEXAS INSTRUMENTS

In closing, let's consider two of the most common, passive component arrangements: series impedances and parallel impedances. Two or more components are considered to be in series when they share the same current. With discrete components, this can be done intentionally. The circuit designer may choose to do this to minimize the power being consumed by each component. Series impedances may also occur parasitically. Regardless of how they occur, they can be simplified to a single equivalent component to facilitate calculations. For example, resistors in series can be simplified to a single component whose total resistance is equal to the sum of the individual resistances. Similarly, inductors in series can be simplified to a single equivalent inductor whose total inductance is equal to the sum of the individual inductances. To find the equivalent capacitance for a set of capacitors in series, sum the reciprocal of each capacitance and take the inverse.

Parallel impedances

- Two or more passive components are in parallel when they share the same voltage drop
- They can be combined to form a single equivalent component

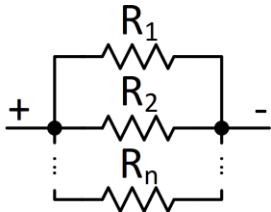

$$\frac{1}{R_{total}} = \sum_{i=1}^n \frac{1}{R_i}$$

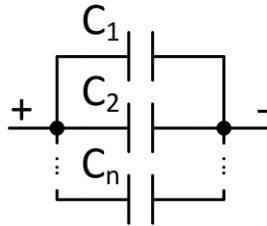

$$C_{total} = \sum_{i=1}^n C_i$$

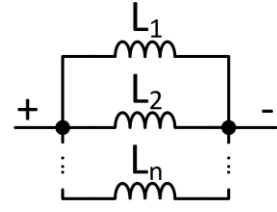

$$\frac{1}{L_{total}} = \sum_{i=1}^n \frac{1}{L_i}$$

11

On the other hand, two or more components are considered to be in parallel when they share the same voltage drop. Again, this may occur intentionally or unintentionally and they too can be simplified to a single equivalent component to facilitate calculations. In this case, resistors can be combined to a single equivalent component by summing the reciprocal of each resistance and taking the inverse. Since parallel resistors are quite common, it's good to know a couple of rules of thumb. For example, if two resistors of the resistance "R" are in parallel, then their equivalent resistance is equal to one half of their individual resistance, or "R/2". Similarly, the equivalent resistance of two or more parallel resistors will always be smaller than the smallest individual resistance. An equivalent inductor for parallel inductors can be found using the same equation. To find an equivalent capacitor, simply take the sum of the individual capacitances.

**Thanks for your time!
Please try the quiz.**

12

 TEXAS INSTRUMENTS

That concludes this lesson! Thanks for your time and please try the quiz.

Questions: Passive components and circuits - 1

1. True or False: A capacitor can undergo instant, step changes in voltage.
 - a) True
 - b) False

13

Question 1. True or False: A capacitor can undergo instant, step changes in voltage. The correct answer is false. Remember that the equation defining the transient behavior of a capacitor is “ I equals $C dv/dt$.” Since the derivative of a step is an impulse and a capacitor cannot pass infinite current, it is also not true that a capacitor can undergo instant, step changes in voltage.

Questions: Passive components and circuits - 1

2. From left to right, the plots below show the impedance versus frequency relationship of which components?

- a) Inductor, Capacitor, Resistor
- b) Inductor, Resistor, Capacitor
- c) Capacitor, Resistor, Inductor

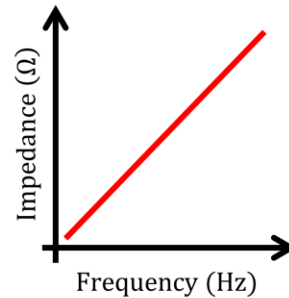
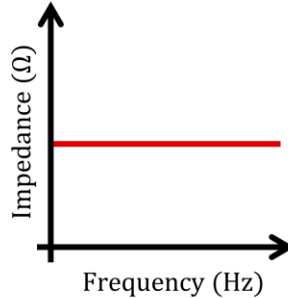
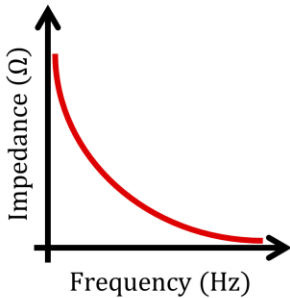

14

Question 2. From left to right, the plots below show the impedance versus frequency relationship of which components? The correct answer is "C." From left to right, the plots describe the impedance versus frequency of a capacitor, then a resistor, and finally and inductor. Remember, the capacitor has an impedance that is inversely proportional to frequency; the resistor has an impedance that is independent of frequency; and the inductor has an impedance that is proportional to frequency.

Questions: Passive components and circuits - 1

3. Looking in from V_{in} , what is the equivalent resistance of this resistor network?

- a) $11.25\text{k}\Omega$
- b) $15\text{k}\Omega$
- c) $16.25\text{k}\Omega$
- d) $20\text{k}\Omega$

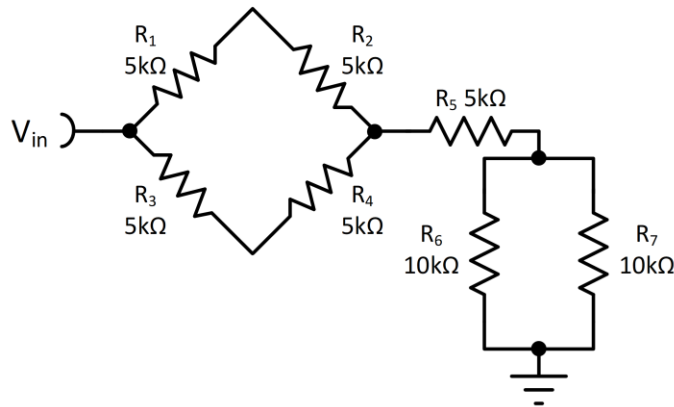

15

 TEXAS INSTRUMENTS

Question 3. Looking in from V_{in} , what is the equivalent resistance of this resistor network? The correct answer is $15\text{k}\Omega$. To solve this problem, begin taking equivalent impedances from the ground node toward the input. The two $10\text{k}\Omega$ resistors are in parallel and have an equivalent resistance of $5\text{k}\Omega$. This is then in series with the $5\text{k}\Omega$, R_5 resistor. Together, this forms a $10\text{k}\Omega$ resistance. Finally, consider the resistor bridge formed by the four remaining $5\text{k}\Omega$ resistors. R_1 and R_2 are in series and form a $10\text{k}\Omega$ equivalent resistance. The same is true of R_3 and R_4 . Taking the equivalent resistance of R_1 and R_2 along with R_3 and R_4 , we have two $10\text{k}\Omega$ resistors together in parallel. This leaves us with a single $5\text{k}\Omega$ resistor equivalent to the combination of R_1 , R_2 , R_3 , and R_4 . This can be combined in series with the equivalent resistor formed by R_5 , R_6 , and R_7 which we found to be $10\text{k}\Omega$. So overall, we have an equivalent resistance of $15\text{k}\Omega$.

Thanks for your time!

16



That's all for now! Thanks again for your time.



© Copyright 2018 Texas Instruments Incorporated. All rights reserved.

This material is provided strictly "as-is," for informational purposes only, and without any warranty.
Use of this material is subject to TI's **Terms of Use**, viewable at TI.com