

Introduction to Magnetic Current Sensing

TI Precision Labs – Magnetic Sensors

Presented and prepared by Ian Williams

Hello, and welcome to the TI precision labs series on magnetic sensors. My name is Ian Williams, and I'm the applications manager for current sensing products. In this video, we will give an introduction to magnetic current sensing, including: a comparison of direct vs. indirect sensing, review of Ampere's law, and overview of different magnetic current sensing technologies.

Direct (shunt-based) current sensing

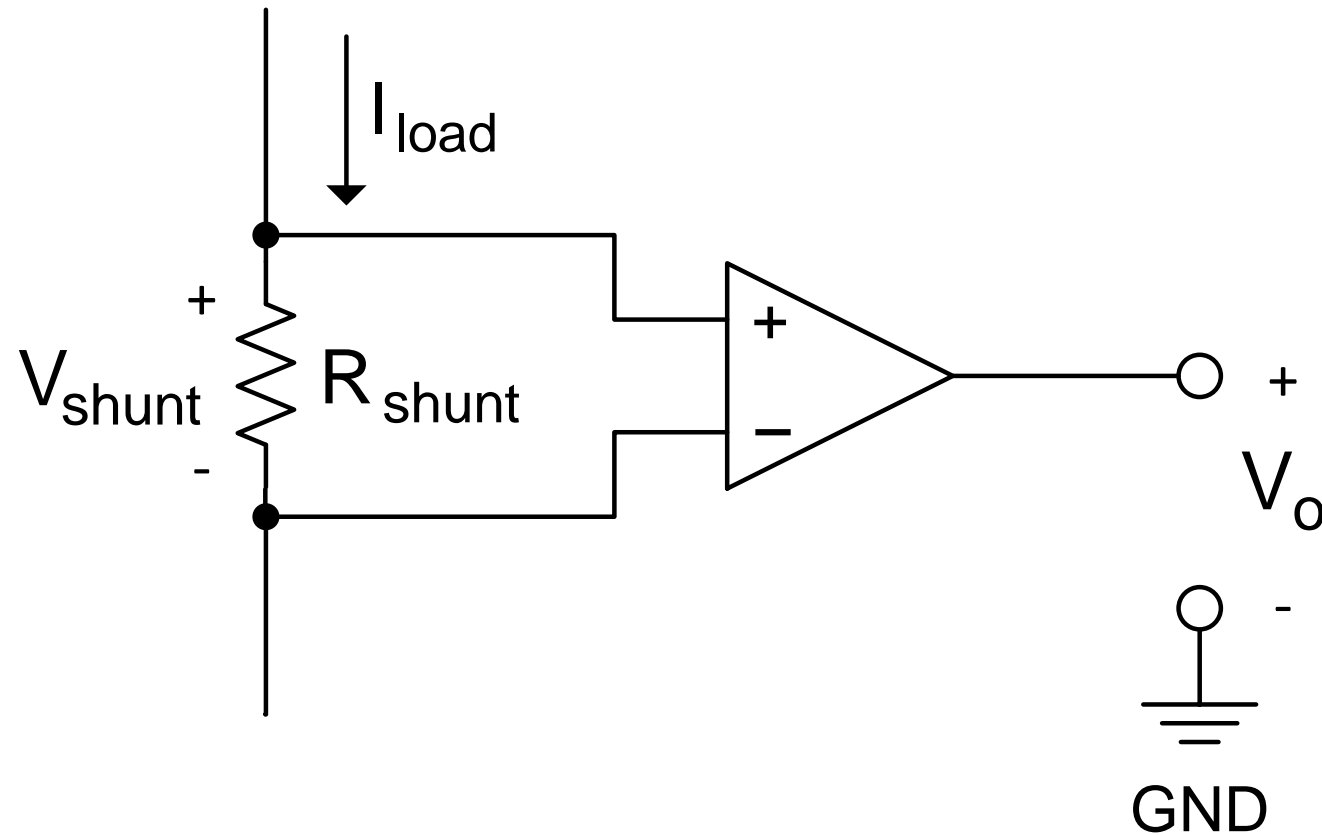

- **Things to know:**

- Based on Ohm's law
- Shunt resistor in series with load
- Invasive measurement $\rightarrow R_{SHUNT}$ adds to system load
- Sensing circuit not isolated from system load

- **Recommend when:**

- Currents are $< 100A$
 - Higher currents possible with appropriate shunt resistor and design techniques
- System can tolerate power loss $\rightarrow P = I^2R$
- Low voltage $\rightarrow 100V$ or less
- Load current not very dynamic
- Isolation not required (though it can be accomplished)

See: [TI Precision Labs – Current Sense Amplifiers](#)

Direct, or shunt-based, current sensing is based on Ohm's law. By placing a shunt resistor in series with the system load, a voltage is generated across the shunt resistor that is proportional to the system load current. The voltage across the shunt can be measured by differential amplifiers such as current sense amplifiers (CSAs), operational amplifiers (op amps), difference amplifiers (DAs), or instrumentation amplifiers (IAs).

This method is an invasive measurement of the current since the shunt resistor and sensing circuitry are electrically connected to the monitored system. Therefore, direct sensing typically is used when galvanic isolation is not required, although isolated devices are available. The shunt resistor also dissipates power, which may not be desirable. Direct current sensing typically is implemented for load currents less than 100A which are not very dynamic, and at voltages typically less than 100V.

For more information on direct current sensing, please watch the TI Precision Labs video series on current sense amplifiers.

Indirect (magnetic) current sensing

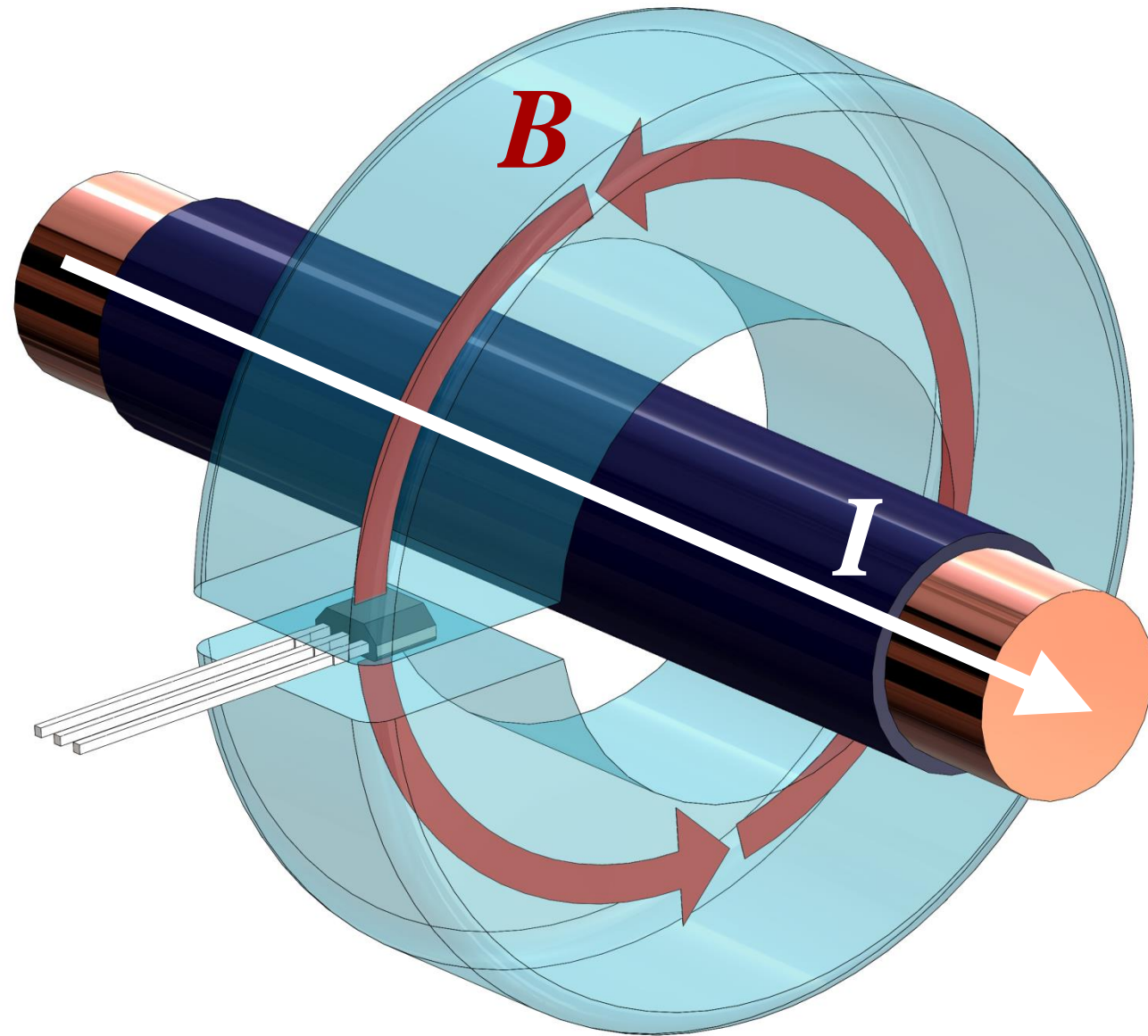

- **Things to know:**

- Based on Ampere's law
- Magnetic sensor placed near current-carrying conductor
- Noninvasive measurement → no direct connections
- Sensing circuit is isolated from system load

- **Recommend when:**

- Currents are $> 1\text{A}$, up to $1000+\text{ A}$
 - Lower currents possible with appropriate devices, calibration, and magnetic and PCB layout design techniques
- System cannot tolerate power loss
- High voltage → 100V or greater
- Load current is dynamic
- Isolation required

Indirect, or magnetic, current sensing is based on Ampere's law. According to Ampere's law, the magnetic field in space around a conductor is proportional to the electric current through that conductor. By placing a magnetic sensor (such as a Hall sensor) near the current-carrying conductor, a voltage is generated across the sensor which is proportional to the magnetic field seen by the sensor.

This method allows for a non-invasive measurement where the sensing circuitry is not electrically connected to the monitored system. Since there is no direct connection between the sensing circuitry and the system, the system is inherently isolated. This makes magnetic current sensing an excellent choice for high-voltage or dynamic current measurements.

In the past, indirect current sensing was typically only used to measure currents 100A or greater. The sensors were relatively expensive and not conducive to sensing currents on a PCB. Also, some amount of magnetic design was often necessary, such as using magnetic cores to attenuate or concentrate the magnetic flux seen by the sensor. However, advancements in technology and reductions in price have resulted in newer devices such as in-package magnetic current sensors, which are relatively inexpensive and well-suited for lower currents on a PCB.

Ampere's law and right hand rule

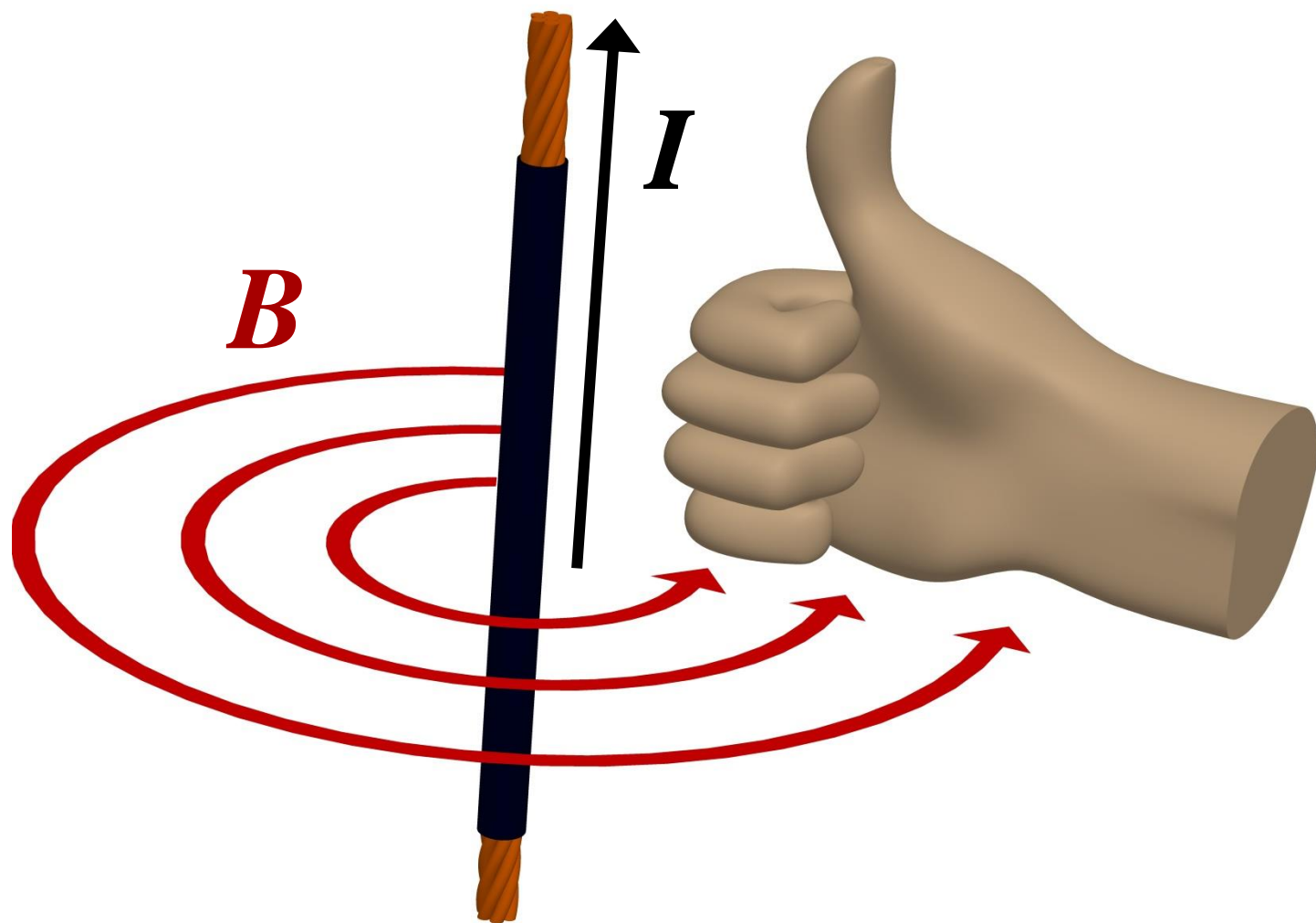

Direction of field relative to current flow

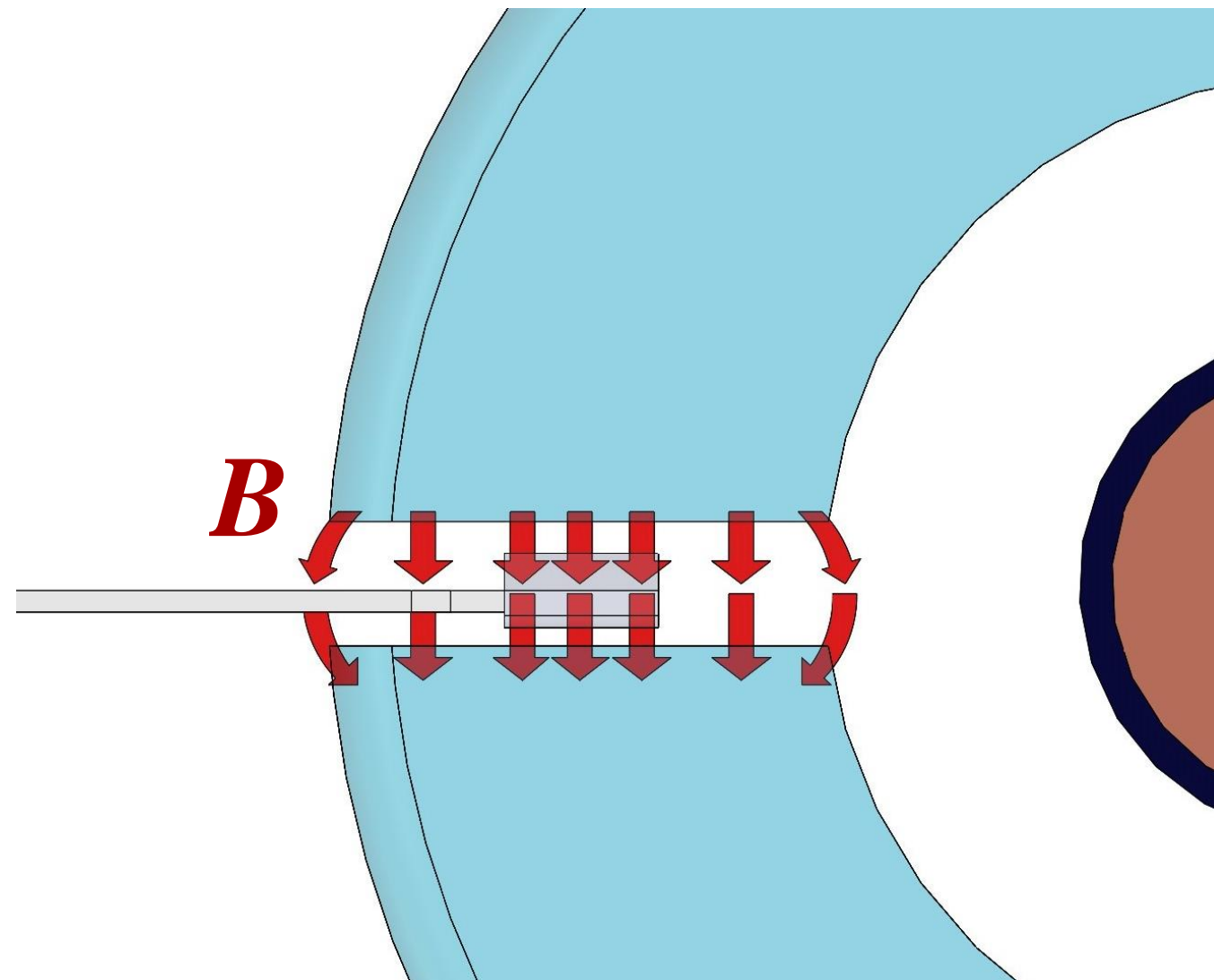

Sensor axis of sensitivity

Let's take a moment to give a quick review of Ampere's law and the right-hand rule. As stated on the previous slide, Ampere's law states that the magnetic field in space around a conductor is proportional to the electric current through that conductor. But in what direction do the lines of magnetic flux follow?

The right hand rule is a simple and helpful way to determine this. The magnetic field lines around a conductor form concentric circles, perpendicular around the conductor. If you make a thumbs-up with your right hand and point your thumb in the direction of current flow, your fingers are curled in the same direction as the direction of the magnetic field.

The direction of magnetic field is important for magnetic current sensors, as these devices have a particular axis of sensitivity. If the direction of magnetic flux is not traveling in their axis of sensitivity, they will not detect the field or produce a measureable output. For example, devices are usually sensitive to fields perpendicular to the face of their package. Therefore, such a device is not able to measure the current directly over a PCB trace, as the field at that spot is traveling across the package instead of into the package. Instead, the device should be moved next to the package, where field is traveling into the package.

Magnetic current sensing (MCS) has many faces

Module

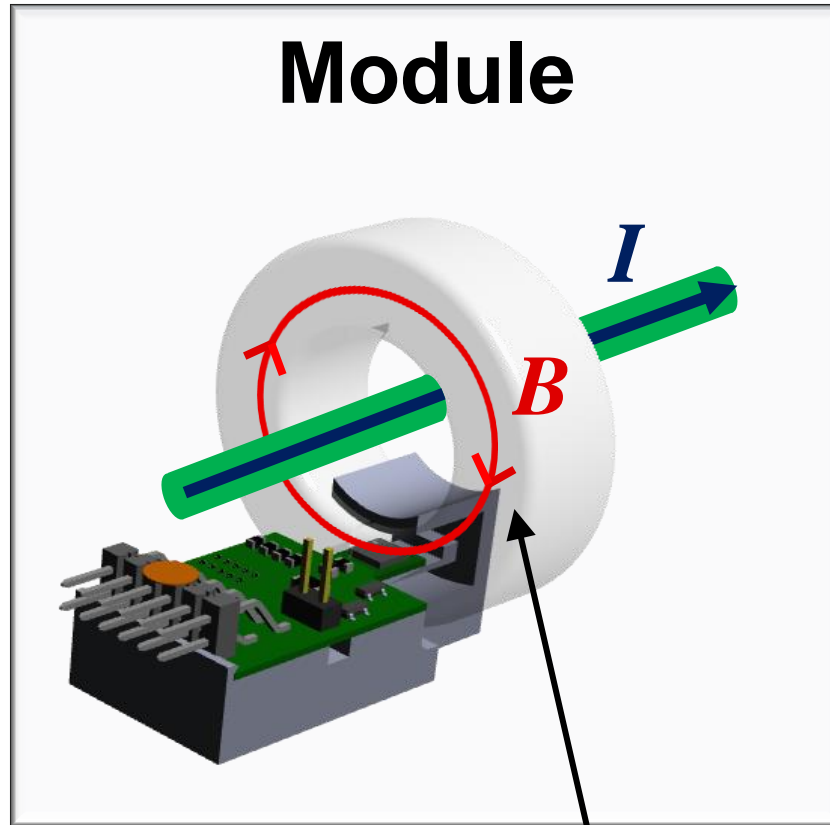

Uses toroid to concentrate magnetic field around a current-carrying conductor

Measures magnetic field in air around a PCB trace, bus bar, or other conductor

Ambient

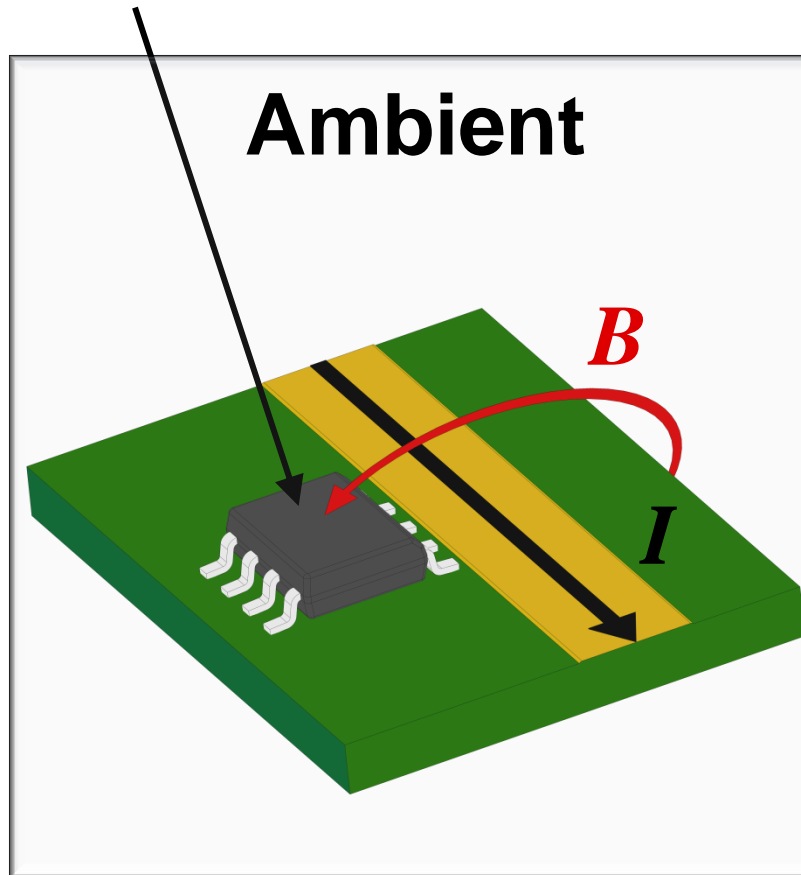

In-Package

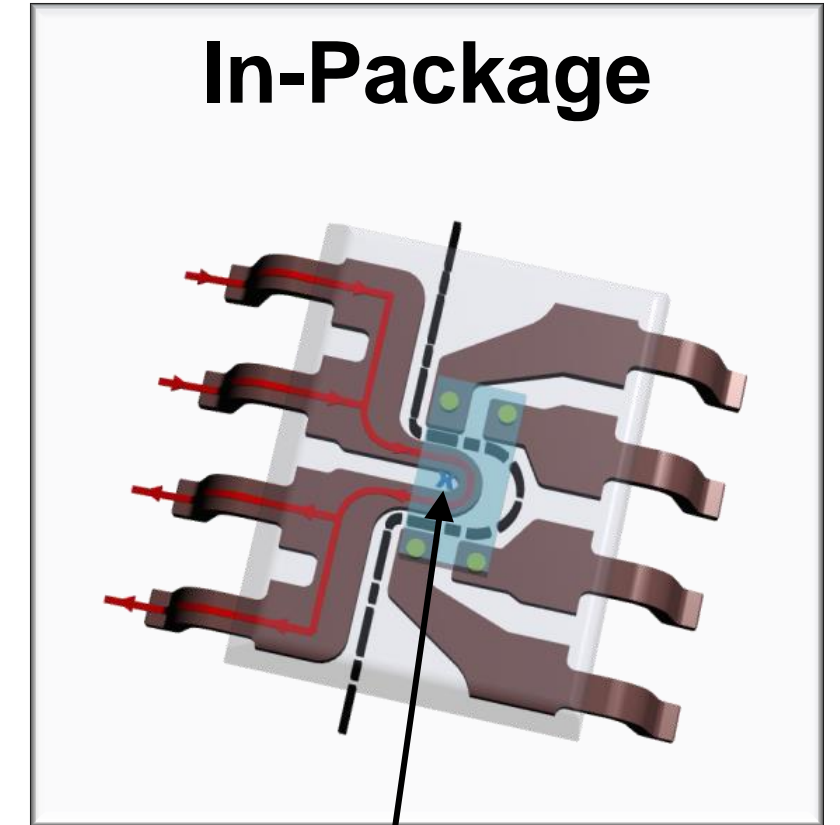

Measures magnetic field generated by current flow through lead frame

There are several different implementations of magnetic current sensing, or MCS, which all use the same fundamental physics given by Ampere's law which we described previously.

Since the physics is the same for all of these solutions, the difference is the mechanical and magnetic integration of the solution: where is the field generated and measured relative to the current flow.

This solution space can be roughly split into three different types, depending on that mechanical integration.

First, module based sensing typically utilizes a magnetic toroid or other geometry to concentrate the magnetic field generated by the current carrying conductor. These systems are typically sold by a third party manufacturer, as there is a high degree of magnetic design required.

Next, ambient magnetic current sensing utilizes the ambient in-air field generated by a PCB trace, bus bar, or other conductor to sense current. This is accomplished using a linear Hall or other magnetic sensor at some fixed mechanical distance from the conductor. This type of solution can also utilize a magnetic concentrator or shield to improve signal levels or reduce the impact of stray fields.

Finally, the third type is in-package magnetic current sensing. In this technology, the current to be measured actually passes through the device package, and the magnetic field generated by the current flow through the lead frame is measured internally with an isolated sensor IC.

The differences between these different solutions are not always clear. This is important to remember, as each implementation has inherent benefits and challenges, but could fundamentally solve the same problem, and thus be inter-changeable to a certain degree depending on application requirements.

The challenges of magnetic current sensing

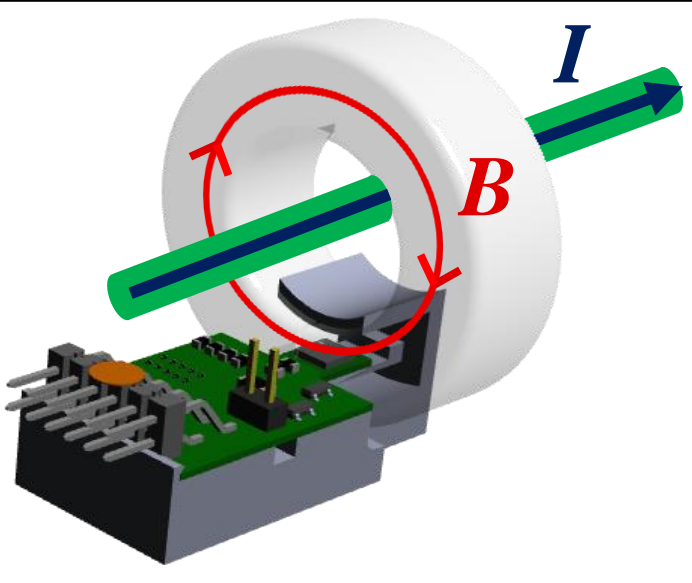
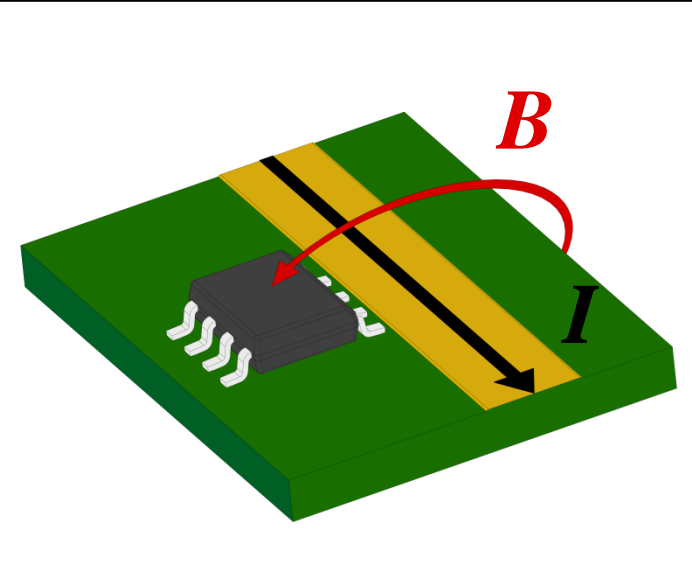
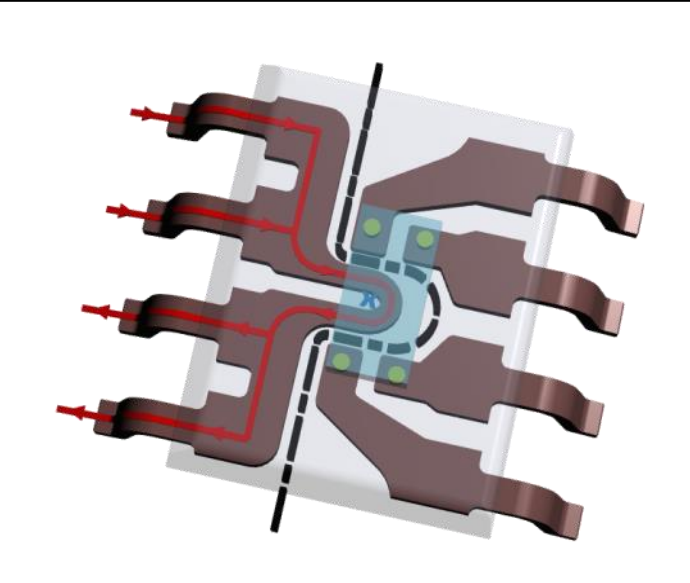
	 Module	 Ambient	 In-package
Mechanical / magnetic design	X		
Distance from magnetic field		X	
Stray magnetic fields		X	X
Magnetic materials in system		X	X
Effects of PCB layout		X	X
Isolation barrier capability			X
Thermal limitations			X

So what are some of the challenges facing magnetic current sensing?

When developing a module, a significant level of mechanical and magnetic design is needed. This may be unfamiliar territory for engineers that typically work in the electrical domain. While it can create a powerful sensing solution, the complexity and cost associated with module design make it prohibitive for many applications.

Ambient sensors are affected by the distance from the magnetic field generated by the current-carrying conductor, while ambient and in-package types are both susceptible to interference from stray magnetic fields, other magnetic materials in the system, and the layout of the printed circuit board.

In-package magnetic current sensors have a couple more unique challenges, including capability of the isolation barrier and the thermal limits to its current measuring capabilities.

There are solutions to these challenges, for example, stray fields can be managed by using differential sensors or by shielding the sensor. More details about these challenges and how to manage them will be given in later videos in this series.

Which technology is best?

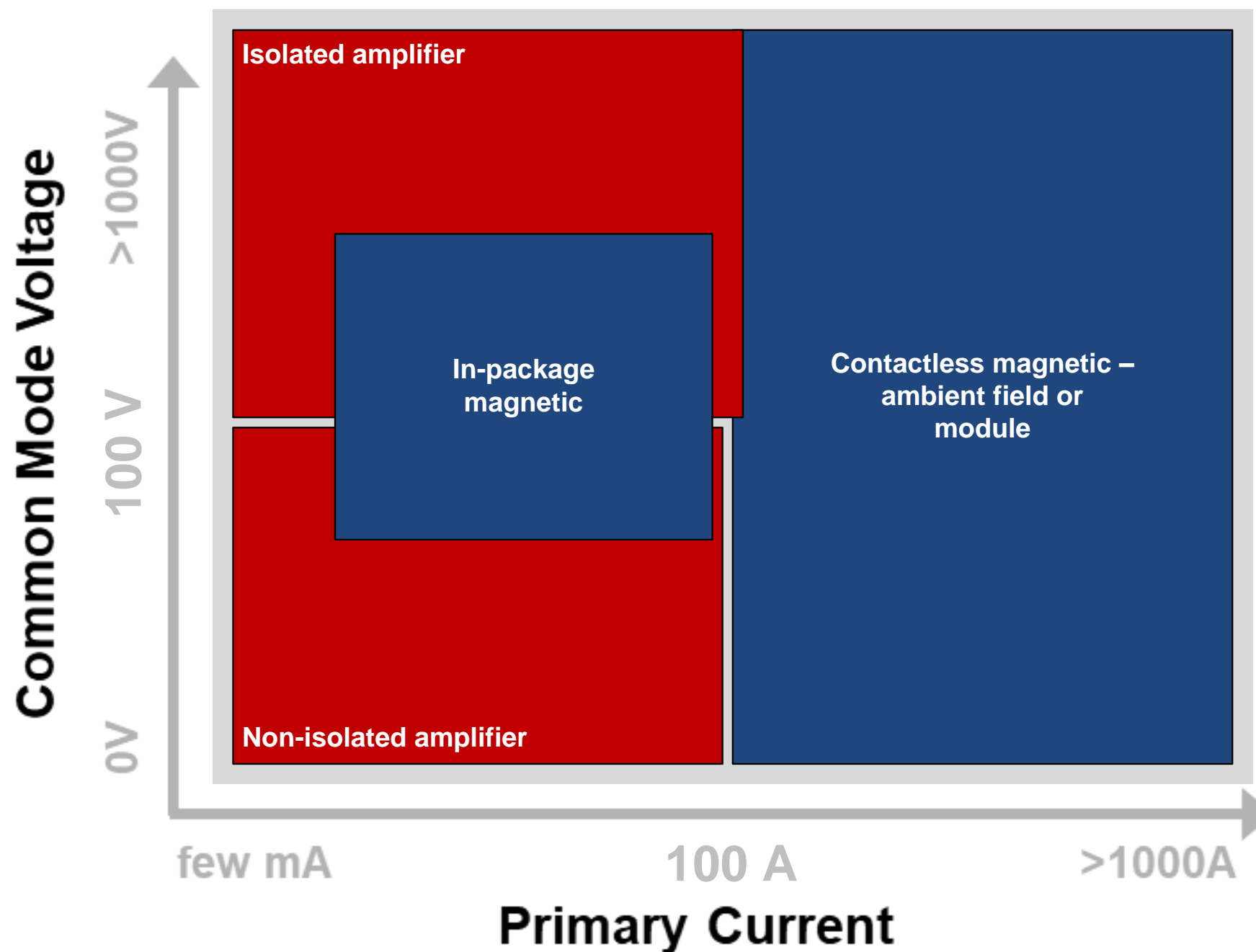

When choosing a current sensing device, you may wonder which device or technology is best-suited for the task. While there are usually multiple feasible options for an application, the image here shows the best-suited technologies for a given primary sense current and common-mode voltage. Please note, this comparison is highly simplified, and the bounds of each technology are not well-defined.

Let's do an example. What if an application requires sensing from 10 milliamps to 10 amps, at a common-mode of 12V? In this case, non-isolated amplifiers seem like the clear choice.

In another case, you may need to measure from 1A to 100A, at a common-mode of 100V. Here things are much less clear, as non-isolated amplifiers, in-package magnetic, and isolated amplifiers all seem to fit. To select the right device, you'll need to consider whether isolation is needed, as well as performance, cost, and anything else critical to your application.

To find more magnetic current sensing technical resources and search products, visit ti.com/halleffect

That concludes this video – thank you for watching! Please try the quiz to check your understanding of the content.

For more information and videos on magnetic current sensors, please visit ti.com/halleffect.

Introduction to Magnetic Current Sensing

TI Precision Labs – Magnetic Sensors

Quiz

Introduction to magnetic current sensing – quiz

1. Magnetic current sensing is based on _____ .
 - a) Ohm's law
 - b) Coulomb's law
 - c) Gauss' law
 - d) Ampere's law

2. The benefits of magnetic current sensing include _____ .
 - a) Isolated measurements
 - b) High voltage and high current capability
 - c) Dynamic current measurement capability
 - d) All of the above

Introduction to magnetic current sensing – quiz

3. Which is the main challenge of module-based MCS?
 - a) Stray magnetic fields
 - b) Complex mechanical and magnetic design
 - c) Isolation barrier capability
 - d) Thermal limitations

4. The direction of magnetic field relative to current flow can easily be determined using which technique?
 - a) Right hand rule
 - b) Newton's second rule of motion
 - c) Cramer's rule
 - d) Hund's rules

Answers

Introduction to magnetic current sensing – quiz

1. Magnetic current sensing is based on _____ .
 - a) Ohm's law
 - b) Coulomb's law
 - c) Gauss' law
 - d) Ampere's law

2. The benefits of magnetic current sensing include _____ .
 - a) Isolated measurements
 - b) High voltage and high current capability
 - c) Dynamic current measurement capability
 - d) All of the above

Introduction to magnetic current sensing – quiz

3. Which is the main challenge of module-based MCS?
- a) Stray magnetic fields
 - b) Complex mechanical and magnetic design
 - c) Isolation barrier capability
 - d) Thermal limitations
4. The direction of magnetic field relative to current flow can easily be determined using which technique?
- a) Right hand rule
 - b) Newton's second rule of motion
 - c) Cramer's rule
 - d) Hund's rules