

CC2340R SimpleLink™ Family of 2.4GHz Wireless MCUs

1 Features

Wireless microcontroller

- Optimized 48MHz Arm® Cortex®-M0+ processor
- Up to 512KB of in-system programmable flash
- 12KB of ROM for bootloader and drivers
- Up to 64KB of ultra-low leakage SRAM. Full RAM retention in standby mode
- 2.4GHz RF transceiver compatible with Bluetooth® Low Energy and IEEE 802.15.4 PHY and MAC
- Integrated balun
- Supports over-the-air upgrade (OTA)
- Serial wire debug (SWD)

Low power consumption

- MCU consumption:
 - 2.6mA active mode, CoreMark®
 - 53µA/MHz running CoreMark®
 - < 710nA standby mode on CC2340R52
 - 165nA shutdown mode, wake-up on pin
- Radio consumption:
 - 5.3mA RX
 - 5.1mA TX at 0dBm
 - < 11.0mA TX at +8dBm

Wireless protocol support

- Bluetooth® LE
 - Features: LE 2M, LE Coded, Periodic Advertising, Extended Advertising, LE Secure Connections
 - Qualified against Bluetooth Core 5.4
- Zigbee®
- Thread
- Proprietary systems

High-performance radio

- –102dBm sensitivity for Bluetooth® LE Coded 125kbps
- –96.5dBm sensitivity for Bluetooth® LE 1Mbps
- –98dBm sensitivity for IEEE 802.15.4 (2.4GHz)
- Output power up to +8dBm with temperature compensation

Regulatory compliance

- Suitable for systems targeting compliance with these standards:
 - EN 300 328 (Europe)
 - FCC CFR47 Part 15
 - ARIB STD-T66 (Japan)

MCU peripherals

- Up to 26 I/O pads
 - Two IO pads SWD, muxed with GPIOs
 - Two IO pads LFXT, muxed with GPIOs
 - Up to 22 DIOs (analog or digital IOs)
- Up to 3 × 16-bit and 1 × 24-bit general-purpose timers with quadrature decode mode and IR generation mode
- 12-bit ADC, 1.2Msps with external reference, 267ksps with internal reference, up to 12 external ADC inputs
- 1 × low power comparator
- 1 × UART
- 1 × SPI
- 1 × I²C
- Real-time clock (RTC)
- Integrated temperature and battery monitor
- Watchdog timer

Security enablers

- AES 128-bit cryptographic accelerator
- Random number generator from on-chip analog noise

Development tools and software

- [LP-EM-CC2340R53 LaunchPad Development Kit](#)
- [SimpleLink™ Low Power F3 software development kit](#)
- [SmartRF™ Studio](#) for simple radio configuration
- [SysConfig](#) system configuration tool

Operating range

- On-chip buck DC/DC converter
- 1.71V to 3.8V single supply voltage
- T_j: –40°C up to +125°C

RoHS-compliant package

- 5mm × 5mm RKP QFN40
- 4mm × 4mm RGE QFN24
- 2.2mm × 2.6mm YBG WCSP



2 Applications

- **Medical**
 - Home healthcare—[blood glucose monitors](#), [blood pressure monitors](#), [CPAP machines](#), [electronic thermometers](#)
 - Patient monitoring and diagnostics—[medical sensor patches](#)
 - Personal care and fitness—[electric toothbrush](#), [wearable fitness and activity monitor](#)
- **Building automation**
 - Building security systems—[motion detector](#), [electronic smart lock](#), [door and window sensor](#), [garage door system](#), [gateway](#)
 - HVAC—[thermostat](#), [wireless environmental sensor](#)
 - Fire safety system—[smoke and heat detector](#)
 - Video surveillance—[IP network camera](#)
- **Lighting**
 - LED luminaire
 - Lighting control—[daylight sensor](#), [lighting sensor](#), [wireless control](#)
- **Factory automation and control**
- **Retail automation and payment—electronic point of sale**
 - [Electronic shelf label](#)
- **Grid infrastructure**
 - Smart meters—[water meter](#), [gas meter](#), [electricity meter](#), and [heat cost allocators](#)
 - Grid communications—[wireless communications](#)—Long-range sensor applications
 - Other alternative energy—[energy harvesting](#)
- **Communication equipment**
 - [Wired networking](#)
 - [wireless LAN or Wi-Fi access points](#), [edge router](#)
- **Personal electronics**
 - [Connected peripherals](#)—[consumer wireless module](#), [pointing devices](#), [keyboards](#), and [keypads](#)
 - [Gaming](#)—[electronic and robotic toys](#)
 - [Wearables \(non-medical\)](#)—[smart trackers](#), [smart clothing](#)

3 Description

The CC2340R SimpleLink™ family of devices are 2.4GHz wireless microcontrollers (MCUs), targeting Bluetooth® Low Energy, Zigbee, Thread, and Proprietary 2.4GHz applications. These devices are optimized for low-power wireless communication with Over the Air Download (OAD) support in Building automation (wireless sensors, lighting control, beacons), asset tracking, medical, retail EPOS (electronic point of sale), ESL (electronic shelf), and Personal electronics (toys, HID, stylus pens) markets. Highlighted features of this device include:

- Support for Bluetooth 5 features: high-speed mode (2Mbps PHY), long-range (LE Coded 125kbps and 500kbps PHYs), privacy 1.2.1 and channel selection algorithm #2, as well as backward compatibility and support for key features from the earlier Bluetooth LE specifications.
- Fully qualified Bluetooth software protocol stack included with the [SimpleLink™ Low Power F3 software development kit \(SDK\)](#)
- Zigbee® protocol stack support in the [SimpleLink™ Low Power F3 software development kit \(SDK\)](#)
- Thread protocol stack support in [SIMPLELINK TI OPENTHREAD SDK](#)
- Ultra-low standby current less than 0.71µA with RTC operational and full RAM retention that enables significant battery life extension, especially for applications with longer sleep intervals.
- Integrated balun for reduced bill-of-material (BOM) board layout
- Excellent radio sensitivity and robustness (selectivity and blocking) performance for Bluetooth Low Energy (–102dBm for 125kbps LE Coded PHY, with integrated balun)

The CC2340R family is part of the SimpleLink™ MCU platform, which consists of Wi-Fi®, Bluetooth Low Energy, Thread, Zigbee, Sub1GHz MCUs, and host MCUs that all share a common, easy-to-use development environment with a single-core software development kit (SDK) and rich tool set. A one-time integration of the SimpleLink™ platform enables you to add any combination of the portfolio's devices into your design, allowing 100-percent code reuse when your design requirements change. For more information, visit the [SimpleLink™ MCU platform](#).

Device Information

PART NUMBER ⁽²⁾	FLASH	RAM	TEMPERATURE RANGE	PACKAGE	STATUS
CC2340R53E0RKPR	512KB	64KB	-40°C–125°C	QFN40	Released
CC2340R53E0YBGR	512KB	64KB	-40°C–125°C	WCSP	Released
CC2340R53N0RKPR	512KB	64KB	-40°C–85°C	QFN40	Released
CC2340R52E0RKPR	512KB	36KB	-40°C–125°C	QFN40	Released
CC2340R52E0RGER	512KB	36KB	-40°C–125°C	QFN24	Released
CC2340R52N0RKPR	512KB	36KB	-40°C–85°C	QFN40	Released
CC2340R52N0RGER	512KB	36KB	-40°C–85°C	QFN24	Released
CC2340R22E0RKPR	256KB	36KB	-40°C–125°C	QFN40	Released
CC2340R22N0RKPR	256KB	36KB	-40°C–85°C	QFN40	Released
CC2340R21E0RGER ⁽¹⁾	256KB	28KB	-40°C–125°C	QFN24	Preview
CC2340R21N0RGER	256KB	28KB	-40°C–85°C	QFN24	Released

- (1) Available in a future release
- (2) For more information, see [Section 12](#).

4 Functional Block Diagram

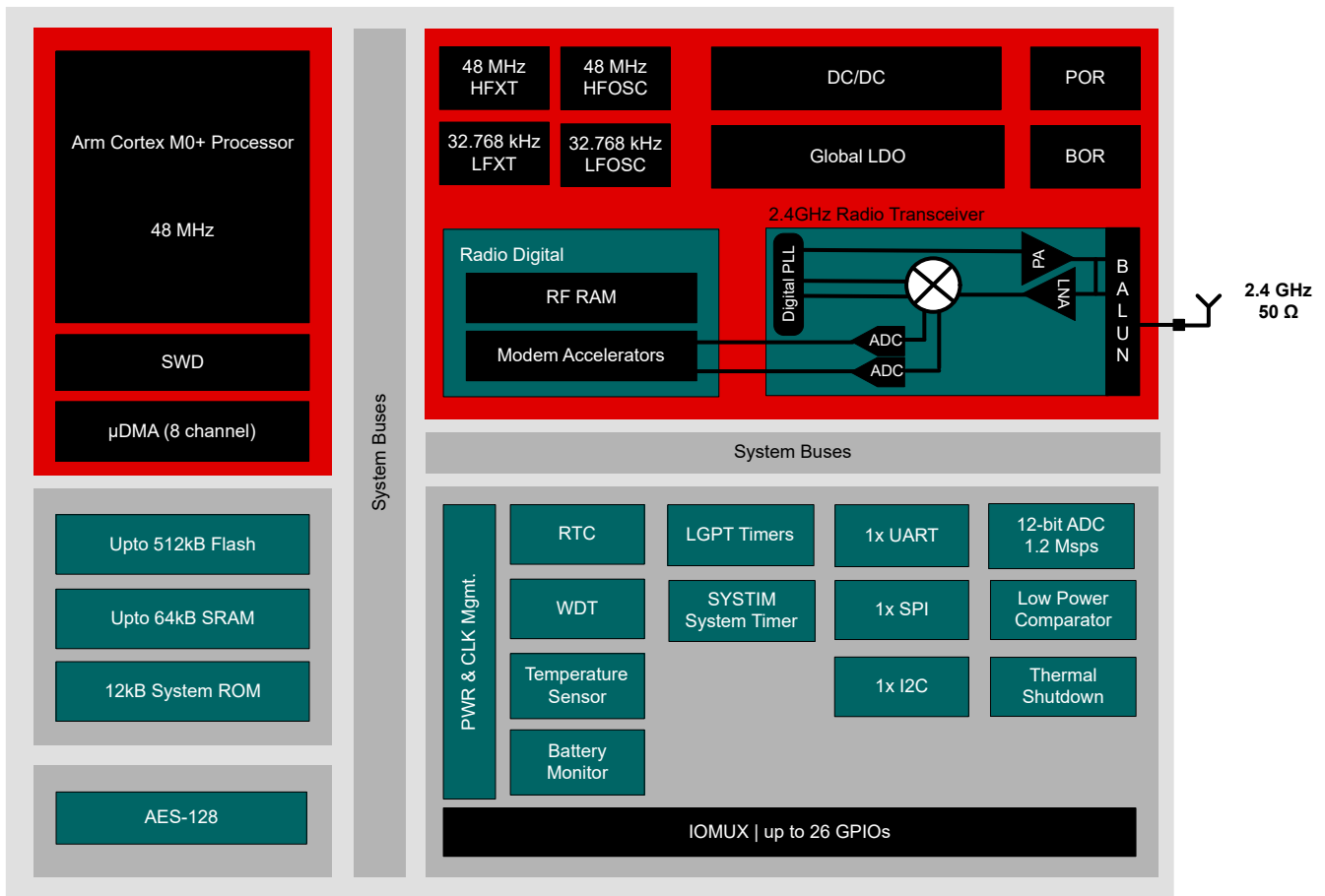

Figure 4-1. CC2340R Family Block Diagram

Table of Contents

1 Features	1	7.20 Timing and Switching Characteristics.....	26
2 Applications	2	7.21 Peripheral Characteristics.....	27
3 Description	2	7.22 Typical Characteristics.....	35
4 Functional Block Diagram	3	8 Detailed Description	44
5 Device Comparison	5	8.1 Overview.....	44
6 Pin Configurations and Functions	6	8.2 System CPU.....	44
6.1 Pin Diagrams.....	6	8.3 Radio (RF Core).....	44
6.2 Signal Descriptions.....	13	8.4 Memory.....	45
6.3 Connections for Unused Pins and Modules.....	17	8.5 Cryptography.....	45
7 Specifications	18	8.6 Timers.....	45
7.1 Absolute Maximum Ratings.....	18	8.7 Serial Peripherals and I/O.....	47
7.2 ESD Ratings.....	18	8.8 Battery and Temperature Monitor.....	47
7.3 Recommended Operating Conditions.....	18	8.9 μ DMA.....	47
7.4 DCDC.....	18	8.10 Debug.....	48
7.5 Global LDO (GLDO).....	19	8.11 Power Management.....	49
7.6 Power Supply and Modules.....	19	8.12 Clock Systems.....	50
7.7 Battery Monitor.....	19	8.13 Network Processor.....	50
7.8 Temperature Sensor.....	19	9 Application, Implementation, and Layout	51
7.9 Power Consumption–Power Modes.....	19	9.1 Reference Designs.....	51
7.10 Power Consumption–Radio Modes.....	20	9.2 Junction Temperature Calculation.....	52
7.11 Nonvolatile (Flash) Memory Characteristics.....	20	10 Device and Documentation Support	53
7.12 Thermal Resistance Characteristics.....	21	10.1 Device Nomenclature.....	53
7.13 RF Frequency Bands.....	21	10.2 Tools and Software.....	53
7.14 Bluetooth Low Energy–Receive (RX).....	21	10.3 Documentation Support.....	55
7.15 Bluetooth Low Energy Transmit (TX).....	24	10.4 Support Resources.....	55
7.16 Zigbee and Thread - IEEE 802.15.4-2006 2.4 GHz (OQPSK DSSS1:8, 250 kbps) - RX.....	24	10.5 Trademarks.....	55
7.17 Zigbee and Thread - IEEE 802.15.4-2006 2.4 GHz (OQPSK DSSS1:8, 250 kbps) - TX.....	25	10.6 Electrostatic Discharge Caution.....	56
7.18 Proprietary Radio Modes.....	25	10.7 Glossary.....	56
7.19 2.4GHz RX/TX CW.....	26	11 Revision History	56
		12 Mechanical, Packaging, and Orderable Information	59

5 Device Comparison

Device	RADIO SUPPORT				FLASH (KB)	RAM + Cache (KB)	GPIO	PACKAGE SIZE		
	2.4GHz Prop.	Bluetooth® LE	ZigBee	Thread				2.2 X 2.6 mm WCSP (28)	4 X 4 mm VQFN (24)	5 X 5 mm VQFN (40)
CC2340R53	✓	✓	✓	✓	512	64	12-26	✓		✓
CC2340R52	✓	✓	✓	✓	512	36	12-26		✓	✓
CC2340R22	✓	✓	✓	✓	256	36	26			✓
CC2340R21	✓	✓	✓		256	28	12		✓	

6 Pin Configurations and Functions

6.1 Pin Diagrams

6.1.1 Pin Diagram—RKP Package (Top View)

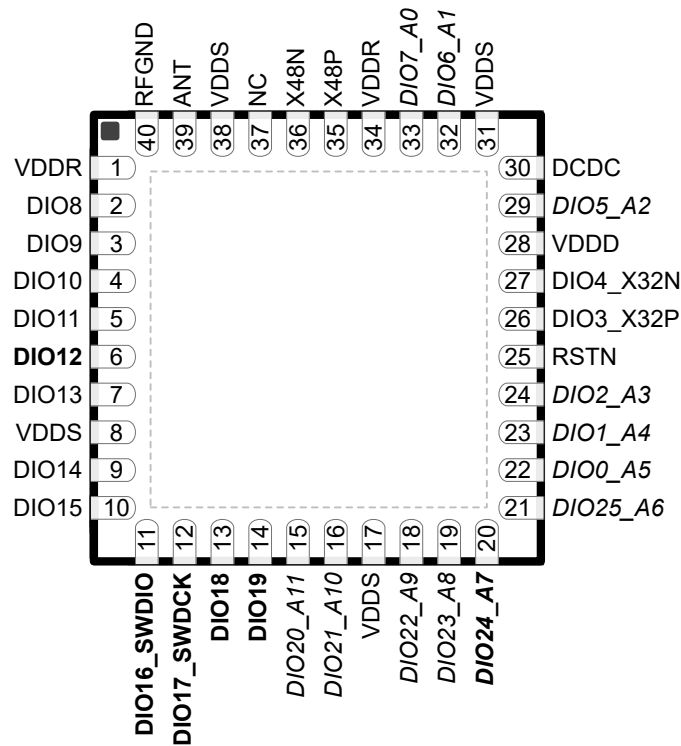

Figure 6-1. RKP (5mm × 5mm) Pinout, 0.4mm Pitch (Top View)

The following I/O pins marked in [Figure 6-1](#) in **bold** have high-drive capabilities:

- Pin 6, **DIO12**
- Pin 11, **DIO16_SWDIO**
- Pin 12, **DIO17_SWDCCK**
- Pin 13, **DIO18**
- Pin 14, **DIO19**
- Pin 20, **DIO24_A7**

The following I/O pins marked in [Figure 6-1](#) in *italics* have analog capabilities:

- Pin 15, *DIO20_A11*
- Pin 16, *DIO21_A10*
- Pin 18, *DIO22_A9*
- Pin 19, *DIO23_A8*
- Pin 20, *DIO24_A7*
- Pin 21, *DIO25_A6*
- Pin 22, *DIO0_A5*
- Pin 23, *DIO1_A4*
- Pin 24, *DIO2_A3*
- Pin 29, *DIO5_A2*
- Pin 32, *DIO6_A1*
- Pin 33, *DIO7_A0*

6.1.2 Pin Diagram—RGE Package (Top View)

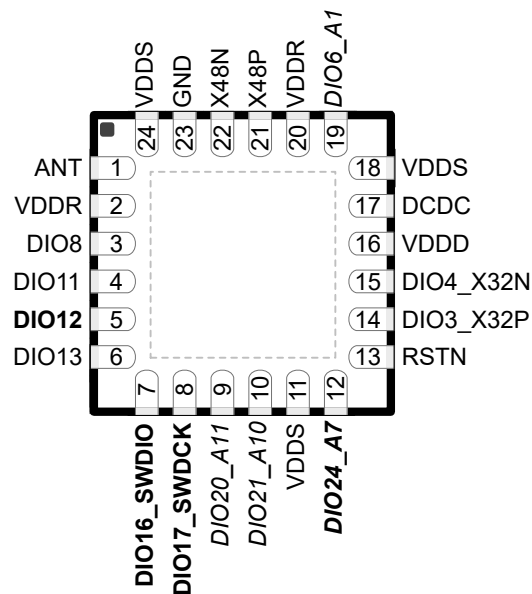

Figure 6-2. RGE (4mm × 4mm) Pinout, 0.5mm Pitch (Top View)

The following I/O pins marked in [Figure 6-2](#) in **bold** have high-drive capabilities:

- Pin 5, **DIO12**
- Pin 7, **DIO16_SWDIO**
- Pin 8, **DIO17_SWDCK**
- Pin 12, **DIO24_A7**

The following I/O pins marked in [Figure 6-2](#) in *italics* have analog capabilities:

- Pin 9, *DIO20_A11*
- Pin 10, *DIO21_A10*
- Pin 12, *DIO24_A7*
- Pin 19, *DIO6_A1*

6.1.3 Pin Diagram—YBG Package (Top View)

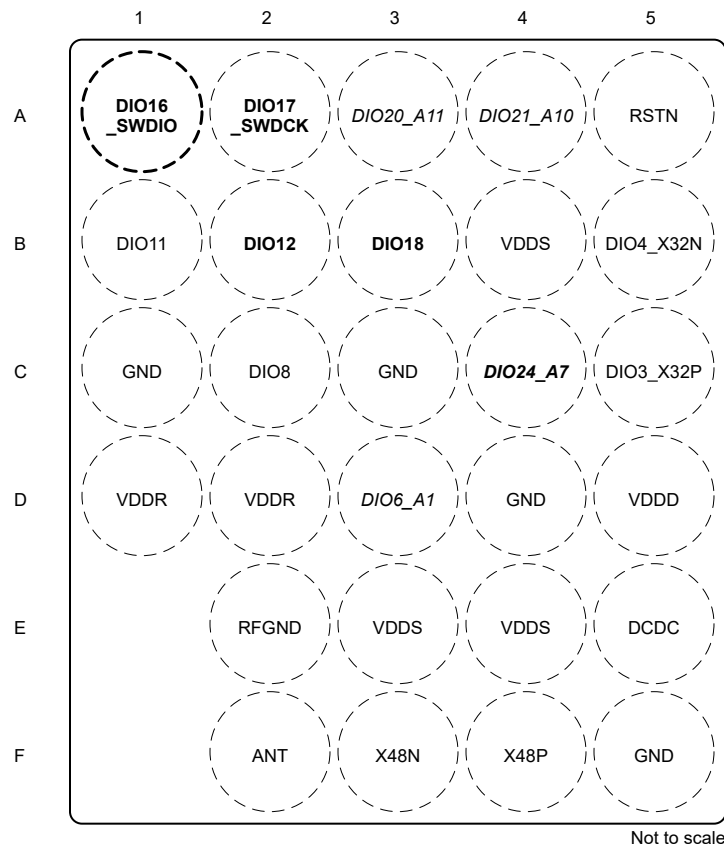

Figure 6-3. YBG (2.2mm × 2.6mm) Pinout, 0.4mm Pitch (Top View)

The following I/O pins marked in [Figure 6-2](#) in **bold** have high-drive capabilities:

- Pin B2, DIO12
- Pin A1, DIO16_SWDIO
- Pin A2, DIO17_SWDCK
- Pin B3, DIO18
- Pin C4, DIO24_A7

The following I/O pins marked in [Figure 6-2](#) in *italics* have analog capabilities:

- Pin A3, DIO20_A11
- Pin A4, DIO21_A10
- Pin C4, DIO24_A7
- Pin D3, DIO6_A1

Table 6-1. Pin Attributes (RKP, RGE, YBG Packages)

RKP PIN NUMBER	RGE PIN NUMBER	YBG PIN NUMBER	PIN NAME	SIGNAL NAME	PIN MUX ENCODING	TYPE
39	1	F2	ANT	ANT		RF
30	17	E5	DCDC	DCDC		PWR
2	3	C2	DIO8	GPIO8	0	I/O
				SPI0SCLK	1	I/O
				UART0RTS	2	I/O
				T1C0N	3	I/O
				I2C0SDA	4	I/O
				T0C0N	5	I/O
				DTB3	7	I/O
3			DIO9	GPIO9	0	I/O
				T3C0	1	I/O
				LRFD3	3	I/O
22			DIO0_A5	GPIO0	0	I/O
				SPI0CSN	1	I/O
				I2C0SDA	2	I/O
				T3C2	3	I/O
				ANA5	6	ANALOG
4			DIO10	GPIO10	0	I/O
				LPCO	1	I/O
				T2PE	2	I/O
				T3C0N	3	I/O
5	4	B1	DIO11	GPIO11	0	I/O
				SPI0CSN	1	I/O
				T1C2N	2	I/O
				T0C0	3	I/O
				LRFD0	4	I/O
				SPI0POCI	5	I/O
				DTB9	7	I/O
6	5	B2	DIO12	GPIO12	0	I/O
				SPI0POCI	1	I/O
				SPI0PICO	2	I/O
				UART0RXD	3	I/O
				T1C1	4	I/O
				I2C0SDA	5	I/O
				DTB13	7	I/O
7	6		DIO13	GPIO13	0	I/O
				SPI0POCI	1	I/O
				SPI0PICO	2	I/O
				UART0TXD	3	I/O
				T0C0N	4	I/O
				T1F	5	I/O
				DTB4	7	I/O

Table 6-1. Pin Attributes (RKP, RGE, YBG Packages) (continued)

RKP PIN NUMBER	RGE PIN NUMBER	YBG PIN NUMBER	PIN NAME	SIGNAL NAME	PIN MUX ENCODING	TYPE
9			DIO14	GPIO14	0	I/O
				T3C2	1	I/O
				T1C2N	2	I/O
				LRFD5	3	I/O
				T1F	4	I/O
10			DIO15	GPIO15	0	I/O
				UART0RXD	1	I/O
				T2C0N	2	I/O
				CKMIN	3	I/O
11	7	A1	DIO16_SWDIO	GPIO16	0	I/O
				SPI0PICO	1	I/O
				UART0RXD	2	I/O
				I2C0SDA	3	I/O
				T1C2	4	I/O
				T1C0N	5	I/O
				DTB10	7	I/O
12	8	A2	DIO17_SWDCCK	GPIO17	0	I/O
				SPI0SCLK	1	I/O
				UART0TXD	2	I/O
				I2C0SCL	3	I/O
				T1C1N	4	I/O
				T0C2	5	I/O
				DTB11	7	I/O
13		B3	DIO18	GPIO18	0	I/O
				T3C0	1	I/O
				LPCO	2	I/O
				UART0TXD	3	I/O
				SPI0SCLK	4	I/O
				DTB12	7	I/O
				14		
T3C1	1	I/O				
T2PE	2	I/O				
SPI0PICO	4	I/O				
DTB0	7	I/O				
23			DIO1_A4	GPIO1	0	I/O
				T3C1	1	I/O
				LRFD7	2	I/O
				T1F	3	I/O
				UART0RTS	4	I/O
				ANA4	6	ANALOG
				DTB2	7	I/O

Table 6-1. Pin Attributes (RKP, RGE, YBG Packages) (continued)

RKP PIN NUMBER	RGE PIN NUMBER	YBG PIN NUMBER	PIN NAME	SIGNAL NAME	PIN MUX ENCODING	TYPE
15	9	A3	DIO20_A11	GPIO20	0	I/O
				LPCO	1	I/O
				UART0TXD	2	I/O
				UART0RXD	3	I/O
				T1C0	4	I/O
				SPI0POCI	5	I/O
				ANA11	6	ANALOG
				DTB14	7	I/O
16	10	A4	DIO21_A10	GPIO21	0	I/O
				UART0CTS	1	I/O
				T1C1N	2	I/O
				T0C1	3	I/O
				SPI0POCI	4	I/O
				LRFD1	5	I/O
				ANA10	6	ANALOG
				DTB15	7	I/O
18			DIO22_A9	GPIO22	0	I/O
				T2C0	1	I/O
				UART0RXD	2	I/O
				T3C1N	3	I/O
				ANA9	6	ANALOG
				DTB1	7	I/O
19			DIO23_A8	GPIO23	0	I/O
				T2C1	1	I/O
				T3C2N	3	I/O
				ANA8	6	ANALOG
20	12	C4	DIO24_A7	GPIO24	0	I/O
				SPI0SCLK	1	I/O
				T1C0	2	I/O
				T3C0	3	I/O
				T0PE	4	I/O
				I2C0SCL	5	I/O
				ANA7	6	ANALOG
				DTB5	7	I/O
21			DIO25_16	GPIO25	0	I/O
				SPI0POCI	1	I/O
				I2C0SCL	2	I/O
				T2C2N	3	I/O
				ANA6	6	ANALOG
24			DIO2_A3	GPIO2	0	I/O
				T0PE	1	I/O
				T2C1N	2	I/O
				UART0CTS	3	I/O
				ANA3	6	ANALOG

Table 6-1. Pin Attributes (RKP, RGE, YBG Packages) (continued)

RKP PIN NUMBER	RGE PIN NUMBER	YBG PIN NUMBER	PIN NAME	SIGNAL NAME	PIN MUX ENCODING	TYPE
26	14	C5	DIO3_X32P	GPIO3	0	I/O
				LFCI	1	I/O
				T0C1N	2	I/O
				LRFD0	3	I/O
				T3C1	4	I/O
				T1C2	5	I/O
				LFXT_P	6	I/O
			DTB7	7	I/O	
27	15	B5	DIO4_X32N	GPIO4	0	I/O
				T0C2N	1	I/O
				UART0TXD	2	I/O
				LRFD1	3	I/O
				SPI0PICO	4	I/O
				T0C2	5	I/O
				LFXT_N	6	I/O
			DTB8	7	I/O	
29			DIO5_A2	GPIO5	0	I/O
				T2C2	1	I/O
				LRFD6	3	I/O
				ANA2	6	ANALOG
32	19	D3	DIO6_A1	GPIO6	0	I/O
				SPI0CSN	1	I/O
				I2C0SCL	2	I/O
				T1C2	3	I/O
				LRFD2	4	I/O
				UART0TXD	5	I/O
				ANA1	6	ANALOG
			DTB6	7	I/O	
33			DIO7_A0	GPIO7	0	I/O
				T3C1	1	I/O
				LRFD4	3	I/O
				ANA0	6	ANALOG
	23	C1, C3, D4, F5	GND	GND		GND
37			NC	NC		NC
40		E2	RFGND	RFGND		GND
25	13	A5	RSTN	RSTN		I/O
28	16	D5	VDDD	VDDD		PWR
1, 34	2, 20	D1, D2	VDDR	VDDR		PWR
17, 31, 38, 8	11, 18, 24	B4, E3, E4	VDDS	VDDS		PWR
36	22	F3	X48N	X48N		I/O
35	21	F4	X48P	X48P		I/O

6.2 Signal Descriptions

Table 6-2. Analog Input Signal Descriptions

SIGNAL NAME	PIN TYPE	DESCRIPTION	RKP PIN	RGE PIN	YBG PIN
ANA0	ANAL OG	ADC reference (negative terminal) or ADC channel 0 input ⁽¹⁾	33		
ANA1	ANAL OG	ADC reference (positive terminal) or ADC channel 1 input	32	19	D3
ANA2	ANAL OG	ADC channel 2 input	29		
ANA3	ANAL OG	ADC channel 3 input	24		
ANA4	ANAL OG	ADC channel 4 input	23		
ANA5	ANAL OG	ADC channel 5 input	22		
ANA6	ANAL OG	ADC channel 6 input	21		
ANA7	ANAL OG	Low power comparator input (positive terminal) / ADC channel 7 input	20	12	C4
ANA8	ANAL OG	Low power comparator input (positive or negative terminal) / ADC channel 8 input	19		
ANA9	ANAL OG	ADC channel 9 input	18		
ANA10	ANAL OG	Low power comparator input (positive terminal) / ADC channel 10 input	16	10	A4
ANA11	ANAL OG	ADC channel 11 input	15	9	A3

(1) ADC VREF– (external reference negative terminal) is connected directly to ground in the RGE package. ADC VREF– is not connected in the WCSP (YBG) package so external reference is not available with the YBG package.

Table 6-3. Clock Signal Descriptions

SIGNAL NAME	PIN TYPE	DESCRIPTION	RKP PIN	RGE PIN	YBG PIN
CKMIN	I/O	HFOSC tracking loop input	10		
LFCI	I/O	Low frequency clock input (LFXT bypass clock from pin)	26	14	C5
LFXT_N	I/O	32kHz crystal oscillator pin 2	27	15	B5
LFXT_P	I/O	32kHz crystal oscillator pin 1	26	14	C5
X48N	I/O	48MHz crystal oscillator pin 2	36	22	F3
X48P	I/O	48MHz crystal oscillator pin 1	35	21	F4

Table 6-4. DTB Signal Descriptions

SIGNAL NAME	PIN TYPE	DESCRIPTION	RKP PIN	RGE PIN	YBG PIN
DTB0	I/O	Digital test bus output 0	14		
DTB1	I/O	Digital test bus output 1	18		
DTB2	I/O	Digital test bus output 2	23		
DTB3	I/O	Digital test bus output 3	2	3	C2
DTB4	I/O	Digital test bus output 4	7	6	
DTB5	I/O	Digital test bus output 5	20	12	C4
DTB6	I/O	Digital test bus output6	32	19	D3

Table 6-4. DTB Signal Descriptions (continued)

SIGNAL NAME	PIN TYPE	DESCRIPTION	RKP PIN	RGE PIN	YBG PIN
DTB7	I/O	Digital test bus output 7	26	14	C5
DTB8	I/O	Digital test bus output 8	27	15	B5
DTB9	I/O	Digital test bus output 9	5	4	B1
DTB10	I/O	Digital test bus output 10	11	7	A1
DTB11	I/O	Digital test bus output 11	12	8	A2
DTB12	I/O	Digital test bus output 12	13		B3
DTB13	I/O	Digital test bus output 13	6	5	B2
DTB14	I/O	Digital test bus output 14	15	9	A3
DTB15	I/O	Digital test bus output 15	16	10	A4

Table 6-5. GPIO Signal Descriptions

SIGNAL NAME	PIN TYPE	DESCRIPTION	RKP PIN	RGE PIN	YBG PIN
GPIO0	I/O	General-purpose input or output	22		
GPIO1	I/O	General-purpose input or output	23		
GPIO2	I/O	General-purpose input or output	24		
GPIO3	I/O	General-purpose input or output	26	14	C5
GPIO4	I/O	General-purpose input or output	27	15	B5
GPIO5	I/O	General-purpose input or output	29		
GPIO6	I/O	General-purpose input or output	32	19	D3
GPIO7	I/O	General-purpose input or output	33		
GPIO8	I/O	General-purpose input or output	2	3	C2
GPIO9	I/O	General-purpose input or output	3		
GPIO10	I/O	General-purpose input or output	4		
GPIO11	I/O	General-purpose input or output	5	4	B1
GPIO12	I/O	General-purpose input or output	6	5	B2
GPIO13	I/O	General-purpose input or output	7	6	
GPIO14	I/O	General-purpose input or output	9		
GPIO15	I/O	General-purpose input or output	10		
GPIO16	I/O	General-purpose input or output	11	7	A1
GPIO17	I/O	General-purpose input or output	12	8	A2
GPIO18	I/O	General-purpose input or output	13		B3
GPIO19	I/O	General-purpose input or output	14		
GPIO20	I/O	General-purpose input or output	15	9	A3
GPIO21	I/O	General-purpose input or output	16	10	A4
GPIO22	I/O	General-purpose input or output	18		
GPIO23	I/O	General-purpose input or output	19		
GPIO24	I/O	General-purpose input or output	20	12	C4
GPIO25	I/O	General-purpose input or output	21		

Table 6-6. Device Grounds

SIGNAL NAME	PIN TYPE	DESCRIPTION	RKP PIN	RGE PIN	YBG PIN
GND	GND	Ground		23	C1, C3, D4, F5
RFGND	GND	RF ground reference	40		E2

Table 6-7. I2C Signal Descriptions

SIGNAL NAME	PIN TYPE	DESCRIPTION	RKP PIN	RGE PIN	YBG PIN
I2C0SCL	I/O	I2C clock	12, 20, 21, 32	12, 19, 8	A2, C4, D3
I2C0SDA	I/O	I2C data	11, 2, 22, 6	3, 5, 7	A1, B2, C2

Table 6-8. Low Power Comparator Output Signal Descriptions

SIGNAL NAME	PIN TYPE	DESCRIPTION	RKP PIN	RGE PIN	YBG PIN
LPCO	I/O	Low power comparator output	13, 15, 4	9	A3, B3

Table 6-9. No Connect

SIGNAL NAME	PIN TYPE	DESCRIPTION	RKP PIN	RGE PIN	YBG PIN
NC	NC	No connect	37		

Table 6-10. Device Power

SIGNAL NAME	PIN TYPE	DESCRIPTION	RKP PIN	RGE PIN	YBG PIN
DCDC ⁽¹⁾	PWR	Switch node of the internal DC/DC converter	30	17	E5
VDDD ⁽¹⁾	PWR	Internal 1.28V regulator decoupling capacitor	28	16	D5
VDDR	PWR	Internal supply, must be powered from the internal DC/DC converter or the internal LDO	1, 34	2, 20	D1, D2
VDDS	PWR	1.71V to 3.8V supply	17, 31, 38, 8	11, 18, 24	B4, E3, E4

(1) Do not supply external circuitry from this pin.

Table 6-11. Reset Signal Descriptions

SIGNAL NAME	PIN TYPE	DESCRIPTION	RKP PIN	RGE PIN	YBG PIN
RSTN	I/O	Global main device reset (active low)	25	13	A5

Table 6-12. Radio Digital Output Signal Descriptions

SIGNAL NAME	PIN TYPE	DESCRIPTION	RKP PIN	RGE PIN	YBG PIN
LRFD0	I/O	Radio Core Output 0	26, 5	14, 4	B1, C5
LRFD1	I/O	Radio Core Output 1	16, 27	10, 15	A4, B5
LRFD2	I/O	Radio Core Output 2	32	19	D3
LRFD3	I/O	Radio Core Digital Output 3	3		
LRFD4	I/O	Radio Core Output 4	33		
LRFD5	I/O	Radio Core Output 5	9		
LRFD6	I/O	Radio Core Output 6	29		
LRFD7	I/O	Radio Core Output 7	23		

Table 6-13. RF Port

SIGNAL NAME	PIN TYPE	DESCRIPTION	RKP PIN	RGE PIN	YBG PIN
ANT	RF	50Ohm RF port	39	1	F2

Table 6-14. SPI Signal Descriptions

SIGNAL NAME	PIN TYPE	DESCRIPTION	RKP PIN	RGE PIN	YBG PIN
SPI0CSN	I/O	SPI chip select	22, 32, 5	19, 4	B1, D3
SPI0PICO	I/O	SPI peripheral in controller out	11, 14, 27, 6, 7	15, 5, 6, 7	A1, B2, B5
SPI0POCI	I/O	SPI peripheral out controller in	15, 16, 21, 5, 6, 7	10, 4, 5, 6, 9	A3, A4, B1, B2
SPI0SCLK	I/O	SPI clock	12, 13, 2, 20	12, 3, 8	A2, B3, C2, C4

Table 6-15. Timers Capture or Compare Signal Descriptions

SIGNAL NAME	PIN TYPE	DESCRIPTION	RKP PIN	RGE PIN	YBG PIN
T0C0	I/O	Capture or compare 0 from timer 0	5	4	B1
T0C1	I/O	Capture or compare 1 from timer 0	16	10	A4
T0C2	I/O	Capture or compare 2 from timer 0	12, 27	15, 8	A2, B5
T1C0	I/O	Capture or compare 0 from timer 1	15, 20	12, 9	A3, C4
T1C1	I/O	Capture or compare 1 from timer 1	6	5	B2
T1C2	I/O	Capture or compare 2 from timer 1	11, 26, 32	14, 19, 7	A1, C5, D3
T2C0	I/O	Capture or compare output 0 from timer 2	18		
T2C1	I/O	Capture or compare 1 from timer 2	19		
T2C2	I/O	Capture or compare 2 from timer 2	29		
T3C0 ⁽¹⁾	I/O	Capture or compare 0 from timer 3	13, 20, 3	12	B3, C4
T3C1 ⁽¹⁾	I/O	Capture or compare 1 from timer 3	14, 23, 26, 33	14	C5
T3C2	I/O	Capture or compare 2 from timer 3	22, 9		

(1) Timer 3 not available on CC2340R21.

Table 6-16. Timers Complementary Output Signal Descriptions

SIGNAL NAME	PIN TYPE	DESCRIPTION	RKP PIN	RGE PIN	YBG PIN
T0C0N	I/O	Complementary compare or PWM output 0 from timer 0	2, 7	3, 6	C2
T0C1N	I/O	Complementary compare or PWM output 1 from timer 0	26	14	C5
T0C2N	I/O	Complementary compare or PWM output 2 from timer 0	27	15	B5
T1C0N	I/O	Complementary compare or PWM output 0 from timer 1	11, 2	3, 7	A1, C2
T1C1N	I/O	Complementary compare or PWM output 1 from timer 1	12, 16	10, 8	A2, A4
T1C2N	I/O	Complementary compare or PWM output 2 from timer 0	5, 9	4	B1
T2C0N	I/O	Complementary compare or PWM output 0 from timer 2	10		
T2C1N	I/O	Complementary compare or PWM output 1 from timer 2	24		
T2C2N	I/O	Complementary compare or PWM output 2 from timer 2	21		
T3C0N	I/O	Complementary compare or PWM output 0 from timer 3	4		
T3C1N	I/O	Complementary compare or PWM output 1 from timer 3	18		

Table 6-16. Timers Complementary Output Signal Descriptions (continued)

SIGNAL NAME	PIN TYPE	DESCRIPTION	RKP PIN	RGE PIN	YBG PIN
T3C2N	I/O	Complementary compare or PWM output 2 from timer 3	19		

Table 6-17. Timers Fault Input Signal Descriptions

SIGNAL NAME	PIN TYPE	DESCRIPTION	RKP PIN	RGE PIN	YBG PIN
T1F	I/O	Fault input for timer 1	23, 7, 9	6	

Table 6-18. Timers Prescaler Event Signal Descriptions

SIGNAL NAME	PIN TYPE	DESCRIPTION	RKP PIN	RGE PIN	YBG PIN
T0PE	I/O	Prescaler event output from timer 0	20, 24	12	C4
T2PE	I/O	Prescaler event output from timer 2	14, 4		

Table 6-19. UART Signal Descriptions

SIGNAL NAME	PIN TYPE	DESCRIPTION	RKP PIN	RGE PIN	YBG PIN
UART0CTS	I/O	UART clear-to-send input (active low)	16, 24	10	A4
UART0RTS	I/O	UART request-to-send (active low)	2, 23	3	C2
UART0RXD	I/O	UART receive data	10, 11, 15, 18, 6	5, 7, 9	A1, A3, B2
UART0TXD	I/O	UART transmit data	12, 13, 15, 27, 32, 7	15, 19, 6, 8, 9	A2, A3, B3, B5, D3

6.3 Connections for Unused Pins and Modules

Table 6-20. Connections for Unused Pins

FUNCTION	SIGNAL NAME	ACCEPTABLE PRACTICE ⁽¹⁾	PREFERRED PRACTICE ⁽¹⁾
GPIO (digital)	DIO _n	NC, GND, or VDD5	NC
SWD	DIO16_SWDIO	NC, GND, or VDD5	GND or VDD5
	DIO17_SWDCK	NC, GND, or VDD5	GND or VDD5
GPIO (digital or analog)	DIO _n _Am	NC, GND, or VDD5	NC
32.768-kHz crystal	DIO3_X32P	NC or GND	NC
	DIO4_X32N		
DC/DC converter ⁽²⁾	DCDC	NC	NC
	VDD5	VDD5	VDD5

(1) NC = No connect

(2) When the DC/DC converter is not used, the inductor between DCDC and VDDR can be removed. VDDR must still be connected, and the 10µF DCDC capacitor must be kept on the VDDR net.

7 Specifications

7.1 Absolute Maximum Ratings

over operating free-air temperature range (unless otherwise noted)^{(1) (2)}

		MIN	MAX	UNIT
V _{DDS}	Supply voltage	-0.3	4.1	V
	Voltage on any digital pin ⁽³⁾	-0.3	V _{DDS} + 0.3, max 4.1	V
	Voltage on crystal oscillator pins X48P and X48N	-0.3	1.24	V
V _{in_adc}	Voltage on ADC input	0	V _{DDS}	V
	Input level, RF pins		5	dBm
T _{stg}	Storage temperature	-40	150	°C

- Operation outside the Absolute Maximum Ratings may cause permanent device damage. Absolute Maximum Ratings do not imply functional operation of the device at these or any other conditions beyond those listed under Recommended Operating Conditions. If outside the Recommended Operating Conditions but within the Absolute Maximum Ratings, the device may not be fully functional, and this may affect device reliability, functionality, performance, and shorten the device lifetime.
- All voltage values are with respect to ground, unless otherwise noted.
- Including analog capable DIOs.

7.2 ESD Ratings

			VALUE	UNIT	
V _{ESD}	Electrostatic discharge	Human body model (HBM), per ANSI/ESDA/JEDEC JS-001 ⁽¹⁾	All pins	±1000	V
		Charged device model (CDM), per ANSI/ESDA/JEDEC JS-002 ⁽²⁾	All pins	±500	V

- JEDEC document JEP155 states that 500V HBM allows safe manufacturing with a standard ESD control process.
- JEDEC document JEP157 states that 250V CDM allows safe manufacturing with a standard ESD control process.

7.3 Recommended Operating Conditions

over operating free-air temperature range (unless otherwise noted)

		MIN	MAX	UNIT
CC2340xxxExxxxx devices (125°C parts)	Operating ambient temperature ^{(1) (2)}	-40	125	°C
	Operating junction temperature ^{(1) (2)}	-40	125	°C
CC2340xxxNxxxxx devices (85°C parts)	Operating ambient temperature ^{(1) (2)}	-40	85	°C
	Operating junction temperature ^{(1) (2)}	-40	85	°C
Operating supply voltage (V _{DDS})		1.71	3.8	V
Rising supply voltage slew rate		0	100	mV/μs
Falling supply voltage slew rate ⁽³⁾		0	1	mV/μs

- Operation at or near maximum operating temperature for extended durations will result in a reduction in lifetime.
- For thermal resistance details, refer to *Thermal Resistance Characteristics* table in this document.
- For small coin-cell batteries, with high worst-case end-of-life equivalent source resistance, a 10μF V_{DDS} input capacitor must be used to ensure compliance with this slew rate.

7.4 DCDC

When measured on the CC2340R5 reference design with T_c = 25°C and DCDC enabled unless otherwise noted.

PARAMETER	TEST CONDITIONS	MIN	TYP	MAX	UNIT
V _{DDS} supply voltage for DCDC operation ^{(1) (2)}		2.2	3.0	3.8	V

- When the supply voltage drops below the DCDC operation min voltage, the device automatically transitions to use GLDO regulator on-chip.
- A 10μH and 10μF load capacitor are required on the V_{DDR} voltage rail. They must be placed close to the DCDC output pin.

7.5 Global LDO (GLDO)

When measured on the CC2340R5 reference design with $T_c = 25^\circ\text{C}$

PARAMETER	TEST CONDITIONS	MIN	TYP	MAX	UNIT
VDDS supply voltage for GLDO operation ⁽¹⁾		1.71	3.0	3.8	V

(1) A 10 μF capacitor is recommended at VDDR pin.

7.6 Power Supply and Modules

over operating free-air temperature range (unless otherwise noted)

PARAMETER	TEST CONDITIONS	MIN	TYP	MAX	UNIT
VDDS_BOD					
Brownout rising threshold ⁽¹⁾			1.68		V
Brownout falling threshold ⁽¹⁾			1.67		V
POR					
power-on reset power-up level			1.5		V
power-on reset power-down level			1.45		V

(1) Brown-out Detector is trimmed at initial boot, value is kept until device is reset by a POR reset or the RSTN pin.

7.7 Battery Monitor

Measured on the CC2340R5 reference design with $T_c = 25^\circ\text{C}$, unless otherwise noted

PARAMETER	TEST CONDITIONS	MIN	TYP	MAX	UNIT
Resolution			22		mV
Range		1.7		3.8	V
Accuracy	VDDS = 3.0V		30		mV

7.8 Temperature Sensor

Measured on the CC2340R5 reference design with $T_c = 25^\circ\text{C}$, $V_{\text{DDS}} = 3.0\text{V}$, unless otherwise noted.

PARAMETER	TEST CONDITIONS	MIN	TYP	MAX	UNIT
CC2340xxxExxxxx devices (125 $^\circ\text{C}$ devices)					
Accuracy	-40 $^\circ\text{C}$ to 125 $^\circ\text{C}$		-15/+9 ⁽¹⁾		$^\circ\text{C}$
CC2340xxxNxxxxx devices (85 $^\circ\text{C}$ devices)					
Accuracy	-40 $^\circ\text{C}$ to 85 $^\circ\text{C}$		± 10 ⁽¹⁾		$^\circ\text{C}$

(1) Raw output from register.

7.9 Power Consumption–Power Modes

When measured on the CC2340R5 reference design with $T_c = 25^\circ\text{C}$, $V_{\text{DDS}} = 3.0\text{V}$, DCDC enabled, GLDO disabled, unless otherwise noted

PARAMETER	TEST CONDITIONS	MIN	TYP	MAX	UNIT
Core Current Consumption with DCDC					
I_{core}	Active	MCU running CoreMark from Flash at 48MHz		2.6	mA
I_{core}	Active	MCU running CoreMark from Flash at 48MHz		53	$\mu\text{A} / \text{MHz}$
I_{core}	Idle	Supply Systems and RAM powered, flash disabled, DMA disabled		0.8	mA
I_{core}	Idle	Supply Systems and RAM powered, flash disabled, DMA enabled		0.8	mA
I_{core}	Idle	Supply Systems and RAM powered, flash enabled, DMA disabled		1.1	mA
I_{core}	Idle	Supply Systems and RAM powered, flash enabled, DMA enabled		1.2	mA
I_{core}	Standby	RTC running, full RAM retention LFOSC, DCDC recharge current setting (ipeak = 1)		0.71	μA
I_{core}	Standby	RTC running, full RAM retention LFXT, DCDC recharge current setting (ipeak = 1)		0.74	μA
Core Current consumption with GLDO					

7.9 Power Consumption–Power Modes (continued)

When measured on the CC2340R5 reference design with $T_c = 25^\circ\text{C}$, $V_{\text{DD5}} = 3.0\text{V}$, DCDC enabled, GLDO disabled, unless otherwise noted

PARAMETER		TEST CONDITIONS	MIN	TYP	MAX	UNIT
I_{core}	Active	MCU running CoreMark from Flash at 48MHz		4.1		mA
I_{core}	Idle	Supply Systems and RAM powered, flash disabled, DMA disabled		1.2		mA
I_{core}	Idle	Supply Systems and RAM powered, flash disabled, DMA enabled		1.3		mA
I_{core}	Idle	Supply Systems and RAM powered, flash enabled, DMA disabled		1.5		mA
I_{core}	Idle	Supply Systems and RAM powered, flash enabled, DMA enabled		1.7		mA
I_{core}	Standby	RTC running, full RAM retention LFOSC, default GLDO recharge current setting		1.1		μA
I_{core}	Standby	RTC running, full RAM retention LFXT default GLDO recharge current setting		1.15		μA
Reset, Shutdown Current Consumption						
I_{core}	Reset	Reset. RSTN pin asserted or VDD5 below power-on-reset threshold		165		nA
I_{core}	Shutdown	Shutdown measured in steady state. No clocks running, no retention, IO wakeup enabled		165		nA
Peripheral Current Consumption						
I_{peri}	RF	Delta current, clock enabled, RF subsystem idle		40		μA
I_{peri}	Timers	Delta current with clock enabled, module is idle, one LGPT timer		2.4		μA
I_{peri}	I2C	Delta current with clock enabled, module is idle		10.6		μA
I_{peri}	SPI	Delta current with clock enabled, module is idle		3.4		μA
I_{peri}	UART	Delta current with clock enabled, module is idle		24.5		μA
I_{peri}	CRYPTO (AES)	Delta current with clock enabled, module is idle		3.8		μA

7.10 Power Consumption–Radio Modes

When measured on the CC2340R5 reference design with $T_c = 25^\circ\text{C}$, $V_{\text{DD5}} = 3.0\text{V}$ with DCDC enabled unless otherwise noted

PARAMETER		TEST CONDITIONS	MIN	TYP	MAX	UNIT
I_{RX}	Radio receive current	2440MHz, 1Mbps, GFSK, system bus off ⁽¹⁾		5.3		mA
I_{RX}	Radio receive current	2440MHz, 1Mbps, GFSK, DCDC OFF, system bus off ⁽¹⁾		9		mA
I_{TX}	Radio transmit current	-8dBm output power setting 2440MHz system bus off ⁽¹⁾		4.5		mA
I_{TX}	Radio transmit current	0dBm output power setting 2440MHz system bus off ⁽¹⁾		5.1		mA
I_{TX}	Radio transmit current	0dBm output power setting 2440MHz DCDC OFF, system bus off ⁽¹⁾		9.0		mA
I_{TX}	Radio transmit current	+4dBm output power setting 2440MHz system bus off ⁽¹⁾		7.9		mA
I_{TX}	Radio transmit current	+6dBm output power setting 2440MHz system bus off ⁽¹⁾		8.9		mA
I_{TX}	Radio transmit current	+8dBm output power setting 2440MHz system bus off ⁽¹⁾		10.7		mA
I_{TX}	Radio transmit current	+8dBm output power setting 2440MHz DCDC OFF, system bus off ⁽¹⁾		19		mA

(1) System bus off refers to device idle mode, DMA disabled, Flash disabled

7.11 Nonvolatile (Flash) Memory Characteristics

Over operating free-air temperature range and $V_{\text{DD5}} = 3.0\text{V}$ (unless otherwise noted)

PARAMETER	TEST CONDITIONS	MIN	TYP	MAX	UNIT
Flash sector size			2		KB
Supported flash erase cycles before failure, full bank ^{(1) (2)}		30			k Cycles
Supported flash erase cycles before failure, single sector ⁽³⁾		60			k Cycles

7.11 Nonvolatile (Flash) Memory Characteristics (continued)

Over operating free-air temperature range and $V_{DD5} = 3.0V$ (unless otherwise noted)

PARAMETER	TEST CONDITIONS	MIN	TYP	MAX	UNIT
Maximum number of write operations per row before sector erase ⁽⁴⁾				83	Write Operations
CC2340xxxExxxxx devices (125°C devices)					
Flash retention	105°C	11.4			Years
Flash retention	125°C	10			Years
CC2340xxxNxxxxx devices (85°C devices)					
Flash retention	85°C	11.4			Years
Flash sector erase current	Average delta current		1.2		mA
Flash sector erase time ⁽⁵⁾	0 erase cycles		2.2		ms
Flash write current	Average delta current, full sector at a time		1.7		mA
Flash write time ⁽⁵⁾	full sector (2kB) at a time, 0 erase cycles		8.3		ms

- (1) A full bank erase is counted as a single erase cycle on each sector.
- (2) Aborting flash during erase or program modes is not a safe operation.
- (3) Up to 16 customer-designated sectors can be individually erased an additional 30k times beyond the baseline bank limitation of 30k cycles.
- (4) Each wordline is 2048 bits (or 256 bytes) wide. This limitation corresponds to sequential memory writes of 4 (3.1) bytes minimum per write over a whole wordline. If additional writes to the same wordline are required, a sector erase is required once the maximum number of write operations per row is reached.
- (5) This number is dependent on Flash aging and increases over time and erase cycles.

7.12 Thermal Resistance Characteristics

THERMAL METRIC	THERMAL METRIC ⁽²⁾	PACKAGE			UNIT ⁽¹⁾
		RKP (VQFN)	RGE (VQFN)	YBG (WCSP)	
		40 PINS	24 PINS	28 PINS	
$R_{\theta JA}$	Junction-to-ambient thermal resistance	31.8	40.1	61.4	°C/W
$R_{\theta JC(top)}$	Junction-to-case (top) thermal resistance	23.1	30.5	0.3	°C/W
$R_{\theta JB}$	Junction-to-board thermal resistance	12.7	17.2	14.2	°C/W
Ψ_{JT}	Junction-to-top characterization parameter	0.3	0.4	0.2	°C/W
Ψ_{JB}	Junction-to-board characterization parameter	12.7	17.1	14	°C/W
$R_{\theta JC(bot)}$	Junction-to-case (bottom) thermal resistance	3.3	3.4	No thermal pad	°C/W

- (1) °C/W = degrees Celsius per watt.
- (2) For more information about traditional and new thermal metrics, see [Semiconductor and IC Package Thermal Metrics](#).

7.13 RF Frequency Bands

Over operating free-air temperature range (unless otherwise noted).

PARAMETER	MIN	TYP	MAX	UNIT
Frequency bands	2360		2510	MHz

7.14 Bluetooth Low Energy–Receive (RX)

When measured on the CC2340R5 reference design with $T_c = 25^\circ C$, $V_{DD5} = 3.0V$, $f_{RF} = 2440MHz$ with DCDC enabled unless otherwise noted. All measurements are performed at the antenna input with a combined RX and TX path. All measurements are performed conducted.

PARAMETER	TEST CONDITIONS	MIN	TYP	MAX	UNIT
125kbps (LE Coded)					
Receiver sensitivity	BER = 10^{-3}		-102		dBm
Receiver saturation	BER = 10^{-3}		5		dBm
Frequency error tolerance	Difference between the incoming carrier frequency and the internally generated carrier frequency		> (-250/ 250) ⁽¹⁾		kHz

7.14 Bluetooth Low Energy–Receive (RX) (continued)

When measured on the CC2340R5 reference design with $T_c = 25^\circ\text{C}$, $V_{\text{DDS}} = 3.0\text{V}$, $f_{\text{RF}} = 2440\text{MHz}$ with DCDC enabled unless otherwise noted. All measurements are performed at the antenna input with a combined RX and TX path. All measurements are performed conducted.

PARAMETER	TEST CONDITIONS	MIN	TYP	MAX	UNIT
Data rate error tolerance	Difference between incoming data rate and the internally generated data rate (37-byte packets)		> (-90 / 90) ⁽¹⁾		ppm
Data rate error tolerance	Difference between incoming data rate and the internally generated data rate (255-byte packets)		> (-90 / 90) ⁽¹⁾		ppm
Co-channel rejection ⁽²⁾	Wanted signal at -79dBm, modulated interferer in channel, BER = 10^{-3}		-6		dB
Selectivity, $\pm 1\text{MHz}$ ⁽²⁾	Wanted signal at -79dBm, modulated interferer at $\pm 1\text{MHz}$, BER = 10^{-3}		9 / 5 ⁽³⁾		dB
Selectivity, $\pm 2\text{MHz}$ ⁽²⁾	Wanted signal at -79dBm, modulated interferer at $\pm 2\text{MHz}$, BER = 10^{-3}		44 / 31 ⁽³⁾		dB
Selectivity, $\pm 3\text{MHz}$ ⁽²⁾	Wanted signal at -79dBm, modulated interferer at $\pm 3\text{MHz}$, BER = 10^{-3}		47 / 42 ⁽³⁾		dB
Selectivity, $\pm 4\text{MHz}$ ⁽²⁾	Wanted signal at -79dBm, modulated interferer at $\pm 4\text{MHz}$, BER = 10^{-3}		49 / 45 ⁽³⁾		dB
Selectivity, $\pm 6\text{MHz}$ ⁽²⁾	Wanted signal at -79dBm, modulated interferer at $\geq \pm 6\text{MHz}$, BER = 10^{-3}		52 / 48 ⁽³⁾		dB
Selectivity, $\pm 7\text{MHz}$	Wanted signal at -79dBm, modulated interferer at $\geq \pm 7\text{MHz}$, BER = 10^{-3}		54 / 49 ⁽³⁾		dB
Selectivity, Image frequency ⁽²⁾	Wanted signal at -79dBm, modulated interferer at image frequency, BER = 10^{-3}		31		dB
Selectivity, Image frequency $\pm 1\text{MHz}$ ⁽²⁾	Note that Image frequency + 1MHz is the Co- channel - 1MHz. Wanted signal at -79dBm, modulated interferer at $\pm 1\text{MHz}$ from image frequency, BER = 10^{-3}		5 / 42 ⁽³⁾		dB
500kbps (LE Coded)					
Receiver sensitivity	BER = 10^{-3}		-99		dBm
Receiver saturation	BER = 10^{-3}		5		dBm
Frequency error tolerance	Difference between the incoming carrier frequency and the internally generated carrier frequency		> (-250 / 250) ⁽¹⁾		kHz
Data rate error tolerance	Difference between incoming data rate and the internally generated data rate (37-byte packets)		> (-90 / 90) ⁽¹⁾		ppm
Data rate error tolerance	Difference between incoming data rate and the internally generated data rate (255-byte packets)		> (-90 / 90) ⁽¹⁾		ppm
Co-channel rejection ⁽²⁾	Wanted signal at -72dBm, modulated interferer in channel, BER = 10^{-3}		-4.5		dB
Selectivity, $\pm 1\text{MHz}$ ⁽²⁾	Wanted signal at -72dBm, modulated interferer at $\pm 1\text{MHz}$, BER = 10^{-3}		9 / 5 ⁽³⁾		dB
Selectivity, $\pm 2\text{MHz}$ ⁽²⁾	Wanted signal at -72dBm, modulated interferer at $\pm 2\text{MHz}$, BER = 10^{-3}		42 / 31 ⁽³⁾		dB
Selectivity, $\pm 3\text{MHz}$ ⁽²⁾	Wanted signal at -72dBm, modulated interferer at $\pm 3\text{MHz}$, BER = 10^{-3}		45 / 41 ⁽³⁾		dB
Selectivity, $\pm 4\text{MHz}$ ⁽²⁾	Wanted signal at -72dBm, modulated interferer at $\pm 4\text{MHz}$, BER = 10^{-3}		46 / 42 ⁽³⁾		dB
Selectivity, $\pm 6\text{MHz}$ ⁽²⁾	Wanted signal at -72dBm, modulated interferer at $\geq \pm 6\text{MHz}$, BER = 10^{-3}		50 / 45 ⁽³⁾		dB
Selectivity, $\pm 7\text{MHz}$	Wanted signal at -72dBm, modulated interferer at $\geq \pm 7\text{MHz}$, BER = 10^{-3}		51 / 46 ⁽³⁾		dB
Selectivity, Image frequency ⁽²⁾	Wanted signal at -72dBm, modulated interferer at image frequency, BER = 10^{-3}		31		dB
Selectivity, Image frequency $\pm 1\text{MHz}$ ⁽²⁾	Note that Image frequency + 1MHz is the Co- channel - 1MHz. Wanted signal at -72dBm, modulated interferer at $\pm 1\text{MHz}$ from image frequency, BER = 10^{-3}		5 / 41 ⁽³⁾		dB
1Mbps (LE 1M)					
Receiver sensitivity	BER = 10^{-3}		-96.5		dBm
Receiver saturation	BER = 10^{-3}		5		dBm

7.14 Bluetooth Low Energy–Receive (RX) (continued)

When measured on the CC2340R5 reference design with $T_c = 25^\circ\text{C}$, $V_{\text{DDS}} = 3.0\text{V}$, $f_{\text{RF}} = 2440\text{MHz}$ with DCDC enabled unless otherwise noted. All measurements are performed at the antenna input with a combined RX and TX path. All measurements are performed conducted.

PARAMETER	TEST CONDITIONS	MIN	TYP	MAX	UNIT
Frequency error tolerance	Difference between the incoming carrier frequency and the internally generated carrier frequency		$> (-250/250)^{(1)}$		kHz
Data rate error tolerance	Difference between incoming data rate and the internally generated data rate (37-byte packets)		$> (-90 / 90)^{(1)}$		ppm
Co-channel rejection ⁽²⁾	Wanted signal at -67dBm , modulated interferer in channel, BER = 10^{-3}		-6		dB
Selectivity, $\pm 1\text{MHz}^{(2)}$	Wanted signal at -67dBm , modulated interferer at $\pm 1\text{MHz}$, BER = 10^{-3}		7 / 5 ⁽³⁾		dB
Selectivity, $\pm 2\text{MHz}^{(2)}$	Wanted signal at -67dBm , modulated interferer at $\pm 2\text{MHz}$, BER = 10^{-3}		39 / 28 ⁽³⁾		dB
Selectivity, $\pm 3\text{MHz}^{(2)}$	Wanted signal at -67dBm , modulated interferer at $\pm 3\text{MHz}$, BER = 10^{-3}		38 / 38 ⁽³⁾		dB
Selectivity, $\pm 4\text{MHz}^{(2)}$	Wanted signal at -67dBm , modulated interferer at $\pm 4\text{MHz}$, BER = 10^{-3}		47 / 35 ⁽³⁾		dB
Selectivity, $\pm 5\text{MHz}$ or more ⁽²⁾	Wanted signal at -67dBm , modulated interferer at $\geq \pm 5\text{MHz}$, BER = 10^{-3}		40		dB
Selectivity, image frequency ⁽²⁾	Wanted signal at -67dBm , modulated interferer at image frequency, BER = 10^{-3}		28		dB
Selectivity, image frequency $\pm 1\text{MHz}^{(2)}$	Note that Image frequency + 1MHz is the co-channel - 1MHz. Wanted signal at -67dBm , modulated interferer at $\pm 1\text{MHz}$ from image frequency, BER = 10^{-3}		5 / 38 ⁽³⁾		dB
Out-of-band blocking ⁽⁴⁾	30MHz to 2000MHz		-10		dBm
Out-of-band blocking	2003MHz to 2399MHz		-10		dBm
Out-of-band blocking	2484MHz to 2997MHz		-10		dBm
Out-of-band blocking	3000MHz to 12.75GHz (excluding VCO frequency)		-2		dBm
Intermodulation	Wanted signal at 2402MHz, -64dBm . Two interferers at 2405 and 2408MHz respectively, at the given power level		-37		dBm
Spurious emissions, 30 to 1000MHz ⁽⁵⁾	Measurement in a 50 Ω single-ended load.		< -59		dBm
Spurious emissions, 1 to 12.75GHz ⁽⁵⁾	Measurement in a 50 Ω single-ended load.		< -47		dBm
RSSI dynamic range ⁽⁶⁾			70		dB
RSSI accuracy			± 4		dB
RSSI resolution			1		dB
2Mbps (LE 2M)					
Receiver sensitivity	Measured at SMA connector, BER = 10^{-3}		-92		dBm
Receiver saturation	Measured at SMA connector, BER = 10^{-3}		2		dBm
Frequency error tolerance	Difference between the incoming carrier frequency and the internally generated carrier frequency		$> (-250 / 250)^{(1)}$		kHz
Data rate error tolerance	Difference between incoming data rate and the internally generated data rate (37-byte packets)		$> (-90/ 90)^{(1)}$		ppm
Co-channel rejection ⁽²⁾	Wanted signal at -67dBm , modulated interferer in channel, BER = 10^{-3}		-8		dB
Selectivity, $\pm 2\text{MHz}^{(2)}$	Wanted signal at -67dBm , modulated interferer at $\pm 2\text{MHz}$, Image frequency is at -2MHz , BER = 10^{-3}		9 / 5 ⁽³⁾		dB
Selectivity, $\pm 4\text{MHz}^{(2)}$	Wanted signal at -67dBm , modulated interferer at $\pm 4\text{MHz}$, BER = 10^{-3}		40 / 32 ⁽³⁾		dB
Selectivity, $\pm 6\text{MHz}^{(2)}$	Wanted signal at -67dBm , modulated interferer at $\pm 6\text{MHz}$, BER = 10^{-3}		46 / 40 ⁽³⁾		dB
Selectivity, image frequency ⁽²⁾	Wanted signal at -67dBm , modulated interferer at image frequency, BER = 10^{-3}		5		dB
Selectivity, image frequency $\pm 2\text{MHz}^{(2)}$	Note that Image frequency + 2MHz is the co-channel. Wanted signal at -67dBm , modulated interferer at $\pm 2\text{MHz}$ from image frequency, BER = 10^{-3}		-8 / 32 ⁽³⁾		dB

7.14 Bluetooth Low Energy–Receive (RX) (continued)

When measured on the CC2340R5 reference design with $T_c = 25^\circ\text{C}$, $V_{\text{DD5}} = 3.0\text{V}$, $f_{\text{RF}} = 2440\text{MHz}$ with DCDC enabled unless otherwise noted. All measurements are performed at the antenna input with a combined RX and TX path. All measurements are performed conducted.

PARAMETER	TEST CONDITIONS	MIN	TYP	MAX	UNIT
Out-of-band blocking ⁽⁴⁾	30MHz to 2000MHz		-10		dBm
Out-of-band blocking	2003MHz to 2399MHz		-10		dBm
Out-of-band blocking	2484MHz to 2997MHz		-12		dBm
Out-of-band blocking	3000MHz to 12.75GHz (excluding VCO frequency)		-10		dBm
Intermodulation	Wanted signal at 2402MHz, -64dBm. Two interferers at 2408 and 2414MHz respectively, at the given power level		-38		dBm

- (1) Actual performance exceeding Bluetooth specification
- (2) Numbers given as I/C dB
- (3) X / Y, where X is +N MHz and Y is -N MHz
- (4) Excluding one exception at $F_{\text{wanted}} / 2$, per Bluetooth Specification
- (5) Suitable for systems targeting compliance with worldwide radio-frequency regulations ETSI EN 300 328 and EN 300 440 Class 2 (Europe), FCC CFR47 Part 15 (US), and ARIB STD-T66 (Japan)
- (6) The RSSI measurement will saturate at -30dBm

7.15 Bluetooth Low Energy Transmit (TX)

When measured on the CC2340R5 reference design with $T_c = 25^\circ\text{C}$, $V_{\text{DD5}} = 3.0\text{V}$, $f_{\text{RF}} = 2440\text{MHz}$ with DCDC enabled unless otherwise noted. All measurements are performed at the antenna input with a combined RX and TX path. All measurements are performed conducted.

PARAMETER	TEST CONDITIONS	MIN	TYP	MAX	UNIT
General Parameters					
Max output power	Delivered to a single-ended 50Ω load through integrated balun		8		dBm
Output power programmable range	Delivered to a single-ended 50Ω load through integrated balun		28		dB

7.16 Zigbee and Thread - IEEE 802.15.4-2006 2.4 GHz (OQPSK DSSS1:8, 250 kbps) - RX

Measured on the CC2340R5 reference design with $T_c = 25^\circ\text{C}$, $V_{\text{DD5}} = 3.0\text{V}$, $f_{\text{RF}} = 2440\text{MHz}$ with DC/DC enabled unless otherwise noted. All measurements are performed at the antenna input with a combined RX and TX path. All measurements are performed conducted.

PARAMETER	TEST CONDITIONS	MIN	TYP	MAX	UNIT
General Parameters					
Receiver sensitivity	PER = 1%		-98		dBm
Receiver saturation	PER = 1%		> 3		dBm
Adjacent channel rejection	Wanted signal at -82dBm, modulated interferer at ±5MHz, PER = 1%		36		dB
Alternate channel rejection	Wanted signal at -82dBm, modulated interferer at ±10MHz, PER = 1%		55		dB
Channel rejection, ±15MHz or more	Wanted signal at -82dBm, undesired signal is IEEE 802.15.4 modulated channel, stepped through all channels 2405 to 2480MHz, PER = 1%		59		dB
Blocking and desensitization, 5MHz from upper band edge	Wanted signal at -97dBm (3dB above the sensitivity level), CW jammer, PER = 1%		57		dB
Blocking and desensitization, 10MHz from upper band edge	Wanted signal at -97dBm (3dB above the sensitivity level), CW jammer, PER = 1%		63		dB
Blocking and desensitization, 20MHz from upper band edge	Wanted signal at -97dBm (3dB above the sensitivity level), CW jammer, PER = 1%		63		dB
Blocking and desensitization, 50MHz from upper band edge	Wanted signal at -97dBm (3dB above the sensitivity level), CW jammer, PER = 1%		66		dB
Blocking and desensitization, -5MHz from lower band edge	Wanted signal at -97dBm (3dB above the sensitivity level), CW jammer, PER = 1%		60		dB
Blocking and desensitization, -10MHz from lower band edge	Wanted signal at -97dBm (3dB above the sensitivity level), CW jammer, PER = 1%		60		dB

7.16 Zigbee and Thread - IEEE 802.15.4-2006 2.4 GHz (OQPSK DSSS1:8, 250 kbps) - RX (continued)

Measured on the CC2340R5 reference design with $T_c = 25^\circ\text{C}$, $V_{\text{DDS}} = 3.0\text{V}$, $f_{\text{RF}} = 2440\text{MHz}$ with DC/DC enabled unless otherwise noted. All measurements are performed at the antenna input with a combined RX and TX path. All measurements are performed conducted.

PARAMETER	TEST CONDITIONS	MIN	TYP	MAX	UNIT
Blocking and desensitization, -20MHz from lower band edge	Wanted signal at -97dBm (3dB above the sensitivity level), CW jammer, PER = 1%		63		dB
Blocking and desensitization, -50MHz from lower band edge	Wanted signal at -97dBm (3dB above the sensitivity level), CW jammer, PER = 1%		65		dB
Spurious emissions, 30MHz to 1000MHz	Measurement in a 50Ω single-ended load ⁽¹⁾		-64		dBm
Spurious emissions, 1GHz to 12.75GHz	Measurement in a 50Ω single-ended load ⁽¹⁾		-49		dBm
Frequency error tolerance	Difference between the incoming carrier frequency and the internally generated carrier frequency		> 80		ppm
Symbol rate error tolerance	Difference between incoming symbol rate and the internally generated symbol rate		> 80		ppm
RSSI dynamic range			90		dB
RSSI accuracy			±4		dB

- (1) Suitable for systems targeting compliance with EN 300 328, EN 300 440 class 2 (Europe), FCC CFR47, Part 15 (US), and ARIB STD-T-66 (Japan)

7.17 Zigbee and Thread - IEEE 802.15.4-2006 2.4 GHz (OQPSK DSSS1:8, 250 kbps) - TX

Measured on the CC2340R5 reference design with $T_c = 25^\circ\text{C}$, $V_{\text{DDS}} = 3.0\text{V}$, $f_{\text{RF}} = 2440\text{MHz}$ with DC/DC enabled unless otherwise noted. All measurements are performed at the antenna input with a combined RX and TX path. All measurements are performed conducted.

PARAMETER	TEST CONDITIONS	MIN	TYP	MAX	UNIT
General Parameters					
Max output power ⁽¹⁾	Delivered to a single-ended 50Ω load through integrated balun		8		dBm
Output power programmable range	Delivered to a single-ended 50Ω load through integrated balun		29		dB
IEEE 802.15.4-2006 2.4 GHz (OQPSK DSSS1:8, 250 kbps)					
Error vector magnitude	+8dBm setting		2%		

- (1) To ensure margins for passing FCC band edge requirements at 2483.5 MHz, a lower than maximum output-power setting or less than 100% duty cycle may be used when operating at the upper 802.15.4 channel(s).

7.18 Proprietary Radio Modes

Measured on the CC2340R5 reference design with $T_c = 25^\circ\text{C}$, $V_{\text{DDS}} = 3.0\text{V}$, $f_{\text{RF}} = 2440\text{MHz}$ with DCDC enabled unless otherwise noted. All measurements are performed at the antenna input with a combined RX and TX path. All measurements are performed conducted.

PARAMETER	TEST CONDITIONS	MIN	TYP	MAX	UNIT
2 Mbps GFSK (HID), 320 kHz deviation					
Receiver sensitivity	PER = 30.8%, Payload 37 bytes		-89		dBm

7.19 2.4GHz RX/TX CW

When measured on the CC2340R5 reference design with $T_c = 25^\circ\text{C}$, $V_{\text{DDS}} = 3.0\text{V}$, $f_{\text{RF}} = 2440\text{MHz}$ with DCDC enabled unless otherwise noted. All measurements are performed at the antenna input with a combined RX and TX path. All measurements are performed conducted.

PARAMETER	TEST CONDITIONS	MIN	TYP	MAX	UNIT
Spurious emissions and harmonics					
Spurious emissions ⁽¹⁾	f < 1GHz, outside restricted bands		< -36		dBm
	f < 1GHz, restricted bands ETSI		< -54		dBm
	f < 1GHz, restricted bands FCC		< -55		dBm
	f > 1GHz, including harmonics (ETSI)	+8dBm setting	< -30		dBm
Harmonics ⁽¹⁾	Second harmonic		< -42		dBm
	Third harmonic		< -42		dBm

(1) Suitable for systems targeting compliance with worldwide radio-frequency regulations ETSI EN 300 328 and EN 300 440 Class 2 (Europe), FCC CFR47 Part 15 (US), and ARIB STD-T66 (Japan).

7.20 Timing and Switching Characteristics

7.20.1 Reset Timing

PARAMETER	MIN	TYP	MAX	UNIT
RSTN low duration	1			μs

7.20.2 Wakeup Timing

Measured over operating free-air temperature with $V_{\text{DDS}} = 3.0\text{V}$ (unless otherwise noted). The times listed here do not include any software overhead (unless otherwise noted).

PARAMETER	TEST CONDITIONS	MIN	TYP	MAX	UNIT
MCU, Reset/Shutdown to Active ⁽¹⁾	GLDO default charge current setting, VDDR capacitor fully charged ⁽²⁾		350–450		μs
MCU, Standby to Active	MCU, Standby to Active (ready to execute code from flash). DCDC ON, default recharge current configuration		33–43 ⁽³⁾		μs
MCU, Standby to Active	MCU, Standby to Active (ready to execute code from flash). GLDO ON, default recharge current configuration		33–50 ⁽³⁾		μs
MCU, Idle to Active	Flash enabled in idle mode		3		μs
MCU, Idle to Active	Flash disabled in idle mode		14		μs

- (1) Wakeup time includes device ROM bootcode execution time. The wakeup time is dependent on remaining charge on VDDR capacitor when starting the device, and thus how long the device has been in Reset or Shutdown before starting up again.
- (2) This is the best-case reset/shutdown to active time (including ROM bootcode operation), for the specified GLDO charge current setting considering the VDDR capacitor is fully charged and is not discharged during the reset and shutdown events; that is, when the device is in reset / shutdown modes for only a very short period of time.
- (3) Depending on VDDR capacitor voltage level

7.20.3 Clock Specifications

7.20.3.1 48MHz Crystal Oscillator (HFXT)

Measured on the CC2340R5 reference design with $T_c = 25^\circ\text{C}$, $V_{\text{DDS}} = 3.0\text{V}$, unless otherwise noted.⁽⁴⁾

	PARAMETER	MIN	TYP	MAX	UNIT
	Crystal frequency		48		MHz
ESR	Equivalent series resistance $6\text{pF} < C_L \leq 9\text{pF}$		20	60	Ω
ESR	Equivalent series resistance $5\text{pF} < C_L \leq 6\text{pF}$			80	Ω
C_L	Crystal load capacitance ⁽¹⁾	5	7 ⁽²⁾	9	pF

7.20.3.1 48MHz Crystal Oscillator (HFXT) (continued)

Measured on the CC2340R5 reference design with $T_c = 25^\circ\text{C}$, $V_{\text{DDS}} = 3.0\text{V}$, unless otherwise noted.⁽⁴⁾

PARAMETER		MIN	TYP	MAX	UNIT
Start-up time ⁽³⁾	Until clock is qualified		200		μs

- (1) Adjustable load capacitance is integrated into the device. External load capacitors are required for systems targeting compliance with certain regulations.
- (2) On-chip default connected capacitance including reference design parasitic capacitance. Connected internal capacitance is changed through software in the SysConfig.
- (3) Start-up time using the TI-provided power driver. Start-up time may increase if driver is not used.
- (4) Tai-Saw TZ3908AAAO43 has been validated for CC2340R5 design.

7.20.3.2 48MHz RC Oscillator (HFOSC)

Measured on the CC2340R5 reference design with $T_c = 25^\circ\text{C}$, $V_{\text{DDS}} = 3.0\text{V}$, unless otherwise noted

	MIN	TYP	MAX	UNIT
Frequency		48		MHz
Uncalibrated frequency accuracy		$\pm 3\%$		
Calibrated frequency accuracy ⁽¹⁾		$\pm 0.25\%$		

- (1) Accuracy relative to the calibration source (HFXT)

7.20.3.3 32kHz Crystal Oscillator (LFXT)

Measured on the CC2340R5 reference design with $T_c = 25^\circ\text{C}$, $V_{\text{DDS}} = 3.0\text{V}$, unless otherwise noted

	MIN	TYP	MAX	UNIT
Crystal frequency		32.768		kHz
Supported crystal load capacitance	6		12	pF
ESR		30	100	k Ω

7.20.3.4 32kHz RC Oscillator (LFOSC)

Measured on the CC2340R5 reference design with $T_c = 25^\circ\text{C}$, $V_{\text{DDS}} = 3.0\text{V}$, unless otherwise noted

	MIN	TYP	MAX	UNIT
Calibrated frequency		32.768		kHz

7.21 Peripheral Characteristics

7.21.1 UART

7.21.1.1 UART Characteristics

over operating free-air temperature range (unless otherwise noted)

PARAMETER	MIN	TYP	MAX	UNIT
UART rate			3	MBaud

7.21.2 SPI

7.21.2.1 SPI Characteristics

Using TI SPI driver, over operating free-air temperature range (unless otherwise noted)

PARAMETERS		TEST CONDITIONS	MIN	TYP	MAX	UNIT
fSCLK 1/tsclk	SPI clock frequency	Controller Mode and Peripheral Mode ⁽¹⁾ $2.7\text{V} \leq V_{\text{DDS}} < 3.8\text{V}$			12	MHz
		Controller Mode and Peripheral Mode ⁽¹⁾ $V_{\text{DDS}} < 2.7\text{V}$			8	MHz
DC _{SCK}	SCK Duty Cycle		45%	50%	55%	

- (1) Assume interfacing with ideal SPI controller and SPI peripheral devices

7.21.2.2 SPI Controller Mode

Using TI SPI driver, over operating free-air temperature range (unless otherwise noted)

PARAMETERS		TEST CONDITIONS	MIN	TYP	MAX	UNIT
$t_{SCLK_H/L}$	SCLK High or Low time		$(t_{SPI}/2)-1$	$t_{SPI}/2$	$(t_{SPI}/2)+1$	ns
t_{CS_LEAD}	CS lead-time, CS active to clock		1/2			SCLK
t_{CS_LAG}	CS lag time, Last clock to CS inactive		1/2			SCLK
t_{CS_ACC}	CS access time, CS active to PICO data out				1	SCLK
t_{CS_DIS}	CS disable time, CS inactive to PICO high impedance				1	SCLK
t_{VALID_CO}	PICO output data valid time ⁽¹⁾	SCLK edge to PICO valid, $C_L = 20pF$			13	ns
t_{HD_CO}	PICO output data hold time ⁽²⁾	$C_L = 20pF$	0			ns

(1) Specifies the time to drive the next valid data to the output after the output changing SCLK clock edge

(2) Specifies how long data on the output is valid after the output changing SCLK clock edge

7.21.2.3 SPI Timing Diagrams—Controller Mode

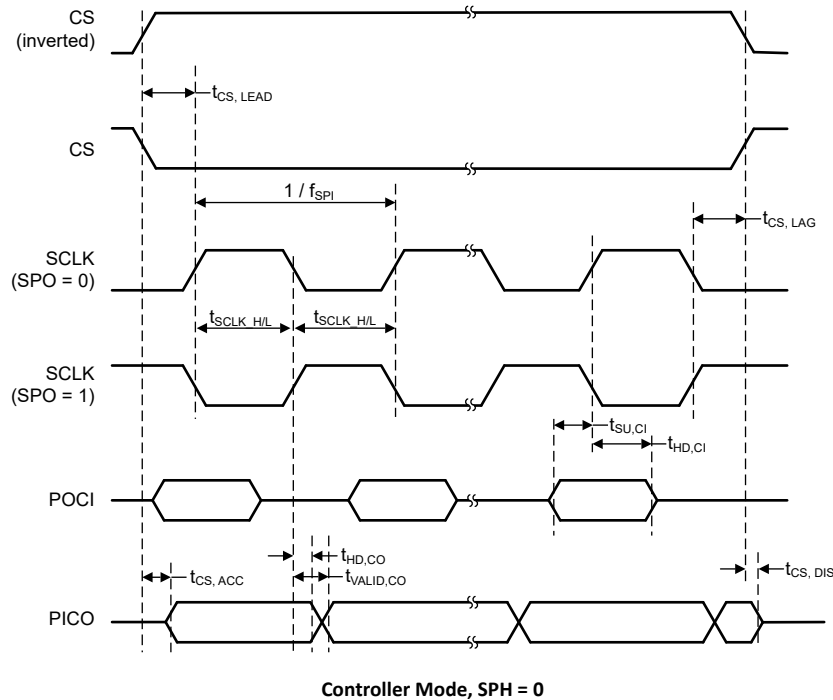

Figure 7-1. SPI Timing Diagram—Controller Mode, SPH = 0



Figure 7-2. SPI Timing Diagram—Controller Mode, SPH = 1

7.21.2.4 SPI Peripheral Mode

Using TI SPI driver, over operating free-air temperature range (unless otherwise noted),

PARAMETERS		TEST CONDITIONS	MIN	TYP	MAX	UNIT
$t_{CS, LEAD}$	CS lead-time, CS active to clock		1/2			SCLK
$t_{CS, LAG}$	CS lag time, Last clock to CS inactive		1/2			SCLK
$t_{CS, ACC}$	CS access time, CS active to POCI data out	VDDS = 3.3V			35	ns
$t_{CS, ACC}$	CS access time, CS active to POCI data out	VDDS = 1.8V			50	ns
$t_{CS, DIS}$	CS disable time, CS inactive to POCI high impedance	VDDS = 3.3V			35	ns
$t_{CS, DIS}$	CS disable time, CS inactive to POCI high impedance	VDDS = 1.8V			50	ns
$t_{SU, PI}$	PICO input data setup time		13			ns
$t_{HD, PI}$	PICO input data hold time		0			ns
$t_{VALID, PO}$	POCI output data valid time ⁽¹⁾	SCLK edge to POCI valid, $C_L = 20\text{pF}$, 3.3V			35	ns
$t_{VALID, PO}$	POCI output data valid time ⁽¹⁾	SCLK edge to POCI valid, $C_L = 20\text{pF}$, 1.8V			50	ns
$t_{HD, PO}$	POCI output data hold time ⁽²⁾	$C_L = 20\text{pF}$	0			ns

(1) Specifies the time to drive the next valid data to the output after the output changing SCLK clock edge

(2) Specifies how long data on the output is valid after the output changing SCLK clock edge

7.21.2.5 SPI Timing Diagrams—Peripheral Mode

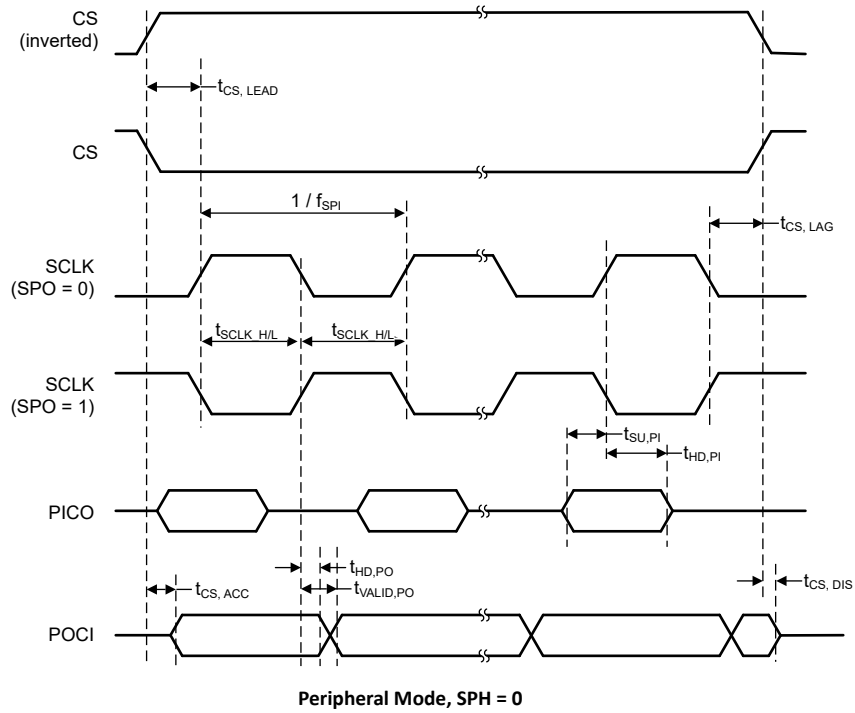

Figure 7-3. SPI Timing Diagram—Peripheral Mode, SPH = 0

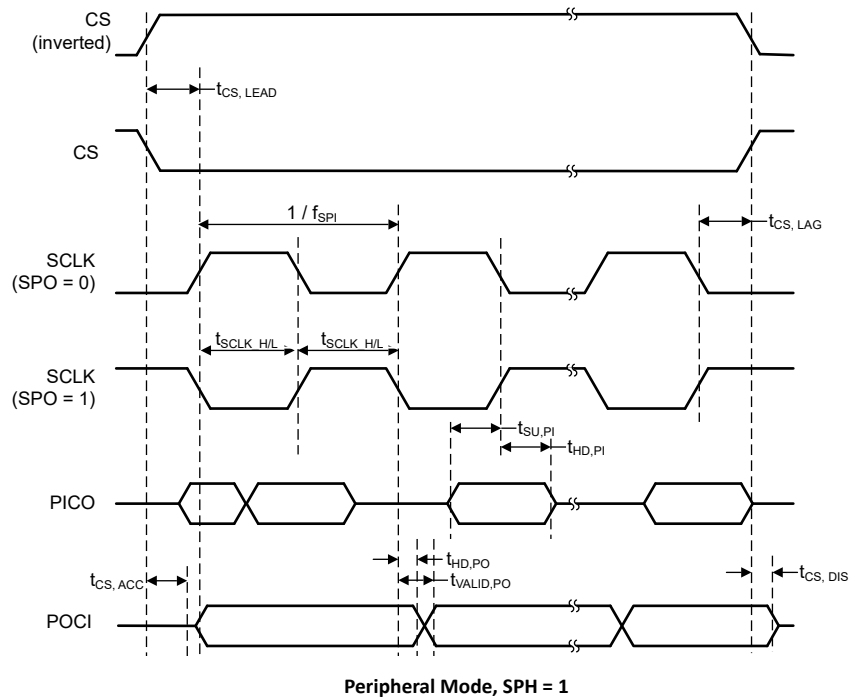

Figure 7-4. SPI Timing Diagram—Peripheral Mode, SPH = 1

7.21.3 I²C

7.21.3.1 I²C

Over operating free-air temperature range (unless otherwise noted)

PARAMETERS		TEST CONDITIONS	MIN	TYP	MAX	UNIT
f _{SCL}	SCL clock frequency		0		400	kHz
t _{HD,STA}	Hold time (repeated) START	f _{SCL} = 100kHz	4.0			μs
t _{HD,STA}	Hold time (repeated) START	f _{SCL} > 100kHz	0.6			μs
t _{SU,STA}	Setup time for a repeated START	f _{SCL} = 100kHz	4.7			μs
t _{SU,STA}	Setup time for a repeated START	f _{SCL} > 100kHz	0.6			μs
t _{HD,DAT}	Data hold time		0			μs
t _{SU,DAT}	Data setup time	f _{SCL} = 100kHz	250			ns
t _{SU,DAT}	Data setup time	f _{SCL} > 100kHz	100			ns
t _{SU,STO}	Setup time for STOP	f _{SCL} = 100kHz	4.0			μs
t _{SU,STO}	Setup time for STOP	f _{SCL} > 100kHz	0.6			μs
t _{BUF}	Bus free time between STOP and START conditions	f _{SCL} = 100kHz	4.7			μs
t _{BUF}	Bus free time between STOP and START conditions	f _{SCL} > 100kHz	1.3			μs
t _{SP}	Pulse duration of spikes suppressed by input deglitch filter		50			ns

7.21.3.2 I²C Timing Diagram

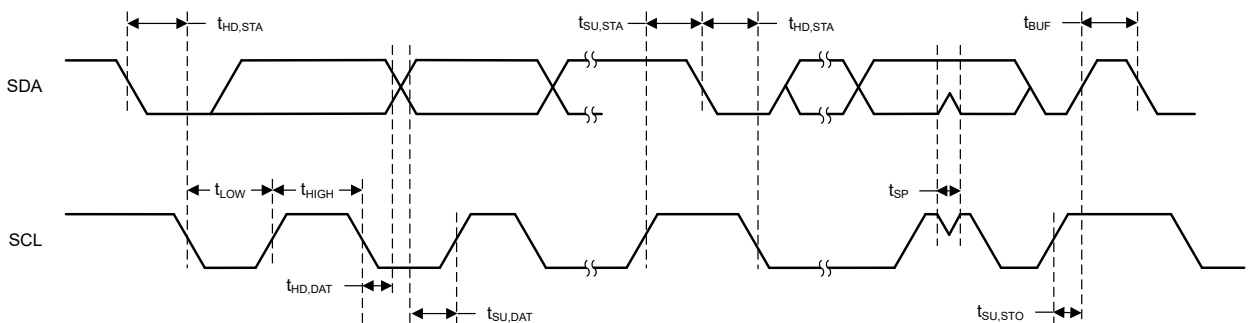

Figure 7-5. I²C Timing Diagram

7.21.4 GPIO

7.21.4.1 GPIO DC Characteristics

PARAMETER	TEST CONDITIONS	MIN	TYP	MAX	UNIT
T_A = 25°C, V_{DDs} = 1.8V					
GPIO pullup current	Input mode, pullup enabled, V _{pad} = 0V	39	66	109	μA
GPIO pulldown current	Input mode, pulldown enabled, V _{pad} = V _{DDs}	10	21	40	μA
GPIO low-to-high input transition, with hysteresis	I _H = 1, transition voltage for input read as 0 → 1	0.91	1.11	1.27	V
GPIO high-to-low input transition, with hysteresis	I _H = 1, transition voltage for input read as 1 → 0	0.59	0.75	0.91	V
GPIO input hysteresis	I _H = 1, difference between 0 → 1 and 1 → 0 points	0.26	0.35	0.44	V
T_A = 25°C, V_{DDs} = 3.0V					
GPIO VOH at 10mA load	high-drive GPIOs only, max drive setting	2.47			V
GPIO VOL at 10mA load	high-drive GPIOs only, max drive setting			0.25	V
GPIO VOH at 2mA load	standard drive GPIOs	2.52			V
GPIO VOL at 2mA load	standard drive GPIOs			0.20	V

7.21.4.1 GPIO DC Characteristics (continued)

PARAMETER	TEST CONDITIONS	MIN	TYP	MAX	UNIT
T_A = 25°C, V_{DD5} = 3.8V					
GPIO pullup current	Input mode, pullup enabled, V _{pad} = 0V	170	262	393	μA
GPIO pulldown current	Input mode, pulldown enabled, V _{pad} = V _{DD5}	60	110	172	μA
GPIO low-to-high input transition, with hysteresis	IH = 1, transition voltage for input read as 0 → 1	1.76	1.98	2.27	V
GPIO high-to-low input transition, with hysteresis	IH = 1, transition voltage for input read as 1 → 0	1.26	1.52	1.79	V
GPIO input hysteresis	IH = 1, difference between 0 → 1 and 1 → 0 points	0.40	0.47	0.54	V
T_A = 25°C					
V _{IH}	Lowest GPIO input voltage reliably interpreted as a <i>High</i>	0.8×V _{DD5}			V
V _{IL}	Highest GPIO input voltage reliably interpreted as a <i>Low</i>	0.2×V _{DD5}			V

7.21.5 ADC

7.21.5.1 Analog-to-Digital Converter (ADC) Characteristics

T_c = 25°C, V_{DD5} = 3.0V, unless otherwise noted⁽²⁾

Performance numbers require use of offset and gain adjustments in software by TI provided ADC drivers.

PARAMETER	TEST CONDITIONS	MIN	TYP	MAX	UNIT
ADC Power Supply and Input Range Conditions					
V _(Ax)	Analog input voltage range	All ADC analog input pins Ax	0	V _{DD5}	V
I _(ADC) single-ended mode	Operating supply current into V _{DD5} terminal	RES = 0x0 (12Bit mode), F _s = 1.2MSPS, Internal reference OFF (ADCREP_EN = 0), V _{eREF+} = V _{DD5}	480		μA
		RES = 0x0 (12Bit mode), F _s = 266ksps, Internal reference ON (ADCREP_EN = 0), ADCREF = 2.5V	365		
C _{I GPIO}	Input capacitance into a single terminal		5	7	pF
R _{I GPIO}	Input MUX ON-resistance		0.5	1	kΩ
ADC Switching Characteristics					
F _S ADCREF	ADC sampling frequency when using the internal ADC reference voltage	ADCREP_EN = 1, RES = 0x0 (12-bit), V _{DD5} = 1.71V to V _{DD5max}		267 ⁽¹⁾	ksps
F _S ADCREF	ADC sampling frequency when using the internal ADC reference voltage	ADCREP_EN = 1, RES = 0x1 (10-bit), V _{DD5} = 1.71V to V _{DD5max}		308 ⁽¹⁾	ksps
F _S ADCREF	ADC sampling frequency when using the internal ADC reference voltage	ADCREP_EN = 1, RES = 0x2 (8-bit), V _{DD5} = 1.71V to V _{DD5max}		400 ⁽¹⁾	ksps
F _S EXTREF	ADC sampling frequency when using the external ADC reference voltage	ADCREP_EN = 0, V _{eREF+} = V _{DD5} , RES = 0x0 (12-bit), V _{DD5} = 1.71V to V _{DD5max}		1.2 ⁽¹⁾	MSPS
F _S EXTREF	ADC sampling frequency when using the external ADC reference voltage	ADCREP_EN = 0, V _{eREF+} = V _{DD5} , RES = 0x1 (10-bit), V _{DD5} = 1.71V to V _{DD5max}		1.33 ⁽¹⁾	MSPS
F _S EXTREF	ADC sampling frequency when using the external ADC reference voltage	ADCREP_EN = 0, V _{eREF+} = V _{DD5} , RES = 0x2 (8-bit), V _{DD5} = 1.71V to V _{DD5max}		1.6 ⁽¹⁾	MSPS
N _{CONVERT}	Clock cycles for conversion	RES = 0x0 (12-bit)	14		cycles
N _{CONVERT}	Clock cycles for conversion	RES = 0x1 (10-bit)	12		cycles
N _{CONVERT}	Clock cycles for conversion	RES = 0x2 (8-bit)	9		cycles
t _{sample}	Sampling time	RES = 0x0 (12-bit), R _S = 25Ω, C _{pext} = 10pF. ±0.5LSB settling	250		ns
t _{VSUPPLY/3(sample)}	Sample time required when V _{supply/3} channel is selected		20		μs
ADC Linearity Parameters					

7.21.5.1 Analog-to-Digital Converter (ADC) Characteristics (continued)

$T_C = 25^\circ\text{C}$, $V_{DD5} = 3.0\text{V}$, unless otherwise noted⁽²⁾

Performance numbers require use of offset and gain adjustments in software by TI provided ADC drivers.

PARAMETER		TEST CONDITIONS	MIN	TYP	MAX	UNIT
E_I	Integral linearity error (INL) for single-ended inputs	12-bit Mode, $V_{R+} = V_{REF+} = V_{DD5}$, $V_{DD5}=1.71\text{V}-3.8\text{V}$		± 2		LSB
E_D	Differential linearity error (DNL)	12-bit Mode, $V_{R+} = V_{REF+} = V_{DD5}$, $V_{DD5}=1.71\text{V}-3.8\text{V}$		± 1		LSB
E_O	Offset error	12-bit Mode, External reference, $V_{R+} = V_{REF+} = V_{DD5}$, $V_{DD5}=1.71\text{V}-3.8\text{V}$		1.98		LSB
E_O	Offset error	12-bit Mode, Internal reference, $V_{R+} = \text{ADCREF} = 2.5\text{V}$		1.02		LSB
E_G	Gain error	External Reference, $V_{R+} = V_{REF+} = V_{DD5}$, $V_{DD} = 1.71\text{V}-3.8\text{V}$		± 2		LSB
E_G	Gain error	Internal reference, $V_{R+} = \text{ADCREF} = 2.5\text{V}$		± 40		LSB
ADC Dynamic Parameters						
ENOB	Effective number of bits	$\text{ADCREF_EN} = 0$, $V_{REF+} = V_{DD5} = 3.3\text{V}$, $V_{REF-} = 0\text{V}$, $\text{RES} = 0\text{x}2$ (8-bit)		8		bit
ENOB	Effective number of bits	$\text{ADCREF_EN} = 0$, $V_{REF+} = V_{DD5} = 3.3\text{V}$, $V_{REF-} = 0\text{V}$, $\text{RES} = 0\text{x}1$ (10-bit)		9.9		bit
ENOB	Effective number of bits	$\text{ADCREF_EN} = 0$, $V_{REF+} = V_{DD5} = 3.3\text{V}$, $V_{REF-} = 0\text{V}$, $\text{RES} = 0\text{x}0$ (12-bit)		11.2		bit
ENOB	Effective number of bits	$\text{ADCREF_EN} = 1$, $\text{ADCREF_VSEL} = \{2.5\text{V}, 1.4\text{V}\}$, $\text{RES} = 0\text{x}2$ (8-bit)		8		bit
ENOB	Effective number of bits	$\text{ADCREF_EN} = 1$, $\text{ADCREF_VSEL} = \{2.5\text{V}, 1.4\text{V}\}$, $\text{RES} = 0\text{x}1$ (10-bit)		9.6		bit
ENOB	Effective number of bits	$\text{ADCREF_EN} = 1$, $\text{ADCREF_VSEL} = \{2.5\text{V}, 1.4\text{V}\}$, $\text{RES} = 0\text{x}0$ (12-bit)		10.4		bit
ENOB	Effective number of bits	V_{DD5} reference, $\text{RES} = 0\text{x}0$ (12-bit)		11.2		bit
SINAD	Signal-to-noise and distortion ratio	$\text{ADCREF_EN} = 0$, $V_{REF+} = V_{DD5} = 3.3\text{V}$, $V_{REF-} = 0\text{V}$, $\text{RES} = 0\text{x}0$ (12-bit)		69.18		dB
SINAD	Signal-to-noise and distortion ratio	$\text{ADCREF_EN} = 1$, $\text{ADCREF_VSEL} = \{2.5\text{V}, 1.4\text{V}\}$, $\text{RES} = 0\text{x}0$ (12-bit)		64.37		dB
SINAD	Signal-to-noise and distortion ratio	V_{DD5} reference, $\text{RES} = 0\text{x}0$ (12-bit)		69.18		dB
ADC External Reference						
EXTREF	Positive external reference voltage input	$\text{ADCREF_EN}=0$, ADC reference sourced from external reference pin (V_{REF+})	1.4		V_{DD5}	V
EXTREF	Negative external reference voltage input	$\text{ADCREF_EN}=0$, ADC reference sourced from external reference pin (V_{REF-})			0	V
ADC Temperature Diode, Supply Monitor						
Temp_diode Accuracy	Temperature Error	ADC input channel: Temp diode voltage. Error calculated in temperature range: -30C to $+40\text{C}$, with single point calibration ⁽²⁾		± 3		C
ADC Internal Input: $V_{\text{SUPPLY}} / 3$ Accuracy	V_{supply} voltage divider accuracy for supply monitoring	ADC input channel: V_{supply} monitor		$\pm 1\%$		
ADC Internal Input: $I_{\text{VSUPPLY}} / 3$	V_{supply} voltage divider current consumption	ADC input channel V_{supply} monitor. $V_{\text{supply}}=V_{DD5}=3.3\text{V}$		10		μA
ADC Internal and VDD5 Reference						
$V_{DD5\text{REF}}$	Positive ADC reference voltage	ADC reference sourced from V_{DD5}		V_{DD5}		V
ADCREF	Internal ADC Reference Voltage	$\text{ADCREF_EN} = 1$, $\text{ADCREF_VSEL} = 0$, $V_{DD5} = 1.71\text{V}$ to $V_{DD5\text{max}}$		1.4		V
		$\text{ADCREF_EN} = 1$, $\text{ADCREF_VSEL} = 1$, $V_{DD5} = 2.7\text{V}$ to $V_{DD5\text{max}}$		2.5		V
I_{ADCREF}	Operating supply current into V_{DDA} terminal with internal reference ON	$\text{ADCREF_EN} = 1$, $V_{DDA} = 1.7\text{V}$ to $V_{DDA\text{max}}$, $\text{ADCREF_VSEL} = \{0,1\}$		80		μA
t_{ON}	Internal ADC Reference Voltage power on-time	$\text{ADCREF_EN} = 1$		2		μs

(1) Measured with 48MHz HFOSC

- (2) Using IEEE Std 1241-2010 for terminology and test methods

7.21.6 Comparators

7.21.6.1 Ultra-Low Power Comparator

$T_c = 25^\circ\text{C}$, $V_{\text{DDS}} = 3.0\text{V}$, unless otherwise noted.

PARAMETER	TEST CONDITIONS	MIN	TYP	MAX	UNIT
Input voltage range		0		V_{DDS}	V
Clock frequency			32		kHz
Voltage Divider Accuracy	Input voltage range is between $V_{\text{DDS}}/4$ and V_{DDS}		98%		
Offset	Measured at $V_{\text{DDS}} / 2$ (Errors seen when using two external inputs)		± 27.3		mV
Decision time	Step from -50mV to 50mV		1	3	Clock Cycle
Comparator enable time	COMP_LP disable \rightarrow enable, VIN+, VIN- from pins, Overdrive $\geq 20\text{mV}$		70		μs
Current consumption	Including using $V_{\text{DDS}}/2$ as internal reference at VIN- comparator terminal		370		nA

7.22 Typical Characteristics

All measurements in this section are done with $T_c = 25^\circ\text{C}$ and $V_{\text{DDS}} = 3.0\text{V}$, unless otherwise noted. See *Recommended Operating Conditions* for device limits. Values exceeding these limits are for reference only.

7.22.1 MCU Current

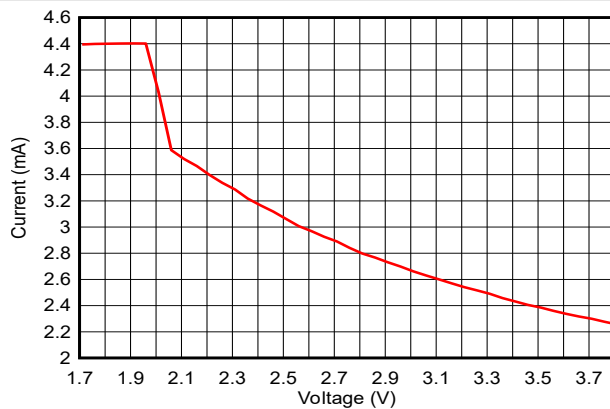

Figure 7-6. Active Mode (MCU) Current vs. Supply Voltage (V_{DDS}) (Running CoreMark)

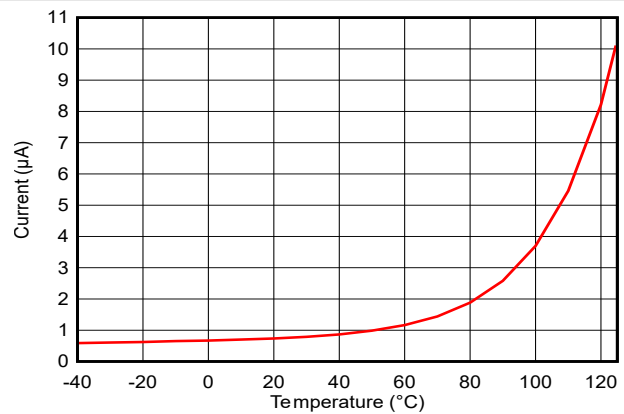

Figure 7-7. Standby Mode (MCU) Current vs. Temperature (RAM and partial register retention, RTC)

7.22.2 RX Current

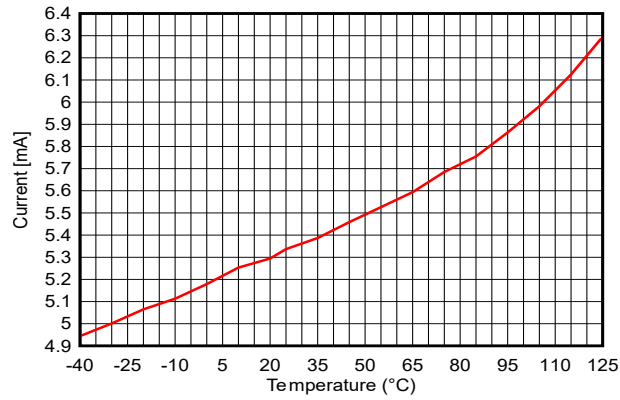

Figure 7-8. RX Current vs. Temperature (Bluetooth LE 1Mbps, 2.44GHz)

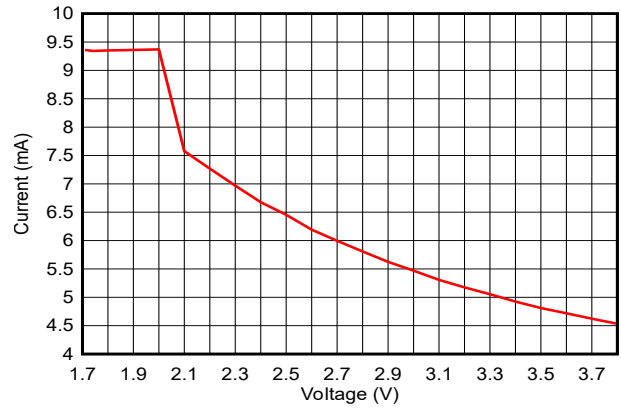

Figure 7-9. RX Current vs. Supply Voltage (VDD5) (Bluetooth LE 1Mbps, 2.44GHz)

7.22.3 TX Current

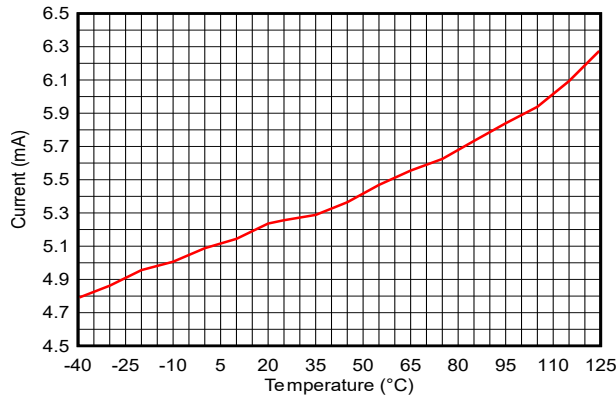

Figure 7-10. TX Current vs. Temperature (Bluetooth LE 1Mbps, 2.44GHz, 0dBm)

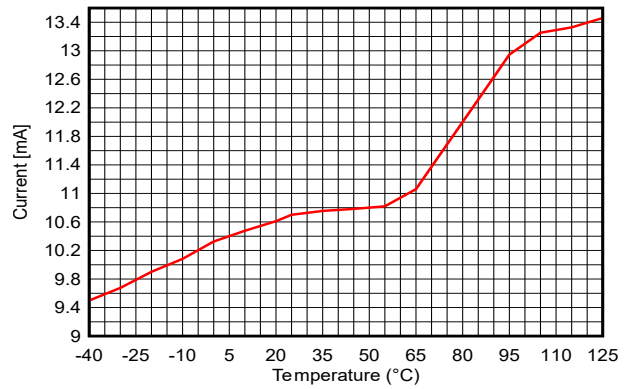

Figure 7-11. TX Current vs. Temperature (Bluetooth LE 1Mbps, 2.44GHz, +8dBm)

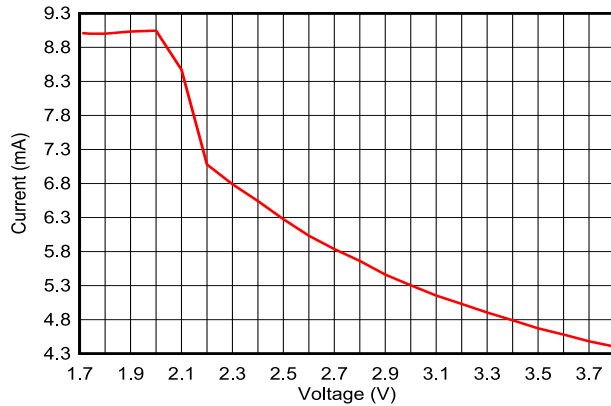

Figure 7-12. TX Current vs. Supply Voltage, VDD5 (Bluetooth LE 1Mbps, 2.44GHz, 0dBm)

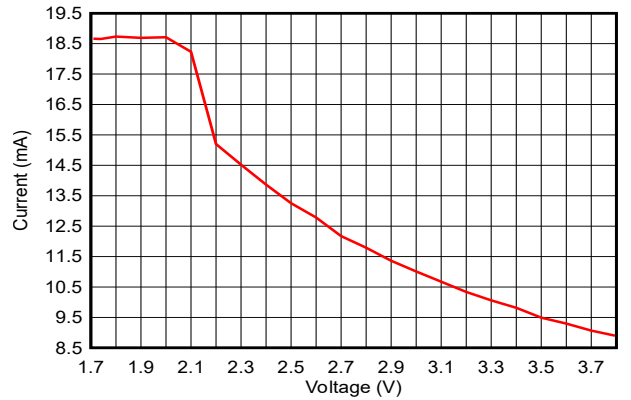

Figure 7-13. TX Current vs. Supply Voltage, VDD5 (Bluetooth LE 1Mbps, 2.44GHz, +8dBm)

Table 7-1 shows typical TX current and output power for different output power settings.

Table 7-1. Typical TX Current and Output Power

2.4 GHz, VDD5 = 3.0 V, DCDC=On, Temperature = 25 °C (Measured on LP-EM-CC2340R5)			
txPowerTable Index	TX Power Setting [dBm] (SmartRF Studio)	Typical Output Power [dBm]	Typical Current Consumption [mA]
13	8	7.7	10.7
12	7	7.1	9.5
11	6	6.3	8.9
10	5	5.5	8.3
9	4	4.5	7.9
8	3	3.7	7.5
7	2	2.4	7.1
6	1	1.0	5.4
5	0	0.4	5.1
4	-4	-3.1	4.8
3	-8	-7.3	4.5
2	-12	-10.9	4.2
1	-16	-15.1	4.0
0	-20	-19.0	3.8

7.22.4 RX Performance

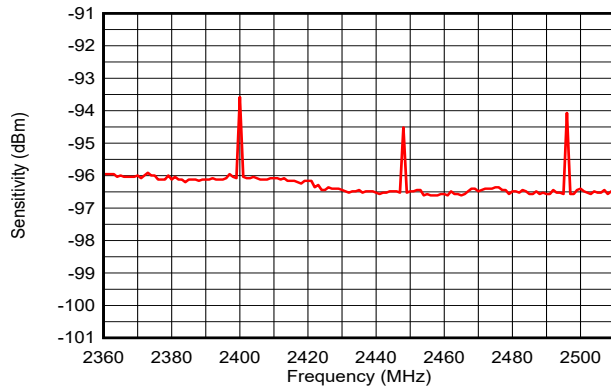

Figure 7-14. Sensitivity vs. Frequency (Bluetooth LE 1Mbps)

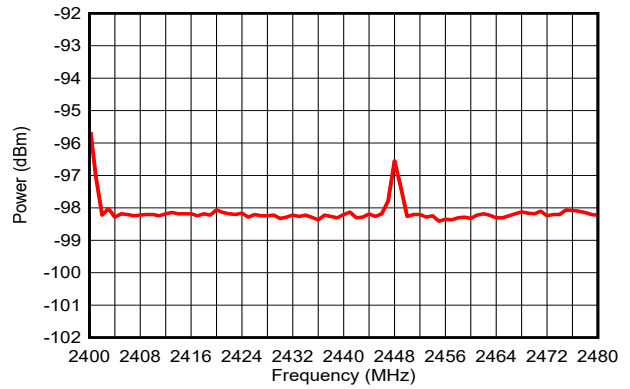

Figure 7-15. Sensitivity vs. Frequency (IEEE 802.15.4 PHY)

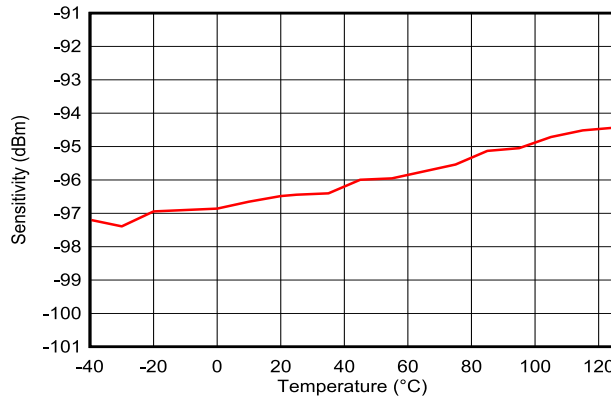

Figure 7-16. Sensitivity vs. Temperature (Bluetooth LE 1Mbps, 2.44GHz)

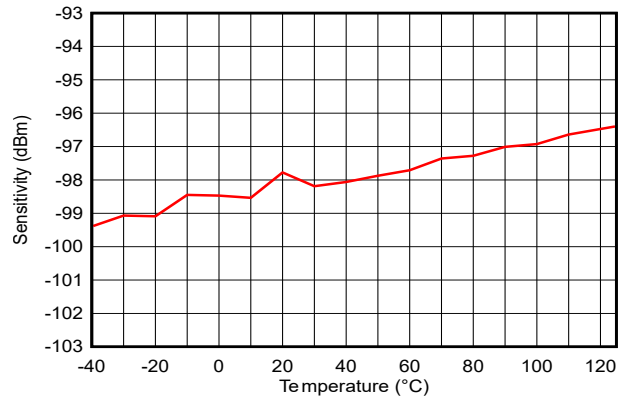

Figure 7-17. Sensitivity vs. Temperature (IEEE 802.15.4 PHY, 2.44GHz)

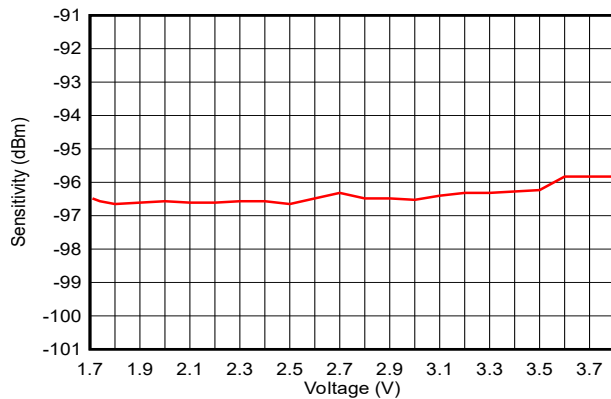

Figure 7-18. Sensitivity vs. Supply Voltage (VDDSD) (Bluetooth LE 1Mbps, 2.44GHz)

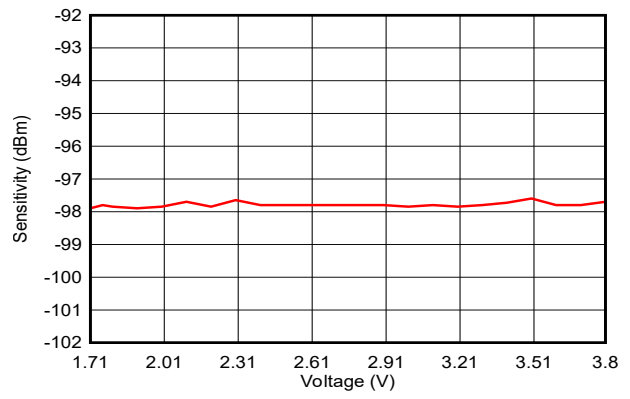

Figure 7-19. Sensitivity vs. Supply Voltage (VDDSD) (IEEE 802.15.4 PHY, 2.44GHz)

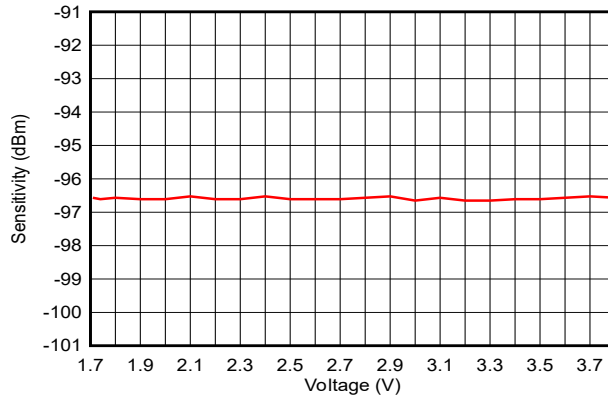

Figure 7-20. Sensitivity vs. Supply Voltage (VDDS) (Bluetooth LE 1Mbps, 2.44GHz, DCDC Off)

7.22.5 TX Performance

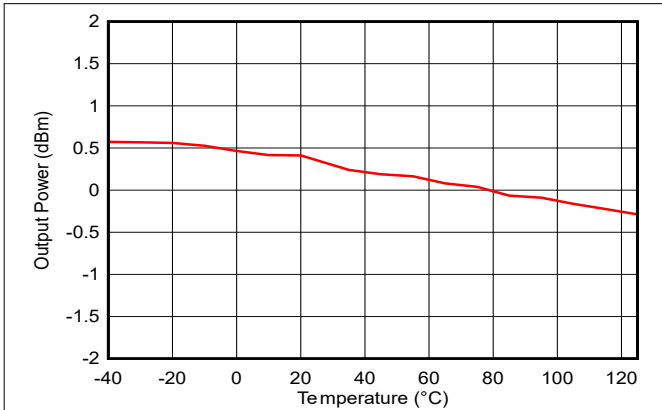

Figure 7-21. Output Power vs. Temperature (Bluetooth LE 1Mbps, 2.44GHz, 0dBm)

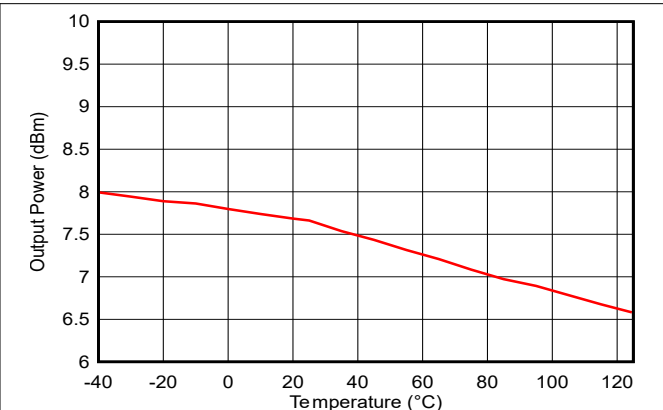

Figure 7-22. Output Power vs. Temperature (Bluetooth LE 1Mbps, 2.44GHz, +8dBm)

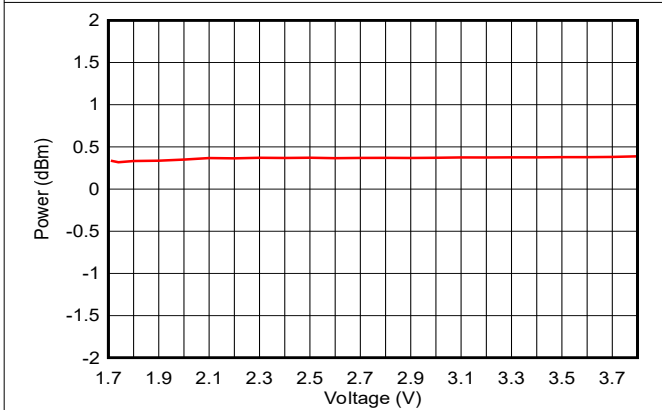

Figure 7-23. Output Power vs. Supply Voltage (VDD5) (Bluetooth LE 1Mbps, 2.44GHz, 0dBm)

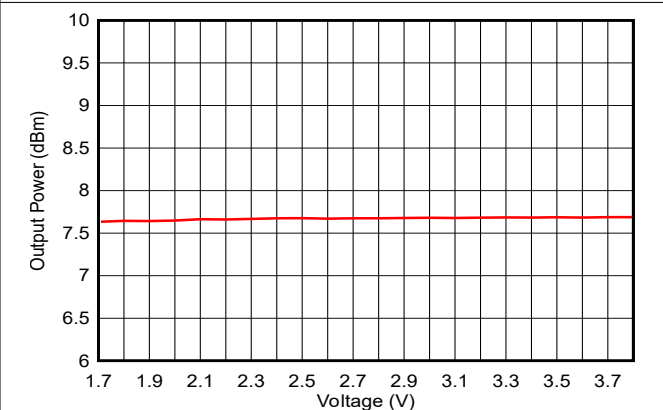

Figure 7-24. Output Power vs. Supply Voltage (VDD5) (Bluetooth LE 1Mbps, 2.44GHz, +8dBm)

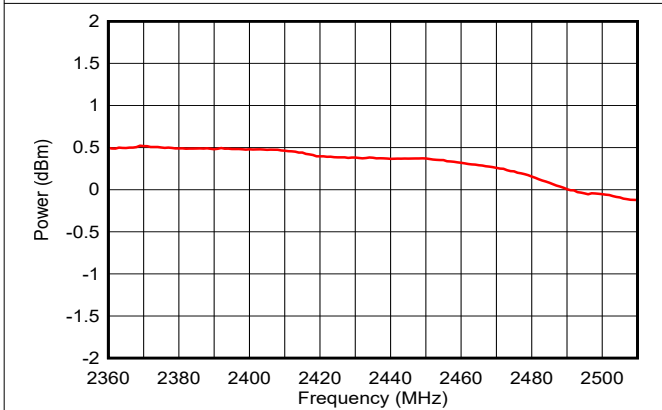

Figure 7-25. Output Power vs. Frequency (Bluetooth LE 1Mbps, 0dBm)

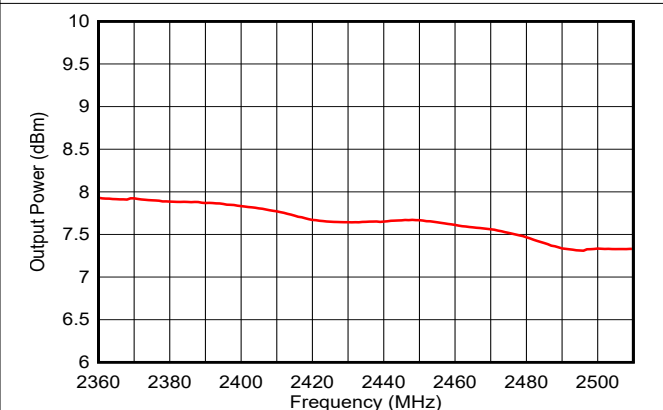
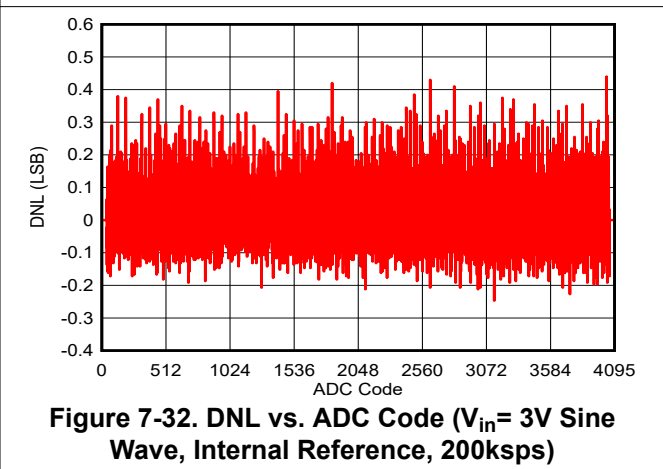
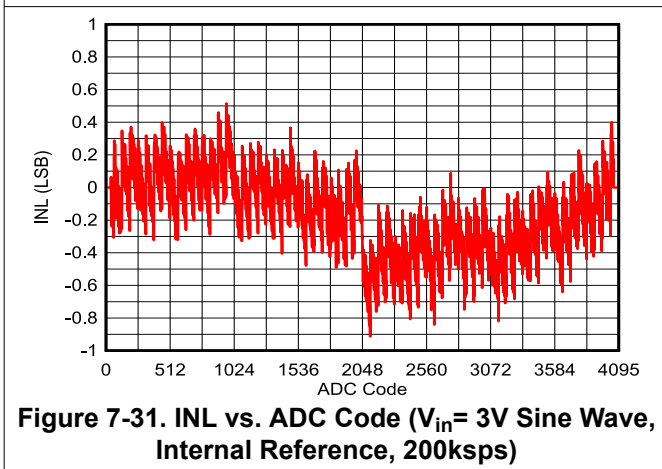
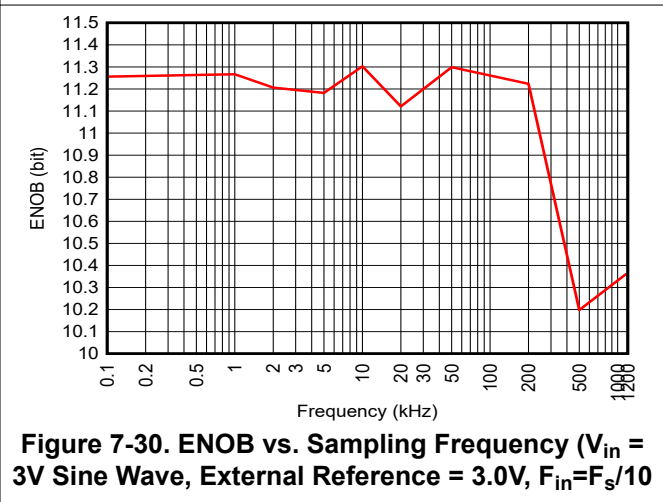
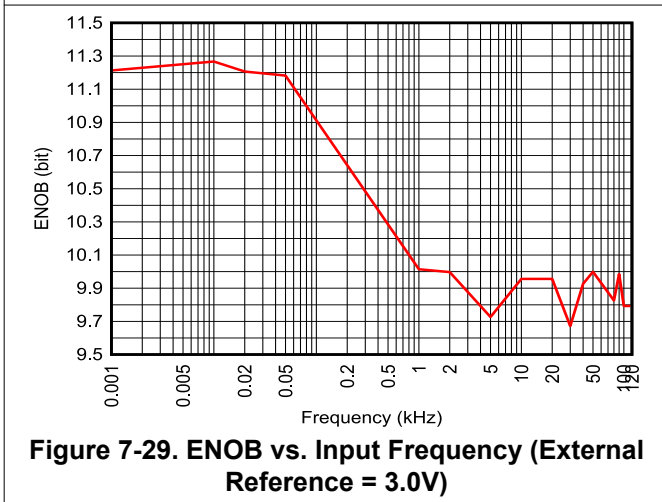
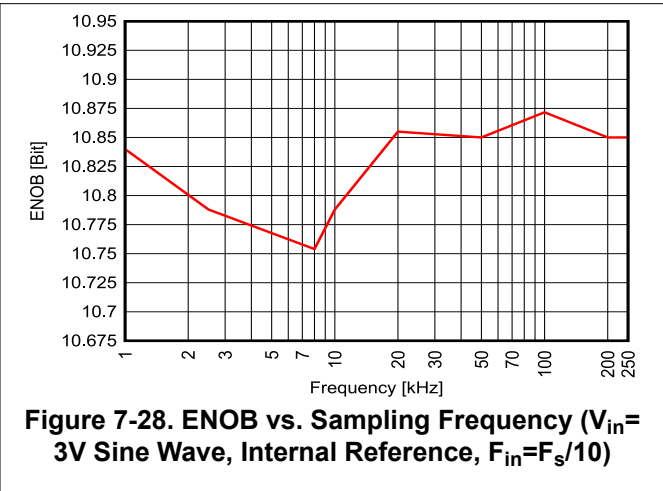
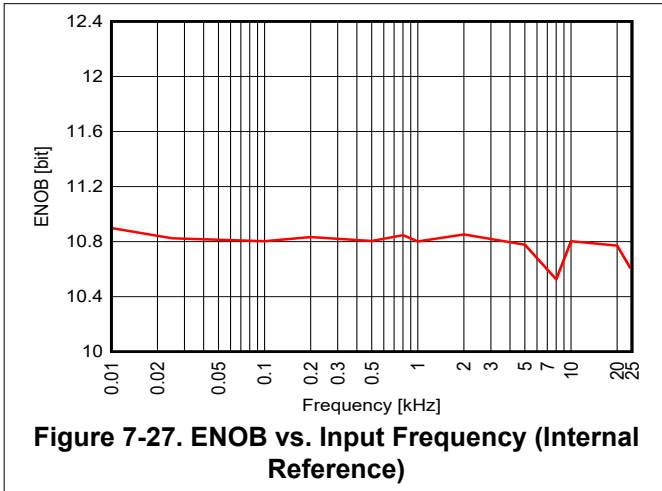

Figure 7-26. Output Power vs. Frequency (Bluetooth LE 1Mbps, +8dBm)

7.22.6 ADC Performance



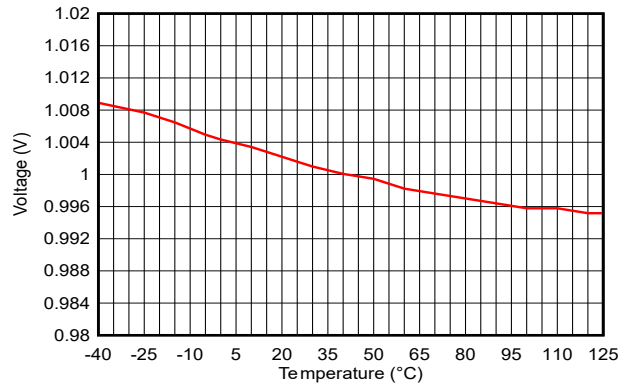

Figure 7-33. ADC Accuracy vs. Temperature ($V_{in}=1V$, Internal Reference, 200ksps)

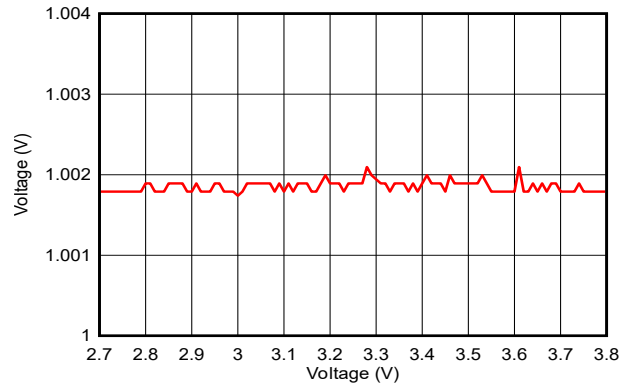

Figure 7-34. ADC Accuracy vs. Supply Voltage ($V_{in}=1V$, Internal Reference, 200ksps)

8 Detailed Description

8.1 Overview

Section 4 shows the core modules of the CC2340R device.

8.2 System CPU

The CC2340R SimpleLink™ Wireless MCU contains an Arm® Cortex®-M0+ system CPU, which runs the application, the protocol stacks, and the radio. The Cortex-M0+ processor is built on a highly area and power-optimized 32-bit processor core, with a 2-stage pipeline Von Neumann architecture. The processor delivers exceptional energy efficiency through a small but powerful instruction set and extensively optimized design, providing high-end processing hardware including a single-cycle multiplier. The Cortex-M0+ processor offers multiple benefits to developers, including:

- Ultra-low power, energy-efficient operation
- Deterministic, high-performance interrupt handling for time-critical applications
- Upward compatibility with the Cortex-M processor family

The Cortex-M0+ processor provides the excellent performance expected of a modern 32-bit architecture core, with higher code density than other 8-bit and 16-bit microcontrollers. Its features include the following:

- ARMv6-M architecture optimized for small-footprint embedded applications
- A subset of Arm Thumb/Thumb-2 mixed 16- and 32-bit instructions delivers the high performance expected of a 32-bit Arm
- Single-cycle multiply instruction
- VTOR supporting offset of the vector table base address
- Serial Wire debug with HW break-point comparators
- Ultra-low-power consumption with integrated sleep modes
- SysTick timer
- 48MHz operation
- 0.99DMIPS/MHz

Additionally, the CC2340R devices are compatible with all ARM tools and software.

8.3 Radio (RF Core)

The low-power RF Core (LRF) implements a high performance and highly flexible RF sub system containing RF and baseband circuitry in addition to a software defined digital radio (LRFD). LRFD provides a high-level, command-based API to the main CPU and handles all of the timing critical and low-level details of many different radio PHYs. Several signals are also available to control external circuitry such as RF switches or range extenders autonomously.

The software-defined modem is not programmable by customers but is instead loaded with precompiled images provided in the radio driver in the SimpleLink™ Low Power F3 software development kit (SDK) for the CC23xx devices. This mechanism allows the radio platform to be updated for support of future versions of standards with over-the-air (OTA) updates while still using the same silicon. LRFD stores the code images in the RF SRAM and does not make use of any ROM memory, thus image loading from NV memory only occurs once after boot and also, no patching is required when exiting power modes.

8.3.1 Bluetooth Low Energy

The RF Core offers full support for Bluetooth Low Energy, including the high-speed 2Mbps physical layer and the 500kbps and 125kbps long-range PHYs (Coded PHY) through the TI-provided Bluetooth stack or through a high-level Bluetooth API.

The new high-speed mode allows data transfers up to 2Mbps. In addition to faster speeds, this mode offers significant improvements in energy efficiency and wireless coexistence with reduced radio communication time.

Bluetooth LE also enables unparalleled flexibility for adjustment of speed and range based on application needs, which capitalizes on the high-speed or long-range modes, respectively. Data transfers are now possible at

2Mbps, enabling the development of applications using voice, audio, imaging, and data logging that were not previously an option using Bluetooth low energy. With high-speed mode, existing applications deliver faster responses, richer engagement, and longer battery life. Bluetooth LE enables fast, reliable firmware updates.

8.3.2 802.15.4 (Thread and Zigbee)

Through a dedicated IEEE radio API, the RF Core supports the 2.4GHz IEEE 802.15.4-2011 physical layer (2 Mcchips per second Offset-QPSK with DSSS 1:8), used in Thread and Zigbee protocols. TI also provides royalty-free protocol stacks for Thread and Zigbee, enabling a robust end-to-end solution.

8.4 Memory

Up to 512KB nonvolatile (Flash) memory provides storage for code and data. The flash memory is in-system programmable and erasable. A special flash memory sector must contain a Customer Configuration section (CCFG) that is used by the boot ROM and TI-provided drivers to configure the device. This configuration is done through the `ccfg.c` source file that is included in all TI-provided examples.

Up to 64KB ultra-low leakage system static RAM (SRAM) can be used for both storage of data and execution of code. Retention of SRAM contents in Standby power mode is enabled by default and included in Standby mode power consumption numbers. System SRAM is always initialized to zeroes upon code execution during boot.

The ROM includes device bootcode firmware handling initial device trimming operations, security configurations, and device lifecycle management. The ROM also contains a serial (SPI and UART) bootloader that can be used for the initial programming of the device.

8.5 Cryptography

The CC2340R device comes with AES-128 cryptography hardware accelerator, reducing code footprint and execution time for cryptographic operations. It also has the benefit of being lower power and improves the availability and responsiveness of the system because the cryptography operations run in a background hardware thread. The AES hardware accelerators support the following block cipher modes and message authentication codes:

- AES ECB encrypt
- AES CBC encrypt
- AES CTR encrypt/decrypt
- AES CBC-MAC
- AES GCM
- AEC CCM (uses a combination of CTR + CBC-MAC hardware via software drivers)

The AES hardware accelerator can be fed with plaintext/ciphertext from either the CPU or using DMA. Sustained throughput of one 16-byte ECB block per 23 cycles is possible, corresponding to > 30Mbps.

The CC2340R device supports Random Number Generation (RNG) using on-chip analog noise as the non-deterministic noise source for the purpose of generating a seed for a cryptographically secure counter deterministic random bit generator (CTR-DRBG) that in turn is used to generate random numbers for keys, initialization vectors (IVs), and other random number requirements. Hardware acceleration of AES CTR-DRBG is supported.

The CC2340R device includes a complete SHA 256 library in ROM, reducing the code footprint of the application. Use cases may include generating digests for use in digital signature algorithms, data integrity checks, and password storage.

Together with a large selection of open-source cryptography libraries provided with the Software Development Kit (SDK), this allows for secure and future-proof IoT applications to be easily built on top of the platform.

8.6 Timers

A large selection of timers are available as part of the CC2340R device. These timers are:

- **Real-Time Clock (RTC)**

The RTC is a 67-bit, 2-channel timer running on the LFCLK system clock. The RTC is active in STANDBY and ACTIVE power states. When the device enters the RESET or SHUTDOWN state the RTC is reset.

The RTC accumulates time elapsed since reset on each LFCLK. The RTC counter is incremented by LFINC at a rate of 32.768kHz. LFINC indicates the period of LFCLK in μs , with an additional granularity of 16 fractional bits.

The counter can be read from two 32-bit registers. RTC.TIME8U has a range of approximately 9.5 hours with an LSB representing 8 microseconds. RTC.TIME524M has a range of approximately 71.4 years with an LSB representing 524 milliseconds.

There is hardware synchronization between the system timer (SYSTIM) and the RTC so that the multichannel and higher resolution SYSTIM remains in synchronization with the RTC's time base.

The RTC has two channels: one compare channel and one capture channel and is capable of waking the device out of the standby power state. The RTC compare channel is typically used only by system software and only during the standby power state.

- **System Timer (SYSTIM)**

The SYSTIM is a 34-bit, 5-channel wrap-around timer with a per-channel selectable 32b slice with either a $1\mu\text{s}$ resolution and 1h11m35s range or 250ns resolution and 17m54s range. All channels support both capture and single-shot compare (posting an event) operation. One channel is reserved for system software, three channels are reserved for radio software and one channel is freely available to user applications.

For software convenience, a hardware synchronization mechanism automatically ensures that the RTC and SYSTIM share a common time base (albeit with different resolutions/spans). Another software convenience feature is that SYSTIM qualifies any submitted compare values so that the timer channel will immediately trigger if the submitted event is in the immediate past (4.294s with $1\mu\text{s}$ resolution and 1.049s with 250ns resolution).

- **General Purpose Timers (LGPT)**

The CC2340R device provides up to four LGPTs with 3×16 bit timers and 1×24 bit timer, all running up to 48MHz. The LGPTs support a wide range of features such as:

- Three capture/compare channels
- One-shot or periodic counting
- Pulse width modulation (PWM)
- Time counting between edges and edge counting
- Input filter implemented on each of the channels for all timers
- IR generation feature available on Timer-0 and Timer-1
- Deadband feature available on Timer-1

The timer capture/compare and PWM signals are connected to IOs through the IO controller module (IOC), and the internal timer event connections to CPU, DMA, and other peripherals are through the event fabric, which allows the timers to interact with signals such as GPIO inputs, other timers, DMA, and ADC. Two LGPTs (2×16 -bit timers) support quadrature decoder mode to enable buffered decoding of quadrature-encoded sensor signals. The LGPTs are available in device Active and Idle power modes.

Table 8-1. Timer Comparison

Feature	Timer 0	Timer 1	Timer 2	Timer 3
Counter Width	16-bit	16-bit	16-bit	24-bit
Quadrature Decoder	Yes	No	Yes	No
Park Mode on Fault	No	Yes	No	No
Programmable Dead-Band Insertion	No	Yes	No	No

Table 8-2. Timer Availability

Part Number	Timer 0	Timer 1	Timer 2	Timer 3
CC2340R21	Yes	Yes	No	No
CC2340R22	Yes	Yes	Yes	Yes
CC2340R52	Yes	Yes	Yes	Yes
CC2340R53	Yes	Yes	Yes	Yes

• **Watchdog timer**

The watchdog timer is used to regain control if the system operates incorrectly due to software errors. Upon counter expiry, the watchdog timer resets the device when periodic monitoring of the system components and tasks fails to verify proper functionality. The watchdog timer runs on a 32kHz clock rate and operates in device active, idle, and standby modes, and cannot be stopped once enabled.

8.7 Serial Peripherals and I/O

The CC2340R device provides 1xUART, 1xSPI, and 1xI2C serial peripherals.

The SPI module supports both SPI controller and peripheral up to 12MHz with configurable phase and polarity.

The UART module implements universal asynchronous receiver and transmitter functions. They support flexible baud-rate generation up to a maximum of 3Mbps and IRDA SIR mode of operation.

The I²C module is used to communicate with devices compatible with the I²C standard. The I²C interface can handle 100kHz and 400kHz operation and can serve as both controller and target.

The I/O controller (IOC) controls the digital I/O pins and contains multiplexer circuitry to allow a set of peripherals to be assigned to I/O pins in a fixed manner over DIOs. All digital I/Os are interrupt and wake-up capable, have a programmable pullup and pulldown function, and can generate an interrupt on a negative or positive edge (configurable). When configured as an output, pins can function as either push-pull, open-drain, or open-source. Some GPIOs have high-drive capabilities, which are marked in **bold** in *Pin Configurations and Functions*.

For more information, see the [CC23xx SimpleLink™ Wireless MCU Technical Reference Manual](#).

8.8 Battery and Temperature Monitor

A combined temperature and battery voltage monitor is available in the CC2340R device. The battery and temperature monitor allows an application to continuously monitor on-chip temperature and supply voltage and respond to changes in environmental conditions as needed. The module contains window comparators to interrupt the system CPU when temperature or supply voltage go outside defined windows. These events can also be used to wake up the device from Standby mode through the Always-On (AON) event fabric.

8.9 μDMA

The device includes a direct memory access (μDMA) controller. The μDMA controller provides a way to offload data-transfer tasks from the system CPU, thus allowing for more efficient use of the processor and the available bus bandwidth. The μDMA controller can perform a transfer between memory and peripherals. The μDMA controller has dedicated channels for each supported on-chip module and can be programmed to automatically perform transfers between peripherals and memory when the peripheral is ready to transfer more data.

Some features of the μDMA controller include the following (this is not an exhaustive list):

- Channel operation of up to 8 channels, with 6 channels having a dedicated peripheral interface and 2 channels having the ability to be triggered via configurable events.
- Transfer modes: memory-to-memory, memory-to-peripheral, peripheral-to-memory, and peripheral-to-peripheral
- Data sizes of 8, 16, and 32 bits
- Ping-pong mode for continuous streaming of data

8.10 Debug

On-chip debug is supported through the serial wire debug (SWD) interface, which is an ARM bi-directional 2-wire protocol that communicates with the JTAG Test Access Port (TAP) controller and allows for complete debug functionality. SWD is fully compatible with Texas Instruments' XDS family of debug probes.

8.11 Power Management

To minimize power consumption, the CC2340R supports a number of power modes and power management features (see [Table 8-3](#)).

Table 8-3. Power Modes

MODE	SOFTWARE CONFIGURABLE POWER MODES ⁽¹⁾				RESET PIN HELD
	ACTIVE	IDLE	STANDBY	SHUTDOWN	
CPU	Active	Off	Off	Off	Off
Flash	On	Available	Off	Off	Off
SRAM	On	On	Retention	Off	Off
Radio	Available	Available	Off	Off	Off
Supply System	On	On	Duty Cycled	Off	Off
CPU register retention	Full	Full	Full ⁽²⁾	No	No
SRAM retention	Full	Full	Full	Off	Off
48 MHz high-speed clock (HFCLK)	HFOSC (tracks HFXT)	HFOSC (tracks HFXT)	Off	Off	Off
32 kHz low-speed clock (LFCLK)	LFXT or LFOSC	LFXT or LFOSC	LFXT or LFOSC	Off	Off
Peripherals	Available	Available	IOC, BATMON, RTC, LPCOMP	Off	Off
Wake-up on RTC	N/A	Available	Available	Off	Off
Wake-up on pin edge	N/A	Available	Available	Available	Off
Wake-up on reset pin	On	On	On	On	On
Brownout detector (BOD)	On	On	Duty Cycled	Off	Off
Power-on reset (POR)	On	On	On	On	On
Watchdog timer (WDT)	Available	Available	Available	Off	Off

- (1) "Available" indicates that the specific IP or feature can be enabled by user application in the corresponding device operating modes. "On" indicates that the specific IP or feature is turned on, irrespective of the user application configuration of the device in the corresponding device operating mode. "Off" indicates that the specific IP or feature is turned off and not available for the user application in the corresponding device operating mode.
- (2) Software-based retention of CPU registers with context save and restore when entering and exiting standby power mode

In the **Active** mode, both of MCU and AON power domains are powered. Clock gating is used to minimize power consumption. Clock gating to peripherals/subsystems is controlled manually by the CPU.

In **Idle** mode, the CPU is in sleep, but selected peripherals and subsystems (such as the radio) can be active. Infrastructure (Flash, ROM, SRAM, bus) clock gating is possible depending on the state of the DMA and debug subsystem.

In **Standby** mode, only the always-on (AON) domain is active. An external wake-up event, RTC event, or comparator event (LP-COMP) is required to bring the device back to active mode. Pin Reset will also drive the device from Standby to Active. MCU peripherals with retention do not need to be reconfigured when waking up again, and the CPU continues execution from where it went into standby mode. All GPIOs are latched in standby mode.

In **Shutdown** mode, the device is entirely turned off (including the AON domain), and the I/Os are latched with the value they had before entering shutdown mode. A change of state on any I/O pin defined as a *wake from shutdown pin* wakes up the device and functions as a reset trigger. The CPU can differentiate between reset in this way and reset-by-reset pin or power-on reset by reading the reset status register. The only states retained in this mode are the latched I/O state, the 3V register bank, and the flash memory contents.

Note

The power, RF, and clock management for the CC2340R device requires specific configuration and handling by software for optimized performance. This configuration and handling is implemented in the TI-provided drivers that are part of the CC2340R software development kit (SDK). Therefore, TI highly recommends using this software framework for all application development on the device. The complete [SDK](#) with FreeRTOS, device drivers, and examples are offered free of charge in source code.

8.12 Clock Systems

The CC2340R device has the following internal system clocks.

The 48MHz HFCLK is used as the main system (MCU and peripherals) clock. This is driven by the internal 48MHz RC Oscillator (HFOSC), which can track its accuracy against an external 48MHz crystal (HFXT). Radio operation requires an external 48MHz crystal.

The 32.768kHz LFCLK is used as the internal low-frequency system clock. It is used for the RTC, the watchdog timer (if enabled in standby power mode), and to synchronize the radio timer before or after Standby power mode. LFCLK can be driven by the internal 32.8kHz RC Oscillator (LFOSC), a 32.768kHz watch-type crystal, or a clock input in LFXT bypass mode. When using a crystal or the internal RC oscillator, the device can output the 32kHz LFCLK signal to other devices, thereby reducing the overall system cost.

8.13 Network Processor

Depending on the product configuration, the CC2340R device can function as a wireless network processor (WNP), a device running the wireless protocol stack with the application running on a separate host MCU, or as a system-on-chip (SoC), with the application and protocol stack running on the system CPU inside the device.

In the first case, the external host MCU communicates with the device using SPI or UART. In the second case, the application must be written according to the application framework supplied with the wireless protocol stack.

9 Application, Implementation, and Layout

Note

Information in the following applications sections is not part of the TI component specification, and TI does not warrant its accuracy or completeness. TI's customers are responsible for determining suitability of components for their purposes, as well as validating and testing their design implementation to confirm system functionality.

9.1 Reference Designs

The following reference designs should be followed closely when implementing designs using the CC2340R devices.

Special attention must be paid to RF component placement, decoupling capacitors, and DCDC regulator components, as well as ground connections for all of these.

- [LP-EM-CC2340R5 Design Files](#) The CC2340R5 LaunchPad Design Files contain detailed schematics and layouts to build application-specific boards using the CC2340R devices in the 5mm x 5mm RKP package.
- [LP-EM-CC2340R53 Design Files](#) The CC2340R53 LaunchPad Design Files contain detailed schematics and layouts to build application-specific boards using the CC2340R devices in the 5mm x 5mm RKP package.
- [LP-EM-CC2340R5-RGE-4x4-IS24 Design Files](#) The CC2340R5 RGE 4x4 LaunchPad Design Files contain detailed schematics and layouts to build application-specific boards using the CC2340R devices in the 4mm x 4mm RGE package. The CC2340R5x and CC2340R2x devices in RGE packages are pin-to-pin compatible.
- [LP-EM-CC2340R53-BG](#) The CC2340R5 YBG WCSP LaunchPad Design Files contain detailed schematics and layouts to build application-specific boards using the CC2340R devices in the WCSP YBG package.
- [Sub1 GHz and 2.4 GHz Antenna Kit for LaunchPad™ Development Kit and SensorTag](#) The antenna kit allows real-life testing to identify the optimal antenna for your application. The antenna kit includes 16 antennas for frequencies from 169MHz to 2.4GHz, including:
- PCB antennas
 - Helical antennas
 - Chip antennas
 - Dualband antennas for 868MHz and 915MHz combined with 2.4GHz
- The antenna kit includes a JSC cable to connect to the Wireless MCU LaunchPad Development Kits and SensorTags.

9.2 Junction Temperature Calculation

This section shows the different techniques for calculating the junction temperature under various operating conditions. For more details, see [Semiconductor and IC Package Thermal Metrics](#).

There are two recommended ways to derive the junction temperature from other measured temperatures:

1. From package temperature:

$$T_J = \psi_{JT} \times P + T_{\text{case}} \quad (1)$$

2. From board temperature:

$$T_J = \psi_{JB} \times P + T_{\text{board}} \quad (2)$$

P is the power dissipated from the device and can be calculated by multiplying the current consumption by the supply voltage. Thermal resistance coefficients are found in *Thermal Resistance Characteristics*.

Example:

In this example, we assume a simple use case where the radio is transmitting continuously at 0dBm output power. Let us assume we want to maintain a junction temperature equal or less than 85°C and the supply voltage is 3V. Using Equation 1, the temperature difference between the top of the case and the junction temperature is calculated. To calculate P, look up the current consumption for Tx at 85°C. At 85°C, the current consumption is approximately 5.5mA. This means that P is 5.5mA × 3V = 16.5mW.

The maximum case temperature to maintain and junction temperature of 85°C is then calculated as:

$$T_{\text{case}} < T_J - 0.4^{\circ}\text{C}/\text{W} \times 23.4\text{mW} = 84.99^{\circ}\text{C} \quad (3)$$

For various application use cases, current consumption for other modules may have to be added to calculate the appropriate power dissipation. For example, the MCU may be running simultaneously as the radio, peripheral modules may be enabled, and so on. Typically, the easiest way to find the peak current consumption, and thus the peak power dissipation in the device, is to measure as described in the [Measuring CC13xx and CC26xx Current Consumption](#) application report.

10 Device and Documentation Support

TI offers an extensive line of development tools. Tools and software to evaluate the performance of the device, generate code, and develop solutions are listed as follows.

10.1 Device Nomenclature

To designate the stages in the product development cycle, TI assigns prefixes to all part numbers and/or date-code. Each device has one of three prefixes/identifications: X, P, or null (no prefix) (for example, X is in preview; therefore, an X prefix/identification is assigned).

Device development evolutionary flow:

- X** Experimental device that is not necessarily representative of the final device's electrical specifications and may not use production assembly flow.
- P** Prototype device that is not necessarily the final silicon die and may not necessarily meet final electrical specifications.
- null** Production version of the silicon die that is fully qualified.

Production devices have been characterized fully, and the quality and reliability of the device have been demonstrated fully. TI's standard warranty applies.

Predictions show that prototype devices (X or P) have a greater failure rate than the standard production devices. Texas Instruments recommends that these devices not be used in any production system because their expected end-use failure rate still is undefined. Only qualified production devices are to be used.

TI device nomenclature also includes a suffix with the device family name. This suffix indicates the package type (for example, *RKP*).

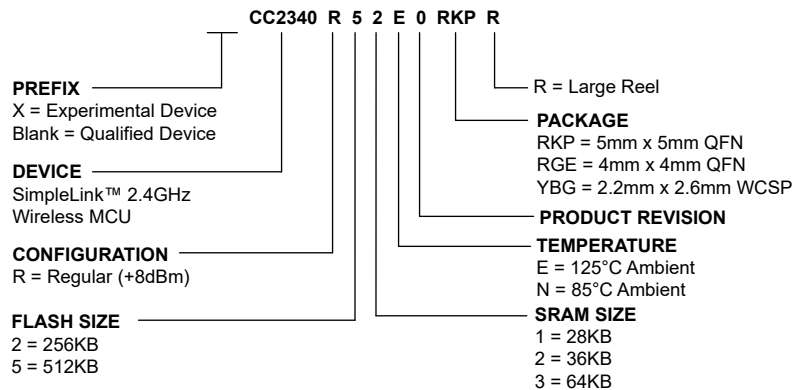

Figure 10-1. Device Nomenclature

10.2 Tools and Software

The CC2340R device is supported by a variety of software and hardware development tools.

Development Kit

[CC2340R53
LaunchPad™
Development Kit](#)

The CC2340R53 LaunchPad™ Development Kit enables development of high-performance wireless applications that benefit from low-power operation. The kit features the CC2340R53 SimpleLink Wireless MCU, which allows you to quickly evaluate and prototype 2.4GHz wireless applications such as Bluetooth Low Energy, Zigbee, and Thread. The kit works with the LaunchPad ecosystem, enabling additional functionality like sensors, display, and more.

Software

SimpleLink™ Low Power F3 software development kit (SDK)

The SimpleLink™ Low Power F3 software development kit (SDK) provides a complete package for the development of wireless applications on the CC2340R family of devices. The SDK includes a comprehensive software package for the CC2340R device, including the following protocol stacks:

- Bluetooth Low Energy
- Zigbee 3.x

The SimpleLink Low Power F3 SDK is part of TI's SimpleLink MCU platform, offering a single development environment that delivers flexible hardware, software, and tool options for customers developing wired and wireless applications. For more information about the SimpleLink MCU Platform, visit <https://www.ti.com/simplelink>.

Zephyr

Our Zephyr stack delivers a fully certified open-source and portable Bluetooth solution while maintaining low power, enabled by TI's Bluetooth LE Controller. Through a TI-managed downstream branch, we ensure faster delivery, bug fixes, and controlled updates for CC2340 and CC2755 devices.

Customers benefit from portability across silicon vendors, extensive testing with Twister, Ztest frameworks and additional validation, plus a complete production-ready SDK and TI tool ecosystem.

Development Tools

Code Composer Studio™ Integrated Development Environment (IDE)

Code Composer Studio is an integrated development environment (IDE) that supports TI's Microcontroller and Embedded Processors portfolio. Code Composer Studio comprises a suite of tools used to develop and debug embedded applications. It includes an optimizing C/C++ compiler, source code editor, project build environment, debugger, profiler, and many other features. The intuitive IDE provides a single user interface, taking you through each step of the application development flow. Familiar tools and interfaces allow users to get started faster than ever before.

CCS has support for all SimpleLink Wireless MCUs and includes support for EnergyTrace™ software (application energy usage profiling).

Code Composer Studio is provided free of charge when used in conjunction with the XDS debuggers included on a LaunchPad Development Kit.

Code Composer Studio™ Cloud IDE

Code Composer Studio (CCS) Cloud is a web-based IDE that allows you to create, edit, and build CCS projects. After you have successfully built your project, you can download and run it on your connected LaunchPad. Basic debugging, including features like setting breakpoints and viewing variable values, is now supported with CCS Cloud.

IAR Embedded Workbench® for Arm®

IAR Embedded Workbench® is a set of development tools for building and debugging embedded system applications using Assembler, C, and C++. It provides a completely integrated development environment that includes a project manager, editor, and build tools. IAR has support for all SimpleLink Wireless MCUs. It offers broad debugger support, including XDS110, IAR I-jet™, and Segger J-Link™. IAR is also supported out-of-the-box on most software examples provided as part of the SimpleLink SDK.

SmartRF™ Studio

SmartRF™ Studio is a Windows® application that can be used to evaluate and configure SimpleLink Wireless MCUs from Texas Instruments. The application will help designers of RF systems to easily evaluate the radio at an early stage in the design process. It is especially useful for the generation of configuration register values and for practical testing and debugging of the RF system. SmartRF Studio can be used either as a standalone

application or together with applicable evaluation boards or debug probes for the RF device. Features of the SmartRF Studio include:

- Link tests—send and receive packets between nodes
- Antenna and radiation tests—set the radio in continuous wave TX and RX states
- Export radio configuration code for use with the TI SimpleLink SDK RF driver
- Custom GPIO configuration for signaling and control of external switches

UniFlash

UniFlash is a standalone tool used to program on-chip flash memory on TI MCUs. UniFlash has a GUI, command line, and scripting interface. UniFlash is available free of charge.

10.2.1 SimpleLink™ Microcontroller Platform

The SimpleLink microcontroller platform sets a new standard for developers with the broadest portfolio of wired and wireless Arm® MCUs (System-on-Chip) in a single software development environment. Delivering flexible hardware, software and tool options for your IoT applications. Invest once in the SimpleLink software development kit and use throughout your entire portfolio. Learn more at ti.com/simplelink.

10.3 Documentation Support

To receive notification of documentation updates on data sheets, errata, application notes, and similar, navigate to the device product folder ([CC2340R5](#)). In the upper right corner, click on *Alert me* to register and receive a weekly digest of any product information that has changed. For change details, review the revision history included in any revised document.

The current documentation that describes the MCU, related peripherals, and other technical collateral is listed as follows.

TI Resource Explorer

[TI Resource Explorer](#) Software examples, libraries, executables, and documentation are available for your device and development board.

Errata

[CC2340R Silicon Errata](#) The silicon errata describes the known exceptions to the functional specifications for each silicon revision of the device and describes how to recognize a device revision.

Application Reports

All application reports for the CC2340R devices are found on the device product folder ([CC2340R2](#) or [CC2340R5](#)).

Technical Reference Manual (TRM)

[CC23xx SimpleLink™ Wireless MCU TRM](#) The TRM provides a detailed description of all modules and peripherals available in the device family.

10.4 Support Resources

[TI E2E™ support forums](#) are an engineer's go-to source for fast, verified answers and design help — straight from the experts. Search existing answers or ask your own question to get the quick design help you need.

Linked content is provided "AS IS" by the respective contributors. They do not constitute TI specifications and do not necessarily reflect TI's views; see TI's [Terms of Use](#).

10.5 Trademarks

SimpleLink™, LaunchPad™, Code Composer Studio™, EnergyTrace™, and TI E2E™ are trademarks of Texas Instruments.

I-jet™ is a trademark of IAR Systems AB.

J-Link™ is a trademark of SEGGER Microcontroller Systems GmbH.
 Arm® and Cortex® are registered trademarks of Arm Limited (or its subsidiaries) in the US and/or elsewhere.
 Bluetooth® is a registered trademark of Bluetooth SIG.
 CoreMark® is a registered trademark of Embedded Microprocessor Benchmark Consortium Corporation.
 is a registered trademark of Bluetooth SIG.
 Wi-Fi® is a registered trademark of Wi-Fi Alliance.
 IAR Embedded Workbench® is a registered trademark of IAR Systems AB.
 Windows® is a registered trademark of Microsoft Corporation.
 All trademarks are the property of their respective owners.

10.6 Electrostatic Discharge Caution



This integrated circuit can be damaged by ESD. Texas Instruments recommends that all integrated circuits be handled with appropriate precautions. Failure to observe proper handling and installation procedures can cause damage.

ESD damage can range from subtle performance degradation to complete device failure. Precision integrated circuits may be more susceptible to damage because very small parametric changes could cause the device not to meet its published specifications.

10.7 Glossary

[TI Glossary](#) This glossary lists and explains terms, acronyms, and definitions.

11 Revision History

NOTE: Page numbers for previous revisions may differ from page numbers in the current version.

Changes from Revision E (September 2024) to Revision F (September 2025)	Page
• Added IR Generation to timer features.....	1
• Removed preview status for WCSP (YBG) package.....	1
• Updated formatting and corrected typos throughout the document.....	1
• Updated features descriptions.....	1
• Included DIO18 in list of high drive pins (YBG) package.....	8
• Updated footnote in Absolute Maximum table.....	18
• Updated DCDC footnote.....	18
• Updated thermal characteristics for YBG package.....	21
• Updated SPI peripheral CS timing.....	29
• Updated Bluetooth Low Energy description.....	44

Changes from Revision D (June 2024) to Revision E (September 2024)	Page
• Updated the SDK name throughout the data sheet.....	1
• Updated CC2340R53E0RKPR from Preview to Released.....	2
• Corrected pin pitch in pin diagram title.....	6
• Corrected pin pitch in diagram title.....	8
• Updated the description of software and tools.....	53

Changes from Revision C (June 2023) to Revision D (June 2024)	Page
• Combined all CC2340R family of devices to a single data sheet.....	1
• Added all devices in CC2340R family.....	2
• Changed the comparison table to the CC2340R family of devices.....	5
• Added preview for YBG package.....	8
• Removed "Untrimmed brownout rising threshold".....	19
• Updated parameter name of "Trimmed brownout rising threshold".....	19
• Updated parameter name of "Trimmed brownout falling threshold".....	19

• Changed Temperature Sensor " Accuracy".....	19
• Changed DCDC "Idle Current - Supply Systems and RAM powered, flash disabled, DMA disabled ".....	19
• Changed DCDC "Idle Current - Supply Systems and RAM powered, flash disabled, DMA enabled".....	19
• Changed DCDC "Idle Current - Supply Systems and RAM powered, flash enabled, DMA disabled".....	19
• Changed DCDC "Idle Current - Supply Systems and RAM powered, flash enabled, DMA enabled".....	19
• Changed GLDO "Idle Current - Supply Systems and RAM powered, flash disabled, DMA disabled".....	19
• Changed GLDO "Idle Current - Supply Systems and RAM powered, flash disabled, DMA enabled".....	19
• Changed GLDO "Idle Current - Supply Systems and RAM powered, flash enabled, DMA disabled".....	19
• Changed GLDO "Idle Current - Supply Systems and RAM powered, flash enabled, DMA enabled ".....	19
• Changed "Reset current".....	19
• Changed "Shutdown Current".....	19
• Changed "Radio transmit current at -8 dBm".....	20
• Changed "Radio transmit current at 0 dBm, DCDC OFF".....	20
• Changed "Radio transmit current at +4 dBm".....	20
• Changed "Flash write time".....	20
• Changed "Frequency error tolerance" for 500kbps BLE PHY.....	21
• Changed "Data rate error tolerance" for 1Mbps BLE PHY.....	21
• Updated footnote 1 in Section 8.14 "Bluetooth Low Energy - Receive (RX)".....	21
• Changed "Selectivity, +3MHz" for 1Mbps BLE PHY.....	21
• Changed "Data rate error tolerance" for 2Mbps BLE PHY.....	21
• Changed "f > 1 GHz, including harmonics".....	26
• Changed min value of "Crystal load capacitance".....	26
• Removed "Temperature coefficient".....	27
• Changed "SPI clock frequency".....	27
• Added footnote (1).....	27
• Changed "CS access time, CS active to POCI data out - VDDS=3.3V".....	29
• Changed "CS access time, CS active to POCI data out - VDDS=1.8V".....	29
• Changed "CS disable time, CS inactive to POCI high inpedance - VDDS=3.3V".....	29
• Changed "CS disable time, CS inactive to POCI high impedance - VDDS=1.8V".....	29
• Changed "PICO input data setup time".....	29
• Changed "POCI output data valid time" at 3.3V.....	29
• Removed "(4)" from test conditions.....	29
• Changed "POCI output data valid time" at 1.8V.....	29
• Removed "(4)" from test conditions.....	29
• Added "Data setup time" at f_SCL = 100kHz.....	31
• Changed "Data setup time" at f_SCL > 100kHz.....	31
• Changed "GPIO pullup current" at 1.8V.....	31
• Changed "GPIO pulldown current" at 1.8V.....	31
• Changed "GPIO low-to-high input transition, with hysteresis" at 1.8V.....	31
• Changed "GPIO high-to-low input transition, with hysteresis" at 1.8V.....	31
• Changed "GPIO input hysteresis" at 1.8V.....	31
• Changed "GPIO VOH at 10 mA load" at 3.0V.....	31
• Changed "GPIO VOL at 10 mA load" at 3.0V.....	31
• Changed "GPIO VOH at 2 mA load" at 3.0V.....	31
• Changed "GPIO VOL at 2 mA load" at 3.0V.....	31
• Changed "GPIO pullup current" at 3.8V.....	31
• Changed "GPIO pulldown current" at 3.8V.....	31
• Changed "GPIO low-to-high input transition, with hysteresis" at 3.8V.....	31
• Changed "GPIO high-to-low input transition, with hysteresis" at 3.8V.....	31
• Changed "GPIO input hysteresis" at 3.8V.....	31
• Added "Temperature Error" of Temp diode inside ADC.....	32
• Changed "Ultra-low power comparator current consumption".....	35
• Added performance plots.....	35

- Corrected timer features.....45
- Updated descriptions.....49

12 Mechanical, Packaging, and Orderable Information

The following pages include mechanical packaging and orderable information. This information is the most current data available for the designated devices. This data is subject to change without notice and revision of this document. For browser-based versions of this data sheet, refer to the left-hand navigation.

EXAMPLE BOARD LAYOUT

YBG0028-C01

DSBGA - 0.5 mm max height

DIE SIZE BALL GRID ARRAY

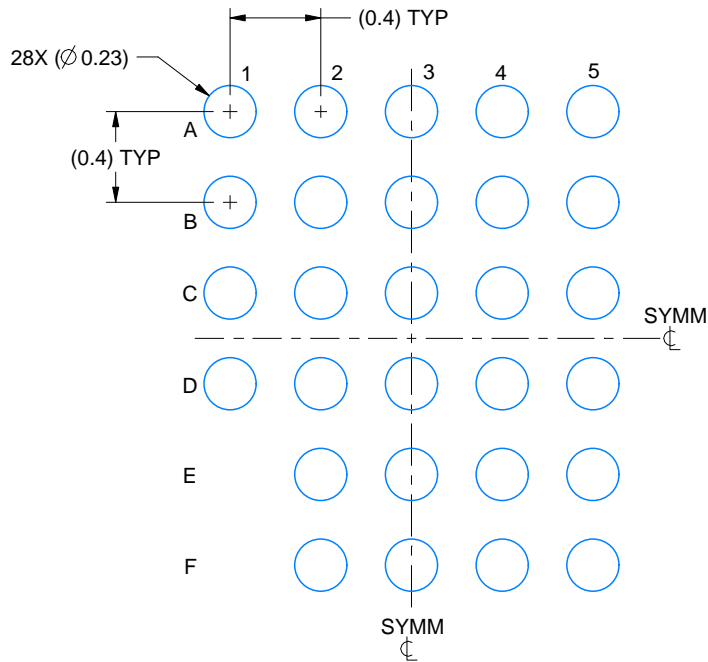

LAND PATTERN EXAMPLE
EXPOSED METAL SHOWN
SCALE: 30X

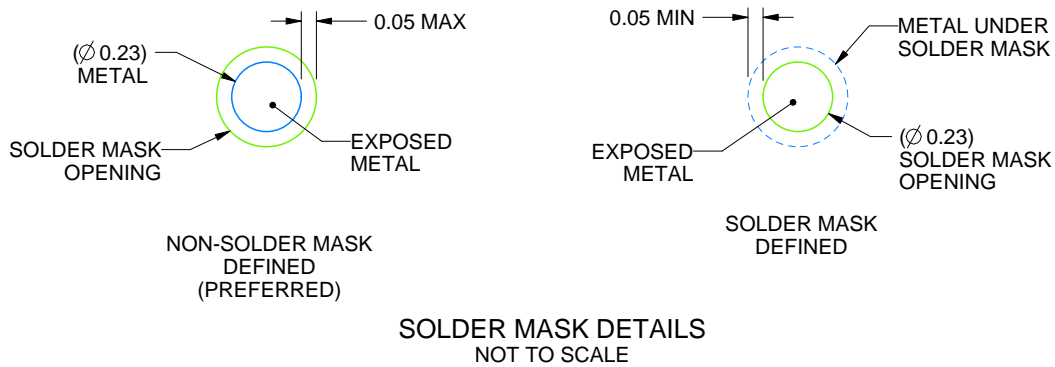

SOLDER MASK DETAILS
NOT TO SCALE

4230507/A 02/2024

NOTES: (continued)

- Final dimensions may vary due to manufacturing tolerance considerations and also routing constraints. See Texas Instruments Literature No. SNVA009 (www.ti.com/lit/snva009).

EXAMPLE STENCIL DESIGN

YBG0028-C01

DSBGA - 0.5 mm max height

DIE SIZE BALL GRID ARRAY

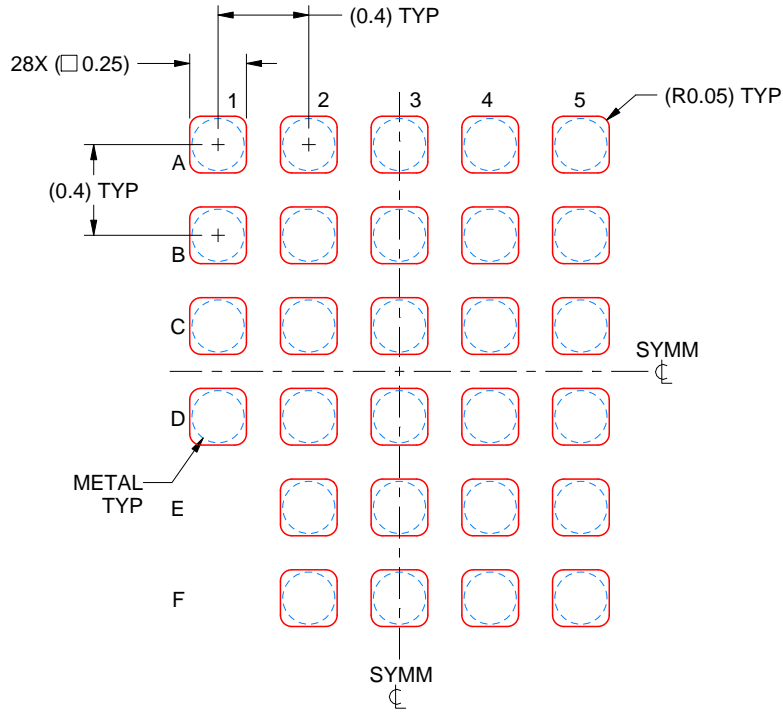

SOLDER PASTE EXAMPLE
BASED ON 0.1 mm THICK STENCIL
SCALE: 30X

4230507/A 02/2024

NOTES: (continued)

4. Laser cutting apertures with trapezoidal walls and rounded corners may offer better paste release.

PACKAGING INFORMATION

Orderable part number	Status (1)	Material type (2)	Package Pins	Package qty Carrier	RoHS (3)	Lead finish/ Ball material (4)	MSL rating/ Peak reflow (5)	Op temp (°C)	Part marking (6)
CC2340R21N0RGER	Active	Production	VQFN (RGE) 24	3000 LARGE T&R	Yes	NIPDAU	Level-3-260C-168 HR	-40 to 85	CC2340 R21
CC2340R21N0RGER.A	Active	Production	VQFN (RGE) 24	3000 LARGE T&R	Yes	NIPDAU	Level-3-260C-168 HR	-40 to 85	CC2340 R21
CC2340R22E0RKPR	Active	Production	VQFN (RKP) 40	3000 LARGE T&R	Yes	NIPDAU	Level-3-260C-168 HR	-40 to 125	CC2340 R22
CC2340R22E0RKPR.A	Active	Production	VQFN (RKP) 40	3000 LARGE T&R	Yes	NIPDAU	Level-3-260C-168 HR	-40 to 125	CC2340 R22
CC2340R22E0RKPR.B	Active	Production	VQFN (RKP) 40	3000 LARGE T&R	Yes	NIPDAU	Level-3-260C-168 HR	-40 to 125	CC2340 R22
CC2340R22N0RKPR	Active	Production	VQFN (RKP) 40	3000 LARGE T&R	Yes	NIPDAU	Level-3-260C-168 HR	-40 to 85	CC2340 R22
CC2340R22N0RKPR.A	Active	Production	VQFN (RKP) 40	3000 LARGE T&R	Yes	NIPDAU	Level-3-260C-168 HR	-40 to 85	CC2340 R22
CC2340R22N0RKPR.B	Active	Production	VQFN (RKP) 40	3000 LARGE T&R	Yes	NIPDAU	Level-3-260C-168 HR	-40 to 85	CC2340 R22
CC2340R52E0RGER	Active	Production	VQFN (RGE) 24	3000 LARGE T&R	Yes	Call TI Sn Nipdau	Level-3-260C-168 HR	-40 to 125	CC2340 R52
CC2340R52E0RGER.A	Active	Production	VQFN (RGE) 24	3000 LARGE T&R	Yes	Call TI	Level-3-260C-168 HR	-40 to 125	CC2340 R52
CC2340R52E0RGER.B	Active	Production	VQFN (RGE) 24	3000 LARGE T&R	Yes	Call TI	Level-3-260C-168 HR	-40 to 125	CC2340 R52
CC2340R52E0RKPR	Active	Production	VQFN (RKP) 40	3000 LARGE T&R	Yes	Call TI Sn Nipdau	Level-3-260C-168 HR	-40 to 125	CC2340 R52
CC2340R52E0RKPR.A	Active	Production	VQFN (RKP) 40	3000 LARGE T&R	Yes	NIPDAU	Level-3-260C-168 HR	-40 to 125	CC2340 R52
CC2340R52E0RKPR.B	Active	Production	VQFN (RKP) 40	3000 LARGE T&R	Yes	NIPDAU	Level-3-260C-168 HR	-40 to 125	CC2340 R52
CC2340R52N0RGER	Active	Production	VQFN (RGE) 24	3000 LARGE T&R	Yes	NIPDAU	Level-3-260C-168 HR	-40 to 85	CC2340 R52
CC2340R52N0RGER.A	Active	Production	VQFN (RGE) 24	3000 LARGE T&R	Yes	NIPDAU	Level-3-260C-168 HR	-40 to 85	CC2340 R52

Orderable part number	Status (1)	Material type (2)	Package Pins	Package qty Carrier	RoHS (3)	Lead finish/ Ball material (4)	MSL rating/ Peak reflow (5)	Op temp (°C)	Part marking (6)
CC2340R52N0RGER.B	Active	Production	VQFN (RGE) 24	3000 LARGE T&R	Yes	NIPDAU	Level-3-260C-168 HR	-40 to 85	CC2340 R52
CC2340R52N0RKPR	Active	Production	VQFN (RKP) 40	3000 LARGE T&R	Yes	NIPDAU	Level-3-260C-168 HR	-40 to 85	CC2340 R52
CC2340R52N0RKPR.A	Active	Production	VQFN (RKP) 40	3000 LARGE T&R	Yes	NIPDAU	Level-3-260C-168 HR	-40 to 85	CC2340 R52
CC2340R52N0RKPR.B	Active	Production	VQFN (RKP) 40	3000 LARGE T&R	Yes	NIPDAU	Level-3-260C-168 HR	-40 to 85	CC2340 R52
CC2340R53E0RKPR	Active	Production	VQFN (RKP) 40	3000 LARGE T&R	Yes	NIPDAU	Level-2-260C-1 YEAR	-40 to 125	CC2340 R53
CC2340R53E0RKPR.A	Active	Production	VQFN (RKP) 40	3000 LARGE T&R	Yes	NIPDAU	Level-2-260C-1 YEAR	-40 to 125	CC2340 R53
CC2340R53E0YBGR	Active	Production	DSBGA (YBG) 28	3000 LARGE T&R	Yes	SNAGCU	Level-1-260C-UNLIM	-40 to 125	CC2340R53
CC2340R53N0RKPR	Active	Production	VQFN (RKP) 40	3000 LARGE T&R	Yes	NIPDAU	Level-2-260C-1 YEAR	-40 to 85	CC2340 R53
CC2340R53N0RKPR.A	Active	Production	VQFN (RKP) 40	3000 LARGE T&R	Yes	NIPDAU	Level-2-260C-1 YEAR	-40 to 85	CC2340 R53

(1) **Status:** For more details on status, see our [product life cycle](#).

(2) **Material type:** When designated, preproduction parts are prototypes/experimental devices, and are not yet approved or released for full production. Testing and final process, including without limitation quality assurance, reliability performance testing, and/or process qualification, may not yet be complete, and this item is subject to further changes or possible discontinuation. If available for ordering, purchases will be subject to an additional waiver at checkout, and are intended for early internal evaluation purposes only. These items are sold without warranties of any kind.

(3) **RoHS values:** Yes, No, RoHS Exempt. See the [TI RoHS Statement](#) for additional information and value definition.

(4) **Lead finish/Ball material:** Parts may have multiple material finish options. Finish options are separated by a vertical ruled line. Lead finish/Ball material values may wrap to two lines if the finish value exceeds the maximum column width.

(5) **MSL rating/Peak reflow:** The moisture sensitivity level ratings and peak solder (reflow) temperatures. In the event that a part has multiple moisture sensitivity ratings, only the lowest level per JEDEC standards is shown. Refer to the shipping label for the actual reflow temperature that will be used to mount the part to the printed circuit board.

(6) **Part marking:** There may be an additional marking, which relates to the logo, the lot trace code information, or the environmental category of the part.

Multiple part markings will be inside parentheses. Only one part marking contained in parentheses and separated by a "~" will appear on a part. If a line is indented then it is a continuation of the previous line and the two combined represent the entire part marking for that device.

Important Information and Disclaimer: The information provided on this page represents TI's knowledge and belief as of the date that it is provided. TI bases its knowledge and belief on information provided by third parties, and makes no representation or warranty as to the accuracy of such information. Efforts are underway to better integrate information from third parties. TI has taken and continues to take reasonable steps to provide representative and accurate information but may not have conducted destructive testing or chemical analysis on incoming materials and chemicals. TI and TI suppliers consider certain information to be proprietary, and thus CAS numbers and other limited information may not be available for release.

In no event shall TI's liability arising out of such information exceed the total purchase price of the TI part(s) at issue in this document sold by TI to Customer on an annual basis.

OTHER QUALIFIED VERSIONS OF CC2340R5 :

- Automotive : [CC2340R5-Q1](#)

NOTE: Qualified Version Definitions:

- Automotive - Q100 devices qualified for high-reliability automotive applications targeting zero defects

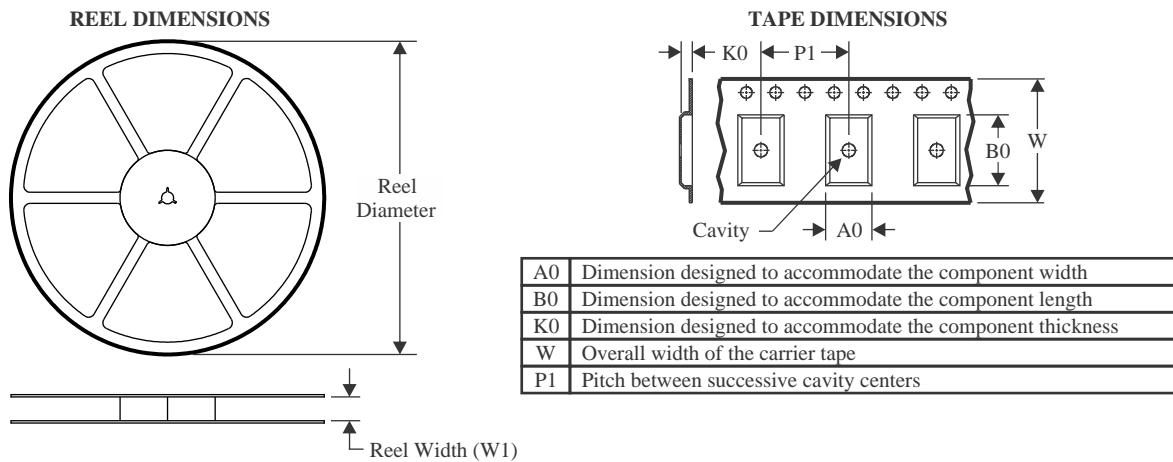
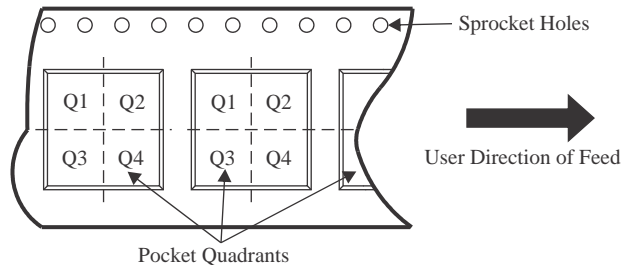
TAPE AND REEL INFORMATION

QUADRANT ASSIGNMENTS FOR PIN 1 ORIENTATION IN TAPE

*All dimensions are nominal

Device	Package Type	Package Drawing	Pins	SPQ	Reel Diameter (mm)	Reel Width W1 (mm)	A0 (mm)	B0 (mm)	K0 (mm)	P1 (mm)	W (mm)	Pin1 Quadrant
CC2340R21N0RGER	VQFN	RGE	24	3000	330.0	12.4	4.3	4.3	1.3	8.0	12.0	Q2
CC2340R22E0RKPR	VQFN	RKP	40	3000	330.0	12.4	5.3	5.3	1.3	8.0	12.0	Q2
CC2340R22N0RKPR	VQFN	RKP	40	3000	330.0	12.4	5.3	5.3	1.3	8.0	12.0	Q2
CC2340R52E0RGER	VQFN	RGE	24	3000	330.0	12.4	4.3	4.3	1.3	8.0	12.0	Q2
CC2340R52E0RGER	VQFN	RGE	24	3000	330.0	12.4	4.25	4.25	1.15	8.0	12.0	Q2
CC2340R52E0RKPR	VQFN	RKP	40	3000	330.0	12.4	5.3	5.3	1.1	8.0	12.0	Q2
CC2340R52N0RGER	VQFN	RGE	24	3000	330.0	12.4	4.3	4.3	1.3	8.0	12.0	Q2
CC2340R52N0RGER	VQFN	RGE	24	3000	330.0	12.4	4.25	4.25	1.15	8.0	12.0	Q2
CC2340R52N0RKPR	VQFN	RKP	40	3000	330.0	12.4	5.3	5.3	1.3	8.0	12.0	Q2
CC2340R53E0RKPR	VQFN	RKP	40	3000	330.0	12.4	5.3	5.3	1.3	8.0	12.0	Q2
CC2340R53E0YBGR	DSBGA	YBG	28	3000	180.0	8.4	2.36	2.77	0.65	4.0	8.0	Q1
CC2340R53N0RKPR	VQFN	RKP	40	3000	330.0	12.4	5.3	5.3	1.3	8.0	12.0	Q2

TAPE AND REEL BOX DIMENSIONS

*All dimensions are nominal

Device	Package Type	Package Drawing	Pins	SPQ	Length (mm)	Width (mm)	Height (mm)
CC2340R21N0RGER	VQFN	RGE	24	3000	353.0	353.0	32.0
CC2340R22E0RKPR	VQFN	RKP	40	3000	353.0	353.0	32.0
CC2340R22N0RKPR	VQFN	RKP	40	3000	353.0	353.0	32.0
CC2340R52E0RGER	VQFN	RGE	24	3000	353.0	353.0	32.0
CC2340R52E0RGER	VQFN	RGE	24	3000	367.0	367.0	35.0
CC2340R52E0RKPR	VQFN	RKP	40	3000	367.0	367.0	35.0
CC2340R52N0RGER	VQFN	RGE	24	3000	353.0	353.0	32.0
CC2340R52N0RGER	VQFN	RGE	24	3000	367.0	367.0	35.0
CC2340R52N0RKPR	VQFN	RKP	40	3000	353.0	353.0	32.0
CC2340R53E0RKPR	VQFN	RKP	40	3000	353.0	353.0	32.0
CC2340R53E0YBGR	DSBGA	YBG	28	3000	182.0	182.0	20.0
CC2340R53N0RKPR	VQFN	RKP	40	3000	353.0	353.0	32.0

GENERIC PACKAGE VIEW

RKP 40

VQFN - 1 mm max height

5 x 5, 0.4 mm pitch

PLASTIC QUAD FLATPACK - NO LEAD

This image is a representation of the package family, actual package may vary.
Refer to the product data sheet for package details.

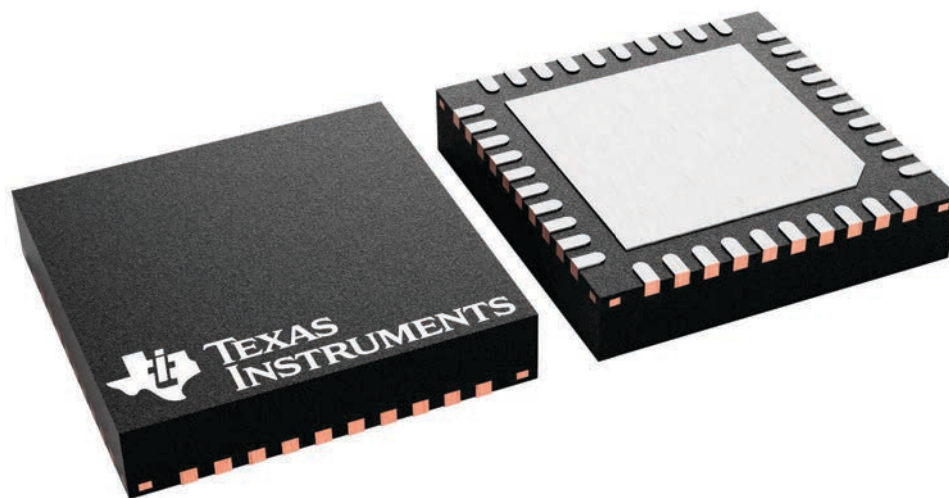

4229305/A

EXAMPLE BOARD LAYOUT

RKP0040B

VQFN - 1 mm max height

PLASTIC QUAD FLATPACK- NO LEAD

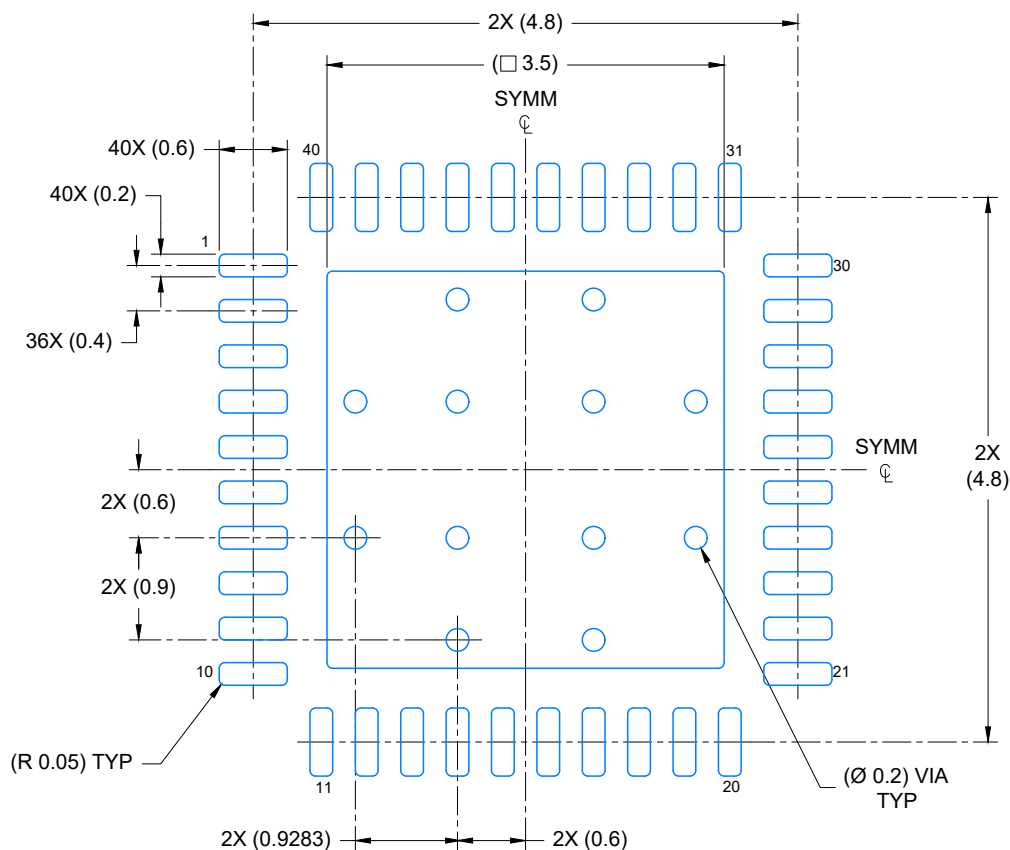

LAND PATTERN EXAMPLE

EXPOSED METAL SHOWN

SCALE: 15X

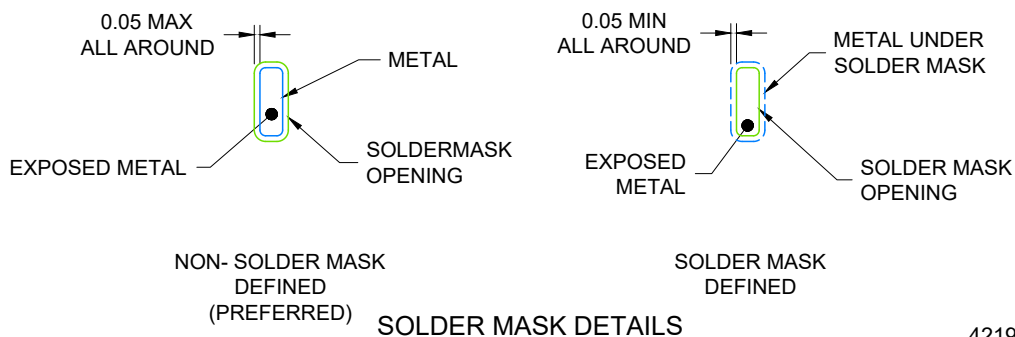

NON- SOLDER MASK
DEFINED
(PREFERRED)

SOLDER MASK
DEFINED

SOLDER MASK DETAILS

4219083/A 03/2021

NOTES: (continued)

4. This package is designed to be soldered to a thermal pad on the board. For more information, see Texas Instruments literature number SLUA271 (www.ti.com/lit/sluea271).
5. Vias are optional depending on application, refer to device data sheet. If any vias are implemented, refer to their locations shown on this view. It is recommended that vias under paste be filled, plugged or tented.

EXAMPLE STENCIL DESIGN

VQFN - 1 mm max height

RKP0040B

PLASTIC QUAD FLATPACK- NO LEAD

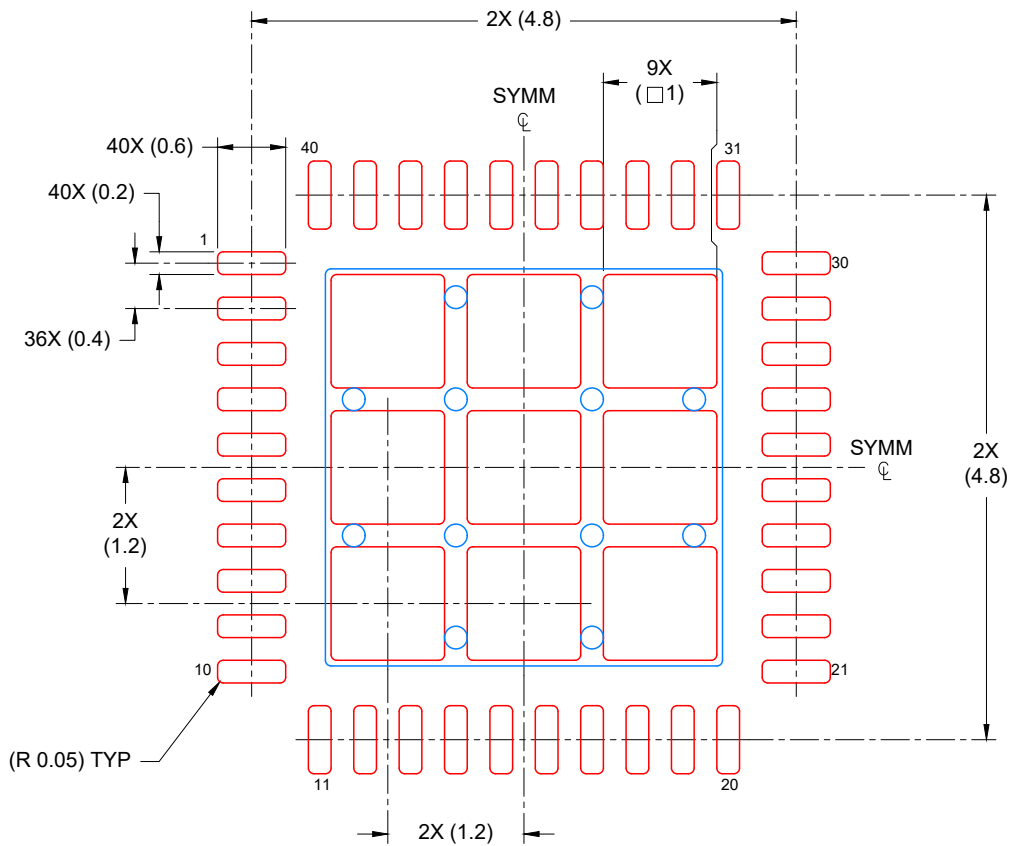

SOLDER PASTE EXAMPLE
BASED ON 0.125 mm THICK STENCIL

EXPOSED PAD
74% PRINTED COVERAGE BY AREA
SCALE: 15X

4219083/A 03/2021

NOTES: (continued)

6. Laser cutting apertures with trapezoidal walls and rounded corners may offer better paste release. IPC-7525 may have alternate design recommendations.

RGE 24

GENERIC PACKAGE VIEW

VQFN - 1 mm max height

PLASTIC QUAD FLATPACK - NO LEAD

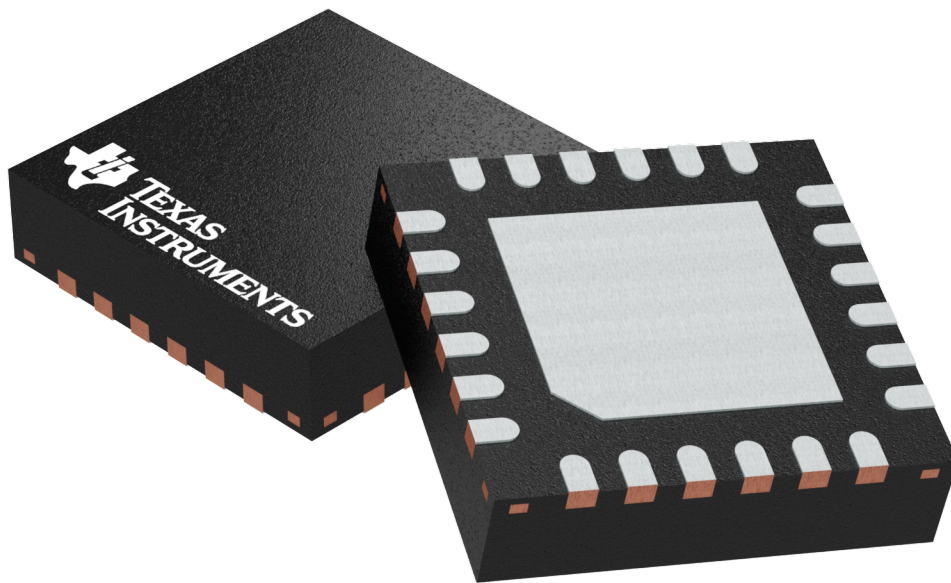

Images above are just a representation of the package family, actual package may vary.
Refer to the product data sheet for package details.

4204104/H

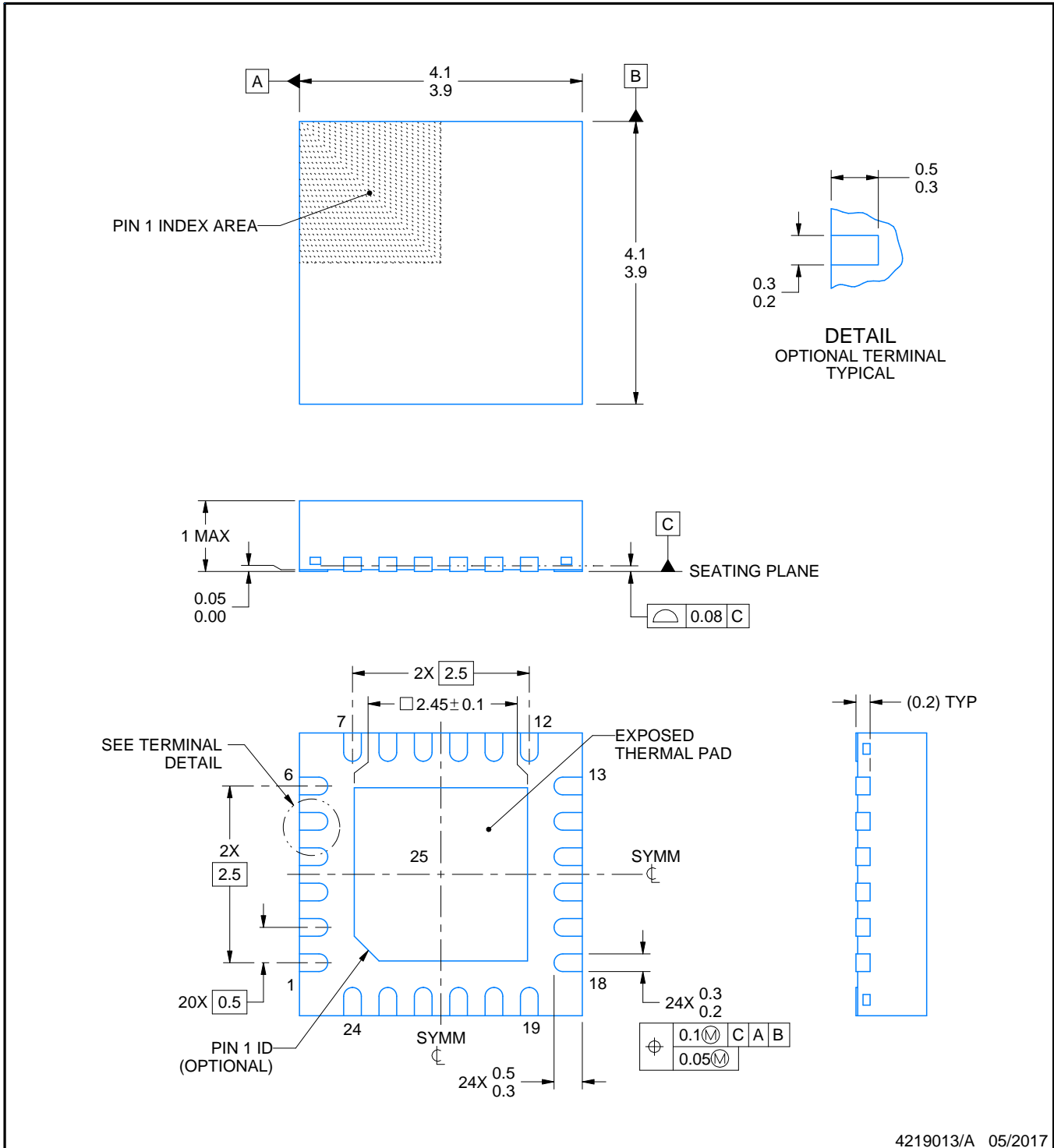
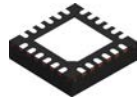

4219013/A 05/2017

NOTES:

1. All linear dimensions are in millimeters. Any dimensions in parenthesis are for reference only. Dimensioning and tolerancing per ASME Y14.5M.
2. This drawing is subject to change without notice.
3. The package thermal pad must be soldered to the printed circuit board for thermal and mechanical performance.

EXAMPLE BOARD LAYOUT

RGE0024B

VQFN - 1 mm max height

PLASTIC QUAD FLATPACK - NO LEAD

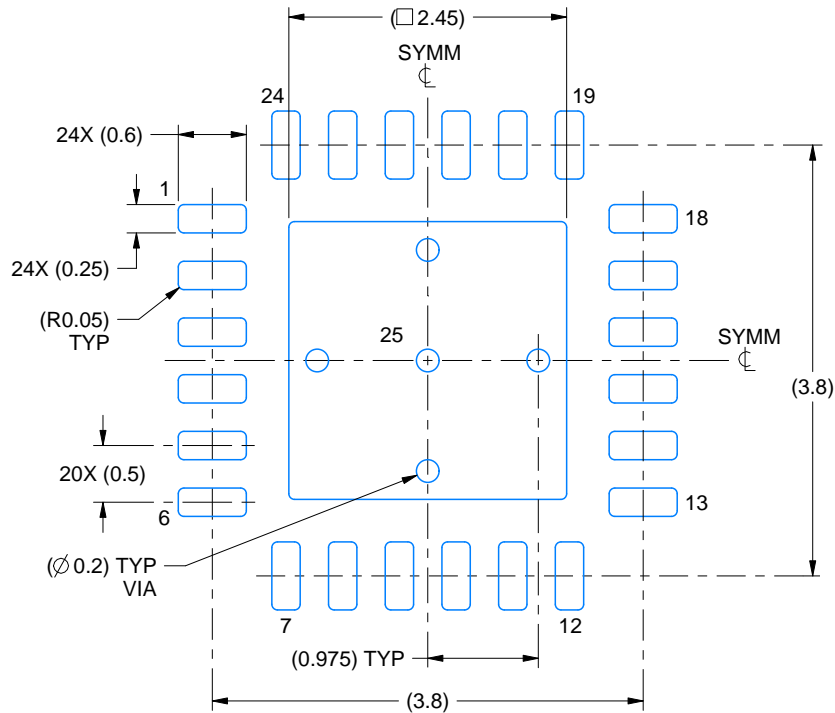

LAND PATTERN EXAMPLE
EXPOSED METAL SHOWN
SCALE:15X

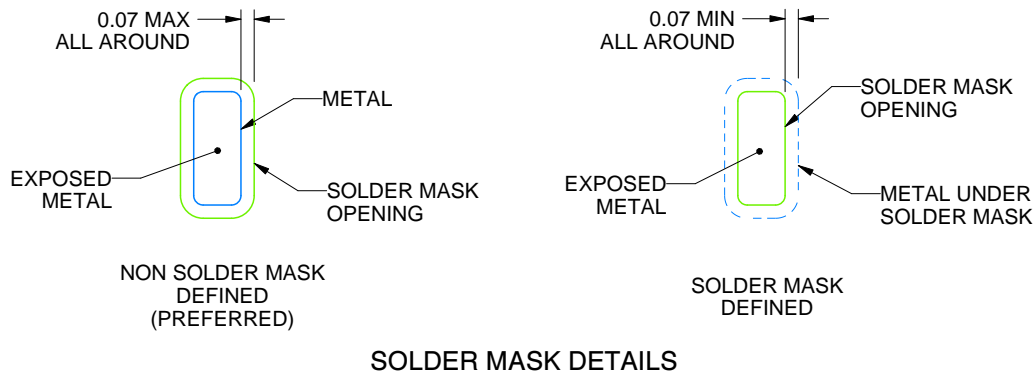

SOLDER MASK DETAILS

4219013/A 05/2017

NOTES: (continued)

4. This package is designed to be soldered to a thermal pad on the board. For more information, see Texas Instruments literature number SLUA271 (www.ti.com/lit/sluea271).
5. Vias are optional depending on application, refer to device data sheet. If any vias are implemented, refer to their locations shown on this view. It is recommended that vias under paste be filled, plugged or tented.

EXAMPLE STENCIL DESIGN

RGE0024B

VQFN - 1 mm max height

PLASTIC QUAD FLATPACK - NO LEAD

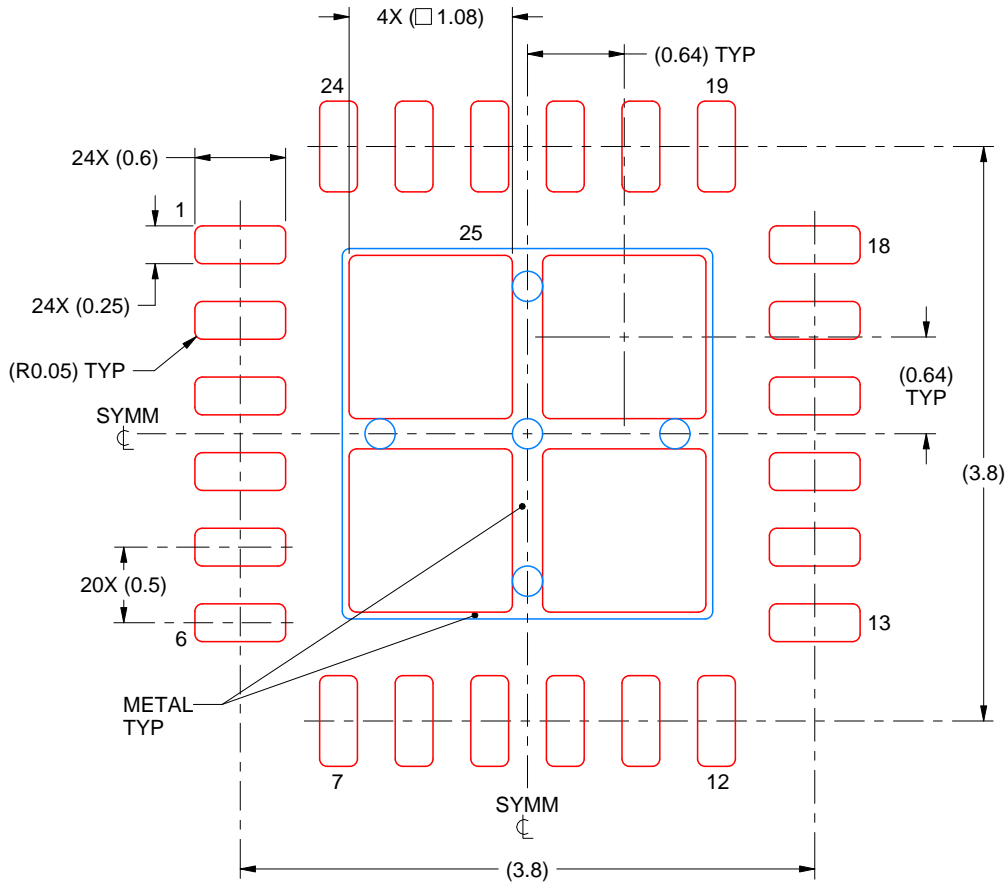

SOLDER PASTE EXAMPLE
 BASED ON 0.125 mm THICK STENCIL

EXPOSED PAD 25
 78% PRINTED SOLDER COVERAGE BY AREA UNDER PACKAGE
 SCALE:20X

4219013/A 05/2017

NOTES: (continued)

6. Laser cutting apertures with trapezoidal walls and rounded corners may offer better paste release. IPC-7525 may have alternate design recommendations.

IMPORTANT NOTICE AND DISCLAIMER

TI PROVIDES TECHNICAL AND RELIABILITY DATA (INCLUDING DATASHEETS), DESIGN RESOURCES (INCLUDING REFERENCE DESIGNS), APPLICATION OR OTHER DESIGN ADVICE, WEB TOOLS, SAFETY INFORMATION, AND OTHER RESOURCES "AS IS" AND WITH ALL FAULTS, AND DISCLAIMS ALL WARRANTIES, EXPRESS AND IMPLIED, INCLUDING WITHOUT LIMITATION ANY IMPLIED WARRANTIES OF MERCHANTABILITY, FITNESS FOR A PARTICULAR PURPOSE OR NON-INFRINGEMENT OF THIRD PARTY INTELLECTUAL PROPERTY RIGHTS.

These resources are intended for skilled developers designing with TI products. You are solely responsible for (1) selecting the appropriate TI products for your application, (2) designing, validating and testing your application, and (3) ensuring your application meets applicable standards, and any other safety, security, regulatory or other requirements.

These resources are subject to change without notice. TI grants you permission to use these resources only for development of an application that uses the TI products described in the resource. Other reproduction and display of these resources is prohibited. No license is granted to any other TI intellectual property right or to any third party intellectual property right. TI disclaims responsibility for, and you fully indemnify TI and its representatives against any claims, damages, costs, losses, and liabilities arising out of your use of these resources.

TI's products are provided subject to [TI's Terms of Sale](#), [TI's General Quality Guidelines](#), or other applicable terms available either on ti.com or provided in conjunction with such TI products. TI's provision of these resources does not expand or otherwise alter TI's applicable warranties or warranty disclaimers for TI products. Unless TI explicitly designates a product as custom or customer-specified, TI products are standard, catalog, general purpose devices.

TI objects to and rejects any additional or different terms you may propose.

Copyright © 2026, Texas Instruments Incorporated

Last updated 10/2025