

# CSD16301Q2 25V N-Channel NexFET™ Power MOSFET

## 1 Features

- Ultra-low  $Q_g$  and  $Q_{gd}$
- Low thermal resistance
- Lead-free terminal plating
- RoHS compliant
- Halogen free
- SON 2mm × 2mm plastic package

## 2 Applications

- DC-DC converters
- Battery and load management applications

## 3 Description

This 25V, 19mΩ, 2mm × 2mm SON NexFET™ power MOSFET has been designed to minimize losses in power conversion and load management applications. The 2mm × 2mm SON package offers excellent thermal performance for the size of the package.

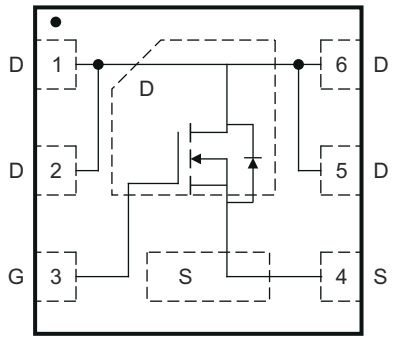

Top View

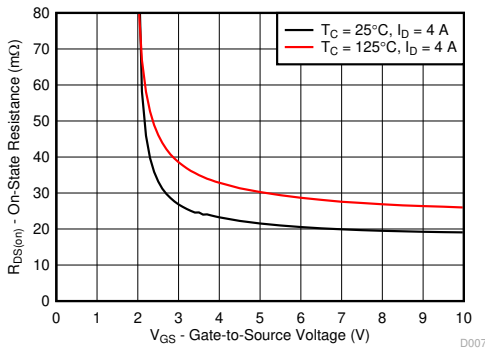

$R_{DS(on)}$  vs  $V_{GS}$

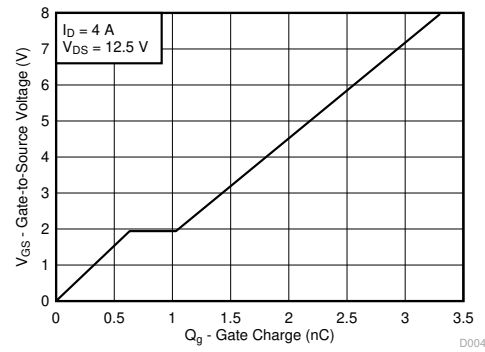

Gate Charge

## Product Summary

$T_A = 25^\circ\text{C}$		TYPICAL VALUE	UNIT
$V_{DS}$	Drain-to-Source Voltage	25	V
$Q_g$	Gate Charge Total (4.5V)	2	nC
$Q_{gd}$	Gate Charge Gate-to-Drain	0.4	nC
$R_{DS(on)}$	Drain-to-Source On Resistance	$V_{GS} = 3\text{V}$	27
		$V_{GS} = 4.5\text{V}$	23
		$V_{GS} = 8\text{V}$	19
$V_{GS(th)}$	Threshold Voltage	1.1	V

## Device Information

DEVICE	QTY	MEDIA	PACKAGE <sup>(1)</sup>	SHIP
CSD16301Q2	3000	7-Inch Reel	SON 2.00mm × 2.00mm Plastic Package	Reel

- (1) For all available packages, see the orderable addendum at the end of the data sheet.

## Absolute Maximum Ratings

$T_A = 25^\circ\text{C}$		VALUE	UNIT
$V_{DS}$	Drain-to-Source Voltage	25	V
$V_{GS}$	Gate-to-Source Voltage	+10 / -8	V
$I_D$	Continuous Drain Current (Package Limited)	5	A
	Continuous Drain Current (Silicon Limited), $T_C = 25^\circ\text{C}$	20	
	Continuous Drain Current <sup>(1)</sup>	8.2	
$I_{DM}$	Pulsed Drain Current <sup>(2)</sup>	85	A
$P_D$	Power Dissipation <sup>(1)</sup>	2.5	W
	Power Dissipation, $T_C = 25^\circ\text{C}$	15	
$T_J, T_{STG}$	Operating Junction, Storage Temperature	-55 to 150	$^\circ\text{C}$
$E_{AS}$	Avalanche Energy, Single Pulse $I_D = 14\text{A}, L = 0.1\text{mH}, R_G = 25\Omega$	10	mJ

- (1) Typical  $R_{\theta JA} = 50^\circ\text{C/W}$  on a 1-in<sup>2</sup>, 2oz Cu pad on a 0.06in thick FR4 PCB.  
 (2) Max  $R_{\theta JC} = 8.4^\circ\text{C/W}$ , pulse duration  $\leq 100\mu\text{s}$ , duty cycle  $\leq 1\%$ .



## Table of Contents

<b>1 Features</b> .....	1	5.1 Receiving Notification of Documentation Updates.....	7
<b>2 Applications</b> .....	1	5.2 Support Resources.....	7
<b>3 Description</b> .....	1	5.3 Trademarks.....	7
<b>4 Specifications</b> .....	3	5.4 Electrostatic Discharge Caution.....	7
4.1 Electrical Characteristics.....	3	5.5 Glossary.....	7
4.2 Thermal Information.....	3	<b>6 Revision History</b> .....	8
4.3 Typical MOSFET Characteristics.....	4	<b>7 Mechanical, Packaging, and Orderable Information</b> ....	9
<b>5 Device and Documentation Support</b> .....	7		

---

## 4 Specifications

### 4.1 Electrical Characteristics

$T_A = 25^\circ\text{C}$  (unless otherwise specified)

PARAMETER		TEST CONDITIONS	MIN	TYP	MAX	UNIT
<b>STATIC CHARACTERISTICS</b>						
$BV_{DSS}$	Drain-to-source voltage	$V_{GS} = 0V, I_D = 250\mu A$	25			V
$I_{DSS}$	Drain-to-source leakage current	$V_{GS} = 0V, V_{DS} = 20V$			1	$\mu A$
$I_{GSS}$	Gate-to-source leakage current	$V_{DS} = 0V, V_{GS} = +10/-8V$			100	nA
$V_{GS(th)}$	Gate-to-source threshold voltage	$V_{DS} = V_{GS}, I_{DS} = 250\mu A$	0.9	1.1	1.55	V
$R_{DS(on)}$	Drain-to-source on resistance	$V_{GS} = 3V, I_{DS} = 4A$		27	34	m $\Omega$
		$V_{GS} = 4.5V, I_{DS} = 4A$		23	29	
		$V_{GS} = 8V, I_{DS} = 4A$		19	24	
$g_{fs}$	Transconductance	$V_{DS} = 15V, I_{DS} = 4A$		16.5		S
<b>DYNAMIC CHARACTERISTICS</b>						
$C_{ISS}$	Input capacitance	$V_{GS} = 0V, V_{DS} = 12.5V, f = 1MHz$		260	340	pF
$C_{OSS}$	Output capacitance			165	215	pF
$C_{RSS}$	Reverse transfer capacitance			13	17	pF
$R_g$	Series gate resistance			1.3	2.6	$\Omega$
$Q_g$	Gate charge total (4.5 V)	$V_{DS} = 10V, I_{DS} = 4A$		2.0	2.8	nC
$Q_{gd}$	Gate charge gate-to-drain			0.4		nC
$Q_{gs}$	Gate charge gate-to-source			0.6		nC
$Q_{g(th)}$	Gate charge at $V_{th}$			0.3		nC
$Q_{OSS}$	Output charge	$V_{DS} = 12.5V, V_{GS} = 0V$		3.0		nC
$t_{d(on)}$	Turnon delay time	$V_{DS} = 12.5V, V_{GS} = 4.5V, I_{DS} = 4A$ $R_G = 2\Omega$		2.7		ns
$t_r$	Rise time			4.4		ns
$t_{d(off)}$	Turnoff delay time			4.1		ns
$t_f$	Fall time			1.7		ns
<b>DIODE CHARACTERISTICS</b>						
$V_{SD}$	Diode forward voltage	$I_{DS} = 4A, V_{GS} = 0V$		0.8	1	V
$Q_{rr}$	Reverse recovery charge	$V_{DD} = 12.5V, I_F = 4A, di/dt = 200A/\mu s$		5.1		nC
$t_{rr}$	Reverse recovery time			11		ns

### 4.2 Thermal Information

$T_A = 25^\circ\text{C}$  (unless otherwise stated)

THERMAL METRIC		MIN	TYP	MAX	UNIT
$R_{\theta JC}$	Junction-to-case thermal resistance <sup>(1)</sup>			8.4	$^\circ\text{C/W}$
$R_{\theta JA}$	Junction-to-ambient thermal resistance <sup>(1) (2)</sup>			65	$^\circ\text{C/W}$

(1)  $R_{\theta JC}$  is determined with the device mounted on a 1in<sup>2</sup> (6.45cm<sup>2</sup>), 2oz (0.071mm) thick Cu pad on a 1.5in × 1.5in (3.81cm × 3.81cm), 0.06in (1.52mm) thick FR4 PCB.  $R_{\theta JC}$  is specified by design, whereas  $R_{\theta JA}$  is determined by the user's board design.

(2) Device mounted on FR4 material with 1in<sup>2</sup> (6.45cm<sup>2</sup>), 2oz (0.071mm) thick Cu.

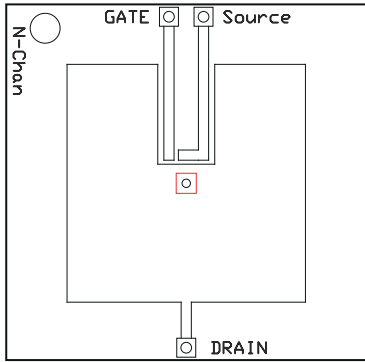

M0164-01

Max  $R_{\theta JA}$  = 65°C/W when mounted on 1in<sup>2</sup> (6.45cm<sup>2</sup>) of 2oz (0.071mm) thick Cu.

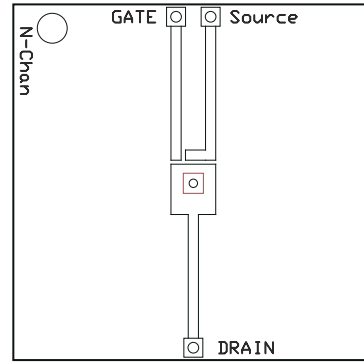

M0164-02

Max  $R_{\theta JA}$  = 250°C/W when mounted on minimum pad area of 2oz (0.071mm) thick Cu.

### 4.3 Typical MOSFET Characteristics

$T_A$  = 25°C (unless otherwise specified)

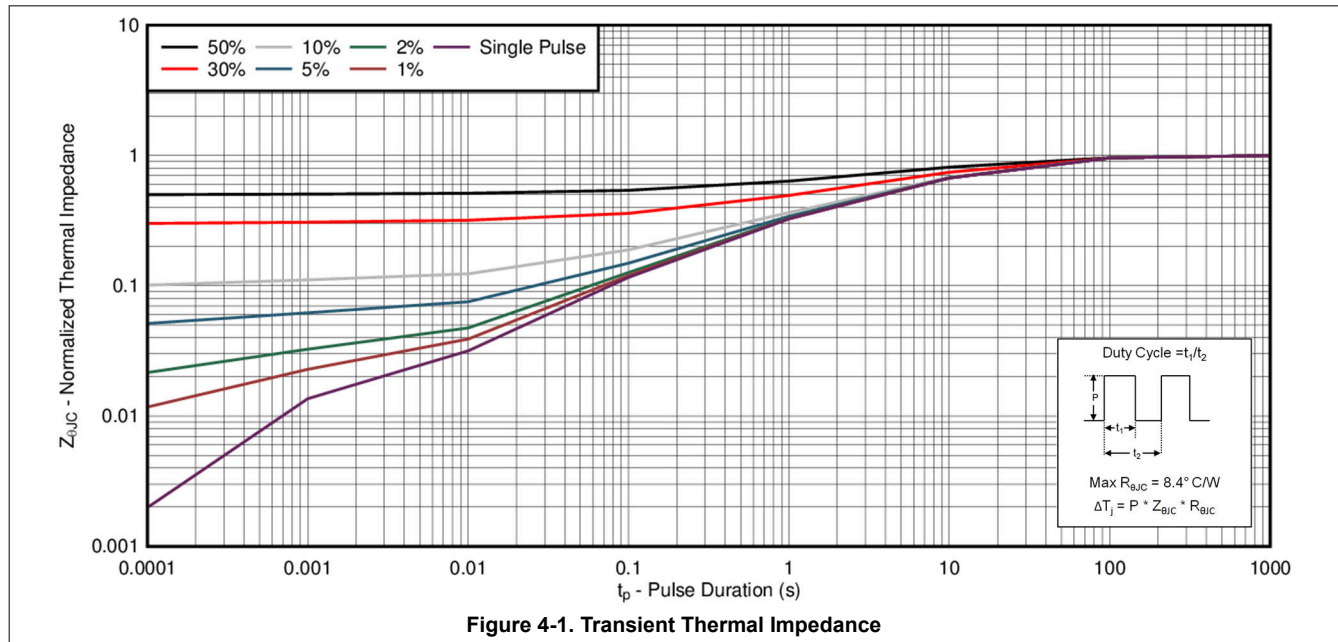

### 4.3 Typical MOSFET Characteristics (continued)

$T_A = 25^\circ\text{C}$  (unless otherwise specified)

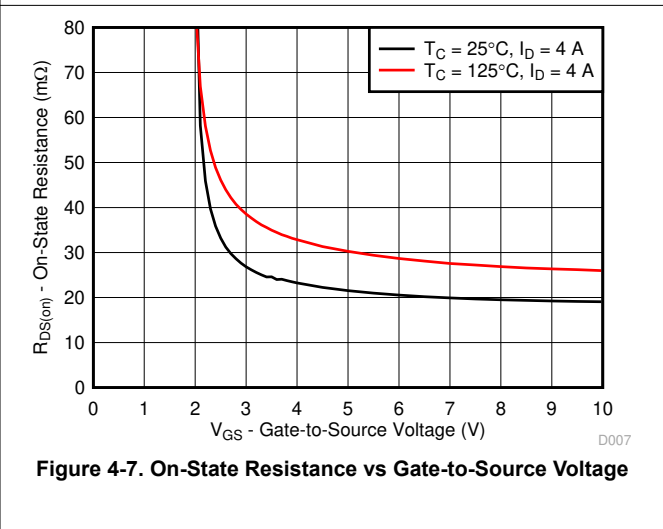
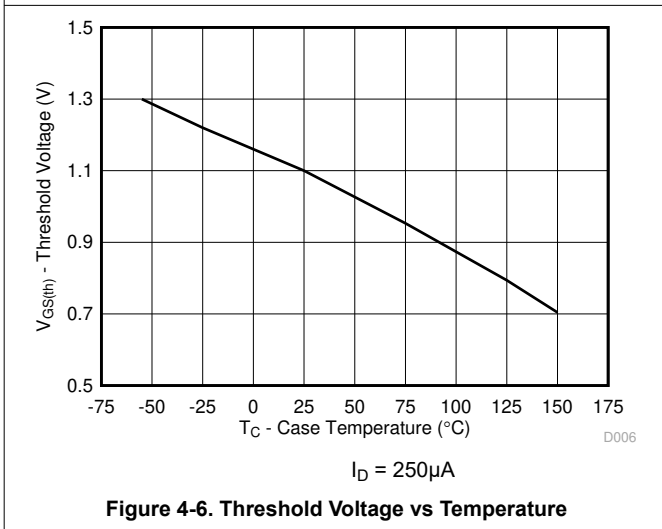
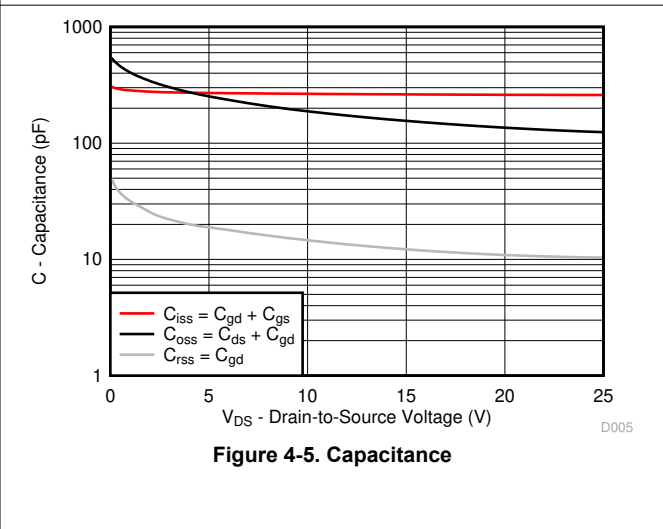
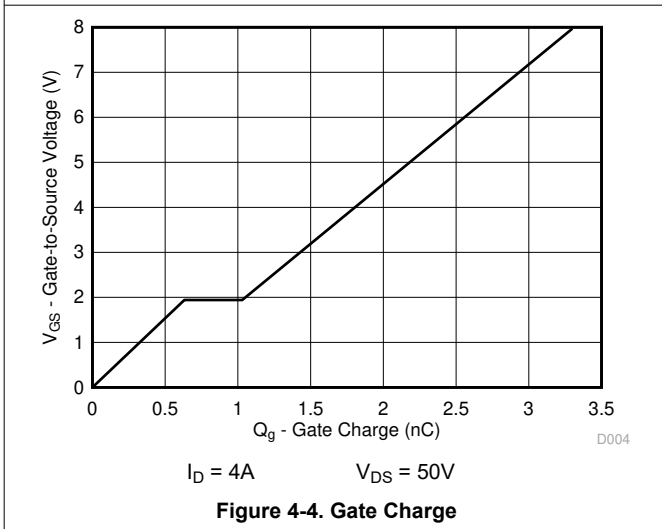
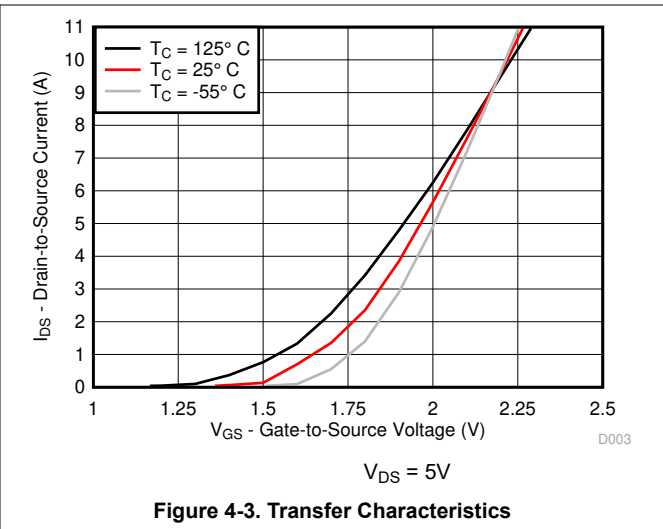
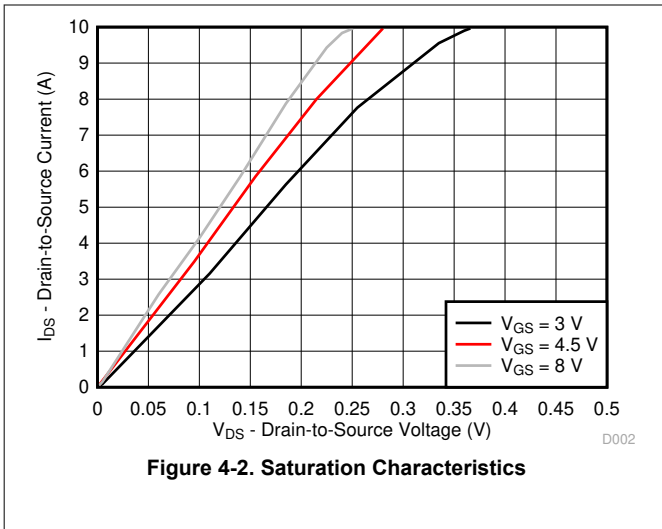

### 4.3 Typical MOSFET Characteristics (continued)

T<sub>A</sub> = 25°C (unless otherwise specified)

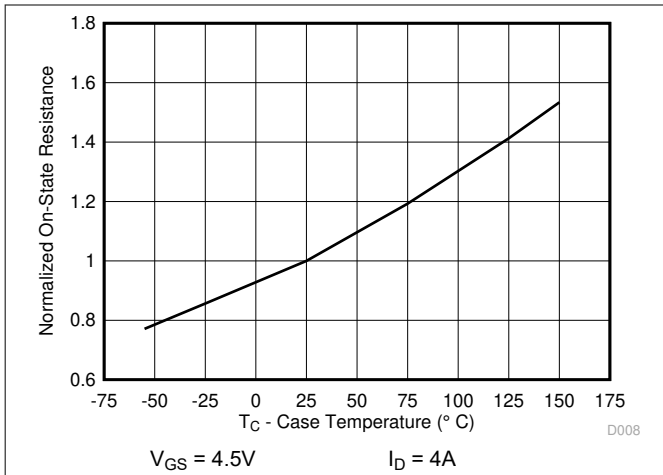

Figure 4-8. Normalized On-State Resistance vs Temperature

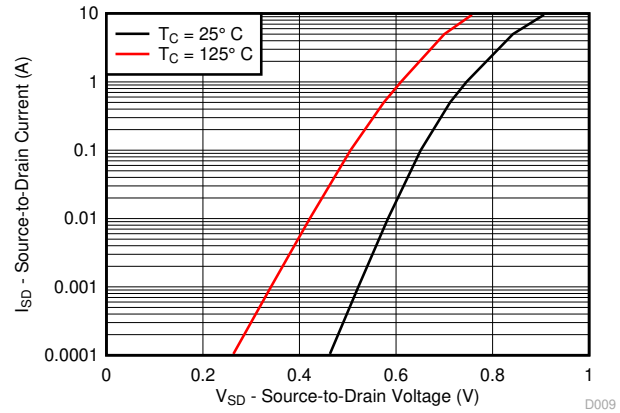

Figure 4-9. Typical Diode Forward Voltage

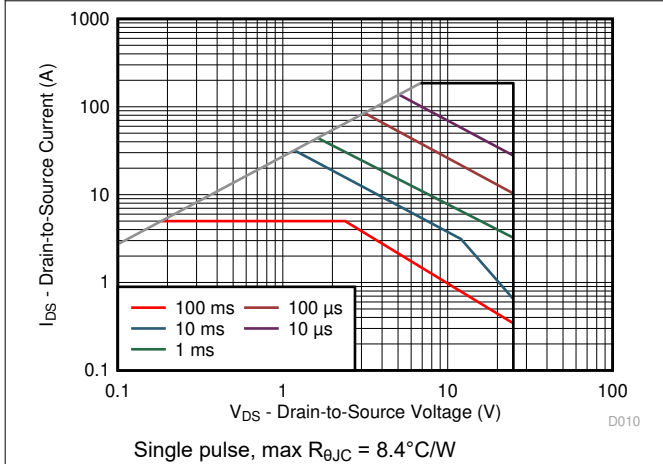

Figure 4-10. Maximum Safe Operating Area

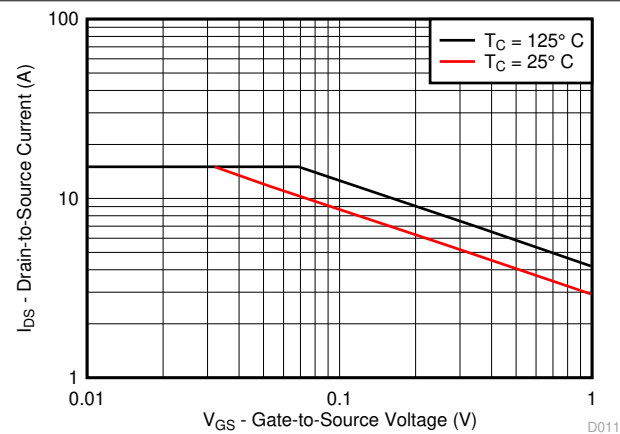

Figure 4-11. Single Pulse Unclamped Inductive Switching

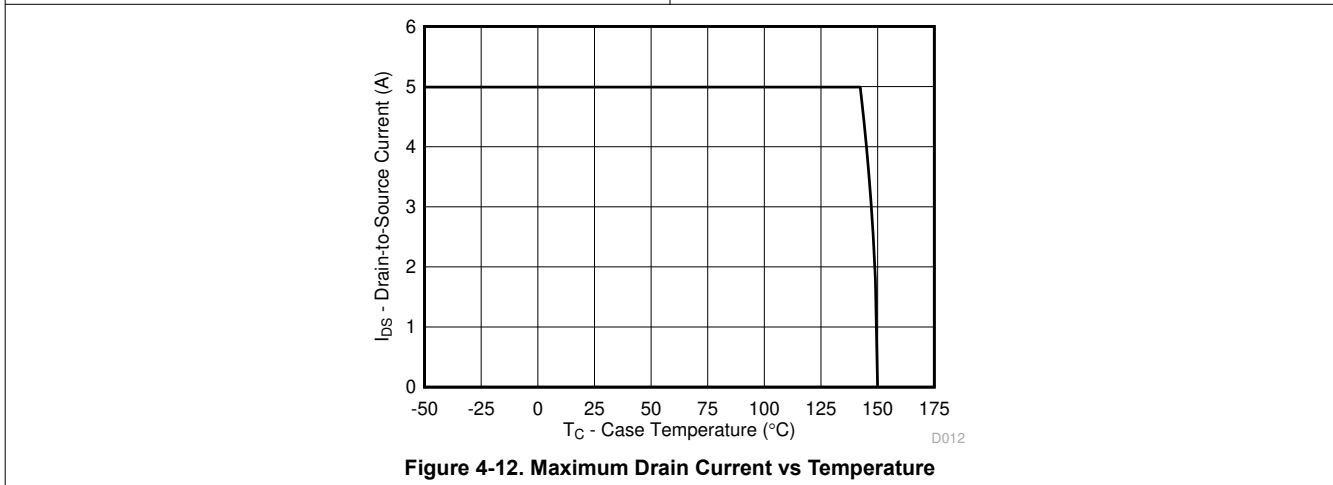

Figure 4-12. Maximum Drain Current vs Temperature

## 5 Device and Documentation Support

### 5.1 Receiving Notification of Documentation Updates

To receive notification of documentation updates, navigate to the device product folder on [ti.com](http://ti.com). Click on *Notifications* to register and receive a weekly digest of any product information that has changed. For change details, review the revision history included in any revised document.

### 5.2 Support Resources

[TI E2E™ support forums](#) are an engineer's go-to source for fast, verified answers and design help — straight from the experts. Search existing answers or ask your own question to get the quick design help you need.

Linked content is provided "AS IS" by the respective contributors. They do not constitute TI specifications and do not necessarily reflect TI's views; see TI's [Terms of Use](#).

### 5.3 Trademarks

NexFET™ and TI E2E™ are trademarks of Texas Instruments.  
All trademarks are the property of their respective owners.

### 5.4 Electrostatic Discharge Caution



This integrated circuit can be damaged by ESD. Texas Instruments recommends that all integrated circuits be handled with appropriate precautions. Failure to observe proper handling and installation procedures can cause damage.

ESD damage can range from subtle performance degradation to complete device failure. Precision integrated circuits may be more susceptible to damage because very small parametric changes could cause the device not to meet its published specifications.

### 5.5 Glossary

[TI Glossary](#) This glossary lists and explains terms, acronyms, and definitions.

## 6 Revision History

NOTE: Page numbers for previous revisions may differ from page numbers in the current version.

<b>Changes from Revision D (November 2016) to Revision E (March 2024)</b>	<b>Page</b>
• Updated the numbering format for tables, figures, and cross-references throughout the document.....	1
• Removed CSD16301Q2T small reel option.....	1
<hr/>	
<b>Changes from Revision C (July 2011) to Revision D (November 2016)</b>	<b>Page</b>
• Added <i>Device and Documentation Support</i> section.....	1
• Changed <i>Description</i> text.....	1
• Changed $Q_g$ voltage condition from $-4.5V$ : to $4.5V$ in <i>Product Summary</i> table.....	1
• Added silicon limited continuous drain current to <i>Absolute Maximum Ratings</i> table.....	1
• Added max power dissipation at $T_C = 25^\circ C$ to <i>Absolute Maximum Ratings</i> table.....	1
• Changed Note 1 and Note 2 in <i>Absolute Maximum Ratings</i> table.....	1
• Changed $R_{\theta JA}$ max from $69^\circ C/W$ : to $65^\circ C/W$ .....	3
• Changed <a href="#">Figure 4-1</a> to reflect a transient $R_{\theta JC}$ curve.....	4
• Changed the safe operating area in <a href="#">Figure 4-10</a> to reflect measured data.....	4
• Changed <i>MECHANICAL DATA</i> section to <i>Mechanical, Packaging, and Orderable Information</i> section.....	9
<hr/>	
<b>Changes from Revision B (April 2010) to Revision C (July 2011)</b>	<b>Page</b>
• Added a 7-Inch Reel option to the Ordering Information Table.....	1
<hr/>	
<b>Changes from Revision A (December 2009) to Revision B (April 2010)</b>	<b>Page</b>
• Added title to <a href="#">Figure 4-11</a> - Single Pulse Unclamped Inductive Switching.....	4
<hr/>	
<b>Changes from Revision * (October 2009) to Revision A (December 2009)</b>	<b>Page</b>
• Changed the Electrical Characteristics table - $V_{GS(th)}$ MAX value From: 1.4V To 1.55V.....	3
<hr/>	



## 7 Mechanical, Packaging, and Orderable Information

The following pages include mechanical, packaging, and orderable information. This information is the most current data available for the designated devices. This data is subject to change without notice and revision of this document. For browser-based versions of this data sheet, refer to the left-hand navigation.

## PACKAGING INFORMATION

Orderable part number	Status (1)	Material type (2)	Package   Pins	Package qty   Carrier	RoHS (3)	Lead finish/ Ball material (4)	MSL rating/ Peak reflow (5)	Op temp (°C)	Part marking (6)
<a href="#">CSD16301Q2</a>	Active	Production	WSON (DQK)   6	3000   LARGE T&R	Yes	NIPDAU	Level-1-260C-UNLIM	-55 to 150	1631
CSD16301Q2.B	Active	Production	WSON (DQK)   6	3000   LARGE T&R	Yes	NIPDAU	Level-1-260C-UNLIM	-55 to 150	1631
CSD16301Q2G4.B	Active	Production	WSON (DQK)   6	3000   LARGE T&R	Yes	NIPDAU	Level-1-260C-UNLIM	-55 to 150	1631

(1) **Status:** For more details on status, see our [product life cycle](#).

(2) **Material type:** When designated, preproduction parts are prototypes/experimental devices, and are not yet approved or released for full production. Testing and final process, including without limitation quality assurance, reliability performance testing, and/or process qualification, may not yet be complete, and this item is subject to further changes or possible discontinuation. If available for ordering, purchases will be subject to an additional waiver at checkout, and are intended for early internal evaluation purposes only. These items are sold without warranties of any kind.

(3) **RoHS values:** Yes, No, RoHS Exempt. See the [TI RoHS Statement](#) for additional information and value definition.

(4) **Lead finish/Ball material:** Parts may have multiple material finish options. Finish options are separated by a vertical ruled line. Lead finish/Ball material values may wrap to two lines if the finish value exceeds the maximum column width.

(5) **MSL rating/Peak reflow:** The moisture sensitivity level ratings and peak solder (reflow) temperatures. In the event that a part has multiple moisture sensitivity ratings, only the lowest level per JEDEC standards is shown. Refer to the shipping label for the actual reflow temperature that will be used to mount the part to the printed circuit board.

(6) **Part marking:** There may be an additional marking, which relates to the logo, the lot trace code information, or the environmental category of the part.

Multiple part markings will be inside parentheses. Only one part marking contained in parentheses and separated by a "-" will appear on a part. If a line is indented then it is a continuation of the previous line and the two combined represent the entire part marking for that device.

**Important Information and Disclaimer:** The information provided on this page represents TI's knowledge and belief as of the date that it is provided. TI bases its knowledge and belief on information provided by third parties, and makes no representation or warranty as to the accuracy of such information. Efforts are underway to better integrate information from third parties. TI has taken and continues to take reasonable steps to provide representative and accurate information but may not have conducted destructive testing or chemical analysis on incoming materials and chemicals. TI and TI suppliers consider certain information to be proprietary, and thus CAS numbers and other limited information may not be available for release.

In no event shall TI's liability arising out of such information exceed the total purchase price of the TI part(s) at issue in this document sold by TI to Customer on an annual basis.

**TAPE AND REEL INFORMATION**

**QUADRANT ASSIGNMENTS FOR PIN 1 ORIENTATION IN TAPE**

\*All dimensions are nominal

Device	Package Type	Package Drawing	Pins	SPQ	Reel Diameter (mm)	Reel Width W1 (mm)	A0 (mm)	B0 (mm)	K0 (mm)	P1 (mm)	W (mm)	Pin1 Quadrant
CSD16301Q2	WSO	DQK	6	3000	180.0	9.5	2.3	2.3	1.0	4.0	8.0	Q1

**TAPE AND REEL BOX DIMENSIONS**

\*All dimensions are nominal

Device	Package Type	Package Drawing	Pins	SPQ	Length (mm)	Width (mm)	Height (mm)
CSD16301Q2	WSON	DQK	6	3000	189.0	185.0	36.0

## GENERIC PACKAGE VIEW

**DQK 6**

**WSON - 0.8 mm max height**

2 x 2, 0.65 mm pitch

PLASTIC SMALL OUTLINE - NO LEAD

This image is a representation of the package family, actual package may vary.  
Refer to the product data sheet for package details.

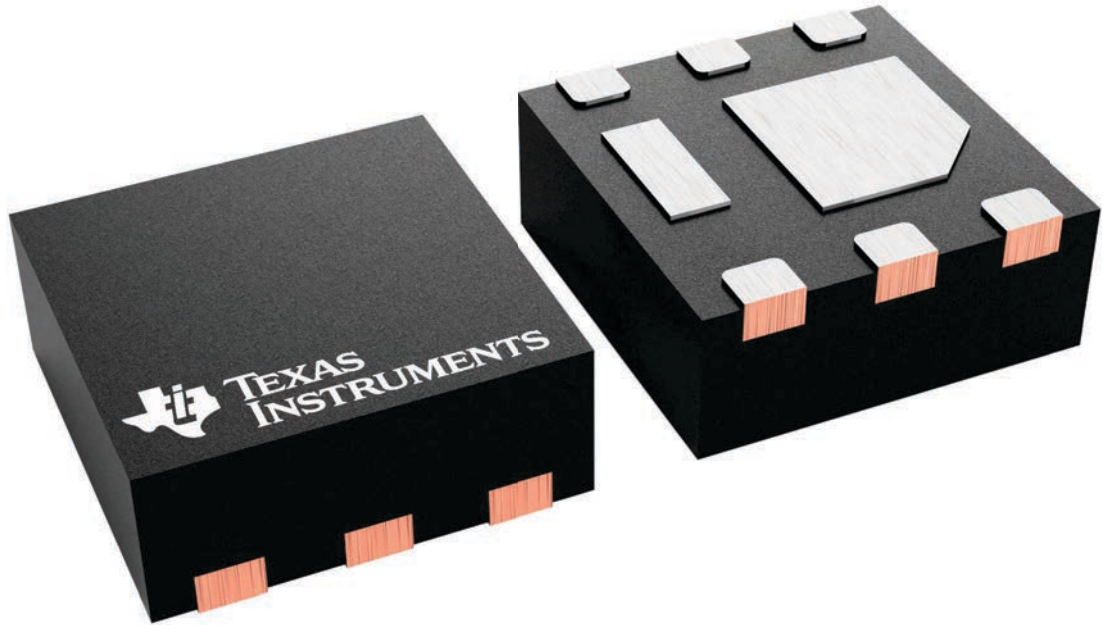

4229807/A

DQK (S-PWSON-N6)

PLASTIC SMALL OUTLINE NO-LEAD

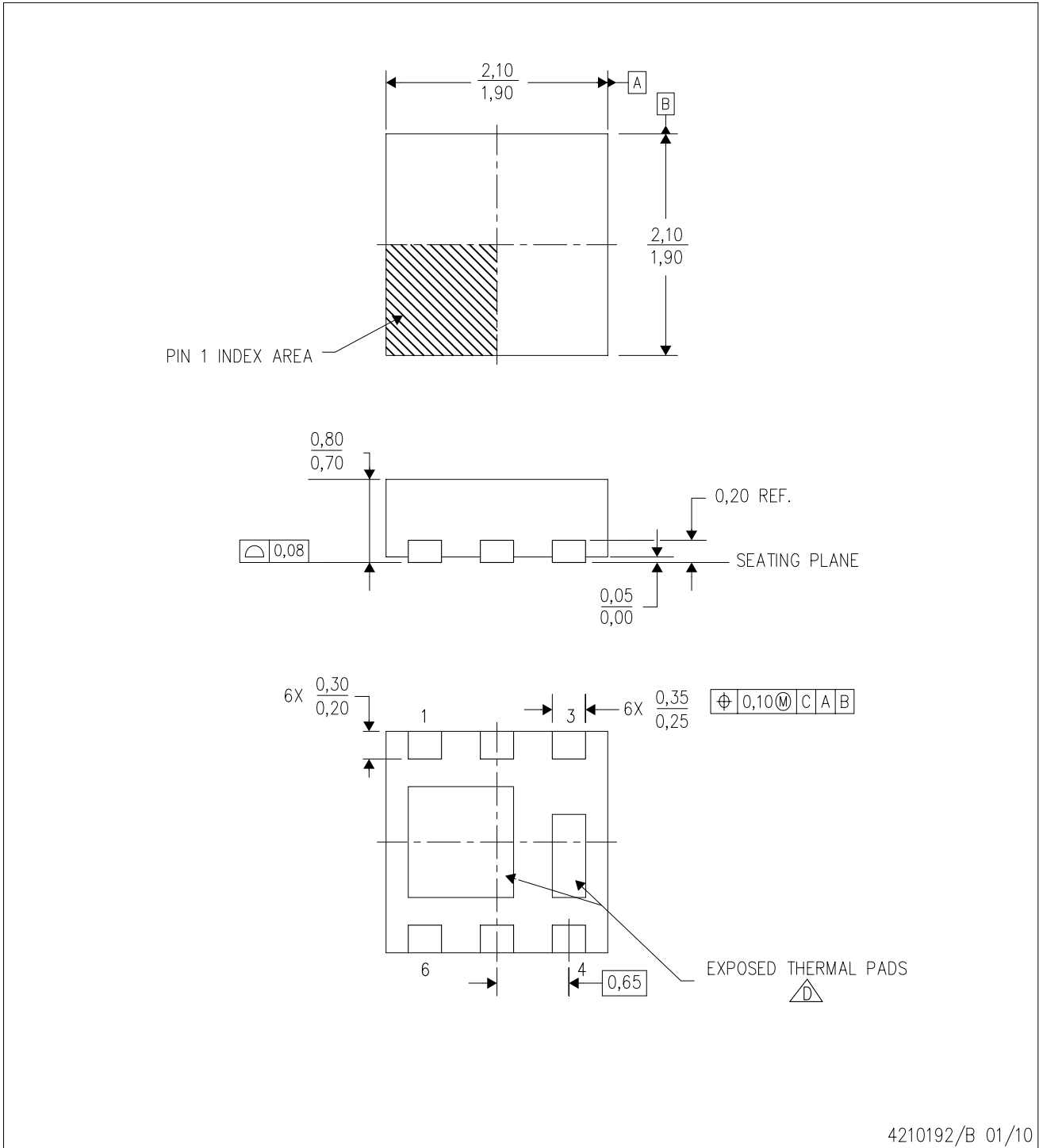

- NOTES:
- A. All linear dimensions are in millimeters. Dimensioning and tolerancing per ASME Y14.5M-1994.
  - B. This drawing is subject to change without notice.
  - C. Small Outline No-Lead (SON) package configuration.
  -  D. The package thermal pads must be soldered to the board for thermal and mechanical performance.

**THERMAL INFORMATION**

This package incorporates an exposed thermal pad that is designed to be attached directly to an external heatsink. The thermal pad must be soldered directly to the printed circuit board (PCB). After soldering, the PCB can be used as a heatsink. In addition, through the use of thermal vias, the thermal pad can be attached directly to the appropriate copper plane shown in the electrical schematic for the device, or alternatively, can be attached to a special heatsink structure designed into the PCB. This design optimizes the heat transfer from the integrated circuit (IC).

For information on the Quad Flatpack No-Lead (QFN) package and its advantages, refer to Application Report, Quad Flatpack No-Lead Logic Packages, Texas Instruments Literature No. SCBA017. This document is available at [www.ti.com](http://www.ti.com).

The exposed thermal pad dimensions for this package are shown in the following illustration.

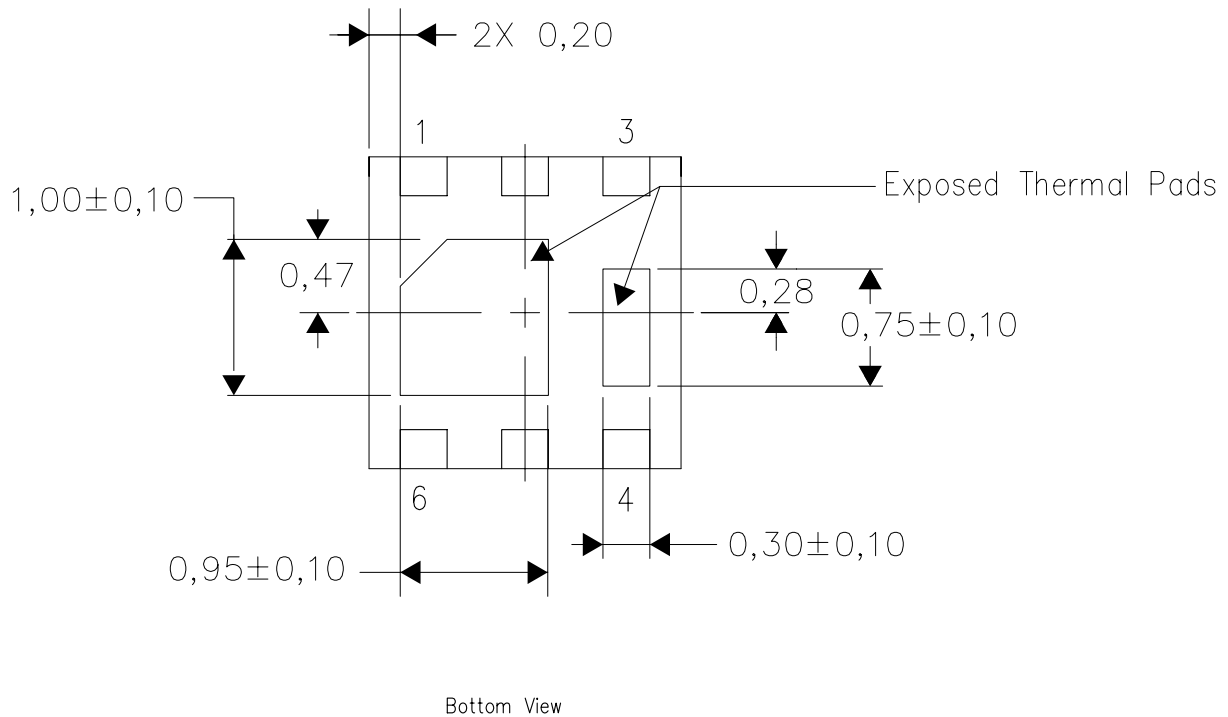

NOTE: All linear dimensions are in millimeters

Exposed Thermal Pad Dimensions

## IMPORTANT NOTICE AND DISCLAIMER

TI PROVIDES TECHNICAL AND RELIABILITY DATA (INCLUDING DATASHEETS), DESIGN RESOURCES (INCLUDING REFERENCE DESIGNS), APPLICATION OR OTHER DESIGN ADVICE, WEB TOOLS, SAFETY INFORMATION, AND OTHER RESOURCES "AS IS" AND WITH ALL FAULTS, AND DISCLAIMS ALL WARRANTIES, EXPRESS AND IMPLIED, INCLUDING WITHOUT LIMITATION ANY IMPLIED WARRANTIES OF MERCHANTABILITY, FITNESS FOR A PARTICULAR PURPOSE OR NON-INFRINGEMENT OF THIRD PARTY INTELLECTUAL PROPERTY RIGHTS.

These resources are intended for skilled developers designing with TI products. You are solely responsible for (1) selecting the appropriate TI products for your application, (2) designing, validating and testing your application, and (3) ensuring your application meets applicable standards, and any other safety, security, regulatory or other requirements.

These resources are subject to change without notice. TI grants you permission to use these resources only for development of an application that uses the TI products described in the resource. Other reproduction and display of these resources is prohibited. No license is granted to any other TI intellectual property right or to any third party intellectual property right. TI disclaims responsibility for, and you fully indemnify TI and its representatives against any claims, damages, costs, losses, and liabilities arising out of your use of these resources.

TI's products are provided subject to [TI's Terms of Sale](#), [TI's General Quality Guidelines](#), or other applicable terms available either on [ti.com](#) or provided in conjunction with such TI products. TI's provision of these resources does not expand or otherwise alter TI's applicable warranties or warranty disclaimers for TI products. Unless TI explicitly designates a product as custom or customer-specified, TI products are standard, catalog, general purpose devices.

TI objects to and rejects any additional or different terms you may propose.

Copyright © 2025, Texas Instruments Incorporated

Last updated 10/2025