

LM3644 Dual 1.5-A Current Source Camera Flash LED Driver

1 Features

- Dual Independent 1.5-A LED Current Source Programmability
- Accurate and Programmable LED Current Range from 1.4 mA to 1.5 A
- Torch Currents up to 360 mA (LM3644TT)
- Flash Timeout Values up to 1.6 seconds (LM3644TT)
- Optimized Flash LED Current During Low Battery Conditions (IVFM)
- > 85% Efficiency in Torch Mode (at 100 mA) and Flash Mode (at 1 A to 1.5 A)
- Grounded Cathode LED Operation for Improved Thermal Management
- Small Solution Size: < 16 mm²
- Hardware Strobe Enable (STROBE)
- Synchronization Input for RF Power Amplifier Pulse Events (TX)
- Hardware Torch Enable (TORCH/TEMP)
- Remote NTC Monitoring (TORCH/TEMP)
- 400-kHz I²C-Compatible Interface
 - LM3644 (I²C Address = 0x63)

2 Applications

- Camera Phone White LED Flash
- Digital Still Cameras
- Fire-Alarm Notification
- Emergency Strobe Lighting
- Intruder Alert Notification
- Barcode Scanners
- Handheld Data Terminals

3 Description

The LM3644 is a dual LED flash driver that provides a high level of adjustability within a small solution size. The LM3644 utilizes a 2-MHz or 4-MHz fixed-frequency synchronous boost converter to provide power to the dual 1.5-A constant current LED sources. The dual 128 level current sources provide the flexibility to adjust the current ratios between LED1 and LED2. An adaptive regulation method ensures the current sources remain in regulation and maximizes efficiency.

Features of the LM3644 are controlled via an I²C-compatible interface. These features include: hardware flash and hardware torch pins (STROBE and TORCH/TEMP), a TX interrupt, and an NTC thermistor monitor. The device offers independently programmable currents in each output leg to drive the LEDs in a Flash or Movie Mode (Torch) condition.

The 2-MHz or 4-MHz switching frequency options, overvoltage protection (OVP), and adjustable current limit allow for the use of tiny, low-profile inductors and 10- μ F ceramic capacitors. The device operates over a –40°C to +85°C ambient temperature range.

Device Information⁽¹⁾

PART NUMBER	PACKAGE	BODY SIZE (MAX)
LM3644	DSBGA (12)	1.69 mm x 1.31 mm

(1) For all available packages, see the orderable addendum at the end of the data sheet.

Simplified Schematic

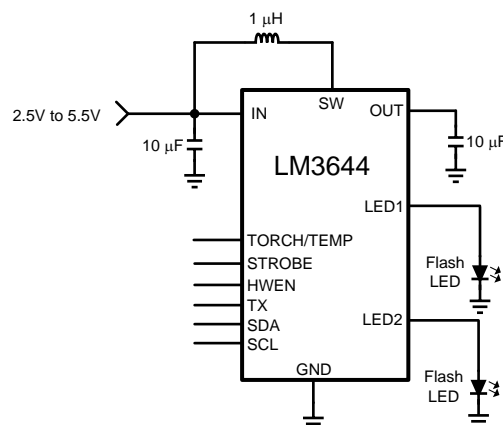

Table of Contents

1	Features	1	8.3	Feature Description	13
2	Applications	1	8.4	Device Functioning Modes.....	15
3	Description	1	8.5	Programming.....	19
4	Revision History	2	8.6	Register Descriptions.....	21
5	Device Comparison Table	2	9	Applications and Implementation	25
6	Pin Configuration and Functions	3	9.1	Application Information.....	25
7	Specifications	4	9.2	Typical Application	25
7.1	Absolute Maximum Ratings	4	10	Power Supply Recommendations	31
7.2	ESD Ratings	4	11	Layout	31
7.3	Recommended Operating Conditions.....	4	11.1	Layout Guidelines	31
7.4	Thermal Information	4	11.2	Layout Example	32
7.5	Electrical Characteristics.....	5	12	Device and Documentation Support	33
7.6	Timing Requirements	6	12.1	Device Support.....	33
7.7	Switching Characteristics	6	12.2	Related Documentation.....	33
7.8	Typical Characteristics.....	6	12.3	Trademarks	33
8	Detailed Description	12	12.4	Electrostatic Discharge Caution.....	33
8.1	Overview	12	12.5	Glossary	33
8.2	Functional Block Diagram	13	13	Mechanical, Packaging, and Orderable Information	34

4 Revision History

Changes from Revision D (September 2015) to Revision E	Page
• Added several additional <i>Applications</i> ; updated <i>Device and Documentation Support</i> with 2 new subsections	1

Changes from Revision C (April 2015) to Revision D	Page
• Changed 0x00 to 0x02 - typo	21
• Changed 0x40 to 0x04 - typo	21

Changes from Revision B (November 2014) to Revision C	Page
• Added information about LM3644TT option	1
• Changed <i>Handling Ratings</i> to <i>ESD Ratings</i> ; moved storage temp to <i>Ab Max</i>	4
• Added full <i>Thermal Information</i> information	4

Changes from Revision A (October 2013) to Revision B	Page
• Changed '011' to '000' - typo	24

Changes from Original (August 2014) to Revision A	Page
• Changed title from "1.5A Synchronous Boost White LED Driver with High Side Current Sources " to "Dual 1.5-A Current Source Camera Flash LED Driver"	1
• Added Note to beginning of <i>Applications and Implementations</i> section	25

5 Device Comparison Table

ORDERING PART NUMBER	MAXIMUM TORCH CURRENT PER CHANNEL	FLASH TIME-OUT RANGE
LM3644YFFR	179 mA	10 ms to 400 ms
LM3644TTYFFR	360 mA	40 ms to 1600 ms

6 Pin Configuration and Functions

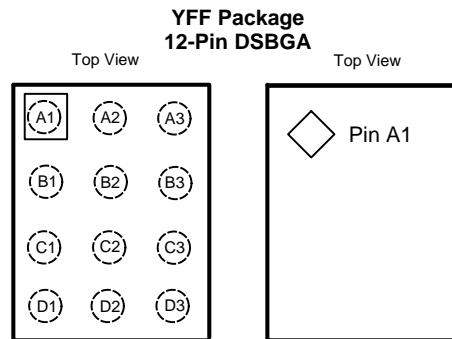

Pin Functions

PIN		TYPE	DESCRIPTION
NUMBER	NAME		
A1	GND	Ground	Ground
A2	IN	Power	Input voltage connection. Connect IN to the input supply and bypass to GND with a 10- μ F or larger ceramic capacitor.
A3	SDA	I/O	Serial data input/output in the I ² C Mode on LM3644.
B1	SW	Power	Drain Connection for Internal NMOS and Synchronous PMOS Switches.
B2	STROBE	I/O	Active high hardware flash enable. Drive STROBE high to turn on Flash pulse. Internal pulldown resistor of 300 k Ω between STROBE and GND.
B3	SCL	I/O	Serial clock input for LM3644.
C1	OUT	Power	Step-up DC-DC converter output. Connect a 10- μ F ceramic capacitor between this pin and GND.
C2	HWEN	I/O	Active high enable pin. High = Standby, Low = Shutdown/Reset. Internal pulldown resistor of 300 k Ω between HWEN and GND.
C3	TORCH/T EMP	I/O	Torch terminal input or threshold detector for NTC temperature sensing and current scale back.
D1	LED2	Power	High-side current source output for flash LED.
D2	TX	I/O	Configurable dual polarity power amplifier synchronization input. Internal pulldown resistor of 300 k Ω between TX and GND.
D3	LED1	Power	High-side current source output for flash LED.

7 Specifications

7.1 Absolute Maximum Ratings

over operating free-air temperature range (unless otherwise noted)⁽¹⁾⁽²⁾

	MIN	MAX	UNIT
IN, SW, OUT, LED1, LED2	-0.3	6	V
SDA, SCL, TX, TORCH/TEMP, HWEN, STROBE	-0.3 to the lesser of (V _{IN} +0.3) w/ 6 V max		V
Continuous power dissipation ⁽³⁾	Internally limited		
Junction temperature (T _{J-MAX})		150	°C
Maximum lead temperature (soldering)	See ⁽⁴⁾		
Storage temperature, T _{stg}	-65	150	°C

- (1) Stresses beyond those listed under *Absolute Maximum Ratings* may cause permanent damage to the device. These are stress ratings only, which do not imply functional operation of the device at these or any other conditions beyond those indicated under *Recommended Operating Conditions*. Exposure to absolute-maximum-rated conditions for extended periods may affect device reliability.
- (2) All voltages are with respect to the potential at the GND terminal.
- (3) Internal thermal shutdown circuitry protects the device from permanent damage. Thermal shutdown engages at T_J = 150°C (typical) and disengages at T_J = 135°C (typical). Thermal shutdown is ensured by design.
- (4) For detailed soldering specifications and information, refer to TI Application Note *DSBGA Wafer Level Chip Scale Package (SNVA009)*.

7.2 ESD Ratings

		VALUE	UNIT
V _(ESD)	Electrostatic discharge	Human-body model (HBM), per ANSI/ESDA/JEDEC JS-001 ⁽¹⁾	V
		Charged-device model (CDM), per JEDEC specification JESD22-C101 ⁽²⁾	

- (1) JEDEC document JEP155 states that 500-V HBM allows safe manufacturing with a standard ESD control process.
- (2) JEDEC document JEP157 states that 250-V CDM allows safe manufacturing with a standard ESD control process.

7.3 Recommended Operating Conditions

over operating free-air temperature range (unless otherwise noted)⁽¹⁾⁽²⁾

	MIN	MAX	UNIT
V _{IN}	2.5	5.5	V
Junction temperature (T _J)	-40	125	°C
Ambient temperature (T _A) ⁽³⁾	-40	85	

- (1) Stresses beyond those listed under *absolute maximum ratings* may cause permanent damage to the device. These are stress ratings only, and functional operation of the device at these or any other conditions beyond those indicated under *recommended operating conditions* is not implied. Exposure to absolute-maximum-rated conditions for extended periods may affect device reliability.
- (2) All voltages are with respect to the potential at the GND terminal.
- (3) In applications where high power dissipation and/or poor package thermal resistance is present, the maximum ambient temperature may have to be derated. Maximum ambient temperature (T_{A-MAX}) is dependent on the maximum operating junction temperature (T_{J-MAX-OP} = 125°C), the maximum power dissipation of the device in the application (P_{D-MAX}), and the junction-to-ambient thermal resistance of the part/package in the application (R_{θJA}), as given by the following equation: T_{A-MAX} = T_{J-MAX-OP} - (R_{θJA} × P_{D-MAX}).

7.4 Thermal Information

THERMAL METRIC ⁽¹⁾		LM3644 DSBGA 12 PINS	UNIT
R _{θJA}	Junction-to-ambient thermal resistance	90.2	°C/W
R _{θJC(top)}	Junction-to-case (top) thermal resistance	0.5	
R _{θJB}	Junction-to-board thermal resistance	40.0	
ψ _{JT}	Junction-to-top characterization parameter	3.0	
ψ _{JB}	Junction-to-board characterization parameter	39.2	

- (1) For more information about traditional and new thermal metrics, see the [Semiconductor and IC Package Thermal Metrics](#).

7.5 Electrical Characteristics

Typical limits tested at $T_A = 25^\circ\text{C}$. Minimum and maximum limits apply over the full operating ambient temperature range ($-40^\circ\text{C} \leq T_A \leq 85^\circ\text{C}$). Unless otherwise specified, $V_{IN} = 3.6\text{ V}$, $\text{HWEN} = V_{IN}$.⁽¹⁾⁽²⁾

PARAMETER		TEST CONDITIONS		MIN	TYP	MAX	UNIT
CURRENT SOURCE SPECIFICATIONS							
$I_{\text{LED1/2}}$	Current source accuracy	$V_{\text{OUT}} = 4\text{ V}$, flash code = 0x7F = 1.5 A flash		-7%	1.5	7%	A
		$V_{\text{OUT}} = 4\text{ V}$, torch code = 0x3F = 89.3 mA torch or flash		-10%	89.3	10%	mA
$I_{\text{LED1/2}}$	Current source accuracy (LM3644TT)	$V_{\text{OUT}} = 4\text{ V}$, torch code = 0x3F = 180 mA torch		-10%	180	10%	mA
V_{HR}	LED1 and LED2 current source regulation voltage	$I_{\text{LED1/2}} = 729\text{ mA}$	Flash	290			mV
		$I_{\text{LED1/2}} = 179\text{ mA}$	Torch	158			
V_{HR}	LED1 and LED2 current source regulation voltage (LM3644TT)	$I_{\text{LED1/2}} = 360\text{ mA}$		270			mV
V_{OVP}		ON threshold		4.86	5	5.1	V
		OFF threshold		4.75	4.88	4.99	
STEP-UP DC/DC CONVERTER SPECIFICATIONS							
R_{PMOS}	PMOS switch on-resistance			86			m Ω
R_{NMOS}	NMOS switch on-resistance			65			m Ω
I_{CL}	Switch current limit	Reg 0x07, bit[0] = 0		-12%	1.9	12%	A
		Reg 0x07, bit[0] = 1		-12%	2.8	12%	
$UVLO$	Undervoltage lockout threshold	Falling V_{IN}		-2%	2.5	2%	V
V_{TRIP}	NTC comparator trip threshold	Reg 0x09, bits[3:1] = '100'		-5%	0.6	5%	V
I_{NTC}	NTC current			-6%	50	6%	μA
V_{IVFM}	Input voltage flash monitor trip threshold	Reg 0x02, bits[5:3] = '000'		-3%	2.9	3%	V
I_{Q}	Quiescent supply current	Device not switching pass mode		0.3		0.75	mA
I_{SD}	Shutdown supply current	Device disabled, $\text{HWEN} = 0\text{ V}$ $2.5\text{ V} \leq V_{\text{IN}} \leq 5.5\text{ V}$		0.1		4	μA
I_{SB}	Standby supply current	Device disabled, $\text{HWEN} = 1.8\text{ V}$ $2.5\text{ V} \leq V_{\text{IN}} \leq 5.5\text{ V}$		2.5		10	μA
HWEN, TORCH/TEMP, STROBE, TX VOLTAGE SPECIFICATIONS							
V_{IL}	Input logic low	$2.5\text{ V} \leq V_{\text{IN}} \leq 5.5\text{ V}$		0	0.4		V
V_{IH}	Input logic high			1.2	V_{IN}		V
I²C-COMPATIBLE INTERFACE SPECIFICATIONS (SCL, SDA)							
V_{IL}	Input logic low	$2.5\text{ V} \leq V_{\text{IN}} \leq 4.2\text{ V}$		0	0.4		V
V_{IH}	Input logic high			1.2	V_{IN}		V
V_{OL}	Output logic low	$I_{\text{LOAD}} = 3\text{ mA}$		400			mV

- (1) Minimum (Min) and Maximum (Max) limits are specified by design, test, or statistical analysis. Typical (typ.) numbers are not verified, but do represent the most likely norm. Unless otherwise specified, conditions for typical specifications are: $V_{\text{IN}} = 3.6\text{ V}$ and $T_A = 25^\circ\text{C}$.
- (2) All voltages are with respect to the potential at the GND pin.

7.6 Timing Requirements

		MIN	NOM	MAX	UNIT
t_1	SCL clock period	2.4			μs
t_2	Data in set-up time to SCL high	100			ns
t_3	Data out stable After SCL low	0			ns
t_4	SDA low set-up time to SCL Low (start)	100			ns
t_5	SDA high hold time after SCL high (stop)	100			ns

7.7 Switching Characteristics

over operating free-air temperature range (unless otherwise noted)

PARAMETER	TEST CONDITIONS	MIN	TYP	MAX	UNIT
f_{sw}	Switching frequency	$2.5\text{ V} \leq V_{\text{IN}} \leq 5.5\text{ V}$	4	6%	MHz

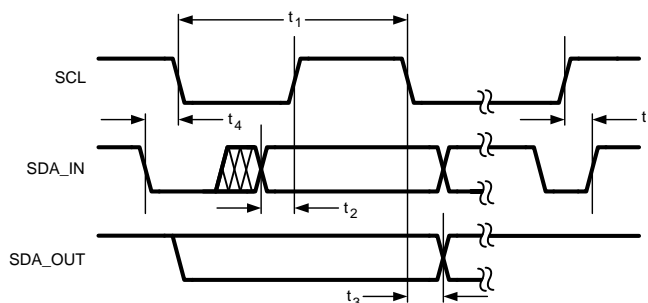

Figure 1. I²C-Compatible Interface Specifications

7.8 Typical Characteristics

Ambient temperature is 25°C, input voltage is 3.6 V, HWEN = V_{IN} , $C_{\text{IN}} = C_{\text{OUT}} = 2 \times 10\ \mu\text{F}$ and $L = 1\ \mu\text{H}$, unless otherwise noted .

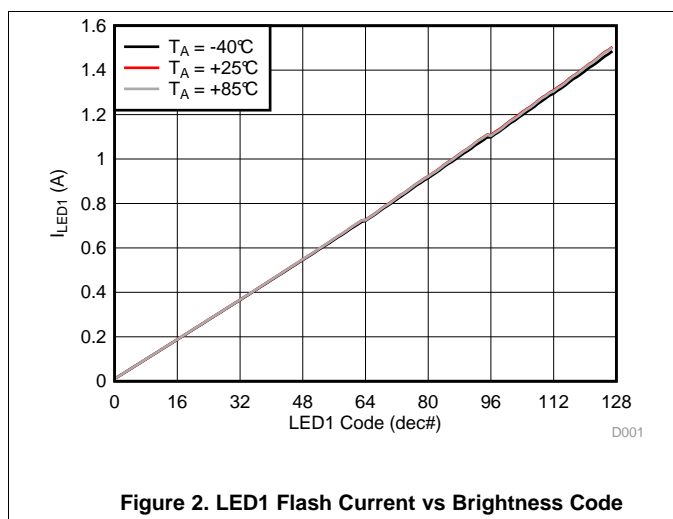

Figure 2. LED1 Flash Current vs Brightness Code

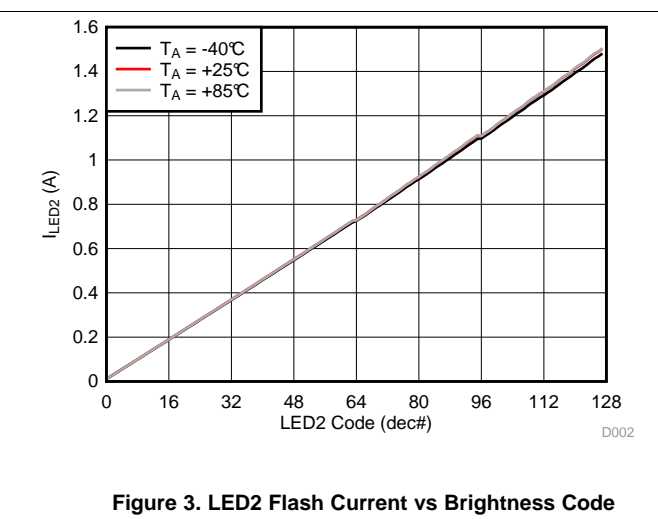

Figure 3. LED2 Flash Current vs Brightness Code

Typical Characteristics (continued)

Ambient temperature is 25°C, input voltage is 3.6 V, HWEN = V_{IN}, C_{IN} = C_{OUT} = 2 × 10 μF and L = 1 μH, unless otherwise noted .

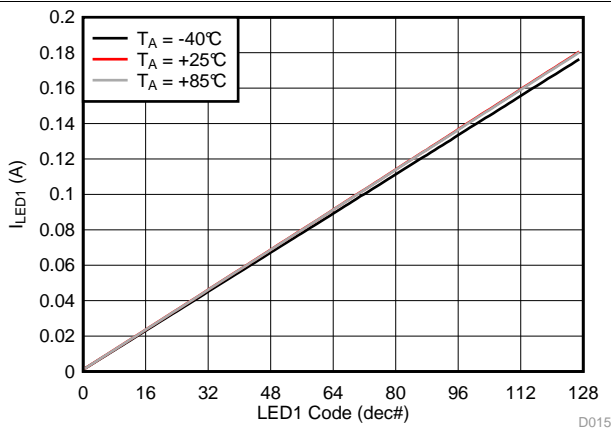

Figure 4. LED1 Torch Current vs Brightness Code

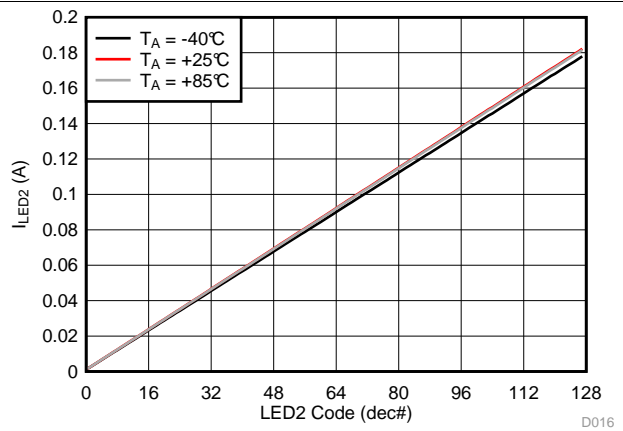
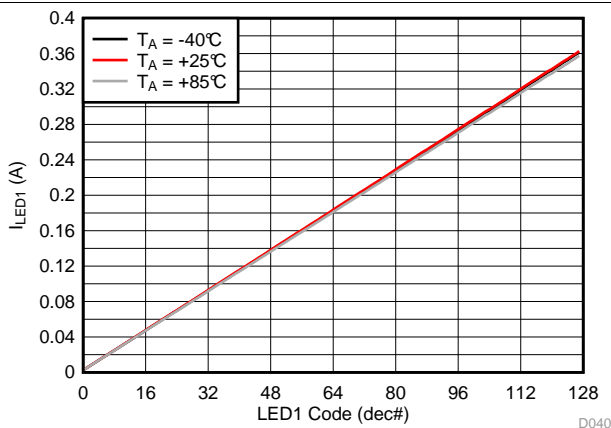
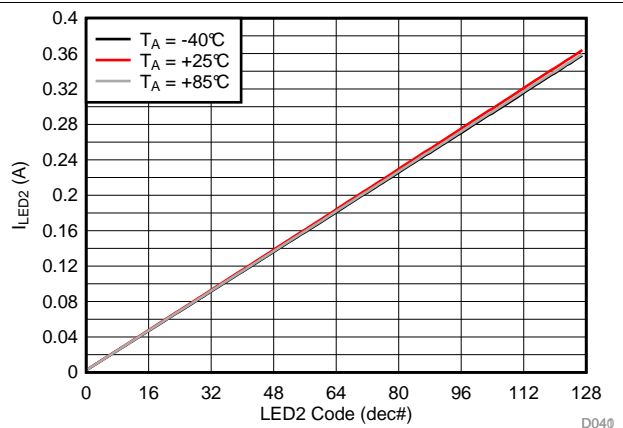

Figure 5. LED2 Torch Current vs Brightness Code



LM3644TT

Figure 6. LED1 Torch Current vs Brightness Code



LM3644TT

Figure 7. LED2 Torch Current vs Brightness Code

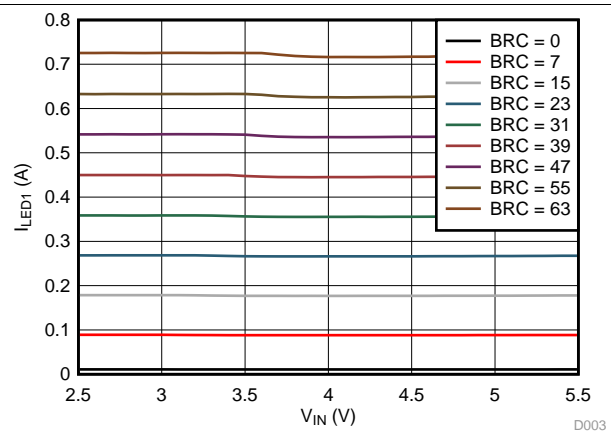

Figure 8. LED1 Current vs Input Voltage

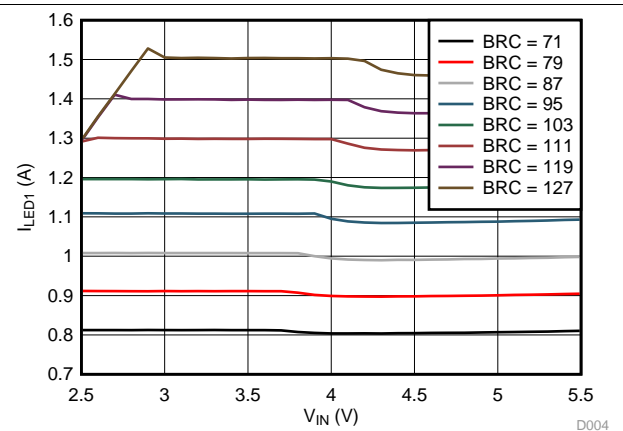

Figure 9. LED1 Current vs Input Voltage

Typical Characteristics (continued)

Ambient temperature is 25°C, input voltage is 3.6 V, HWEN = V_{IN}, C_{IN} = C_{OUT} = 2 × 10 μF and L = 1 μH, unless otherwise noted .

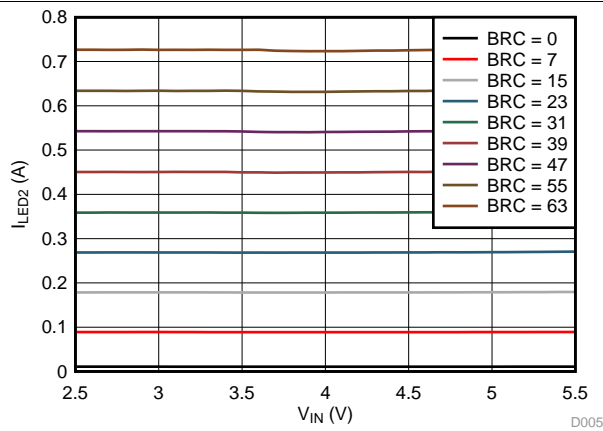

Figure 10. LED2 Current vs Input Voltage

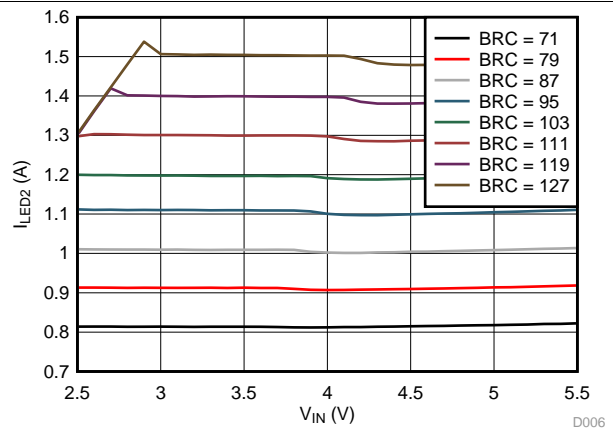

Figure 11. LED2 Current vs Input Voltage

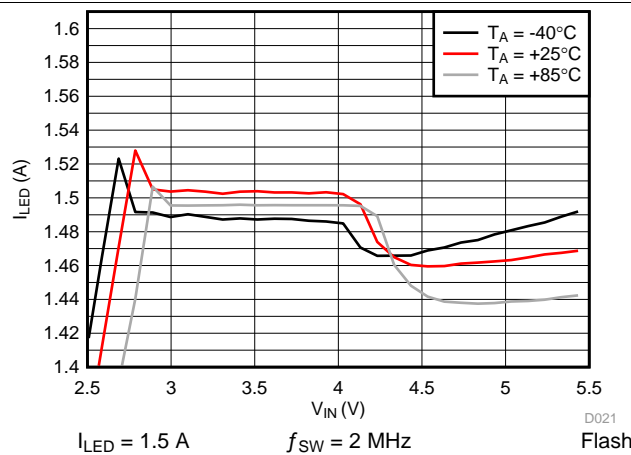

Figure 12. LED1/2 Current vs Input Voltage

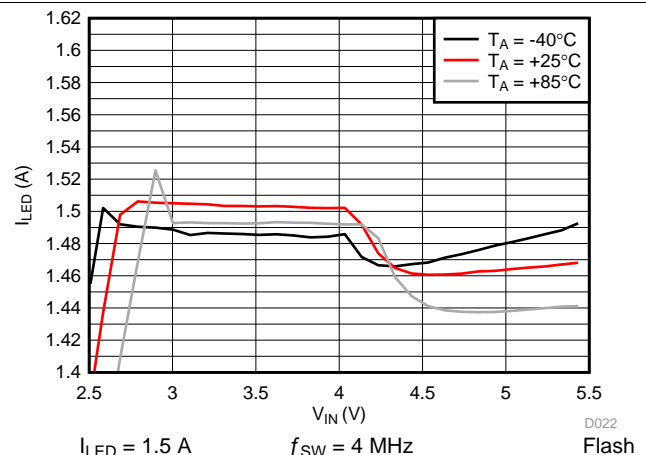

Figure 13. LED1/2 Current vs Input Voltage

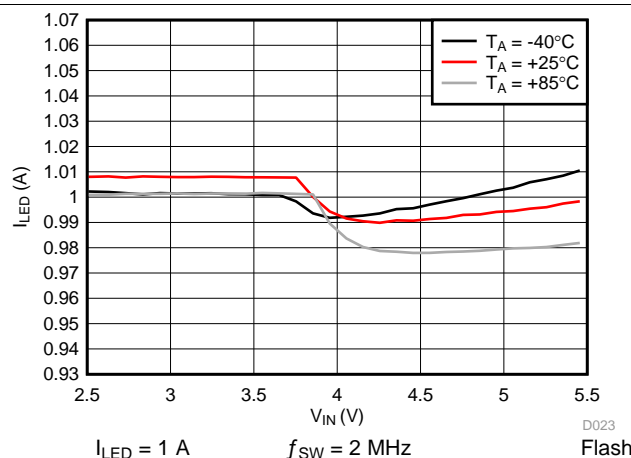

Figure 14. LED1/2 Current vs Input Voltage

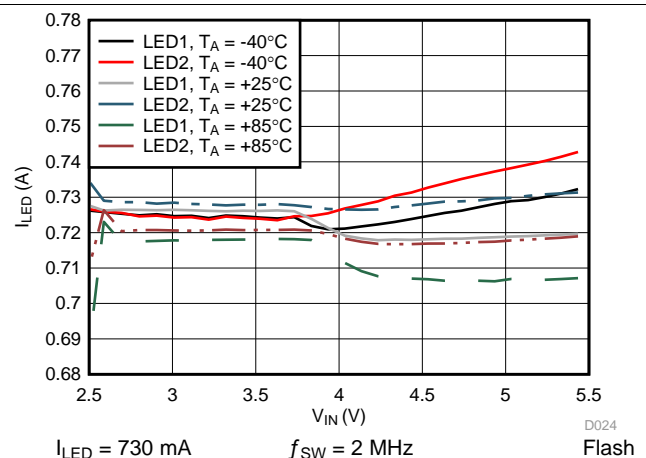

Figure 15. LED1 and LED2 Current vs Input Voltage

Typical Characteristics (continued)

Ambient temperature is 25°C, input voltage is 3.6 V, HWEN = V_{IN}, C_{IN} = C_{OUT} = 2 × 10 μF and L = 1 μH, unless otherwise noted .

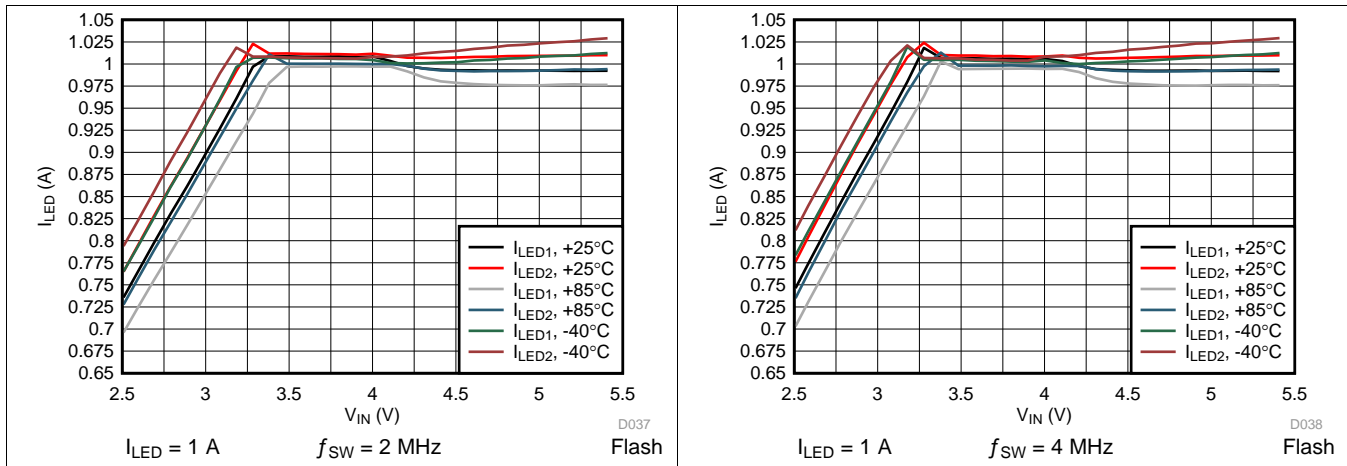

Figure 16. LED1 and LED2 Current vs Input Voltage

Figure 17. LED1 and LED2 Current vs Input Voltage

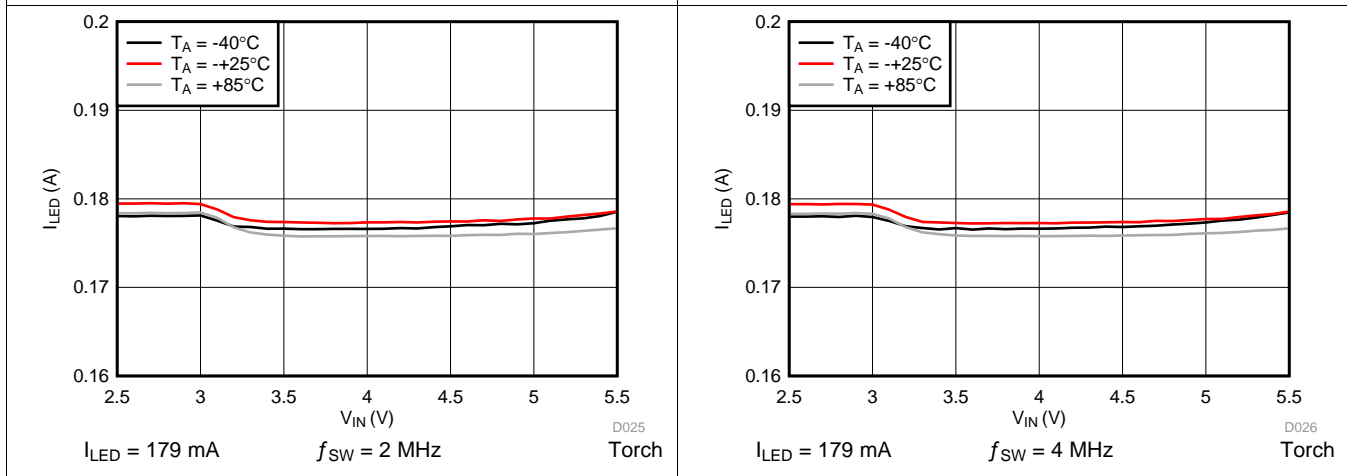

Figure 18. LED Current vs Input Voltage

Figure 19. LED Current vs Input Voltage

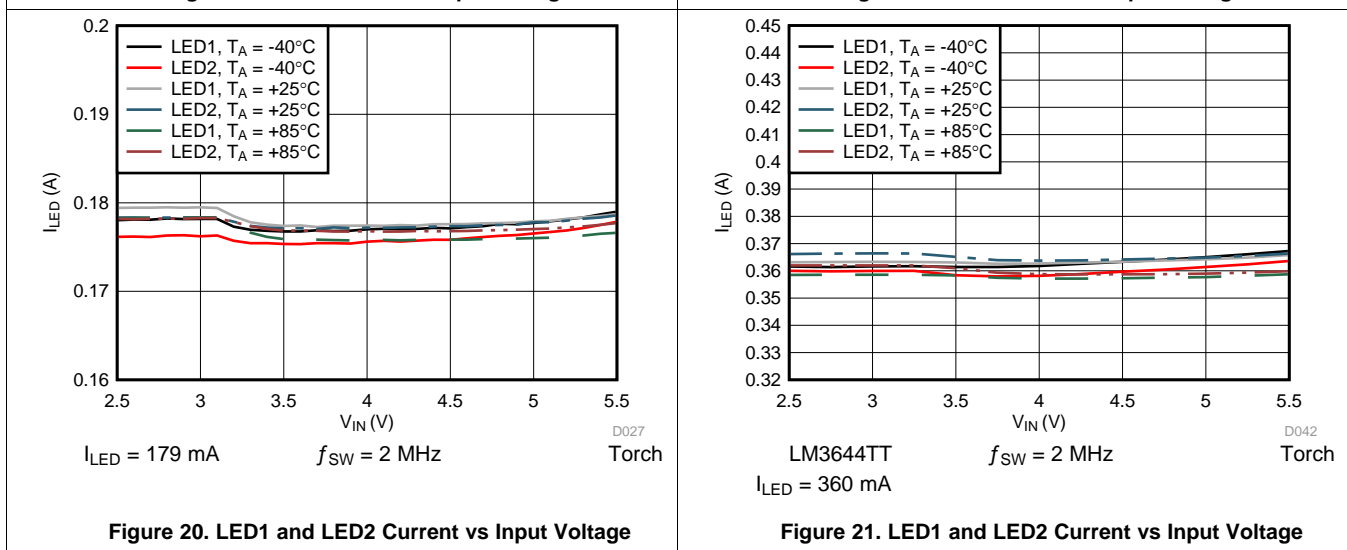

Figure 20. LED1 and LED2 Current vs Input Voltage

Figure 21. LED1 and LED2 Current vs Input Voltage

Typical Characteristics (continued)

Ambient temperature is 25°C, input voltage is 3.6 V, HWEN = V_{IN}, C_{IN} = C_{OUT} = 2 × 10 μF and L = 1 μH, unless otherwise noted .

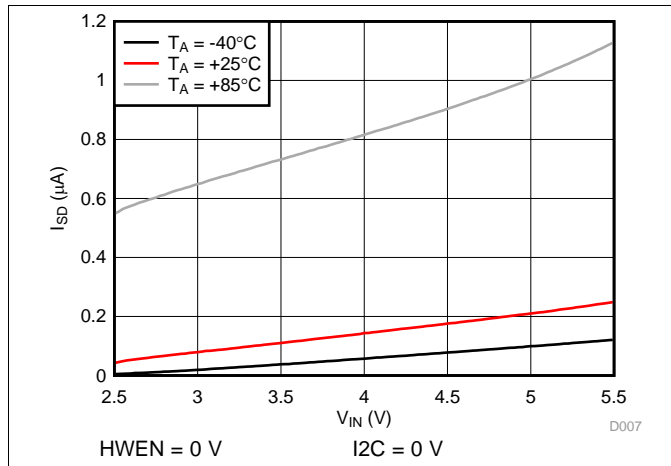

Figure 22. Shutdown Current vs Input Voltage

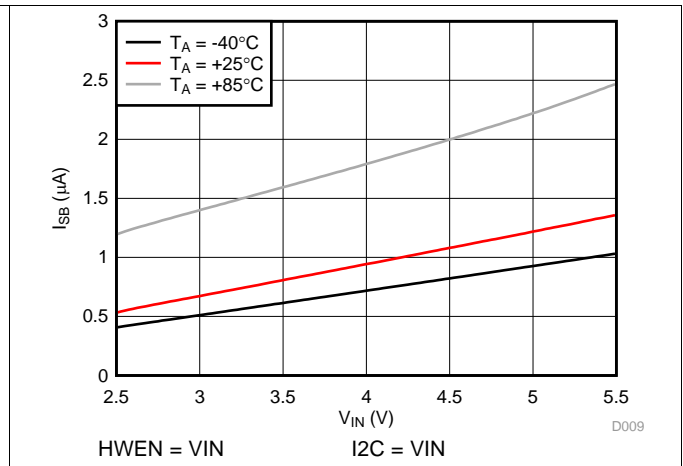

Figure 23. Standby Current vs Input Voltage

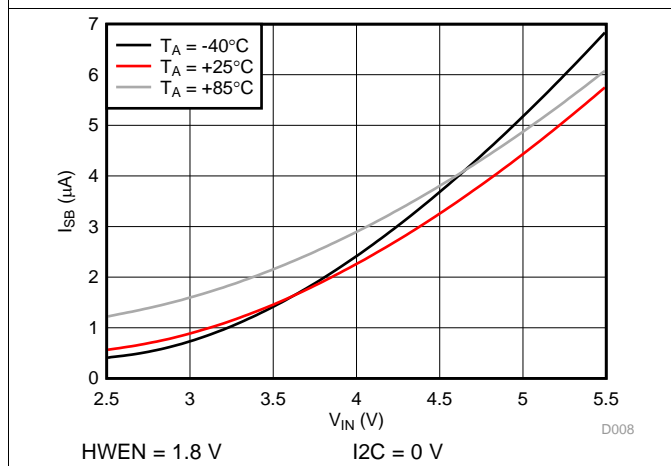

Figure 24. Standby Current vs Input Voltage

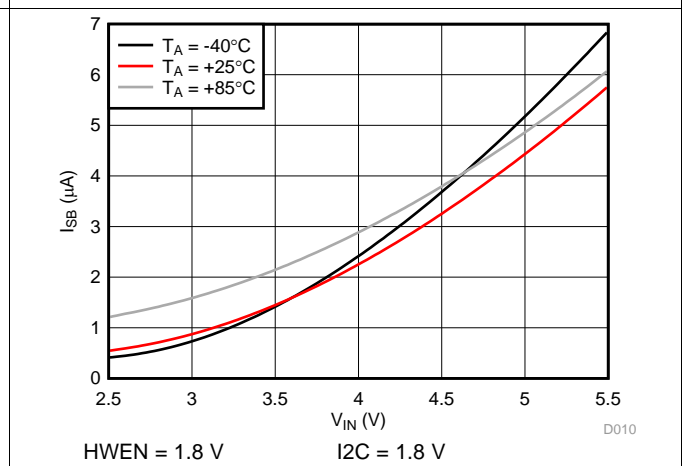

Figure 25. Standby Current vs Input Voltage

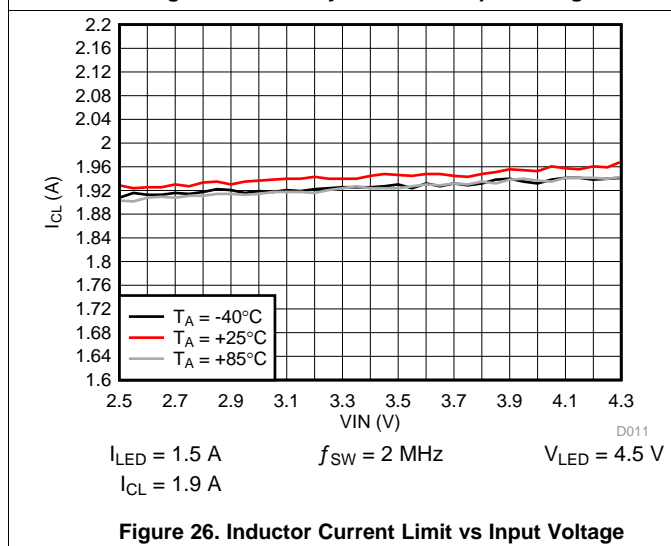

Figure 26. Inductor Current Limit vs Input Voltage

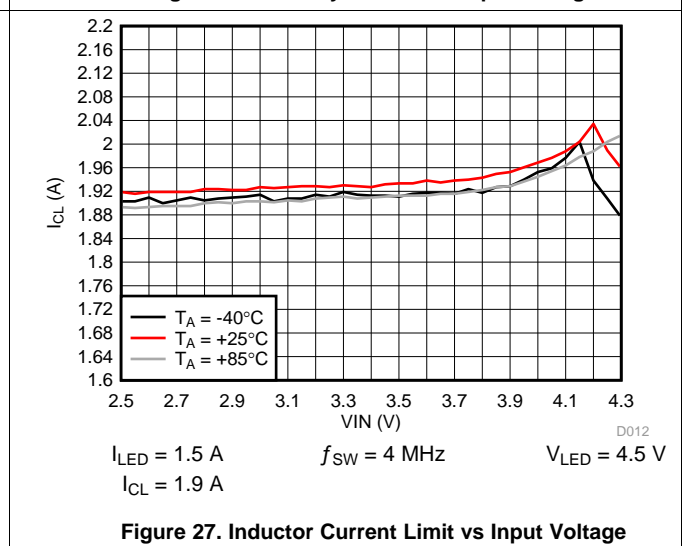

Figure 27. Inductor Current Limit vs Input Voltage

Typical Characteristics (continued)

Ambient temperature is 25°C, input voltage is 3.6 V, $I_{LED} = I_{CL}$, $C_{IN} = C_{OUT} = 2 \times 10 \mu\text{F}$ and $L = 1 \mu\text{H}$, unless otherwise noted.

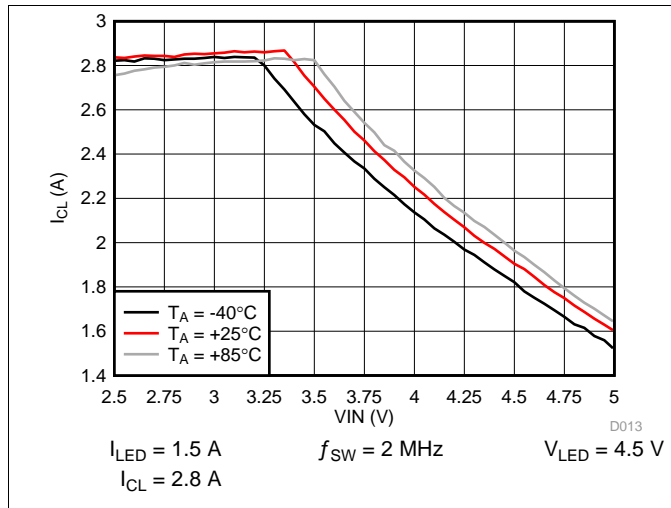

Figure 28. Inductor Current Limit vs Input Voltage

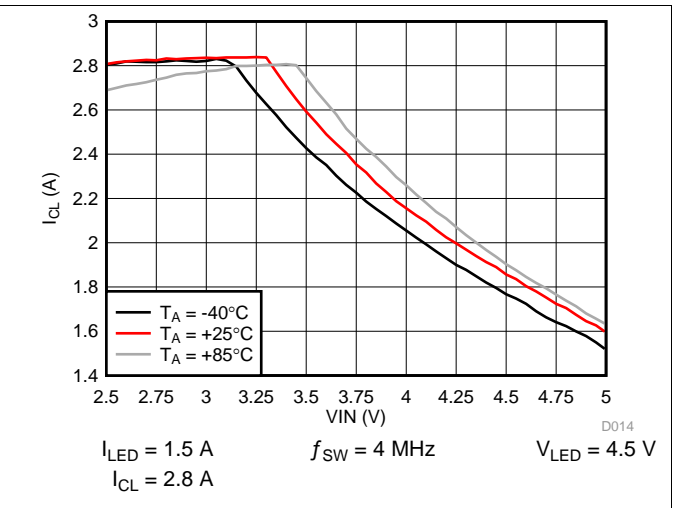

Figure 29. Inductor Current Limit vs Input Voltage

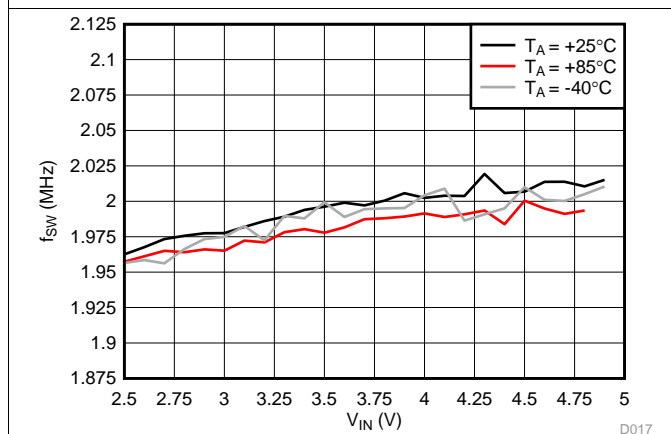

Figure 30. 2-MHz Switching Frequency vs Input Voltage

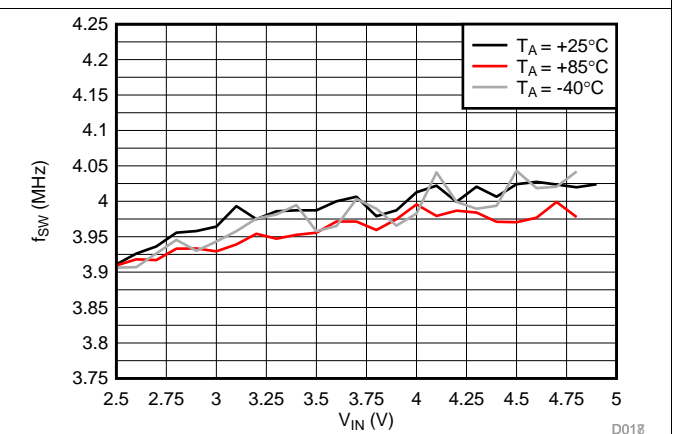

Figure 31. 4-MHz Switching Frequency vs Input Voltage

8 Detailed Description

8.1 Overview

The LM3644 is a high-power white LED flash driver capable of delivering up to 1.5 A in either of the two parallel LEDs. The device incorporates a 2-MHz or 4-MHz constant frequency-synchronous current-mode PWM boost converter and dual high-side current sources to regulate the LED current over the 2.5-V to 5.5-V input voltage range.

The LM3644 PWM DC-DC boost converter switches and boosts the output to maintain at least V_{HR} across each of the current sources (LED1/2). This minimum headroom voltage ensures that both current sources remain in regulation. If the input voltage is above the LED voltage + current source headroom voltage the device does not switch, but turns the PFET on continuously (Pass mode). In Pass mode the difference between $(V_{IN} - I_{LED} \times R_{PMOS})$ and the voltage across the LED is dropped across the current source.

The LM3644 has three logic inputs including a hardware Flash Enable (STROBE), a hardware Torch Enable (TORCH/TEMP, TORCH = default), and a Flash Interrupt input (TX) designed to interrupt the flash pulse during high battery-current conditions. These logic inputs have internal 300-k Ω (typical) pulldown resistors to GND.

Additional features of the LM3644 include an internal comparator for LED thermal sensing via an external NTC thermistor and an input voltage monitor that can reduce the Flash current during low V_{IN} conditions. It also has a Hardware Enable (HWEN) pin that can be used to reset the state of the device and the registers by pulling the HWEN pin to ground.

Control is done via an I²C-compatible interface. This includes adjustment of the Flash and Torch current levels, changing the Flash Timeout Duration, and changing the switch current limit. Additionally, there are flag and status bits that indicate flash current time-out, LED overtemperature condition, LED failure (open/short), device thermal shutdown, TX interrupt, and V_{IN} undervoltage conditions.

8.2 Functional Block Diagram

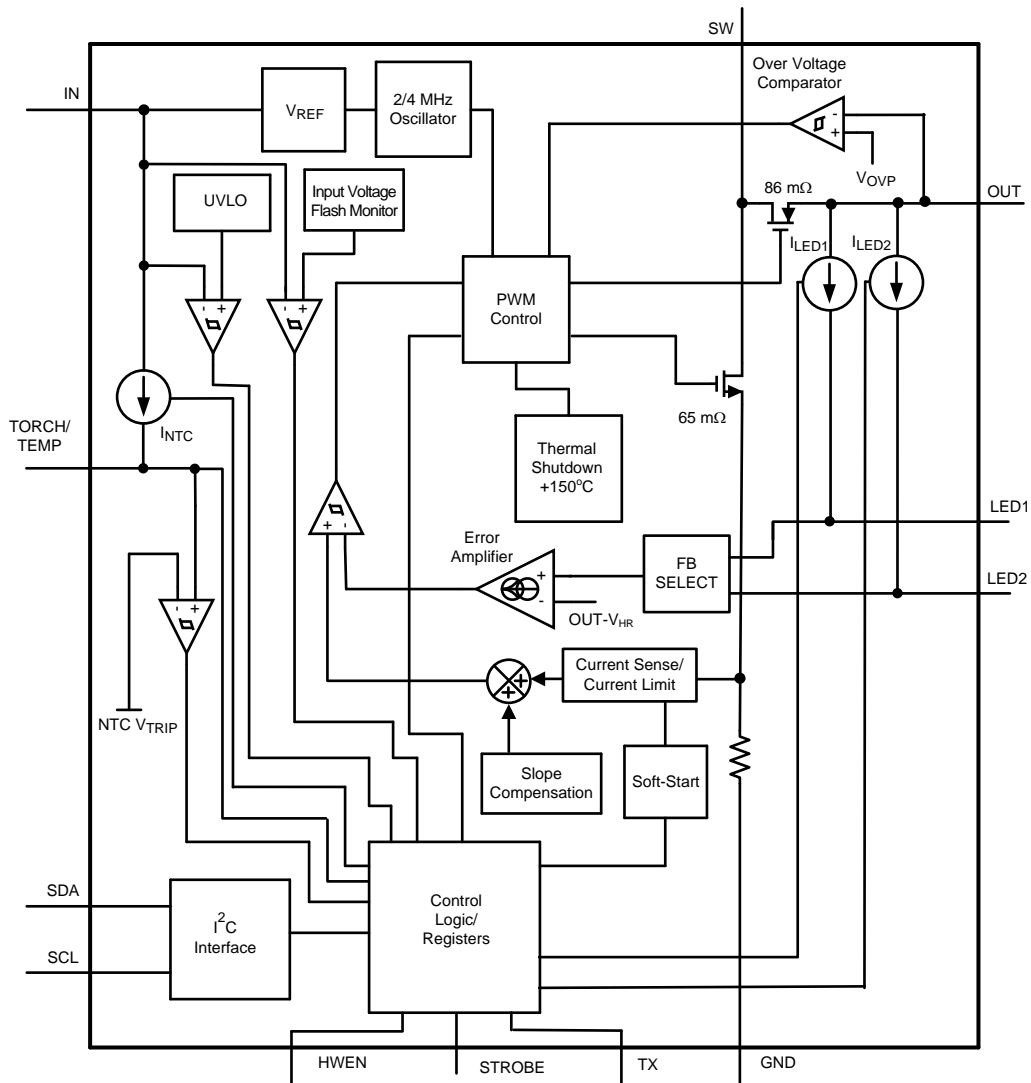

8.3 Feature Description

8.3.1 Flash Mode

In Flash Mode, the LED current sources (LED1/2) provide 128 target current levels from 10.9 mA to 1500 mA. Once the Flash sequence is activated the current source (LED) ramps up to the programmed Flash current by stepping through all current steps until the programmed current is reached. The headroom in the two current sources can be regulated to provide 10.9 mA to 1.5 A on each of the two output legs. There is an option in the register settings to keep the two currents in the output leg the same.

When the device is enabled in Flash Mode through the Enable Register, all mode bits in the Enable Register are cleared after a flash time-out event.

Feature Description (continued)

8.3.2 Torch Mode

In Torch mode, the LED current sources (LED1/2) provide 128 target current levels from 0.977 mA to 179 mA or 1.954 mA to 360 mA on LM3644TT. The Torch currents are adjusted via the LED1 and LED2 LED Torch Brightness Registers. Torch mode is activated by the Enable Register (setting M1, M0 to '10'), or by pulling the TORCH/TEMP pin HIGH when the pin is enabled (Enable Register) and set to Torch Mode. Once the TORCH sequence is activated the active current sources (LED1/2) ramps up to the programmed Torch current by stepping through all current steps until the programmed current is reached. The rate at which the current ramps is determined by the value chosen in the Timing Register.

Torch Mode is not affected by Flash Timeout or by a TX Interrupt event.

8.3.3 IR Mode

In IR Mode, the target LED current is equal to the value stored in the LED1/2 Flash Brightness Registers. When IR mode is enabled (setting M1, M0 to '01'), the boost converter turns on and set the output equal to the input (pass-mode). At this point, toggling the STROBE pin enables and disables the LED1/2 current sources (if enabled). The strobe pin can only be set to be Level sensitive, meaning all timing of the IR pulse is externally controlled. In IR Mode, the current sources do not ramp the LED outputs to the target. The current transitions immediately from off to on and then on to off.

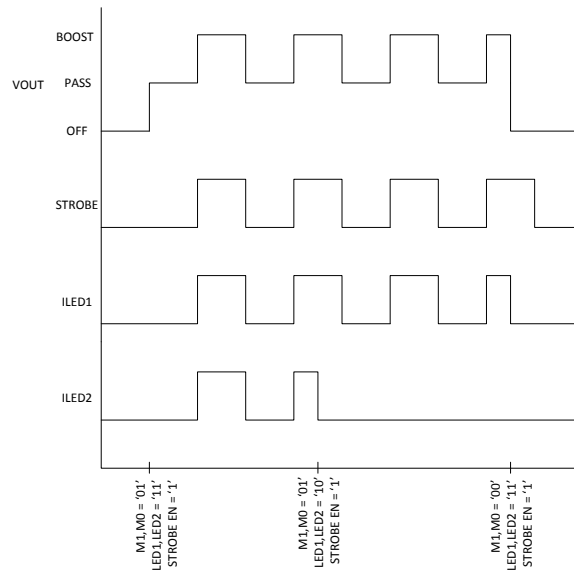

Figure 32. IR Mode with Boost

Feature Description (continued)

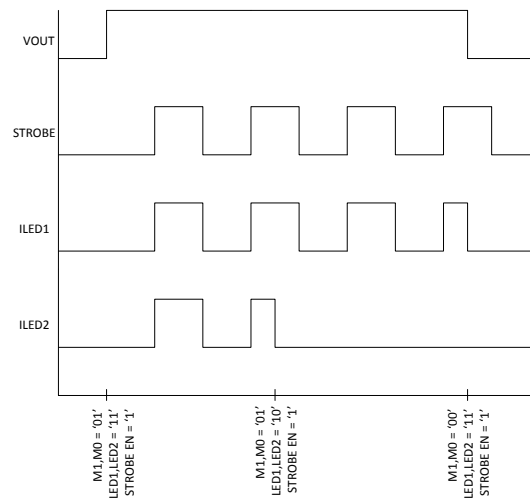

Figure 33. IR Mode Pass Only

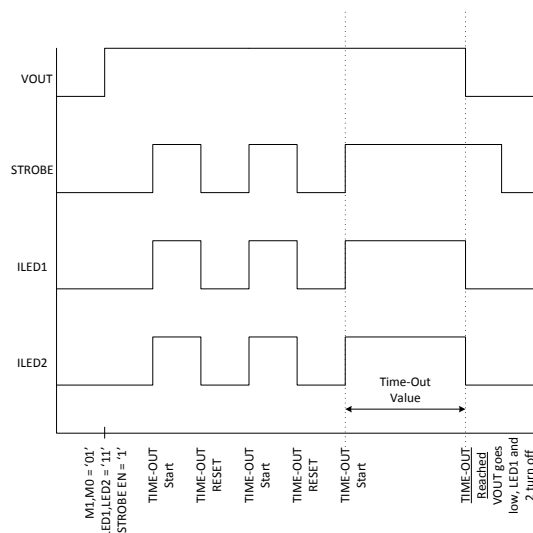

Figure 34. IR Mode Timeout

8.4 Device Functioning Modes

8.4.1 Start-Up (Enabling The Device)

Turn on of the LM3644 Torch and Flash modes can be done through the Enable Register. On start-up, when V_{OUT} is less than V_{IN} the internal synchronous PFET turns on as a current source and delivers 200 mA (typical) to the output capacitor. During this time the current source (LED) is off. When the voltage across the output capacitor reaches 2.2 V (typical) the current source turns on. At turnon the current source steps through each FLASH or TORCH level until the target LED current is reached. This gives the device a controlled turnon and limits inrush current from the V_{IN} supply.

Device Functioning Modes (continued)

8.4.2 Pass Mode

The LM3644 starts up in Pass Mode and stays there until Boost Mode is needed to maintain regulation. If the voltage difference between V_{OUT} and V_{LED} falls below V_{HR} , the device switches to Boost Mode. In Pass Mode the boost converter does not switch, and the synchronous PFET turns fully on bringing V_{OUT} up to $V_{IN} - I_{LED} \times R_{PMOS}$. In Pass Mode the inductor current is not limited by the peak current limit.

8.4.3 Power Amplifier Synchronization (TX)

The TX pin is a Power Amplifier Synchronization input. This is designed to reduce the flash LED current and thus limit the battery current during high battery current conditions such as PA transmit events. When the LM3644 is engaged in a Flash event, and the TX pin is pulled high, the LED current is forced into Torch Mode at the programmed Torch current setting. If the TX pin is then pulled low before the Flash pulse terminates, the LED current returns to the previous Flash current level. At the end of the Flash time-out, whether the TX pin is high or low, the LED current turns off.

8.4.4 Input Voltage Flash Monitor (IVFM)

The LM3644 has the ability to adjust the flash current based upon the voltage level present at the IN pin utilizing the Input Voltage Flash Monitor (IVFM). The adjustable threshold IVFM-D ranges from 2.9 V to 3.6 V in 100-mV steps, with three different usage modes (Stop and Hold, Adjust Down Only, Adjust Up and Down). The Flags2 Register has the IVFM flag bit set when the input voltage crosses the IVFM-D value. Additionally, the IVFM-D threshold sets the input voltage boundary that forces the LM3644 to either stop ramping the flash current during start-up (Stop and Hold Mode) or to start decreasing the LED current during the flash (Down Adjust Only and Up and Down Adjust). In Adjust Up and Down mode, the IVFM-D value plus the hysteresis voltage threshold set the input voltage boundary that forces the LM3644 to start ramping the flash current back up towards the target.

Device Functioning Modes (continued)

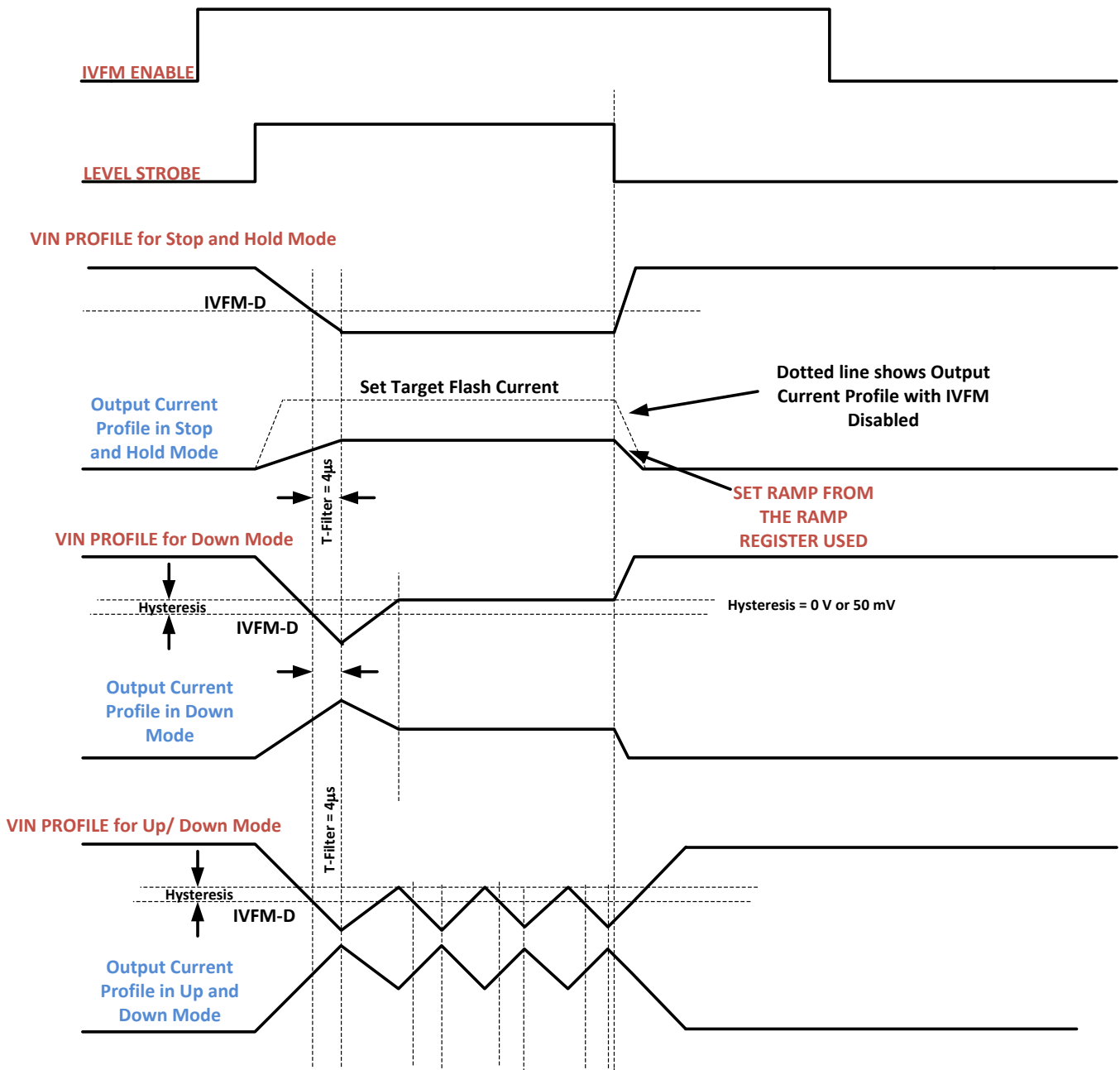

Figure 35. IVFM Modes

Device Functioning Modes (continued)

8.4.5 Fault/Protections

8.4.5.1 Fault Operation

If the LM3644 enters a fault condition, the device sets the appropriate flag in the Flags1 and Flags2 Registers (0x0A and 0x0B), and place the device into standby by clearing the Mode Bits ([1],[0]) in the Enable Register. The LM3644 remains in standby until an I²C read of the Flags1 and Flags2 Registers are completed. Upon clearing the flags/faults, the device can be restarted (Flash, Torch, IR, etc.). If the fault is still present, the LM3644 re-enters the fault state and enters standby again.

8.4.5.2 Flash Time-Out

The Flash Time-Out period sets the amount of time that the Flash Current is being sourced from the current sources (LED1/2). The LM3644 has 16 timeout levels ranging from 10 ms to 400 ms or 40 ms to 1.6 s on LM3644TT (see [Timing Configuration Register \(0x08\)](#) for more detail).

8.4.5.3 Overvoltage Protection (OVP)

The output voltage is limited to typically 5 V (see V_{OVP} spec in the [Electrical Characteristics](#)). In situations such as an open LED, the LM3644 raises the output voltage in order to try and keep the LED current at its target value. When V_{OUT} reaches 5 V (typical) the overvoltage comparator trips and turns off the internal NFET. When V_{OUT} falls below the “ **V_{OVP} Off Threshold**”, the LM3644 begins switching again. The mode bits are cleared, and the OVP flag is set, when an OVP condition is present for three rising OVP edges. This prevents momentary OVP events from forcing the device to shut down.

8.4.5.4 Current Limit

The LM3644 features two selectable inductor current limits that are programmable through the I²C-compatible interface. When the inductor current limit is reached, the LM3644 terminates the charging phase of the switching cycle. Switching resumes at the start of the next switching period. If the overcurrent condition persists, the device operates continuously in current limit.

Since the current limit is sensed in the NMOS switch, there is no mechanism to limit the current when the device operates in Pass Mode (current does not flow through the NMOS in pass mode). In Boost mode or Pass mode if V_{OUT} falls below 2.3 V, the device stops switching, and the PFET operates as a current source limiting the current to 200 mA. This prevents damage to the LM3644 and excessive current draw from the battery during output short-circuit conditions. The mode bits are not cleared upon a Current Limit event, but a flag is set.

8.4.5.5 NTC Thermistor Input (Torch/Temp)

The TORCH/TEMP pin, when set to TEMP mode, serves as a threshold detector and bias source for negative temperature coefficient (NTC) thermistors. When the voltage at TEMP goes below the programmed threshold, the LM3644 is placed into standby mode. The NTC threshold voltage is adjustable from 200 mV to 900 mV in 100-mV steps. The NTC bias current is set to 50 μ A. The NTC detection circuitry can be enabled or disabled via the Enable Register. If enabled, the NTC block turns on and off during the start and stop of a Flash/Torch event.

Additionally, the NTC input looks for an open NTC connection and a shorted NTC connection. If the NTC input falls below 100 mV, the NTC short flag is set, and the device is disabled. If the NTC input rises above 2.3 V, the NTC Open flag is set, and the device is disabled. These fault detections can be individually disabled/enabled via the NTC Open Fault Enable bit and the NTC Short Fault Enable bit.

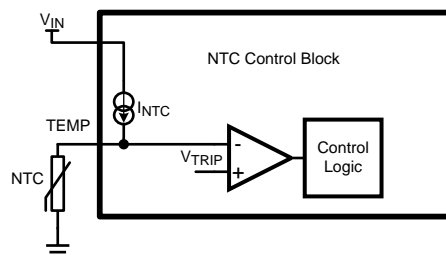

Figure 36. Temp Detection Diagram

Device Functioning Modes (continued)

8.4.5.6 Undervoltage Lockout (UVLO)

The LM3644 has an internal comparator that monitors the voltage at IN and forces the LM3644 into standby if the input voltage drops to 2.5 V. If the UVLO monitor threshold is tripped, the UVLO flag bit is set in the Flags1 Register (0x0A). If the input voltage rises above 2.5 V, the LM3644 is not available for operation until there is an I²C read of the Flags1 Register (0x0A). Upon a read, the Flags1 register is cleared, and normal operation can resume if the input voltage is greater than 2.5 V.

8.4.5.7 Thermal Shutdown (TSD)

When the LM3644 die temperature reaches 150°C, the thermal shutdown detection circuit trips, forcing the LM3644 into standby and writing a '1' to the corresponding bit of the Flags1 Register (0x0A) (Thermal Shutdown bit). The LM3644 is only allowed to restart after the Flags1 Register (0x0A) is read, clearing the fault flag. Upon restart, if the die temperature is still above 150°C, the LM3644 resets the Fault flag and re-enters standby.

8.4.5.8 LED and/or V_{OUT} Short Fault

The LED Fault flags read back a '1' if the device is active in Flash or Torch mode and either active LED output experiences a short condition. The Output Short Fault flag reads back a '1' if the device is active in Flash or Torch mode and the boost output experiences a short condition. An LED short condition is determined if the voltage at LED1 or LED2 goes below 500 mV (typ.) while the device is in Torch or Flash mode. There is a deglitch time of 256 μs before the LED Short flag is valid and a deglitch time of 2.048 ms before the V_{OUT} Short flag is valid. The LED Short Faults can be reset to '0' by removing power to the LM3644, setting HWEN to '0', setting the SW RESET bit to a '1', or by reading back the Flags1 Register (0x0A on LM3644). The mode bits are cleared upon an LED and/or V_{OUT} short fault.

8.5 Programming

8.5.1 Control Truth Table

MODE1	MODE0	STROBE EN	TORCH EN	STROBE PIN	TORCH PIN	ACTION
0	0	0	0	X	X	Standby
0	0	0	1	X	pos edge	Ext Torch
0	0	1	0	pos edge	X	Ext Flash
0	0	1	1	0	pos edge	Standalone Torch
0	0	1	1	pos edge	0	Standalone Flash
0	0	1	1	pos edge	pos edge	Standalone Flash
1	0	X	X	X	X	Int Torch
1	1	X	X	X	X	Int Flash
0	1	0	X	X	X	IRLED Standby
0	1	1	X	0	X	IRLED Standby
0	1	1	X	pos edge	X	IRLED enabled

8.5.2 I²C-Compatible Interface

8.5.2.1 Data Validity

The data on SDA must be stable during the HIGH period of the clock signal (SCL). In other words, the state of the data line can only be changed when SCL is LOW.

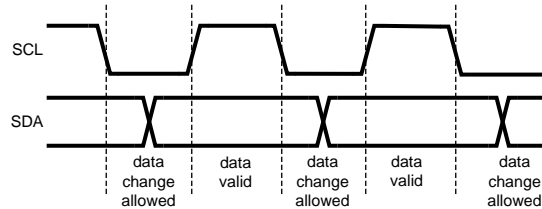

Figure 37. Data Validity Data

A pullup resistor between the controller's VIO line and SDA must be greater than $[(VIO - V_{OL}) / 3 \text{ mA}]$ to meet the V_{OL} requirement on SDA. Using a larger pullup resistor results in lower switching current with slower edges, while using a smaller pullup results in higher switching currents with faster edges.

8.5.2.2 Start and Stop Conditions

START and STOP conditions classify the beginning and the end of the I²C session. A START condition is defined as the SDA signal transitioning from HIGH to LOW while SCL line is HIGH. A STOP condition is defined as the SDA transitioning from LOW to HIGH while SCL is HIGH. The I²C master always generates START and STOP conditions. The I²C bus is considered busy after a START condition and free after a STOP condition. During data transmission, the I²C master can generate repeated START conditions. First START and repeated START conditions are equivalent, function-wise.

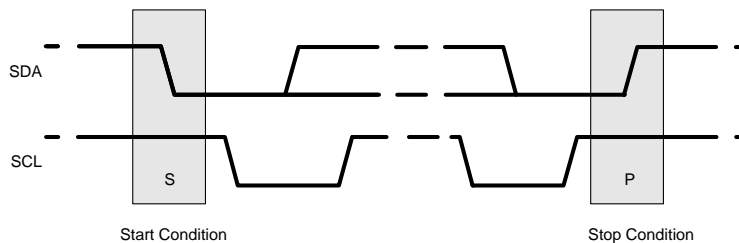

Figure 38. Start and Stop Conditions

8.5.2.3 Transferring Data

Every byte put on the SDA line must be eight bits long, with the most significant bit (MSB) transferred first. Each byte of data has to be followed by an acknowledge bit. The acknowledge related clock pulse is generated by the master. The master releases the SDA line (HIGH) during the acknowledge clock pulse. The LM3644 pulls down the SDA line during the 9th clock pulse, signifying an acknowledge. The LM3644 generates an acknowledge after each byte is received. There is no acknowledge created after data is read from the device.

After the START condition, the I²C master sends a chip address. This address is seven bits long followed by an eighth bit which is a data direction bit (R/W). The LM3644 7-bit address is 0x63. For the eighth bit, a '0' indicates a WRITE and a '1' indicates a READ. The second byte selects the register to which the data is written. The third byte contains data to write to the selected register.

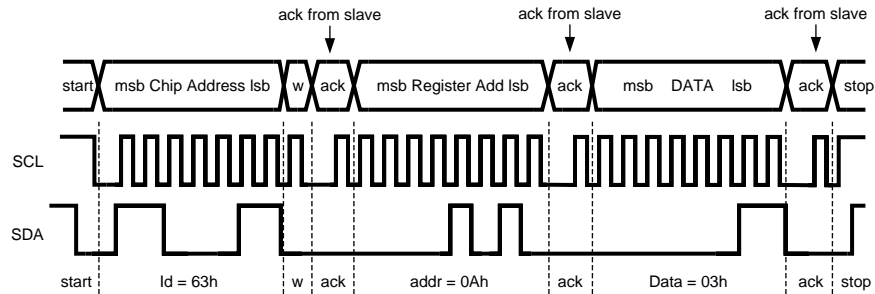

Figure 39. Write Cycle W = Write (SDA = "0") R = Read (SDA = "1") Ack = Acknowledge (SDA Pulled Down by Either Master or Slave) ID = Chip Address, 63h for LM3644

8.5.2.4 I²C-Compatible Chip Address

The device address for the LM3644 is 1100011 (0x63). After the START condition, the I²C-compatible master sends the 7-bit address followed by an eighth read or write bit (R/W). R/W = 0 indicates a WRITE and R/W = 1 indicates a READ. The second byte following the device address selects the register address to which the data is written. The third byte contains the data for the selected register.

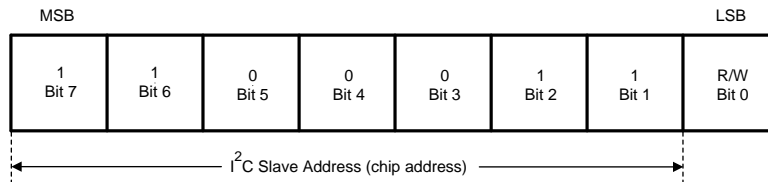

Figure 40. I²C-Compatible Chip Address

8.6 Register Descriptions

REGISTER NAME	INTERNAL HEX ADDRESS	POWER ON/RESET VALUE LM3644
Enable Register	0x01	0x80
IVFM Register	0x02	0x01
LED1 Flash Brightness Register	0x03	0xBF
LED2 Flash Brightness Register	0x04	0x3F
LED1 Torch Brightness Register	0x05	0xBF
LED2 Torch Brightness Register	0x06	0x3F
Boost Configuration Register	0x07	0x09
Timing Configuration Register	0x08	0x1A
TEMP Register	0x09	0x08
Flags1 Register	0x0A	0x00
Flags2 Register	0x0B	0x00
Device ID Register	0x0C	0x02 or 0x04 for LM3644TT
Last Flash Register	0x0D	0x00

8.6.1 Enable Register (0x01)

Bit 7	Bit 6	Bit 5	Bit 4	Bit 3	Bit 2	Bit 1	Bit 0
TX Pin Enable 0 = Disabled 1 = Enabled (Default)	Strobe Type 0 = Level Triggered (Default) 1 = Edge Triggered	Strobe Enable 0 = Disabled (Default) 1 = Enabled	TORCH/TEMP Pin Enable 0 = Disabled (Default) 1 = Enabled	Mode Bits: M1, M0 00 = Standby (Default) 01 = IR Drive 10 = Torch 11 = Flash		LED2 Enable 0 = OFF (Default) 1 = ON	LED1 Enable 0 = OFF (Default) 1 = ON

NOTE

Edge Strobe Mode is not valid in IR MODE. Switching between Level and Edge Strobe Types while the device is enabled is not recommended.

In Edge or Level Strobe Mode, it is recommended that the trigger pulse width be set greater than 1 ms to ensure proper turn-on of the device.

8.6.2 IVFM Register (0x02)

Bit 7	Bit 6	Bit 5	Bit 4	Bit 3	Bit 2	Bit 1	Bit 0
RFU	UVLO Circuitry (Default) 0 = Disabled (Default) 1 = Enabled	IVFM Levels 000 = 2.9 V (Default) 001 = 3 V 010 = 3.1 V 011 = 3.2 V 100 = 3.3 V 101 = 3.4 V 110 = 3.5 V 111 = 3.6 V		IVFM Hysteresis 0 = 0 mV (Default) 1 = 50 mV	IVFM Selection 00 = Disabled 01 = Stop and Hold Mode (Default) 10 = Down Mode 11 = Up and Down Mode		

NOTE

IVFM Mode Bits are static once the LM3644 is enabled in Torch, Flash or IR modes. If the IVFM mode needs to be updated, disable the device and then change the mode bits to the desired state.

8.6.3 LED1 Flash Brightness Register (0x03)

Bit 7	Bit 6	Bit 5	Bit 4	Bit 3	Bit 2	Bit 1	Bit 0
LED2 Flash Current Override 0 = LED2 Flash Current is not set to LED1 Flash Current 1 = LED2 Flash Current is set to LED1 Flash Current (Default)	LED1 Flash Brightness Level $I_{FLASH1/2} \text{ (mA)} \approx (\text{Brightness Code} \times 11.725 \text{ mA}) + 10.9 \text{ mA}$ 0000000 = 10.9 mA 0111111 = 729 mA (Default) 1111111 = 1.5 A						

8.6.4 LED2 Flash Brightness Register (0x04)

Bit 7	Bit 6	Bit 5	Bit 4	Bit 3	Bit 2	Bit 1	Bit 0
RFU	LED2 Flash Brightness Levels $I_{FLASH1/2} \text{ (mA)} \approx (\text{Brightness Code} \times 11.725 \text{ mA}) + 10.9 \text{ mA}$ 0000000 = 10.9 mA 0111111 = 729 mA (Default) 1111111 = 1.5 A						

8.6.5 LED1 Torch Brightness Register (0x05)

Bit 7	Bit 6	Bit 5	Bit 4	Bit 3	Bit 2	Bit 1	Bit 0
LED2 Torch Current Override 0 = LED2 Torch Current is not set to LED1 Torch Current 1 = LED2 Torch Current is set to LED1 Torch Current (Default)	LED1 Torch Brightness Levels $I_{TORCH1/2} (mA) \approx (Brightness\ Code \times 1.4\ mA) + 0.977\ mA$ or $I_{TORCH1/2} (mA) \approx (Brightness\ Code \times 2.8\ mA) + 1.954\ mA$ (LM3644TT) 0000000 = 0.977 mA or 1.954 mA for LM3644TT 0111111 = 89.3 mA (Default) or 178.6 mA for LM3644TT 1111111 = 179 mA or 360mA for LM3644TT						

8.6.6 LED2 Torch Brightness Register (0x06)

Bit 7	Bit 6	Bit 5	Bit 4	Bit 3	Bit 2	Bit 1	Bit 0
RFU	LED2 Torch Brightness Levels $I_{TORCH1/2} (mA) \approx (Brightness\ Code \times 1.4\ mA) + 0.977\ mA$ or $I_{TORCH1/2} (mA) \approx (Brightness\ Code \times 2.8\ mA) + 1.954\ mA$ (LM3644TT) 0000000 = 0.977 mA or 1.954 mA (LM3644TT) 0111111 = 89.3 mA (Default) or 178.6 mA (LM3644TT) 1111111 = 179 mA or 360mA (LM3644TT)						

8.6.7 Boost Configuration Register (0x07)

Bit 7	Bit 6	Bit 5	Bit 4	Bit 3	Bit 2	Bit 1	Bit 0
Software Reset Bit 0 = Not Reset (Default) 1 = Reset	RFU	RFU	RFU	LED Pin Short Fault Detect 0 = Disabled (Default) 1 = Enabled	Boost Mode 0 = Normal (Default) 1 = Pass Mode Only	Boost Frequency Select 0 = 2 MHz (Default) 1 = 4 MHz	Boost Current Limit Setting 0 = 1.9 A 1 = 2.8 A (Default)

8.6.8 Timing Configuration Register (0x08)

Bit 7	Bit 6	Bit 5	Bit 4	Bit 3	Bit 2	Bit 1	Bit 0
RFU	Torch Current Ramp Time 000 = No Ramp 001 = 1 ms (Default) 010 = 32 ms 011 = 64 ms 100 = 128 ms 101 = 256 ms 110 = 512 ms 111 = 1024 ms			Flash Time-Out Duration 0000 = 10 ms or 40 ms (LM3644TT) 0001 = 20 ms or 80 ms (LM3644TT) 0010 = 30 ms or 120 ms (LM3644TT) 0011 = 40 ms or 160 ms (LM3644TT) 0100 = 50 ms or 200 ms (LM3644TT) 0101 = 60 ms or 240 ms (LM3644TT) 0110 = 70 ms or 280 ms (LM3644TT) 0111 = 80 ms or 320 ms (LM3644TT) 1000 = 90 ms or 360 ms (LM3644TT) 1001 = 100 ms or 400 ms (LM3644TT) 1010 = 150 ms (Default) or 600 ms (LM3644TT) 1011 = 200 ms or 800 ms (LM3644TT) 1100 = 250 ms or 1000 ms (LM3644TT) 1101 = 300 ms or 1200 ms (LM3644TT) 1110 = 350 ms or 1400 ms (LM3644TT) 1111 = 400 ms or 1600 ms (LM3644TT)			

NOTE

On the LM3644TT, special care must be taken with regards to thermal management when using time-out values greater than 400 ms. Depending on the PCB layout, input voltage and output current, it is possible to have the internal thermal shutdown circuit trip prior to reaching the desired flash time-out value.

8.6.9 TEMP Register (0x09)

Bit 7	Bit 6	Bit 5	Bit 4	Bit 3	Bit 2	Bit 1	Bit 0
RFU	TORCH Polarity 0 = Active High (Default) (Pull-down Resistor Enabled) 1 = Active Low (Pull-down Resistor Disabled)	NTC Open Fault Enable 0 = Disabled (Default) 1 = Enable	NTC Short Fault Enable 0 = Disabled (Default) 1 = Enable	TEMP Detect Voltage Threshold 000 = 0.2 V 001 = 0.3 V 010 = 0.4 V 011 = 0.5 V 100 = 0.6 V (Default) 101 = 0.7 V 110 = 0.8 V 111 = 0.9 V			TORCH/TEMP Function Select 0 = TORCH (Default) 1 = TEMP

NOTE

The Torch Polarity bit is static once the LM3644 is enabled in Torch, Flash or IR modes. If the Torch Polarity bit needs to be updated, disable the device and then change the Torch Polarity bit to the desired state.

8.6.10 Flags1 Register (0x0A)

Bit 7	Bit 6	Bit 5	Bit 4	Bit 3	Bit 2	Bit 1	Bit 0
TX Flag	V _{OUT} Short Fault	VLED1 Short Fault	VLED2 Short Fault	Current Limit Flag	Thermal Shutdown (TSD) Fault	UVLO Fault	Flash Time-Out Flag

8.6.11 Flags2 Register (0x0B)

Bit 7	Bit 6	Bit 5	Bit 4	Bit 3	Bit 2	Bit 1	Bit 0
RFU	RFU	RFU	NTC Short Fault	NTC Open Fault	IVFM Trip Flag	OVP Fault	TEMP Trip Fault

8.6.12 Device ID Register (0x0C)

Bit 7	Bit 6	Bit 5	Bit 4	Bit 3	Bit 2	Bit 1	Bit 0
RFU	RFU	Device ID '000'			Silicon Revision Bits '010' or '100' for LM3644TT		

8.6.13 Last Flash Register (0x0D)

Bit 7	Bit 6	Bit 5	Bit 4	Bit 3	Bit 2	Bit 1	Bit 0
RFU	The value stored is always the last current value the IVFM detection block set. $I_{LED} = I_{FLASH - TARGET} \times ((Code + 1) / 128)$						

9 Applications and Implementation

NOTE

Information in the following applications sections is not part of the TI component specification, and TI does not warrant its accuracy or completeness. TI's customers are responsible for determining suitability of components for their purposes. Customers should validate and test their design implementation to confirm system functionality.

9.1 Application Information

The LM3644 can drive two flash LEDs at currents up to 1.5 A per LED. The 2-MHz/4-MHz DC-DC boost regulator allows for the use of small value discrete external components.

9.2 Typical Application

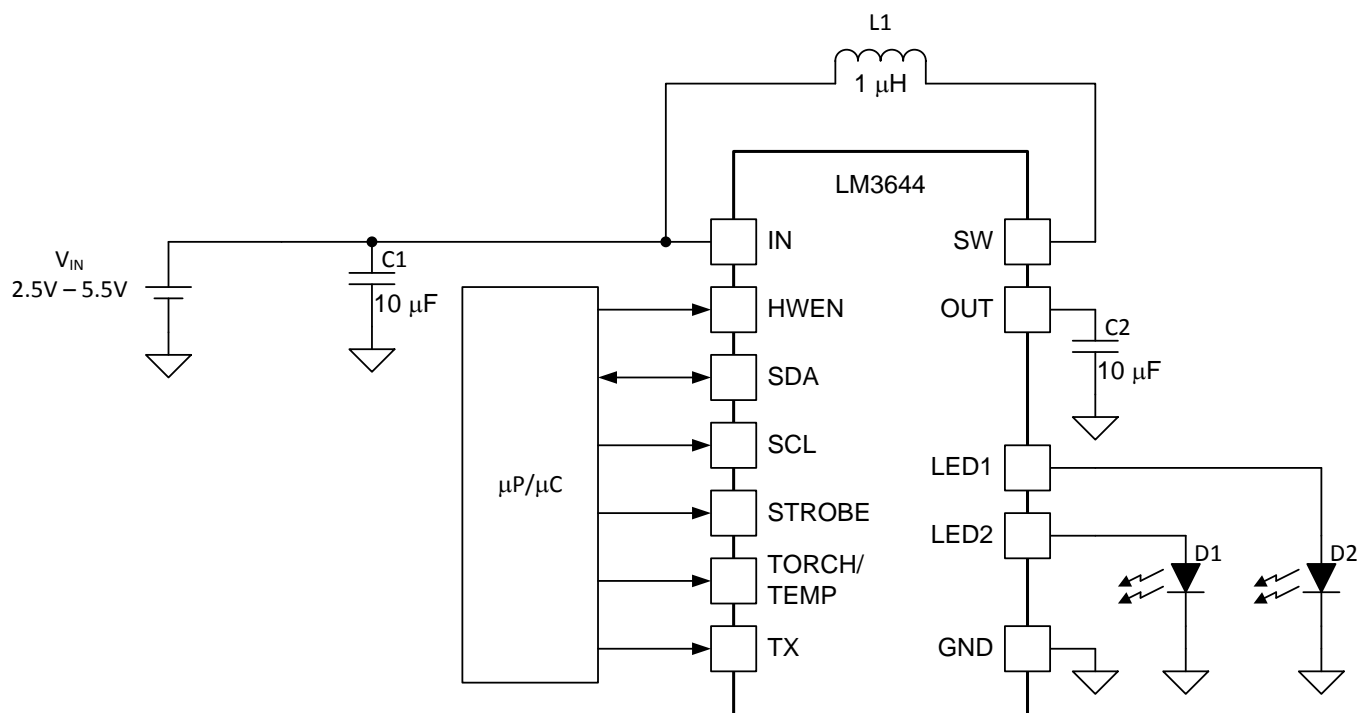

Figure 41. LM3644 Typical Application

9.2.1 Design Requirements

Example requirements based on default register values:

DESIGN PARAMETER	EXAMPLE VALUE
Input voltage range	2.5 V to 5.5 V
Brightness control	I ² C Register
LED configuration	2 parallel flash LEDs
Boost switching frequency	2 MHz (4 MHz selectable)
Flash brightness	750 mA per LED

9.2.2 Detailed Design Procedure

9.2.2.1 Output Capacitor Selection

The LM3644 is designed to operate with a 10- μ F ceramic output capacitor. When the boost converter is running, the output capacitor supplies the load current during the boost converter on-time. When the NMOS switch turns off, the inductor energy is discharged through the internal PMOS switch, supplying power to the load and restoring charge to the output capacitor. This causes a sag in the output voltage during the on-time and a rise in the output voltage during the off-time. The output capacitor is therefore chosen to limit the output ripple to an acceptable level depending on load current and input/output voltage differentials and also to ensure the converter remains stable.

Larger capacitors such as a 22- μ F or capacitors in parallel can be used if lower output voltage ripple is desired. To estimate the output voltage ripple considering the ripple due to capacitor discharge (ΔV_Q) and the ripple due to the capacitors ESR (ΔV_{ESR}) use the following equations:

For continuous conduction mode, the output voltage ripple due to the capacitor discharge is:

$$\Delta V_Q = \frac{I_{LED} \times (V_{OUT} - V_{IN})}{f_{SW} \times V_{OUT} \times C_{OUT}} \quad (1)$$

The output voltage ripple due to the output capacitors ESR is found by:

$$\Delta V_{ESR} = R_{ESR} \times \left(\frac{I_{LED} \times V_{OUT}}{V_{IN}} + \Delta I_L \right)$$

where

$$\Delta I_L = \frac{V_{IN} \times (V_{OUT} - V_{IN})}{2 \times f_{SW} \times L \times V_{OUT}} \quad (2)$$

In ceramic capacitors the ESR is very low so the assumption is that 80% of the output voltage ripple is due to capacitor discharge and 20% from ESR. [Table 1](#) lists different manufacturers for various output capacitors and their case sizes suitable for use with the LM3644.

9.2.2.2 Input Capacitor Selection

Choosing the correct size and type of input capacitor helps minimize the voltage ripple caused by the switching of the LM3644 boost converter and reduce noise on the boost converter's input pin that can feed through and disrupt internal analog signals. In the typical application circuit a 10- μ F ceramic input capacitor works well. It is important to place the input capacitor as close as possible to the LM3644 input (IN) pin. This reduces the series resistance and inductance that can inject noise into the device due to the input switching currents. [Table 1](#) lists various input capacitors recommended for use with the LM3644.

Table 1. Recommended Input/Output Capacitors (X5R/X7R Dielectric)

MANUFACTURER	PART NUMBER	VALUE	CASE SIZE	VOLTAGE RATING
TDK Corporation	C1608JB0J106M	10 μ F	0603 (1.6 mm \times 0.8 mm \times 0.8 mm)	6.3 V
TDK Corporation	C2012JB1A106M	10 μ F	0805 (2.0 mm \times 1.25 mm \times 1.25 mm)	10 V
Murata	GRM188R60J106M	10 μ F	0603 (1.6 mm \times 0.8 mm \times 0.8 mm)	6.3 V
Murata	GRM21BR61A106KE19	10 μ F	0805 (2.0 mm \times 1.25 mm \times 1.25 mm)	10 V

9.2.2.3 Inductor Selection

The LM3644 is designed to use a 0.47- μ H or 1- μ H inductor. [Table 2](#) lists various inductors and their manufacturers that work well with the LM3644. When the device is boosting ($V_{OUT} > V_{IN}$) the inductor is typically the largest area of efficiency loss in the circuit. Therefore, choosing an inductor with the lowest possible series resistance is important. Additionally, the saturation rating of the inductor should be greater than the maximum operating peak current of the LM3644. This prevents excess efficiency loss that can occur with inductors that operate in saturation. For proper inductor operation and circuit performance, ensure that the inductor saturation and the peak current limit setting of the LM3644 are greater than I_{PEAK} in the following calculation:

$$I_{PEAK} = \frac{I_{LOAD}}{\eta} \times \frac{V_{OUT}}{V_{IN}} + \Delta I_L \quad \text{where} \quad \Delta I_L = \frac{V_{IN} \times (V_{OUT} - V_{IN})}{2 \times f_{SW} \times L \times V_{OUT}}$$

where

- $f_{SW} = 2$ or 4 MHz

(3)

Efficiency details can be found in the [Application Curves](#).

Table 2. Recommended Inductors

MANUFACTURER	L	PART NUMBER	DIMENSIONS (LxWxH)	I _{SAT}	R _{DC}
TOKO	0.47 μH	DFE201610P-R470M	2.0 mm x 1.6 mm x 1.0 mm	4.1 A	32 mΩ
TOKO	1 μH	DFE201610P-1R0M	2.0 mm x 1.6 mm x 1.0 mm	3.7 A	58 mΩ

9.2.3 Application Curves

Ambient temperature is 25°C, input voltage is 3.6 V, HWEN = V_{IN}, C_{IN} = 2 × 10 μF, C_{OUT} = 2 × 10 μF and L = 1 μH, unless otherwise noted.

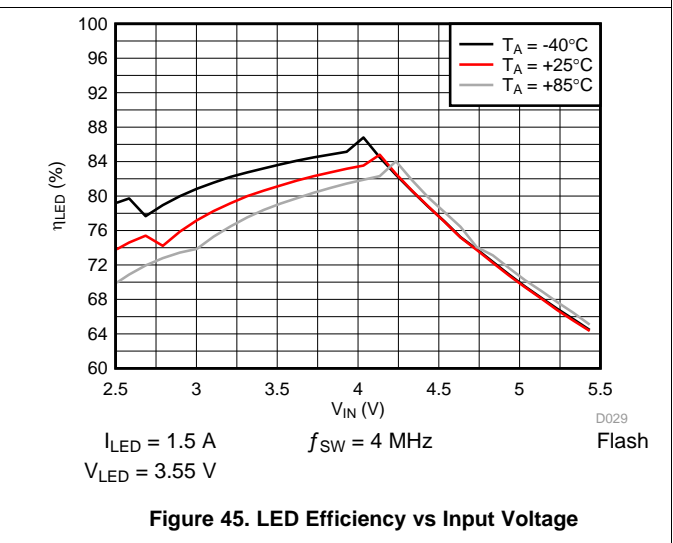
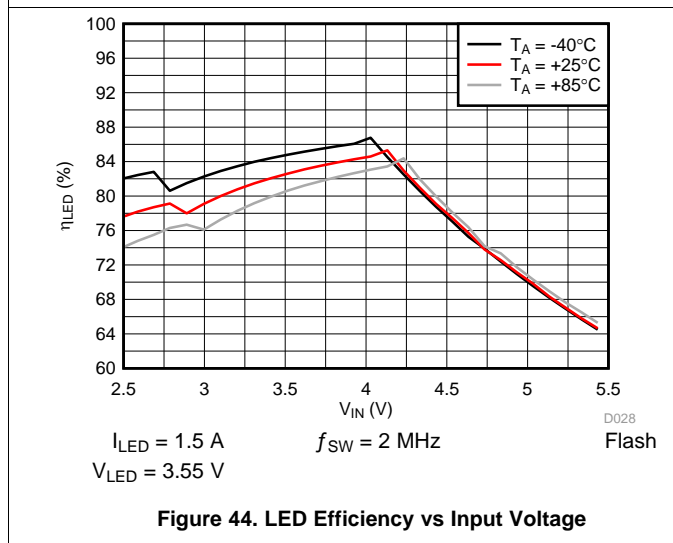
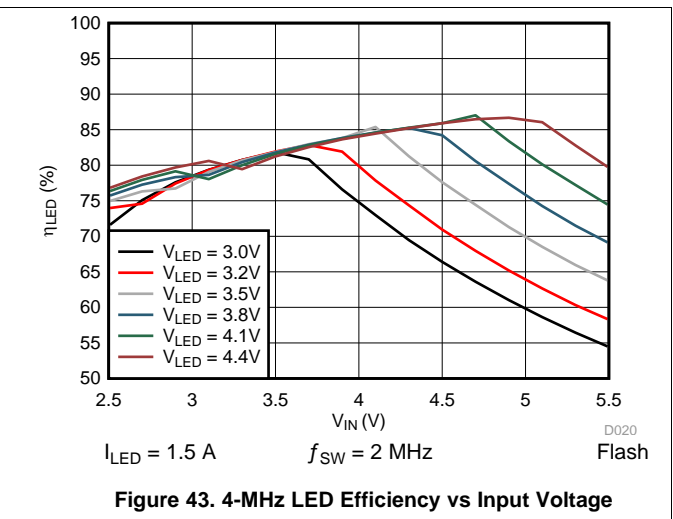
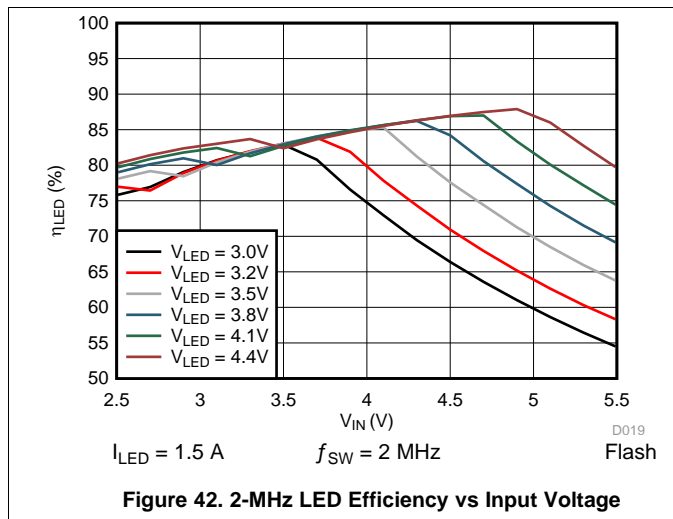

Ambient temperature is 25°C, input voltage is 3.6 V, HWEN = V_{IN}, C_{IN} = 2 × 10 μF, C_{OUT} = 2 × 10 μF and L = 1 μH, unless otherwise noted.

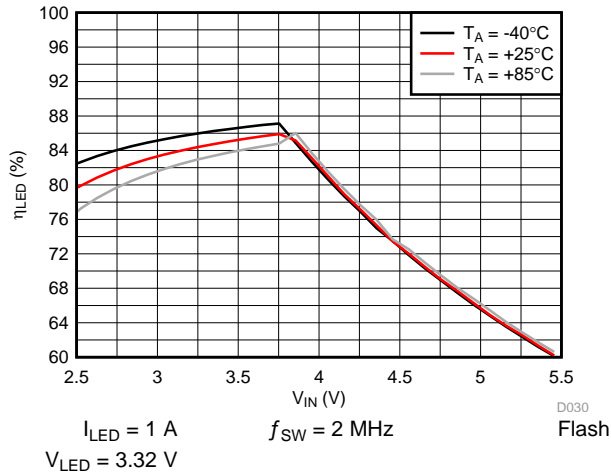

Figure 46. LED Efficiency vs Input Voltage

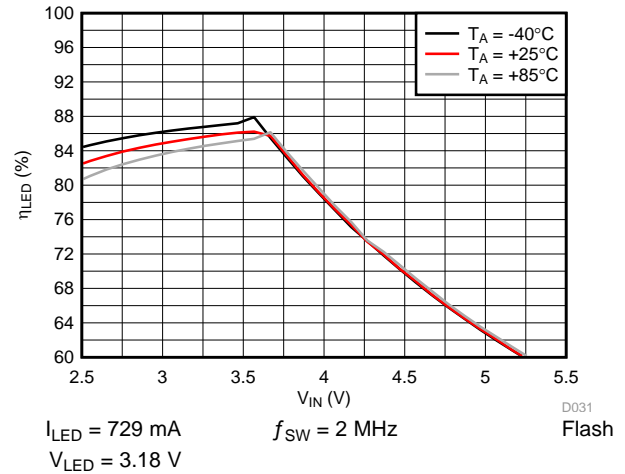

Figure 47. LED Efficiency vs Input Voltage

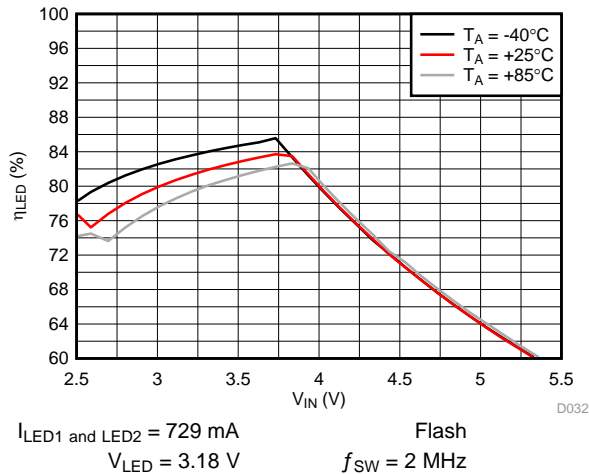

Figure 48. LED Efficiency vs Input Voltage

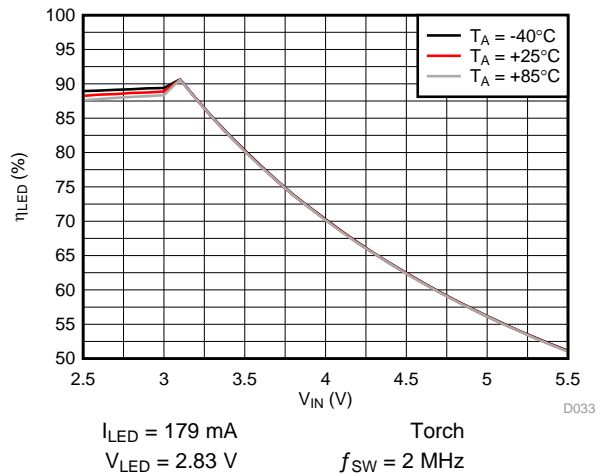

Figure 49. LED Efficiency vs Input Voltage

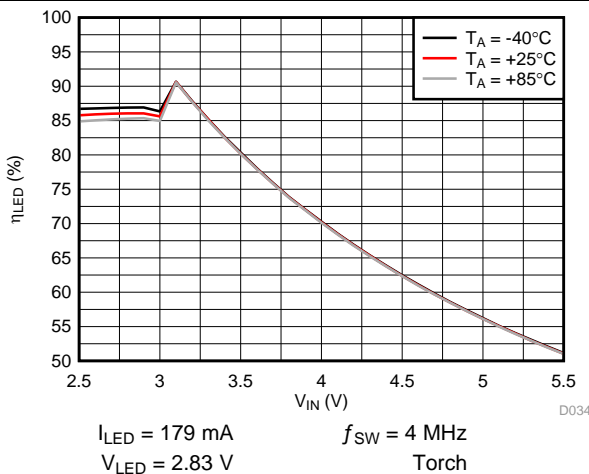

Figure 50. LED Efficiency vs Input Voltage

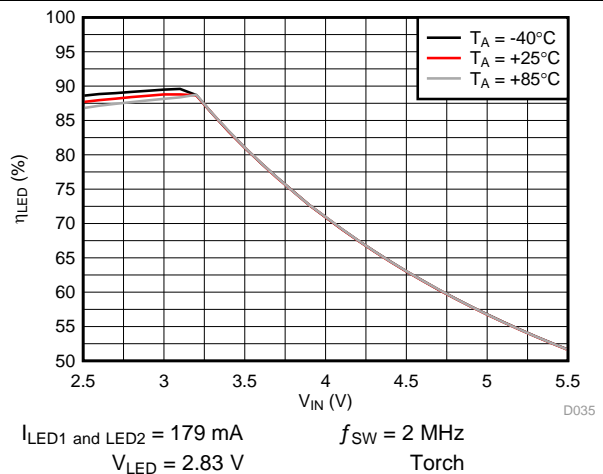
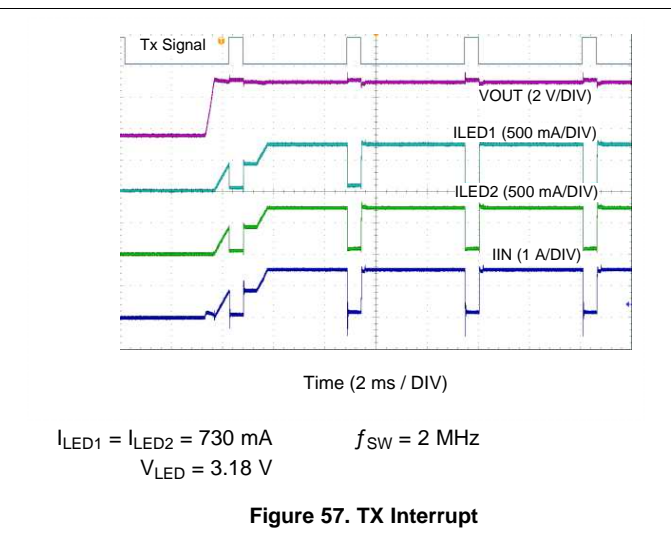
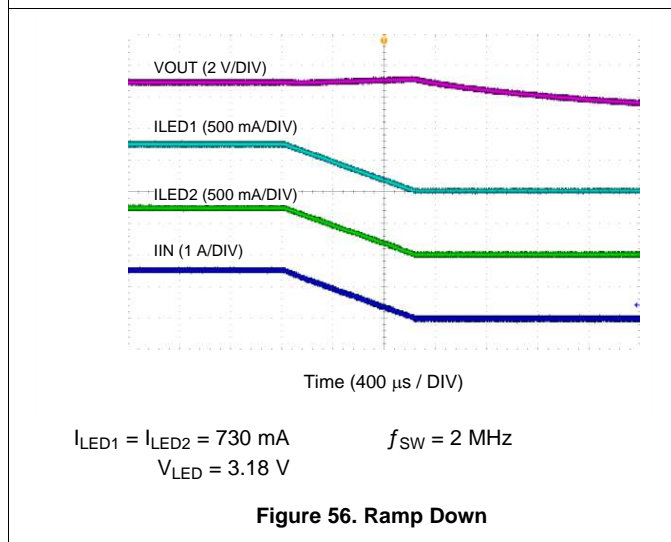
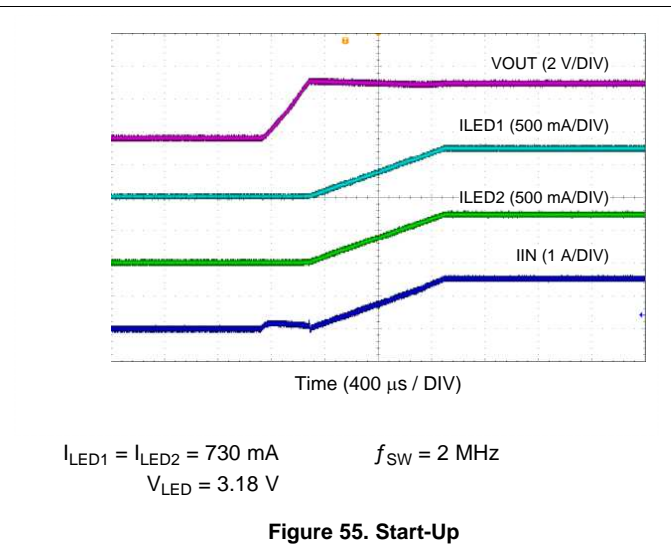
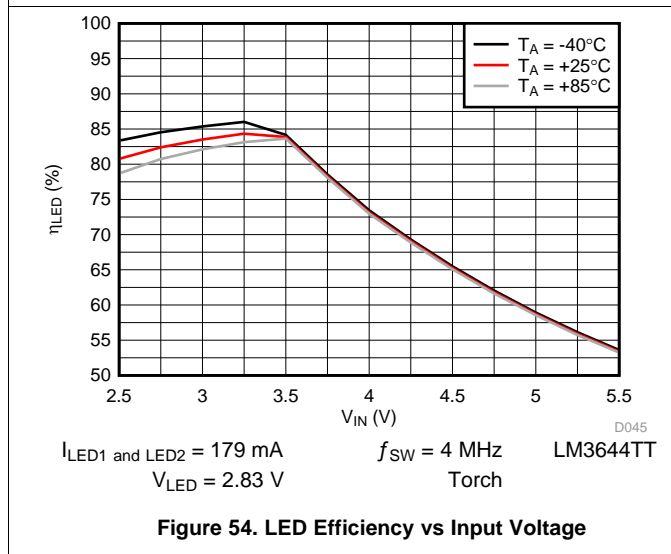
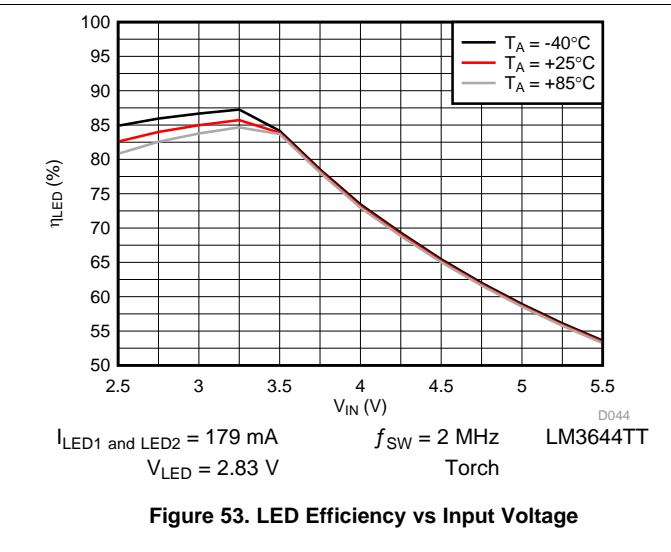
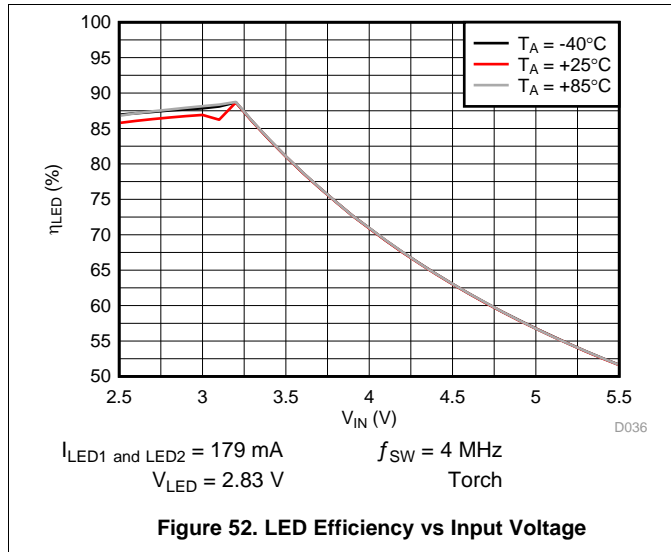
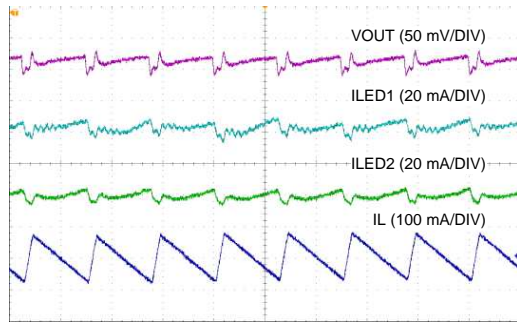

Figure 51. LED Efficiency vs Input Voltage

Ambient temperature is 25°C, input voltage is 3.6 V, $H_{WEN} = V_{IN}$, $C_{IN} = 2 \times 10 \mu F$, $C_{OUT} = 2 \times 10 \mu F$ and $L = 1 \mu H$, unless otherwise noted.



Ambient temperature is 25°C, input voltage is 3.6 V, HWEN = V_{IN}, C_{IN} = 2 × 10 μF, C_{OUT} = 2 × 10 μF and L = 1 μH, unless otherwise noted.



Time (400 ns / DIV)

$I_{LED1} = I_{LED2} = 730 \text{ mA}$ $f_{SW} = 2 \text{ MHz}$
 $V_{LED} = 3.18 \text{ V}$

Figure 58. Ripple @ 2 MHz

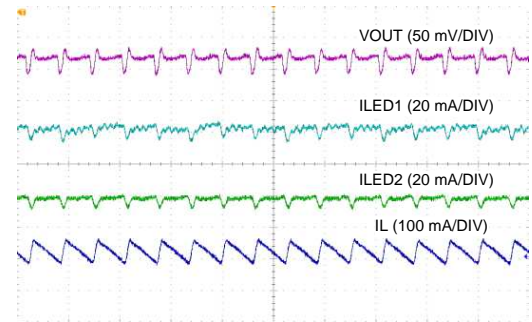

Time (400 ns / DIV)

$I_{LED1} = I_{LED2} = 730 \text{ mA}$ $f_{SW} = 4 \text{ MHz}$
 $V_{LED} = 3.18 \text{ V}$

Figure 59. Ripple @ 4 MHz

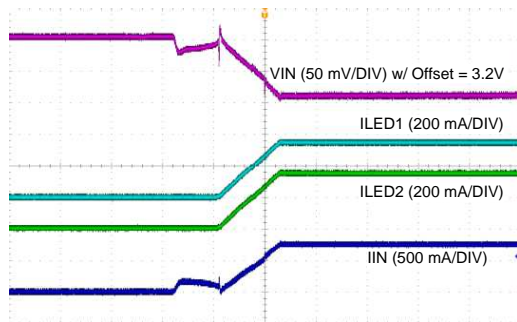

Time (400 μs / DIV)

$I_{LED1} = I_{LED2} = 730 \text{ mA}$ $f_{SW} = 2 \text{ MHz}$
 $V_{LED} = 3.18 \text{ V}$ $V_{IVFM} = 3.2 \text{ V}$

Figure 60. IVFM - Ramp and Hold

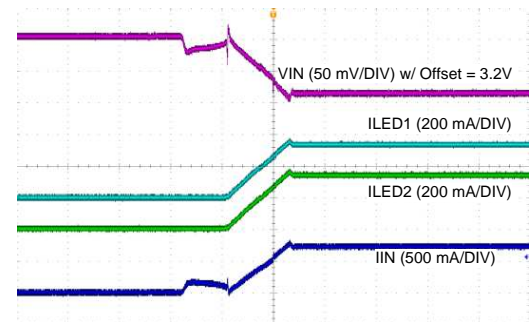

Time (400 μs / DIV)

$I_{LED1} = I_{LED2} = 730 \text{ mA}$ $f_{SW} = 2 \text{ MHz}$
 $V_{LED} = 3.18 \text{ V}$ $V_{IVFM} = 3.2 \text{ V}$

Figure 61. IVFM - Down Adjust Only

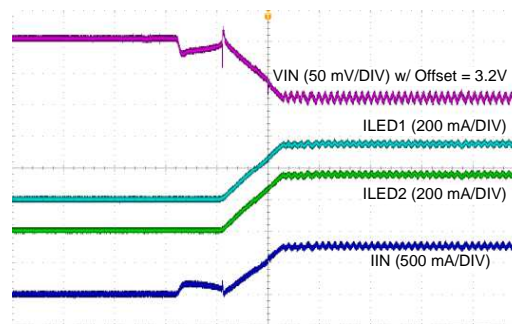

Time (400 μs / DIV)

$I_{LED1} = I_{LED2} = 730 \text{ mA}$ $f_{SW} = 2 \text{ MHz}$
 $V_{LED} = 3.18 \text{ V}$ $V_{IVFM} = 3.2 \text{ V}$

Figure 62. IVFM - Up and Down Adjust

10 Power Supply Recommendations

The LM3644 is designed to operate from an input voltage supply range between 2.5 V and 5.5 V. This input supply must be well regulated and capable to supply the required input current. If the input supply is located far from the LM3644 additional bulk capacitance may be required in addition to the ceramic bypass capacitors.

11 Layout

11.1 Layout Guidelines

The high switching frequency and large switching currents of the LM3644 make the choice of layout important. The following steps should be used as a reference to ensure the device is stable and maintains proper LED current regulation across its intended operating voltage and current range.

1. Place C_{IN} on the top layer (same layer as the LM3644) and as close to the device as possible. The input capacitor conducts the driver currents during the low-side MOSFET turn-on and turn-off and can detect current spikes over 1 A in amplitude. Connecting the input capacitor through short, wide traces to both the IN and GND pins reduces the inductive voltage spikes that occur during switching which can corrupt the V_{IN} line.
2. Place C_{OUT} on the top layer (same layer as the LM3644) and as close as possible to the OUT and GND pin. The returns for both C_{IN} and C_{OUT} should come together at one point, as close to the GND pin as possible. Connecting C_{OUT} through short, wide traces reduce the series inductance on the OUT and GND pins that can corrupt the V_{OUT} and GND lines and cause excessive noise in the device and surrounding circuitry.
3. Connect the inductor on the top layer close to the SW pin. There should be a low-impedance connection from the inductor to SW due to the large DC inductor current, and at the same time the area occupied by the SW node should be small so as to reduce the capacitive coupling of the high dV/dT present at SW that can couple into nearby traces.
4. Avoid routing logic traces near the SW node so as to avoid any capacitively coupled voltages from SW onto any high-impedance logic lines such as TORCH/TEMP, STROBE, HWEN, SDA, and SCL. A good approach is to insert an inner layer GND plane underneath the SW node and between any nearby routed traces. This creates a shield from the electric field generated at SW.
5. Terminate the Flash LED cathodes directly to the GND pin of the LM3644. If possible, route the LED returns with a dedicated path so as to keep the high amplitude LED currents out of the GND plane. For Flash LEDs that are routed relatively far away from the LM3644, a good approach is to sandwich the forward and return current paths over the top of each other on two layers. This helps reduce the inductance of the LED current paths.

11.2 Layout Example

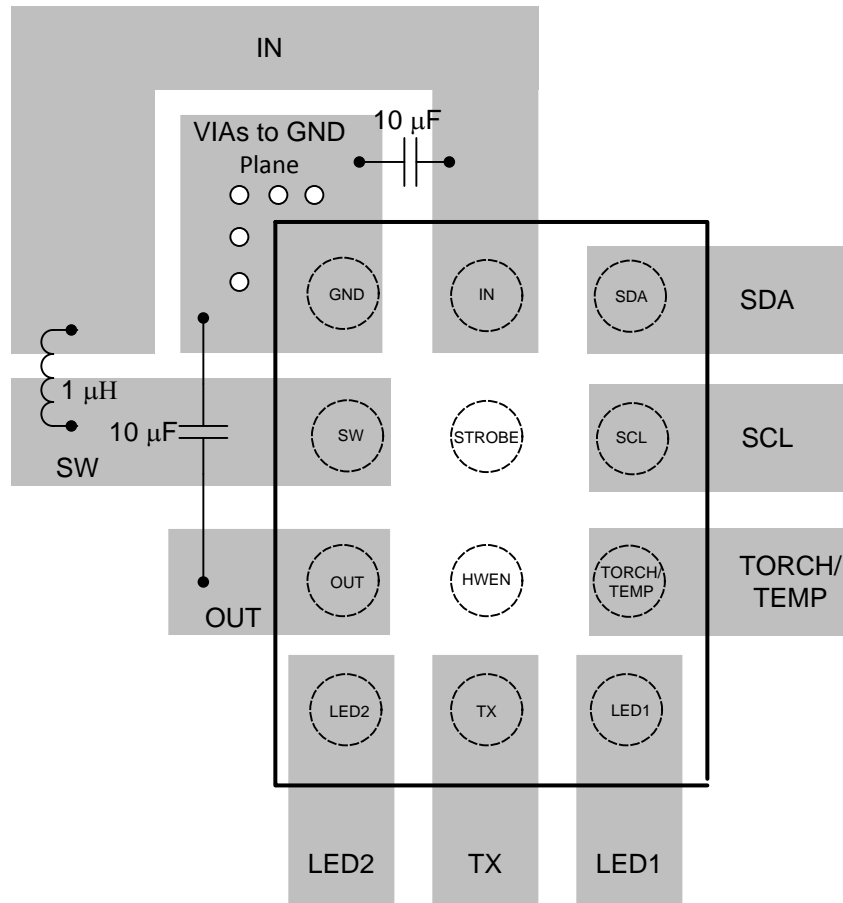

Figure 63. Layout Example

12 Device and Documentation Support

12.1 Device Support

12.1.1 Third-Party Products Disclaimer

TI'S PUBLICATION OF INFORMATION REGARDING THIRD-PARTY PRODUCTS OR SERVICES DOES NOT CONSTITUTE AN ENDORSEMENT REGARDING THE SUITABILITY OF SUCH PRODUCTS OR SERVICES OR A WARRANTY, REPRESENTATION OR ENDORSEMENT OF SUCH PRODUCTS OR SERVICES, EITHER ALONE OR IN COMBINATION WITH ANY TI PRODUCT OR SERVICE.

12.2 Related Documentation

12.2.1 Related Links

below lists quick access links. Categories include technical documents, support and community resources, tools and software, and quick access to sample or buy.

Table 3. Related Links

PARTS	PRODUCT FOLDER	SAMPLE & BUY	TECHNICAL DOCUMENTS	TOOLS & SOFTWARE	SUPPORT & COMMUNITY
LM3644	Click here	Click here	Click here	Click here	Click here
LM3644TT	Click here	Click here	Click here	Click here	Click here

12.2.2 Receiving Notification of Documentation Updates

To receive notification of documentation updates, navigate to the device product folder on ti.com. In the upper right corner, click on *Alert me* to register and receive a weekly digest of any product information that has changed. For change details, review the revision history included in any revised document.

12.2.3 Community Resources

The following links connect to TI community resources. Linked contents are provided "AS IS" by the respective contributors. They do not constitute TI specifications and do not necessarily reflect TI's views; see TI's [Terms of Use](#).

TI E2E™ Online Community *TI's Engineer-to-Engineer (E2E) Community*. Created to foster collaboration among engineers. At e2e.ti.com, you can ask questions, share knowledge, explore ideas and help solve problems with fellow engineers.

Design Support *TI's Design Support* Quickly find helpful E2E forums along with design support tools and contact information for technical support.

12.3 Trademarks

E2E is a trademark of Texas Instruments.

12.4 Electrostatic Discharge Caution



This integrated circuit can be damaged by ESD. Texas Instruments recommends that all integrated circuits be handled with appropriate precautions. Failure to observe proper handling and installation procedures can cause damage.

ESD damage can range from subtle performance degradation to complete device failure. Precision integrated circuits may be more susceptible to damage because very small parametric changes could cause the device not to meet its published specifications.

12.5 Glossary

[SLYZ022](#) — *TI Glossary*.

This glossary lists and explains terms, acronyms, and definitions.

13 Mechanical, Packaging, and Orderable Information

The following pages include mechanical, packaging, and orderable information. This information is the most current data available for the designated devices. This data is subject to change without notice and revision of this document. For browser-based versions of this data sheet, refer to the left-hand navigation.

PACKAGING INFORMATION

Orderable part number	Status (1)	Material type (2)	Package Pins	Package qty Carrier	RoHS (3)	Lead finish/ Ball material (4)	MSL rating/ Peak reflow (5)	Op temp (°C)	Part marking (6)
LM3644TTYFFR	Active	Production	DSBGA (YFF) 12	3000 LARGE T&R	Yes	SNAGCU	Level-1-260C-UNLIM	-40 to 85	3644TT
LM3644TTYFFR.A	Active	Production	DSBGA (YFF) 12	3000 LARGE T&R	Yes	SNAGCU	Level-1-260C-UNLIM	-40 to 85	3644TT
LM3644YFFR	Active	Production	DSBGA (YFF) 12	3000 LARGE T&R	Yes	SNAGCU	Level-1-260C-UNLIM	-40 to 85	3644
LM3644YFFR.A	Active	Production	DSBGA (YFF) 12	3000 LARGE T&R	Yes	SNAGCU	Level-1-260C-UNLIM	-40 to 85	3644

(1) **Status:** For more details on status, see our [product life cycle](#).

(2) **Material type:** When designated, preproduction parts are prototypes/experimental devices, and are not yet approved or released for full production. Testing and final process, including without limitation quality assurance, reliability performance testing, and/or process qualification, may not yet be complete, and this item is subject to further changes or possible discontinuation. If available for ordering, purchases will be subject to an additional waiver at checkout, and are intended for early internal evaluation purposes only. These items are sold without warranties of any kind.

(3) **RoHS values:** Yes, No, RoHS Exempt. See the [TI RoHS Statement](#) for additional information and value definition.

(4) **Lead finish/Ball material:** Parts may have multiple material finish options. Finish options are separated by a vertical ruled line. Lead finish/Ball material values may wrap to two lines if the finish value exceeds the maximum column width.

(5) **MSL rating/Peak reflow:** The moisture sensitivity level ratings and peak solder (reflow) temperatures. In the event that a part has multiple moisture sensitivity ratings, only the lowest level per JEDEC standards is shown. Refer to the shipping label for the actual reflow temperature that will be used to mount the part to the printed circuit board.

(6) **Part marking:** There may be an additional marking, which relates to the logo, the lot trace code information, or the environmental category of the part.

Multiple part markings will be inside parentheses. Only one part marking contained in parentheses and separated by a "~" will appear on a part. If a line is indented then it is a continuation of the previous line and the two combined represent the entire part marking for that device.

Important Information and Disclaimer: The information provided on this page represents TI's knowledge and belief as of the date that it is provided. TI bases its knowledge and belief on information provided by third parties, and makes no representation or warranty as to the accuracy of such information. Efforts are underway to better integrate information from third parties. TI has taken and continues to take reasonable steps to provide representative and accurate information but may not have conducted destructive testing or chemical analysis on incoming materials and chemicals. TI and TI suppliers consider certain information to be proprietary, and thus CAS numbers and other limited information may not be available for release.

In no event shall TI's liability arising out of such information exceed the total purchase price of the TI part(s) at issue in this document sold by TI to Customer on an annual basis.

TAPE AND REEL INFORMATION

QUADRANT ASSIGNMENTS FOR PIN 1 ORIENTATION IN TAPE

*All dimensions are nominal

Device	Package Type	Package Drawing	Pins	SPQ	Reel Diameter (mm)	Reel Width W1 (mm)	A0 (mm)	B0 (mm)	K0 (mm)	P1 (mm)	W (mm)	Pin1 Quadrant
LM3644TTYFFR	DSBGA	YFF	12	3000	180.0	8.4	1.36	1.76	0.77	4.0	8.0	Q1
LM3644YFFR	DSBGA	YFF	12	3000	180.0	8.4	1.36	1.76	0.77	4.0	8.0	Q1

TAPE AND REEL BOX DIMENSIONS

*All dimensions are nominal

Device	Package Type	Package Drawing	Pins	SPQ	Length (mm)	Width (mm)	Height (mm)
LM3644TTYFFR	DSBGA	YFF	12	3000	182.0	182.0	20.0
LM3644YFFR	DSBGA	YFF	12	3000	182.0	182.0	20.0

YFF0012

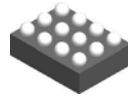

PACKAGE OUTLINE

DSBGA - 0.625 mm max height

DIE SIZE BALL GRID ARRAY

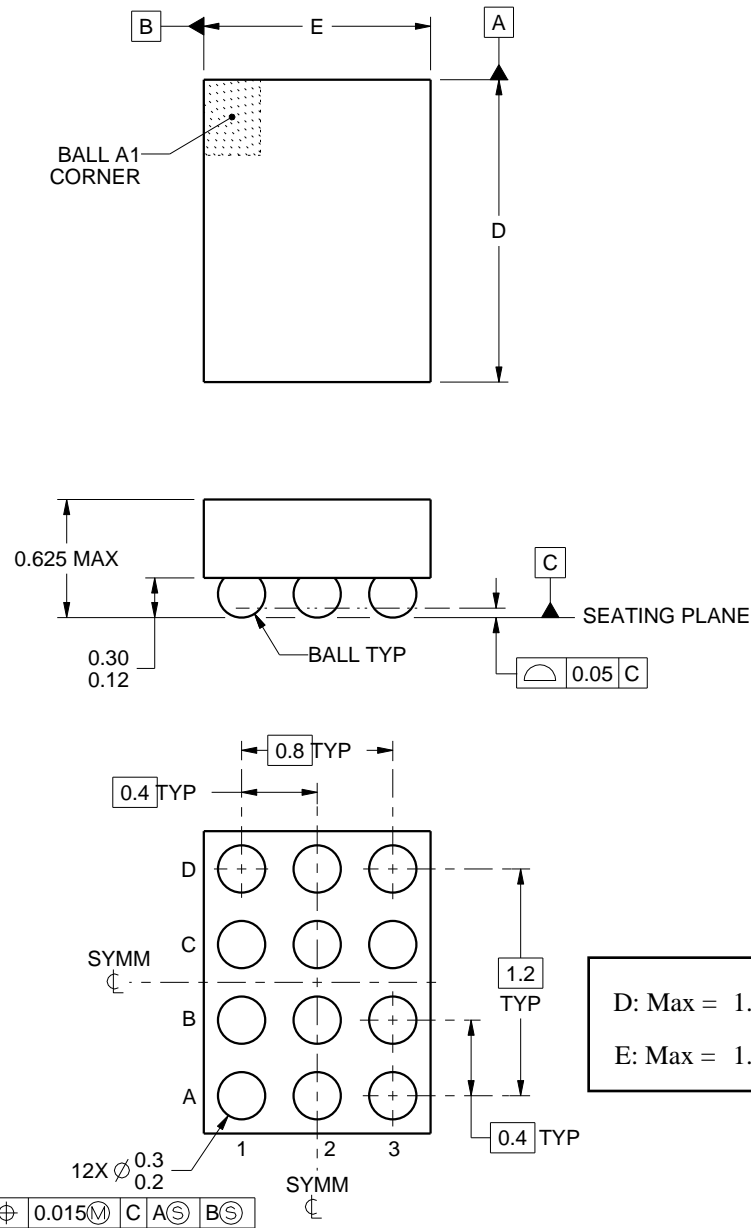

D: Max = 1.69 mm, Min = 1.63 mm
 E: Max = 1.31 mm, Min = 1.25 mm

4222191/A 07/2015

NOTES:

1. All linear dimensions are in millimeters. Any dimensions in parenthesis are for reference only. Dimensioning and tolerancing per ASME Y14.5M.
2. This drawing is subject to change without notice.

EXAMPLE BOARD LAYOUT

YFF0012

DSBGA - 0.625 mm max height

DIE SIZE BALL GRID ARRAY

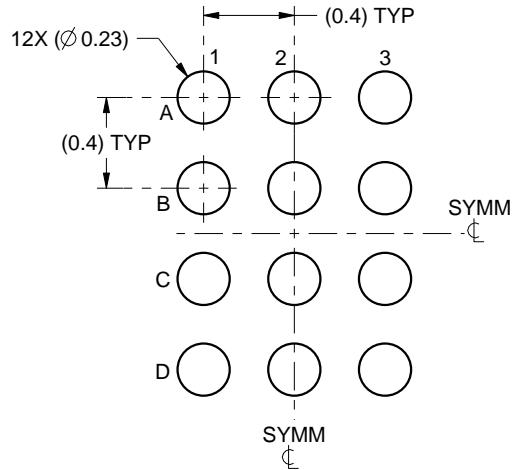

LAND PATTERN EXAMPLE
SCALE:30X

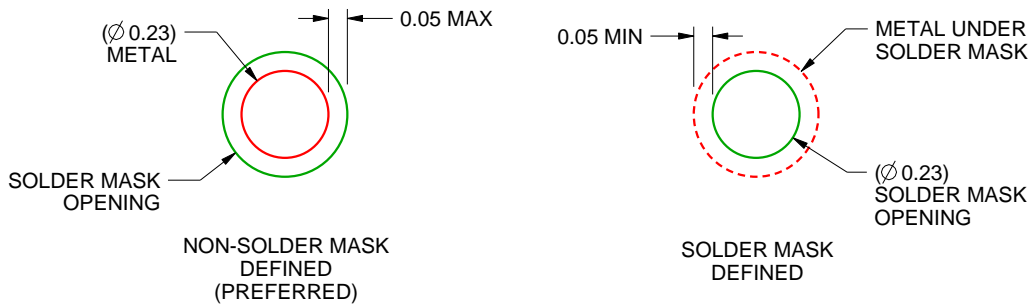

SOLDER MASK DETAILS
NOT TO SCALE

4222191/A 07/2015

NOTES: (continued)

3. Final dimensions may vary due to manufacturing tolerance considerations and also routing constraints. For more information, see Texas Instruments literature number SNVA009 (www.ti.com/lit/snva009).

EXAMPLE STENCIL DESIGN

YFF0012

DSBGA - 0.625 mm max height

DIE SIZE BALL GRID ARRAY

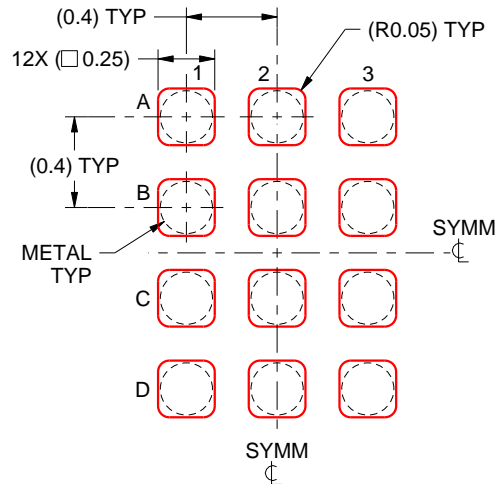

SOLDER PASTE EXAMPLE
BASED ON 0.1 mm THICK STENCIL
SCALE:30X

4222191/A 07/2015

NOTES: (continued)

4. Laser cutting apertures with trapezoidal walls and rounded corners may offer better paste release.

IMPORTANT NOTICE AND DISCLAIMER

TI PROVIDES TECHNICAL AND RELIABILITY DATA (INCLUDING DATASHEETS), DESIGN RESOURCES (INCLUDING REFERENCE DESIGNS), APPLICATION OR OTHER DESIGN ADVICE, WEB TOOLS, SAFETY INFORMATION, AND OTHER RESOURCES "AS IS" AND WITH ALL FAULTS, AND DISCLAIMS ALL WARRANTIES, EXPRESS AND IMPLIED, INCLUDING WITHOUT LIMITATION ANY IMPLIED WARRANTIES OF MERCHANTABILITY, FITNESS FOR A PARTICULAR PURPOSE OR NON-INFRINGEMENT OF THIRD PARTY INTELLECTUAL PROPERTY RIGHTS.

These resources are intended for skilled developers designing with TI products. You are solely responsible for (1) selecting the appropriate TI products for your application, (2) designing, validating and testing your application, and (3) ensuring your application meets applicable standards, and any other safety, security, regulatory or other requirements.

These resources are subject to change without notice. TI grants you permission to use these resources only for development of an application that uses the TI products described in the resource. Other reproduction and display of these resources is prohibited. No license is granted to any other TI intellectual property right or to any third party intellectual property right. TI disclaims responsibility for, and you fully indemnify TI and its representatives against any claims, damages, costs, losses, and liabilities arising out of your use of these resources.

TI's products are provided subject to [TI's Terms of Sale](#), [TI's General Quality Guidelines](#), or other applicable terms available either on ti.com or provided in conjunction with such TI products. TI's provision of these resources does not expand or otherwise alter TI's applicable warranties or warranty disclaimers for TI products. Unless TI explicitly designates a product as custom or customer-specified, TI products are standard, catalog, general purpose devices.

TI objects to and rejects any additional or different terms you may propose.

Copyright © 2025, Texas Instruments Incorporated

Last updated 10/2025