

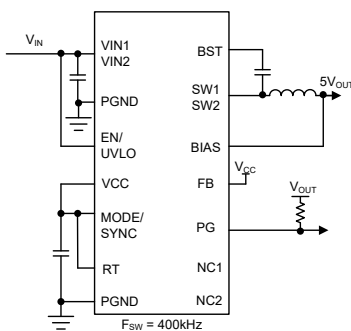
# LM656x5-Q1 High-Performance, 3V to 65V, Pin Compatible, 2.5A, 3.5A, 4.5A, Automotive, Low EMI, Synchronous Buck Converters

## 1 Features

- AEC-Q100 qualified for automotive applications:
  - Temperature grade 1:  $-40^{\circ}\text{C}$  to  $+125^{\circ}\text{C}$ ,  $T_A$
- Wide input voltage range: 3V to 65V (70V transient  $< 100\text{ms}$ )
  - Meets LV148 / ISO21780 requirements
- Designed for low EMI requirements
  - Facilitates CISPR 25 class 5 compliance
  - Mode pin configurable  $\pm 5\%$  or  $\pm 10\%$  dual-random spread spectrum reducing peak emissions
  - Enhanced HotRod™ QFN package with symmetrical pinout
  - Switching frequency from 300kHz to 2.2MHz
  - Pin-configurable AUTO or FPWM operation
  - Internal compensation, current limit, and TSD
- Low minimum on time: 40ns (maximum)
  - Enables  $36V_{IN}$  to  $3.3V_{OUT}$  conversion at 2.2MHz
- High-efficiency power conversion at all loads
  - $> 94\%$  peak efficiency at  $24V_{IN}$ ,  $5V_{OUT}$ , 400kHz
  - $2.5\mu\text{A}$  switching input current at no load
- High power density
  - $3.6\text{mm} \times 2.6\text{mm}$ , wettable flank, 20-pin package
  - Pin compatible with 36V LM654x0-Q1
  - $\Theta_{JA} = 24.0^{\circ}\text{C}/\text{W}$  (LM65645-Q1EVM)
- Create a custom design using the LM656x5-Q1 with the [WEBENCH® Power Designer](#)

## 2 Applications

- [Advanced driver assistance systems \(ADAS\)](#)
- [Automotive infotainment and cluster](#)
- [Hybrid, electric, and powertrain systems](#)



**Simplified Schematic**

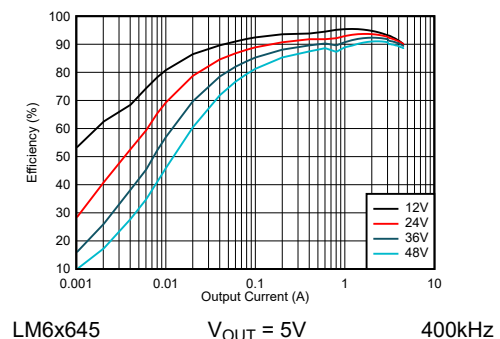
## 3 Description

The LM656x5-Q1 are a family of automotive buck converters designed for high efficiency, high-power density, and ultra-low electromagnetic interference (EMI). The converters operate over a wide input voltage range of 3V to 65V (70V transient  $< 100\text{ms}$ ), reducing the need for external input surge protection. The LM656x5-Q1 comes with pin selectable fixed output voltages of 3.3V and 5V or in adjustable configuration. The low EMI operation is enabled with minimized loop inductance and optimized switch node slew rate. A pin-selectable  $\pm 5\%$  or  $\pm 10\%$  dual-random spread spectrum (DRSS) significantly reduces peak emissions through a combination of triangular and pseudo-random modulation while keeping output voltage ripple very low. The current-mode control architecture with a 30ns typical minimum on-time allows high conversion ratios at high frequencies coupled with a fast transient response and excellent load and line regulation.

### Device Information

PART NUMBER <sup>(3)</sup>	PACKAGE <sup>(1)</sup>	PACKAGE SIZE <sup>(2)</sup>
LM65625-Q1, LM65635-Q1, LM65645-Q1	RZT (WQFN, 20)	2.60mm $\times$ 3.60mm

- (1) For more information, see [Section 11](#).
- (2) The package size (length  $\times$  width) is a nominal value and includes pins, where applicable.
- (3) See the [Device Comparison table](#).



**Figure 3-1. LM6x645 Efficiency - Auto Mode**



## Table of Contents

<b>1 Features</b> .....	1	<b>8 Application and Implementation</b> .....	26
<b>2 Applications</b> .....	1	8.1 Application Information.....	26
<b>3 Description</b> .....	1	8.2 Typical Application.....	27
<b>4 Device Comparison Table</b> .....	3	8.3 Best Design Practices.....	49
<b>5 Pin Configuration and Functions</b> .....	4	8.4 Power Supply Recommendations.....	49
<b>6 Specifications</b> .....	6	8.5 Layout.....	49
6.1 Absolute Maximum Ratings.....	6	<b>9 Device and Documentation Support</b> .....	53
6.2 ESD Ratings.....	6	9.1 Device Support.....	53
6.3 Recommended Operating Conditions.....	6	9.2 Documentation Support.....	53
6.4 Thermal Information.....	7	9.3 Receiving Notification of Documentation Updates....	53
6.5 Electrical Characteristics.....	7	9.4 Support Resources.....	53
6.6 Typical Characteristics.....	10	9.5 Trademarks.....	54
<b>7 Detailed Description</b> .....	12	9.6 Electrostatic Discharge Caution.....	54
7.1 Overview.....	12	9.7 Glossary.....	54
7.2 Functional Block Diagram.....	13	<b>10 Revision History</b> .....	54
7.3 Feature Description.....	14	<b>11 Mechanical, Packaging, and Orderable Information</b> .....	55
7.4 Device Functional Modes.....	21		

## 4 Device Comparison Table

ORDERABLE PART NUMBER	CURRENT
LM65645SRZTRQ1	4.5A
LM65635SRZTRQ1	3.5A
LM65625SRZTRQ1	2.5A

## 5 Pin Configuration and Functions

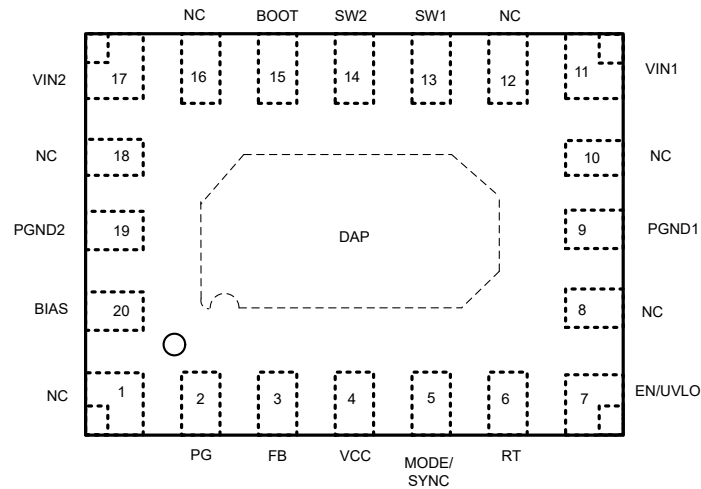


Figure 5-1. 20 Pin RZT, WQFN Package (Top View)

Table 5-1. Pin Functions

PIN		TYPE <sup>(1)</sup>	DESCRIPTION
NAME	NO.		
NC	1	—	No connect pin. Leave floating.
PG	2	O	Power Good flag output. Open drain output that goes low if VOUT is outside of the specified regulation window. Use a 100kΩ pull-up resistor on this pin.
FB	3	A	Feedback configuration pin. Connect to GND to configure 3.3V fixed output voltage. Connect to VCC to configure 5V fixed output voltage. Connect this pin to a feedback divider for adjustable output options. The regulation threshold is 0.8V.
VCC	4	P	Internal LDO output. Used as supply to internal control circuits. Do not connect this pin to any external loads. Can be used for logic pull-up to control or flag pins. Connect a high quality 1μF capacitor from this pin to GND.
MODE / SYNC	5	I/O	Mode and synchronization input pin. Connect to GND, or drive the pin low to operate in AUTO mode. Connect to VCC, or drive the pin high, or send a synchronization clock signal to operate in FPWM mode. When synchronized to an external clock, use the RT pin to set the internal frequency close to the synchronized frequency.
RT	6	I/O	Switching frequency programming pin. Connect this pin to VCC for 400kHz operation, or to GND for 2.2MHz operation. Connect this pin to ground through a resistor to set the switching frequency between 300kHz and 2200kHz. Do not float.
EN / UVLO	7	P	Precision enable pin. High = ON, Low = OFF. This pin can be directly connected to VIN. The precision threshold on this input enables use as an adjustable UVLO. Do not float.
NC	8	—	No connect pin. Leave floating.
PGND1	9	G	Power ground to low-side MOSFET. Connect to system ground. Connect a high-quality bypass capacitor or capacitors between this pin and VIN1.
NC	10	—	No connect pin. Leave floating.
VIN1	11	P	Input supply to the regulator. Connect high-quality bypass capacitors from this pin to PGND1.
NC	12	—	No connect pin. Leave floating.
SW1, SW2	13, 14	P	Device switch pins. Connect to the output inductor.
BOOT	15	P	High-side driver upper supply rail. Connect a high quality 100nF capacitor between the SW node and BOOT. An internal diode charges the capacitor while SW node is low.
NC	16	—	No connect pin. Leave floating.
VIN2	17	P	Input supply to the regulator. Connect high-quality bypass capacitors from this pin to PGND2.
NC	18	—	No connect pin. Leave floating.

**Table 5-1. Pin Functions (continued)**

PIN		TYPE <sup>(1)</sup>	DESCRIPTION
NAME	NO.		
PGND2	19	G	Power ground to internal low-side MOSFET. Connect to system ground. Connect high-quality bypass capacitors between this pin and VIN2.
BIAS	20	P	Input to internal voltage regulator. If configured for fixed VOUT, connect this pin to the VOUT node to close the control loop. If configured for an adjustable VOUT, connect this pin to the VOUT node or an external bias supply from 3.3V to 30V. If output voltage is above 30V and no external supply is used, tie the pin to GND.
DAP	—	G	Exposed ground pad. Connect to system GND on the PCB. This pin is a major heat dissipation path for the die. The pad must be used for heat sinking by soldering to the GND copper on a PCB. Implementing as many thermal vias as suggested in the example board layout makes sure of the lowest package thermal resistance and best possible thermal performance.

(1) I = Input, O = Output, A = Analog, P = Power, G = Ground

## 6 Specifications

### 6.1 Absolute Maximum Ratings

Over the operating junction temperature range  $-40^{\circ}\text{C}$  to  $+150^{\circ}\text{C}$  (unless otherwise noted) <sup>(1)</sup>

		MIN	MAX	UNIT
Input voltage	VIN to PGND	-0.3	72	V
Input voltage	EN/UVLO TO PGND	-0.3	72	V
Input voltage	RT to PGND	-0.3	72	V
Input voltage	BIAS TO PGND	-0.3	40	V
Input voltage	MODE/CLKIN to PGND	-0.3	5.5	V
Input voltage	FB to PGND	-0.3	5.5	V
Output voltage	SW to PGND	-0.6	V <sub>IN</sub>	V
Output voltage	SW to PGND less than 10ns transient	-5.0	V <sub>IN</sub>	V
Output voltage	PGOOD to PGND	-0.3	40	V
Output voltage	BST to SW	-0.3	5.5	V
Output voltage	VCC to PGND	-0.3	5.5	V
Temperature	Operating junction temperature T <sub>J</sub>	-40	150	°C
Temperature	Storage temperature T <sub>stg</sub>	-65	150	°C

- (1) Operation outside the Absolute Maximum Ratings may cause permanent device damage. Absolute Maximum Ratings do not imply functional operation of the device at these or any other conditions beyond those listed under Recommended Operating Conditions. If used outside the Recommended Operating Conditions but within the Absolute Maximum Ratings, the device may not be fully functional, and this may affect device reliability, functionality, performance, and shorten the device lifetime.

### 6.2 ESD Ratings

				VALUE	UNIT
V <sub>(ESD)</sub>	Electrostatic discharge	Charged device model (CDM), per AEC Q100-011	Other Pins	±500	V
V <sub>(ESD)</sub>	Electrostatic discharge	Human body model (HBM), per AEC Q100-002 <sup>(1)</sup>	Human body model (HBM), per AEC Q100-002 <sup>(1)</sup>	±2000	V
		Charged device model (CDM), per AEC Q100-011	Corner Pins (1, 7, 11, 17)	±750	

- (1) AEC Q100-002 indicates that HBM stressing must be in accordance with the ANSI/ESDA/JEDEC JS-001 specification.

### 6.3 Recommended Operating Conditions

Over operating junction temperature range  $-40^{\circ}\text{C}$  to  $+150^{\circ}\text{C}$  (unless otherwise noted)

		MIN	MAX	UNIT
Input voltage	VIN <sup>(1)</sup> transient voltage (<100ms)	3	70	V
Input voltage	VIN (DC)	3	65	V
Input voltage	EN <sup>(1)</sup> transient voltage (<100ms)	0	70	V
Input voltage	EN(DC)	0	65	V
Input voltage	BIAS, PG	0	30	V
Input voltage	FB	0	5.5	V
Input voltage	MODE/SYNC, RT	0	5.5	V
Pullup resistance	R <sub>PU(PG)</sub>	4		kΩ
Pullup reference voltage	V <sub>PU(PGOOD)</sub>	0.8	30	V
Output voltage	VOUT	0.8		V
Output current	LM65645/LM65645-Q1/	0	4.5	A
Output current	LM65635/LM65635-Q1/	0	3.5	A
Output current	LM65625/LM65625-Q1/	0	2.5	A

### 6.3 Recommended Operating Conditions (continued)

Over operating junction temperature range  $-40^{\circ}\text{C}$  to  $+150^{\circ}\text{C}$  (unless otherwise noted)

		MIN	MAX	UNIT
Temperature	Operating junction temperature $T_J$	-40	150	$^{\circ}\text{C}$

- (1) Operation at the maximum transient voltage is limited to less than 1% of the device operating lifetime.

### 6.4 Thermal Information

THERMAL METRIC <sup>(1)</sup>		DEVICE	UNIT
		RZT (WQFN)	
		20 PINS	
$R_{\theta JA}$	Junction-to-ambient thermal resistance <sup>(3)</sup>	24.0	$^{\circ}\text{C}/\text{W}$
$R_{\theta JA}$	Junction-to-ambient thermal resistance (JEDEC 51-7) <sup>(2)</sup>	43.4	$^{\circ}\text{C}/\text{W}$
$R_{\theta JC(top)}$	Junction-to-case (top) thermal resistance	14.9	$^{\circ}\text{C}/\text{W}$
$R_{\theta JB}$	Junction-to-board thermal resistance	12.0	$^{\circ}\text{C}/\text{W}$
$\Psi_{JT}$	Junction-to-top characterization parameter	1.0	$^{\circ}\text{C}/\text{W}$
$\Psi_{JB}$	Junction-to-board characterization parameter	11.9	$^{\circ}\text{C}/\text{W}$
$R_{\theta JC(bot)}$	Junction-to-case (bottom) thermal resistance	6.0	$^{\circ}\text{C}/\text{W}$

- (1) For more information about traditional and new thermal metrics, see the [Semiconductor and IC Package Thermal Metrics](#) application note.
- (2) The value of  $R_{\theta JA}$  given in this table is only valid for comparison with other packages and can not be used for design purposes. These values were calculated in accordance with JEDEC 51-7, and simulated on a 4-layer JEDEC board. The thermal parameters do not represent the performance obtained in an actual application. For example, the EVM  $R_{\theta JA} = 24.0^{\circ}\text{C}/\text{W}$ . For design information please see the Maximum Ambient Temperature section.
- (3) Refer to the LM65645EVM user's guide for board layout and additional information. For thermal design information please see the Maximum Ambient Temperature section.

### 6.5 Electrical Characteristics

Limits apply over the recommended operating junction temperature ( $T_J$ ) range of  $-40^{\circ}\text{C}$  to  $+150^{\circ}\text{C}$ , unless otherwise stated. Minimum and Maximum limits are specified through test, design or statistical correlation. Typical values represent the most likely parametric norm at  $T_J = 25^{\circ}\text{C}$ , and are provided for reference purposes only. Unless otherwise stated, the following conditions apply:  $V_{IN} = 13.5\text{V}$ ,  $V_{EN} = V_{IN}$ ,  $V_{OUT} = 3.3\text{V}$ ,  $f_{SW} = 2.2\text{MHz}$

PARAMETER		TEST CONDITIONS	MIN	TYP	MAX	UNIT
<b>SUPPLY (VIN PIN)</b>						
$V_{INUVLO\_R}$	VIN UVLO rising threshold	$V_{IN}$ rising (needed to start up), $I_{VCC} = 0\text{A}$	3.25	3.5	3.65	V
$V_{INUVLO\_F}$	VIN UVLO falling threshold	$V_{IN}$ falling (once operating), $I_{VCC} = 0\text{A}$		2.5	2.6	V
$V_{INUVLO\_H}$	VIN UVLO hysteresis			0.9		V
$I_{Q\_SD}$	VIN shutdown supply current	$V_{EN} = 0\text{V}$ , $T_J = 25^{\circ}\text{C}$			0.85	$\mu\text{A}$
$I_{VIN}$	VIN pin input current, no switching	$V_{BIAS} = 3.3\text{V} + 2\%$		0.83		$\mu\text{A}$
$I_{BIAS(FIX-3.3V)}$	BIAS pin input current, fixed 3.3V output, no switching	$V_{BIAS} = 3.3\text{V} + 2\%$ , Auto Mode enabled		8.0		$\mu\text{A}$
$I_{Q(FIX-3.3V)}$	Total $V_{IN}$ quiescent current, fixed 3.3V output, no switching	$V_{IN} = 24\text{V}$ , $V_{BIAS} = 3.3\text{V} + 2\%$ , $T_J = 25^{\circ}\text{C}$ , Auto Mode enabled		2.1	2.5	$\mu\text{A}$
		$T_J = 125^{\circ}\text{C}$			3.4	$\mu\text{A}$
$I_{BIAS(ADJ-3.3V)}$	BIAS pin input current, adjustable 3.3V output, no switching	$V_{FB} = 0.8\text{V} + 2\%$ , Auto Mode		6.5		$\mu\text{A}$
$I_{Q(ADJ-3.3V)}$	Total $V_{IN}$ quiescent current, adjustable 3.3V output, no switching	$V_{IN} = 24.0\text{V}$ , $V_{FB} = 0.8\text{V} + 2\%$ , Auto Mode		2.5		$\mu\text{A}$
<b>ENABLE (EN PIN)</b>						
$V_{EN\_TH\_R}$	Enable voltage rising threshold	$V_{EN}$ rising	1.15	1.25	1.35	V
$V_{EN\_TH\_F}$	Enable input low threshold	$V_{EN}$ falling	0.9	1	1.1	V
$V_{EN\_HYS}$	Enable voltage hysteresis			250		mV
$I_{EN\_LKG}$	Enable input leakage current	$V_{EN} = V_{IN}$		0.2	1.0	$\mu\text{A}$
<b>INTERNAL LDO (VCC PIN)</b>						

## 6.5 Electrical Characteristics (continued)

Limits apply over the recommended operating junction temperature ( $T_J$ ) range of  $-40^{\circ}\text{C}$  to  $+150^{\circ}\text{C}$ , unless otherwise stated. Minimum and Maximum limits are specified through test, design or statistical correlation. Typical values represent the most likely parametric norm at  $T_J = 25^{\circ}\text{C}$ , and are provided for reference purposes only. Unless otherwise stated, the following conditions apply:  $V_{IN} = 13.5\text{V}$ ,  $V_{EN} = V_{IN}$ ,  $V_{OUT} = 3.3\text{V}$ ,  $f_{SW} = 2.2\text{MHz}$

PARAMETER		TEST CONDITIONS	MIN	TYP	MAX	UNIT
$V_{VCC}$	Internal LDO output voltage	$3.4\text{V} \leq V_{IN} \leq 65\text{V}$ , $V_{BIAS} = 0\text{V}$		3.35		V
		$3.4\text{V} \leq V_{BIAS} \leq 30\text{V}$		3.35		V
$V_{VCC-UVLO\_R}$	VCC UVLO rising threshold	VCC rising under voltage threshold, $I_{VCC} = 0\text{A}$	3.20	3.5	3.65	V
$V_{VCC-UVLO\_H}$	VCC UVLO hysteresis	Hysteresis below $V_{VCC-UVLO\_R}$		0.9		V
<b>VOLTAGE REFERENCE (FB PIN)</b>						
$V_{FB}$	Internal feedback reference voltage	FPWM Mode	0.792	0.8	0.808	V
$I_{FB-LKG}$	Feedback pin input leakage current	$V_{FB} = 0.8\text{V}$ , adjustable version		0.025		nA
$R_{FB-SEL-5V}$	Resistance for fixed 5.0V setting from FB pin to VCC				200	$\Omega$
$R_{FB-SEL-3V}$	Resistance for fixed 3.3V setting from FB pin to GND				200	$\Omega$
$R_{FB-SEL-ADJ}$	Thevenin equivalent resistance of external FB divider on FB pin to select adjustable output voltage setting		4		100	k $\Omega$
<b>FIXED OUTPUT VOLTAGE (BIAS PIN)</b>						
$V_{OUT(3.3V)}$	3.3V fixed output voltage	FB shorted to GND	3.267	3.3	3.333	V
$V_{OUT(5V)}$	5.0V fixed output voltage	FB shorted to VCC	4.95	5	5.05	V
<b>STARTUP (SS PIN)</b>						
$t_{EN\_HIGH}$	Enable HIGH to start of switching delay	$V_{FB} = V_{RT} = V_{MODE} = \text{GND}$ , $V_{BIAS} = V_{OUT}$		3.0		ms
$t_{SS}$	Internal fixed soft-start time	Time from first SW pulse to $V_{REF}$ at 90% of set point	2.9	5.3	8.1	ms
<b>CURRENT LIMITS AND HICCUP</b>						
$I_{HS-LIM}$	High side peak current limit, 4.5A trim option	Duty cycle approaches 0%.	5.4	6.6	7.25	A
$I_{LS-LIM}$	Low side valley current limit, 4.5A trim option	Valley current limit on low-side FET	4.1	5.2	5.65	A
$I_{L-PEAK-MIN}$	Minimum peak inductor current at minimum duty cycle, 4.5A trim option	$V_{VCC} = 3.3\text{V}$ , $t_{pulse} \leq 100\text{ns}$ , auto mode	1.21	1.57	1.92	A
$I_{L-PEAK-MAX}$	Minimum peak inductor current at maximum duty cycle, 4.5A Trim Option	$V_{VCC} = 3.3\text{V}$ , $t_{pulse} \geq 1\mu\text{s}$ , auto mode		0.66		A
$I_{HS-LIM}$	High side peak current limit, 3.5A trim option	Duty-cycle approaches 0%.	4.8	5.45	5.9	A
$I_{LS-LIM}$	Low side valley current limit, 3.5A trim option	Valley current limit on low-side FET	3.5	4.4	4.85	A
$I_{L-PEAK-MIN}$	Minimum peak inductor current at minimum duty cycle, 3.5A trim option	$V_{VCC} = 3.3\text{V}$ , $t_{pulse} \leq 100\text{ns}$ , auto mode	0.80	1.29	1.58	A
$I_{L-PEAK-MAX}$	Minimum peak inductor current at maximum duty cycle, 3.5A trim option	$V_{VCC} = 3.3\text{V}$ , $t_{pulse} \geq 1\mu\text{s}$ , auto mode		0.52		A
$I_{HS-LIM}$	High side peak current limit, 2.5A trim option	Duty-cycle approaches 0%.	3.75	4.1	4.9	A
$I_{LS-LIM}$	Low side valley current limit, 2.5A trim option	Valley current limit on low-side FET	2.4	3.0	3.4	A
$I_{L-PEAK-MIN}$	Minimum peak inductor current at minimum duty cycle, 2.5A trim option	$V_{VCC} = 3.3\text{V}$ , $t_{pulse} \leq 100\text{ns}$ , auto mode	0.8	1.1	1.35	A
$I_{L-PEAK-MAX}$	Minimum peak inductor current at maximum duty cycle, 2.5A trim option	$V_{VCC} = 3.3\text{V}$ , $t_{pulse} \geq 1\mu\text{s}$ , auto mode		0.43		A
$I_{LS-NEG-LIM}$	Low side negative current limit, All current limit trim options	Sinking current limit on LS FET, FPWM mode	-6	-4.3	-2.8	A
$I_{L-ZC-LIM}$	Zero-cross current limit	$V_{VCC} = 3.3\text{V}$ , auto mode		45		mA
$V_{HIC}$	Overcurrent hiccup threshold on FB pin	LS FET on-time > 165ns, not during soft start		0.32		V
$t_{HIC\_DLY}$	Hiccup mode activation delay			64		cycles
$t_{HIC}$	Hiccup mode duration time			45		ms



## 6.5 Electrical Characteristics (continued)

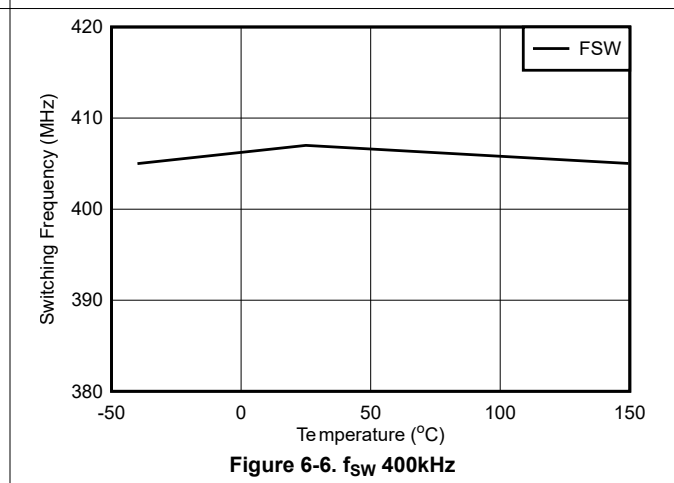
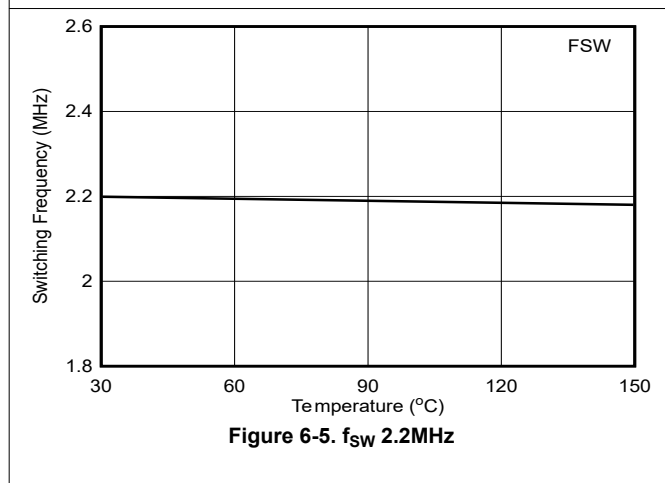
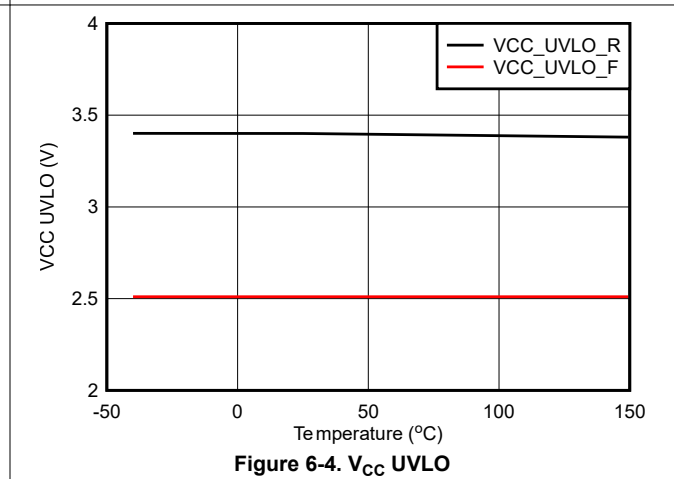
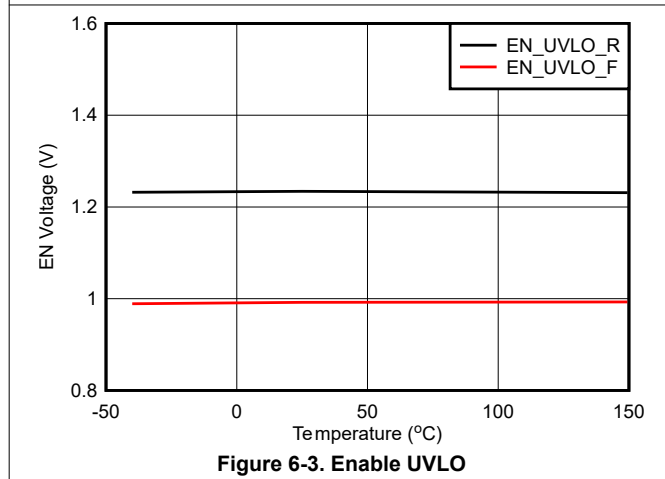
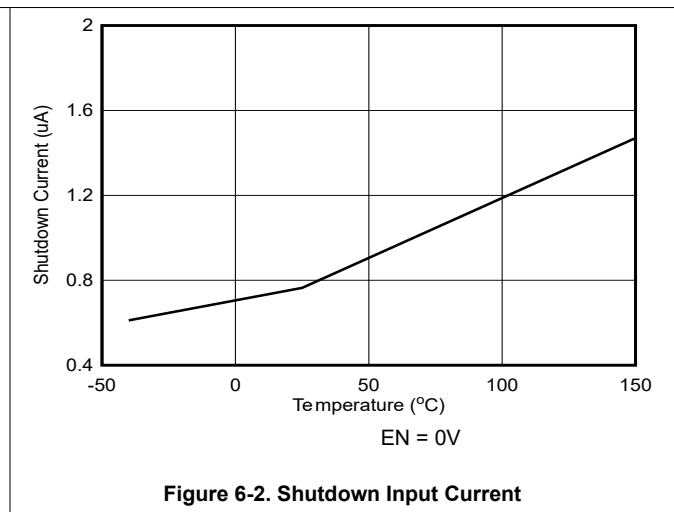
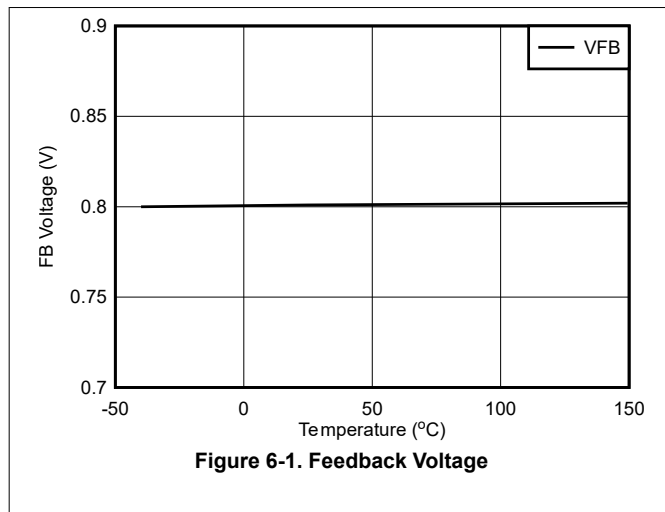
Limits apply over the recommended operating junction temperature ( $T_J$ ) range of  $-40^{\circ}\text{C}$  to  $+150^{\circ}\text{C}$ , unless otherwise stated. Minimum and Maximum limits are specified through test, design or statistical correlation. Typical values represent the most likely parametric norm at  $T_J = 25^{\circ}\text{C}$ , and are provided for reference purposes only. Unless otherwise stated, the following conditions apply:  $V_{IN} = 13.5\text{V}$ ,  $V_{EN} = V_{IN}$ ,  $V_{OUT} = 3.3\text{V}$ ,  $f_{SW} = 2.2\text{MHz}$

PARAMETER		TEST CONDITIONS	MIN	TYP	MAX	UNIT
<b>POWER GOOD (PG PIN)</b>						
$V_{PG-OVP-R}$	PG overvoltage rising threshold	% of FB voltage (Adj) or bias voltage (fixed)	103	105	107	%
$V_{PG-OVP-F}$	PG overvoltage falling threshold	% of FB voltage (Adj) or bias voltage (fixed)	101	104	106	%
$V_{PG-UVF-R}$	PG undervoltage rising threshold	% of FB voltage (Adj) or bias voltage (fixed)	94	96	98	%
$V_{PG-UVF-F}$	PG undervoltage falling threshold	% of FB voltage (Adj) or bias voltage (fixed)	93	95	97	%
$t_{PG-DEGLITCH-F}$	Deglintch filter delay on PG falling edge		55	120	175	$\mu\text{s}$
$t_{PG-DEGLITCH-R}$	Deglintch filter delay on PG rising edge		1.4	2	4.5	ms
$V_{IN-PG-VALID}$	Minimum $V_{IN}$ for valid PG output	$V_{OL(PG)} < 0.4\text{V}$ , $R_{PU} = 50\text{k}\Omega$ , $V_{PU} = 5\text{V}$			1.25	V
$V_{OL-PG}$	Output low voltage	$I_{OL} = 1\text{mA}$ , $V_{IN} = 1.2\text{V}$			0.4	V
$R_{ON-PG}$	PGOOD ON resistance	$I_{PG} = 1\text{mA}$		40	125	$\Omega$
<b>SWITCHING FREQUENCY (RT PIN)</b>						
$f_{SW1(FPWM)}$	Switching frequency, FPWM operation	$R_{RT} = \text{GND}$	1.98	2.2	2.42	MHz
$f_{SW2(FPWM)}$	Switching frequency, FPWM operation	$R_{RT} = 15.8\text{k}\Omega$ , 1%	900	1000	1100	kHz
$f_{SW3(FPWM)}$	Switching frequency, FPWM operation	$R_{RT} = \text{VCC}$	360	400	440	kHz
<b>SYNCHRONIZATION (MODE/SYNC PIN)</b>						
$V_{IH(MODE/CLKIN)}$	MODE/CLKIN input high level threshold				1.3	V
$V_{IL(MODE/CLKIN)}$	MODE/CLKIN input low level threshold		0.45			V
$f_{CLKIN-RANGE(FPWM)}$	Synchronization frequency range for set $2.2\text{MHz } f_{SW}$	$R_{RT} = 6.81\text{k}\Omega$ , 1%	1.76		2.64	MHz
$t_{CLKIN(TON)}$	Minimum positive pulse width of external sync signal				80	ns
$t_{CLKIN(TOFF)}$	Minimum negative pulse width of external sync signal				80	ns
$t_{CLKIN-SW-DLY}$	CLKIN to SW delay time <sup>(1)</sup>		-15		15	ns
<b>DUAL RANDOM SPREAD SPECTRUM</b>						
$\Delta f_{SS1-LF}$	Low-frequency triangular spread spectrum modulation range - standard	Mode pin short to ground		8.5		%
$\Delta f_{SS2-LF}$	Low-frequency triangular spread spectrum modulation range - extended	$R_{MODE} = 149.9\text{k}\Omega$ , 1%		17		%
$f_{m1-LF}$	Triangular modulation frequency - standard	Mode pin short to ground	7.2	12	16.8	kHz
$f_{m2-LF}$	Triangular modulation frequency - extended	$R_{MODE} = 149.9\text{k}\Omega$ , 1%	3.6	6	8.4	kHz
$\Delta f_{SS-HF}$	High-frequency pseudo-random spread spectrum modulation range	$R_{MODE} = 149.9\text{k}\Omega$ , 1%		2.0		%
<b>POWER STAGE</b>						
$R_{DS-ON-HS}$	High-side FET ON resistance	$I_{SW} = 500\text{mA}$ , $V_{BOOT-SW} = 3.3\text{V}$		99		m $\Omega$
$R_{DS-ON-LS}$	Low-side FET ON resistance			50		m $\Omega$
$t_{ON-MIN(FPWM)}$	Minimum on time <sup>(1)</sup>	FPWM: $I_{OUT} = 0\text{A}$ , $V_{IN} = 36\text{V}$ , $RT = \text{GND}$		30	40	ns
$t_{ON-MIN(AUTO)}$	Minimum on time <sup>(1)</sup>	AUTO: $I_{OUT} = 2\text{A}$ , $V_{IN} = 36\text{V}$ , $RT = \text{GND}$		28	40	ns
$t_{OFF-MIN}$	Minimum off-time	$V_{IN} = 4\text{V}$		80	110	ns
$t_{ON-MAX}$	Maximum on-time	$f_{SW} = 400\text{kHz}$ , $R_{RT} = 40.2\text{k}\Omega$		13.3		$\mu\text{s}$
<b>THERMAL SHUTDOWN</b>						
$T_{SD}$	Thermal shutdown <sup>(1)</sup>	Shutdown threshold	155	165	177	$^{\circ}\text{C}$
		Recovery threshold		156		$^{\circ}\text{C}$

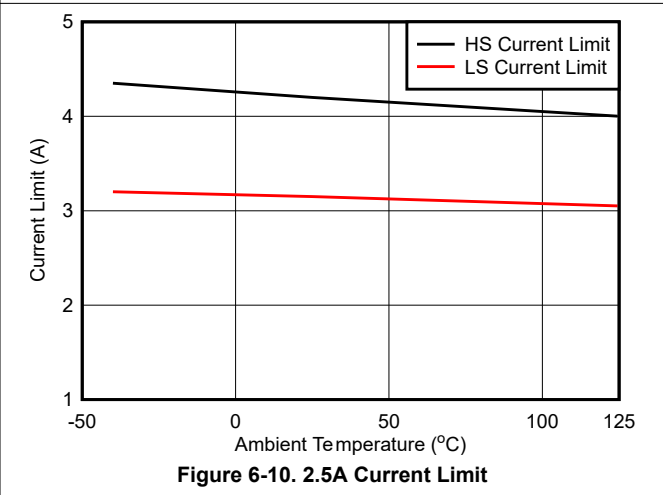
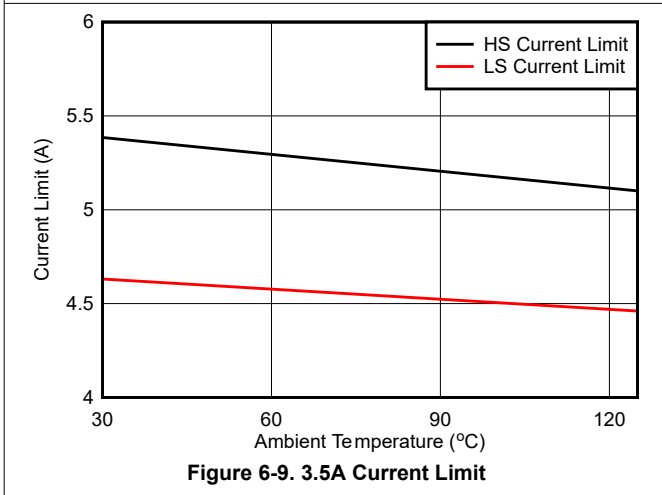
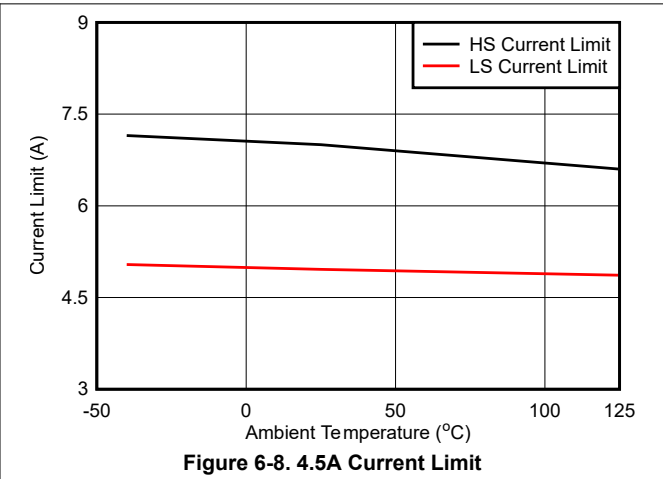
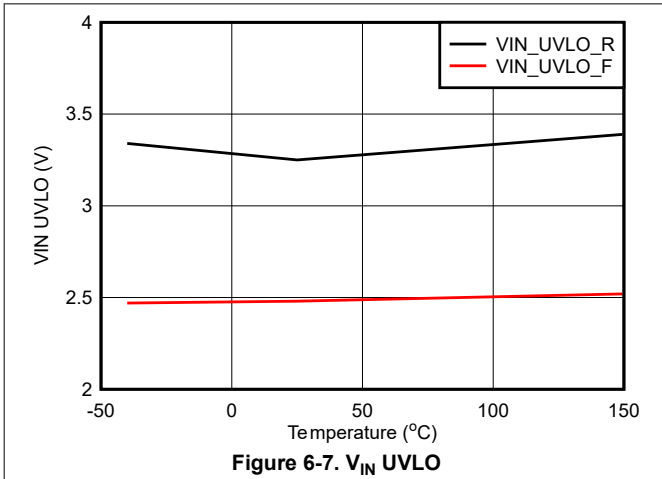
(1) Specified by design.

## 6.6 Typical Characteristics

Unless otherwise specified,  $V_{IN} = 13.5V$ .



### 6.6 Typical Characteristics (continued)



## 7 Detailed Description

### 7.1 Overview

The LM656x5-Q1 is a family of high-efficiency, high-power density, ultra-low EMI buck converters. These converters operate over a wide input voltage range of 3V to 65V (70V <100ms) with pin selectable fixed output voltages of 3.3V, 5V, or as in adjustable output configuration.

The current-mode control architecture, with 30ns typical minimum on-time, allows high conversion ratios at high frequencies, fast transient response, and excellent load and line regulation. If the minimum on-time or minimum off-time does not support the desired conversion ratio, the switching frequency is automatically reduced. This feature allows regulation to be maintained during load dump events and cold cranking situations.

This device is designed to minimize end-product cost and size while operating in demanding automotive and high-performance industrial environments. The LM656x5-Q1 can be set to operate at fixed 400kHz, fixed 2.2MHz, or in adjustable mode from 300kHz to 2.2MHz by using the RT pin. An integrated compensation network combined with an accurate current limit scheme minimizes bill of material cost and component count.

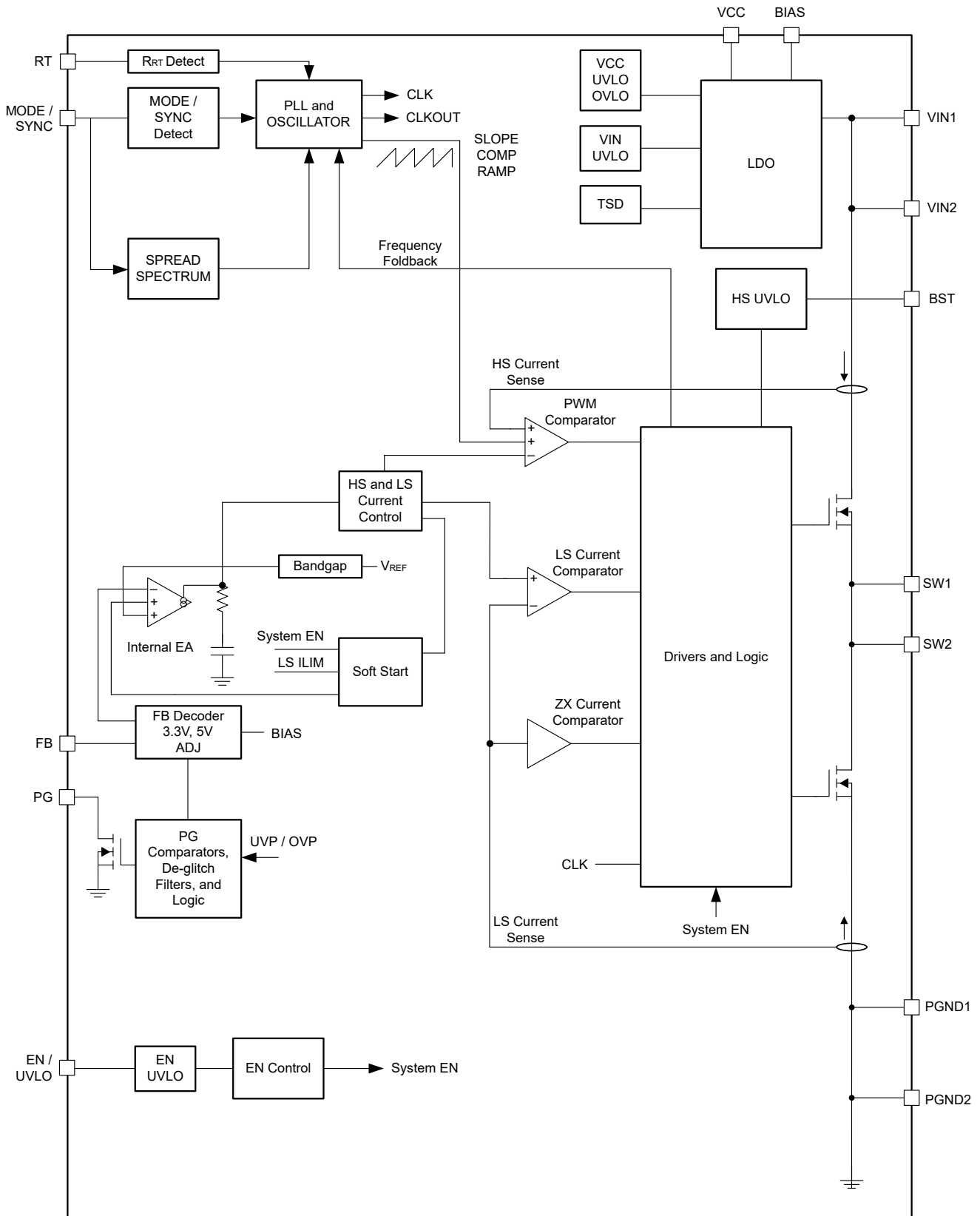
The LM656x5-Q1 has been designed for low EMI. The device includes the following:

- Mode pin-configurable  $\pm 5\%$  or  $\pm 10\%$  dual random spread spectrum (DRSS) frequency hopping
- Symmetrical pin out minimizing parasitic package inductance
- Operation over a frequency range above and below AM radio band
- Pin-configurable for AUTO or FPWM mode along with external clock synchronization capabilities

These features can eliminate shielding and other expensive EMI mitigation measures.

To use the device in reliability-conscious environments, the LM656x5-Q1 has a package with enlarged corner terminals for improved board level reliability and wettable flanks, allowing optical inspection.

## 7.2 Functional Block Diagram



## 7.3 Feature Description

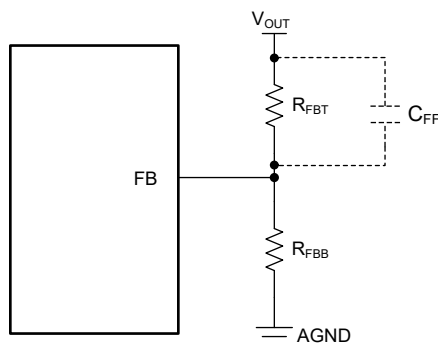
### 7.3.1 Output Voltage Selection

The LM656x5-Q1 features pin-selectable fixed output voltage or adjustable output voltage mode. In fixed output voltage mode, the output voltage is selected by the FB pin. Connect the FB pin to GND to select the fixed 3.3V output, or connect to VCC for a fixed 5V output. When the fixed output voltage mode is selected, the BIAS pin is connected directly to the output of the regulator. In this mode, the BIAS pin closes the feedback loop of the regulator and provides input power to the internal bias regulator. Because of the internal LDO is supplied through this pin, a reliable bode plot cannot be taken in fixed output voltage mode however this measurement can be taken in adjustable mode. Connect BIAS to VOUT as shown in [Figure 8-2](#).

**Table 7-1. Output Voltage Selection**

FB	VOUT
Short to GND	3.3V
Short to VCC	5V
Connect to a feedback resistor divider ( <a href="#">Figure 7-1</a> )	ADJ

In the adjustable output voltage mode, a voltage divider is connected between the regulator output voltage and the FB pin. The resistor values are calculated based on the desired output voltage and the 0.8V reference of the regulator. See [Figure 7-1](#) for detailed connections.



**Figure 7-1. Setting Output Voltage of Adjustable Versions**

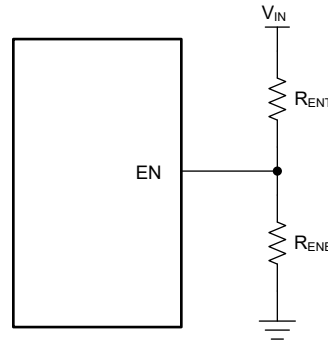
Use [Equation 1](#) to select a value for  $R_{FBB}$ , based on a desired value of  $R_{FBT}$ . Limiting the value of  $R_{FBT}$  to 100k $\Omega$  or less is best practice. Larger values of resistance are susceptible to leakage currents on the PCB, caused by environmental contamination, that can shift the desired output voltage. Values up to about 1M $\Omega$  can be used to reduce the no-load supply current, in those cases where excessive PCB leakage currents are not present.

$$R_{FBB} = R_{FBT} \times \frac{0.8}{V_{OUT} - 0.8} \quad (1)$$

In some cases, when using the adjustable mode, a feed forward capacitor can be used to improve the loop phase margin or load transient response. The exact value of  $C_{FF}$  is best selected empirically during the initial bench evaluation of the design. Leave a placeholder for this capacitor in the PCB layout if needed at some stage during development.

### 7.3.2 EN Pin and Use as $V_{IN}$ UVLO

Start-up and shutdown are controlled by the EN input. This input features precision thresholds, allowing the use of an external voltage divider to provide an adjustable input Undervoltage Lockout (UVLO), if desired. Applying a voltage greater than  $V_{EN\_TH\_R}$  fully enables the device, allowing the device to enter start-up mode and begin the soft-start period. When the EN input is brought below  $V_{EN\_TH\_F}$ , the regulator stops switching and enters shutdown mode, with a  $V_{IN}$  input current of less than 0.85 $\mu$ A (maximum). The EN input can be connected directly to  $V_{IN}$  if this feature is not needed. The enable must not float, as floating the enable pin turns the device off. The values for the various EN thresholds can be found in the *Electrical Characteristics* table.



**Figure 7-2. VIN UVLO Using the EN Pin**

In some cases, an input UVLO level different than that provided internal to the device is needed. This feature can be used for special sequencing or to prevent input voltage oscillations caused by excessively long power cables. External UVLO can be accomplished by using the circuit shown in Figure 7-2. The input voltage at which the device turns on is designated as  $V_{ON}$  while the turnoff voltage is  $V_{OFF}$ . The current in the divider must be greater than the current into the EN input ( $I_{EN\_LKG}$ ), to preserve accuracy. Values for  $R_{ENB}$  between 10k $\Omega$  and 50k $\Omega$  are reasonable. Then, Equation 2 is used to calculate  $R_{ENT}$  and Equation 3 is used to calculate  $V_{OFF}$ .

$$R_{ENT} = R_{ENB} \times \left( \frac{V_{ON}}{V_{EN\_TH\_R}} - 1 \right) \quad (2)$$

$$V_{OFF} = V_{ON} \times \left( \frac{V_{EN\_TH\_F}}{V_{EN\_TH\_R}} \right) \quad (3)$$

where

- $V_{ON} = V_{IN}$  turn-on voltage
- $V_{OFF} = V_{IN}$  turn-off voltage

### 7.3.3 Mode Selection

The MODE / SYNC pin is a multifunction pin that configures the mode of operation, and serves as an input for an external synchronization signal. If the pin is grounded or driven to logic low, the converter operates in AUTO mode. If the pin is tied to VCC or driven to logic high, or synchronized to an external clock source, the converter operates in FPWM mode.

**Table 7-2. Mode Selection**

MODE/SYNC	MODE	DYNAMIC MODE CHANGE	SPREAD SPECTRUM
Short to GND or driven low	AUTO	Enabled	Standard $\pm 5\%$ DRSS
49.9k $\Omega$ to GND	FPWM	Disabled	Wide $\pm 10\%$ DRSS
149.9k $\Omega$ to GND	AUTO	Disabled	Wide $\pm 10\%$ DRSS
Short to VCC or driven high	FPWM	Enabled	Standard $\pm 5\%$ DRSS
Synchronizing signal	FPWM	Enabled	Disabled

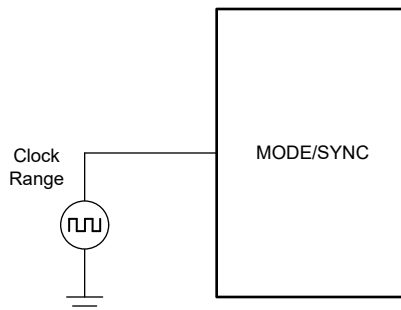
Transitioning the device from AUTO to FPWM mode requires driving the pin from low to high or sending a synchronization signal. Transitioning the device from FPWM to AUTO mode requires driving the pin from high to low or stop sending the synchronization signal. Note that a short to ground or a pullup to VCC requires < 200 $\Omega$  resistor.

#### 7.3.3.1 MODE/SYNC Pin Uses for Synchronization

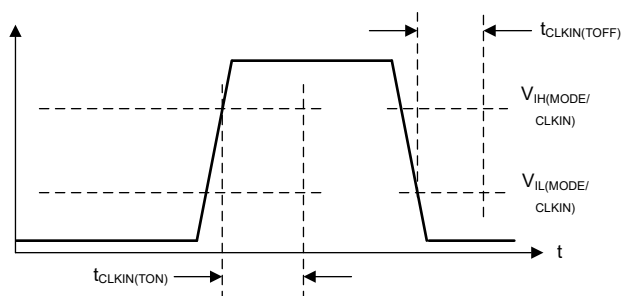
The LM656x5-Q1 MODE/SYNC pin can be used to synchronize the internal oscillator to an external clock. The internal oscillator can be synchronized by coupling a positive edge into the pin. The coupled edge voltage at the pin must exceed the SYNC amplitude threshold of  $V_{IH(MODE/CLKIN)}$  to trip the internal synchronization pulse detector. The minimum SYNC ON pulse and OFF pulse durations must be longer than  $t_{CLKIN(TON)}$  and

$t_{CLKIN(TOFF)}$  respectively. The LM656x5-Q1 switching action can be synchronized to an external clock from 300kHz to 2.2MHz.

Note, an external SYNC signal can only be applied before or after pin detection. If applied during the pin detection, the SYNC signal can not be detected.



**Figure 7-3. Typical Implementation Allowing Synchronization Using the MODE/SYNC Pin**

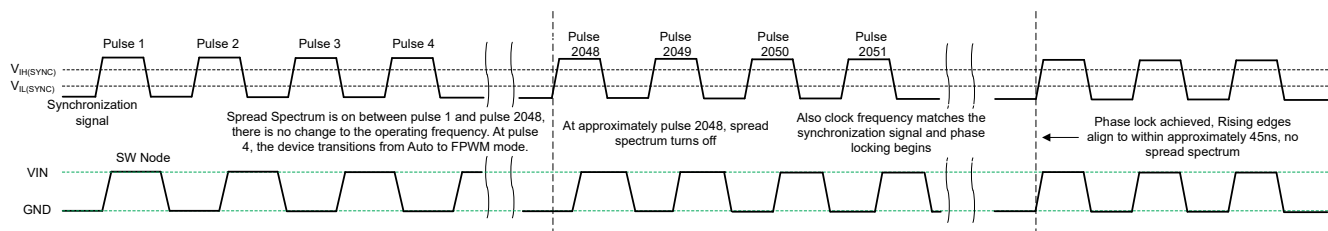


This figure shows the conditions needed for detection of a synchronization signal.

**Figure 7-4. Typical SYNC Waveform**

### 7.3.3.2 Clock Locking

After a valid synchronization signal is detected, a clock locking procedure is initiated. After approximately 2048 pulses, the clock frequency locks to the frequency of the synchronization signal. While the switching frequency adjusts, phase is maintained so that the clock cycle lying between the operation at the default and synchronization frequencies is of intermediate length. There are no very long or very short pulses. After frequency is adjusted, phase is adjusted over a few tens of cycles so that the rising synchronization edges correspond with the rising SW node pulses. See [Figure 7-5](#).



On the fourth pulse, the synchronization signal is detected. After approximately 2048 pulses, the synchronization signal is ready to synchronize, and the frequency is adjusted using a glitch-free technique, then the phase is locked.

**Figure 7-5. Synchronization Process**

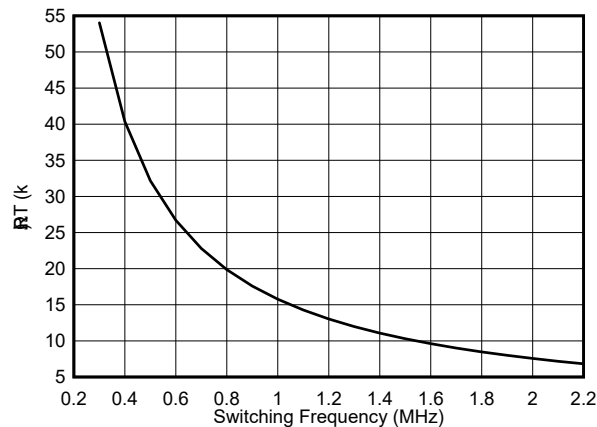


### 7.3.4 Adjustable Switching Frequency

The RT pin is configurable. This pin can be tied to VCC for 400kHz operation, grounded for 2.2MHz operation, or a resistor to GND can be used to set an adjustable operating frequency; see [Table 7-3](#). Note that if a resistor value falls outside of the recommended range the LM656x5-Q1 reverts to 400kHz or 2.2MHz. Do not apply a pulsed signal to this pin to force synchronization. If synchronization is needed, see the SYNC/MODE pin in [Section 7.3.3.1](#). The switching frequency can be programmed in the range of 300kHz to 2200kHz by placing a resistor from the RT pin to GND. See [Equation 4](#) and [Figure 7-6](#).

$$R_T(\text{k}\Omega) = \frac{16.4}{f_{\text{SW}}(\text{MHz})} - 0.633 \quad (4)$$

For example, for  $f_{\text{SW}} = 400\text{kHz}$ ,  $R_T = 40.37\text{k}\Omega$  so a 40.2k $\Omega$  resistor can be selected as the closest value.



**Figure 7-6. Switching Frequency vs RT**

**Table 7-3. Switching Frequency Settings**

RT	SWITCHING FREQUENCY
VCC	400kHz
GND	2200kHz
RT Resistor to GND	300kHz to 2200kHz
Float	Do not float

Note that a short to ground or a pullup to VCC requires < 200 $\Omega$  resistor.

### 7.3.5 Dual Random Spread Spectrum (DRSS)

The LM656x5-Q1 provides a Dual Random Spread Spectrum (DRSS) function, which reduces the EMI of the power supply over a wide-frequency range. The DRSS function combines a low-frequency triangular modulation profile (standard or wide) with a high-frequency cycle-by-cycle pseudo-random modulation profile. The low frequency triangular modulation improves performance in the lower radio frequency bands, while the high frequency random modulation improves performance in the higher radio frequency bands.

The low frequency triangular modulation profiles are pin-selectable. The standard low-frequency modulation profile spreads the switching frequency by  $\pm 5\%$  with a 12kHz modulation frequency while the wide low frequency modulation profile spreads the switching frequency by  $\pm 10\%$  with a 6kHz modulation frequency.

Spread spectrum works by converting a narrowband signal into a wideband signal which spreads the energy over multiple frequencies. Industry standards require different spectrum analyzer resolution bandwidth (RBW) settings for different frequency bands. The RBW has an impact on the spread spectrum performance. For example, the CISPR-25 requires 9kHz RBW for the 150kHz to 30MHz frequency band. For frequencies greater than 30MHz, the required RBW is 120kHz. DRSS is able to simultaneously improve the EMI performance in the high and low RBWs with the low frequency triangular modulation and high-frequency cycle-by-cycle

pseudo-random modulation. In the low-frequency band (150kHz – 30MHz), the DRSS function can reduce the conducted emissions by as much as 15dB $\mu$ V, and in the high-frequency band (30MHz – 108MHz) by as much as 5dB $\mu$ V. The DRSS function is disabled when an external clock is applied to the MODE / SYNC pin.

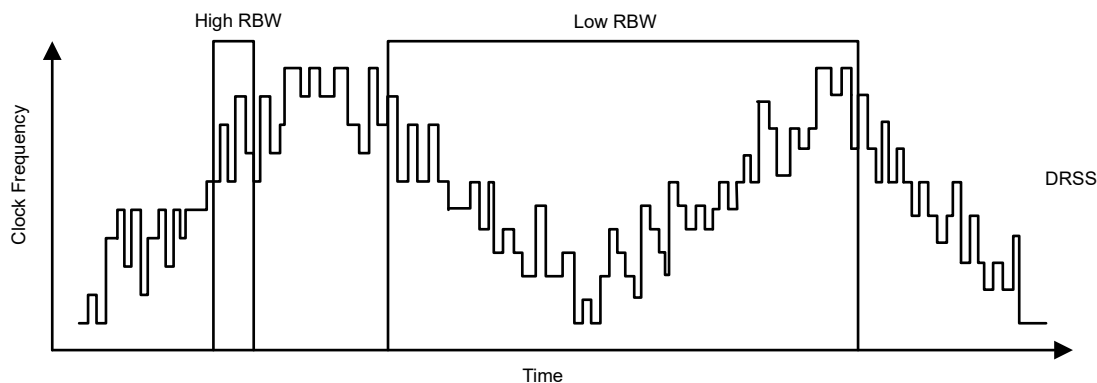


Figure 7-7. Dual Random Spread Spectrum Implementation

### 7.3.6 Internal LDO, VCC UVLO, and BIAS Input

The LM656x5-Q1 has a dual input for the VCC regulator that is supplied from either VIN or BIAS. After the LM656x5-Q1 is active, power comes from VIN if BIAS is less than approximately 3.1V. However, power comes from BIAS if BIAS is more than 3.2V<sub>MAX</sub>. VCC is typically 3.3V under most conditions, but can be lower if VIN is very low. To prevent unsafe operation, VCC has a UVLO that prevents switching if the internal voltage is too low. See V<sub>CC-UVLO\_R</sub> and V<sub>CC-UVLO\_HYST</sub> in *Electrical Characteristics*. TI recommends a 1 $\mu$ F capacitor rated for 10V with X7R or better dielectric for the VCC capacitor.

### 7.3.7 Bootstrap Voltage (BST Pin)

The driver of the power switch (HS switch) requires bias higher than VIN when the HS switch is ON. The capacitor connected between BST and SW works as a charge pump to boost voltage on the BST terminal to (SW + VCC). The boot diode is integrated on the LM656x5-Q1 die to minimize the physical design size. TI recommends a 100nF capacitor rated for 10V with X7R or better dielectric for the BST capacitor.

### 7.3.8 Soft Start and Recovery From Dropout

When designing with the LM656x5-Q1, slower rise in output voltage due to recovery from dropout and soft start must be considered separate phenomena. Soft start is triggered by any of the following conditions:

- EN is used to turn on the device
- Recovery from a hiccup waiting period; see [Section 7.3.9.3](#)
- Recovery from shutdown due to overtemperature protection
- Power is applied to the VIN of the IC or the VCC UVLO is released

After soft start is initiated, the IC takes the following actions:

- The reference used by the IC to regulate output voltage is slowly ramping up from zero. The net result is that output voltage, if previously 0V, takes t<sub>SS</sub> to reach 90% of regulation value.
- Operating mode is set to auto, activating diode emulation. This action allows start-up without pulling the output voltage low if there is a voltage already present on the output.
- Hiccup is disabled for the duration of soft start; see [Section 7.3.9.3](#).

All of these actions together provide a controlled start-up with limited inrush current. These actions also allow the use of output capacitors and loading conditions that can cause current limit during start-up without triggering hiccup. In addition, if the output voltage is already present the output voltage does not discharge.

Any time the output voltage is more than a few percent low for any reason, the output voltage ramps back up slowly. This action is the recovery from dropout condition, which differs from soft start in three important ways:

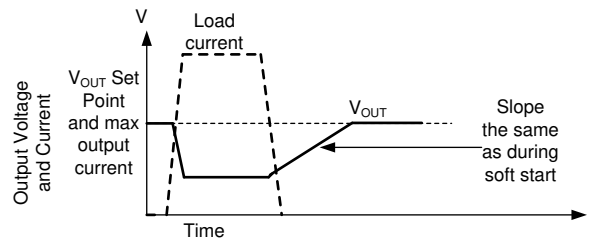
- Hiccup is allowed only if output voltage is less than 40 percent the set point. Note that during dropout regulation, hiccup is inhibited. See [Section 7.3.9.3](#).
- FPWM mode is allowed during recovery from dropout. If the output voltage were to suddenly be pulled up by an external supply, the LM656x5-Q1 can pull down on the output. Note that all the protections that are present during normal operation are in place, protecting the device if output is shorted to a high voltage or ground.
- The reference voltage is set to approximately 1% above that needed to achieve the current output voltage. The reference voltage is not started from zero.

Despite the name, recovery from dropout is active whenever output voltage is more than a few percent lower than the setpoint for long enough that:

- Duty factor is controlled by minimum on-time or
- When the part is operating in current limit.

This action primarily occurs under the following conditions:

- Dropout: when there is insufficient input voltage for the desired output voltage to be generated.
- Overcurrent that is not severe enough to trigger hiccup or if the duration is too short to trigger hiccup. See [Section 7.3.9.3](#).



Whether output voltage falls due to high load or low input voltage, after the condition that causes output to fall below the setpoint is removed, output climbs at the same speed as during start-up. Even though hiccup does not trigger due to dropout, hiccup can, in principal, be triggered during recovery if output voltage is below 0.4 times output the setpoint for more than 64 clock cycles during recovery.

**Figure 7-8. Recovery From Dropout**

### 7.3.9 Safety Features

The LM656x5-Q1 includes a set of safety features:

- Power-Good monitor with output undervoltage (UV) and overvoltage (OV) protection
- Overcurrent and short-circuit protection with HICCUP mode
- Thermal shutdown (TSD)

#### 7.3.9.1 Power-Good Monitor

The LM656x5-Q1 includes a power-good function to simplify supply sequencing and supervision in a system. The power good function can be used to enable downstream circuits that are supplied by the LM656x5-Q1, control downstream protection circuits such as load switches, or to turn on sequenced supplies. The function monitors the output voltage with a window comparator through the FB pin for adjustable  $V_{OUT}$  configurations and the BIAS pin for fixed  $V_{OUT}$  configurations. The power-good output (PG) switches to a high impedance open-drain state when the output voltage is in regulation. When the output voltage is outside of the  $\pm 5\%$  range from the set voltage, the PG pin is driven low ( $< V_{OL(PG)}$ ) warning the system of an output over-voltage or under-voltage condition. A 114 $\mu$ s deglitch filter on the PG falling edge prevents false tripping of the power good signals during transients. When the output voltage returns within the regulation window, a 2ms filter on the PG rising edge allows extra processing time for the downstream components.

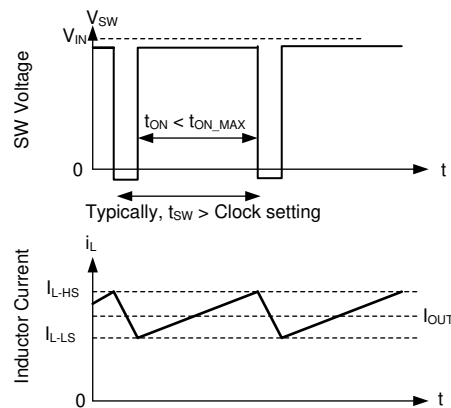
TI recommends a 100k $\Omega$  pullup resistor from the PG pin to the relevant logic rail not greater than 30V. PG is asserted low during soft start and when the LM656x5-Q1 is disabled.

### 7.3.9.2 Overcurrent and Short-Circuit Protection

The LM656x5-Q1 is protected from overcurrent conditions by cycle-by-cycle current limiting on both the high-side and the low-side MOSFETs.

High-side MOSFET overcurrent protection is implemented by the nature of the peak current mode control. The HS switch current is sensed when the HS is turned on after a short blanking time. The HS switch current is compared to the minimum of a fixed current setpoint, or the output of the voltage regulation loop minus slope compensation, every switching cycle. Because the voltage loop has a maximum value and slope compensation increases with duty cycle, the HS current limit decreases with increased duty cycle if duty cycle is above 35%.

When the LS switch is turned on, the current going through is also sensed and monitored. Like the high-side MOSFET, the low-side MOSFET turn-off is commanded by the voltage control loop. For a low-side device, turn-off is prevented if the current limit is exceeded, even if the oscillator normally starts a new switching cycle. Also like the high-side device, there is a limit on how high the turn-off current is allowed to be. This limit is called the low-side current limit; see the *Electrical Characteristics* for values. If the LS current limit is exceeded, the LS MOSFET stays on and the HS switch is not turned on. The LS switch is turned off after the LS current falls below the limit. The HS switch is turned on again as long as at least one clock period has passed since the last time the HS device has turned on.



**Figure 7-9. Current Limit Waveforms**

The net effect of the operation of high-side and low-side current limit is that the IC operates in hysteretic control. Because the current waveform assumes values between  $I_{L-HS}$  and  $I_{L-LS}$ , output current is close to the average of these two values unless duty cycle is very high. After operating in current limit, hysteretic control is used and current does not increase as output voltage approaches zero.

If the duty cycle is very high, current ripple must be very low to prevent instability; refer to [Section 8.2.2.4](#). Because the current ripple is low, the device is able to deliver the full load current. The current delivered is close to  $I_{L-LS}$ .

After the overload condition is removed, the device recovers as though in soft start; see [Section 7.3.8](#). Note that hiccup can be triggered if output voltage drops below approximately 0.4 times the intended output voltage and 64 consecutive switching cycles elapse.

### 7.3.9.3 Hiccup

The LM656x5-Q1 employs hiccup overcurrent protection when all of the following conditions are met for 64 consecutive switching cycles:

- A time greater than  $t_{SS}$  has passed since soft start has started; see [Section 7.3.8](#).
- Output voltage is below approximately 0.4 times output setpoint.
- The device is not operating in dropout defined as having minimum off-time controlled by duty factor.

In hiccup mode, the device shuts down and attempts to soft start after  $t_{HIC}$ . Hiccup mode helps reduce the device power dissipation under severe overcurrent and short circuit conditions.

#### 7.3.9.4 Thermal Shutdown

Thermal shutdown limits total power dissipation by turning off the internal switches when the IC junction temperature exceeds 165°C (typical) and power-good (PG) asserts. Thermal shutdown does not trigger below 155°C. After thermal shutdown occurs, hysteresis prevents the device from switching until the junction temperature drops to approximately 156°C. When the junction temperature falls below 156°C (typical), the LM656x5-Q1 attempts to soft start.

### 7.4 Device Functional Modes

#### 7.4.1 Shutdown Mode

The EN pin provides electrical on and off control of the device. When the EN pin voltage is below 0.9V, both the regulator and the internal LDO have no output voltage and the part is in shutdown mode. In shutdown mode, the quiescent current drops below 0.85µA and PG pin gets pulled low.

#### 7.4.2 Active Mode

The LM656x5-Q1 is in active mode when the following occurs:

- The EN pin is above  $V_{EN\_TH\_R}$ .
- $V_{IN}$  is above  $V_{IN\_UVLO\_R}$ .
- $V_{IN}$  is high enough to satisfy the  $V_{IN}$  minimum operating input voltage.
- No other fault conditions are present.

See [Section 7.3](#) for protection features. The simplest way to enable the operation is to connect EN to VIN, allowing self-start-up when the applied input voltage exceeds the minimum  $V_{IN\_OPERATE}$ .

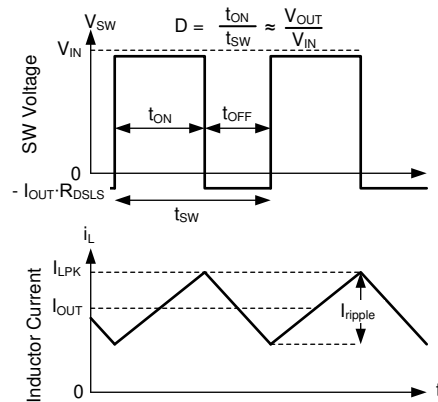
In active mode, depending on the load current, input voltage, and output voltage, the LM656x5-Q1 is in one of six sub-modes:

- Continuous conduction mode (CCM) with fixed switching frequency and peak current mode operation.
- Discontinuous conduction mode (DCM) while in auto mode when the load current is lower than half of the inductor current ripple. If current continues to reduce, the device enters Pulse Frequency Modulation (PFM) which reduces the switch frequency to maintain regulation while reducing switching losses to achieve higher efficiency at light load.
- Minimum on-time operation while the on-time of the device needed for full-frequency operation at the requested low-duty cycle is not supported by  $T_{ON\_MIN}$ .
- Forced pulse width modulation (FPWM) similar to CCM with fixed-switching frequency, but extends the fixed frequency range of operation from full to no load.
- A current limiting condition where the output voltage remains above 0.4 times the output setpoint.
- Dropout mode when switching frequency is reduced to minimize dropout.
- Recovery from dropout similar to other modes of operation except the output voltage setpoint is gradually moved up until the programmed setpoint is reached.

##### 7.4.2.1 Peak Current Mode Operation

The following operating description of the LM656x5-Q1 refers to [Section 7.2](#) and the waveforms in [Figure 7-10](#). Both supply a regulated output voltage by turning on the internal high-side (HS) and low-side (LS) NMOS switches with varying duty cycle (D). During the HS switch on-time, the SW terminal voltage,  $V_{SW}$ , swings up to approximately  $V_{IN}$ , and the inductor current,  $i_L$ , increases with a linear slope. The HS switch is turned off by the control logic. During the HS switch off-time,  $t_{OFF}$ , the LS switch is turned on. Inductor current discharges through the LS switch, forcing  $V_{SW}$  to swing below ground by the voltage drop across the LS switch. The regulator loop adjusts the duty cycle to maintain a constant output voltage. D is defined by the on-time of the HS switch over the switching period:  $D = T_{ON} / (T_{ON} + T_{OFF})$ .

In an ideal buck converter, where losses are ignored, D is proportional to the output voltage and inversely proportional to the input voltage:  $D = V_{OUT} / V_{IN}$ .



**Figure 7-10. SW Voltage and Inductor Current Waveforms in Continuous Conduction Mode (CCM)**

To get accurate DC load regulation, a voltage feedback loop is used. Peak and valley inductor currents are sensed for peak current mode control and current protection. The regulator operates with continuous conduction mode with constant switching frequency when load level is above one half of the minimum peak inductor current. The internally-compensated regulation network achieves fast and stable operation with small external components and low-ESR capacitors.

**7.4.2.2 Auto Mode Operation**

The LM656x5-Q1 can have two behaviors while lightly loaded. One behavior, called auto mode operation, allows a seamless transition between normal current mode operation while heavily loaded and in highly-efficient light-load operation. The other behavior known as FPWM mode, maintains full frequency even when unloaded. Which mode the LM656x5-Q1 operates in depends on the SYNC/MODE pin. When SYNC/MODE is high, the part is in FPWM. When SYNC/MODE is low, the part is in PFM.

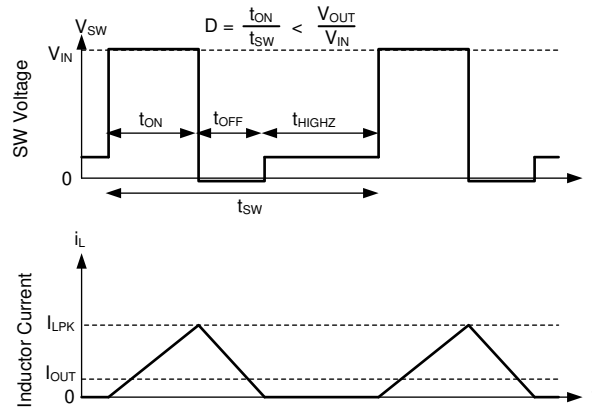
In auto mode, light-load operation is employed in the LM656x5-Q1 at load lower than approximately 1/10th of the rated maximum output current. Light-load operation employs two techniques to improve efficiency:

- Diode emulation, which allows DCM operation
- Frequency foldback

Note that while these two features operate together to create excellent light load behavior, these features operate independently of each other.

**7.4.2.2.1 Diode Emulation**

Diode emulation prevents reverse current through the inductor, which requires a lower frequency needed to regulate given a fixed peak inductor current. Diode emulation also limits ripple current as frequency is reduced. Frequency is reduced when peak inductor current goes below  $I_{PEAK-MIN}$ . With a fixed peak current, as output current is reduced to zero, frequency must be reduced to near zero to maintain regulation.



In auto mode, the low-side device is turned off after inductor current is near zero. As a result, after output current is less than half of inductor ripple in CCM, the part operates in DCM. This is equivalent to saying that diode emulation is active.

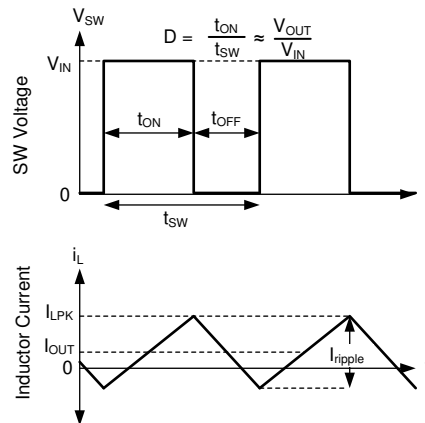
**Figure 7-11. PFM Operation**

The LM656x5-Q1 has a minimum peak inductor current setting in auto mode. That being said, when current is reduced to a low value with fixed input voltage, on-time is constant. Regulation is then achieved by adjusting frequency. This mode of operation is called PFM mode regulation.

#### 7.4.2.3 FPWM Mode Operation

Like auto mode operation, FPWM mode operation during light-load operation is selected using the SYNC/MODE pin.

In FPWM Mode, frequency is maintained while lightly loaded. To maintain frequency, a limited reverse current is allowed to flow through the inductor. Reverse current is limited by reverse current limit circuitry. See the *Electrical Characteristics* for reverse current limit values.



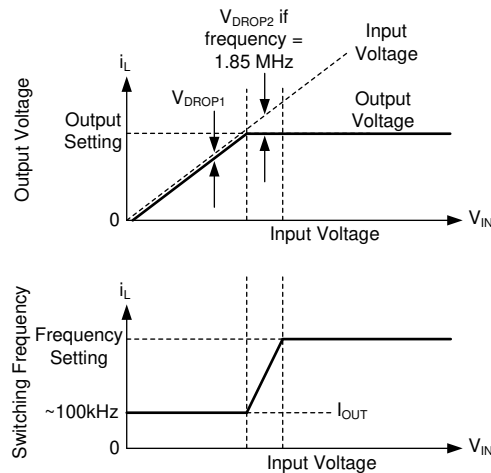
FPWM mode Continuous Conduction (CCM) is possible even if  $I_{OUT}$  is less than half of  $I_{ripple}$ .

**Figure 7-12. FPWM Mode Operation**

In FPWM mode, frequency reduction can occur if the input voltage is high enough to command minimum on-time, even while lightly loaded. This foldback feature allows to sustain regulation during input voltage transient events.

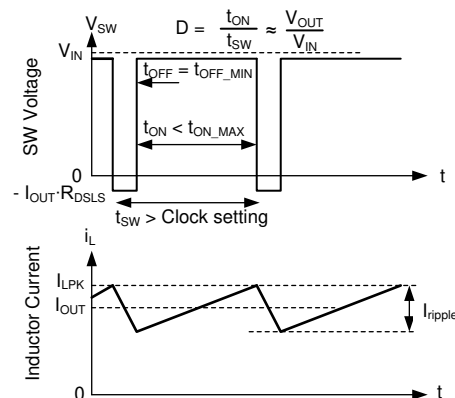
### 7.4.2.4 Dropout

Dropout operation is defined as any input-to-output voltage ratio that requires frequency to drop to achieve the needed duty factor. At a given clock frequency, duty factor is limited by minimum off-time. After this limit is reached, if clock frequency is maintained, output voltage falls. Instead of allowing the output voltage to drop, the LM656x5-Q1 extends on-time past the end of the clock cycle until the required peak inductor current is achieved. The clock can start a new cycle after peak inductor current is achieved or after a pre-determined maximum on-time,  $t_{ON\_MAX}$ , of approximately  $9\mu s$  elapses. As a result, after the needed duty factor cannot be achieved at the selected clock frequency due to the existence of a minimum off-time, frequency drops to maintain regulation. If input voltage is low enough that the output voltage cannot be regulated even with an on-time of  $t_{ON\_MAX}$ , output voltage drops to slightly below input voltage,  $V_{DROPP1}$ . See [Section 6](#).



Output voltage and frequency versus input voltage: if there is little difference between input voltage and output voltage setting, the IC reduces frequency to maintain regulation. If input voltage is too low to provide the desired output voltage at approximately 110kHz, output voltage tracks input voltage.

**Figure 7-13. Frequency and Output Voltage in Dropout**



This image shows the switching waveforms while in dropout. Inductor current takes longer than a normal clock to reach the desired peak value. As a result, frequency drops. This frequency drop is limited by  $t_{ON\_MAX}$ .

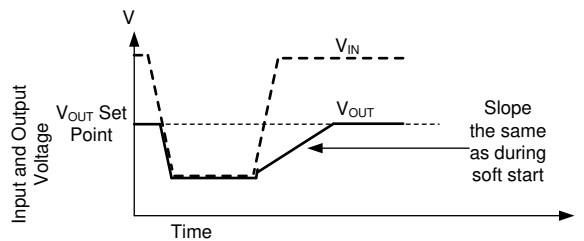
**Figure 7-14. Dropout Waveforms**



#### 7.4.2.5 Recovery from Dropout

In some applications, input voltage can drop below the desired output voltage then recover to a higher value suddenly. With most regulators, the sudden increase in input voltage results in output voltage rising at a rate limited only by current limit until regulation is achieved. As input voltage reaches the desired output voltage, there is overshoot due to wind up in the control loop. This overshoot can be large in applications that have small output capacitors and light loads. Also, large inrush currents can cause large fluctuations on the input line after the regulator starts regulating the output voltage. This typically requires less current than during this initial inrush.

The LM656x5-Q1 greatly reduces inrush current and overshoot. This is done by engaging the soft-start circuit whenever the input voltage suddenly rises, after dipping low enough to cause the output voltage to droop. To prevent this feature from accidentally engaging, output voltage must fall more than 1% to engage this feature. Also, this feature engages only if operating in dropout or current limit, preventing interference with normal transient response but allowing several percent overshoot while engaging. If output voltage is very close to the desired level, overshoot is reduced by inductor current not having time to rise to a high level before regulation starts.



**Figure 7-15. When Output Voltage Falls, Output Voltage Recovers Slowly, Preventing Overshoot and Large Inrush Currents**

## 8 Application and Implementation

---

### Note

Information in the following applications sections is not part of the TI component specification, and TI does not warrant its accuracy or completeness. TI's customers are responsible for determining suitability of components for their purposes, as well as validating and testing their design implementation to confirm system functionality.

---

### 8.1 Application Information

The LM656x5-Q1 step-down DC-to-DC converter is typically used to convert a higher DC voltage to a lower DC voltage with a maximum output current of 2.5A, 3.5A, 4.5A. The following design procedure can be used to select components for the LM656x5-Q1. Alternately, use the WEBENCH design tool to generate a complete design ([WEBENCH](#)). This tool uses an iterative design procedure and has access to a comprehensive database of components. This feature allows the tool to create an optimized design and allows the user to experiment with various options.

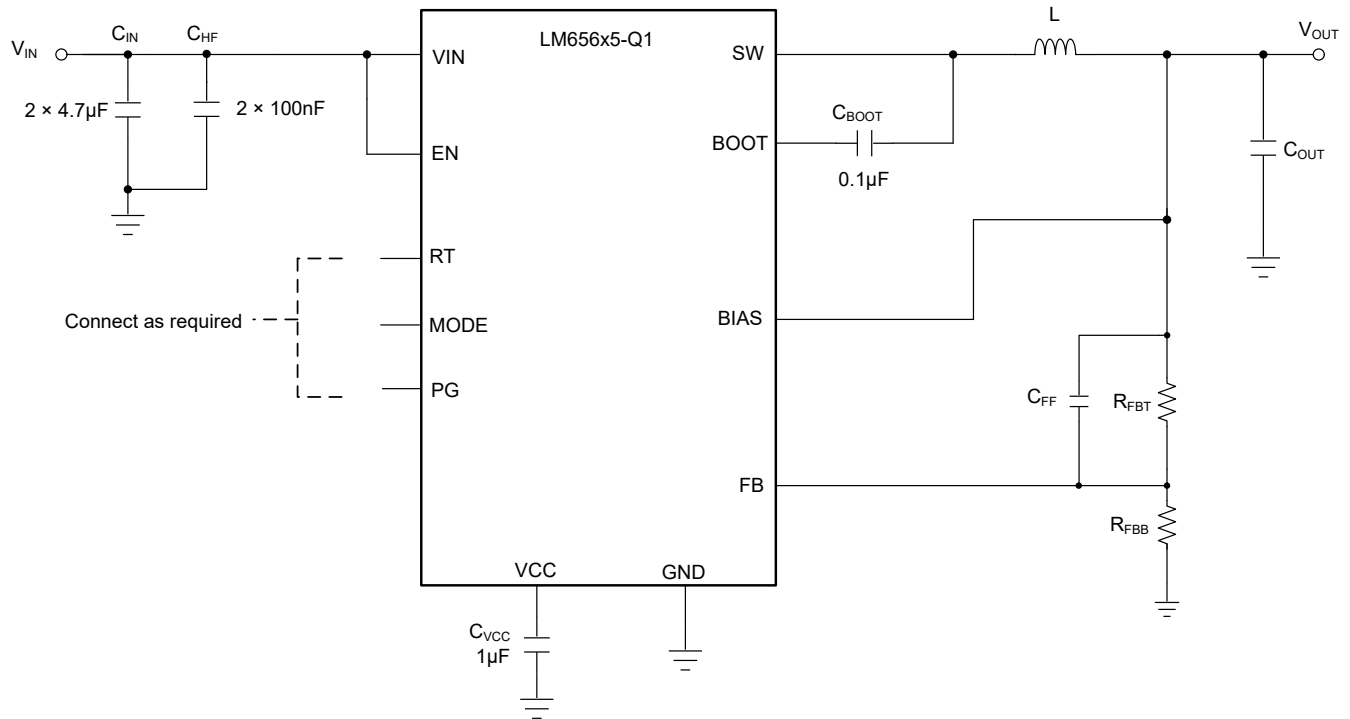
### Note

All of the capacitance values given in the following application information refer to *effective* values unless otherwise stated. The *effective* value is defined as the actual capacitance under DC bias and temperature, not the rated or nameplate values. Use high-quality, low-ESR, ceramic capacitors with an X7R or better dielectric throughout. All high value ceramic capacitors have a large voltage coefficient in addition to normal tolerances and temperature effects. Under DC bias, the capacitance drops considerably. Large case sizes and higher voltage ratings are better in this regard. To help mitigate these effects, multiple capacitors can be used in parallel to bring the minimum *effective* capacitance up to the required value. This action can also ease the RMS current requirements on a single capacitor. A careful study of bias and temperature variation of any capacitor bank must be made to make sure that the minimum value of *effective* capacitance is provided.

---

## 8.2 Typical Application

Figure 8-1 and Figure 8-2 show typical application circuits for the LM656x5-Q1, when using the adjustable output mode or the fixed output mode, respectively. This device is designed to function over a wide range of external components and system parameters. However, the internal compensation is designed for a certain range of external inductance and output capacitance. As a quick-start guide, Table 8-1 through Table 8-4 provide typical component values for a range of application parameters. The component values in these table represent stable designs and are not necessarily optimized. Note that the designs in these tables are based on a typical input voltage of 12V; or 36V for the 24V outputs.



**Figure 8-1. Example Application Circuit for Adjustable Output Voltage Mode With LM656x5-Q1**

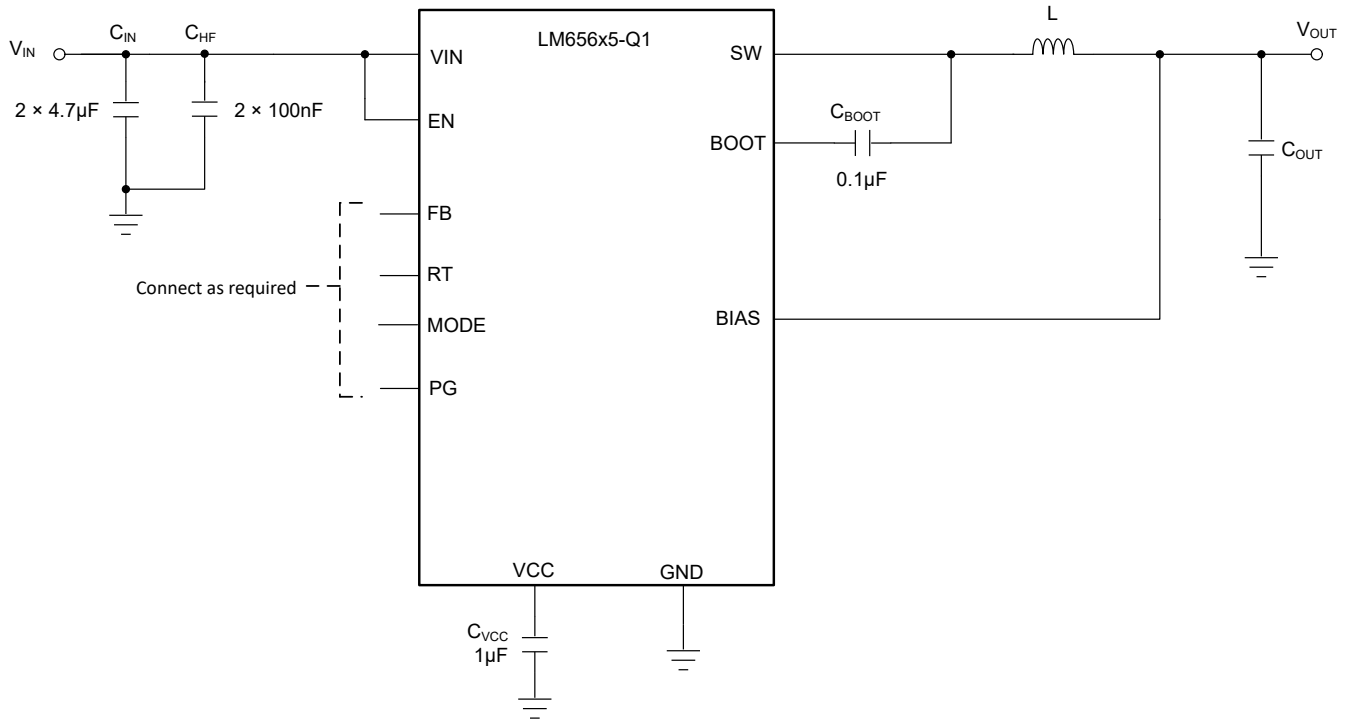


Figure 8-2. Example Application Circuit for Fixed Output Voltage Mode With LM656x5-Q1

Table 8-1. Typical External Components for Fixed Output Voltage Mode

OUTPUT VOLTAGE	FREQUENCY	FB	LM6xx25		LM6xx35		LM6xx45	
			L	COUT	L	COUT	L	COUT <sup>(1)</sup>
3.3V	400kHz	GND	8.2µH	75µF	6.8µH	94µF	5.6µH	110µF
3.3V	2200kHz	GND	1.5µH	20µF	1.5µH	25µF	1.0µH	30µF
5V	400kHz	VCC	10µH	50µF	8.2µH	55µF	8.2µH	70µF
5V	2200kHz	VCC	2.2µH	15µF	1.5µH	20µF	1.5µH	25µF

(1) Please note all COUT values are the derated output capacitor values in the tables.

Table 8-2. Typical External Components for LM6x635 in Adjustable Output Voltage Mode

OUTPUT VOLTAGE	FREQUENCY	L	COUT <sup>(1)</sup>	R <sub>FBT</sub>	R <sub>FBB</sub>	C <sub>FF</sub>
3.3V	400kHz	6.8µH	70µF	100kΩ	31.6kΩ	10pF
5V	400kHz	10µH	60µF	100kΩ	19.1kΩ	15pF
24V	400kHz	47µH	25µF	205kΩ	7.15kΩ	10pF
3.3V	2200kHz	1.2µH	30µF	100kΩ	31.6kΩ	5pF
5V	2200kHz	1.5µH	20µF	100kΩ	19.1kΩ	5pF
24V	2200kHz	5.6µH	10µF	205kΩ	7.15kΩ	5pF

Table 8-3. Typical External Components for LM6x645 in Adjustable Output Voltage Mode

OUTPUT VOLTAGE	FREQUENCY	L	COUT <sup>(1)</sup>	R <sub>FBT</sub>	R <sub>FBB</sub>	C <sub>FF</sub>
3.3V	400kHz	5.6µH	80µF	100kΩ	31.6kΩ	15pF
5V	400kHz	8.2µH	70µF	100kΩ	19.1kΩ	15pF
24V	400kHz	22µH	30µF	205kΩ	7.15kΩ	10pF
3.3V	2200kHz	1.2µH	40µF	100kΩ	31.6kΩ	5pF
5V	2200kHz	1.2µH	30µF	100kΩ	19.1kΩ	5pF

**Table 8-3. Typical External Components for LM6x645 in Adjustable Output Voltage Mode (continued)**

OUTPUT VOLTAGE	FREQUENCY	L	COU <sup>T</sup> ( <sup>1</sup> )	R <sub>F<sup>B</sup>T</sub>	R <sub>F<sup>B</sup>B</sub>	C <sub>F<sup>F</sup></sub>
24V	2200kHz	5.6μH	10μF	205kΩ	7.15kΩ	5pF

**Table 8-4. Typical External Components for Various Adjustable Output Voltage Applications**

OUTPUT VOLTAGE	OUTPUT CURRENT	FREQUENCY	L	COU <sup>T</sup> ( <sup>1</sup> )	R <sub>F<sup>B</sup>T</sub>	R <sub>F<sup>B</sup>B</sub>	C <sub>F<sup>F</sup></sub>
3.3V	3.5A	1100kHz	3.3μH	45μF	N/A	N/A	N/A
1V	4.5A	500kHz	2.2μH	550μF	100kΩ	402kΩ	25pF
12V	3.5A	1100kHz	6.8μH	15μF	100kΩ	7.15kΩ	10pF
16V	3.5A	1600kHz	5.6μH	10μF	100kΩ	5.23kΩ	5pF

### 8.2.1 Design Requirements

The following example provides a detailed design procedure based on the specifications found in [Table 8-5](#).

**Table 8-5. Detailed Design Parameters**

DESIGN PARAMETER	EXAMPLE VALUE
Input voltage	24V (typical)
Output voltage	5V
Maximum output current	0A to 3.5A
Switching frequency	2200kHz

### 8.2.2 Detailed Design Procedure

The following design procedure applies to [Figure 8-2](#) and [Table 8-5](#).

#### 8.2.2.1 Custom Design With WEBENCH® Tools

[Click here](#) to create a custom design using the LM656x5-Q1 device with the WEBENCH Power Designer.

1. Start by entering the input voltage ( $V_{IN}$ ), output voltage ( $V_{OUT}$ ), and output current ( $I_{OUT}$ ) requirements.
2. Optimize the design for key parameters such as efficiency, footprint, and cost using the optimizer dial.
3. Compare the generated design with other possible solutions from Texas Instruments.

The WEBENCH Power Designer provides a customized schematic along with a list of materials with real-time pricing and component availability.

In most cases, these actions are available:

- Run electrical simulations to see important waveforms and circuit performance
- Run thermal simulations to understand board thermal performance
- Export customized schematic and layout into popular CAD formats
- Print PDF reports for the design, and share the design with colleagues

Get more information about WEBENCH tools at [www.ti.com/WBENCH](http://www.ti.com/WBENCH).

#### 8.2.2.2 Choosing the Switching Frequency

The choice of switching frequency is a compromise between conversion efficiency and overall design size. Lower switching frequency implies reduced switching losses and usually results in higher system efficiency. However, higher switching frequency allows the use of smaller inductors and output capacitors, hence, a more compact design. For this application example, select a frequency of 2200kHz. In this case, the RT pin is connected to the GND. See [Section 7.3.4](#) for more details.

#### 8.2.2.3 FB for Adjustable or Fixed Output Voltage Mode

This example uses the fixed output voltage mode to set the output voltage to 5V, by connecting the FB pin to the VCC pin.

If an output voltage different from either 3.3V or 5V is required, then the adjustable output voltage mode must be used. In that case, an external voltage divider must be connected between the output node and the FB pin, while [Equation 5](#) and [Equation 6](#) are used to determine the divider values.

$$R_{FBB} = R_{FBT} \times \frac{0.8}{V_{OUT} - 0.8} \quad (5)$$

$$100k\Omega \geq R_{FBB} \parallel R_{FBT} \geq 4k\Omega \quad (6)$$

Note that [Equation 6](#) states that the parallel combination of  $R_{FBB}$  and  $R_{FBT}$  must be greater than  $4k\Omega$  and less than  $100k\Omega$ . This limit is required because the regulator must reliably detect the state of the FB pin during the start-up sequence to set the output voltage mode correctly. The capacitance from the FB pin to ground must be minimized on the PCB layout.

If the adjustable output voltage mode had been chosen for this example, then values of  $R_{FBT} = 100k\Omega$  and  $R_{FBB} = 19.1k\Omega$  satisfy both [Equation 5](#) and [Equation 6](#).

For more details, see [Section 7.3.1](#).

#### 8.2.2.4 Inductor Selection

The parameters for selecting the inductor are the inductance and saturation current. The inductance is based on the desired peak-to-peak ripple current and is normally chosen to be in the range of 20% to 40% of the maximum output current *rating* of the device. Experience shows that the best value for inductor ripple current is 30% of the maximum output current rating. Larger values of ripple current can restrict the maximum output current, before current limit is reached. Smaller values of ripple current reduce the SNR of the current mode controller and can lead to increased jitter in the duty cycle. Both the inductor and switching frequency tolerance have an impact on the selection of ripple current, and, therefore, inductor value. Use the maximum device current rating when calculating the ripple current for applications with much smaller maximum load than the maximum available from the device. The ratio of inductor ripple current over maximum output current is designated as K. [Equation 7](#) is used to determine the value of inductance

$$L = \frac{(V_{IN} - V_{OUT}) \times V_{OUT}}{V_{IN} \times K \times I_{OUT - rated} \times F_{SW}} \quad (7)$$

The typical input voltage for the application is usually used in [Equation 7](#). However, if the application requires and very wide range of input voltages, then some voltage near the upper end of the range can be used. In any case, after the inductor has been selected, the ripple current must be checked at the maximum input voltage. Too large a ripple current can limit the maximum output current, as mentioned above. Use [Equation 8](#) to check for these concerns.

$$I_{OUT - max} \cong I_{HS - LIM} - \frac{1}{2} \times \frac{(V_{IN} - V_{OUT}) \times V_{OUT}}{V_{IN} \times L \times F_{SW}} \quad (8)$$

Ideally, the saturation current rating of the inductor is at least as large as the high-side switch current limit,  $I_{HS-LIM}$ . This size makes sure that the inductor does not saturate even during a short circuit on the output. When the inductor core material saturates, the inductance falls to a very low value, causing the inductor current to rise very rapidly. Although the valley current limit is designed to reduce the risk of current run-away, a saturated inductor can cause the current to rise to high values very rapidly. This rise can lead to component damage. Inductors with a ferrite core material have very hard saturation characteristics, but usually have lower core losses than powdered iron cores. Powdered iron cores exhibit a soft saturation, allowing some relaxation in the current rating of the inductor. However, powdered iron cores have more core losses at frequencies above about 1MHz. In any case, the inductor saturation current must not be less than the maximum peak inductor current at full load.

To avoid subharmonic oscillation, the inductance value must not be less than that given in [Equation 9](#). This limit applies to applications where the switch duty cycle becomes greater than or equal to 50%, under any operating condition.

$$L_{\min} \geq M \times \frac{V_{\text{OUT}}}{F_{\text{SW}}} \quad (9)$$

where

- M = 0.47 for the 2.5A device
- M = 0.35 for the 3.5A device
- M = 0.29 for the 4.5A device

The maximum inductance is limited by the minimum current ripple required for the current mode control to perform correctly. As a rule, the minimum inductor ripple current must be no less than about 10% of the device maximum rated current under nominal conditions.

For this example, assuming a 24V input, [Equation 7](#) gives a value of 1.7μH. Use the next standard value of 2.2μH. Alternatively, [Table 8-1](#) can be used to select the inductor value for a typical input voltage of 12V.

### 8.2.2.5 Output Capacitor Selection

The current mode control scheme of the LM656x5-Q1 devices allows operation over a wide range of output capacitance. The output capacitor bank is usually limited by the load transient requirements and stability rather than the output voltage ripple. The best starting point for estimating the required output capacitance is to use the values in [Table 8-1](#) through [Table 8-4](#). The values found in those tables can be interpolated for other output voltages or switching frequencies. In general, higher output voltages and higher switching frequencies require less output capacitance. In addition, when using the adjustable output voltage mode, the C<sub>FF</sub> capacitor can be used to optimize the loop performance.

After the output capacitance is selected, and assuming a low ESR ceramic is used, the approximate peak-to-peak output voltage ripple can be estimated using [Equation 10](#) and [Equation 11](#).

$$V_r \cong \frac{\Delta I}{8 \times F_{\text{SW}} \times C_{\text{OUT}}} \quad (10)$$

$$\Delta I = \frac{(V_{\text{IN}} - V_{\text{OUT}}) \times V_{\text{OUT}}}{V_{\text{IN}} \times F_{\text{SW}} \times L} \quad (11)$$

In practice, the output capacitor has the most influence on the transient response and loop-phase margin. Load transient testing and Bode plots are the best way to validate any given design and must always be completed before the application goes into production. In addition to the required output capacitance, a small ceramic placed on the output can help reduce high-frequency noise. Small-case size ceramic capacitors in the range of 1nF to 100nF can be very helpful in reducing spikes on the output caused by inductor and board parasitics.

The maximum output capacitance must be limited to approximately 10 times the design value, or 1000μF, whichever is smaller. Large values of output capacitance can adversely affect the start-up behavior of the regulator as well as the loop stability. If values larger than noted here must be used, then a careful study of start-up at full load and loop stability must be performed.

This example uses an output capacitance of 15μF, based on [Table 8-1](#). Keep in mind that this example represents the value after applying D.C. bias derating and any other applicable tolerance in the capacitance. This is true for all the values shown in the tables. Any ceramic capacitor, or combination of capacitors, with an X7R or better dielectric, that provides 15μF at 5V bias, can be used. The values shown in the table must be considered as typical to provide a stable design. Maximum and minimum limits on the output capacitance can be found by testing the application, as mentioned above.

### 8.2.2.6 Input Capacitor Selection

The ceramic input capacitors provide a low impedance source to the regulator in addition to supplying the ripple current and isolating switching noise from other circuits. A minimum ceramic capacitance of 2 × 4.7μF is required on the input of the regulator. Place one capacitor on each side of the package and connected directly to the VIN and GND pins of the device. This capacitance must be rated for at least the maximum input voltage that the application requires, preferably twice the maximum input voltage. The value can be increased to help reduce

input voltage ripple and maintain the input voltage during load transients. In addition, a high frequency bypass capacitance of  $2 \times 100\text{nF}$  ceramic capacitor must be used at the input, as close a possible to the regulator. Place one capacitor on each side of the package and connected directly to the VIN and GND pins of the device. This requirement provides a high frequency bypass for the control circuits internal to the device.

For this example,  $2 \times 4.7\mu\text{F}$ , 100V, X7R (or better) ceramic capacitors are chosen. The 100nF capacitors must also be rated at 100V with an X7R dielectric.

Using an electrolytic capacitor on the input in parallel with the ceramics is often desirable. This statement is especially true if long leads or traces are used to connect the input supply to the regulator, or an input EMI filter is used. The moderate ESR of this capacitor can help damp any ringing on the input supply caused by any inductance on the input. The use of this additional capacitor also helps with voltage dips caused by input supplies with unusually high impedance.

Most of the input switching current passes through the ceramic input capacitor or capacitors. The approximate RMS value of this current can be calculated from Equation 12 and must be checked against the manufacturers maximum ratings.

$$I_{\text{RMS}} \approx \frac{I_{\text{OUT}}}{2} \tag{12}$$

#### 8.2.2.7 C<sub>BOOT</sub>

The LM656x5-Q1 requires a bootstrap capacitor connected between the BOOT pin and the SW pin. This capacitor stores energy that is used to supply the high-side gate driver for the power MOSFET, along with other critical control circuits. A high-quality ceramic capacitor of 100nF and at least 16V is required.

#### 8.2.2.8 External UVLO

In some cases, an input UVLO level different than that provided internal to the device is needed. This need can be accomplished by using the circuit shown in Figure 8-3. The turn-on voltage is designated as  $V_{\text{ON}}$  while the turn-off voltage is  $V_{\text{OFF}}$ . First, a value for  $R_{\text{ENB}}$  is chosen in the range of 10kΩ to 100kΩ, then use Equation 13 and Equation 14 to calculate  $R_{\text{ENT}}$  and  $V_{\text{OFF}}$ .

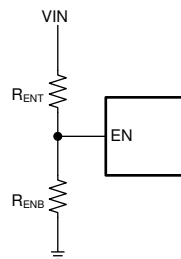


Figure 8-3. Setup for External UVLO Application

$$R_{\text{ENT}} = R_{\text{ENB}} \times \left( \frac{V_{\text{ON}}}{V_{\text{EN-H}}} - 1 \right) \tag{13}$$

$$V_{\text{OFF}} = V_{\text{EN-L}} \times \left( \frac{V_{\text{ON}}}{V_{\text{EN-H}}} \right) \tag{14}$$

where

- $V_{\text{ON}} = V_{\text{IN}}$  turn-on voltage
- $V_{\text{OFF}} = V_{\text{IN}}$  turn-off voltage

#### 8.2.2.9 Maximum Ambient Temperature

As with any power conversion device, the regulator dissipates internal power while operating. The effect of this power dissipation is to raise the internal temperature of the converter above ambient. The internal die



temperature ( $T_J$ ) is a function of the ambient temperature, the power loss, and the effective thermal resistance,  $R_{\theta JA}$ , of the device and PCB combination. The maximum junction temperature for the LM656x5-Q1 must be limited to 150°C. This limit establishes a limit on the maximum device power dissipation and, therefore, the load current. Equation 15 shows the relationships between the important parameters. Higher ambient temperatures ( $T_A$ ) and larger values of  $R_{\theta JA}$  reduce the maximum available output current. The converter efficiency can be estimated by using the curves provided in this data sheet. If the desired operating conditions cannot be found in one of the curves, interpolation can be used to estimate the efficiency. Alternatively, the EVM can be adjusted to match the desired application requirements and the efficiency can be measured directly. The correct value of  $R_{\theta JA}$  is more difficult to estimate. As stated in the [Semiconductor and IC Package Thermal Metrics application note](#), the values given in the *Thermal Information* table are not valid for design purposes and must not be used to estimate the thermal performance of the application. The values reported in that table were measured under a specific set of conditions that are rarely obtained in an actual application. The data given for  $R_{\theta JC(bott)}$  and  $\Psi_{JT}$  can be useful when determining thermal performance. See the [Semiconductor and IC Package Thermal Metrics application note](#) for more information and the resources given at the end of this section.

$$I_{OUT_{MAX}} = \left( \frac{T_J - T_A}{R_{\theta JA}} \right) \times \left( \frac{\eta}{1 - \eta} \right) \times \left( \frac{1}{V_{OUT}} \right) \tag{15}$$

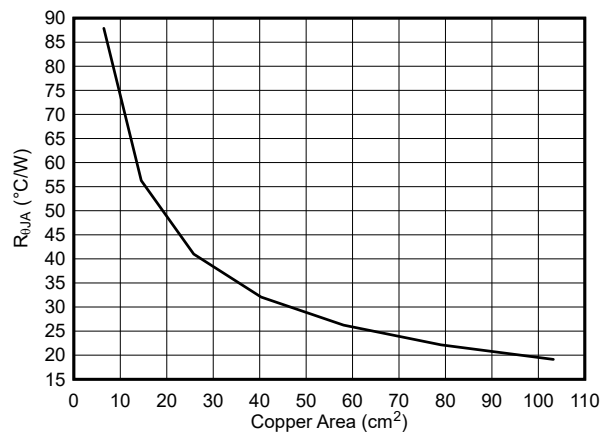
where

- $\eta$  = efficiency

The effective  $R_{\theta JA}$  is a critical parameter and depends on many factors such as the following:

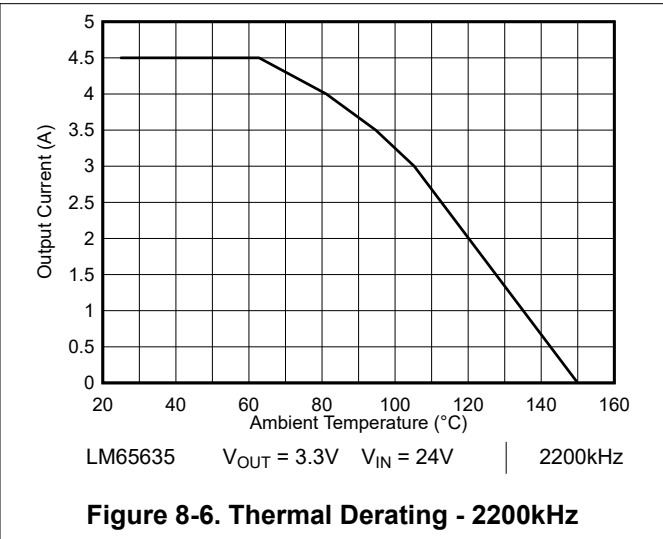
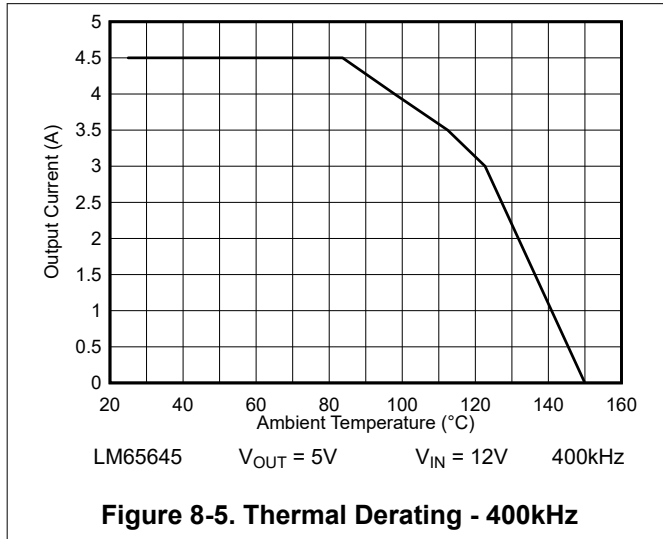
- Power dissipation
- Air temperature, flow
- PCB area
- Copper heat-sink area
- Number of thermal vias under the package
- Adjacent component placement

The advanced package used for this regulator features a die attach paddle, or "thermal pad" (DAP), to provide a place to solder down to the PCB heat-sinking copper. This feature provides a good heat conduction path from the regulator junction to the heat sink and must be properly soldered to the PCB heat sink copper. A typical curve of  $R_{\theta JA}$  versus copper board area can be found in Figure 8-4. The copper area given in the graph is for each layer. The top and bottom layers are 2oz copper each, while the inner layers are 1oz. Remember that the data given in this graph is for illustration purposes only, and the actual performance in any given application depends on all of the previously mentioned factors. As one data point, the LM65645EVM exhibits an approximate  $R_{\theta JA}$  of about 24°C/W for a copper area of about 58cm<sup>2</sup>.



**Figure 8-4. Thermal Resistance vs Copper Area**

The graphs shown in [Figure 8-5](#) and [Figure 8-6](#) provide examples of typical thermal performance. The data is *only* valid for an  $R_{\theta JA}$  of approximately 20°C/W.

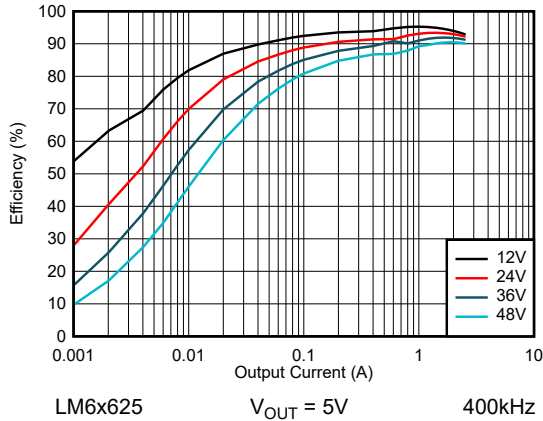


Use the following resources as guides to excellent thermal PCB design and estimating  $R_{\theta JA}$  for a given application environment:

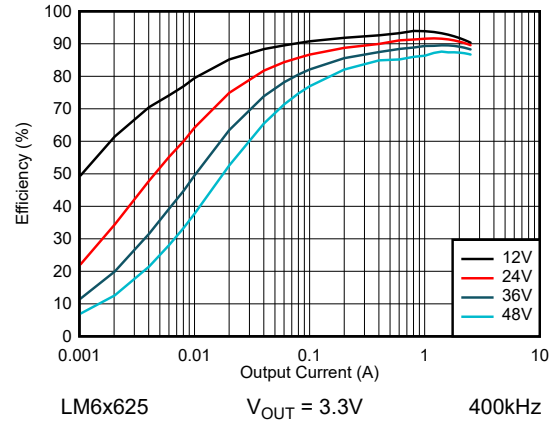
- [Thermal Design by Insight not Hindsight](#) application report
- [A Guide to Board Layout for Best Thermal Resistance for Exposed Pad Packages](#) application report
- [How to Properly Evaluate Junction Temperature with Thermal Metrics](#) application report

### 8.2.3 Application Curves

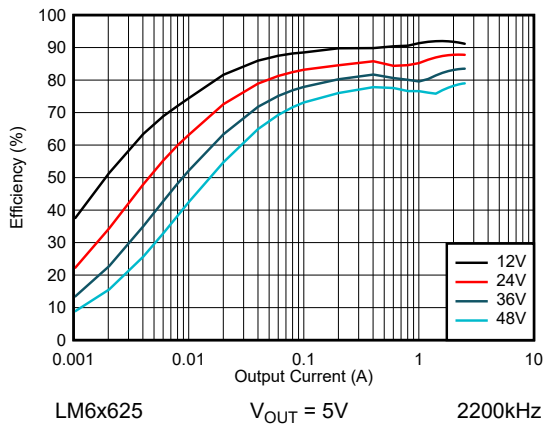
Unless otherwise specified the following conditions apply:  $V_{IN} = 24V$ , Fixed output voltage mode, BIAS connected to  $V_{OUT}$ ,  $T_A = 25^\circ C$ . All data taken on standard EVM. See [Table 8-6](#) for BOM. See [Figure 8-75](#) and [Figure 8-76](#) for typical EMI filters. Typical system specifications can be found in [Table 8-7](#)



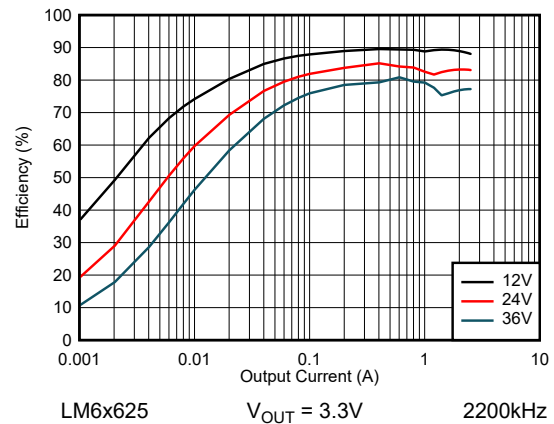
**Figure 8-7. LM6x625 Efficiency - Auto Mode**



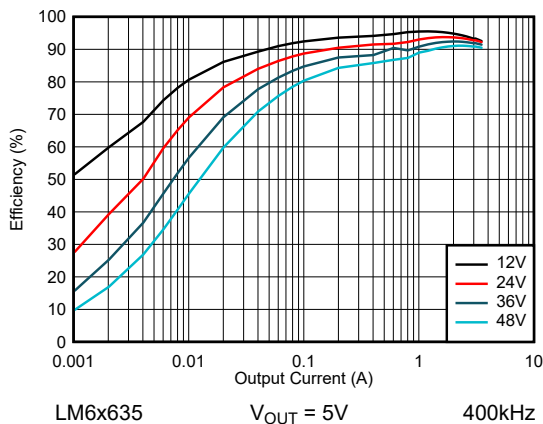
**Figure 8-8. LM6x625 Efficiency - Auto Mode**



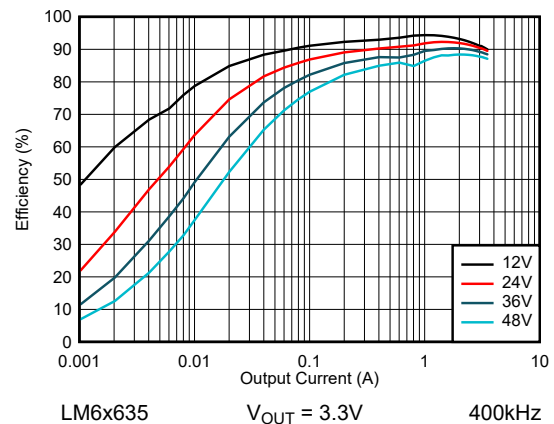
**Figure 8-9. LM6x625 Efficiency - Auto Mode**



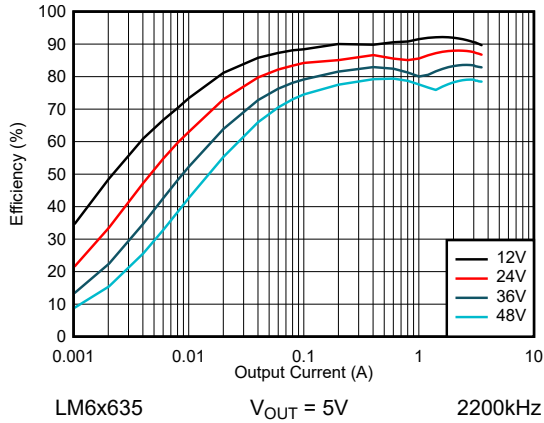
**Figure 8-10. LM6x625 Efficiency - Auto Mode**



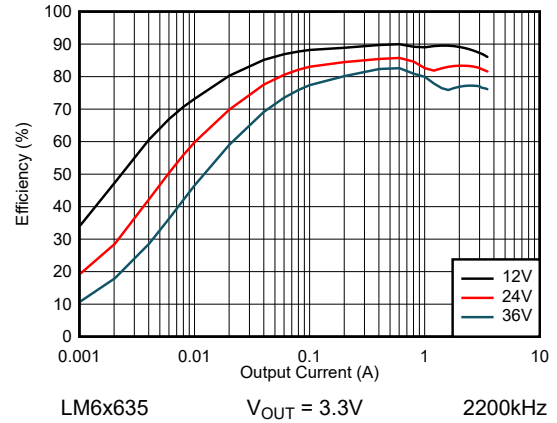
**Figure 8-11. LM6x635 Efficiency - Auto Mode**



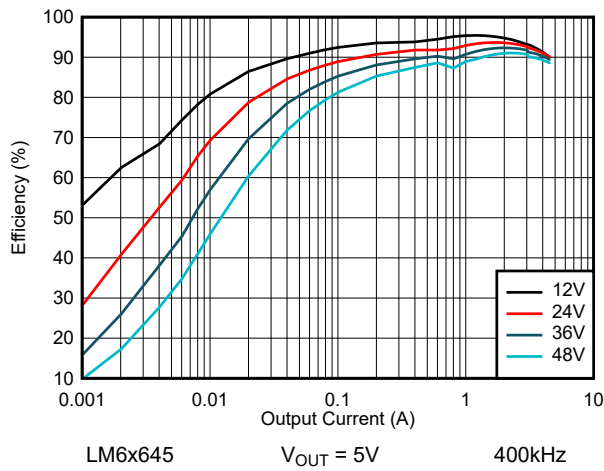
**Figure 8-12. LM6x635 Efficiency - Auto Mode**



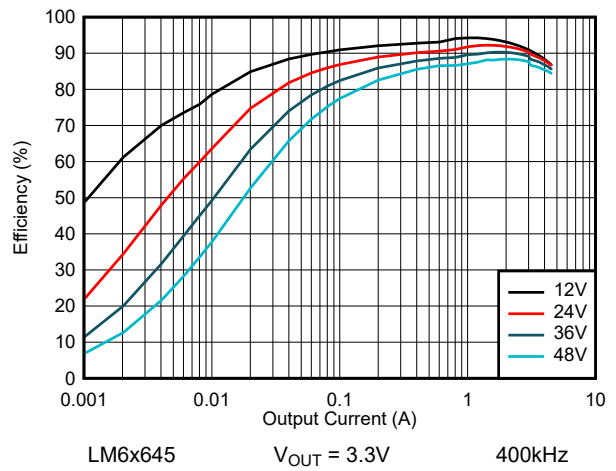
**Figure 8-13. LM6x635 Efficiency - Auto Mode**



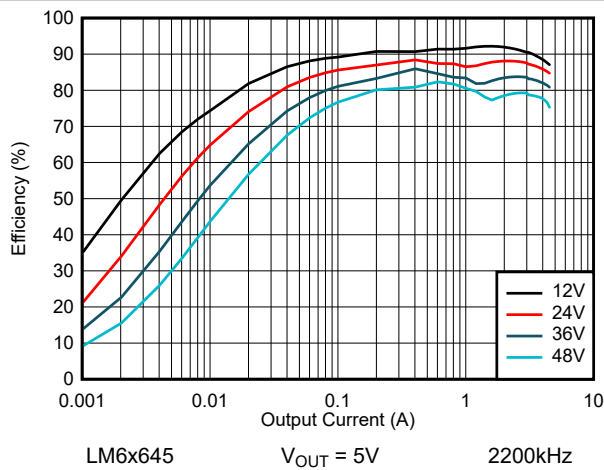
**Figure 8-14. LM6x635 Efficiency - Auto Mode**



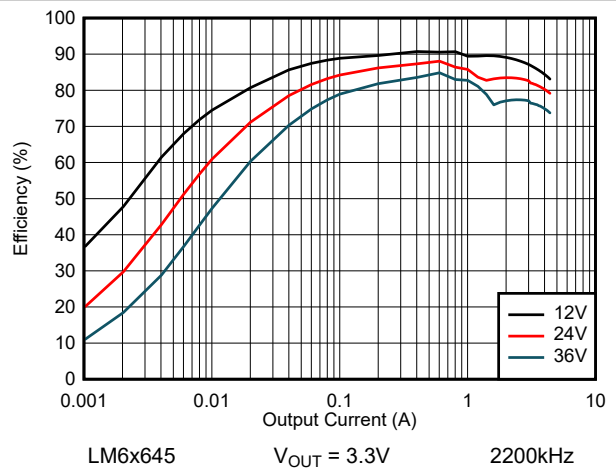
**Figure 8-15. LM6x645 Efficiency - Auto Mode**



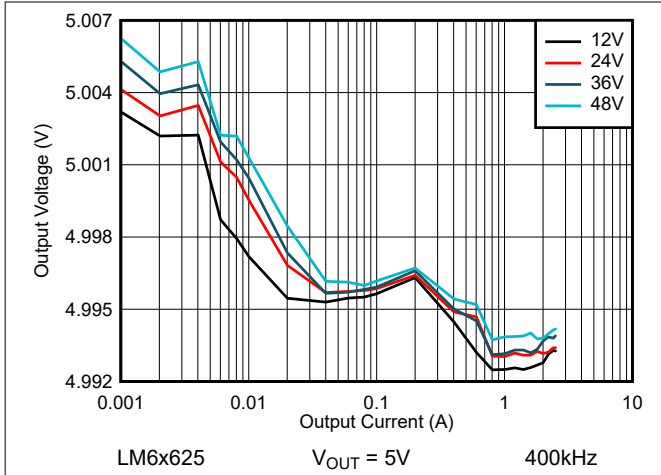
**Figure 8-16. LM6x645 Efficiency - Auto Mode**



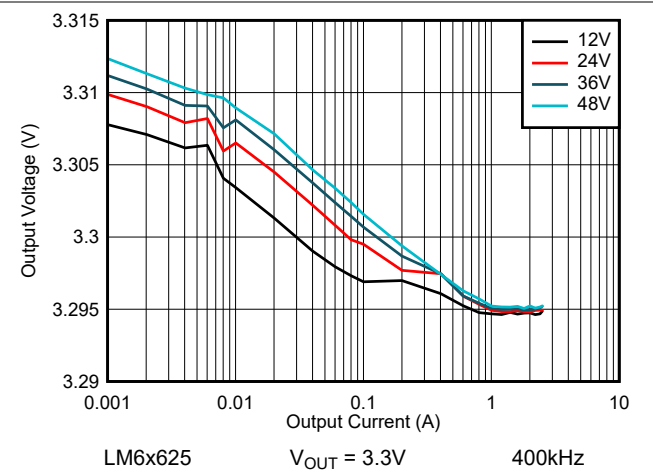
**Figure 8-17. LM6x645 Efficiency - Auto Mode**



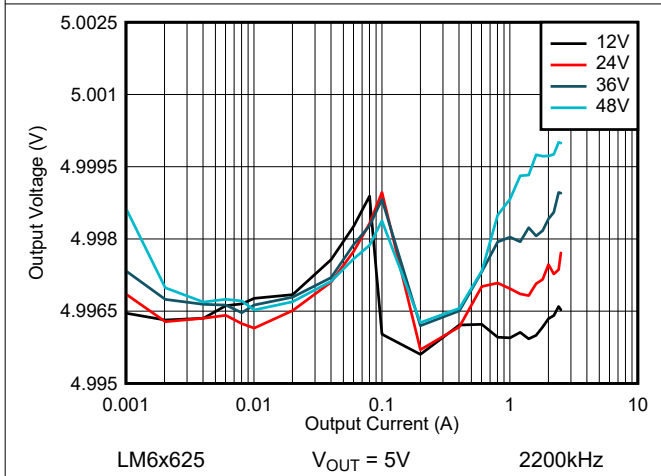
**Figure 8-18. LM6x645 Efficiency - Auto Mode**



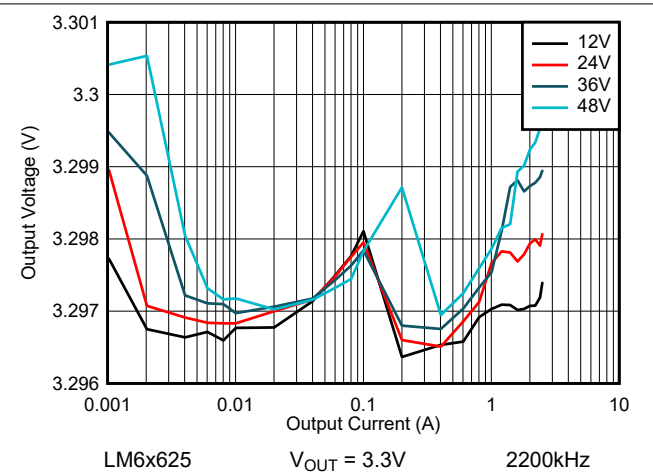
**Figure 8-19. LM6x625 Line and Load Regulation - Auto Mode**



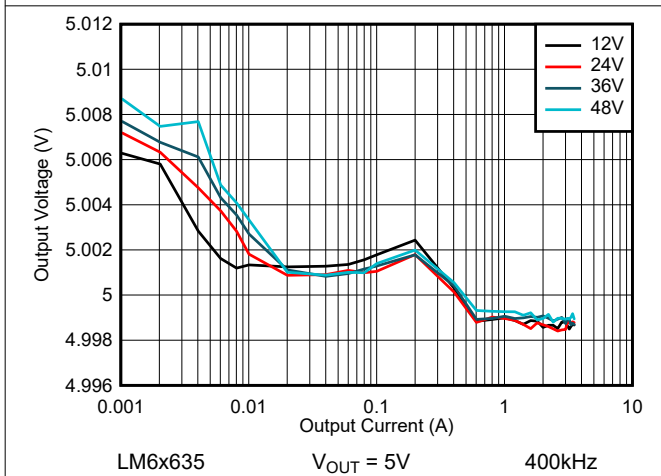
**Figure 8-20. LM6x625 Line and Load Regulation - Auto Mode**



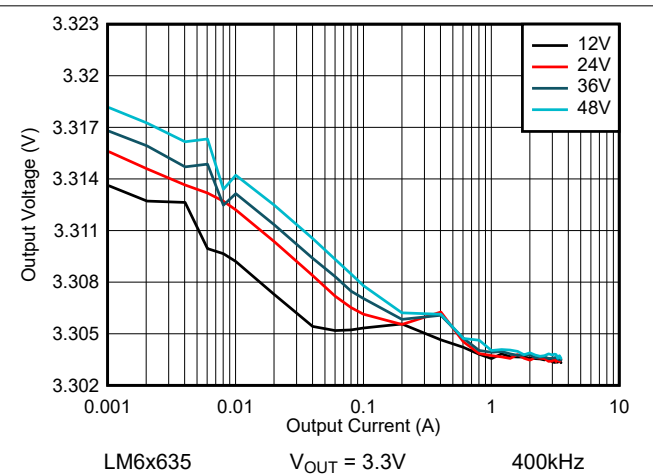
**Figure 8-21. LM6x625 Line and Load Regulation - Auto Mode**



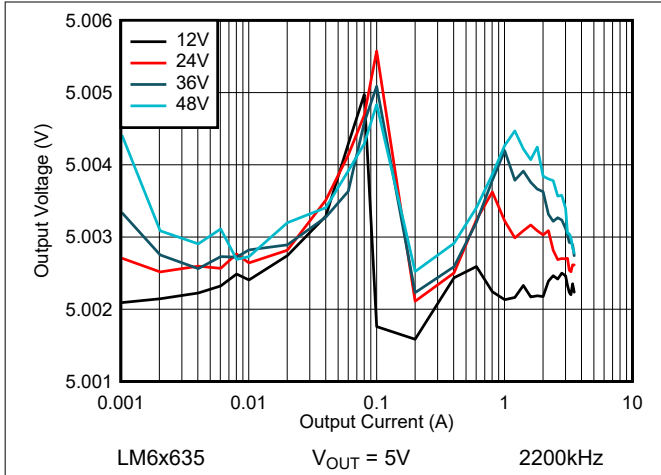
**Figure 8-22. LM6x625 Line and Load Regulation - Auto Mode**



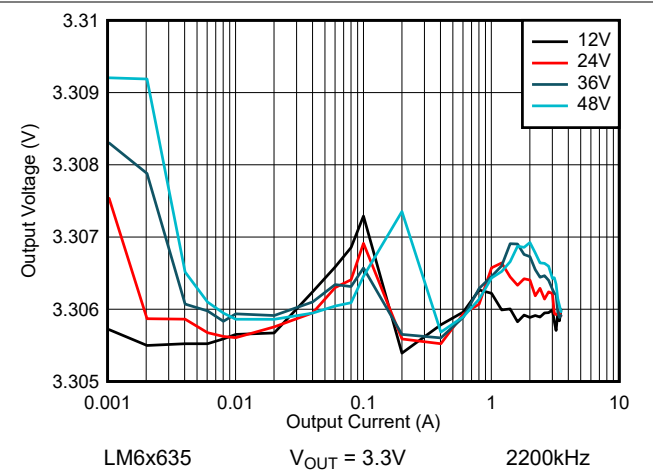
**Figure 8-23. LM6x635 Line and Load Regulation - Auto Mode**



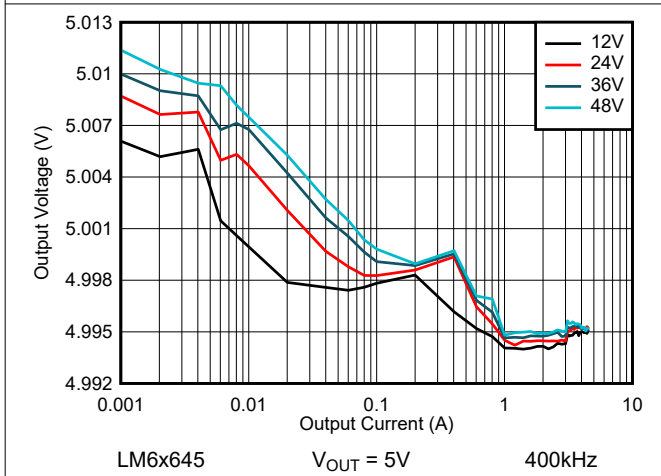
**Figure 8-24. LM6x635 Line and Load Regulation - Auto Mode**



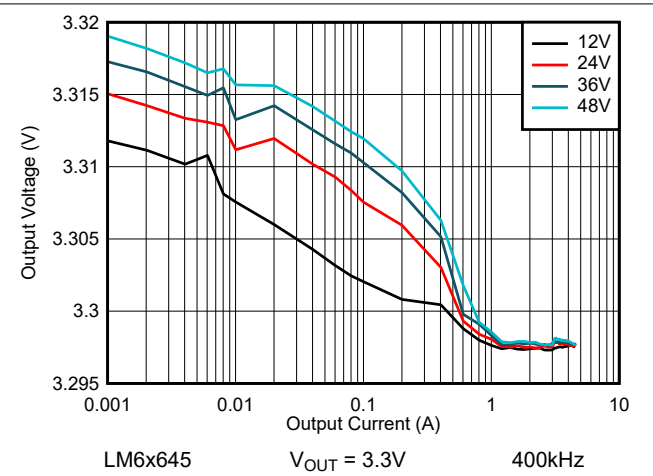
**Figure 8-25. LM6x635 Line and Load Regulation - Auto Mode**



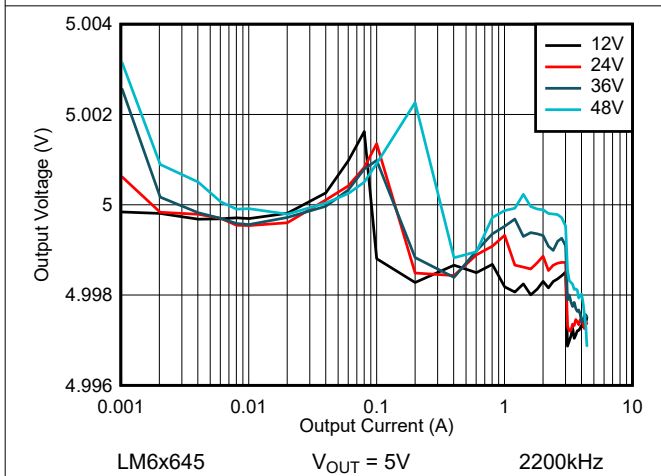
**Figure 8-26. LM6x635 Line and Load Regulation - Auto Mode**



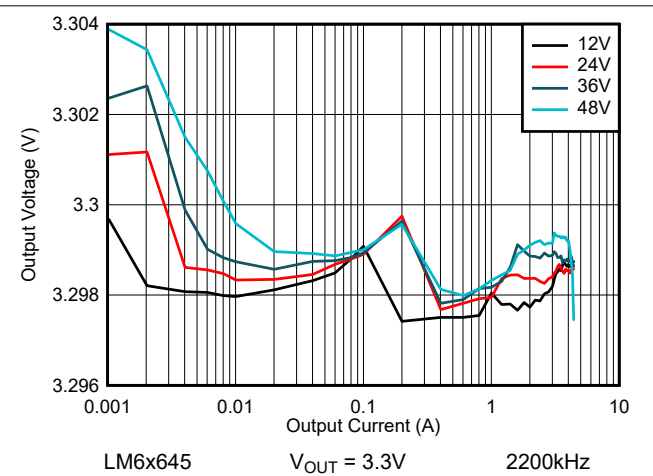
**Figure 8-27. LM6x645 Line and Load Regulation - Auto Mode**



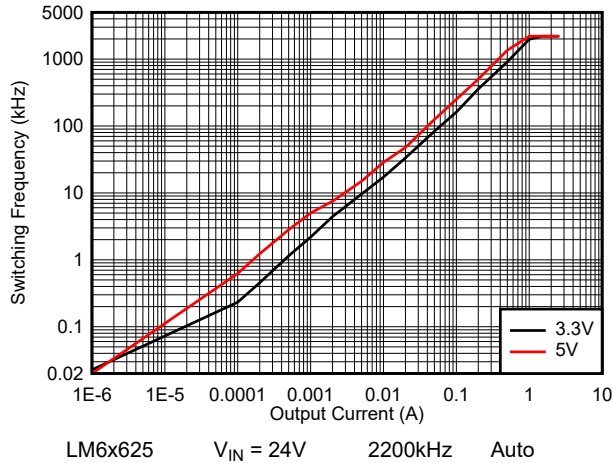
**Figure 8-28. LM6x645 Line and Load Regulation - Auto Mode**



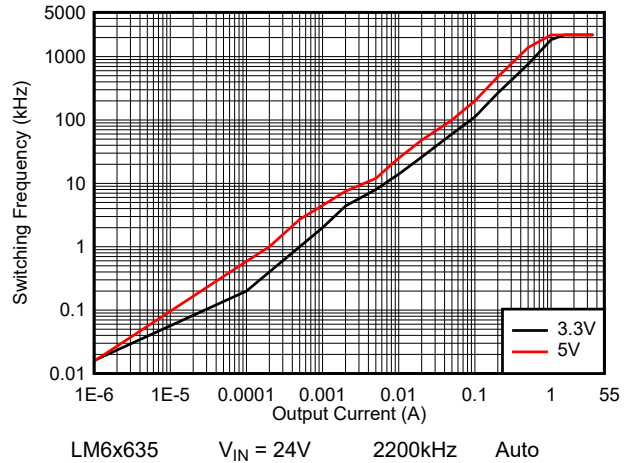
**Figure 8-29. LM6x645 Line and Load Regulation - Auto Mode**



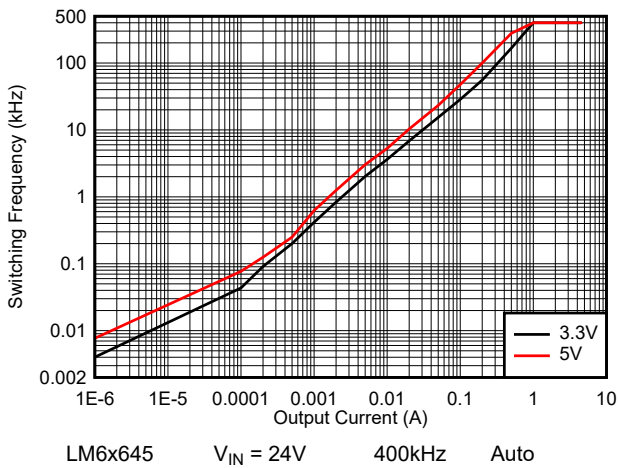
**Figure 8-30. LM6x645 Line and Load Regulation - Auto Mode**



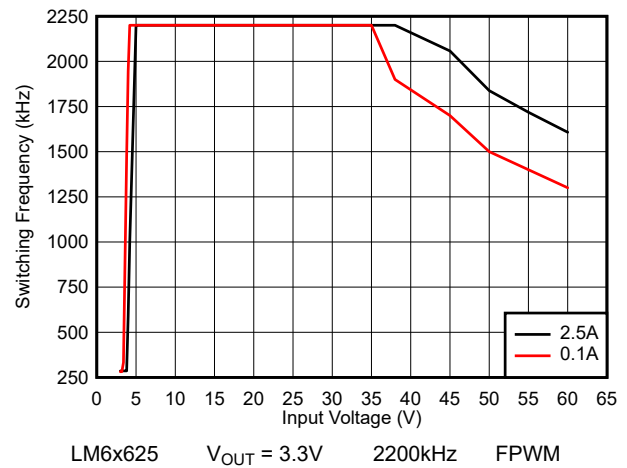
**Figure 8-31. LM6x625 Switching Frequency vs. Load Current**



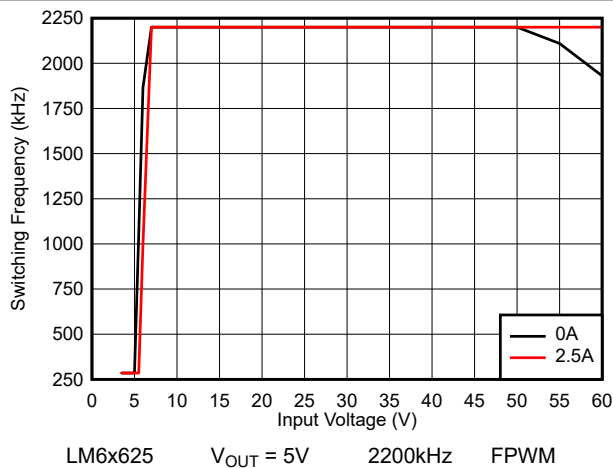
**Figure 8-32. LM6x635 Switching Frequency vs. Load Current**



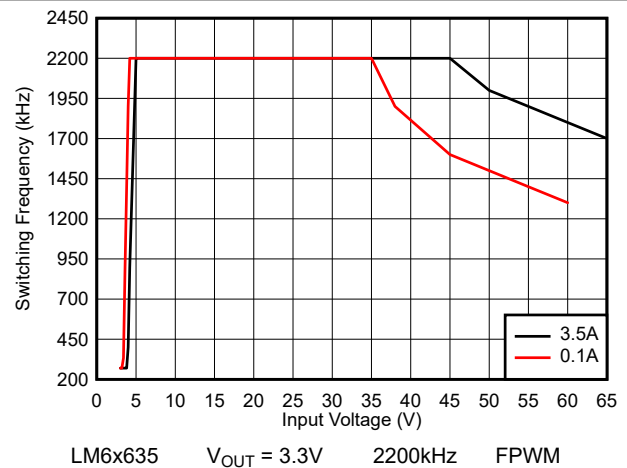
**Figure 8-33. LM6x645 Switching Frequency vs. Load Current**



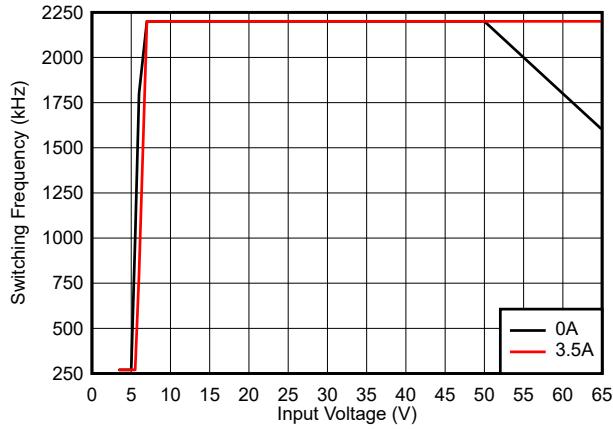
**Figure 8-34. LM6x625 Switching Frequency vs. Input Voltage**



**Figure 8-35. LM6x625 Switching Frequency vs. Input Voltage**

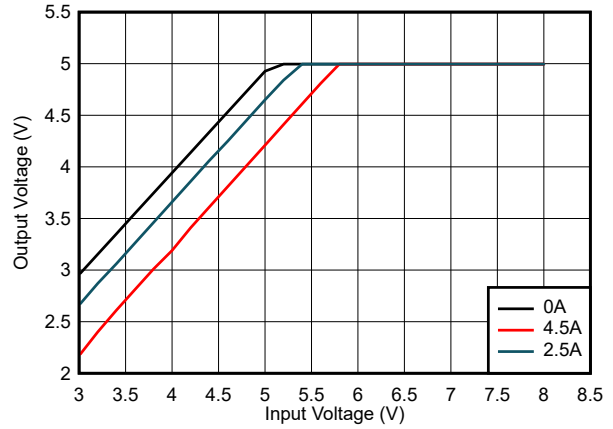


**Figure 8-36. LM6x635 Switching Frequency vs. Input Voltage**



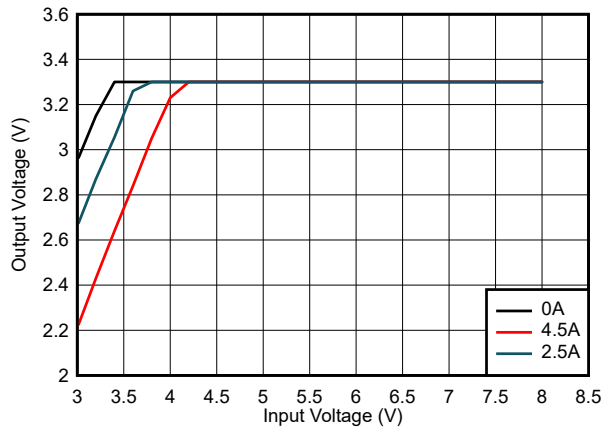
LM6x635  $V_{OUT} = 5V$  2200kHz FPWM

**Figure 8-37. LM6x635 Switching Frequency vs. Input Voltage**



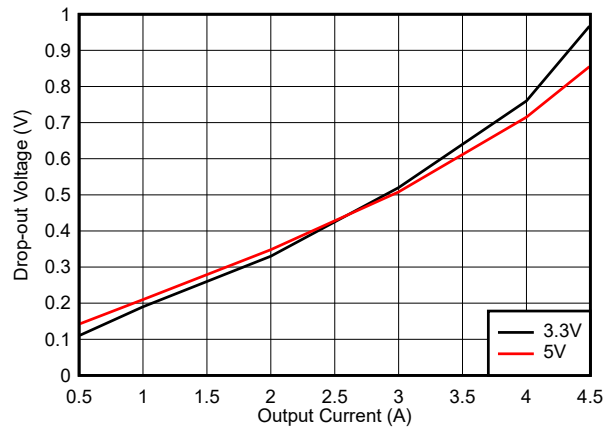
LM6x645  $V_{OUT} = 5V$  400kHz FPWM

**Figure 8-38. LM6x645 Dropout Characteristic**



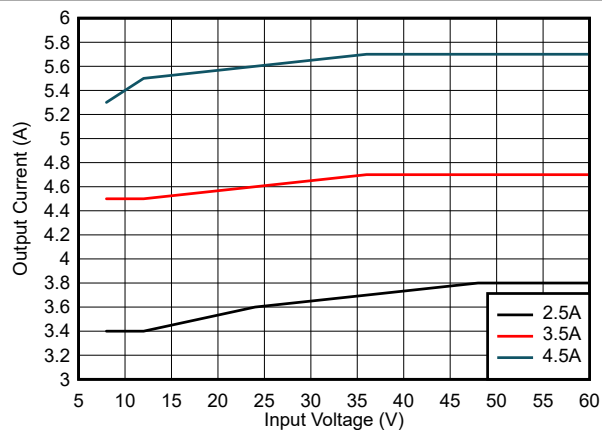
LM6x645  $V_{OUT} = 3.3V$  400kHz FPWM

**Figure 8-39. LM6x645 Dropout Characteristic**



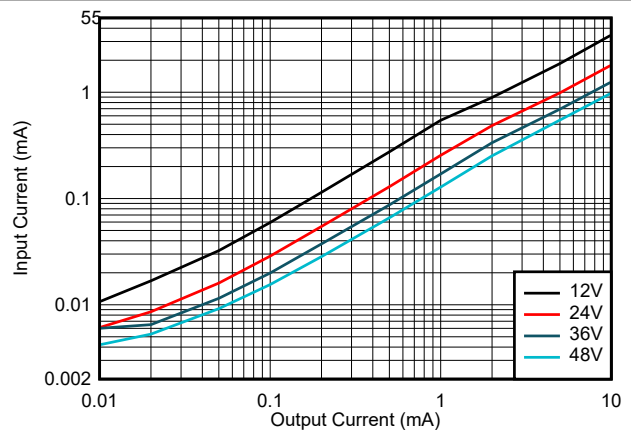
LM6x645 FPWM 400kHz

**Figure 8-40. LM6x645 Dropout Voltage**



$V_{OUT} = 2V$  FPWM 400kHz

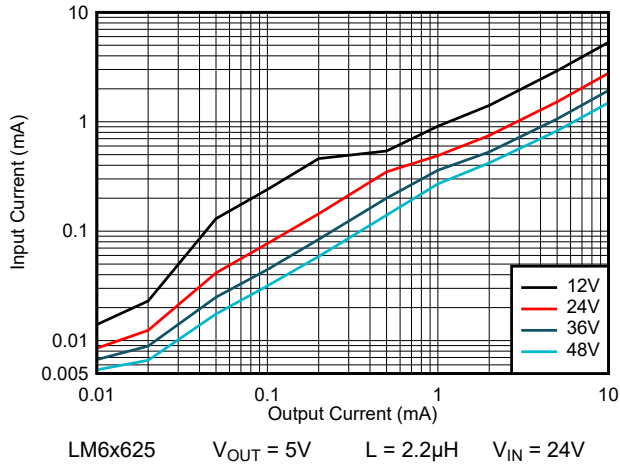
**Figure 8-41. Maximum Output Current**



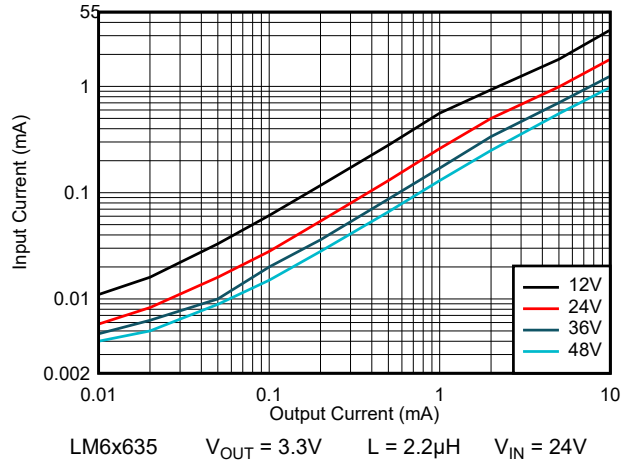
LM6x625  $V_{OUT} = 3.3V$   $L = 2.2\mu H$   $V_{IN} = 24V$

**Figure 8-42. Input Supply Current - Auto Mode**

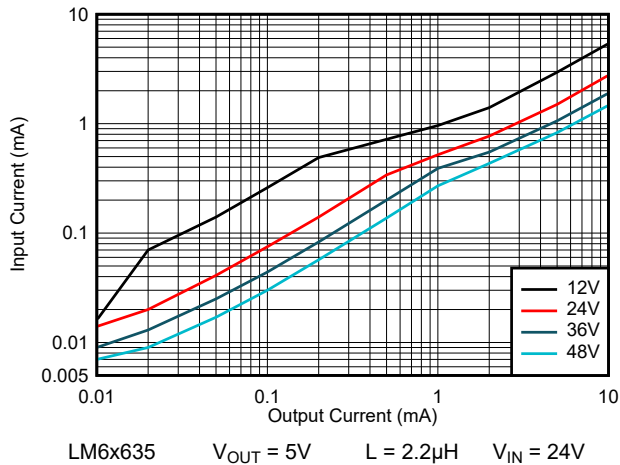




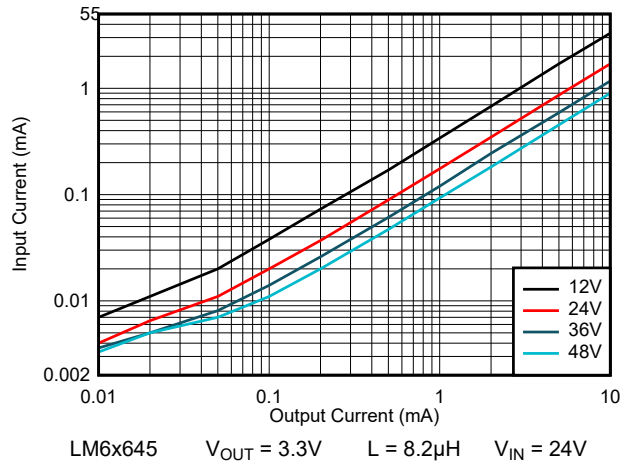
**Figure 8-43. Input Supply Current - Auto Mode**



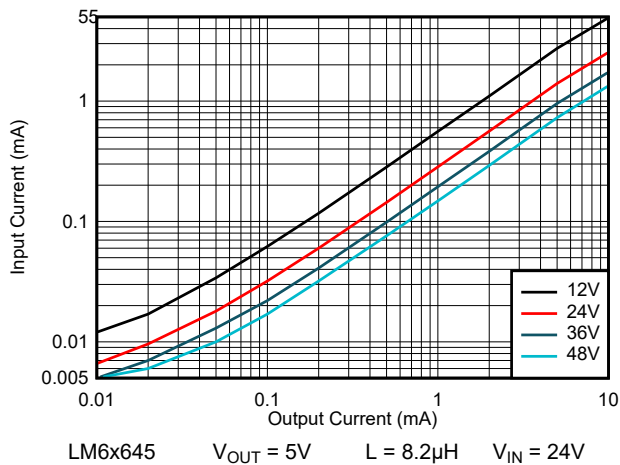
**Figure 8-44. Input Supply Current - Auto Mode**



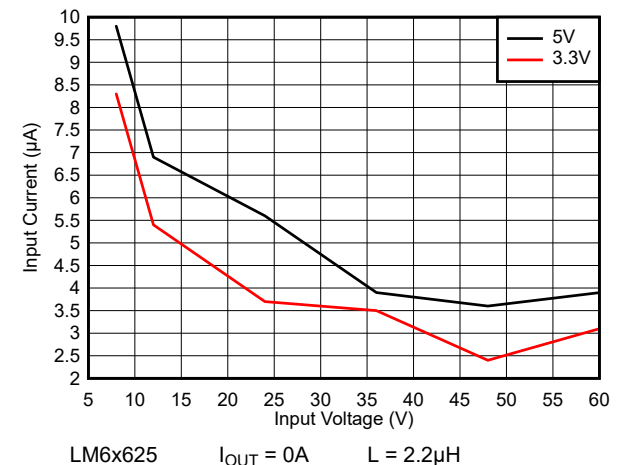
**Figure 8-45. Input Supply Current - Auto Mode**



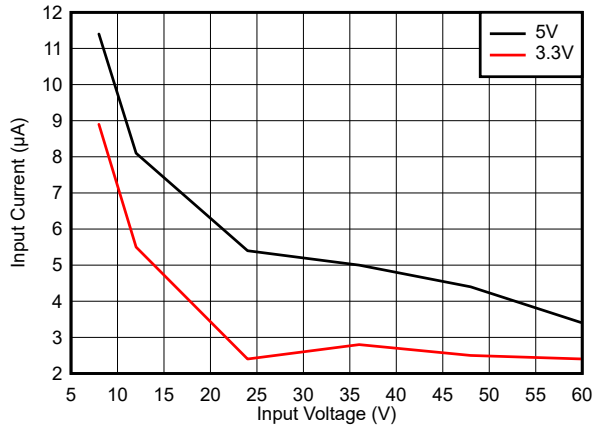
**Figure 8-46. Input Supply Current - Auto Mode**



**Figure 8-47. Input Supply Current - Auto Mode**

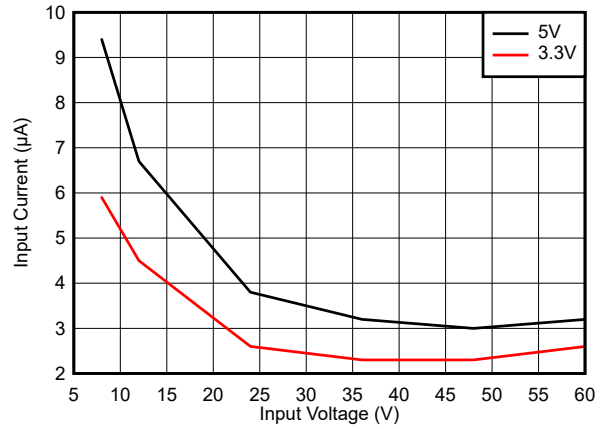


**Figure 8-48. No Load Input Supply Current - Auto Mode**



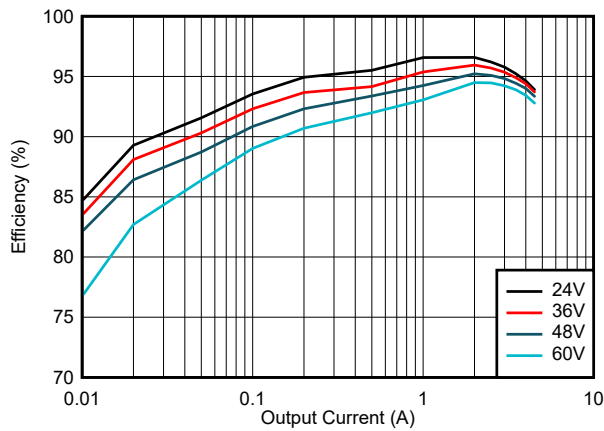
LM6x635  $I_{OUT} = 0A$   $L = 2.2\mu H$

**Figure 8-49. No Load Input Supply Current - Auto Mode**



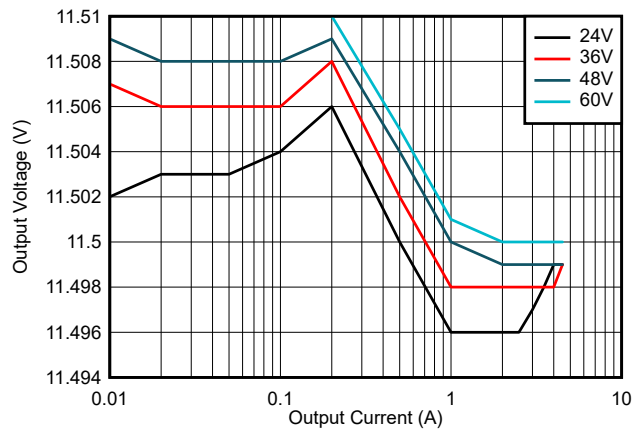
LM6x645  $I_{OUT} = 0A$   $L = 8.2\mu H$

**Figure 8-50. No Load Input Supply Current - Auto Mode**



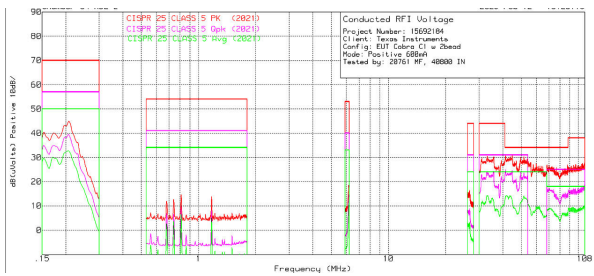
LM6x645  $V_{OUT} = 12V$  400kHz

**Figure 8-51. LM6x645 Efficiency -  $V_{OUT} = 12V$  - Auto Mode**



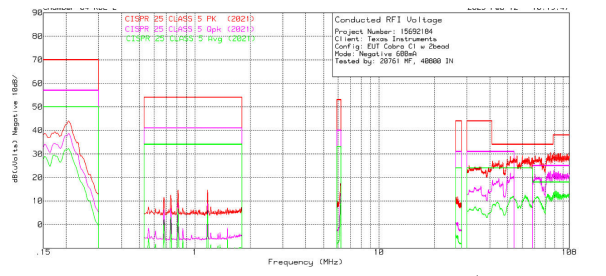
LM6x645  $V_{OUT} = 12V$  400kHz

**Figure 8-52. LM6x645 Line and Load Regulation -  $V_{OUT} = 12V$  - Auto Mode**



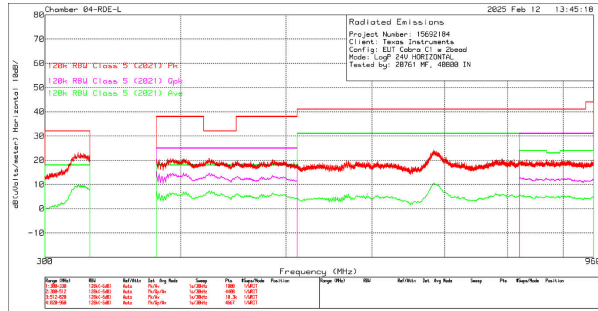
$V_{IN} = 24V$   $V_{OUT} = 5V$   $I_{OUT} = 3.5A$  | 2200kHz

**Figure 8-53. LM6x635 Conducted EMI - Positive Line**



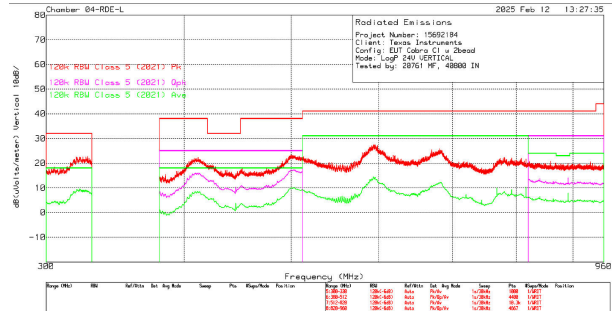
$V_{IN} = 24V$   $V_{OUT} = 5V$   $I_{OUT} = 3.5A$  | 2200kHz

**Figure 8-54. LM6x635 Conducted EMI - Negative Line**



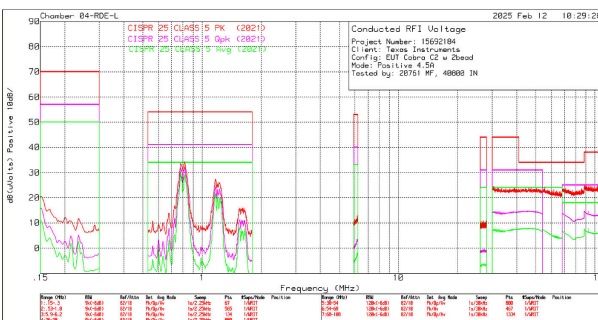
$V_{IN} = 24V$   $V_{OUT} = 5V$   $I_{OUT} = 3.5A$  | 2200kHz

**Figure 8-55. LM6x635 Radiated EMI - Log Periodic - Horizontal**



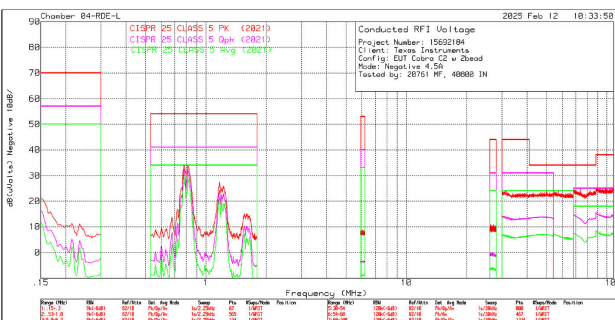
$V_{IN} = 24V$   $V_{OUT} = 5V$   $I_{OUT} = 3.5A$  | 2200kHz

**Figure 8-56. LM6x635 Radiated EMI - Log Periodic - Vertical**



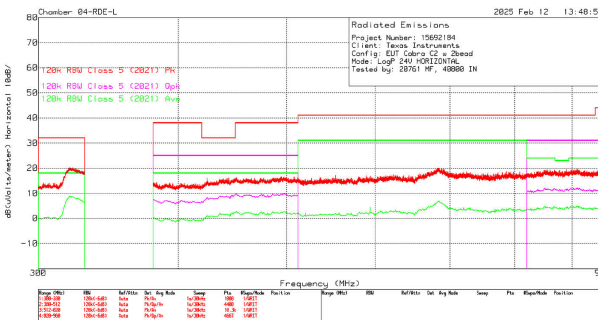
$V_{IN} = 24V$   $V_{OUT} = 5V$   $I_{OUT} = 4.5A$  | 400kHz

**Figure 8-57. LM6x645 Conducted EMI - Positive Line**



$V_{IN} = 24V$   $V_{OUT} = 5V$   $I_{OUT} = 4.5A$  | 400kHz

**Figure 8-58. LM6x645 Conducted EMI - Negative Line**



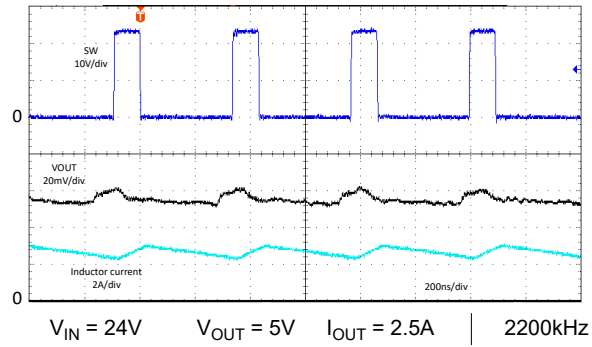
$V_{IN} = 24V$   $V_{OUT} = 5V$   $I_{OUT} = 4.5A$  | 400kHz

**Figure 8-59. LM6x645 Radiated EMI - Log Periodic - Horizontal**

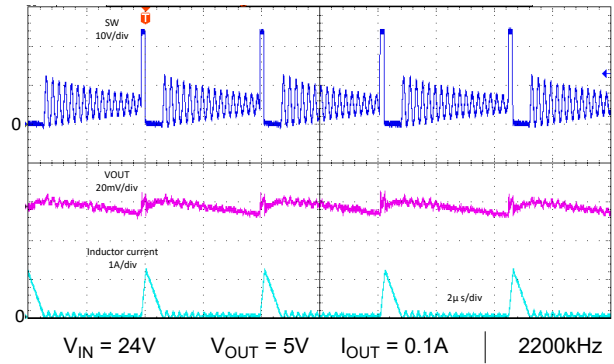


$V_{IN} = 24V$   $V_{OUT} = 5V$   $I_{OUT} = 4.5A$  | 400kHz

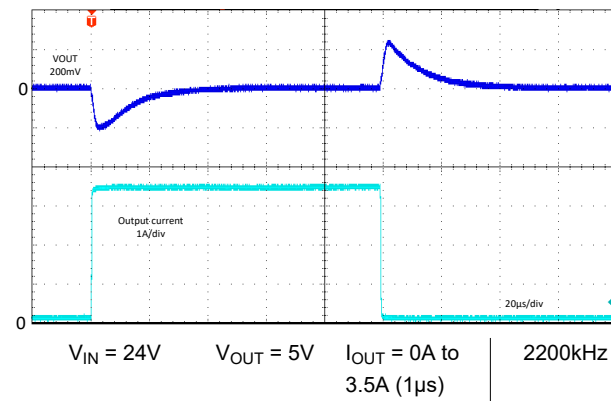
**Figure 8-60. LM6x645 Radiated EMI - Log Periodic - Vertical**



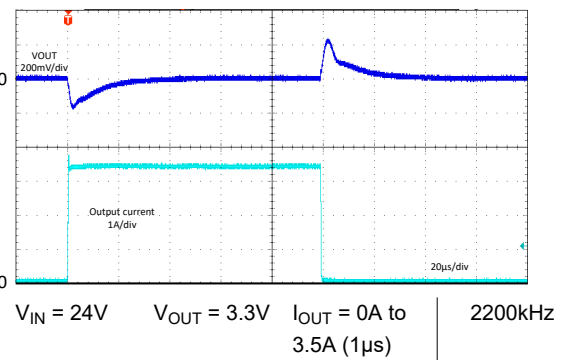
**Figure 8-61. Typical Switching Waveforms - LM6x625 - FPWM**



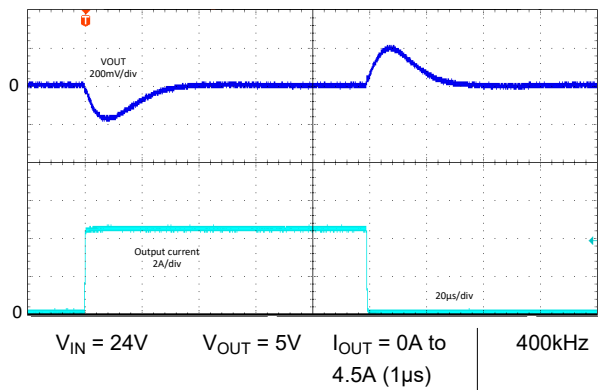
**Figure 8-62. Typical Switching Waveforms - LM6x625 - Auto**



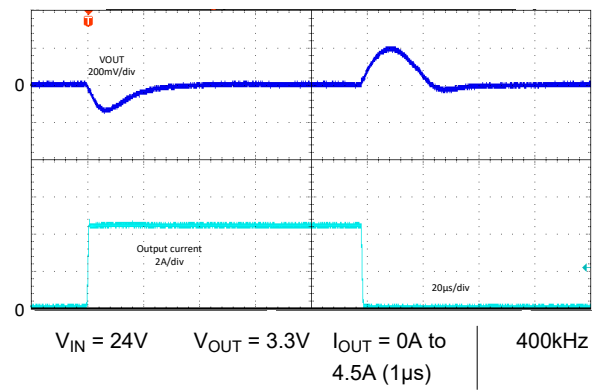
**Figure 8-63. Load Transient - LM6x635 - FPWM**



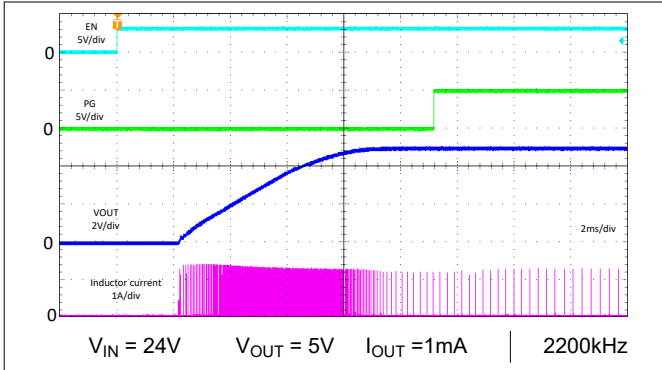
**Figure 8-64. Load Transient - LM6x635 - Auto**



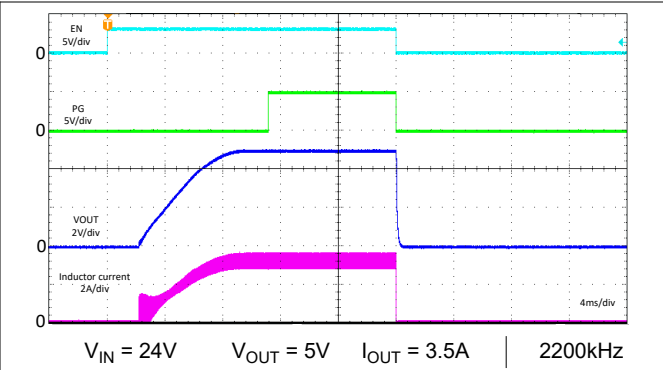
**Figure 8-65. Load Transient - LM6x645 - FPWM**



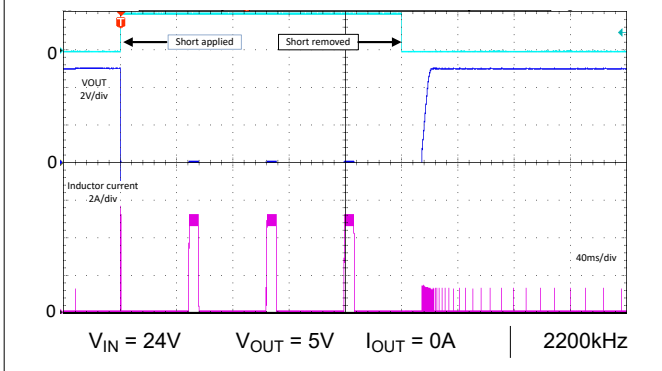
**Figure 8-66. Load Transient - LM6x645 - Auto**



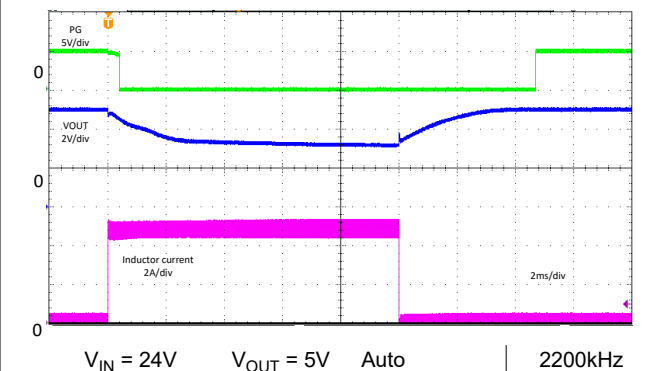
**Figure 8-67. Start-up - Auto**



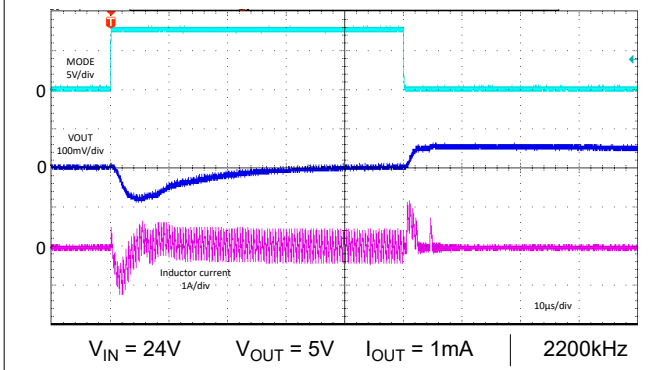
**Figure 8-68. Start-up/Shutdown - FPWM**



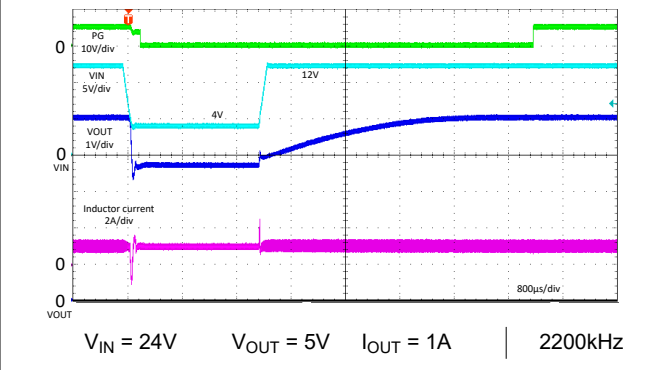
**Figure 8-69. Output Short Circuit and Recovery - Auto**



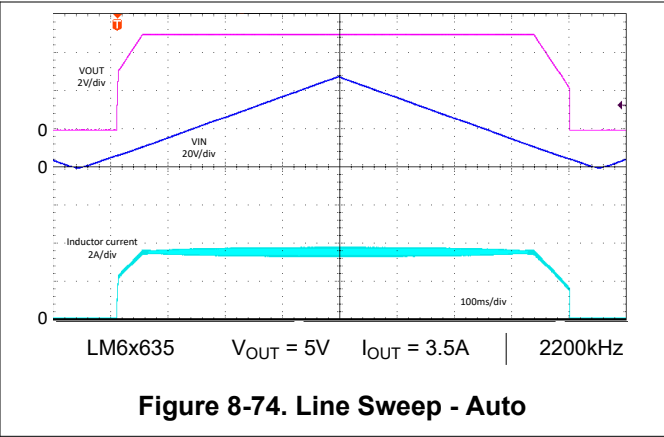
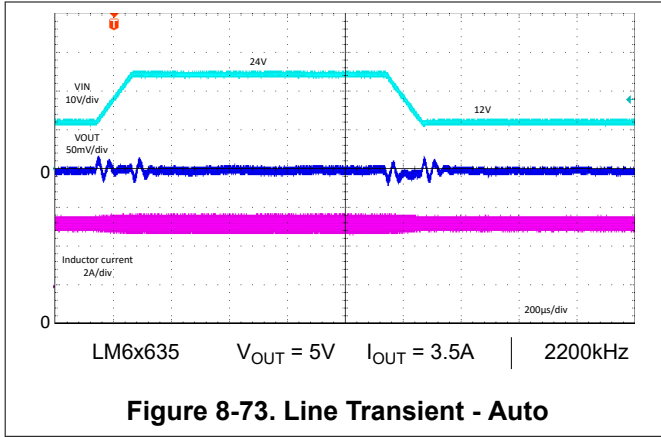
**Figure 8-70. Current Limit Transient**



**Figure 8-71. MODE Change Transient**

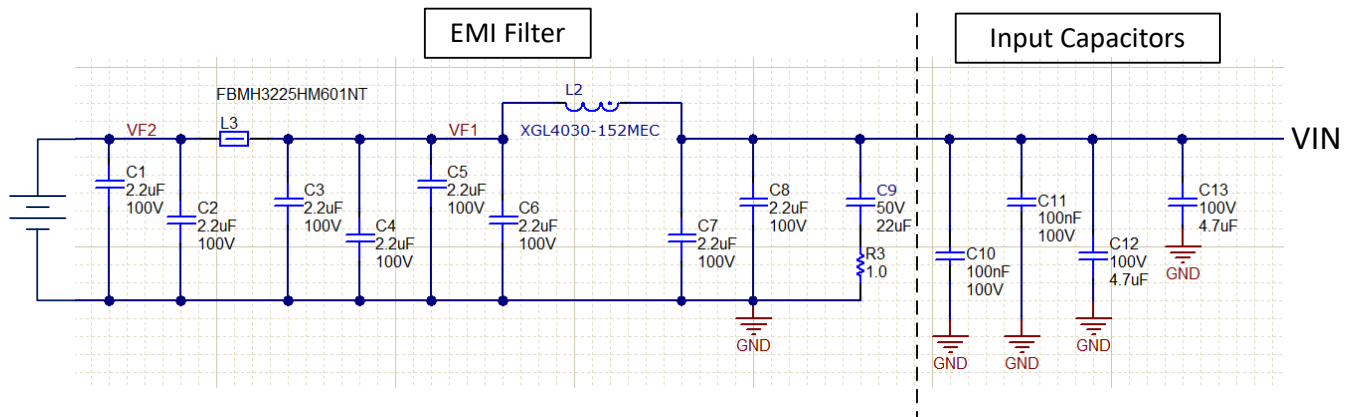


**Figure 8-72. Dropout Transient and Recovery**

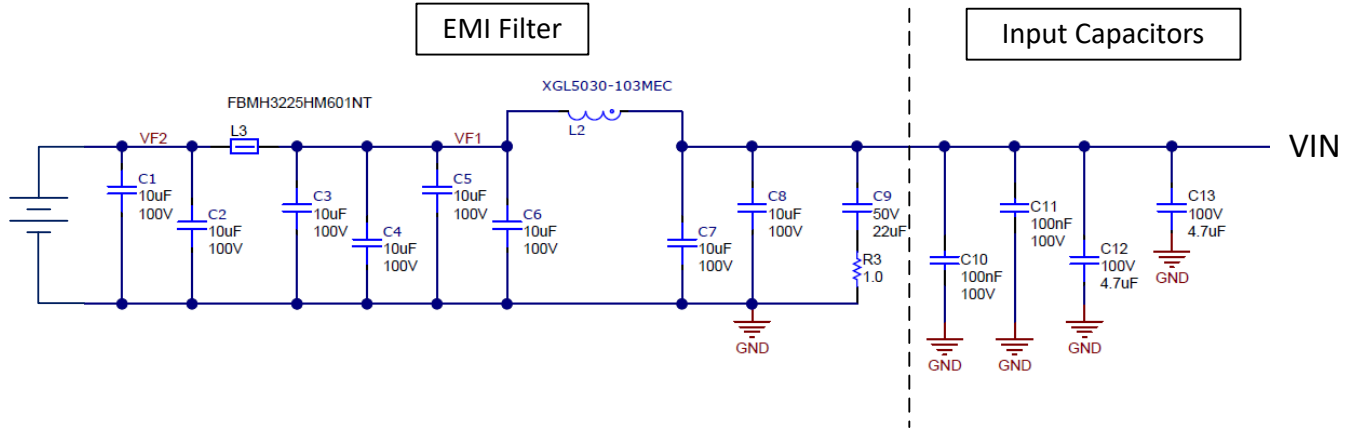


**Table 8-6. BOM for Application Curve Data**

DEVICE	OUTPUT VOLTAGE	SWITCHING FREQUENCY	INDUCTOR	INDUCTOR D.C.R.	C <sub>OUT</sub> AT V <sub>OUT</sub> (FOR TRANSIENT TESTS)
LM6x625	5V	400kHz	10μH	0.03Ω	
LM6x625	5V	2200kHz	2.2μH	0.02Ω	
LM6x625	3.3V	400kHz	10μH	0.03Ω	
LM6x625	3.3V	2200kHz	2.2μH	0.02Ω	
LM6x635	5V	400kHz	8.2μH	0.016Ω	
LM6x635	5V	2200kHz	2.2μH	0.018Ω	23μF
LM6x635	3.3V	400kHz	8.2μH	0.016Ω	
LM6x635	3.3V	2200kHz	2.2μH	0.018Ω	27μF
LM6x645	5V	400kHz	8.2μH	0.016Ω	91μF
LM6x645	5V	2200kHz	2.2μH	0.018Ω	
LM6x645	3.3V	400kHz	8.2μH	0.016Ω	120μF
LM6x645	3.3V	2200kHz	2.2μH	0.018Ω	
LM6x645	5V	1000kHz	3.3μH	0.012Ω	
LM6x645	3.3V	1000kHz	3.3μH	0.012Ω	
LM6x635	5V	1000kHz	4.7μH	0.014Ω	
LM6x635	3.3V	1000kHz	4.7μH	0.014Ω	
LM6x625	5V	1000kHz	6.8μH	0.021Ω	
LM6x625	3.3V	1000kHz	6.8μH	0.021Ω	
LM6x645	12V	400kHz	15μH	0.043Ω	



**Figure 8-75. EMI Input Filter for 2200kHz**



**Figure 8-76. EMI Input Filter for 400kHz**

The data in the [Table 8-7](#) table apply only to the typical applications circuit, with nominal component values. Specifications in the typical (TYP) column apply to  $T_J = 25^\circ\text{C}$  only. Specifications in the minimum (MIN) and maximum (MAX) columns apply to the case of typical components over the temperature range of  $T_J = -40^\circ\text{C}$  to  $150^\circ\text{C}$ . These specifications are not specified by production testing.

**Table 8-7. Typical System Specifications**

PARAMETERS		TEST CONDITIONS	MIN	TYP	MAX	UNITS
$I_{\text{supply}}$	Input supply current	$V_{\text{in}} = 24\text{V}$ , $V_{\text{out}} = 3.3\text{V}$ , $I_{\text{out}} = 0\text{A}$ , LM65635, 2.2MHz		2.4		$\mu\text{A}$
$V_{\text{out}}$	$V_{\text{out}} = 5\text{V}$	$V_{\text{in}} = 7\text{V}$ to $65\text{V}$ , $I_{\text{out}} = 0\text{A}$ to full load, FPWM	-1.5%		+1.5%	
	$V_{\text{out}} = 5\text{V}$	$V_{\text{in}} = 7\text{V}$ to $65\text{V}$ , $I_{\text{out}} = 0\text{A}$ to full load, AUTO	-1.5%		+2.5%	
$V_{\text{out}}$	$V_{\text{out}} = 3.3\text{V}$	$V_{\text{in}} = 5\text{V}$ to $65\text{V}$ , $I_{\text{out}} = 0\text{A}$ to full load, FPWM	-1.5%		+1.5%	
	$V_{\text{out}} = 3.3\text{V}$	$V_{\text{in}} = 5\text{V}$ to $65\text{V}$ , $I_{\text{out}} = 0\text{A}$ to full load, AUTO	-1.5%		+2.5%	
$\eta$	Peak efficiency	$V_{\text{in}} = 12\text{V}$ , $V_{\text{out}} = 5\text{V}$ , $I_{\text{out}} = 1.5\text{A}$ , LM65645, 400kHz		95%		
		$V_{\text{in}} = 24\text{V}$ , $V_{\text{out}} = 5\text{V}$ , $I_{\text{out}} = 1.5\text{A}$ , LM65645, 400kHz		93.6%		



## 8.3 Best Design Practices

- Do not exceed the [Absolute Maximum Ratings](#).
- Do not exceed the [Recommended Operating Conditions](#).
- Do not exceed the [ESD Ratings](#).
- Do not allow the EN input to float.
- Do not allow the output voltage to exceed the input voltage, nor go below ground.
- Follow all the guidelines and suggestions found in this data sheet before committing the design to production. TI application engineers are ready to help critique design and PCB layout to help make a project a success.

## 8.4 Power Supply Recommendations

The characteristics of the input supply must be capable of delivering the required input current to the loaded regulator. The average input current can be estimated with [Equation 16](#).

$$I_{IN} = \frac{V_{IN}}{V_{OUT}} \times \frac{I_{OUT}}{\eta} \quad (16)$$

where

$\eta$  is the efficiency.

If the regulator is connected to the input supply through long wires or PCB traces, special care is required to achieve good performance. The parasitic inductance and resistance of the input cables can have an adverse effect on the operation of the regulator. The parasitic inductance, in combination with the low-ESR ceramic input capacitors, can form an underdamped resonant circuit. This action can result in overvoltage transients at the input to the regulator or tripping UVLO. Consider that the supply voltage can dip when a load transient is applied to the output depending on the parasitic resistance and inductance of the harness and characteristics of the supply. If the application is operating close to the minimum input voltage, this dip can cause the regulator to momentarily shut down and reset. The best way to solve these kinds of issues is to reduce the distance from the input supply to the regulator. Additionally, use an aluminum input capacitor in parallel with the ceramics. The moderate ESR of this type of capacitor helps damp the input resonant circuit and reduce any overshoots or undershoots. A value in the range of 20 $\mu$ F to 100 $\mu$ F is usually sufficient to provide input damping and help hold the input voltage steady during large load transients.

In some cases, a transient voltage suppressor (TVS) is used on the input of regulators. One class of this device has a snap-back characteristic (thyristor type). TI does not recommend to use a device with this type of characteristic. When the TVS fires, the clamping voltage falls to a very low value. If this voltage is less than the output voltage of the regulator, the output capacitors discharge through the device back to the input. This uncontrolled current flow can damage the device.

The input voltage must not be allowed to fall below the output voltage. In this scenario, such as a shorted input test, the output capacitors discharge through the internal parasitic diode found between the VIN and SW pins of the device. During this condition, the current can become uncontrolled, possibly causing damage to the device. If this scenario is considered likely, then use a Schottky diode between the input supply and the output.

## 8.5 Layout

### 8.5.1 Layout Guidelines

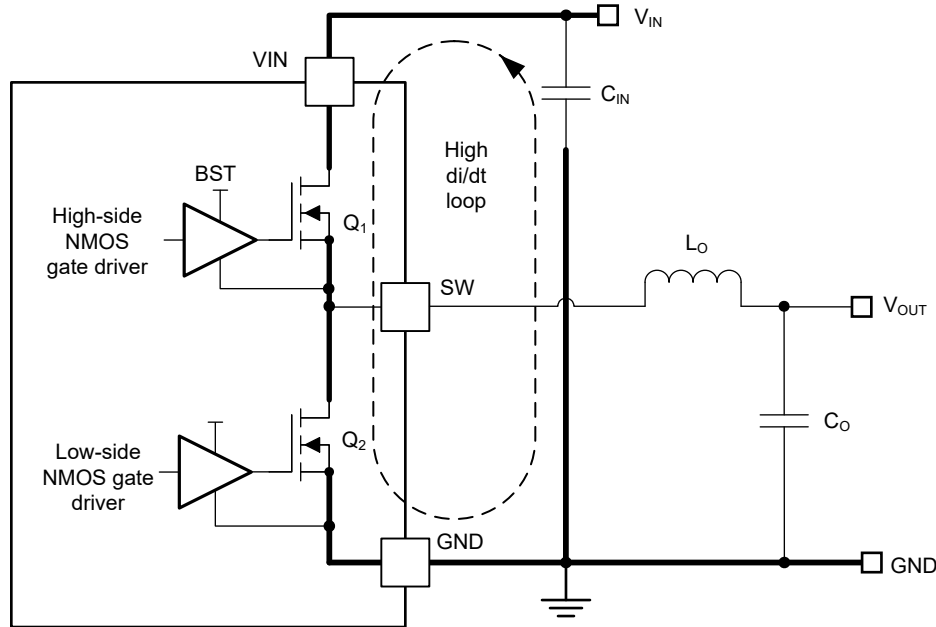
The PCB layout of any DC/DC converter is critical to the excellent performance of the design. Bad PCB layout can disrupt the operation of an otherwise good schematic design. Even if the converter regulates correctly, bad PCB layout can mean the difference between a robust design and one that cannot be mass produced. Furthermore, the EMI performance of the regulator is dependent on the PCB layout, to a great extent. In a buck converter, the most critical PCB feature is the loop formed by the input capacitor or input capacitors, and power ground, as shown in [Figure 8-77](#). This loop carries large transient currents that can cause large transient voltages when reacting with the trace inductance. These unwanted transient voltages disrupt the proper operation of the converter. Because of this, the traces in this loop must be wide and short, and the loop area as small as possible

to reduce the parasitic inductance. [Section 8.5.2](#) shows a recommended layout for the critical components of the LM656x5-Q1.

- *Place the input capacitors as close as possible to the VIN pins and connect to ground through a short wide trace.*
- *Apply the symmetrical input capacitors technique* as shown in the LM65645EVM
- *Use wide traces for the  $C_{BOOT}$  capacitor.* Place  $C_{BOOT}$  close to the device with short/wide traces to the BOOT and SW pins. The BOOT and SW pins are adjacent which simplifies the  $C_{BOOT}$  capacitor placement.
- *Place the feedback divider as close as possible to the FB pin of the device.* Place  $R_{FBB}$ ,  $R_{FBT}$ , and  $C_{FF}$ , if used, physically close to the device. The connections to FB and GND must be short and close to those pins on the device. The connection to  $V_{OUT}$  can be somewhat longer. However, this latter trace must not be routed near any noise sources (such as the SW node) that can capacitively couple into the feedback path of the regulator.
- *Use at least one ground plane in one of the middle layers.* This plane acts as a noise shield and also act as a heat dissipation path.
- *Connect the thermal pad to the ground plane.* The WQFN package has a thermal pad (PAD) connection that can be soldered down to the PCB ground plane. This pad acts as a heat-sink connection. The integrity of this solder connection has a direct bearing on the total effective  $R_{\theta JA}$  of the application.
- *Provide wide planes for VIN, VOUT, and GND.* Making these paths as wide and direct as possible reduces any voltage drops on the input or output paths of the converter and maximizes efficiency.
- *Provide enough PCB area for proper heat sinking.* Enough copper area must be used to keep a low  $R_{\theta JA}$ , commensurate with the maximum load current and ambient temperature. Make the top and bottom PCB layers with two-ounce copper; and no less than one ounce. With the WQFN package, use at least six heat-sinking vias to connect the thermal pad (PAD) to the ground plane on the bottom PCB layer. If the PCB design uses multiple copper layers (recommended), thermal vias can also be connected to the inner layer heat-spreading ground planes.
- *Keep switch area small.* Keep the copper area connecting the SW pin to the inductor as short and wide as possible. At the same time the total area of this node must be minimized to help reduce radiated EMI.

See the following PCB layout resources for additional important guidelines:

- [Layout Guidelines for Switching Power Supplies application report](#)
- [Simple Switcher PCB Layout Guidelines application report](#)
- [Construction Your Power Supply- Layout Considerations seminar](#)
- [Low Radiated EMI Layout Made Simple with LM4360x and LM4600x application report](#)



**Figure 8-77. Current Loops With Fast Edges**

#### 8.5.1.1 Ground and Thermal Considerations

As mentioned above, TI recommends using one of the middle layers as a solid ground plane. A ground plane provides shielding for sensitive circuits and traces. A ground plane also provides a quiet reference potential for the control circuitry. PGND pins are connected directly to the source of the low-side MOSFET switch, and also connected directly to the grounds of the input and output capacitors. The PGND net contains noise at the switching frequency and can bounce due to load variations. The PGND trace, as well as the VIN and SW traces, must be constrained to one side of the ground planes. The other side of the ground plane contains much less noise and must be used for sensitive routes.

TI recommends providing adequate device heat sinking by using the thermal pad (PAD) of the device as the primary thermal path. Use a minimum of six 10mil thermal vias to connect the PAD to the system ground plane heat sink. The vias must be evenly distributed under the PAD. Use as much copper as possible, for system ground plane, on the top and bottom layers for the best heat dissipation. Use a four-layer board with the copper thickness for the four layers, starting from the top as: 2oz / 1oz / 1oz / 2oz. A four-layer board with enough copper thickness, and proper layout, provides low current conduction impedance, proper shielding, and lower thermal resistance.

### 8.5.2 Layout Example

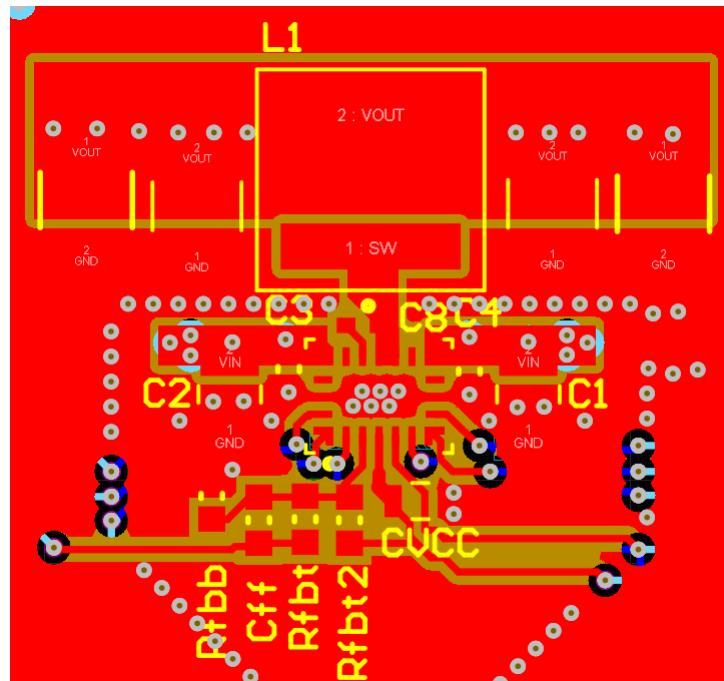


Figure 8-78. Layout Example

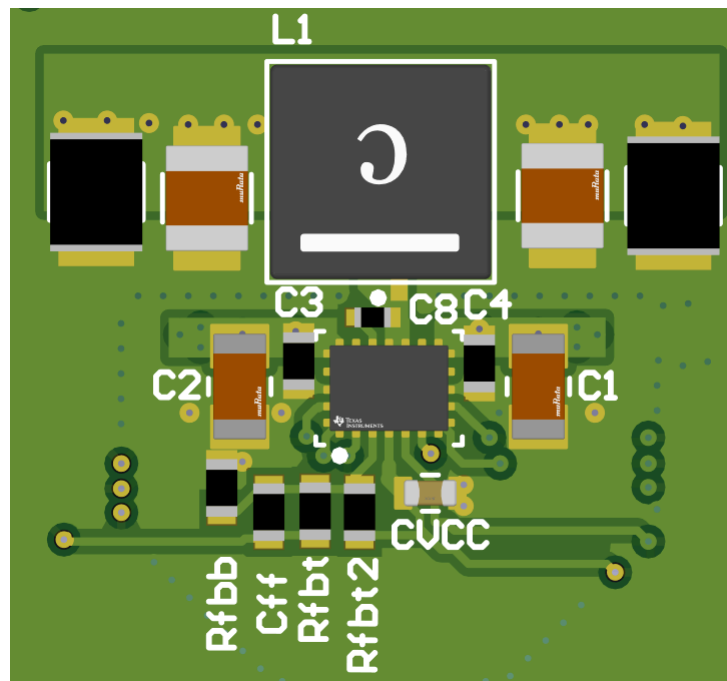


Figure 8-79. PCB Image

## 9 Device and Documentation Support

### 9.1 Device Support

#### 9.1.1 Third-Party Products Disclaimer

TI'S PUBLICATION OF INFORMATION REGARDING THIRD-PARTY PRODUCTS OR SERVICES DOES NOT CONSTITUTE AN ENDORSEMENT REGARDING THE SUITABILITY OF SUCH PRODUCTS OR SERVICES OR A WARRANTY, REPRESENTATION OR ENDORSEMENT OF SUCH PRODUCTS OR SERVICES, EITHER ALONE OR IN COMBINATION WITH ANY TI PRODUCT OR SERVICE.

#### 9.1.2 Development Support

##### 9.1.2.1 Custom Design With WEBENCH® Tools

[Click here](#) to create a custom design using the LM656x5-Q1 device with the WEBENCH Power Designer.

1. Start by entering the input voltage ( $V_{IN}$ ), output voltage ( $V_{OUT}$ ), and output current ( $I_{OUT}$ ) requirements.
2. Optimize the design for key parameters such as efficiency, footprint, and cost using the optimizer dial.
3. Compare the generated design with other possible solutions from Texas Instruments.

The WEBENCH Power Designer provides a customized schematic along with a list of materials with real-time pricing and component availability.

In most cases, these actions are available:

- Run electrical simulations to see important waveforms and circuit performance
- Run thermal simulations to understand board thermal performance
- Export customized schematic and layout into popular CAD formats
- Print PDF reports for the design, and share the design with colleagues

Get more information about WEBENCH tools at [www.ti.com/WEBENCH](http://www.ti.com/WEBENCH).

### 9.2 Documentation Support

#### 9.2.1 Related Documentation

For related documentation, see the following:

- Texas Instruments, [Thermal Design by Insight not Hindsight](#) application report
- Texas Instruments, [A Guide to Board Layout for Best Thermal Resistance for Exposed Pad Packages](#) application report
- Texas Instruments, [How to Properly Evaluate Junction Temperature with Thermal Metrics](#) application report
- Texas Instruments, [Layout Guidelines for Switching Power Supplies](#) application report
- Texas Instruments, [Simple Switcher PCB Layout Guidelines](#) application report
- Texas Instruments, [Construction Your Power Supply- Layout Considerations](#) seminar
- Texas Instruments, [Low Radiated EMI Layout Made Simple with LM4360x and LM4600x](#) application report
- Texas Instruments, [Semiconductor and IC Package Thermal Metrics](#) application note

### 9.3 Receiving Notification of Documentation Updates

To receive notification of documentation updates, navigate to the device product folder on [ti.com](http://ti.com). Click on *Notifications* to register and receive a weekly digest of any product information that has changed. For change details, review the revision history included in any revised document.

### 9.4 Support Resources

[TI E2E™ support forums](#) are an engineer's go-to source for fast, verified answers and design help — straight from the experts. Search existing answers or ask your own question to get the quick design help you need.

Linked content is provided "AS IS" by the respective contributors. They do not constitute TI specifications and do not necessarily reflect TI's views; see TI's [Terms of Use](#).

## 9.5 Trademarks

HotRod™ and TI E2E™ are trademarks of Texas Instruments.  
WEBENCH® is a registered trademark of Texas Instruments.  
All trademarks are the property of their respective owners.

## 9.6 Electrostatic Discharge Caution



This integrated circuit can be damaged by ESD. Texas Instruments recommends that all integrated circuits be handled with appropriate precautions. Failure to observe proper handling and installation procedures can cause damage.

ESD damage can range from subtle performance degradation to complete device failure. Precision integrated circuits may be more susceptible to damage because very small parametric changes could cause the device not to meet its published specifications.

## 9.7 Glossary

[TI Glossary](#) This glossary lists and explains terms, acronyms, and definitions.

## 10 Revision History

NOTE: Page numbers for previous revisions may differ from page numbers in the current version.

<b>Changes from Revision * (September 2024) to Revision A (May 2025)</b>	<b>Page</b>
• Changed document status from Advance Information to Production Data.....	<a href="#">1</a>

## 11 Mechanical, Packaging, and Orderable Information

The following pages include mechanical, packaging, and orderable information. This information is the most current data available for the designated devices. This data is subject to change without notice and revision of this document. For browser-based versions of this data sheet, refer to the left-hand navigation.

## PACKAGING INFORMATION

Orderable part number	Status (1)	Material type (2)	Package   Pins	Package qty   Carrier	RoHS (3)	Lead finish/ Ball material (4)	MSL rating/ Peak reflow (5)	Op temp (°C)	Part marking (6)
<a href="#">LM65625SRZTRQ1</a>	Active	Production	WQFN-FCRLF (RZT)   20	2500   LARGE T&R	Yes	NIPDAU	Level-2-260C-1 YEAR	-40 to 150	625SQ
<a href="#">LM65635SRZTRQ1</a>	Active	Production	WQFN-FCRLF (RZT)   20	2500   LARGE T&R	Yes	NIPDAU	Level-2-260C-1 YEAR	-40 to 150	635SQ
<a href="#">LM65645SRZTRQ1</a>	Active	Production	WQFN-FCRLF (RZT)   20	2500   LARGE T&R	Yes	NIPDAU	Level-2-260C-1 YEAR	-40 to 150	645SQ
<a href="#">PLM65645SRZTRQ1</a>	Active	Preproduction	WQFN-FCRLF (RZT)   20	2500   LARGE T&R	-	Call TI	Call TI	-40 to 150	
PLM65645SRZTRQ1.A	Active	Preproduction	WQFN-FCRLF (RZT)   20	2500   LARGE T&R	-	Call TI	Call TI	-40 to 150	

(1) **Status:** For more details on status, see our [product life cycle](#).

(2) **Material type:** When designated, preproduction parts are prototypes/experimental devices, and are not yet approved or released for full production. Testing and final process, including without limitation quality assurance, reliability performance testing, and/or process qualification, may not yet be complete, and this item is subject to further changes or possible discontinuation. If available for ordering, purchases will be subject to an additional waiver at checkout, and are intended for early internal evaluation purposes only. These items are sold without warranties of any kind.

(3) **RoHS values:** Yes, No, RoHS Exempt. See the [TI RoHS Statement](#) for additional information and value definition.

(4) **Lead finish/Ball material:** Parts may have multiple material finish options. Finish options are separated by a vertical ruled line. Lead finish/Ball material values may wrap to two lines if the finish value exceeds the maximum column width.

(5) **MSL rating/Peak reflow:** The moisture sensitivity level ratings and peak solder (reflow) temperatures. In the event that a part has multiple moisture sensitivity ratings, only the lowest level per JEDEC standards is shown. Refer to the shipping label for the actual reflow temperature that will be used to mount the part to the printed circuit board.

(6) **Part marking:** There may be an additional marking, which relates to the logo, the lot trace code information, or the environmental category of the part.

Multiple part markings will be inside parentheses. Only one part marking contained in parentheses and separated by a "~" will appear on a part. If a line is indented then it is a continuation of the previous line and the two combined represent the entire part marking for that device.

**Important Information and Disclaimer:** The information provided on this page represents TI's knowledge and belief as of the date that it is provided. TI bases its knowledge and belief on information provided by third parties, and makes no representation or warranty as to the accuracy of such information. Efforts are underway to better integrate information from third parties. TI has taken and continues to take reasonable steps to provide representative and accurate information but may not have conducted destructive testing or chemical analysis on incoming materials and chemicals. TI and TI suppliers consider certain information to be proprietary, and thus CAS numbers and other limited information may not be available for release.



In no event shall TI's liability arising out of such information exceed the total purchase price of the TI part(s) at issue in this document sold by TI to Customer on an annual basis.

**OTHER QUALIFIED VERSIONS OF LM65645-Q1 :**

- Catalog : [LM65645](#)

NOTE: Qualified Version Definitions:

- Catalog - TI's standard catalog product

**TAPE AND REEL INFORMATION**

**QUADRANT ASSIGNMENTS FOR PIN 1 ORIENTATION IN TAPE**


\*All dimensions are nominal

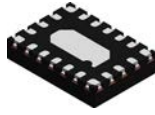
Device	Package Type	Package Drawing	Pins	SPQ	Reel Diameter (mm)	Reel Width W1 (mm)	A0 (mm)	B0 (mm)	K0 (mm)	P1 (mm)	W (mm)	Pin1 Quadrant
LM65625SRZTRQ1	WQFN-FCRLF	RZT	20	2500	330.0	12.4	3.4	4.27	0.7	8.0	12.0	Q1
LM65635SRZTRQ1	WQFN-FCRLF	RZT	20	2500	330.0	12.4	3.4	4.27	0.7	8.0	12.0	Q1
LM65645SRZTRQ1	WQFN-FCRLF	RZT	20	2500	330.0	12.4	3.4	4.27	0.7	8.0	12.0	Q1

**TAPE AND REEL BOX DIMENSIONS**


\*All dimensions are nominal

Device	Package Type	Package Drawing	Pins	SPQ	Length (mm)	Width (mm)	Height (mm)
LM65625SRZTRQ1	WQFN-FCRLF	RZT	20	2500	346.0	346.0	33.0
LM65635SRZTRQ1	WQFN-FCRLF	RZT	20	2500	346.0	346.0	33.0
LM65645SRZTRQ1	WQFN-FCRLF	RZT	20	2500	346.0	346.0	33.0

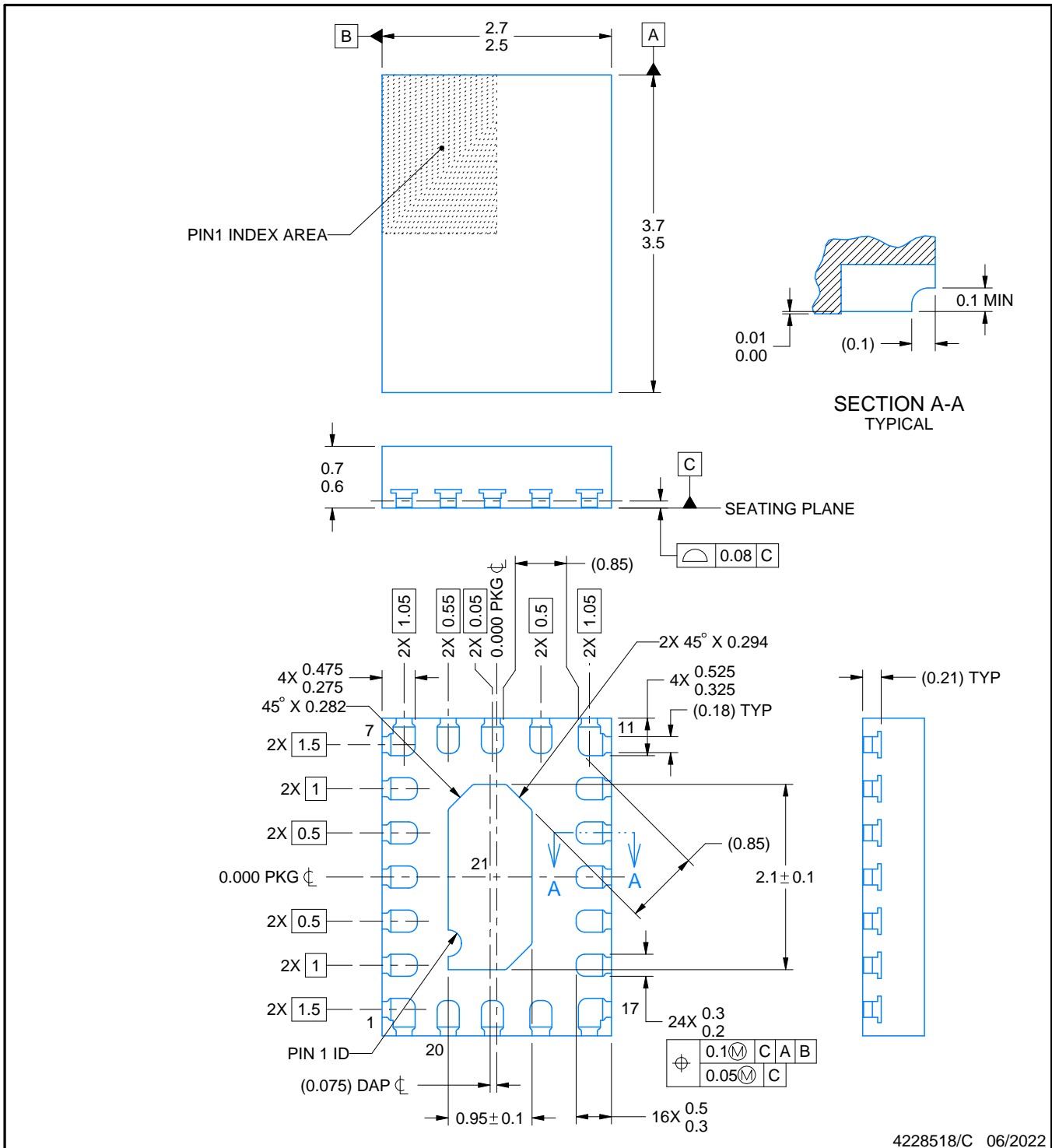
# RZT0020A



# PACKAGE OUTLINE

## WQFN-FCRLF - 0.7 mm max height

PLASTIC QUAD FLATPACK - NO LEAD



**NOTES:**

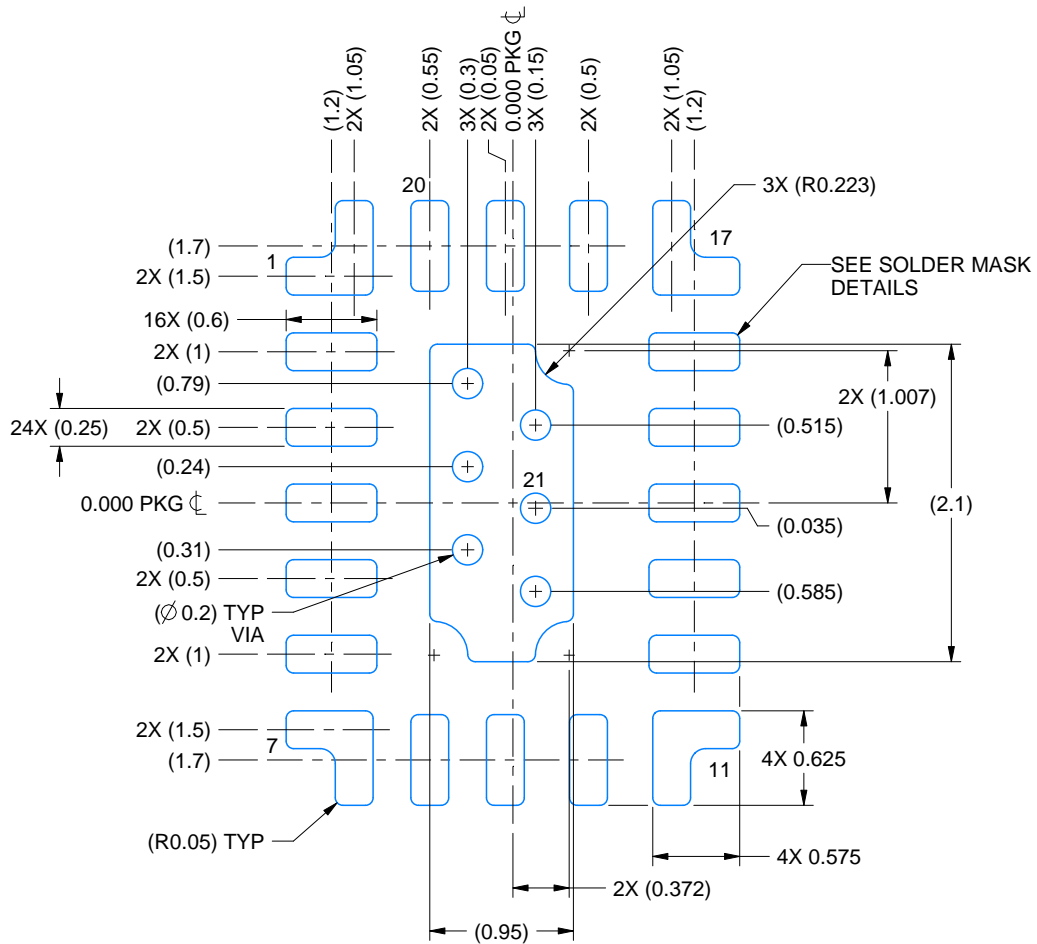
1. All linear dimensions are in millimeters. Any dimensions in parenthesis are for reference only. Dimensioning and tolerancing per ASME Y14.5M.
2. This drawing is subject to change without notice.
3. The package thermal pad must be soldered to the printed circuit board for thermal and mechanical performance.

# EXAMPLE BOARD LAYOUT

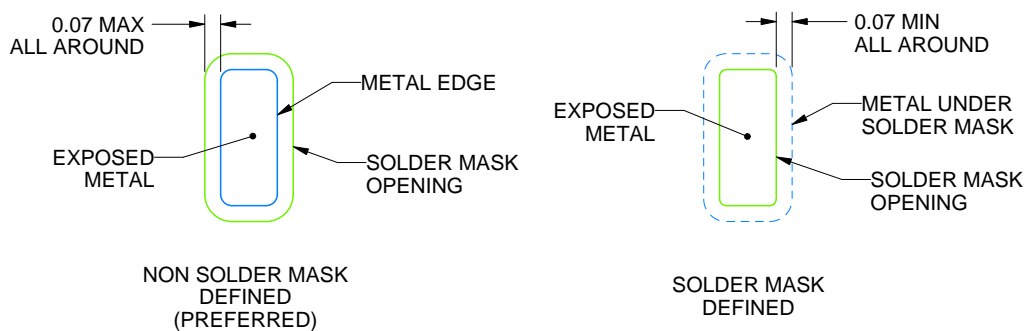
RZT0020A

WQFN-FCRLF - 0.7 mm max height

PLASTIC QUAD FLATPACK - NO LEAD



LAND PATTERN EXAMPLE  
EXPOSED METAL SHOWN  
SCALE: 20X



SOLDER MASK DETAILS

4228518/C 06/2022

NOTES: (continued)

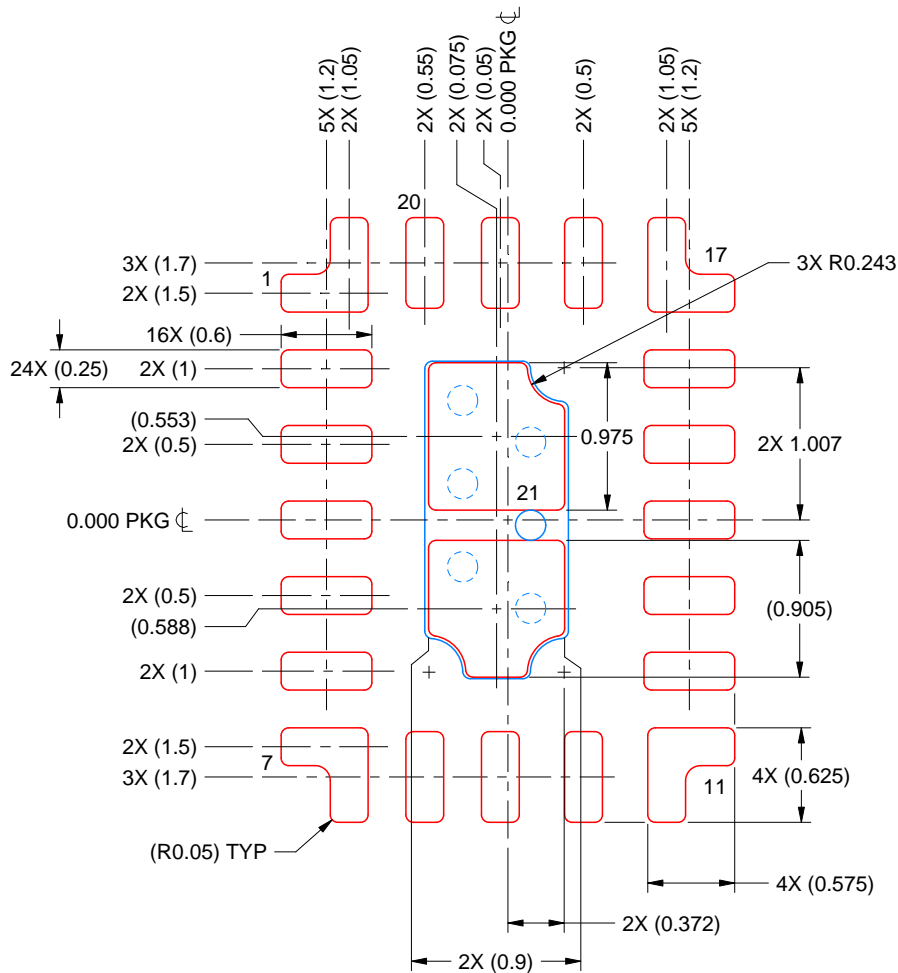
- This package is designed to be soldered to a thermal pad on the board. For more information, see Texas Instruments literature number SLUA271 ([www.ti.com/lit/slua271](http://www.ti.com/lit/slua271)).
- Vias are optional depending on application, refer to device data sheet. If any vias are implemented, refer to their locations shown on this view. It is recommended that vias under paste be filled, plugged or tented.

# EXAMPLE STENCIL DESIGN

RZT0020A

WQFN-FCRLF - 0.7 mm max height

PLASTIC QUAD FLATPACK - NO LEAD



SOLDER PASTE EXAMPLE  
 BASED ON 0.125 mm THICK STENCIL  
 SCALE: 20X

EXPOSED PAD 21:  
 85% PRINTED SOLDER COVERAGE BY AREA UNDER PACKAGE

4228518/C 06/2022

NOTES: (continued)

6. Laser cutting apertures with trapezoidal walls and rounded corners may offer better paste release. IPC-7525 may have alternate design recommendations.

## IMPORTANT NOTICE AND DISCLAIMER

TI PROVIDES TECHNICAL AND RELIABILITY DATA (INCLUDING DATASHEETS), DESIGN RESOURCES (INCLUDING REFERENCE DESIGNS), APPLICATION OR OTHER DESIGN ADVICE, WEB TOOLS, SAFETY INFORMATION, AND OTHER RESOURCES "AS IS" AND WITH ALL FAULTS, AND DISCLAIMS ALL WARRANTIES, EXPRESS AND IMPLIED, INCLUDING WITHOUT LIMITATION ANY IMPLIED WARRANTIES OF MERCHANTABILITY, FITNESS FOR A PARTICULAR PURPOSE OR NON-INFRINGEMENT OF THIRD PARTY INTELLECTUAL PROPERTY RIGHTS.

These resources are intended for skilled developers designing with TI products. You are solely responsible for (1) selecting the appropriate TI products for your application, (2) designing, validating and testing your application, and (3) ensuring your application meets applicable standards, and any other safety, security, regulatory or other requirements.

These resources are subject to change without notice. TI grants you permission to use these resources only for development of an application that uses the TI products described in the resource. Other reproduction and display of these resources is prohibited. No license is granted to any other TI intellectual property right or to any third party intellectual property right. TI disclaims responsibility for, and you fully indemnify TI and its representatives against any claims, damages, costs, losses, and liabilities arising out of your use of these resources.

TI's products are provided subject to [TI's Terms of Sale](#), [TI's General Quality Guidelines](#), or other applicable terms available either on [ti.com](http://ti.com) or provided in conjunction with such TI products. TI's provision of these resources does not expand or otherwise alter TI's applicable warranties or warranty disclaimers for TI products. Unless TI explicitly designates a product as custom or customer-specified, TI products are standard, catalog, general purpose devices.

TI objects to and rejects any additional or different terms you may propose.

Copyright © 2025, Texas Instruments Incorporated

Last updated 10/2025