

LMV225/LMV226/LMV228 RF Power Detector for CDMA and WCDMA

Check for Samples: [LMV225](#), [LMV226](#), [LMV228](#)

FEATURES

- 30 dB Linear in dB Power Detection Range
- Output Voltage Range 0.2 to 2V
- Logic Low Shutdown
- Multi-Band Operation from 450 MHz to 2000 MHz
- Accurate Temperature Compensation
- Packages:
 - DSBGA Thin 1.0 mm x 1.0 mm x 0.6 mm
 - DSBGA Ultra Thin 1.0 mm x 1.0 mm x 0.35 mm
 - WSON 2.2 mm x 2.5 mm x 0.8 mm
 - (LMV225 and LMV228)

APPLICATIONS

- CDMA RF Power Control
- WCDMA RF Power Control
- CDMA2000 RF Power Control
- PA Modules

DESCRIPTION

The LMV225/LMV226/LMV228 are 30 dB RF power detectors intended for use in CDMA and WCDMA applications. The device has an RF frequency range from 450 MHz to 2 GHz. It provides an accurate temperature and supply compensated output voltage that relates linearly to the RF input power in dBm. The circuit operates with a single supply from 2.7V to 5.5V. The LMV225/LMV226/LMV228 have an integrated filter for low-ripple average power detection of CDMA signals with 30 dB dynamic range. Additional filtering can be applied using a single external capacitor.

The LMV225 has an RF power detection range from –30 dBm to 0 dBm and is ideally suited for direct use in combination with resistive taps. The LMV226/LMV228 have a detection range from –15 dBm to 15 dBm and are intended for use in combination with a directional coupler. The LMV226 is equipped with a buffered output which makes it suitable for GSM, EDGE, GPRS and TDMA applications.

The device is active for Enable = HI, otherwise it is in a low power consumption shutdown mode. During shutdown the output will be LOW. The output voltage ranges from 0.2V to 2V and can be scaled down to meet ADC input range requirements.

The LMV225/LMV226/LMV228 power detectors are offered in the thin 1.0 mm x 1.0 mm x 0.6 mm DSBGA package and the ultra thin 1.0 mm x 1.0 mm x 0.35 mm DSBGA package. The LMV225 and the LMV228 are also offered in the 2.2 mm x 2.5 mm x 0.8 mm WSON package.

Typical Application

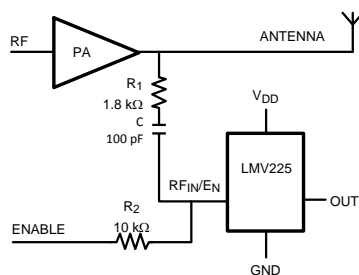
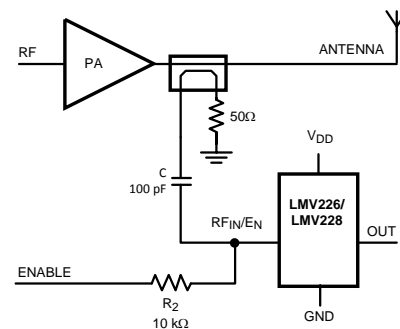
Figure 1. LMV225

Figure 2. LMV226/LMV228

Please be aware that an important notice concerning availability, standard warranty, and use in critical applications of Texas Instruments semiconductor products and disclaimers thereto appears at the end of this data sheet.

All trademarks are the property of their respective owners.



These devices have limited built-in ESD protection. The leads should be shorted together or the device placed in conductive foam during storage or handling to prevent electrostatic damage to the MOS gates.

ABSOLUTE MAXIMUM RATINGS ⁽¹⁾⁽²⁾

Supply Voltage	
$V_{DD} - GND$	6.0V Max
ESD Tolerance ⁽³⁾	
Human Body Model	2000V
Machine Model	200V
Storage Temperature Range	
	-65°C to 150°C
Junction Temperature ⁽⁴⁾	
	150°C Max
Mounting Temperature, Infrared or convection (20 sec)	
Tin/Lead	235°C
Lead-Free	260°C

- (1) Absolute Maximum Ratings indicate limits beyond which damage to the device may occur. Operating Ratings indicate conditions for which the device is intended to be functional, but specific performance is not specified. For specifications and the test conditions, see the Electrical Characteristics.
- (2) If Military/Aerospace specified devices are required, please contact the Texas Instruments Sales Office/ Distributors for availability and specifications.
- (3) Human body model: 1.5 k Ω in series with 100 pF. Machine model, 0 Ω in series with 100 pF.
- (4) The maximum power dissipation is a function of $T_{J(MAX)}$, θ_{JA} and T_A . The maximum allowable power dissipation at any ambient temperature is $P_D = (T_{J(MAX)} - T_A)/\theta_{JA}$. All numbers apply for packages soldered directly into a PC board

OPERATING RATINGS ⁽¹⁾

Supply Voltage	2.7V to 5.5V
Temperature Range	-40°C to +85°C
RF Frequency Range	450 MHz to 2 GHz

- (1) Absolute Maximum Ratings indicate limits beyond which damage to the device may occur. Operating Ratings indicate conditions for which the device is intended to be functional, but specific performance is not specified. For specifications and the test conditions, see the Electrical Characteristics.

2.7 DC AND AC ELECTRICAL CHARACTERISTICS

Unless otherwise specified, all limits are specified to $V_{DD} = 2.7V$; $T_J = 25^\circ C$. **Boldface** limits apply at temperature extremes. ⁽¹⁾

Symbol	Parameter	Condition	Min	Typ	Max	Units
I_{DD}	Supply Current	Active Mode: $RF_{IN}/E_N = V_{DD}$ (DC), No RF Input Power Present	LMV225	4.8	7.8	mA
			LMV226	4.9	6.28	
			LMV228	4.9	6.28	
		Shutdown: $RF_{IN}/E_N = GND$ (DC), No RF Input Power Present		0.44	4.5	μA
V_{LOW}	E_N Logic Low Input Level ⁽²⁾				0.8	V
V_{HIGH}	E_N Logic High Input Level ⁽²⁾		1.8			V
t_{on}	Turn-on-Time ⁽³⁾	No RF Input Power Present, Output Loaded with 10 pF	LMV225	2.1		μs
			LMV226	1.2		
			LMV228	1.7		
t_r	Rise Time ⁽⁴⁾	Step from no Power to 0 dBm Applied, Output Loaded with 10 pF	LMV225	4.5		μs
			LMV226	1.8		
		Step from no Power to 15 dBm Applied, Output Loaded with 10 pF	LMV228	4.8		
I_{EN}	Current into RF_{IN}/E_N Pin				1	μA
P_{IN}	Input Power Range ⁽⁵⁾	LMV225		-30 0		dBm
					-43 -13	
		LMV226		-15 15		dBm
					-28 2	
		LMV228		-15 15		dBm
					-28 2	

(1) Electrical Table values apply only for factory testing conditions at the temperature indicated. Factory testing conditions result in very limited self-heating of the device such that $T_J = T_A$. No specification of parametric performance is indicated in the electrical tables under conditions of internal self-heating where $T_J > T_A$.

(2) All limits are specified by design or statistical analysis

(3) Turn-on time is measured by connecting a 10 k Ω resistor to the RF_{IN}/E_N pin. Be aware that in the actual application on the front page, the RC-time constant of resistor R_2 and capacitor C adds an additional delay.

(4) Typical values represent the most likely parametric norm.

(5) Power in dBV = dBm + 13 when the impedance is 50 Ω .

2.7 DC AND AC ELECTRICAL CHARACTERISTICS (continued)

Unless otherwise specified, all limits are specified to $V_{DD} = 2.7V$; $T_J = 25^\circ C$. **Boldface** limits apply at temperature extremes. ⁽¹⁾

Symbol	Parameter	Condition	Min	Typ	Max	Units
	Logarithmic Slope ⁽⁶⁾	900 MHz	LMV225	44.0		mV/dB
			LMV226	44.5		
			LMV228 DSBGA	44.0		
			LMV228 WSON	48.5		
		1800 MHz	LMV225	39.4		
			LMV226	41.6		
			LMV228 DSBGA	41.9		
			LMV228 WSON	47.4		
		1900 MHz	LMV225	38.5		
			LMV226	41.2		
			LMV228 DSBGA	41.6		
			LMV228 WSON	46.6		
		2000 MHz	LMV225	38.5		
			LMV226	41.0		
			LMV228 DSBGA	41.2		
			LMV228 WSON	45.4		
	Logarithmic Intercept ⁽⁶⁾	900 MHz	LMV225	-45.5		dBm
			LMV226	-24.5		
			LMV228 DSBGA	-27.2		
			LMV228 WSON	-23.7		
		1800 MHz	LMV225	-46.6		
			LMV226	-25.1		
			LMV228 DSBGA	-28.2		
			LMV228 WSON	-23.8		
		1900 MHz	LMV225	-46.3		
			LMV226	-24.9		
			LMV228 DSBGA	-28.0		
			LMV228 WSON	-23.7		
		2000 MHz	LMV225	-46.7		
			LMV226	-24.7		
			LMV228 DSBGA	-28.0		
			LMV228 WSON	-23.6		
V _{OUT}	Output Voltage	No RF Input Power Present	LMV225	214	350	mV
			LMV226	223	350	
			LMV228	228	350	
I _{OUT}	Output Current Sourcing/Sinking	LMV226 Only	4.5	5.3		mA
R _{OUT}	Output Impedance	LMV225/LMV228 only, no RF Input Power Present		19.8	29 34	kΩ

(6) Device is set in active mode with a 10 kΩ resistor from V_{DD} to RF_{IN}/E_N. RF signal is applied using a 50Ω RF signal generator AC coupled to the RF_{IN}/E_N pin using a 100 pF coupling capacitor.

2.7 DC AND AC ELECTRICAL CHARACTERISTICS (continued)

 Unless otherwise specified, all limits are specified to $V_{DD} = 2.7V$; $T_J = 25^\circ C$. **Boldface** limits apply at temperature extremes. ⁽¹⁾

Symbol	Parameter	Condition	Min	Typ	Max	Units
e_n	Output Referred Noise	RF Input = 1800 MHz, -10 dBm for LMV225 and 5 dBm for LMV226/LMV228, Measured at 10 kHz		700		nV/\sqrt{Hz}
	Variation Due to Temperature	900 MHz, $RF_{IN} = 0$ dBm Referred to 25°C	LMV225	+0.64 -1.07		dB
		900 MHz, $RF_{IN} = 15$ dBm Referred to 25°C	LMV226	+0.05 -0.02		
			LMV228 DSBGA	+0.22 -0.36		
			LMV228 WSON	+0.87 -0.87		
		1800 MHz, $RF_{IN} = 0$ dBm Referred to 25°C	LMV225	+0.09 -0.86		
		1800 MHz, $RF_{IN} = 15$ dBm Referred to 25°C	LMV226	+0.07 -0.10		
			LMV228 DSBGA	+0.29 -0.57		
			LMV228 WSON	+1.04 -1.23		
		1900 MHz, $RF_{IN} = 0$ dBm Referred to 25°C	LMV225	+0 -0.69		
		1900 MHz, $RF_{IN} = 15$ dBm Referred to 25°C	LMV226	+0 -0.10		
			LMV228 DSBGA	+0.23 -0.64		
			LMV228 WSON	+1.05 -1.45		
		2000 MHz, $RF_{IN} = 0$ dBm Referred to 25°C	LMV225	+0 -0.86		
		2000 MHz, $RF_{IN} = 15$ dBm Referred to 25°C	LMV226	+0 -0.29		
			LMV228 DSBGA	+0.27 -0.65		
			LMV228 WSON	+1.04 -2.02		

5.0 DC AND AC ELECTRICAL CHARACTERISTICS

Unless otherwise specified, all limits are specified to $V_{DD} = 5.0V$; $T_J = 25^\circ C$. **Boldface** limits apply at temperature extremes. ⁽¹⁾

Symbol	Parameter	Condition	Min	Typ	Max	Units
I_{DD}	Supply Current	Active Mode: $RF_{IN}/E_N = V_{DD}$ (DC), no RF Input Power Present.	LMV225	5.3	7.5 9	mA
			LMV226	5.3	6.8 9	
			LMV228	5.4	6.8 9	
		Shutdown: $RF_{IN}/E_N = GND$ (DC), no RF Input Power Present.		0.32	4.5	μA
V_{LOW}	E_N Logic Low Input Level ⁽²⁾				0.8	V
V_{HIGH}	E_N Logic High Input Level ⁽²⁾		1.8			V
t_{on}	Turn-on-Time ⁽³⁾	No RF Input Power Present, Output Loaded with 10 pF	LMV225	2.1		μs
			LMV226	1.0		
			LMV228	1.7		
t_r	Rise Time ⁽⁴⁾	Step from no Power to 0 dBm Applied, Output Loaded with 10 pF	LMV225	4.5		μs
			LMV226	1.4		
		Step from no Power to 15 dBm Applied, Output Loaded with 10 pF	LMV228	4.8		
I_{EN}	Current Into RF_{IN}/E_N Pin				1	μA
P_{IN}	Input Power Range ⁽⁵⁾	LMV225		-30 0		dBm
				-43 -13		dBV
		LMV226		-15 15		dBm
				-28 2		dBV
		LMV228		-15 15		dBm
				-28 2		dBV

- (1) Electrical Table values apply only for factory testing conditions at the temperature indicated. Factory testing conditions result in very limited self-heating of the device such that $T_J = T_A$. No specification of parametric performance is indicated in the electrical tables under conditions of internal self-heating where $T_J > T_A$.
- (2) All limits are specified by design or statistical analysis
- (3) Turn-on time is measured by connecting a 10 k Ω resistor to the RF_{IN}/E_N pin. Be aware that in the actual application on the front page, the RC-time constant of resistor R_2 and capacitor C adds an additional delay.
- (4) Typical values represent the most likely parametric norm.
- (5) Power in dBV = dBm + 13 when the impedance is 50 Ω .

5.0 DC AND AC ELECTRICAL CHARACTERISTICS (continued)

 Unless otherwise specified, all limits are specified to $V_{DD} = 5.0V$; $T_J = 25^\circ C$. **Boldface** limits apply at temperature extremes. ⁽¹⁾

Symbol	Parameter	Condition	Min	Typ	Max	Units
	Logarithmic Slope ⁽⁶⁾	900 MHz	LMV225	44.6		mV/dB
			LMV226	44.6		
			LMV228 DSBGA	44.2		
			LMV228 WSON	48.4		
		1800 MHz	LMV225	40.6		
			LMV226	42.2		
			LMV228 DSBGA	42.4		
			LMV228 WSON	48.3		
		1900 MHz	LMV225	39.6		
			LMV226	41.8		
			LMV228 DSBGA	42.2		
			LMV228 WSON	47.8		
		2000 MHz	LMV225	39.7		
			LMV226	41.6		
			LMV228 DSBGA	41.8		
			LMV228 WSON	47.2		
	Logarithmic Intercept ⁽⁶⁾	900 MHz	LMV225	-47.0		dBm
			LMV226	-25.0		
			LMV228 DSBGA	-27.7		
			LMV228 WSON	-23.9		
		1800 MHz	LMV225	-48.5		
			LMV226	-25.7		
			LMV228 DSBGA	-28.9		
			LMV228 WSON	-23.6		
		1900 MHz	LMV225	-48.2		
			LMV226	-25.6		
			LMV228 DSBGA	-28.7		
			LMV228 WSON	-23.1		
		2000 MHz	LMV225	-48.9		
			LMV226	-25.5		
			LMV228 DSBGA	-28.7		
			LMV228 WSON	-23.0		
V_{OUT}	Output Voltage	No RF Input Power Present	LMV225	222	400	mV
			LMV226	231	400	
			LMV228	244	400	
I_{OUT}	Output Current Sourcing/Sinking	LMV226 Only	4.5	5.3		mA
R_{OUT}	Output Impedance	No RF Input Power Present		23.7	29 31	k Ω

(6) Device is set in active mode with a 10 k Ω resistor from V_{DD} to RF_{IN}/E_N . RF signal is applied using a 50 Ω RF signal generator AC coupled to the RF_{IN}/E_N pin using a 100 pF coupling capacitor.

5.0 DC AND AC ELECTRICAL CHARACTERISTICS (continued)

Unless otherwise specified, all limits are specified to $V_{DD} = 5.0V$; $T_J = 25^{\circ}C$. **Boldface** limits apply at temperature extremes. ⁽¹⁾

Symbol	Parameter	Condition	Min	Typ	Max	Units
e_n	Output Referred Noise	RF Input = 1800 MHz, -10 dBm for LMV225 and 5 dBm for LMV226/LMV228, Measured at 10 kHz		700		nV/\sqrt{Hz}
	Variation Due to Temperature	900 MHz, $RF_{IN} = 0$ dBm Referred to 25°C	LMV225	+0.89 -1.16		dB
		900 MHz, $RF_{IN} = 15$ dBm Referred to 25°C	LMV226	+0.25 -0.16		
			LMV228 DSBGA	+0.46 -0.62		
			LMV228 WSON	+1.39 -1.19		
		1800 MHz, $RF_{IN} = 0$ dBm Referred to 25°C	LMV225	+0.3 -0.82		
		1800 MHz, $RF_{IN} = 15$ dBm Referred to 25°C	LMV226	+0.21 -0.09		
			LMV228 DSBGA	+0.55 -0.78		
			LMV228 WSON	+1.39 -1.43		
		1900 MHz, $RF_{IN} = 0$ dBm Referred to 25°C	LMV225	+0.34 -0.63		
		1900 MHz, $RF_{IN} = 15$ dBm Referred to 25°C	LMV226	+0.21 -0.19		
			LMV228 DSBGA	+0.55 -0.93		
			LMV228 WSON	+1.54 -1.64		
		2000 MHz, $RF_{IN} = 0$ dBm Referred to 25°C	LMV225	+0.22 -0.75		
		2000 MHz $RF_{IN} = 15$ dBm Referred to 25°C	LMV226	+0.25 -0.34		
			LMV228 DSBGA	+0.61- 0.91		
	LMV228 WSON		+0.89 -0.99			

CONNECTION DIAGRAM

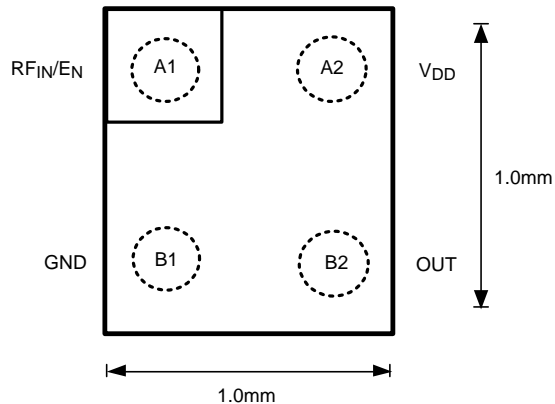

BUMP PITCH 500µm
 BUMP DIAMETER 300µm
 SOLDER DOT DIAMETER/
 PASSIVATION OPENING 125µm

Figure 3. 4-Bump DSBGA – Top View
 See Package Number YZR0004 or YPD0004

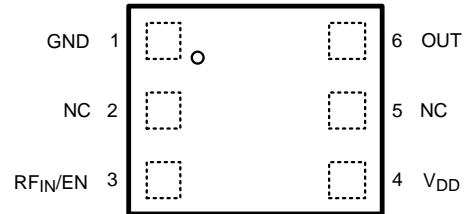

Figure 4. 6-pin WSON – Top View
 See Package Number NGF0006A

PIN DESCRIPTIONS

	Pin		Name	Description
	DSBGA	WSON6		
Power Supply	A2	4	V _{DD}	Positive Supply Voltage
	B1	1	GND	Power Ground
	A1	3	RF _{IN} /E _N	DC voltage determines enable state of the device (HIGH = device active). AC voltage is the RF input signal to the detector (beyond 450 MHz). The RF _{IN} /E _N pin is internally terminated with 50Ω in series with 45 pF.
Output	B2	6	Out	Ground referenced detector output voltage (linear in dBm)

Block Diagrams

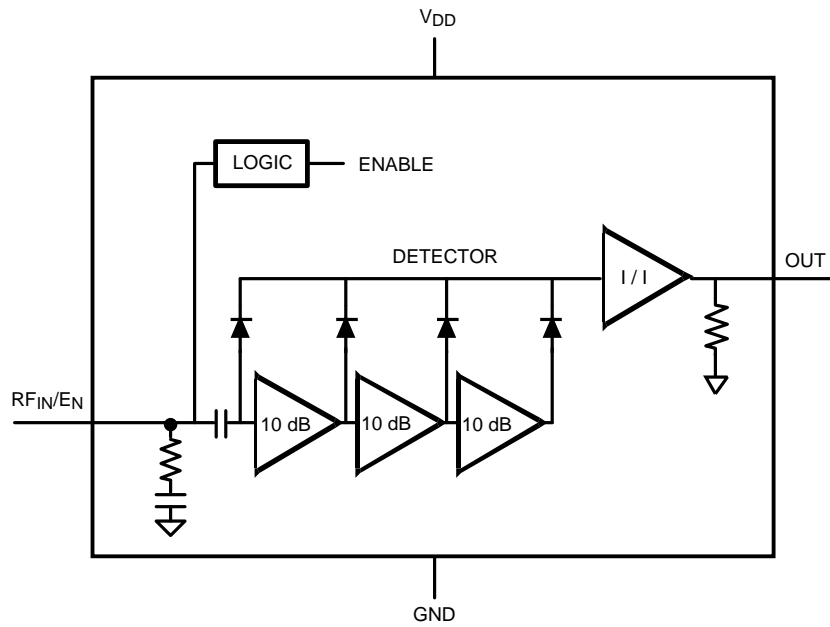

Figure 5. LMV225

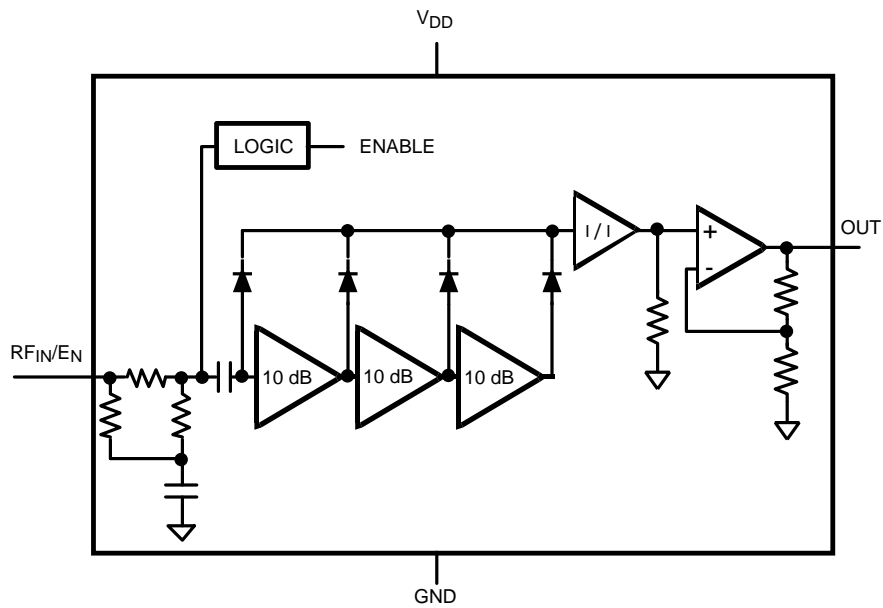

Figure 6. LMV226

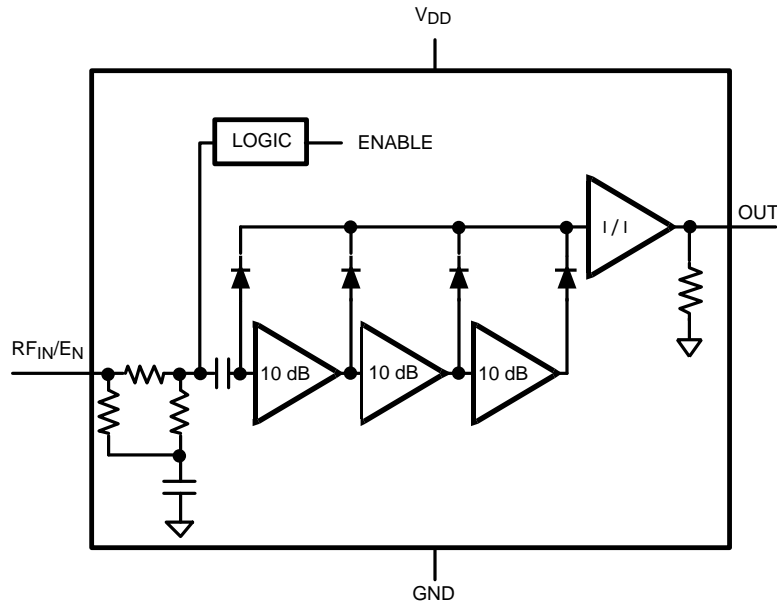

Figure 7. LMV228

TYPICAL PERFORMANCE CHARACTERISTICS LMV225

Unless otherwise specified, $V_{DD} = 2.7V$, $T_J = 25^\circ C$.

Supply Current vs. Supply Voltage (LMV225)

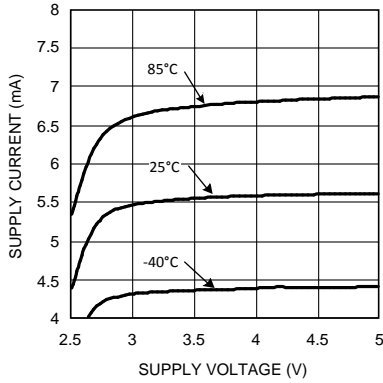

Figure 8.

Output Voltage vs. RF Input Power (LMV225)

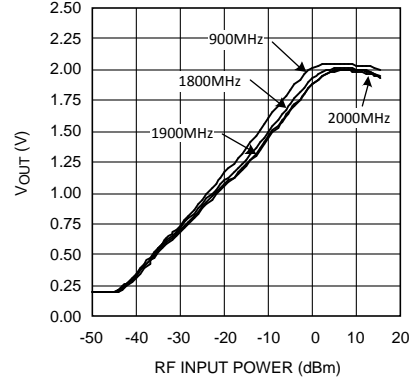

Figure 9.

Output Voltage and Log Conformance vs. RF Input Power @ 900 MHz (LMV225)

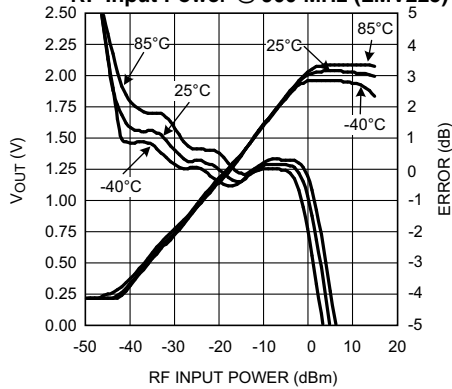

Figure 10.

Output Voltage and Log Conformance vs. RF Input Power @ 1800 MHz (LMV225)

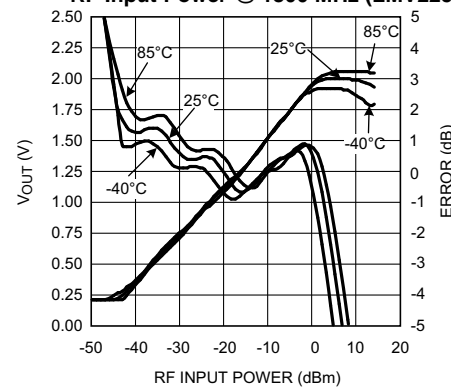

Figure 11.

Output Voltage and Log Conformance vs. RF Input Power @ 1900 MHz (LMV225)

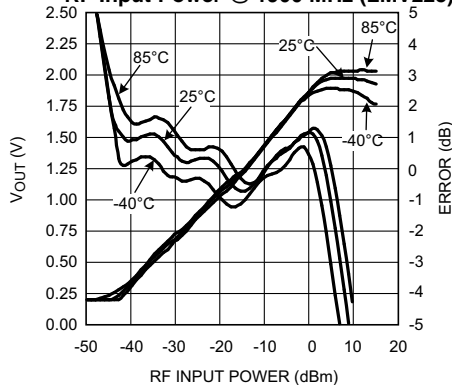

Figure 12.

Output Voltage and Log Conformance vs. RF Input Power @ 2000 MHz (LMV225)

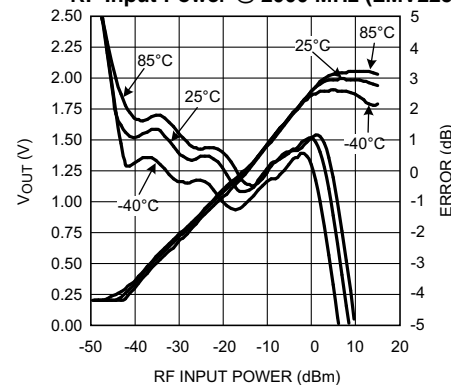

Figure 13.

TYPICAL PERFORMANCE CHARACTERISTICS LMV225
(continued)

Unless otherwise specified, $V_{DD} = 2.7V$, $T_J = 25^\circ C$.

Logarithmic Slope vs. Frequency (LMV225)

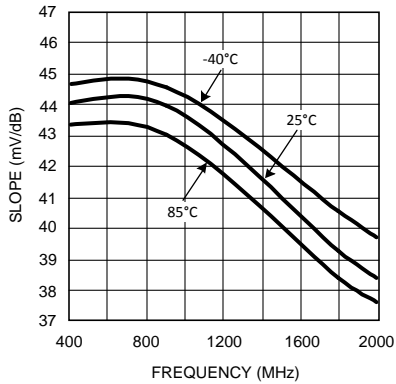

Figure 14.

Logarithmic Intercept vs. Frequency (LMV225)

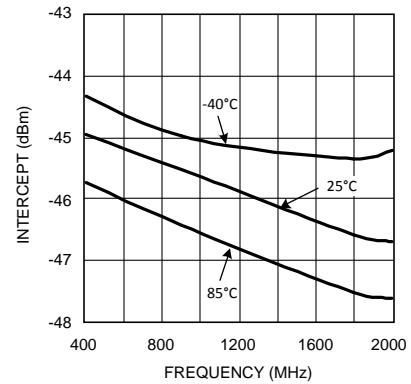

Figure 15.

Output Variation vs. RF Input Power Normalized to 25°C @ 900 MHz (LMV225)

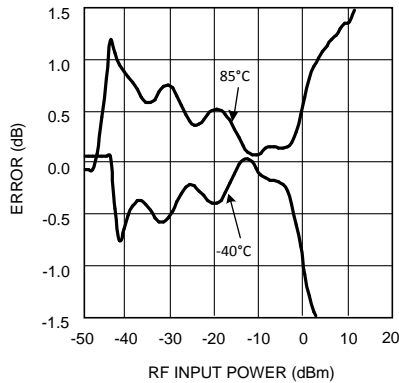

Figure 16.

Output Variation vs. RF Input Power Normalized to 25°C @ 1800 MHz (LMV225)

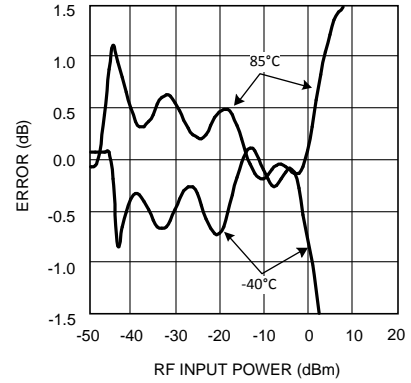

Figure 17.

Output Variation vs. RF Input Power Normalized to 25°C @ 1900 MHz (LMV225)

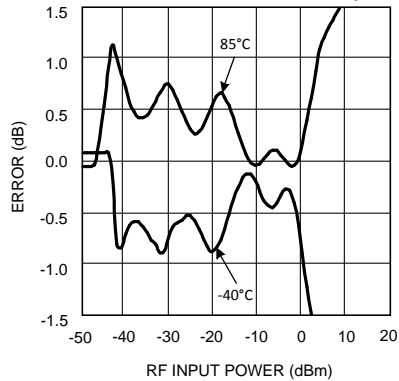

Figure 18.

Output Variation vs. RF Input Power Normalized to 25°C @ 2000 MHz (LMV225)

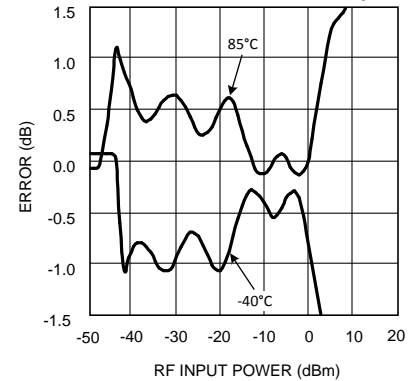

Figure 19.

TYPICAL PERFORMANCE CHARACTERISTICS LMV225 (continued)

Unless otherwise specified, $V_{DD} = 2.7V$, $T_J = 25^\circ C$.

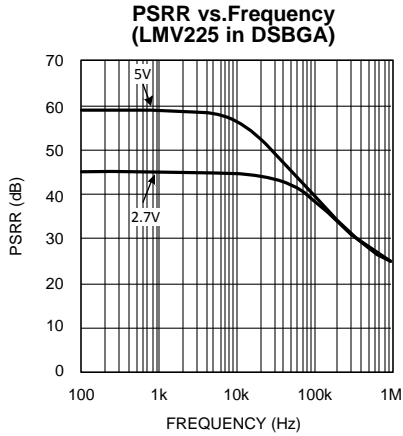

Figure 20.

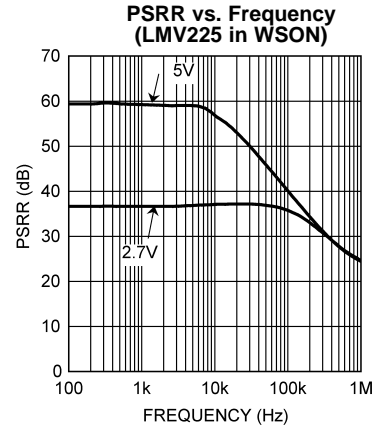

Figure 21.

RF Input Impedance vs. Frequency @ Resistance and Reactance (LMV225 in DSBGA)

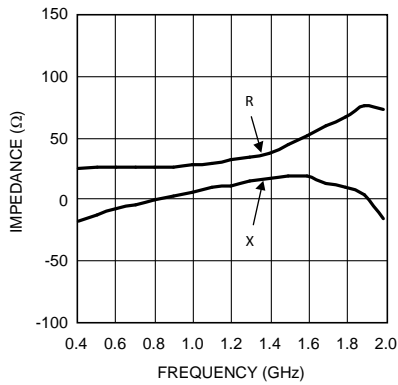

Figure 22.

RF Input Impedance vs. Frequency @ Resistance and Reactance (LMV225 in WSON)

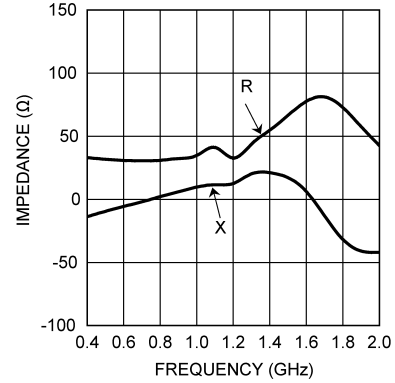

Figure 23.

TYPICAL PERFORMANCE CHARACTERISTICS LMV226

Unless otherwise specified, $V_{DD} = 2.7V$, $T_J = 25^\circ C$.

Supply Current vs. Supply Voltage (LMV226)

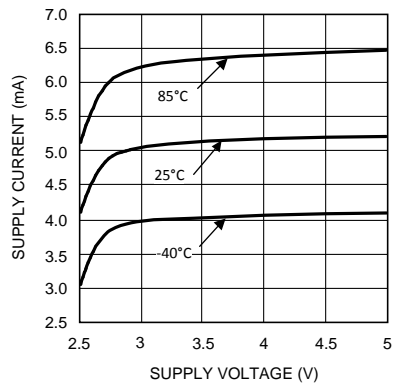

Figure 24.

Output Voltage vs. RF Input Power (LMV226)

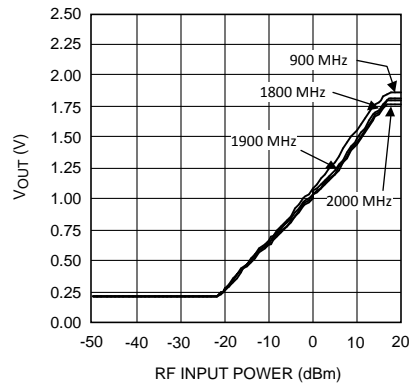

Figure 25.

TYPICAL PERFORMANCE CHARACTERISTICS LMV226
(continued)

Unless otherwise specified, $V_{DD} = 2.7V$, $T_J = 25^\circ C$.

Output Voltage and Log Conformance vs. RF Input Power @ 900 MHz (LMV226)

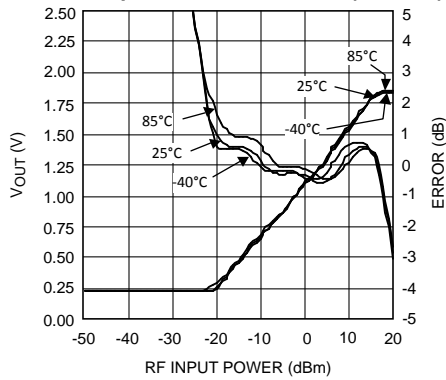

Figure 26.

Output Voltage and Log Conformance vs. RF Input Power @ 1800 MHz (LMV226)

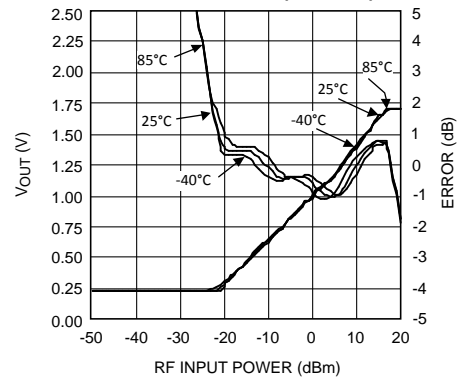

Figure 27.

Output Voltage and Log Conformance vs. RF Input Power @ 1900 MHz (LMV226)

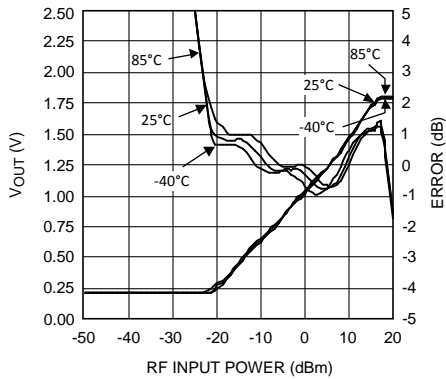

Figure 28.

Output Voltage and Log Conformance vs. RF Input Power @ 2000 MHz (LMV226)

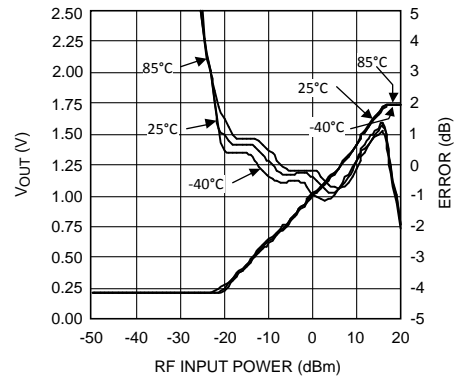

Figure 29.

Logarithmic Slope vs. Frequency (LMV226)

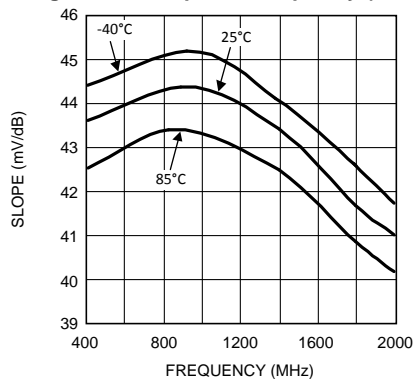

Figure 30.

Logarithmic Intercept vs. Frequency (LMV226)

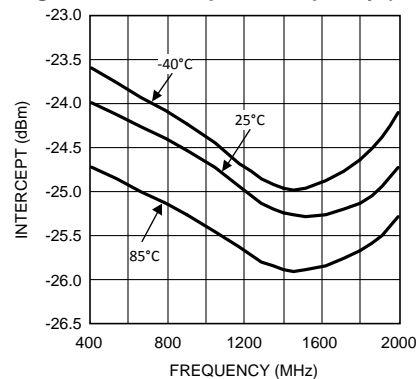

Figure 31.

TYPICAL PERFORMANCE CHARACTERISTICS LMV226
(continued)

Unless otherwise specified, $V_{DD} = 2.7V$, $T_J = 25^\circ C$.

**Output Variation vs. RF Input Power
Normalized to 25°C @ 900 MHz (LMV226)**

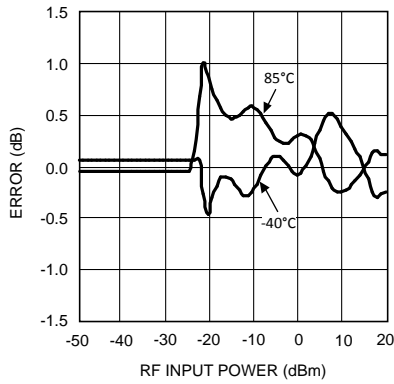

Figure 32.

**Output Variation vs. RF Input Power
Normalized to 25°C @ 1800 MHz (LMV226)**

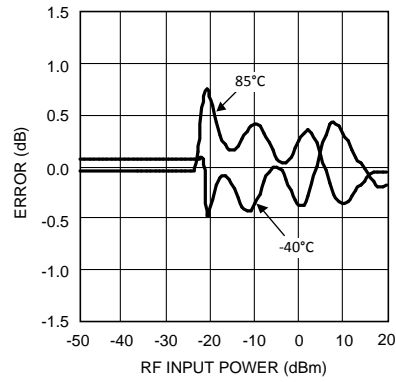

Figure 33.

**Output Variation vs. RF Input Power
Normalized to 25°C @ 1900 MHz (LMV226)**

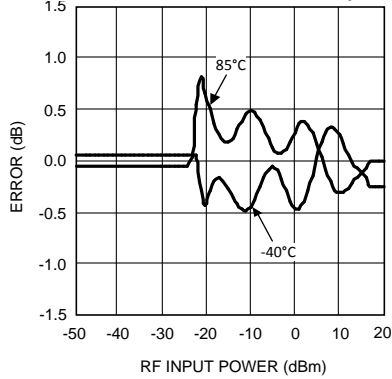

Figure 34.

**Output Variation vs. RF Input Power
Normalized to 25°C @ 2000 MHz (LMV226)**

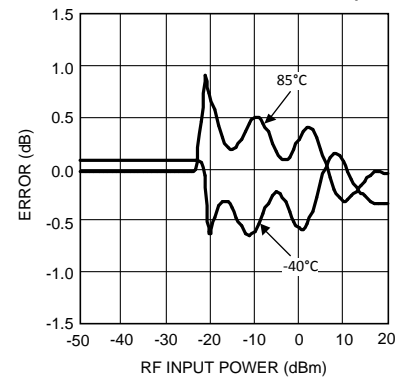

Figure 35.

**PSRR vs. Frequency
(LMV226)**

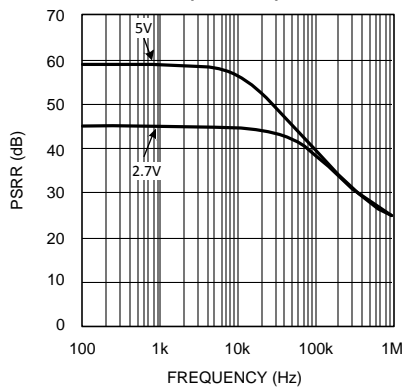

Figure 36.

**RF Input Impedance vs. Frequency @ Resistance and
Reactance (LMV226)**

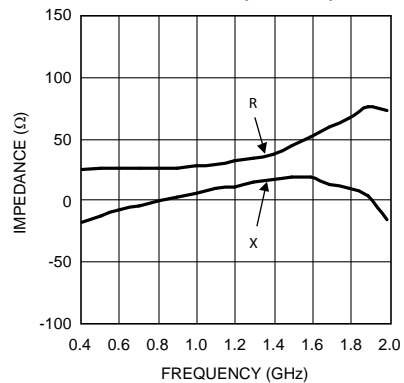

Figure 37.

TYPICAL PERFORMANCE CHARACTERISTICS LMV228 IN DSBGA

Unless otherwise specified, $V_{DD} = 2.7V$, $T_J = 25^\circ C$.

Supply Current vs. Supply Voltage (LMV228 in DSBGA)

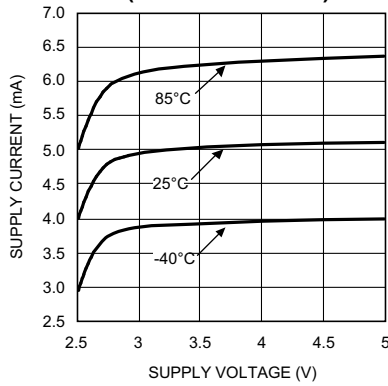

Figure 38.

Output Voltage vs. RF Input Power (LMV228 in DSBGA)

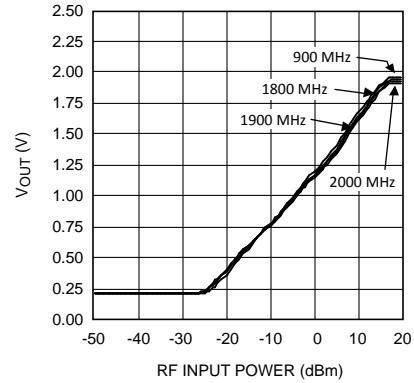

Figure 39.

Output Voltage and Log Conformance vs. RF Input Power @ 900 MHz (LMV228 in DSBGA)

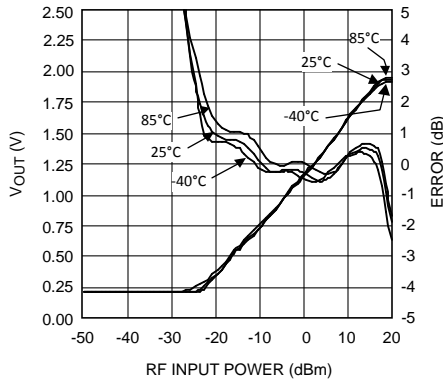

Figure 40.

Output Voltage and Log Conformance vs. RF Input Power @ 1800 MHz (LMV228 in DSBGA)

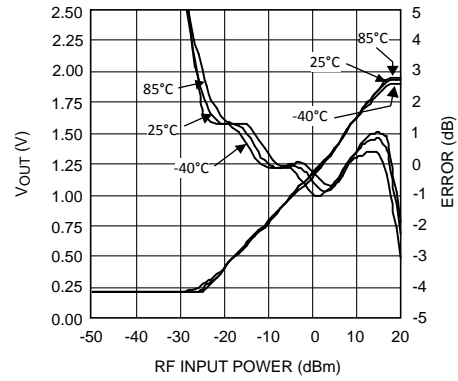

Figure 41.

Output Voltage and Log Conformance vs. RF Input Power @ 1900 MHz (LMV228 in DSBGA)

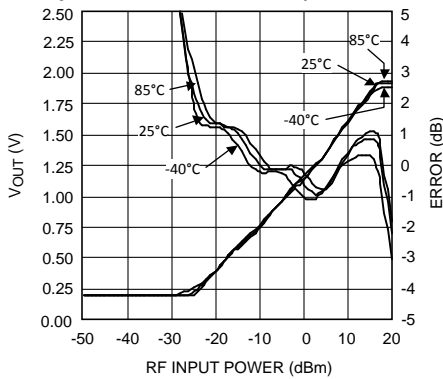

Figure 42.

Output Voltage and Log Conformance vs. RF Input Power @ 2000 MHz (LMV228 in DSBGA)

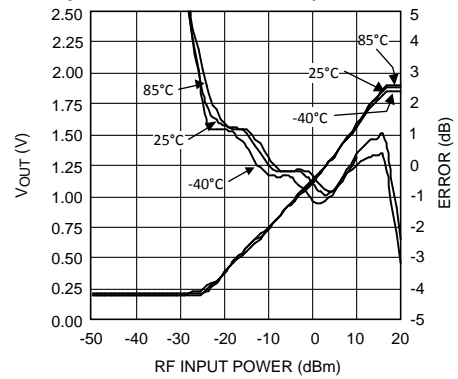

Figure 43.

TYPICAL PERFORMANCE CHARACTERISTICS LMV228 IN DSBGA (continued)

Unless otherwise specified, $V_{DD} = 2.7V$, $T_J = 25^\circ C$.

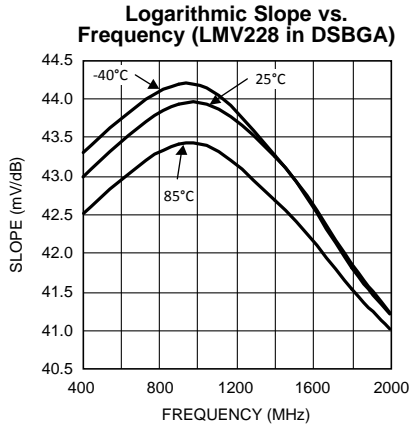

Figure 44.

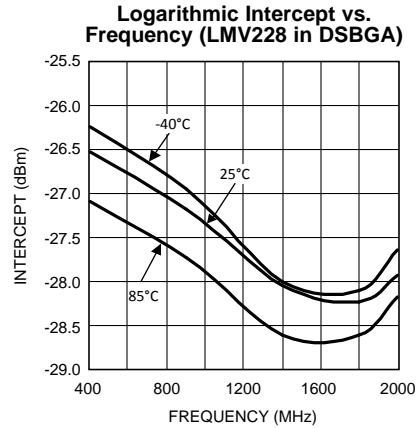

Figure 45.

**Output Variation vs.
RF Input Power Normalized to 25°C @ 900 MHz (LMV228 in DSBGA)**

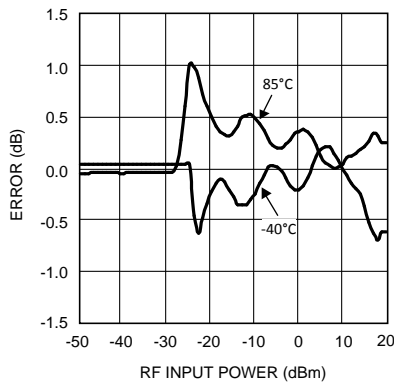

Figure 46.

**Output Variation vs.
RF Input Power Normalized to 25°C @ 1800 MHz (LMV228 in DSBGA)**

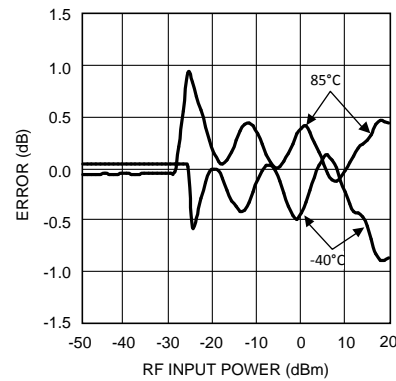

Figure 47.

**Output Variation vs.
RF Input Power Normalized to 25°C @ 1900 MHz (LMV228 in DSBGA)**

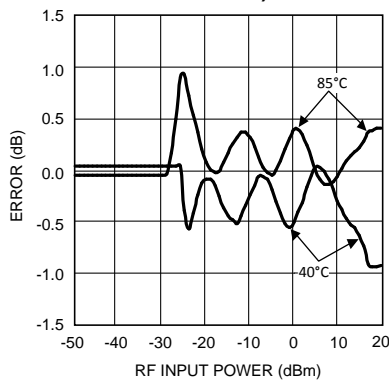

Figure 48.

**Output Variation vs.
RF Input Power Normalized to 25°C @ 2000 MHz (LMV228 in DSBGA)**

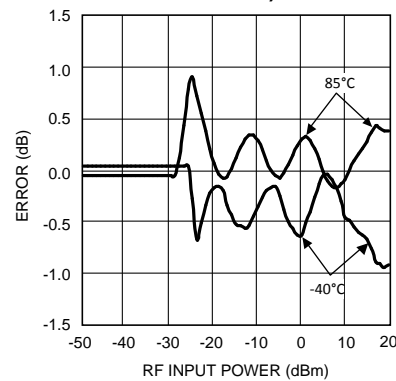

Figure 49.

TYPICAL PERFORMANCE CHARACTERISTICS LMV228 IN DSBGA
(continued)

Unless otherwise specified, $V_{DD} = 2.7V$, $T_J = 25^\circ C$.

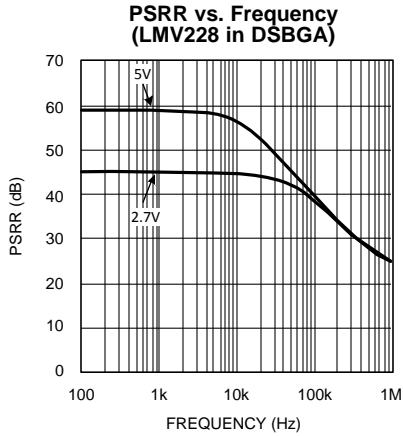

Figure 50.

RF Input Impedance vs. Frequency @ Resistance and Reactance (LMV228 in DSBGA)

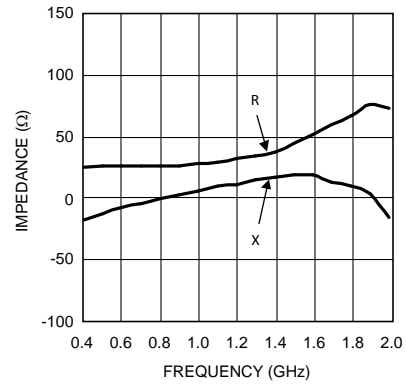

Figure 51.

TYPICAL PERFORMANCE CHARACTERISTICS LMV228 IN WSON

Unless otherwise specified, $V_{DD} = 2.7V$, $T_J = 25^\circ C$.

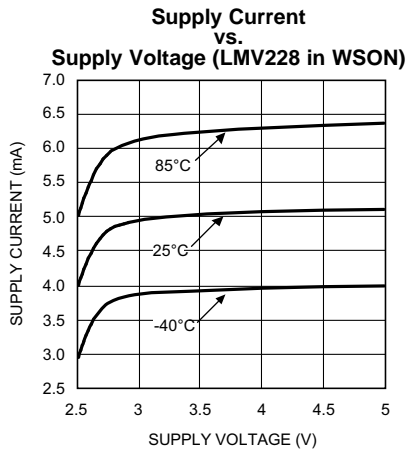

Figure 52.

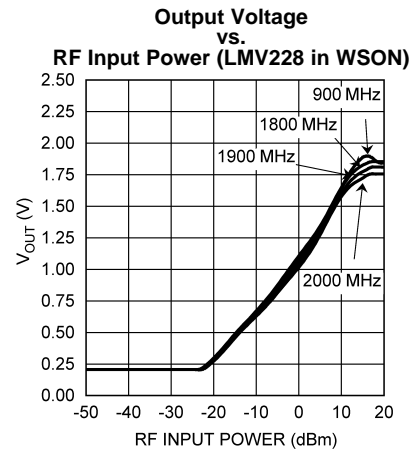

Figure 53.

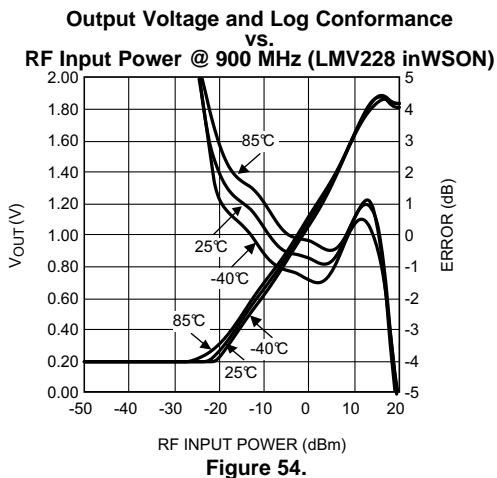

Figure 54.

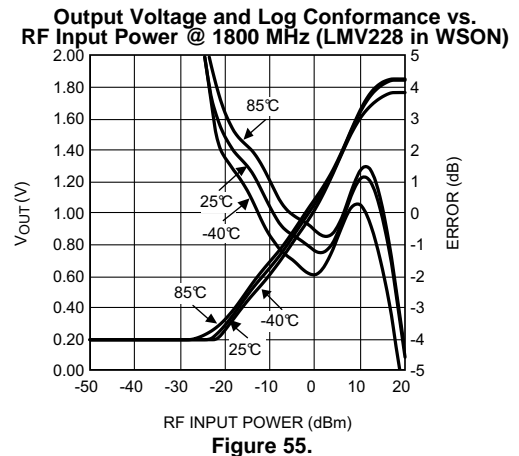

Figure 55.

TYPICAL PERFORMANCE CHARACTERISTICS LMV228 IN WSON
(continued)

Unless otherwise specified, $V_{DD} = 2.7V$, $T_J = 25^\circ C$.

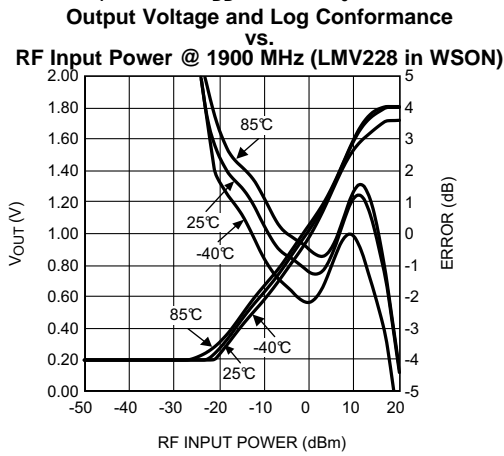

Figure 56.

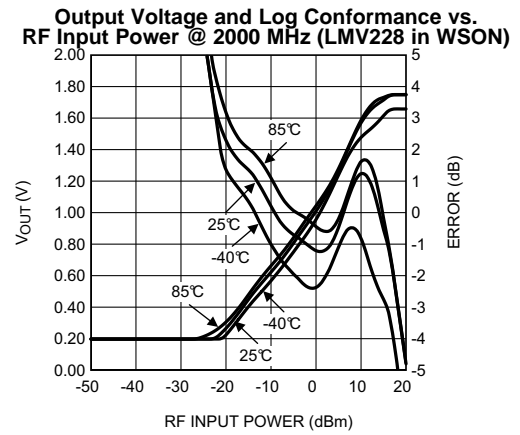

Figure 57.

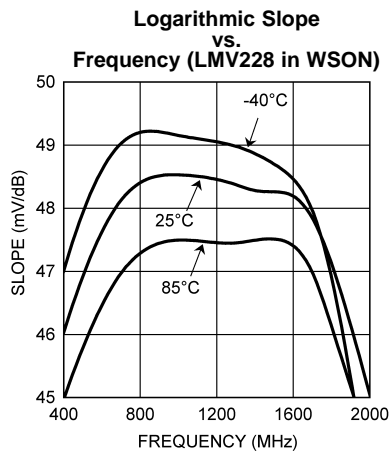

Figure 58.

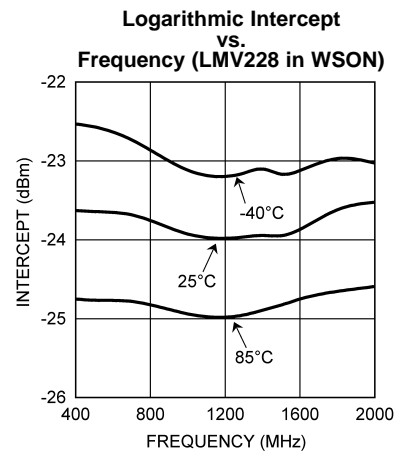

Figure 59.

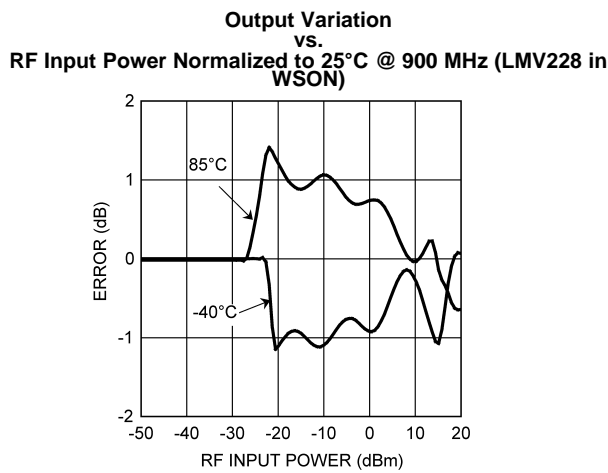

Figure 60.

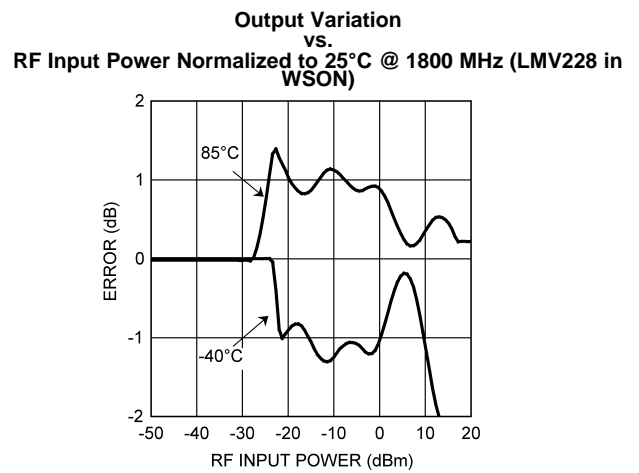

Figure 61.

TYPICAL PERFORMANCE CHARACTERISTICS LMV228 IN WSON
(continued)

Unless otherwise specified, $V_{DD} = 2.7V$, $T_J = 25^\circ C$.

Output Variation vs. RF Input Power Normalized to 25°C @ 1900 MHz (LMV228 in WSON)

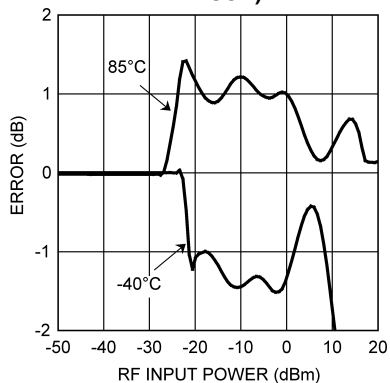

Figure 62.

Output Variation vs. RF Input Power Normalized to 25°C @ 2000 MHz (LMV228 in WSON)

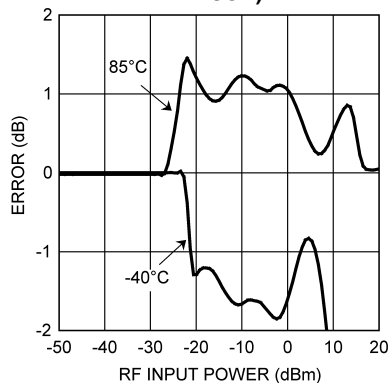

Figure 63.

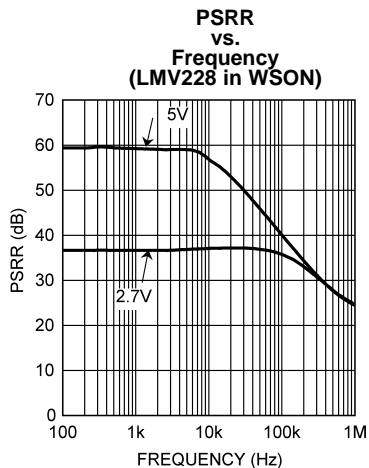

Figure 64.

RF Input Impedance vs. Frequency @ Resistance and Reactance (LMV228 in WSON)

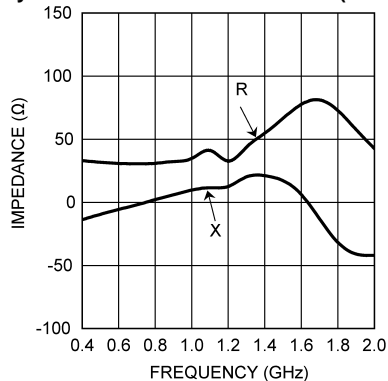

Figure 65.

APPLICATION NOTES

CONFIGURING A TYPICAL APPLICATION

The LMV225/LMV226/LMV228 are power detectors intended for CDMA and WCDMA applications. Power applied at its input translates to a DC voltage on the output through a linear-in-dB response. The LMV225 detector is especially suited for power measurements via a high-resistive tap, while the LMV226/LMV228 are designed to be used in combination with a directional coupler. The LMV226 has an additional output voltage buffer and therefore a low output impedance. The key features of the devices are shown in .

Table 1. DEVICE CHARACTERISTICS

	Input Range (dBm)	Output Buffer	Application
LMV225	-30 / 0	No	High Resistive Tap
LMV226	-15 / 15	Yes	Directional Coupler
LMV228	-15 / 15	No	Directional Coupler

In order to match the output power range of the power amplifier (PA) with the range of the LMV225's input, the high resistive tap needs to be configured correctly. In case of the LMV226/LMV228 the coupling factor of the directional coupler needs to be chosen correctly.

HIGH RESISTIVE TAP APPLICATION

The constant input impedance of the device enables the realization of a frequency independent input attenuation to adjust the LMV225's range to the range of the PA. Resistor R₁ and the 50Ω input resistance (R_{IN}) of the device realize this attenuation (Figure 66). To minimize insertion loss, resistor R₁ needs to be sufficiently large. The following example demonstrates how to determine the proper value for R₁.

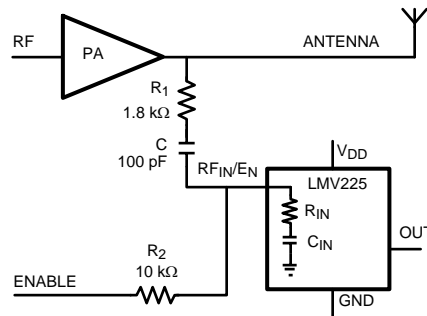

Figure 66. Typical LMV225 Application with High Resistive Tap

Suppose the useful output power of the PA ranges up to +31 dBm. As the LMV225 can handle input power levels up to 0 dBm. R₁ should realize a minimum attenuation of 31 - 0 = 31 dB. The attenuation realized by R₁ and the effective input resistance R_{IN} of the detector equals:

$$A_{dB} = 20 \cdot \text{LOG} \left[1 + \frac{R_1}{R_{IN}} \right] = 31 \text{ dB} \tag{1}$$

Solving this expression for R₁, using that R_{IN} = 50Ω, yields:

$$R_1 = \left[10^{\frac{A_{dB}}{20}} - 1 \right] \cdot R_{IN} = \left[10^{\frac{31}{20}} - 1 \right] \cdot 50 = 1724 \Omega \tag{2}$$

In Figure 66, R₁ is set to 1800Ω resulting in an attenuation of 31.4 dB.

DIRECTIONAL COUPLER APPLICATION

The LMV226/LMV228 also has a 50Ω input resistance. However, its input range differs compared to the LMV225, i.e. -15 dBm to +15 dBm. If a typical attenuation of a directional coupler is 20 dB, the LMV226/LMV228 can be directly connected via the directional coupler to the PA without the need of additional external attenuator (Figure 67). Different PA ranges can be configured using couplers with other coupling factors.

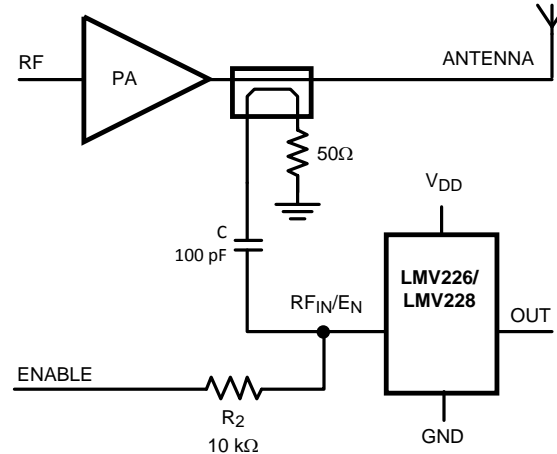

Figure 67. Typical LMV226/LMV228 Application with Directional Coupler

SHUTDOWN FUNCTIONALITY

The LMV225/LMV226/LMV228 RF_{IN}/E_N pins have 2 functions combined:

- Enable/Shutdown
- Power input

The capacitor C and the resistor R₂ (Figure 66 and Figure 67) separate the DC shutdown functionality from the AC power measurement. The device is active when Enable = HI, otherwise it is in a low power consumption shutdown mode. During shutdown the output will be LOW.

Capacitor C should be chosen sufficiently large to ensure a corner frequency far below the lowest input frequency to be measured. In case of the LMV225 the corner frequency can be calculated using:

$$f = \frac{1}{2\pi(R_1 + R_{IN}) \frac{C \cdot C_{IN}}{C + C_{IN}}}$$

where

- R_{IN} = 50Ω, C_{IN} = 45 pF typical (3)

With R₁ = 1800Ω and C = 100 pF, this results in a corner frequency of 2.8 MHz. This corner frequency is an indicative number. The goal is to have a magnitude transfer, which is sufficiently flat in the used frequency range; capacitor C should be chosen significantly larger than capacitor C_{IN} to assure a proper performance of the high resistive tap. Capacitor C shouldn't be chosen excessively large since the RC-time, it introduces in combination with resistor R₂, adds to the turn-on time of the device.

The LMV226/LMV228 do not use a resistor R₁ like the LMV225. Though a resistor is seen on the coupler side (R_{COUPLER}). Therefore a similar equation holds for the LMV226/LMV228 LF corner frequency, where R₁ is replaced with the coupler output impedance (R_{COUPLER}).

With R_{COUPLER} = 50Ω and C = 100 pF, the resulting corner frequency is 50 MHz.

The output voltage is proportional to the logarithm of the input power, often called "linear-in-dB". Figure 68 shows the typical output voltage versus PA output power of the LMV225 setup as depicted in Figure 66.

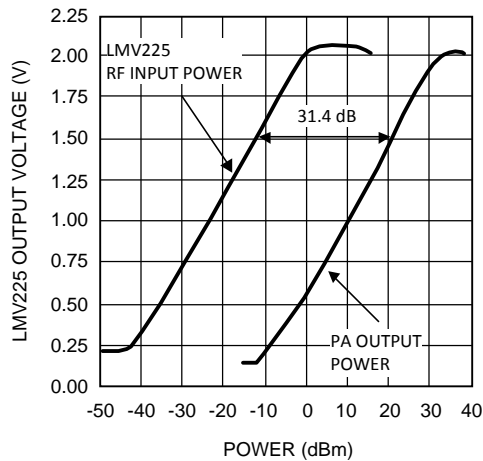

Figure 68. Typical power detector response, V_{OUT} vs. PA output Power

OUTPUT RIPPLE DUE TO AM MODULATION

A CDMA modulated carrier wave generally contains some amplitude modulation that might disturb the RF power measurement used for controlling the PA. This section explains the relation between amplitude modulation in the RF signal and the ripple on the output of the LMV225/LMV228. Expressions are provided to estimate this ripple on the output. The ripple can be further reduced by lowpass filtering at the output. This is realized by connecting an capacitor from the output of the LMV225/LMV228 to ground.

Estimating Output Ripple

The CDMA modulated RF input signal of Figure 68 can be described as:

$$V_{IN}(t) = V_{IN} [1 + \mu(t)] \cos(2 \cdot \pi \cdot f \cdot t)$$

where

- V_{IN} is the amplitude of the carrier frequency
- Amplitude modulation $\mu(t)$ can be between -1 and 1

(4)

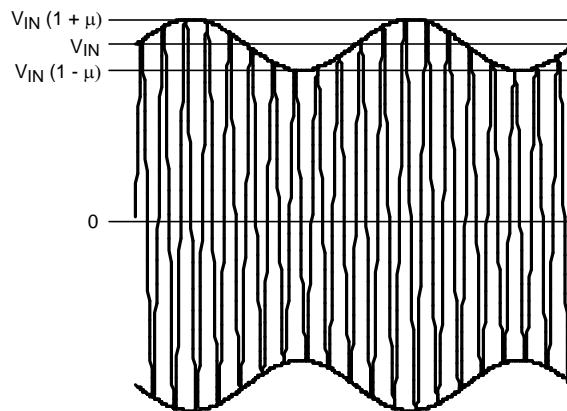

Figure 69. AM Modulated RF Signal

The ripple observed at the output of the detector equals the detectors response to the power variation at the input due to AM modulation (Figure 69). This signal has a maximum amplitude $V_{IN} \cdot (1+\mu)$ and a minimum amplitude $V_{IN} \cdot (1-\mu)$, where $1+\mu$ can be maximum 2 and $1-\mu$ can be minimum 0. The amplitude of the ripple can be described with the formula:

$$V_{RIPPLE} = V_Y \left[10 \text{ LOG} \left[\frac{V_{IN}^2 (1 + \mu)^2}{2R_{IN}} \right] + 30 \right] - V_Y \left[10 \text{ LOG} \left[\frac{V_{IN}^2 (1 - \mu)^2}{2R_{IN}} \right] + 30 \right]$$

P_{INMAX} IN dBm P_{INMIN} IN dBm

where

- V_Y is the slope of the detection curve (Figure 70)
 - μ is the modulation index
- (5)

Equation 5 can be reduced to:

$$V_{RIPPLE} = V_Y \cdot 20 \text{ LOG} \left[\frac{1 + \mu}{1 - \mu} \right]$$

(6)

Consequently, the ripple is independent of the average input power of the RF input signal and only depends on the logarithmic slope V_Y and the ratio of the maximum and the minimum input signal amplitude.

For CDMA, the ratio of the maximum and the minimum input signal amplitude modulation is typically in the order of 5 to 6 dB, which is equivalent to a modulation index μ of 0.28 to 0.33.

A further understanding of the equation above can be achieved via the knowledge that the output voltage V_{OUT} of the LMV225/LMV228 is linear in dB, or proportional to the input power P_{IN} in dBm. As discussed earlier, CDMA has a modulation in the order of 5 to 6 dB. Since the transfer is linear in dB, the output voltage V_{OUT} will vary linearly over about 5 to 6 dB in the curve (Figure 70).

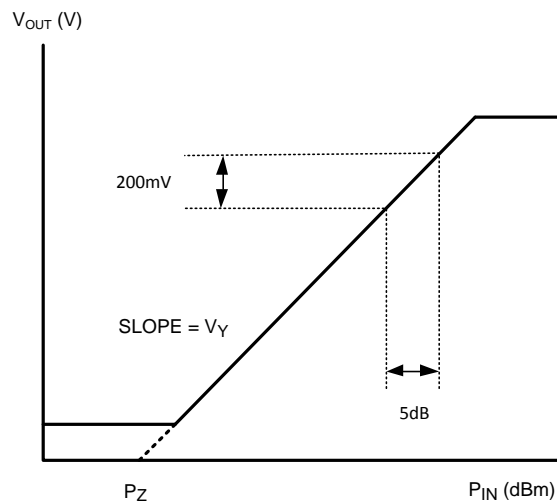

Figure 70. V_{OUT} vs. RF Input Power P_{IN}

The output voltage variation ΔV_{OUT} is thus identical for RF input signals that fall within the linear range (in dB) of the detector. In other words, the output variation is independent of the absolute RF input signal:

$$\Delta V_O = V_Y \cdot \Delta P_{IN}$$

(7)

In which V_Y is the slope of the curve. The log-conformance error is usually much smaller than the ripple due to AM modulation. In case of the LMV225/LMV228, $V_Y = 40$ mV/dB. With $\Delta P_{IN} = 5$ dB for CDMA, $\Delta V_{OUT} = 200$ mV_{PP}. This is valid for all V_{OUT} .

Output Ripple with Additional Filtering

The calculated result above is for an unfiltered configuration. When a low pass filter is used by shunting a capacitor of e.g. $C_{OUT} = 1.5 \text{ nF}$ at the output of the LMV225/LMV228 to ground, this ripple is further attenuated. The cut-off frequency follows from:

$$f_c = \frac{1}{2 \pi C_{OUT} R_O} \tag{8}$$

With the output resistance of the LMV225/LMV228 $R_O = 19.8 \text{ k}\Omega$ typical and $C_{OUT} = 1.5 \text{ nF}$, the cut-off frequency equals $f_c = 5.36 \text{ kHz}$. A 100 kHz AM signal then gets attenuated by $5.36/100$ or 25.4 dB. The remaining ripple will be less than 20 mV. With a slope of 40 mV/dB this translates into an error of less than $\pm 0.5 \text{ dB}$. Since the LMV226 has a low output impedance buffer, a capacitor to reduce the ripple will not be effective.

Output Ripple Measurement

Figure 71 shows the ripple reduction that can be achieved by adding additional capacitance at the output of the LMV225/LMV228. The RF signal of 900 MHz is AM modulated with a 100 kHz sinewave and a modulation index of 0.3. The RF input power is swept while the modulation index remains unchanged. Without the output capacitor the ripple is about 200 mV_{PP}. Connecting a capacitor of 1.5 nF at the output to ground, results in a ripple of 12 mV_{PP}. The attenuation with a 1.5 nF capacitor is then $20 \cdot \log(200/12) = 24.4 \text{ dB}$. This is very close to the calculated number of the previous paragraph.

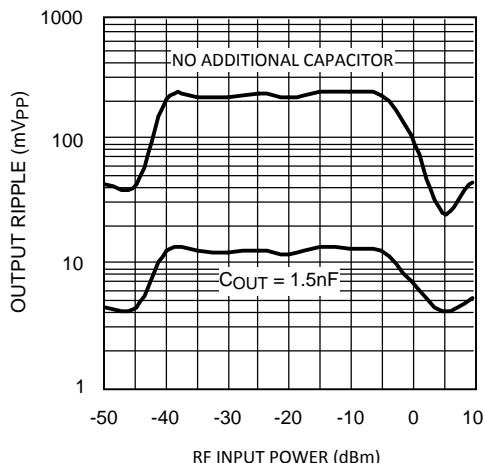

Figure 71. Output Ripple vs. RF Input Power

PRINCIPLE OF OPERATION

The logarithmic response of the LMV225/LMV226/LMV228 is implemented by a logarithmic amplifier as shown in Figure 72. The logarithmic amplifier consists of a number of cascaded linear gain cells. With these gain cells, a piecewise approximation of the logarithmic function is constructed.

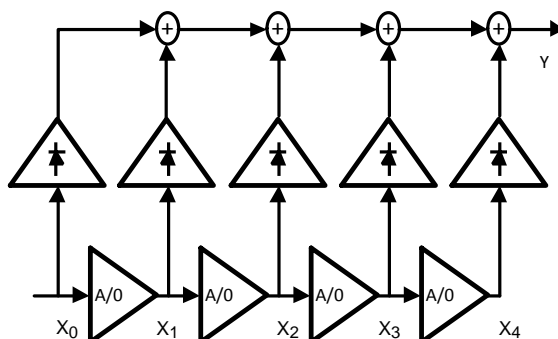

Figure 72. Logarithmic Amplifier

Every gain cell has a response according to Figure 73. At a certain threshold (E_K), the gain cell starts to saturate, which means that the gain drops to zero. The output of gain cell 1 is connected to the input of gain cell 2 and so on.

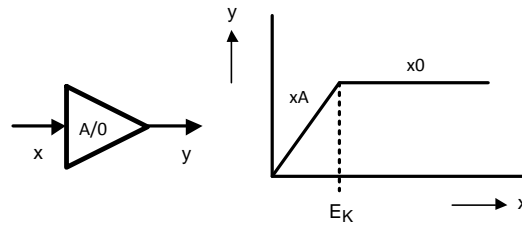

Figure 73. Gain Cell

All gain cell outputs are AM-demodulated with a peak detector and summed together. This results in a logarithmic function. The logarithmic range is about:

$$20 \cdot n \cdot \log(A)$$

where

- n = number of gain cells
 - A = gain per gaincell
- (9)

Figure 74 shows a logarithmic function on a linear scale and the piecewise approximation of the logarithmic function.

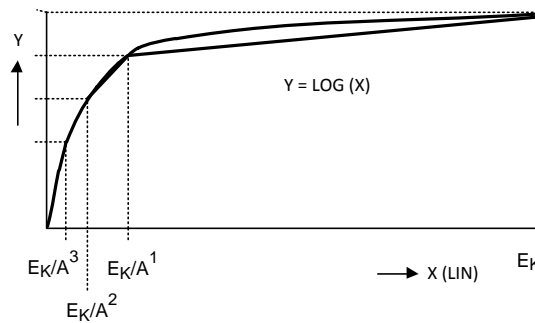

Figure 74. Log-Function on Lin Scale

Figure 75 shows a logarithmic function on a logarithmic scale and the piecewise approximation of the logarithmic function.

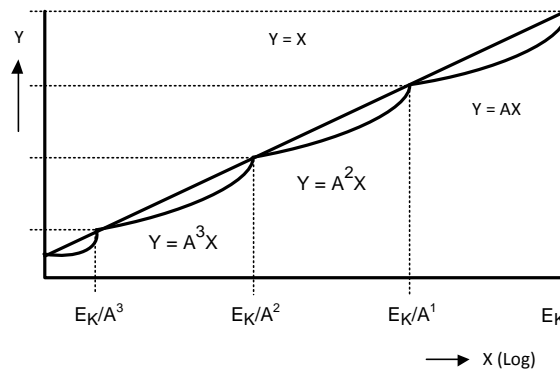

Figure 75. Log-Function on Log Scale

The maximum error for this approximation occurs at the geometric mean of a gain section, which is e.g. for the third segment:

$$\sqrt{\frac{E_K}{A^2} \cdot \frac{E_K}{A^1}} = \frac{E_K}{A\sqrt{A}} \quad (10)$$

The size of the error increases with distance between the thresholds.

LAYOUT CONSIDERATIONS

For a proper functioning part a good board layout is necessary. Special care should be taken for the series resistance R_1 (Figure 66) that determines the attenuation. For high resistor values the parasitic capacitance of the resistor may significantly impact the realized attenuation. The effective attenuation will be lower than intended. To reduce the parasitic capacitance across resistor R_1 , this resistor can be composed of several components in series instead of using a single component.

REVISION HISTORY

Changes from Revision K (March 2013) to Revision L	Page
• Changed layout of National Data Sheet to TI format	28

PACKAGING INFORMATION

Orderable part number	Status (1)	Material type (2)	Package Pins	Package qty Carrier	RoHS (3)	Lead finish/ Ball material (4)	MSL rating/ Peak reflow (5)	Op temp (°C)	Part marking (6)
LMV225SD/NOPB	Active	Production	WSO (NGF) 6	1000 SMALL T&R	Yes	SN	Level-1-260C-UNLIM	-40 to 85	A90
LMV225SD/NOPB.A	Active	Production	WSO (NGF) 6	1000 SMALL T&R	Yes	SN	Level-1-260C-UNLIM	-40 to 85	A90
LMV225SDX/NOPB	Active	Production	WSO (NGF) 6	4500 LARGE T&R	Yes	SN	Level-1-260C-UNLIM	-40 to 85	A90
LMV225SDX/NOPB.A	Active	Production	WSO (NGF) 6	4500 LARGE T&R	Yes	SN	Level-1-260C-UNLIM	-40 to 85	A90
LMV225TL/NOPB	Active	Production	DSBGA (YZR) 4	250 SMALL T&R	Yes	SNAGCU	Level-1-260C-UNLIM	-40 to 85	
LMV225TL/NOPB.A	Active	Production	DSBGA (YZR) 4	250 SMALL T&R	Yes	SNAGCU	Level-1-260C-UNLIM	-40 to 85	
LMV225TLX/NOPB	Active	Production	DSBGA (YZR) 4	3000 LARGE T&R	Yes	SNAGCU	Level-1-260C-UNLIM	-40 to 85	
LMV225TLX/NOPB.A	Active	Production	DSBGA (YZR) 4	3000 LARGE T&R	Yes	SNAGCU	Level-1-260C-UNLIM	-40 to 85	
LMV225UR/NOPB	Active	Production	DSBGA (YPD) 4	250 SMALL T&R	Yes	SNAGCU	Level-1-260C-UNLIM	-40 to 85	
LMV225UR/NOPB.A	Active	Production	DSBGA (YPD) 4	250 SMALL T&R	Yes	SNAGCU	Level-1-260C-UNLIM	-40 to 85	
LMV225URX/NOPB	Active	Production	DSBGA (YPD) 4	3000 LARGE T&R	Yes	SNAGCU	Level-1-260C-UNLIM	-40 to 85	
LMV225URX/NOPB.A	Active	Production	DSBGA (YPD) 4	3000 LARGE T&R	Yes	SNAGCU	Level-1-260C-UNLIM	-40 to 85	
LMV226TL/NOPB	Active	Production	DSBGA (YZR) 4	250 SMALL T&R	Yes	SNAGCU	Level-1-260C-UNLIM	-40 to 85	
LMV226TL/NOPB.A	Active	Production	DSBGA (YZR) 4	250 SMALL T&R	Yes	SNAGCU	Level-1-260C-UNLIM	-40 to 85	
LMV226TLX/NOPB	Active	Production	DSBGA (YZR) 4	3000 LARGE T&R	Yes	SNAGCU	Level-1-260C-UNLIM	-40 to 85	
LMV226TLX/NOPB.A	Active	Production	DSBGA (YZR) 4	3000 LARGE T&R	Yes	SNAGCU	Level-1-260C-UNLIM	-40 to 85	
LMV226UR/NOPB	Active	Production	DSBGA (YPD) 4	250 SMALL T&R	Yes	SNAGCU	Level-1-260C-UNLIM	-40 to 85	
LMV226UR/NOPB.A	Active	Production	DSBGA (YPD) 4	250 SMALL T&R	Yes	SNAGCU	Level-1-260C-UNLIM	-40 to 85	
LMV228SD/NOPB	Active	Production	WSO (NGF) 6	1000 SMALL T&R	Yes	SN	Level-1-260C-UNLIM	-40 to 85	A89
LMV228SD/NOPB.A	Active	Production	WSO (NGF) 6	1000 SMALL T&R	Yes	SN	Level-1-260C-UNLIM	-40 to 85	A89
LMV228TL/NOPB	Active	Production	DSBGA (YZR) 4	250 SMALL T&R	Yes	SNAGCU	Level-1-260C-UNLIM	-40 to 85	
LMV228TL/NOPB.A	Active	Production	DSBGA (YZR) 4	250 SMALL T&R	Yes	SNAGCU	Level-1-260C-UNLIM	-40 to 85	
LMV228TLX/NOPB	Active	Production	DSBGA (YZR) 4	3000 LARGE T&R	Yes	SNAGCU	Level-1-260C-UNLIM	-40 to 85	
LMV228TLX/NOPB.A	Active	Production	DSBGA (YZR) 4	3000 LARGE T&R	Yes	SNAGCU	Level-1-260C-UNLIM	-40 to 85	

(1) **Status:** For more details on status, see our [product life cycle](#).

(2) **Material type:** When designated, preproduction parts are prototypes/experimental devices, and are not yet approved or released for full production. Testing and final process, including without limitation quality assurance, reliability performance testing, and/or process qualification, may not yet be complete, and this item is subject to further changes or possible discontinuation. If available for ordering, purchases will be subject to an additional waiver at checkout, and are intended for early internal evaluation purposes only. These items are sold without warranties of any kind.

(3) **RoHS values:** Yes, No, RoHS Exempt. See the [TI RoHS Statement](#) for additional information and value definition.

(4) **Lead finish/Ball material:** Parts may have multiple material finish options. Finish options are separated by a vertical ruled line. Lead finish/Ball material values may wrap to two lines if the finish value exceeds the maximum column width.

(5) **MSL rating/Peak reflow:** The moisture sensitivity level ratings and peak solder (reflow) temperatures. In the event that a part has multiple moisture sensitivity ratings, only the lowest level per JEDEC standards is shown. Refer to the shipping label for the actual reflow temperature that will be used to mount the part to the printed circuit board.

(6) **Part marking:** There may be an additional marking, which relates to the logo, the lot trace code information, or the environmental category of the part.

Multiple part markings will be inside parentheses. Only one part marking contained in parentheses and separated by a "~" will appear on a part. If a line is indented then it is a continuation of the previous line and the two combined represent the entire part marking for that device.

Important Information and Disclaimer:The information provided on this page represents TI's knowledge and belief as of the date that it is provided. TI bases its knowledge and belief on information provided by third parties, and makes no representation or warranty as to the accuracy of such information. Efforts are underway to better integrate information from third parties. TI has taken and continues to take reasonable steps to provide representative and accurate information but may not have conducted destructive testing or chemical analysis on incoming materials and chemicals. TI and TI suppliers consider certain information to be proprietary, and thus CAS numbers and other limited information may not be available for release.

In no event shall TI's liability arising out of such information exceed the total purchase price of the TI part(s) at issue in this document sold by TI to Customer on an annual basis.

TAPE AND REEL INFORMATION

QUADRANT ASSIGNMENTS FOR PIN 1 ORIENTATION IN TAPE

*All dimensions are nominal

Device	Package Type	Package Drawing	Pins	SPQ	Reel Diameter (mm)	Reel Width W1 (mm)	A0 (mm)	B0 (mm)	K0 (mm)	P1 (mm)	W (mm)	Pin1 Quadrant
LMV225SD/NOPB	WSON	NGF	6	1000	177.8	12.4	2.8	2.5	1.0	8.0	12.0	Q1
LMV225SDX/NOPB	WSON	NGF	6	4500	330.0	12.4	2.8	2.5	1.0	8.0	12.0	Q1
LMV225TL/NOPB	DSBGA	YZR	4	250	178.0	8.4	1.09	1.09	0.76	4.0	8.0	Q1
LMV225TLX/NOPB	DSBGA	YZR	4	3000	178.0	8.4	1.09	1.09	0.76	4.0	8.0	Q1
LMV225UR/NOPB	DSBGA	YPD	4	250	178.0	8.4	1.04	1.04	0.56	4.0	8.0	Q1
LMV225URX/NOPB	DSBGA	YPD	4	3000	178.0	8.4	1.04	1.04	0.56	4.0	8.0	Q1
LMV226TL/NOPB	DSBGA	YZR	4	250	178.0	8.4	1.09	1.09	0.76	4.0	8.0	Q1
LMV226TLX/NOPB	DSBGA	YZR	4	3000	178.0	8.4	1.09	1.09	0.76	4.0	8.0	Q1
LMV226UR/NOPB	DSBGA	YPD	4	250	178.0	8.4	1.04	1.04	0.56	4.0	8.0	Q1
LMV228SD/NOPB	WSON	NGF	6	1000	177.8	12.4	2.8	2.5	1.0	8.0	12.0	Q1
LMV228TL/NOPB	DSBGA	YZR	4	250	178.0	8.4	1.09	1.09	0.76	4.0	8.0	Q1
LMV228TLX/NOPB	DSBGA	YZR	4	3000	178.0	8.4	1.09	1.09	0.76	4.0	8.0	Q1

TAPE AND REEL BOX DIMENSIONS

*All dimensions are nominal

Device	Package Type	Package Drawing	Pins	SPQ	Length (mm)	Width (mm)	Height (mm)
LMV225SD/NOPB	WSON	NGF	6	1000	208.0	191.0	35.0
LMV225SDX/NOPB	WSON	NGF	6	4500	367.0	367.0	35.0
LMV225TL/NOPB	DSBGA	YZR	4	250	208.0	191.0	35.0
LMV225TLX/NOPB	DSBGA	YZR	4	3000	208.0	191.0	35.0
LMV225UR/NOPB	DSBGA	YPD	4	250	208.0	191.0	35.0
LMV225URX/NOPB	DSBGA	YPD	4	3000	208.0	191.0	35.0
LMV226TL/NOPB	DSBGA	YZR	4	250	208.0	191.0	35.0
LMV226TLX/NOPB	DSBGA	YZR	4	3000	208.0	191.0	35.0
LMV226UR/NOPB	DSBGA	YPD	4	250	208.0	191.0	35.0
LMV228SD/NOPB	WSON	NGF	6	1000	208.0	191.0	35.0
LMV228TL/NOPB	DSBGA	YZR	4	250	208.0	191.0	35.0
LMV228TLX/NOPB	DSBGA	YZR	4	3000	208.0	191.0	35.0

YPD0004

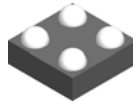

PACKAGE OUTLINE

DSBGA - 0.395 mm max height

DIE SIZE BALL GRID ARRAY

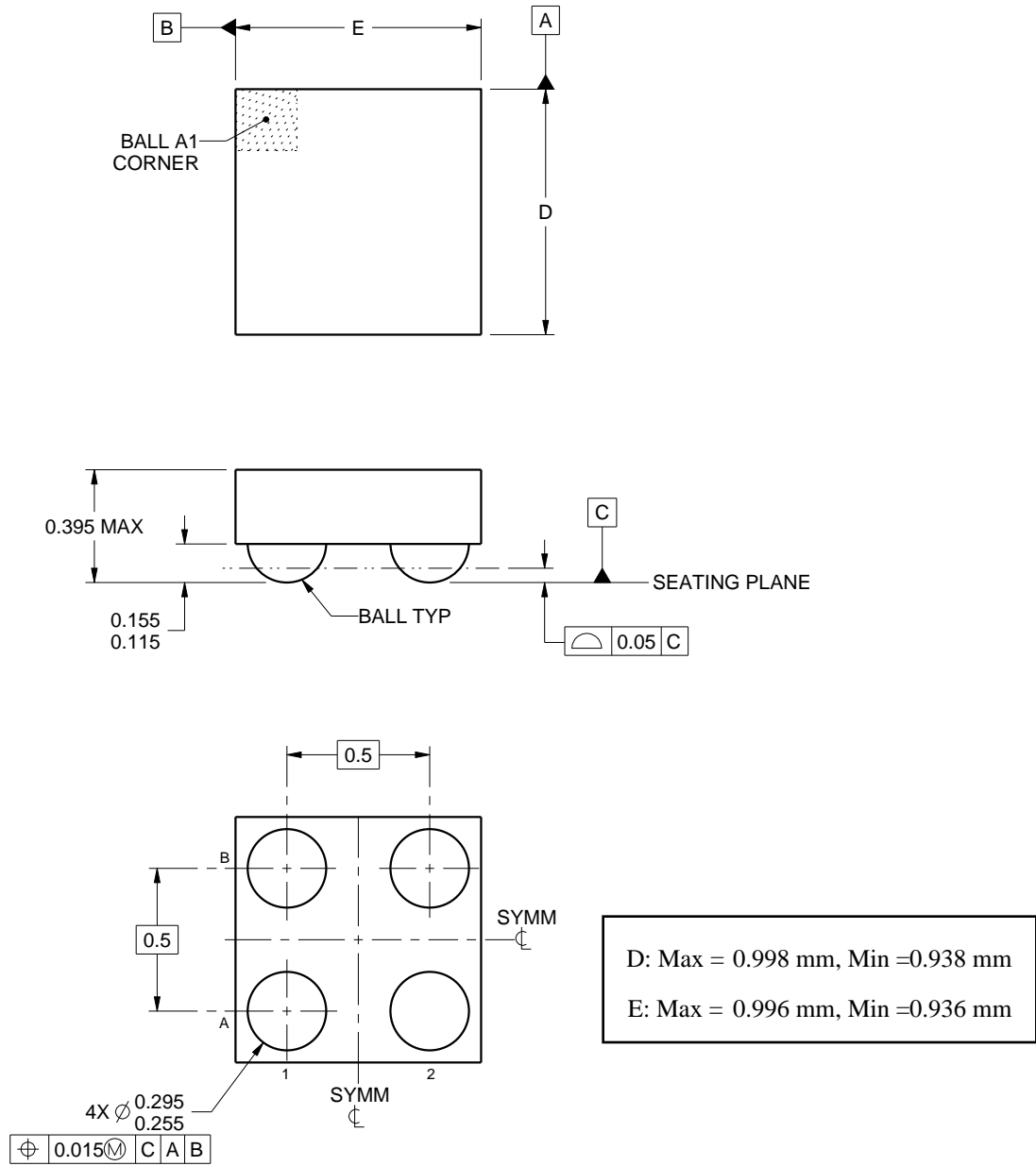

4215141/B 08/2016

NOTES:

1. All linear dimensions are in millimeters. Any dimensions in parenthesis are for reference only. Dimensioning and tolerancing per ASME Y14.5M.
2. This drawing is subject to change without notice.

EXAMPLE BOARD LAYOUT

YPD0004

DSBGA - 0.395 mm max height

DIE SIZE BALL GRID ARRAY

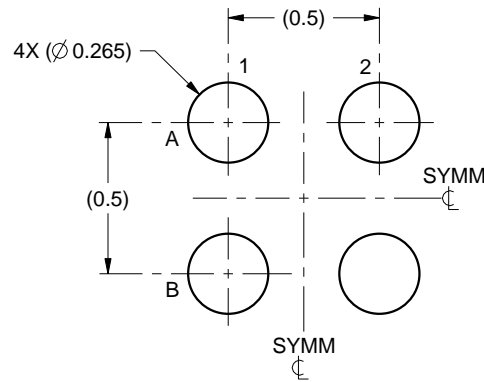

LAND PATTERN EXAMPLE
SCALE:40X

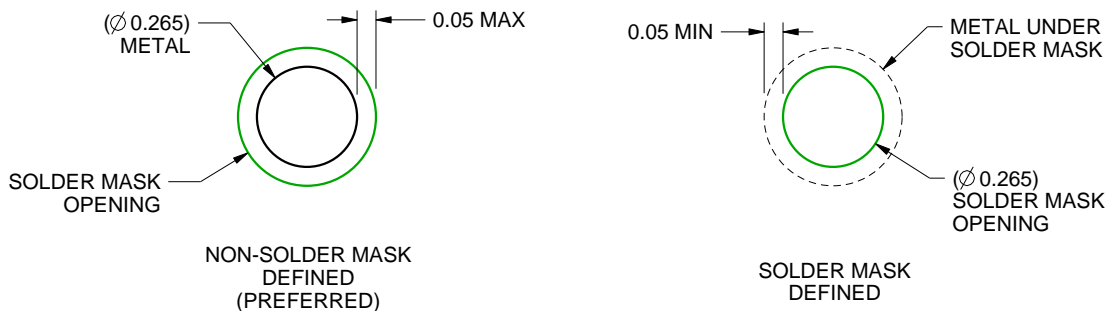

SOLDER MASK DETAILS
NOT TO SCALE

4215141/B 08/2016

NOTES: (continued)

3. Final dimensions may vary due to manufacturing tolerance considerations and also routing constraints. See Texas Instruments Literature No. SNVA009 (www.ti.com/lit/snva009).

EXAMPLE STENCIL DESIGN

YPD0004

DSBGA - 0.395 mm max height

DIE SIZE BALL GRID ARRAY

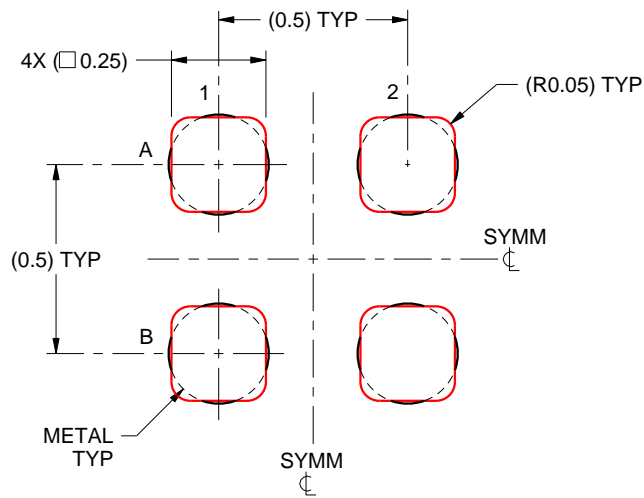

SOLDER PASTE EXAMPLE
BASED ON 0.1 mm THICK STENCIL
SCALE:50X

4215141/B 08/2016

NOTES: (continued)

4. Laser cutting apertures with trapezoidal walls and rounded corners may offer better paste release.

YZR0004

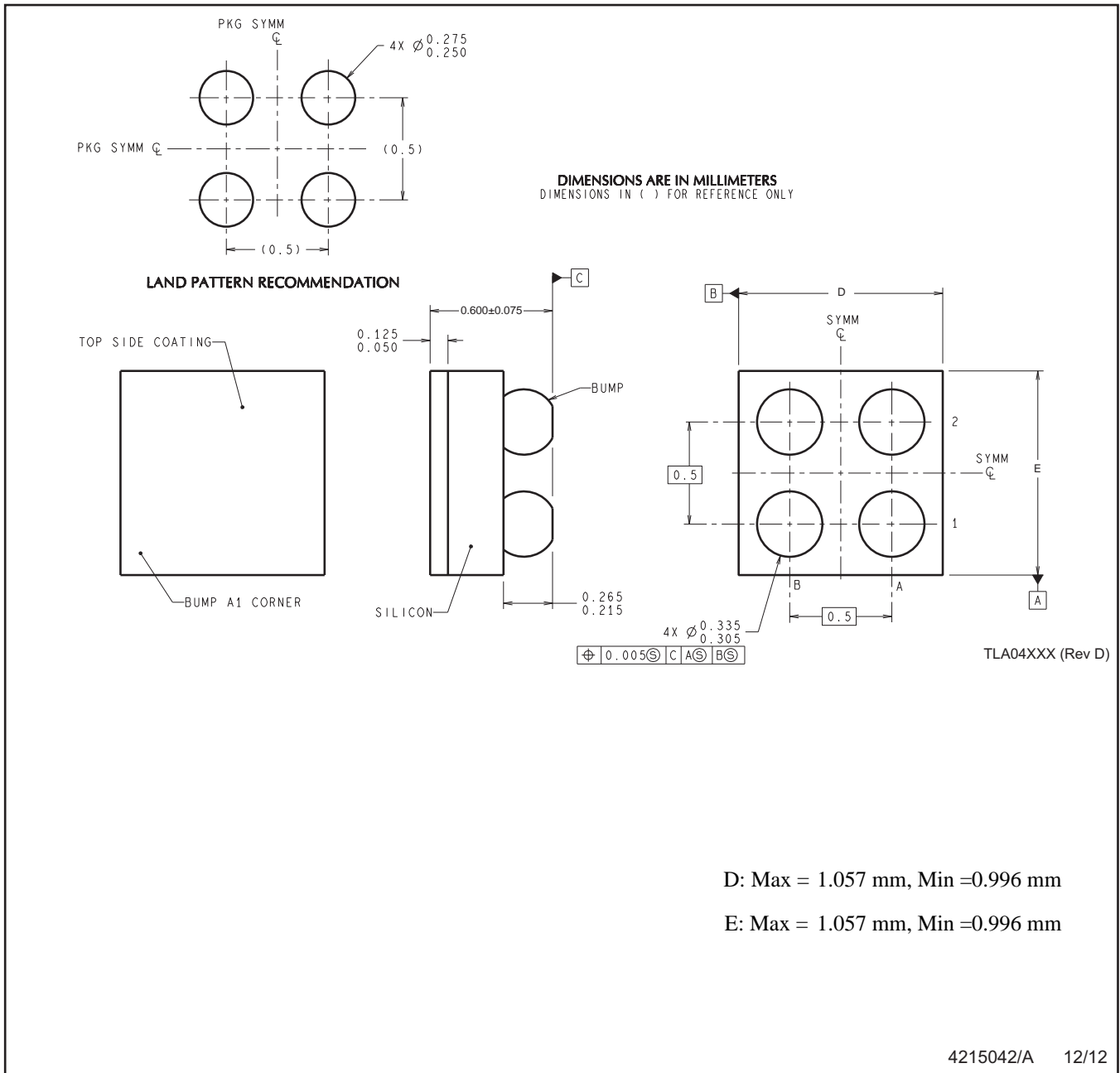

NOTES: A. All linear dimensions are in millimeters. Dimensioning and tolerancing per ASME Y14.5M-1994.
B. This drawing is subject to change without notice.

4215042/A 12/12

NGF0006A

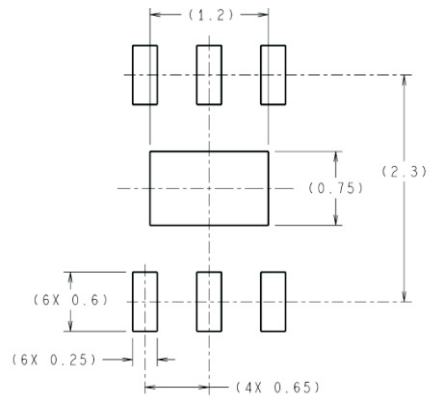

DIMENSIONS ARE IN MILLIMETERS
DIMENSIONS IN () FOR REFERENCE ONLY

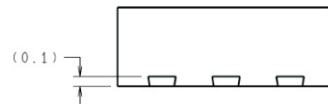

RECOMMENDED LAND PATTERN

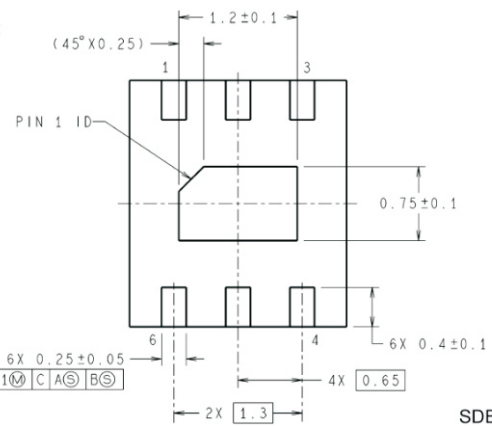
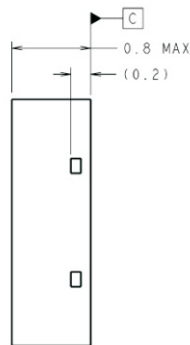
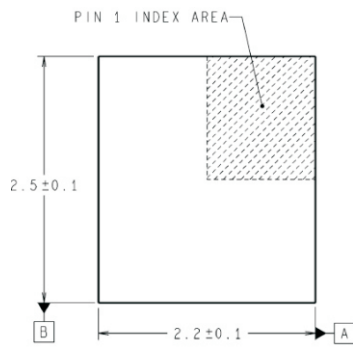

SDB06A (Rev A)

IMPORTANT NOTICE AND DISCLAIMER

TI PROVIDES TECHNICAL AND RELIABILITY DATA (INCLUDING DATASHEETS), DESIGN RESOURCES (INCLUDING REFERENCE DESIGNS), APPLICATION OR OTHER DESIGN ADVICE, WEB TOOLS, SAFETY INFORMATION, AND OTHER RESOURCES "AS IS" AND WITH ALL FAULTS, AND DISCLAIMS ALL WARRANTIES, EXPRESS AND IMPLIED, INCLUDING WITHOUT LIMITATION ANY IMPLIED WARRANTIES OF MERCHANTABILITY, FITNESS FOR A PARTICULAR PURPOSE OR NON-INFRINGEMENT OF THIRD PARTY INTELLECTUAL PROPERTY RIGHTS.

These resources are intended for skilled developers designing with TI products. You are solely responsible for (1) selecting the appropriate TI products for your application, (2) designing, validating and testing your application, and (3) ensuring your application meets applicable standards, and any other safety, security, regulatory or other requirements.

These resources are subject to change without notice. TI grants you permission to use these resources only for development of an application that uses the TI products described in the resource. Other reproduction and display of these resources is prohibited. No license is granted to any other TI intellectual property right or to any third party intellectual property right. TI disclaims responsibility for, and you fully indemnify TI and its representatives against any claims, damages, costs, losses, and liabilities arising out of your use of these resources.

TI's products are provided subject to [TI's Terms of Sale](#), [TI's General Quality Guidelines](#), or other applicable terms available either on [ti.com](#) or provided in conjunction with such TI products. TI's provision of these resources does not expand or otherwise alter TI's applicable warranties or warranty disclaimers for TI products. Unless TI explicitly designates a product as custom or customer-specified, TI products are standard, catalog, general purpose devices.

TI objects to and rejects any additional or different terms you may propose.

Copyright © 2026, Texas Instruments Incorporated

Last updated 10/2025