

## FEATURES

- Available in the Texas Instruments NanoFree™ Package
- Low Static-Power Consumption ( $I_{CC} = 0.9 \mu\text{A Max}$ )
- Low Dynamic-Power Consumption ( $C_{pd} = 5 \text{ pF Typ at } 3.3 \text{ V}$ )
- Low Input Capacitance ( $C_i = 1.5 \text{ pF}$ )
- Low Noise – Overshoot and Undershoot <math><10\% \text{ of } V\_{CC}</math>
- Input-Disable Feature Allows Floating Input Conditions
- $I_{off}$  Supports Partial-Power-Down Mode Operation
- Includes Schmitt-Trigger Inputs
- Wide Operating  $V_{CC}$  Range of 0.8 V to 3.6 V
- Optimized for 3.3-V Operation
- 3.6-V I/O Tolerant to Support Mixed-Mode Signal Operation
- $t_{pd} = 7.4 \text{ ns Max at } 3.3 \text{ V}$
- Suitable for Point-to-Point Applications
- Latch-Up Performance Exceeds 100 mA Per JESD 78, Class II
- ESD Performance Tested Per JESD 22
  - 2000-V Human-Body Model (A114-B, Class II)
  - 200-V Machine Model (A115-A)
  - 1000-V Charged-Device Model (C101)

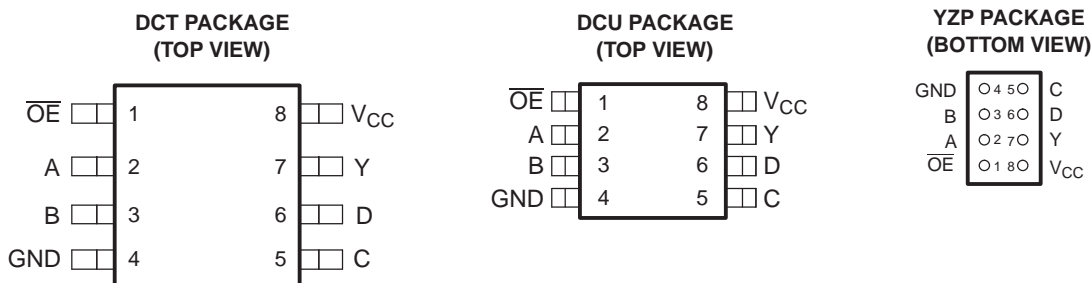

See mechanical drawings for dimensions.

## DESCRIPTION/ORDERING INFORMATION

The AUP family is TI's premier solution to the industry's low-power needs in battery-powered portable applications. This family ensures a very low static- and dynamic-power consumption across the entire  $V_{CC}$  range of 0.8 V to 3.6 V, resulting in an increased battery life. This product also maintains excellent signal integrity (see Figures 1 and 2).

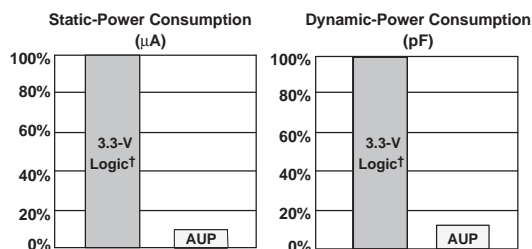

† Single, dual, and triple gates

**Figure 1. AUP - The Lowest-Power Family**

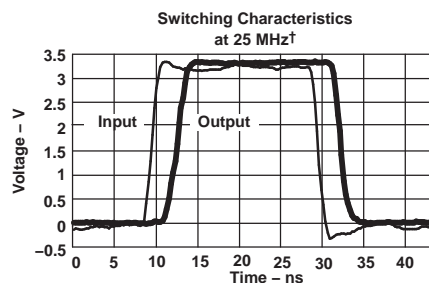

† AUP1G08 data at  $C_L = 15 \text{ pF}$

**Figure 2. Excellent Signal Integrity**



Please be aware that an important notice concerning availability, standard warranty, and use in critical applications of Texas Instruments semiconductor products and disclaimers thereto appears at the end of this data sheet.

NanoFree is a trademark of Texas Instruments.

# SN74AUP1G99

## LOW-POWER ULTRA-CONFIGURABLE MULTIPLE-FUNCTION GATE WITH 3-STATE OUTPUTS

SCES594C–JULY 2004–REVISED DECEMBER 2007

### DESCRIPTION/ORDERING INFORMATION

The SN74AUP1G99 features configurable multiple functions with a 3-state output. This device has the input-disable feature, which allows floating input signals. The inputs and output are disabled when the output-enable ( $\overline{OE}$ ) input is high. When  $\overline{OE}$  is low, the output state is determined by 16 patterns of 4-bit input. The user can choose the logic functions, such as MUX, AND, OR, NAND, NOR, XOR, XNOR, inverter, and buffer. All inputs can be connected to  $V_{CC}$  or GND.

This device functions as an independent gate with Schmitt-trigger inputs, which allows for slow input transition and better switching noise immunity at the input.

To ensure the high-impedance state during power up or power down,  $\overline{OE}$  should be tied to  $V_{CC}$  through a pullup resistor; the minimum value of the resistor is determined by the current-sinking capability of the driver.

NanoStar™ and NanoFree™ package technology is a major breakthrough in IC packaging concepts, using the die as the package.

This device is fully specified for partial-power-down applications using  $I_{off}$ . The  $I_{off}$  circuitry disables the outputs, preventing damaging current backflow through the device when it is powered down.

### ORDERING INFORMATION

$T_A$	PACKAGE <sup>(1)(2)</sup>		ORDERABLE PART NUMBER	TOP-SIDE MARKING <sup>(3)</sup>
–40°C to 85°C	NanoFree™ – WCSP (DSBGA) 0.23-mm Large Bump – YZP (Pb-free)	Tape and reel	SN74AUP1G99YZPR	__ HY_
	SSOP – DCT	Tape and reel	SN74AUP1G99DCTR	H99_ _ _
	VSSOP – DCU	Tape and reel	SN74AUP1G99DCUR	H99_

(1) Package drawings, thermal data, and symbolization are available at [www.ti.com/packaging](http://www.ti.com/packaging).

(2) For the most current package and ordering information, see the Package Option Addendum at the end of this document, or see the TI website at [www.ti.com](http://www.ti.com).

(3) DCT: The actual top-side marking has three additional characters that designate the year, month, and assembly/test site.

DCU: The actual top-side marking has one additional character that designates the assembly/test site.

YZP: The actual top-side marking has three preceding characters to denote year, month, and sequence code, and one following character to designate the assembly/test site. Pin 1 identifier indicates solder-bump composition (1 = SnPb, • = Pb-free).

**FUNCTION TABLE**

INPUTS					OUTPUT Y
$\overline{OE}$	D	C	B	A	
L	L	L	L	L	L
L	L	L	L	H	H
L	L	L	H	L	L
L	L	L	H	H	H
L	L	H	L	L	L
L	L	H	L	H	L
L	L	H	H	L	H
L	L	H	H	H	H
L	H	L	L	L	H
L	H	L	L	H	L
L	H	L	H	L	H
L	H	L	H	H	L
L	H	H	L	L	H
L	H	H	L	H	H
L	H	H	H	L	L
L	H	H	H	H	L
H	X <sup>(1)</sup>	X <sup>(1)</sup>	X <sup>(1)</sup>	X <sup>(1)</sup>	Z

(1) Floating inputs allowed.

**LOGIC DIAGRAM (POSITIVE LOGIC)**

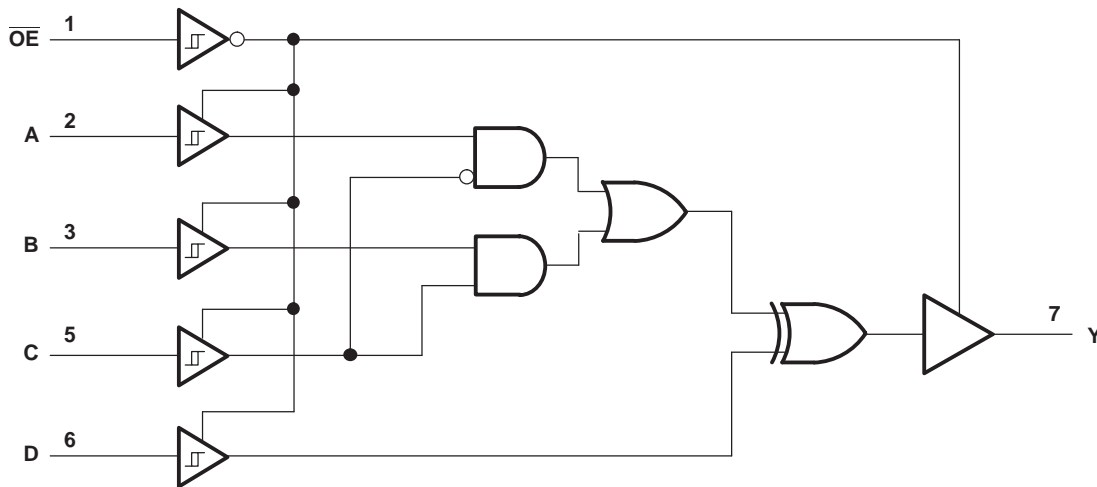

# SN74AUP1G99 LOW-POWER ULTRA-CONFIGURABLE MULTIPLE-FUNCTION GATE WITH 3-STATE OUTPUTS

SCES594C—JULY 2004—REVISED DECEMBER 2007

## FUNCTION SELECTION TABLE

PRIMARY FUNCTION	COMPLEMENTARY FUNCTION	PAGE
3-state buffer		4
3-state inverter		4
3-state 2-to-1 data selector MUX		5
3-state 2-to-1 data selector MUX, inverted out		5
3-state 2-input AND	3-state 2-input NOR, both inputs inverted	5
3-state 2-input AND, 1 input inverted	3-state 2-input NOR, 1 input inverted	5
3-state 2-input AND, both inputs inverted	3-state 2-input NOR	5
3-state 2-input NAND	3-state 2-input OR, both inputs inverted	6
3-state 2-input NAND, 1 input inverted	3-state 2-input OR, 1 input inverted	6
3-state 2-input NAND, both inputs inverted	3-state 2-input OR	6
3-state 2-input XOR		6
3-state 2-input XNOR	3-state 2-input XOR, 1 input inverted	7

### 3-STATE BUFFER FUNCTIONS AVAILABLE

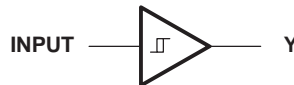

FUNCTION	$\overline{OE}$	A	B	C	D
3-state buffer	L	Input	X	L	L
		X	Input	H	L
		L	H	Input	L
		H	L	Input	H
		H	X	L	Input
		X	L	H	Input
		L	L	X	Input

### 3-STATE INVERTER FUNCTIONS AVAILABLE

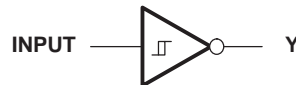

FUNCTION	$\overline{OE}$	A	B	C	D
3-state inverter	L	Input	X	L	H
		X	Input	H	H
		L	H	Input	H
		H	L	Input	L
		H	X	L	Input
		X	H	H	Input
		H	H	X	Input

3-STATE MUX FUNCTIONS AVAILABLE



FUNCTION	$\overline{OE}$	A	B	C	D
3-state 2-to-1, data selector MUX	L	Input 1	Input 2	$\overline{\text{Input 1}}$ or Input 2	L
3-state 2-to-1, data selector MUX		Input 2	Input 1	$\overline{\text{Input 2}}$ or Input 1	L
3-state 2-to-1, data selector MUX, inverted out		Input 1	Input 2	$\overline{\text{Input 1}}$ or Input 2	H
3-state 2-to-1, data selector MUX, inverted out		Input 2	Input 1	$\overline{\text{Input 2}}$ or Input 1	H

3-STATE AND/NOR FUNCTIONS AVAILABLE



NO. OF INPUTS	AND/NAND FUNCTION	OR/NOR FUNCTION	$\overline{OE}$	A	B	C	D
2	3-state AND	3-state NOR, both inputs inverted	L	L	Input 1	Input 2	L
2	3-state AND	3-state NOR, both inputs inverted		L	L	Input 2	Input 1



NO. OF INPUTS	AND/NAND FUNCTION	OR/NOR FUNCTION	$\overline{OE}$	A	B	C	D
2	3-state AND, with A inverted	3-state NOR, with B inverted	L	Input 2	L	Input 1	L
2	3-state AND, with A inverted	3-state NOR, with B inverted		H	Input 1	Input 2	H



NO. OF INPUTS	AND/NAND FUNCTION	OR/NOR FUNCTION	$\overline{OE}$	A	B	C	D
2	3-state AND, with B inverted	3-state NOR, with A inverted	L	Input 1	L	Input 2	L
2	3-state AND, with B inverted	3-state NOR, with A inverted		H	Input 2	Input 1	H



NO. OF INPUTS	AND/NAND FUNCTION	OR/NOR FUNCTION	$\overline{OE}$	A	B	C	D
2	3-state AND, both inverted inputs	3-state NOR	L	Input 1	H	Input 2	H
2	3-state AND, both inverted inputs	3-state NOR		Input 2	H	Input 1	H

# SN74AUP1G99

## LOW-POWER ULTRA-CONFIGURABLE MULTIPLE-FUNCTION GATE WITH 3-STATE OUTPUTS

SCES594C—JULY 2004—REVISED DECEMBER 2007

### 3-STATE NAND/OR FUNCTIONS AVAILABLE

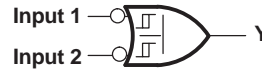
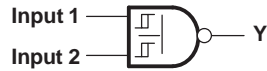

NO. OF INPUTS	AND/NAND FUNCTION	OR/NOR FUNCTION	$\overline{OE}$	A	B	C	D
2	3-state NAND	3-state OR, with both inputs inverted	L	L	Input 1	Input 2	H
2	3-state NAND	3-state OR, with both inputs inverted		L	Input 2	Input 1	H

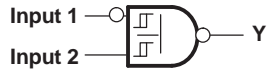

NO. OF INPUTS	AND/NAND FUNCTION	OR/NOR FUNCTION	$\overline{OE}$	A	B	C	D
2	3-state NAND, with A inverted	3-state OR, with B inverted	L	Input 2	L	Input 1	H
2	3-state NAND, with A inverted	3-state OR, with B inverted		H	Input 1	Input 2	L

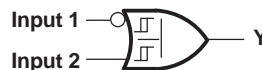
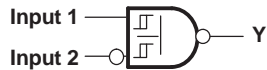

NO. OF INPUTS	AND/NAND FUNCTION	OR/NOR FUNCTION	$\overline{OE}$	A	B	C	D
2	3-state NAND, with B inverted	3-state OR, with A inverted	L	Input 1	L	Input 2	H
2	3-state NAND, with B inverted	3-state OR, with A inverted		H	Input 2	Input 1	L

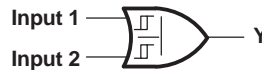
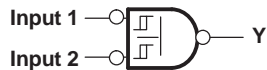

NO. OF INPUTS	AND/NAND FUNCTION	OR/NOR FUNCTION	$\overline{OE}$	A	B	C	D
2	3-state NAND, with both inputs inverted	3-state OR	L	Input 1	H	Input 2	L
2	3-state NAND, with both inputs inverted	3-state OR		Input 2	H	Input 1	L

### 3-STATE XOR/XNOR FUNCTIONS AVAILABLE



FUNCTION	$\overline{OE}$	A	B	C	D
3-state XOR	L	Input 1	X	L	Input 2
		Input 2	X	L	Input 1
		X	Input 1	H	Input 2
		X	Input 2	H	Input 1
		L	H	Input 1	Input 2
		L	H	Input 2	Input 1

3-STATE XOR/XNOR FUNCTIONS AVAILABLE (continued)



FUNCTION	$\overline{OE}$	A	B	C	D
3-state XOR, with A inverted	L	H	L	Input 1	Input 2



FUNCTION	$\overline{OE}$	A	B	C	D
3-state XOR, with B inverted	L	H	L	Input 1	Input 2



FUNCTION	$\overline{OE}$	A	B	C	D
3-state XNOR	L	H	L	Input 1	Input 2
3-state XNOR		H	L	Input 2	Input 1

**Absolute Maximum Ratings<sup>(1)</sup>**

over operating free-air temperature range (unless otherwise noted)

		MIN	MAX	UNIT
$V_{CC}$	Supply voltage range	-0.5	4.6	V
$V_I$	Input voltage range <sup>(2)</sup>	-0.5	4.6	V
$V_O$	Voltage range applied to any output in the high-impedance or power-off state <sup>(2)</sup>	-0.5	4.6	V
$V_O$	Output voltage range in the high or low state <sup>(2)</sup>	-0.5	$V_{CC} + 0.5$	V
$I_{IK}$	Input clamp current	$V_I < 0$		-50 mA
$I_{OK}$	Output clamp current	$V_O < 0$		-50 mA
$I_O$	Continuous output current			$\pm 20$ mA
	Continuous current through $V_{CC}$ or GND			$\pm 50$ mA
$\theta_{JA}$	Package thermal impedance <sup>(3)</sup>	DCT package		220
		DCU package		227
		YZP package		102
$T_{stg}$	Storage temperature range	-65	150	$^{\circ}\text{C}$

- (1) Stresses beyond those listed under "absolute maximum ratings" may cause permanent damage to the device. These are stress ratings only, and functional operation of the device at these or any other conditions beyond those indicated under "recommended operating conditions" is not implied. Exposure to absolute-maximum-rated conditions for extended periods may affect device reliability.
- (2) The input negative-voltage and output voltage ratings may be exceeded if the input and output current ratings are observed.
- (3) The package thermal impedance is calculated in accordance with JESD 51-7.

# SN74AUP1G99

## LOW-POWER ULTRA-CONFIGURABLE MULTIPLE-FUNCTION GATE WITH 3-STATE OUTPUTS

SCES594C–JULY 2004–REVISED DECEMBER 2007

### Recommended Operating Conditions<sup>(1)</sup>

		MIN	MAX	UNIT	
$V_{CC}$	Supply voltage	0.8	3.6	V	
$V_I$	Input voltage	0	3.6	V	
$V_O$	Output voltage	Active state	0	$V_{CC}$	
		3-state	0	3.6	
$I_{OH}$	High-level output current	$V_{CC} = 0.8\text{ V}$	-20	$\mu\text{A}$	
		$V_{CC} = 1.1\text{ V}$	-1.1	mA	
		$V_{CC} = 1.4\text{ V}$	-1.7		
		$V_{CC} = 1.65\text{ V}$	-1.9		
		$V_{CC} = 2.3\text{ V}$	-3.1		
		$V_{CC} = 3\text{ V}$	-4		
$I_{OL}$	Low-level output current	$V_{CC} = 0.8\text{ V}$	20	$\mu\text{A}$	
		$V_{CC} = 1.1\text{ V}$	1.1	mA	
		$V_{CC} = 1.4\text{ V}$	1.7		
		$V_{CC} = 1.65\text{ V}$	1.9		
		$V_{CC} = 2.3\text{ V}$	3.1		
		$V_{CC} = 3\text{ V}$	4		
$\Delta t/\Delta v$	Input transition rise or fall rate	$V_{CC} = 0.8\text{ V to }3.6\text{ V}$		200	ns/V
$T_A$	Operating free-air temperature	-40	85	$^{\circ}\text{C}$	

(1) All unused inputs of the device must be held at  $V_{CC}$  or GND to ensure proper device operation. Refer to the TI application report, *Implications of Slow or Floating CMOS Inputs*, literature number SCBA004.

**Electrical Characteristics**

over recommended operating free-air temperature range (unless otherwise noted)

PARAMETER	TEST CONDITIONS	V <sub>CC</sub>	T <sub>A</sub> = 25°C			T <sub>A</sub> = –40°C to 85°C		UNIT
			MIN	TYP	MAX	MIN	MAX	
V <sub>T+</sub> Positive-going input threshold voltage		0.8 V	0.3		0.6	0.3	0.6	V
		1.1 V	0.53		0.9	0.53	0.9	
		1.4 V	0.74		1.11	0.74	1.11	
		1.65 V	0.91		1.29	0.91	1.29	
		2.3 V	1.37		1.77	1.37	1.77	
		3 V	1.88		2.29	1.88	2.29	
V <sub>T–</sub> Negative-going input threshold voltage		0.8 V	0.1		0.6	0.1	0.6	V
		1.1 V	0.26		0.65	0.26	0.65	
		1.4 V	0.39		0.75	0.39	0.75	
		1.65 V	0.47		0.84	0.47	0.84	
		2.3 V	0.69		1.04	0.69	1.04	
		3 V	0.88		1.24	0.88	1.24	
ΔV <sub>T</sub> Hysteresis (V <sub>T+</sub> – V <sub>T–</sub> )		0.8 V	0.07		0.5	0.07	0.5	V
		1.1 V	0.08		0.46	0.08	0.46	
		1.4 V	0.18		0.56	0.18	0.56	
		1.65 V	0.27		0.66	0.27	0.66	
		2.3 V	0.53		0.92	0.53	0.92	
		3 V	0.79		1.31	0.79	1.31	
V <sub>OH</sub>	I <sub>OH</sub> = –20 μA I <sub>OH</sub> = –1.1 mA I <sub>OH</sub> = –1.7 mA I <sub>OH</sub> = –1.9 mA I <sub>OH</sub> = –2.3 mA I <sub>OH</sub> = –3.1 mA I <sub>OH</sub> = –2.7 mA I <sub>OH</sub> = –4 mA	0.8 V to 3.6 V	V <sub>CC</sub> – 0.1		V <sub>CC</sub> – 0.1		V	
		1.1 V	0.75 × V <sub>CC</sub>		0.7 × V <sub>CC</sub>			
		1.4 V	1.11		1.03			
		1.65 V	1.32		1.3			
		2.3 V	2.05		1.97			
			1.9		1.85			
		3 V	2.72		2.67			
			2.6		2.55			
V <sub>OL</sub>	I <sub>OL</sub> = 20 μA I <sub>OL</sub> = 1.1 mA I <sub>OL</sub> = 1.7 mA I <sub>OL</sub> = 1.9 mA I <sub>OL</sub> = 2.3 mA I <sub>OL</sub> = 3.1 mA I <sub>OL</sub> = 2.7 mA I <sub>OL</sub> = 4 mA	0.8 V to 3.6 V	0.1		0.1		V	
		1.1 V	0.3 × V <sub>CC</sub>		0.3 × V <sub>CC</sub>			
		1.4 V	0.31		0.37			
		1.65 V	0.31		0.35			
		2.3 V	0.31		0.33			
			0.44		0.45			
		3 V	0.31		0.33			
			0.44		0.45			
I <sub>i</sub>	All inputs V <sub>i</sub> = GND to 3.6 V	0 V to 3.6 V		0.1		0.5	μA	
I <sub>off</sub>	V <sub>i</sub> or V <sub>O</sub> = 0 V to 3.6 V	0 V		0.2		0.6	μA	
ΔI <sub>off</sub>	V <sub>i</sub> or V <sub>O</sub> = 0 V to 3.6 V	0 V to 0.2 V		0.2		0.6	μA	
I <sub>OZ</sub>	V <sub>O</sub> = V <sub>CC</sub> or GND	3.6 V		0.1		0.5	μA	
I <sub>CC</sub>	V <sub>i</sub> = GND or (V <sub>CC</sub> to 3.6 V), OE = GND, I <sub>O</sub> = 0	0.8 V to 3.6 V		0.5		0.9	μA	

# SN74AUP1G99

## LOW-POWER ULTRA-CONFIGURABLE MULTIPLE-FUNCTION GATE WITH 3-STATE OUTPUTS

SCES594C–JULY 2004–REVISED DECEMBER 2007

### Electrical Characteristics (continued)

over recommended operating free-air temperature range (unless otherwise noted)

PARAMETER		TEST CONDITIONS	V <sub>CC</sub>	T <sub>A</sub> = 25°C			T <sub>A</sub> = –40°C to 85°C		UNIT
				MIN	TYP	MAX	MIN	MAX	
ΔI <sub>CC</sub>	Data inputs	V <sub>I</sub> = V <sub>CC</sub> – 0.6 V, <sup>(1)</sup> I <sub>O</sub> = 0	3.3 V	40			50		μA
	$\overline{OE}$			110			120		
	All inputs	V <sub>I</sub> = GND to 3.6 V, $\overline{OE}$ = V <sub>CC</sub> <sup>(2)</sup>	0.8 V to 3.6 V	0					nA
C <sub>I</sub>		V <sub>I</sub> = V <sub>CC</sub> or GND	0 V	1.5					pF
			3.6 V	1.5					
C <sub>O</sub>		V <sub>O</sub> = V <sub>CC</sub> or GND	3.6 V	3					pF

(1) One input at V<sub>CC</sub> – 0.6 V, other input at V<sub>CC</sub> or GND

(2) To show I<sub>CC</sub> is very low when the input-disable feature is enabled.

### Switching Characteristics

over recommended operating free-air temperature range, C<sub>L</sub> = 5 pF (unless otherwise noted) (see [Figure 3](#) and [Figure 4](#))

PARAMETER	FROM (INPUT)	TO (OUTPUT)	V <sub>CC</sub>	T <sub>A</sub> = 25°C			T <sub>A</sub> = –40°C to 85°C		UNIT
				MIN	TYP	MAX	MIN	MAX	
t <sub>pd</sub>	A, B, C, or D	Y	0.8 V	32					ns
			1.2 V ± 0.1 V	0.5	9.9	20.1	0.5	26.6	
			1.5 V ± 0.1 V	1.4	6.6	11.9	0.5	16.8	
			1.8 V ± 0.15 V	1.8	5.3	8.9	1	13	
			2.5 V ± 0.2 V	2.1	3.9	5.8	1.3	8.9	
			3.3 V ± 0.3 V	1.9	3.3	4.8	1.2	7.4	
t <sub>en</sub>	$\overline{OE}$	Y	0.8 V	35					ns
			1.2 V ± 0.1 V	0.6	11.1	21.7	0.5	25.2	
			1.5 V ± 0.1 V	2.3	7.4	12.6	1.4	16.4	
			1.8 V ± 0.15 V	2	5.7	9.4	1.1	12.8	
			2.5 V ± 0.2 V	2.1	4.1	6.2	1.2	8.5	
			3.3 V ± 0.3 V	1.9	3.4	5	1.1	6.7	
t <sub>dis</sub>	$\overline{OE}$	Y	0.8 V	9.8					ns
			1.2 V ± 0.1 V	1.4	4.5	7.7	1.5	8.2	
			1.5 V ± 0.1 V	1.7	3.2	4.8	1.7	6	
			1.8 V ± 0.15 V	1.5	3	4.7	1.3	6.1	
			2.5 V ± 0.2 V	0.9	1.9	3	0.7	4.2	
			3.3 V ± 0.3 V	0.8	2.5	4.4	0.7	4.5	

**Switching Characteristics**

 over recommended operating free-air temperature range,  $C_L = 10$  pF (unless otherwise noted) (see [Figure 3](#) and [Figure 4](#))

PARAMETER	FROM (INPUT)	TO (OUTPUT)	$V_{CC}$	$T_A = 25^\circ\text{C}$			$T_A = -40^\circ\text{C}$ to $85^\circ\text{C}$		UNIT
				MIN	TYP	MAX	MIN	MAX	
$t_{pd}$	A, B, C, or D	Y	0.8 V	36					ns
			$1.2\text{ V} \pm 0.1\text{ V}$	0.4	10.7	21.1	0.7	29.8	
			$1.5\text{ V} \pm 0.1\text{ V}$	2	7.2	12.6	1.1	18.5	
			$1.8\text{ V} \pm 0.15\text{ V}$	2.3	5.8	9.5	1.5	14.5	
			$2.5\text{ V} \pm 0.2\text{ V}$	2.5	4.4	6.3	1.7	10.5	
		Y	0.8 V	0					ns
			$1.2\text{ V} \pm 0.1\text{ V}$	1.4	12.1	22.8	0.8	29.3	
			$1.5\text{ V} \pm 0.1\text{ V}$	2.8	8	13.3	2	18.7	
			$1.8\text{ V} \pm 0.15\text{ V}$	2.5	6.2	10	1.6	14.8	
			$2.5\text{ V} \pm 0.2\text{ V}$	2.5	4.5	6.7	1.6	9.9	
		Y	0.8 V	0					ns
			$1.2\text{ V} \pm 0.1\text{ V}$	2	5.6	9.3	2	10	
			$1.5\text{ V} \pm 0.1\text{ V}$	2.5	4.1	5.8	2.4	7.6	
			$1.8\text{ V} \pm 0.15\text{ V}$	2.9	4.2	5.7	2.7	7.9	
			$2.5\text{ V} \pm 0.2\text{ V}$	1.1	2.7	4.4	1.1	5.5	
		Y	$3.3\text{ V} \pm 0.3\text{ V}$	1.9	3.5	5.2	1.9	5.8	

# SN74AUP1G99

## LOW-POWER ULTRA-CONFIGURABLE MULTIPLE-FUNCTION GATE WITH 3-STATE OUTPUTS

SCES594C—JULY 2004—REVISED DECEMBER 2007

### Switching Characteristics

over recommended operating free-air temperature range,  $C_L = 15 \text{ pF}$  (unless otherwise noted) (see [Figure 3](#) and [Figure 4](#))

PARAMETER	FROM (INPUT)	TO (OUTPUT)	$V_{CC}$	$T_A = 25^\circ\text{C}$			$T_A = -40^\circ\text{C}$ to $85^\circ\text{C}$		UNIT
				MIN	TYP	MAX	MIN	MAX	
$t_{pd}$	A, B, C, or D	Y	0.8 V	38					ns
			$1.2 \text{ V} \pm 0.1 \text{ V}$	0.9	11.4	22	0.5	30.8	
			$1.5 \text{ V} \pm 0.1 \text{ V}$	2.5	7.8	13.2	1.6	19.2	
			$1.8 \text{ V} \pm 0.15 \text{ V}$	2.7	6.3	10	1.9	15.1	
			$2.5 \text{ V} \pm 0.2 \text{ V}$	2.8	4.7	6.6	2	10.8	
$t_{en}$	$\overline{OE}$	Y	0.8 V	44					ns
			$1.2 \text{ V} \pm 0.1 \text{ V}$	1.8	13	24.2	1.3	30.6	
			$1.5 \text{ V} \pm 0.1 \text{ V}$	3.2	8.6	14.1	2.4	19.5	
			$1.8 \text{ V} \pm 0.15 \text{ V}$	2.9	6.7	10.6	2	15.4	
			$2.5 \text{ V} \pm 0.2 \text{ V}$	2.8	4.9	7	1.9	10.3	
$t_{dis}$	$\overline{OE}$	Y	0.8 V	13					ns
			$1.2 \text{ V} \pm 0.1 \text{ V}$	2.7	6.3	9.9	2.8	10.7	
			$1.5 \pm 0.1 \text{ V}$	3.2	4.6	6.1	3.1	8	
			$1.8 \text{ V} \pm 0.15 \text{ V}$	3.2	4.8	6.6	3	8.8	
			$2.5 \text{ V} \pm 0.2 \text{ V}$	2.2	3.4	4.7	2	6	
			$3.3 \text{ V} \pm 0.3 \text{ V}$	2.4	4.4	6.5	2.3	7.2	

## Switching Characteristics

over recommended operating free-air temperature range,  $C_L = 30$  pF (unless otherwise noted) (see Figure 3 and Figure 4)

PARAMETER	FROM (INPUT)	TO (OUTPUT)	$V_{CC}$	$T_A = 25^\circ\text{C}$			$T_A = -40^\circ\text{C}$ to $85^\circ\text{C}$		UNIT
				MIN	TYP	MAX	MIN	MAX	
$t_{pd}$	A, B, C, or D	Y	0.8 V	48					ns
			$1.2\text{ V} \pm 0.1\text{ V}$	3.1	14	24.9	2.6	36.1	
			$1.5\text{ V} \pm 0.1\text{ V}$	4.2	9.6	15.1	3.3	23.1	
			$1.8\text{ V} \pm 0.15\text{ V}$	4.1	7.9	11.7	3.3	18	
			$2.5\text{ V} \pm 0.2\text{ V}$	4.1	5.9	7.9	3.1	12.7	
$t_{en}$	$\overline{OE}$	Y	0.8 V	50					ns
			$1.2\text{ V} \pm 0.1\text{ V}$	4.4	16	27.6	3.9	36.8	
			$1.5\text{ V} \pm 0.1\text{ V}$	5.3	10.7	16.2	4.3	23.6	
			$1.8\text{ V} \pm 0.15\text{ V}$	4.6	8.5	12.4	3.6	18.6	
			$2.5\text{ V} \pm 0.2\text{ V}$	4.2	6.3	8.5	3.2	12.6	
$t_{dis}$	$\overline{OE}$	Y	0.8 V	19					ns
			$1.2\text{ V} \pm 0.1\text{ V}$	6	10.1	14.2	6	14.6	
			$1.5\text{ V} \pm 0.1\text{ V}$	5.1	7.4	10.6	5	10.1	
			$1.8\text{ V} \pm 0.15\text{ V}$	5.5	8.6	11.6	5.5	12.1	
			$2.5\text{ V} \pm 0.2\text{ V}$	3.3	5.9	8.3	3.3	8.9	
			$3.3\text{ V} \pm 0.3\text{ V}$	6	8.7	10.9	5.9	11.8	

## Operating Characteristics

$T_A = 25^\circ\text{C}$

PARAMETER		TEST CONDITIONS	$V_{CC}$	TYP	UNIT
$C_{pd}$	Power dissipation capacitance	Outputs enabled	0.8 V	4	pF
			$1.2 \pm 0.1\text{ V}$	4	
			$1.5 \pm 0.1\text{ V}$	4	
			$1.8\text{ V} \pm 0.15\text{ V}$	4	
			$2.5\text{ V} \pm 0.2\text{ V}$	5	
			$3.3\text{ V} \pm 0.3\text{ V}$	5	
	Outputs disabled	0.8 V	0		
		$1.2 \pm 0.1\text{ V}$	0		
		$1.5 \pm 0.1\text{ V}$	0		
		$1.8\text{ V} \pm 0.15\text{ V}$	0		
		$2.5\text{ V} \pm 0.2\text{ V}$	0		
		$3.3\text{ V} \pm 0.3\text{ V}$	0		

**PARAMETER MEASUREMENT INFORMATION**  
**(Propagation Delays, Setup and Hold Times, and Pulse Width)**

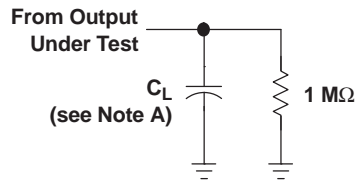

LOAD CIRCUIT

	$V_{CC} = 0.8\text{ V}$	$V_{CC} = 1.2\text{ V}$ $\pm 0.1\text{ V}$	$V_{CC} = 1.5\text{ V}$ $\pm 0.1\text{ V}$	$V_{CC} = 1.8\text{ V}$ $\pm 0.15\text{ V}$	$V_{CC} = 2.5\text{ V}$ $\pm 0.2\text{ V}$	$V_{CC} = 3.3\text{ V}$ $\pm 0.3\text{ V}$
$C_L$	5, 10, 15, 30 pF	5, 10, 15, 30 pF	5, 10, 15, 30 pF	5, 10, 15, 30 pF	5, 10, 15, 30 pF	5, 10, 15, 30 pF
$V_M$	$V_{CC}/2$	$V_{CC}/2$	$V_{CC}/2$	$V_{CC}/2$	$V_{CC}/2$	$V_{CC}/2$
$V_I$	$V_{CC}$	$V_{CC}$	$V_{CC}$	$V_{CC}$	$V_{CC}$	$V_{CC}$

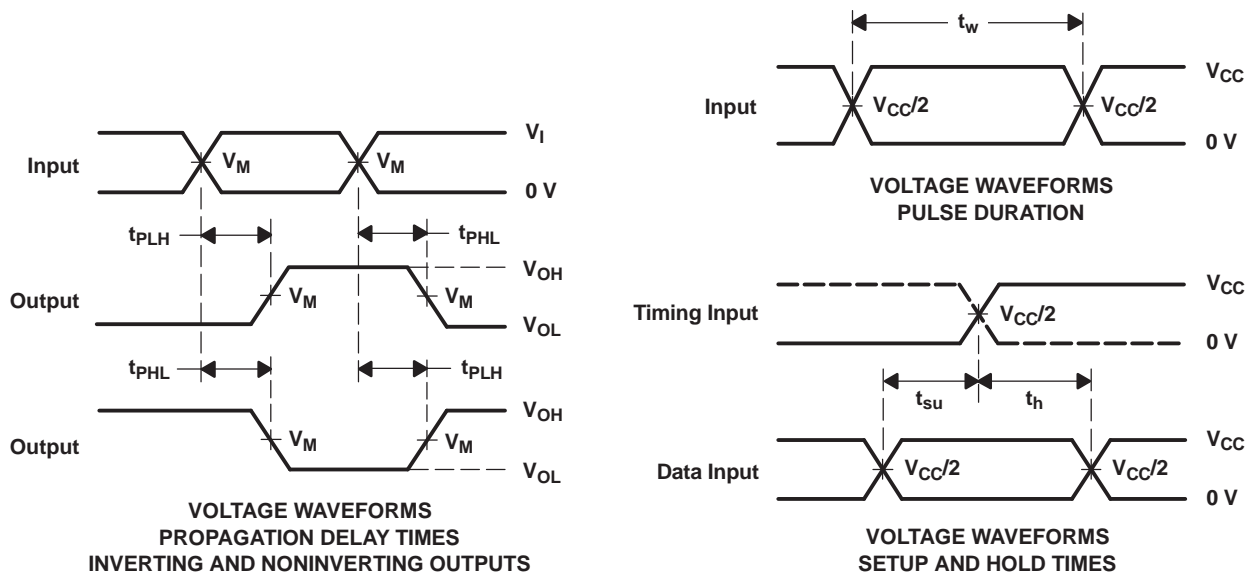

- NOTES: A.  $C_L$  includes probe and jig capacitance.  
B. All input pulses are supplied by generators having the following characteristics: PRR  $\leq 10$  MHz,  $Z_O = 50\ \Omega$ , for propagation delays  $t_r/t_f = 3$  ns, for setup and hold times and pulse width  $t_r/t_f = 1.2$  ns.  
C. The outputs are measured one at a time, with one transition per measurement.  
D.  $t_{PLH}$  and  $t_{PHL}$  are the same as  $t_{pd}$ .  
E. All parameters and waveforms are not applicable to all devices.

**Figure 3. Load Circuit and Voltage Waveforms**

PARAMETER MEASUREMENT INFORMATION  
(Enable and Disable Times)

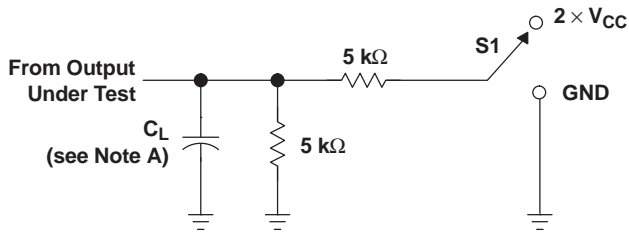

TEST	S1
$t_{PLZ}/t_{PZL}$	$2 \times V_{CC}$
$t_{PHZ}/t_{PZH}$	GND

LOAD CIRCUIT

	$V_{CC} = 0.8 \text{ V}$	$V_{CC} = 1.2 \text{ V}$ $\pm 0.1 \text{ V}$	$V_{CC} = 1.5 \text{ V}$ $\pm 0.1 \text{ V}$	$V_{CC} = 1.8 \text{ V}$ $\pm 0.15 \text{ V}$	$V_{CC} = 2.5 \text{ V}$ $\pm 0.2 \text{ V}$	$V_{CC} = 3.3 \text{ V}$ $\pm 0.3 \text{ V}$
$C_L$	5, 10, 15, 30 pF	5, 10, 15, 30 pF	5, 10, 15, 30 pF	5, 10, 15, 30 pF	5, 10, 15, 30 pF	5, 10, 15, 30 pF
$V_M$	$V_{CC}/2$	$V_{CC}/2$	$V_{CC}/2$	$V_{CC}/2$	$V_{CC}/2$	$V_{CC}/2$
$V_I$	$V_{CC}$	$V_{CC}$	$V_{CC}$	$V_{CC}$	$V_{CC}$	$V_{CC}$
$V_{\Delta}$	0.1 V	0.1 V	0.1 V	0.15 V	0.15 V	0.3 V

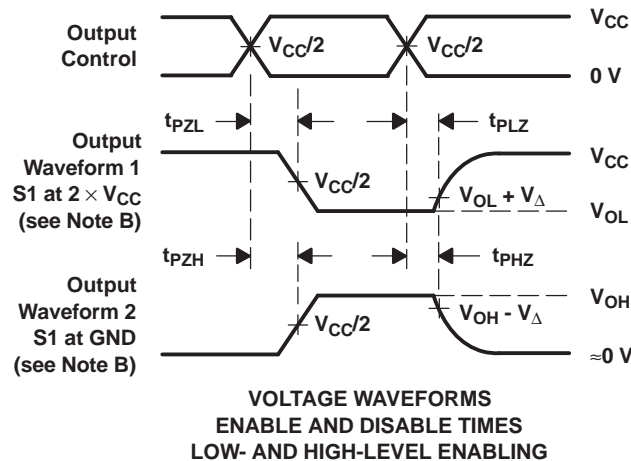

VOLTAGE WAVEFORMS  
ENABLE AND DISABLE TIMES  
LOW- AND HIGH-LEVEL ENABLING

- NOTES:
- A.  $C_L$  includes probe and jig capacitance.
  - B. Waveform 1 is for an output with internal conditions such that the output is low, except when disabled by the output control. Waveform 2 is for an output with internal conditions such that the output is high, except when disabled by the output control.
  - C. All input pulses are supplied by generators having the following characteristics:  $PRR \leq 10 \text{ MHz}$ ,  $Z_O = 50 \Omega$ ,  $t_r/t_f = 3 \text{ ns}$ .
  - D. The outputs are measured one at a time, with one transition per measurement.
  - E.  $t_{PLZ}$  and  $t_{PHZ}$  are the same as  $t_{dis}$ .
  - F.  $t_{PZL}$  and  $t_{PZH}$  are the same as  $t_{en}$ .
  - G. All parameters and waveforms are not applicable to all devices.

Figure 4. Load Circuit and Voltage Waveforms

**PACKAGING INFORMATION**

Orderable part number	Status (1)	Material type (2)	Package   Pins	Package qty   Carrier	RoHS (3)	Lead finish/ Ball material (4)	MSL rating/ Peak reflow (5)	Op temp (°C)	Part marking (6)
<a href="#">SN74AUP1G99DCTR</a>	Active	Production	SSOP (DCT)   8	3000   LARGE T&R	Yes	NIPDAU   SN	Level-1-260C-UNLIM	-40 to 85	(2XG5, H99) (R, Z)
SN74AUP1G99DCTR.B	Active	Production	SSOP (DCT)   8	3000   LARGE T&R	Yes	NIPDAU	Level-1-260C-UNLIM	-40 to 85	(2XG5, H99) (R, Z)
<a href="#">SN74AUP1G99DCTT</a>	Active	Production	SSOP (DCT)   8	250   SMALL T&R	Yes	NIPDAU   SN	Level-1-260C-UNLIM	-40 to 85	(2XG5, H99) (R, Z)
SN74AUP1G99DCTT.B	Active	Production	SSOP (DCT)   8	250   SMALL T&R	Yes	NIPDAU	Level-1-260C-UNLIM	-40 to 85	(2XG5, H99) (R, Z)
<a href="#">SN74AUP1G99DCUR</a>	Active	Production	VSSOP (DCU)   8	3000   LARGE T&R	Yes	NIPDAU   SN	Level-1-260C-UNLIM	-40 to 85	(H99Q, H99R)
SN74AUP1G99DCUR.B	Active	Production	VSSOP (DCU)   8	3000   LARGE T&R	Yes	NIPDAU	Level-1-260C-UNLIM	-40 to 85	(H99Q, H99R)
SN74AUP1G99DCUR1G4.B	Active	Production	VSSOP (DCU)   8	3000   LARGE T&R	-	Call TI	Call TI	-40 to 85	
<a href="#">SN74AUP1G99DCUT</a>	Active	Production	VSSOP (DCU)   8	250   SMALL T&R	Yes	NIPDAU   SN	Level-1-260C-UNLIM	-40 to 85	(H99Q, H99R)
SN74AUP1G99DCUT.B	Active	Production	VSSOP (DCU)   8	250   SMALL T&R	Yes	NIPDAU	Level-1-260C-UNLIM	-40 to 85	(H99Q, H99R)
<a href="#">SN74AUP1G99YZPR</a>	Active	Production	DSBGA (YZP)   8	3000   LARGE T&R	Yes	SNAGCU	Level-1-260C-UNLIM	-40 to 85	HYN
SN74AUP1G99YZPR.B	Active	Production	DSBGA (YZP)   8	3000   LARGE T&R	Yes	SNAGCU	Level-1-260C-UNLIM	-40 to 85	HYN

(1) **Status:** For more details on status, see our [product life cycle](#).

(2) **Material type:** When designated, preproduction parts are prototypes/experimental devices, and are not yet approved or released for full production. Testing and final process, including without limitation quality assurance, reliability performance testing, and/or process qualification, may not yet be complete, and this item is subject to further changes or possible discontinuation. If available for ordering, purchases will be subject to an additional waiver at checkout, and are intended for early internal evaluation purposes only. These items are sold without warranties of any kind.

(3) **RoHS values:** Yes, No, RoHS Exempt. See the [TI RoHS Statement](#) for additional information and value definition.

(4) **Lead finish/Ball material:** Parts may have multiple material finish options. Finish options are separated by a vertical ruled line. Lead finish/Ball material values may wrap to two lines if the finish value exceeds the maximum column width.

(5) **MSL rating/Peak reflow:** The moisture sensitivity level ratings and peak solder (reflow) temperatures. In the event that a part has multiple moisture sensitivity ratings, only the lowest level per JEDEC standards is shown. Refer to the shipping label for the actual reflow temperature that will be used to mount the part to the printed circuit board.

(6) **Part marking:** There may be an additional marking, which relates to the logo, the lot trace code information, or the environmental category of the part.

Multiple part markings will be inside parentheses. Only one part marking contained in parentheses and separated by a "~" will appear on a part. If a line is indented then it is a continuation of the previous line and the two combined represent the entire part marking for that device.

**Important Information and Disclaimer:** The information provided on this page represents TI's knowledge and belief as of the date that it is provided. TI bases its knowledge and belief on information provided by third parties, and makes no representation or warranty as to the accuracy of such information. Efforts are underway to better integrate information from third parties. TI has taken and continues to take reasonable steps to provide representative and accurate information but may not have conducted destructive testing or chemical analysis on incoming materials and chemicals. TI and TI suppliers consider certain information to be proprietary, and thus CAS numbers and other limited information may not be available for release.

In no event shall TI's liability arising out of such information exceed the total purchase price of the TI part(s) at issue in this document sold by TI to Customer on an annual basis.

**TAPE AND REEL INFORMATION**

**QUADRANT ASSIGNMENTS FOR PIN 1 ORIENTATION IN TAPE**

\*All dimensions are nominal

Device	Package Type	Package Drawing	Pins	SPQ	Reel Diameter (mm)	Reel Width W1 (mm)	A0 (mm)	B0 (mm)	K0 (mm)	P1 (mm)	W (mm)	Pin1 Quadrant
SN74AUP1G99DCTR	SSOP	DCT	8	3000	180.0	13.0	3.35	4.5	1.55	4.0	12.0	Q3
SN74AUP1G99DCTR	SSOP	DCT	8	3000	180.0	12.4	3.15	4.35	1.55	4.0	12.0	Q3
SN74AUP1G99DCTT	SSOP	DCT	8	250	180.0	12.4	3.15	4.35	1.55	4.0	12.0	Q3
SN74AUP1G99DCTT	SSOP	DCT	8	250	177.8	12.4	3.45	4.4	1.45	4.0	12.0	Q3
SN74AUP1G99DCTT	SSOP	DCT	8	250	180.0	13.0	3.35	4.5	1.55	4.0	12.0	Q3
SN74AUP1G99DCUR	VSSOP	DCU	8	3000	178.0	9.5	2.25	3.35	1.05	4.0	8.0	Q3
SN74AUP1G99DCUT	VSSOP	DCU	8	250	178.0	9.5	2.25	3.35	1.05	4.0	8.0	Q3
SN74AUP1G99YZPR	DSBGA	YZP	8	3000	178.0	9.2	1.02	2.02	0.63	4.0	8.0	Q1

**TAPE AND REEL BOX DIMENSIONS**

\*All dimensions are nominal

Device	Package Type	Package Drawing	Pins	SPQ	Length (mm)	Width (mm)	Height (mm)
SN74AUP1G99DCTR	SSOP	DCT	8	3000	182.0	182.0	20.0
SN74AUP1G99DCTR	SSOP	DCT	8	3000	190.0	190.0	30.0
SN74AUP1G99DCTT	SSOP	DCT	8	250	190.0	190.0	30.0
SN74AUP1G99DCTT	SSOP	DCT	8	250	183.0	183.0	20.0
SN74AUP1G99DCTT	SSOP	DCT	8	250	182.0	182.0	20.0
SN74AUP1G99DCUR	VSSOP	DCU	8	3000	202.0	201.0	28.0
SN74AUP1G99DCUT	VSSOP	DCU	8	250	202.0	201.0	28.0
SN74AUP1G99YZPR	DSBGA	YZP	8	3000	220.0	220.0	35.0

YZP0008

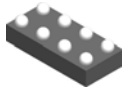

# PACKAGE OUTLINE

DSBGA - 0.5 mm max height

DIE SIZE BALL GRID ARRAY

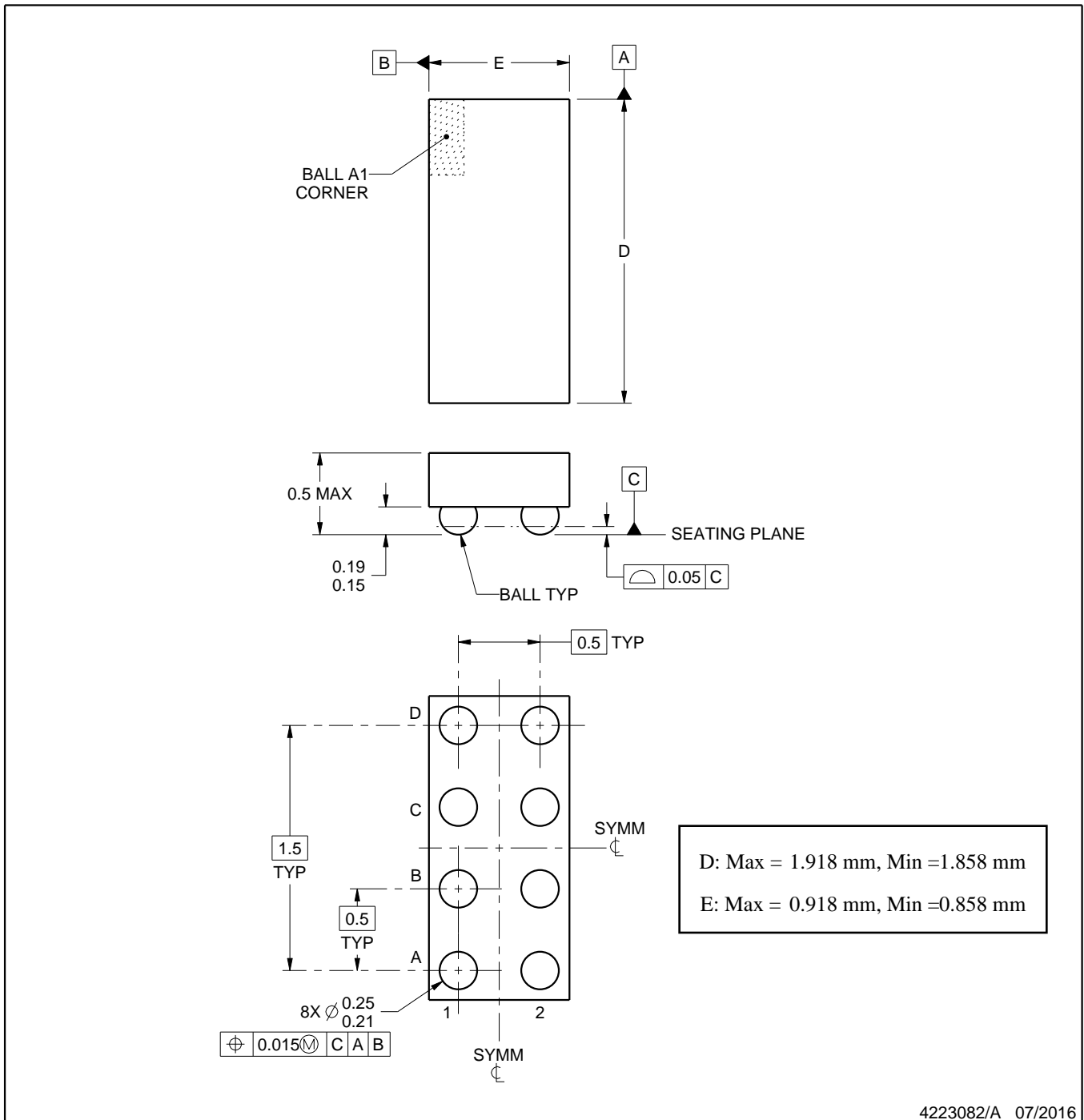

NOTES:

1. All linear dimensions are in millimeters. Any dimensions in parenthesis are for reference only. Dimensioning and tolerancing per ASME Y14.5M.
2. This drawing is subject to change without notice.

# EXAMPLE BOARD LAYOUT

YZP0008

DSBGA - 0.5 mm max height

DIE SIZE BALL GRID ARRAY



LAND PATTERN EXAMPLE  
SCALE:40X



SOLDER MASK DETAILS  
NOT TO SCALE

4223082/A 07/2016

NOTES: (continued)

- Final dimensions may vary due to manufacturing tolerance considerations and also routing constraints. For more information, see Texas Instruments literature number SNVA009 ([www.ti.com/lit/snva009](http://www.ti.com/lit/snva009)).

# EXAMPLE STENCIL DESIGN

YZP0008

DSBGA - 0.5 mm max height

DIE SIZE BALL GRID ARRAY

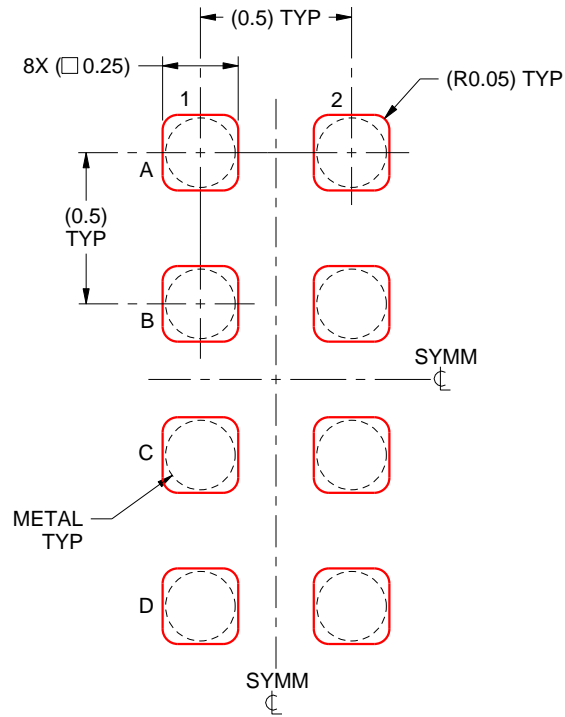

SOLDER PASTE EXAMPLE  
BASED ON 0.1 mm THICK STENCIL  
SCALE:40X

4223082/A 07/2016

NOTES: (continued)

4. Laser cutting apertures with trapezoidal walls and rounded corners may offer better paste release.

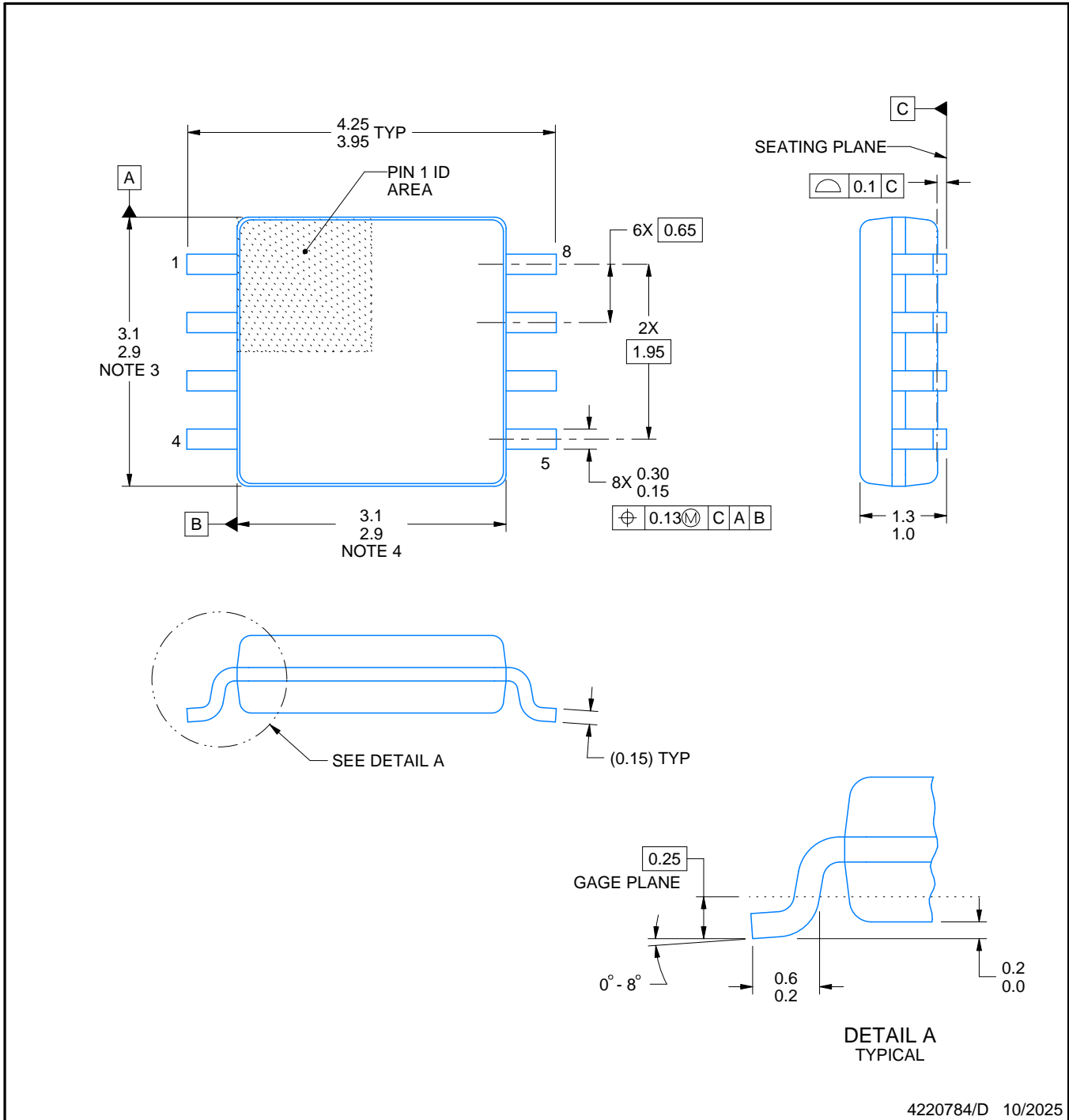
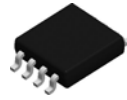

4220784/D 10/2025

NOTES:

1. All linear dimensions are in millimeters. Dimensions in parenthesis are for reference only. Dimensioning and tolerancing per ASME Y14.5M.
2. This drawing is subject to change without notice.
3. This dimension does not include mold flash, protrusions, or gate burrs. Mold flash, protrusions, or gate burrs shall not exceed 0.15 mm per side.
4. This dimension does not include interlead flash. Interlead flash shall not exceed 0.25 mm per side.

# EXAMPLE BOARD LAYOUT

DCT0008A

SSOP - 1.3 mm max height

SMALL OUTLINE PACKAGE

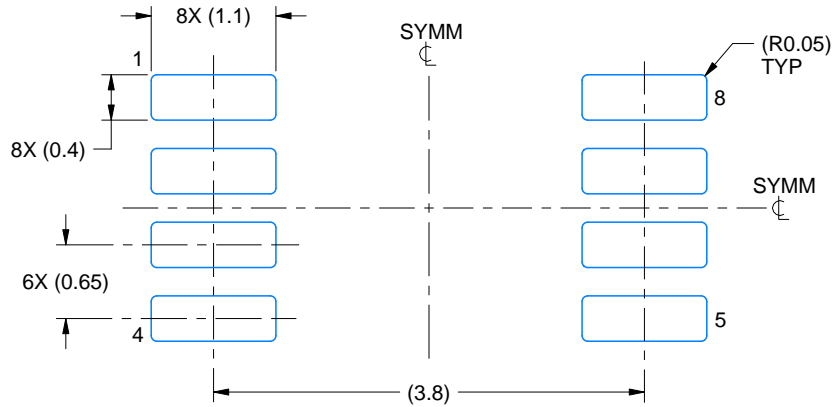

LAND PATTERN EXAMPLE  
EXPOSED METAL SHOWN  
SCALE:15X

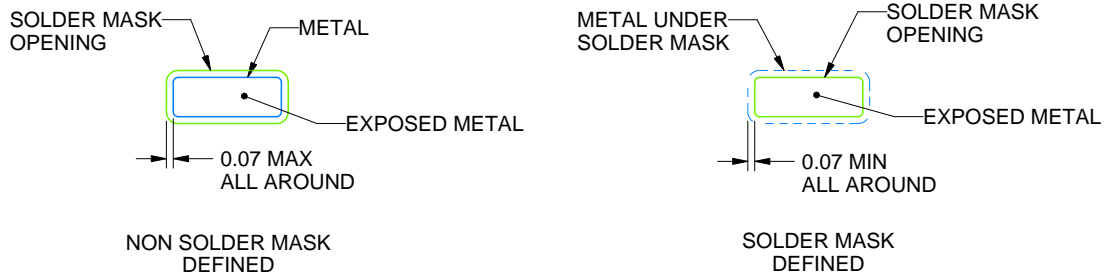

SOLDER MASK DETAILS

4220784/D 10/2025

NOTES: (continued)

- 5. Publication IPC-7351 may have alternate designs.
- 6. Solder mask tolerances between and around signal pads can vary based on board fabrication site.



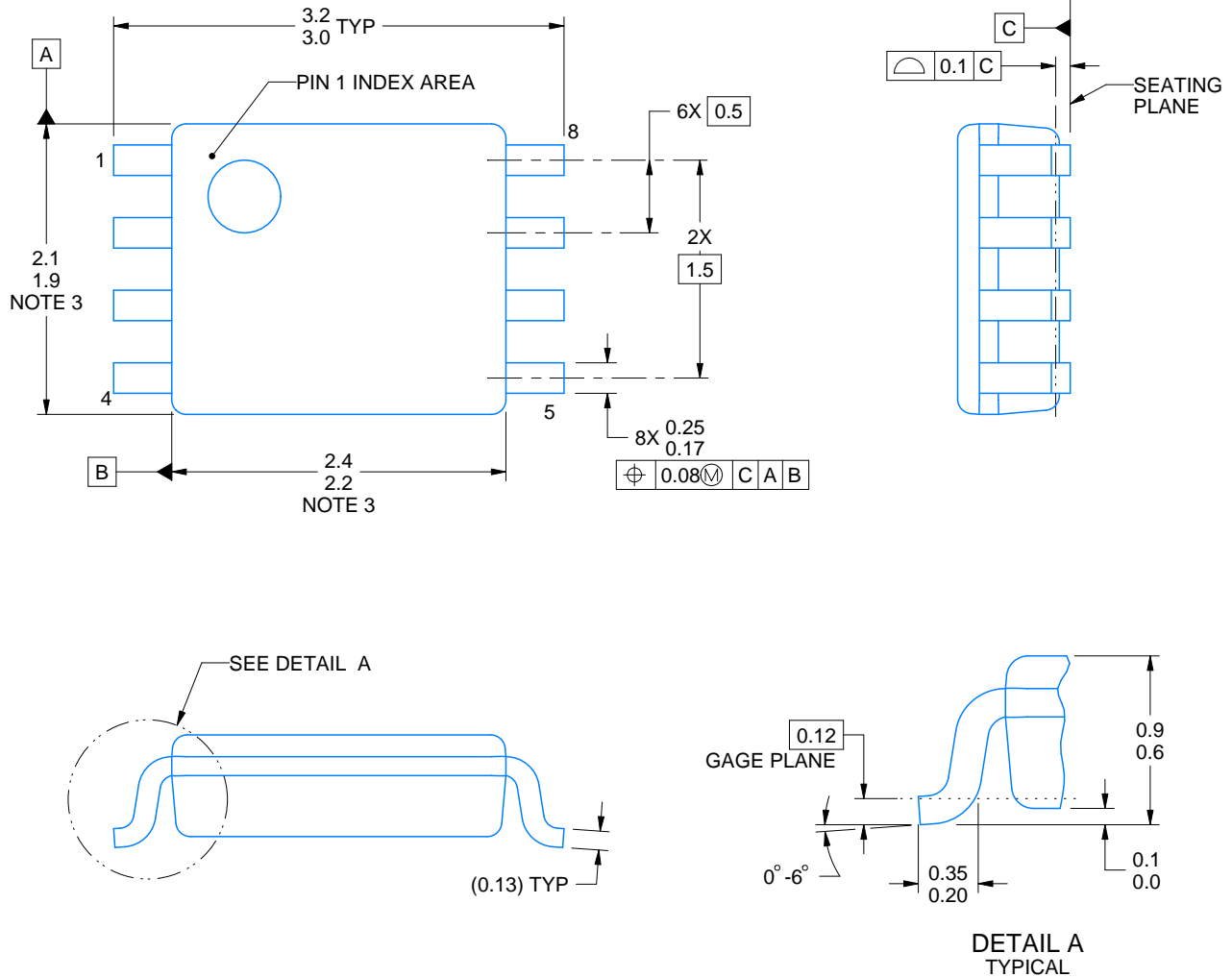

4225266/A 09/2014

NOTES:

1. All linear dimensions are in millimeters. Any dimensions in parenthesis are for reference only. Dimensioning and tolerancing per ASME Y14.5M.
2. This drawing is subject to change without notice.
3. This dimension does not include mold flash, protrusions, or gate burrs. Mold flash, protrusions, or gate burrs shall not exceed 0.15 mm per side.
4. Reference JEDEC registration MO-187 variation CA.

# EXAMPLE BOARD LAYOUT

DCU0008A

VSSOP - 0.9 mm max height

SMALL OUTLINE PACKAGE

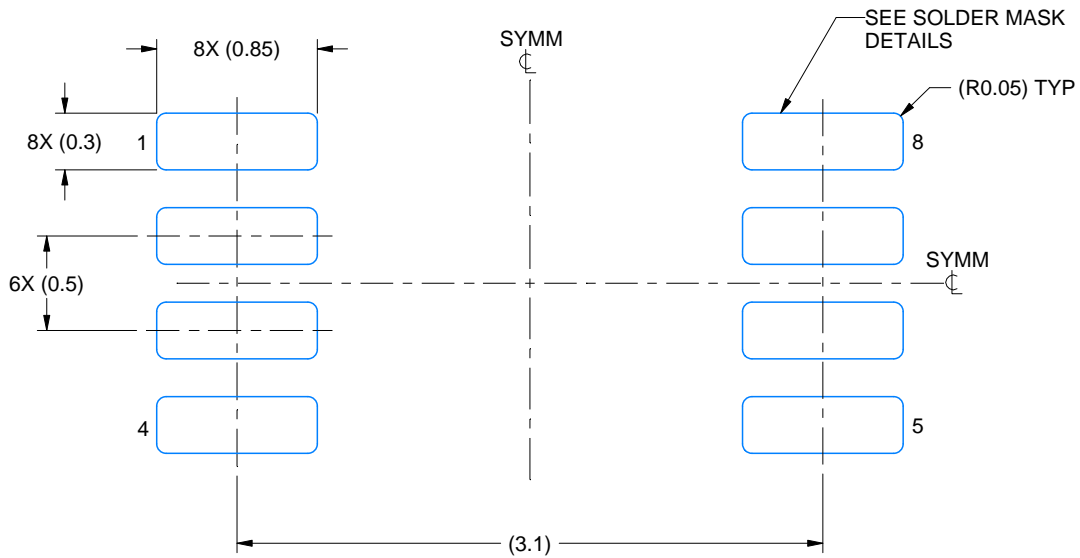

LAND PATTERN EXAMPLE  
EXPOSED METAL SHOWN  
SCALE: 25X

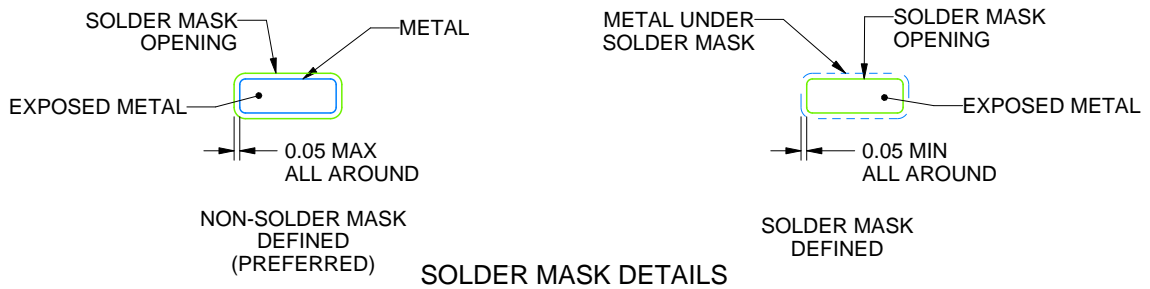

4225266/A 09/2014

NOTES: (continued)

- 5. Publication IPC-7351 may have alternate designs.
- 6. Solder mask tolerances between and around signal pads can vary based on board fabrication site.

# EXAMPLE STENCIL DESIGN

DCU0008A

VSSOP - 0.9 mm max height

SMALL OUTLINE PACKAGE

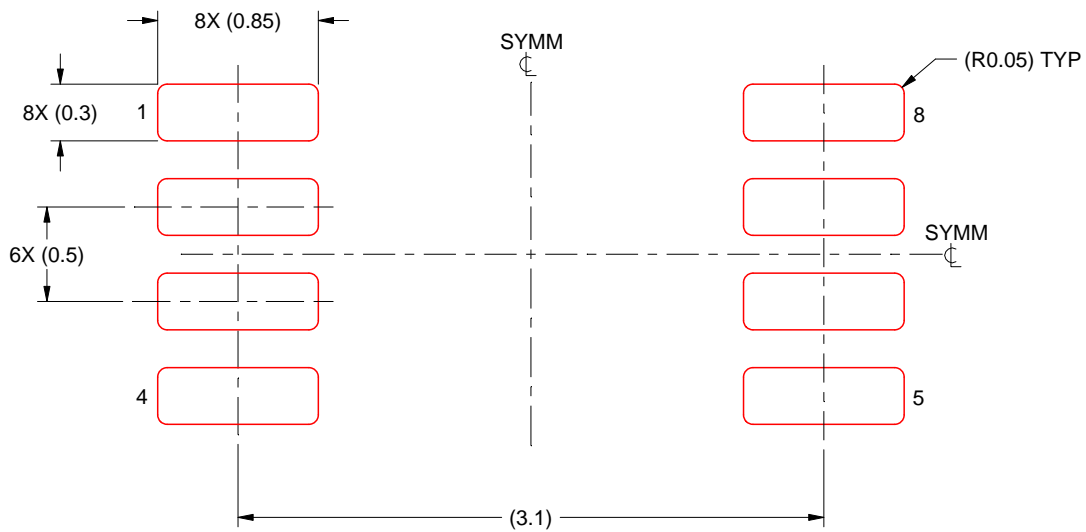

SOLDER PASTE EXAMPLE  
BASED ON 0.125 mm THICK STENCIL  
SCALE: 25X

4225266/A 09/2014

NOTES: (continued)

7. Laser cutting apertures with trapezoidal walls and rounded corners may offer better paste release. IPC-7525 may have alternate design recommendations.
8. Board assembly site may have different recommendations for stencil design.

## IMPORTANT NOTICE AND DISCLAIMER

TI PROVIDES TECHNICAL AND RELIABILITY DATA (INCLUDING DATASHEETS), DESIGN RESOURCES (INCLUDING REFERENCE DESIGNS), APPLICATION OR OTHER DESIGN ADVICE, WEB TOOLS, SAFETY INFORMATION, AND OTHER RESOURCES "AS IS" AND WITH ALL FAULTS, AND DISCLAIMS ALL WARRANTIES, EXPRESS AND IMPLIED, INCLUDING WITHOUT LIMITATION ANY IMPLIED WARRANTIES OF MERCHANTABILITY, FITNESS FOR A PARTICULAR PURPOSE OR NON-INFRINGEMENT OF THIRD PARTY INTELLECTUAL PROPERTY RIGHTS.

These resources are intended for skilled developers designing with TI products. You are solely responsible for (1) selecting the appropriate TI products for your application, (2) designing, validating and testing your application, and (3) ensuring your application meets applicable standards, and any other safety, security, regulatory or other requirements.

These resources are subject to change without notice. TI grants you permission to use these resources only for development of an application that uses the TI products described in the resource. Other reproduction and display of these resources is prohibited. No license is granted to any other TI intellectual property right or to any third party intellectual property right. TI disclaims responsibility for, and you fully indemnify TI and its representatives against any claims, damages, costs, losses, and liabilities arising out of your use of these resources.

TI's products are provided subject to [TI's Terms of Sale](#), [TI's General Quality Guidelines](#), or other applicable terms available either on [ti.com](http://ti.com) or provided in conjunction with such TI products. TI's provision of these resources does not expand or otherwise alter TI's applicable warranties or warranty disclaimers for TI products. Unless TI explicitly designates a product as custom or customer-specified, TI products are standard, catalog, general purpose devices.

TI objects to and rejects any additional or different terms you may propose.

Copyright © 2026, Texas Instruments Incorporated

Last updated 10/2025