

# SNx4HC125 Quadruple Buffers with 3-State Outputs

## 1 Features

- Buffered inputs
- Wide operating voltage range: 2 V to 6 V
- Wide operating temperature range:  $-40^{\circ}\text{C}$  to  $+85^{\circ}\text{C}$
- Supports fanout up to 10 LSTTL loads
- Significant power reduction compared to LSTTL logic ICs

## 2 Applications

- [Enable digital signals](#)

## 3 Description

This device contains four independent buffers with 3-state outputs. Each gate performs the Boolean function  $Y = A$  in positive logic.

### Device Information<sup>(1)</sup>

PART NUMBER	PACKAGE	BODY SIZE (NOM)
SN74HC125D	SOIC (14)	8.70 mm × 3.90 mm
SN74HC125DB	SSOP (14)	6.50 mm × 5.30 mm
SN74HC125N	PDIP (14)	19.30 mm × 6.40 mm
SN74HC125NS	SO (14)	10.20 mm × 5.30 mm
SN74HC125PW	TSSOP (14)	5.00 mm × 4.40 mm
SN54HC125J	CDIP (14)	21.30 mm × 7.60 mm
SN54HC125FK	LCCC (20)	8.90 mm × 8.90 mm

(1) For all available packages, see the orderable addendum at the end of the data sheet.

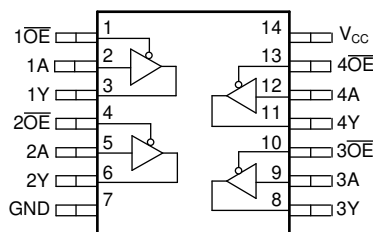

Functional pinout



## Table of Contents

<b>1 Features</b> .....	1	8.2 Functional Block Diagram.....	10
<b>2 Applications</b> .....	1	8.3 Feature Description.....	10
<b>3 Description</b> .....	1	8.4 Device Functional Modes.....	11
<b>4 Revision History</b> .....	2	<b>9 Application and Implementation</b> .....	12
<b>5 Pin Configuration and Functions</b> .....	3	9.1 Application Information.....	12
Pin Functions.....	3	9.2 Typical Application.....	12
<b>6 Specifications</b> .....	4	<b>10 Power Supply Recommendations</b> .....	14
6.1 Absolute Maximum Ratings.....	4	<b>11 Layout</b> .....	14
6.2 ESD Ratings.....	4	11.1 Layout Guidelines.....	14
6.3 Recommended Operating Conditions.....	4	11.2 Layout Example.....	14
6.4 Thermal Information.....	5	<b>12 Device and Documentation Support</b> .....	15
6.5 Electrical Characteristics - 74.....	5	12.1 Documentation Support.....	15
6.6 Electrical Characteristics - 54.....	6	12.2 Related Links.....	15
6.7 Switching Characteristics - 74.....	6	12.3 Support Resources.....	15
6.8 Switching Characteristics - 54.....	7	12.4 Trademarks.....	15
6.9 Operating Characteristics.....	7	12.5 Electrostatic Discharge Caution.....	15
6.10 Typical Characteristics.....	7	12.6 Glossary.....	15
<b>7 Parameter Measurement Information</b> .....	9	<b>13 Mechanical, Packaging, and Orderable Information</b> .....	15
<b>8 Detailed Description</b> .....	10		
8.1 Overview.....	10		

## 4 Revision History

NOTE: Page numbers for previous revisions may differ from page numbers in the current version.

Changes from Revision E (December 2015) to Revision F (April 2021)	Page
• Updated the numbering format for tables, figures, and cross-references throughout the document.....	1
• Updated to new data sheet standards.....	1
• Increased D (86 to 133.6), DB (96 to 108.0), NS (76 to 122.6), and PW (113 to 151.7); decreased N (80 to 63.0) °C/W.....	5

## 5 Pin Configuration and Functions

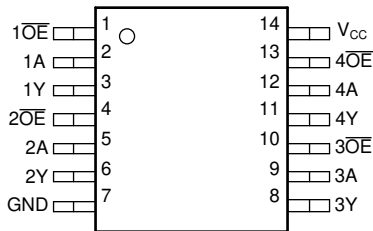

**Figure 5-1. D, DB, N, NS, PW, or J Package  
14-Pin SOIC, SSOP, PDIP, SO, TSSOP, or CDIP  
Top View**

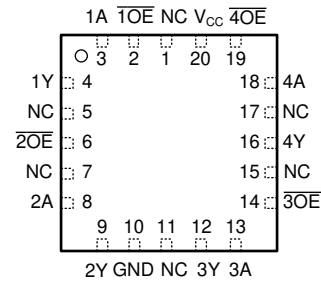

**Figure 5-2. FK Package  
20-Pin LCCC  
Top View**

## Pin Functions

NAME	PIN		I/O	DESCRIPTION
	D, DB, N, NS, PW, or J	FK		
1 OE	1	2	Input	Channel 1, Output Enable, Active Low
1A	2	3	Input	Channel 1, Input A
1Y	3	4	Output	Channel 1, Output Y
2 OE	4	6	Input	Channel 2, Output Enable, Active Low
2A	5	8	Input	Channel 2, Input A
2Y	6	9	Output	Channel 2, Output Y
GND	7	10	—	Ground
3Y	8	12	Output	Channel 3, Output Y
3A	9	13	Input	Channel 3, Input A
3 OE	10	14	Input	Channel 3, Output Enable, Active Low
4Y	11	16	Output	Channel 4, Output Y
4A	12	18	Input	Channel 4, Input A
4 OE	13	19	Input	Channel 4, Output Enable, Active Low
V <sub>CC</sub>	14	20	—	Positive Supply
NC		1, 5, 7, 11, 15, 17	—	Not internally connected

## 6 Specifications

### 6.1 Absolute Maximum Ratings

over operating free-air temperature range (unless otherwise noted)<sup>(1)</sup>

			MIN	MAX	UNIT
V <sub>CC</sub>	Supply voltage		-0.5	7	V
I <sub>IK</sub>	Input clamp current <sup>(2)</sup>	V <sub>I</sub> < 0 or V <sub>I</sub> > V <sub>CC</sub>		±20	mA
I <sub>OK</sub>	Output clamp current <sup>(2)</sup>	V <sub>O</sub> < 0 or V <sub>O</sub> > V <sub>CC</sub>		±20	mA
I <sub>O</sub>	Continuous output current	V <sub>O</sub> = 0 to V <sub>CC</sub>		±35	mA
	Continuous current through V <sub>CC</sub> or GND			±70	mA
T <sub>J</sub>	Junction temperature <sup>(3)</sup>			150	°C
T <sub>stg</sub>	Storage temperature		-65	150	°C

- (1) Stresses beyond those listed under *Absolute Maximum Rating* may cause permanent damage to the device. These are stress ratings only, which do not imply functional operation of the device at these or any other conditions beyond those indicated under *Recommended Operating Condition*. Exposure to absolute-maximum-rated conditions for extended periods may affect device reliability.
- (2) The input and output voltage ratings may be exceeded if the input and output current ratings are observed.
- (3) Guaranteed by design.

### 6.2 ESD Ratings

			VALUE	UNIT
V <sub>(ESD)</sub>	Electrostatic discharge	Human-body model (HBM), per ANSI/ESDA/ JEDEC JS-001 <sup>(1)</sup>	±2000	V
		Charged-device model (CDM), per JEDEC specification JESD22-C101 <sup>(2)</sup>	±500	

- (1) JEDEC document JEP155 states that 500-V HBM allows safe manufacturing with a standard ESD control process.
- (2) JEDEC document JEP157 states that 250-V CDM allows safe manufacturing with a standard ESD control process.

### 6.3 Recommended Operating Conditions

over operating free-air temperature range (unless otherwise noted)

			MIN	NOM	MAX	UNIT
V <sub>CC</sub>	Supply voltage		2	5	6	V
V <sub>IH</sub>	High-level input voltage	V <sub>CC</sub> = 2 V	1.5			V
		V <sub>CC</sub> = 4.5 V	3.15			
		V <sub>CC</sub> = 6 V	4.2			
V <sub>IL</sub>	Low-level input voltage	V <sub>CC</sub> = 2 V			0.5	V
		V <sub>CC</sub> = 4.5 V			1.35	
		V <sub>CC</sub> = 6 V			1.8	
V <sub>I</sub>	Input voltage		0		V <sub>CC</sub>	V
V <sub>O</sub>	Output voltage		0		V <sub>CC</sub>	V
t <sub>t</sub>	Input transition time	V <sub>CC</sub> = 2 V			1000	ns
		V <sub>CC</sub> = 4.5 V			500	
		V <sub>CC</sub> = 6 V			400	
T <sub>A</sub>	Operating free-air temperature		-55		125	°C

## 6.4 Thermal Information

THERMAL METRIC <sup>(1)</sup>		SN74HC125					UNIT
		D (SOIC)	DB (SSOP)	N (PDIP)	NS (SO)	PW (TSSOP)	
		14 PINS	14 PINS	14 PINS	14 PINS	14 PINS	
$R_{\theta JA}$	Junction-to-ambient thermal resistance	133.6	108.0	63.0	122.6	151.7	°C/W
$R_{\theta JC(top)}$	Junction-to-case (top) thermal resistance	89	57.8	50.7	81.8	79.4	°C/W
$R_{\theta JB}$	Junction-to-board thermal resistance	89.5	58.3	42.7	83.8	94.7	°C/W
$\Psi_{JT}$	Junction-to-top characterization parameter	45.5	18.0	30.3	45.4	25.2	°C/W
$\Psi_{JB}$	Junction-to-board characterization parameter	89.1	57.6	42.5	83.4	94.1	°C/W
$R_{\theta JC(bot)}$	Junction-to-case (bottom) thermal resistance	N/A	N/A	N/A	N/A	N/A	°C/W

(1) For more information about traditional and new thermal metrics, see the [Semiconductor and IC Package Thermal Metrics](#) application report.

## 6.5 Electrical Characteristics - 74

over operating free-air temperature range; typical values measured at  $T_A = 25^\circ\text{C}$  (unless otherwise noted).

PARAMETER		TEST CONDITIONS		$V_{CC}$	Operating free-air temperature ( $T_A$ )						UNIT
					25°C			-40°C to 85°C			
					MIN	TYP	MAX	MIN	TYP	MAX	
$V_{OH}$	High-level output voltage	$V_I = V_{IH}$ or $V_{IL}$	$I_{OH} = -20 \mu\text{A}$	2 V	1.9	1.998	0.1	1.9			V
				4.5 V	4.4	4.499	4.4				
				6 V	5.9	5.999	5.9				
			$I_{OH} = -6 \text{ mA}$	4.5 V	3.98	4.3	3.84				
				6 V	5.48	5.8	5.34				
$V_{OL}$	Low-level output voltage	$V_I = V_{IH}$ or $V_{IL}$	$I_{OL} = 20 \mu\text{A}$	2 V		0.002	0.1		0.1	V	
				4.5 V		0.001	0.1		0.1		
				6 V		0.001	0.1		0.1		
			$I_{OL} = 6 \text{ mA}$	4.5 V		0.17	0.26		0.33		
				6 V		0.15	0.26		0.33		
$I_I$	Input leakage current	$V_I = V_{CC}$ or 0		6 V			$\pm 0.1$		$\pm 1$	$\mu\text{A}$	
$I_{OZ}$	Three-state leakage current	$V_O = V_{CC}$ or 0		6 V		$\pm 0.01$	$\pm 0.5$		$\pm 5$	$\mu\text{A}$	
$I_{CC}$	Supply current	$V_I = V_{CC}$ or 0	$I_O = 0$	6 V			8		80	$\mu\text{A}$	
$C_i$	Input capacitance			2 V to 6 V		3	10		10	pF	

### 6.6 Electrical Characteristics - 54

over operating free-air temperature range; typical values measured at TA = 25°C (unless otherwise noted).

PARAMETER	TEST CONDITIONS	V <sub>CC</sub>	Operating free-air temperature (T <sub>A</sub> )									UNIT
			25°C			-40°C to 85°C			-55°C to 125°C			
			MIN	TYP	MAX	MIN	TYP	MAX	MIN	TYP	MAX	
V <sub>OH</sub>	High-level output voltage	V <sub>I</sub> = V <sub>IH</sub> or V <sub>IL</sub>	I <sub>OH</sub> = -20 μA	2 V	1.9	1.998		1.9		1.9		V
				4.5 V	4.4	4.499		4.4		4.4		
				6 V	5.9	5.999		5.9		5.9		
			I <sub>OH</sub> = -6 mA	4.5 V	3.98	4.3		3.84		3.7		
				6 V	5.48	5.8		5.34		5.2		
V <sub>OL</sub>	Low-level output voltage	V <sub>I</sub> = V <sub>IH</sub> or V <sub>IL</sub>	I <sub>OL</sub> = 20 μA	2 V		0.002	0.1			0.1	0.1	V
				4.5 V		0.001	0.1			0.1	0.1	
				6 V		0.001	0.1			0.1	0.1	
			I <sub>OL</sub> = 6 mA	4.5 V		0.17	0.26			0.33	0.4	
				6 V		0.15	0.26			0.33	0.4	
I <sub>I</sub>	Input leakage current	V <sub>I</sub> = V <sub>CC</sub> or 0	6 V			±0.1			±1	±1	μA	
I <sub>OZ</sub>	Three-state leakage current	V <sub>O</sub> = V <sub>CC</sub> or 0	6 V		±0.01	±0.5			±5	±10	μA	
I <sub>CC</sub>	Supply current	V <sub>I</sub> = V <sub>CC</sub> or 0 I <sub>O</sub> = 0	6 V			8			80	160	μA	
C <sub>i</sub>	Input capacitance		2 V to 6 V		3	10			10	10	pF	

### 6.7 Switching Characteristics - 74

over operating free-air temperature range (unless otherwise noted)

PARAMETER	FROM	TO	TEST CONDITIONS	V <sub>CC</sub>	Operating free-air temperature (T <sub>A</sub> )						UNIT	
					25°C			-40°C to 85°C				
					MIN	TYP	MAX	MIN	TYP	MAX		
t <sub>pd</sub>	Propagation delay	A	Y	C <sub>L</sub> = 50 pF	2 V		47	120			180	ns
					4.5 V		14	24			36	
					6 V		11	20			31	
				C <sub>L</sub> = 150 pF	2 V		67	150			225	ns
					4.5 V		19	30			45	
					6 V		15	25			39	
t <sub>en</sub>	Enable delay	$\overline{OE}$	Y	C <sub>L</sub> = 50 pF	2 V		57	120			180	ns
					4.5 V		16	24			36	
					6 V		12	20			31	
				C <sub>L</sub> = 150 pF	2 V		100	135			202	ns
					4.5 V		20	27			40	
					6 V		17	23			36	
t <sub>dis</sub>	Disable delay	$\overline{OE}$	Y	C <sub>L</sub> = 50 pF	2 V		35	120			180	ns
					4.5 V		17	24			36	
					6 V		15	20			31	

over operating free-air temperature range (unless otherwise noted)

PARAMETER		FROM	TO	TEST CONDITIONS	V <sub>CC</sub>	Operating free-air temperature (T <sub>A</sub> )						UNIT
						25°C			–40°C to 85°C			
						MIN	TYP	MAX	MIN	TYP	MAX	
t <sub>t</sub>	Transition-time		Y	C <sub>L</sub> = 50 pF	2 V	28 60		90			ns	
					4.5 V	8 12		18				
					6 V	6 10		15				
				C <sub>L</sub> = 150 pF	2 V	45 210		315			ns	
					4.5 V	17 42		63				
					6 V	13 36		53				

## 6.8 Switching Characteristics - 54

over operating free-air temperature range; typical values measured at T<sub>A</sub> = 25°C (unless otherwise noted).

PARAMETER		FROM	TO	TEST CONDITIONS	V <sub>CC</sub>	Operating free-air temperature (T <sub>A</sub> )									UNIT
						25°C			–40°C to 85°C			–55°C to 125°C			
						MIN	TYP	MAX	MIN	TYP	MAX	MIN	TYP	MAX	
t <sub>pd</sub>	Propagation delay	A	Y	C <sub>L</sub> = 50 pF	2 V	47 120		180			150			ns	
					4.5 V	14 24		36			30				
					6 V	11 20		31			26				
				C <sub>L</sub> = 150 pF	2 V	67 150		225			188			ns	
					4.5 V	19 30		45			38				
					6 V	15 25		39			33				
t <sub>en</sub>	Enable delay	OE	Y	C <sub>L</sub> = 50 pF	2 V	57 120		180			150			ns	
					4.5 V	16 24		36			30				
					6 V	12 20		31			26				
				C <sub>L</sub> = 150 pF	2 V	100 135		202			169			ns	
					4.5 V	20 27		40			36				
					6 V	17 23		36			30				
t <sub>dis</sub>	Disable delay	OE	Y	C <sub>L</sub> = 50 pF	2 V	35 120		180			150			ns	
					4.5 V	17 24		36			30				
					6 V	15 20		31			26				
t <sub>t</sub>	Transition-time		Y	C <sub>L</sub> = 50 pF	2 V	28 60		90			75			ns	
					4.5 V	8 12		18			15				
					6 V	6 10		15			13				
				C <sub>L</sub> = 150 pF	2 V	45 210		315			265			ns	
					4.5 V	17 42		63			53				
					6 V	13 36		53			45				

## 6.9 Operating Characteristics

over operating free-air temperature range; typical values measured at T<sub>A</sub> = 25°C (unless otherwise noted).

PARAMETER		TEST CONDITIONS	V <sub>CC</sub>	MIN	TYP	MAX	UNIT
C <sub>pd</sub>	Power dissipation capacitance per gate	No load	2 V to 6 V		45		pF

## 6.10 Typical Characteristics

T<sub>A</sub> = 25°C

**SN74HC125, SN54HC125**

SCLS104F – AUGUST 1984 – REVISED APRIL 2021



**Figure 6-1. Typical output voltage in the high state (V<sub>OH</sub>)**

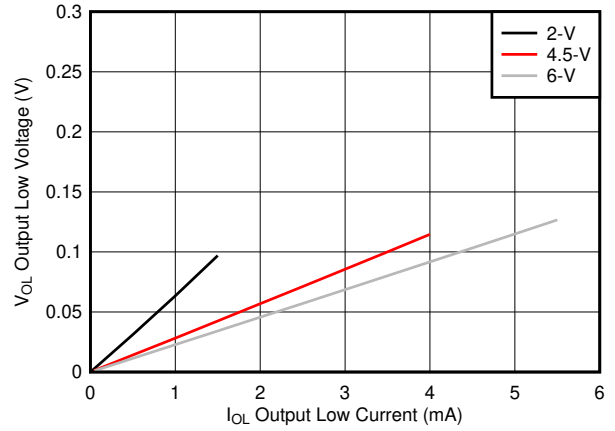

**Figure 6-2. Typical output voltage in the low state (V<sub>OL</sub>)**



## 7 Parameter Measurement Information

- Phase relationships between waveforms were chosen arbitrarily. All input pulses are supplied by generators having the following characteristics:  $PRR \leq 1 \text{ MHz}$ ,  $Z_O = 50 \Omega$ ,  $t_t < 6 \text{ ns}$ .
- The outputs are measured one at a time, with one input transition per measurement.



A.  $C_L = 50 \text{ pF}$  and includes probe and jig capacitance.

**Figure 7-1. Load Circuit**

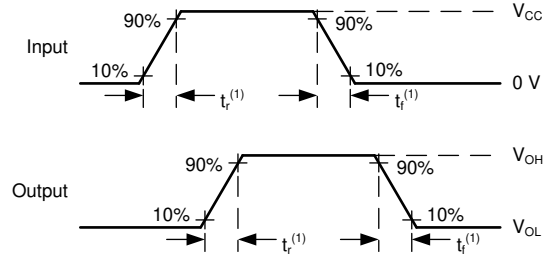

A.  $t_t$  is the greater of  $t_r$  and  $t_f$ .

**Figure 7-2. Voltage Waveforms Transition Times**

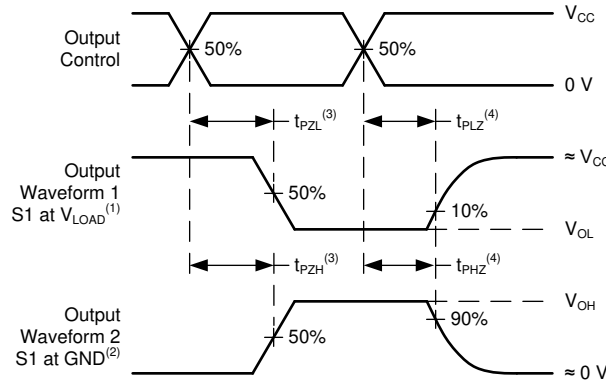

A. The maximum between  $t_{pLH}$  and  $t_{pHL}$  is used for  $t_{pd}$ .

**Figure 7-3. Voltage Waveforms Propagation Delays**

## 8 Detailed Description

### 8.1 Overview

This device contains four independent buffers with 3-state outputs. Each gate performs the Boolean function  $Y = A$  in positive logic.

### 8.2 Functional Block Diagram

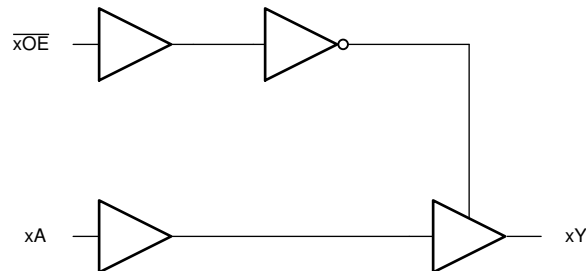

### 8.3 Feature Description

#### 8.3.1 Balanced CMOS 3-State Outputs

A balanced output allows the device to sink and source similar currents. The drive capability of this device may create fast edges into light loads so routing and load conditions should be considered to prevent ringing. Additionally, the outputs of this device are capable of driving larger currents than the device can sustain without being damaged. It is important for the output power of the device to be limited to avoid damage due to over-current. The electrical and thermal limits defined in the [Absolute Maximum Ratings](#) must be followed at all times.

The SN74HC125 can drive a load with a total capacitance less than or equal to the maximum load listed in the [Electrical Characteristics - 74](#) connected to a high-impedance CMOS input while still meeting all of the datasheet specifications. Larger capacitive loads can be applied, however it is not recommended to exceed the provided load value. If larger capacitive loads are required, it is recommended to add a series resistor between the output and the capacitor to limit output current to the values given in the [Absolute Maximum Ratings](#).

3-State outputs can be placed into a high-impedance state. In this state, the output will neither source nor sink current, and leakage current is defined by the  $I_{OZ}$  specification in the [Electrical Characteristics - 74](#). A pull-up or pull-down resistor can be used to ensure that the output remains HIGH or LOW, respectively, during the high-impedance state.

#### 8.3.2 Standard CMOS Inputs

Standard CMOS inputs are high impedance and are typically modeled as a resistor from the input to ground in parallel with the input capacitance given in the [Electrical Characteristics - 74](#). The worst case resistance is calculated with the maximum input voltage, given in the [Absolute Maximum Ratings](#), and the maximum input leakage current, given in the [Electrical Characteristics - 74](#), using ohm's law ( $R = V \div I$ ).

Signals applied to the inputs need to have fast edge rates, as defined by the input transition time in the [Recommended Operating Conditions](#) to avoid excessive current consumption and oscillations. If a slow or noisy input signal is required, a device with a Schmitt-trigger input should be used to condition the input signal prior to the standard CMOS input.

### 8.3.3 Clamp Diode Structure

The inputs and outputs to this device have both positive and negative clamping diodes as depicted in [Figure 8-1](#).

**CAUTION**

Voltages beyond the values specified in the [Absolute Maximum Ratings](#) table can cause damage to the device. The recommended input and output voltage ratings may be exceeded if the input and output clamp-current ratings are observed.

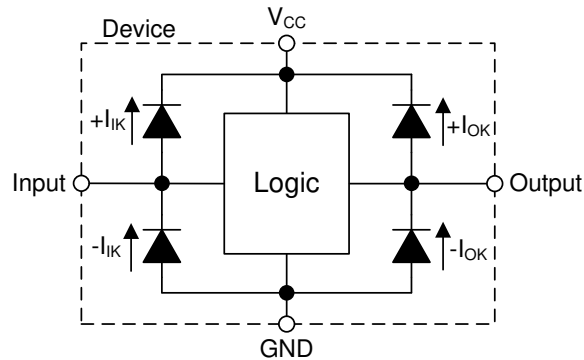

**Figure 8-1. Electrical Placement of Clamping Diodes for Each Input and Output**

### 8.4 Device Functional Modes

**Table 8-1. Function Table**

INPUTS		OUTPUT
OE	A	Y
L	H	H
L	L	L
H	X	Z

## 9 Application and Implementation

### Note

Information in the following applications sections is not part of the TI component specification, and TI does not warrant its accuracy or completeness. TI's customers are responsible for determining suitability of components for their purposes, as well as validating and testing their design implementation to confirm system functionality.

### 9.1 Application Information

In this application, a 3-state buffer is used to enable or disable a data connection as shown in [Figure 9-1](#). It is common to see all four channels of a device used together for controlling a 4-bit data bus, however each channel of the device can be used independently. Unused channels should have the inputs terminated at ground or  $V_{CC}$  and the output left unconnected.

When the output of the device is active, the data signal will be replicated at the output. When the output of the device is disabled, the output will be in a high-impedance state, and the output voltage will be determined by the circuit connected to the output pin. This circuit is most commonly used when a bus must be completely disabled. One example of this situation is when the circuitry connected to the output is to be powered off for an extended period of time to save system power, and the inputs to that circuitry cannot have a voltage present due to protective clamp diodes.

### 9.2 Typical Application

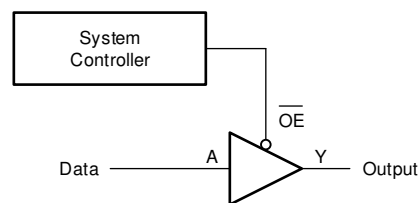

**Figure 9-1. Typical application schematic**

#### 9.2.1 Design Requirements

##### 9.2.1.1 Power Considerations

Ensure the desired supply voltage is within the range specified in the [Recommended Operating Conditions](#). The supply voltage sets the device's electrical characteristics as described in the [Electrical Characteristics - 74](#).

The supply must be capable of sourcing current equal to the total current to be sourced by all outputs of the SN74HC125 plus the maximum supply current,  $I_{CC}$ , listed in the [Electrical Characteristics - 74](#). The logic device can only source or sink as much current as it is provided at the supply and ground pins, respectively. Be sure not to exceed the maximum total current through GND or  $V_{CC}$  listed in the [Absolute Maximum Ratings](#).

Total power consumption can be calculated using the information provided in [CMOS Power Consumption and  \$C\_{pd}\$  Calculation](#).

Thermal increase can be calculated using the information provided in [Thermal Characteristics of Standard Linear and Logic \(SLL\) Packages and Devices](#).

#### CAUTION

The maximum junction temperature,  $T_J(\max)$  listed in the [Absolute Maximum Ratings](#), is an *additional limitation* to prevent damage to the device. Do not violate any values listed in the [Absolute Maximum Ratings](#). These limits are provided to prevent damage to the device.

### 9.2.1.2 Input Considerations

Unused inputs must be terminated to either  $V_{CC}$  or ground. These can be directly terminated if the input is completely unused, or they can be connected with a pull-up or pull-down resistor if the input is to be used sometimes, but not always. A pull-up resistor is used for a default state of HIGH, and a pull-down resistor is used for a default state of LOW. The resistor size is limited by drive current of the controller, leakage current into the SN74HC125, as specified in the [Electrical Characteristics - 74](#), and the desired input transition rate. A 10-k $\Omega$  resistor value is often used due to these factors.

The SN74HC125 has standard CMOS inputs, so input signal edge rates cannot be slow. Slow input edge rates can cause oscillations and damaging shoot-through current. The recommended rates are defined in the [Recommended Operating Conditions](#).

Refer to [Section 8.3](#) for additional information regarding the inputs for this device.

### 9.2.1.3 Output Considerations

The positive supply voltage is used to produce the output HIGH voltage. Drawing current from the output will decrease the output voltage as specified by the  $V_{OH}$  specification in the [Electrical Characteristics - 74](#). Similarly, the ground voltage is used to produce the output LOW voltage. Sinking current into the output will increase the output voltage as specified by the  $V_{OL}$  specification in the [Electrical Characteristics - 74](#).

Unused outputs can be left floating. Do not connect outputs directly to  $V_{CC}$  or ground.

Refer to [Section 8.3](#) for additional information regarding the outputs for this device.

## 9.2.2 Detailed Design Procedure

1. Add a decoupling capacitor from  $V_{CC}$  to GND. The capacitor needs to be placed physically close to the device and electrically close to both the  $V_{CC}$  and GND pins. An example layout is shown in [Section 11](#).
2. Ensure the capacitive load at the output is  $\leq 70$  pF. This is not a hard limit, however it will ensure optimal performance. This can be accomplished by providing short, appropriately sized traces from the SN74HC125 to the receiving device.
3. Ensure the resistive load at the output is larger than  $(V_{CC} / I_{O(max)}) \Omega$ . This will ensure that the maximum output current from the [Absolute Maximum Ratings](#) is not violated. Most CMOS inputs have a resistive load measured in megaohms; much larger than the minimum calculated above.
4. Thermal issues are rarely a concern for logic gates, however the power consumption and thermal increase can be calculated using the steps provided in the application report, [CMOS Power Consumption and Cpd Calculation](#)

### 9.2.3 Application Curves

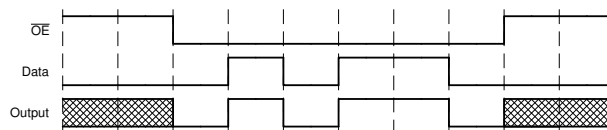

**Figure 9-2. Typical application timing diagram**

## 10 Power Supply Recommendations

The power supply can be any voltage between the minimum and maximum supply voltage rating located in the *Recommended Operating Conditions*. Each  $V_{CC}$  terminal should have a bypass capacitor to prevent power disturbance. A 0.1- $\mu\text{F}$  capacitor is recommended for this device. It is acceptable to parallel multiple bypass caps to reject different frequencies of noise. The 0.1- $\mu\text{F}$  and 1- $\mu\text{F}$  capacitors are commonly used in parallel. The bypass capacitor should be installed as close to the power terminal as possible for best results, as shown in *Figure 11-1*.

## 11 Layout

### 11.1 Layout Guidelines

When using multiple-input and multiple-channel logic devices inputs must not ever be left floating. In many cases, functions or parts of functions of digital logic devices are unused; for example, when only two inputs of a triple-input AND gate are used. Such unused input pins must not be left unconnected because the undefined voltages at the outside connections result in undefined operational states. All unused inputs of digital logic devices must be connected to a logic high or logic low voltage, as defined by the input voltage specifications, to prevent them from floating. The logic level that must be applied to any particular unused input depends on the function of the device. Generally, the inputs are tied to GND or  $V_{CC}$ , whichever makes more sense for the logic function or is more convenient.

### 11.2 Layout Example

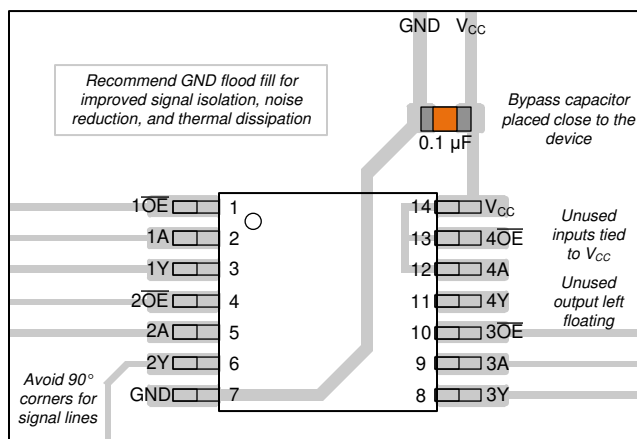

Figure 11-1. Example layout for the SN74HC125

## 12 Device and Documentation Support

### 12.1 Documentation Support

#### 12.1.1 Related Documentation

For related documentation see the following:

- [HCMOS Design Considerations](#)
- [CMOS Power Consumption and CPD Calculation](#)
- [Designing with Logic](#)

#### 12.2 Related Links

The table below lists quick access links. Categories include technical documents, support and community resources, tools and software, and quick access to sample or buy.

#### 12.3 Support Resources

[TI E2E™ support forums](#) are an engineer's go-to source for fast, verified answers and design help — straight from the experts. Search existing answers or ask your own question to get the quick design help you need.

Linked content is provided "AS IS" by the respective contributors. They do not constitute TI specifications and do not necessarily reflect TI's views; see TI's [Terms of Use](#).

#### 12.4 Trademarks

TI E2E™ is a trademark of Texas Instruments.

All trademarks are the property of their respective owners.

#### 12.5 Electrostatic Discharge Caution



This integrated circuit can be damaged by ESD. Texas Instruments recommends that all integrated circuits be handled with appropriate precautions. Failure to observe proper handling and installation procedures can cause damage.

ESD damage can range from subtle performance degradation to complete device failure. Precision integrated circuits may be more susceptible to damage because very small parametric changes could cause the device not to meet its published specifications.

#### 12.6 Glossary

[TI Glossary](#) This glossary lists and explains terms, acronyms, and definitions.

## 13 Mechanical, Packaging, and Orderable Information

The following pages include mechanical, packaging, and orderable information. This information is the most current data available for the designated devices. This data is subject to change without notice and revision of this document. For browser-based versions of this data sheet, refer to the left-hand navigation.

**PACKAGING INFORMATION**

Orderable part number	Status (1)	Material type (2)	Package   Pins	Package qty   Carrier	RoHS (3)	Lead finish/ Ball material (4)	MSL rating/ Peak reflow (5)	Op temp (°C)	Part marking (6)
<a href="#">5962-87721012A</a>	Active	Production	LCCC (FK)   20	55   TUBE	No	SNPB	N/A for Pkg Type	-55 to 125	5962-87721012A SNJ54HC 125FK
<a href="#">5962-8772101CA</a>	Active	Production	CDIP (J)   14	25   TUBE	No	SNPB	N/A for Pkg Type	-55 to 125	5962-8772101CA SNJ54HC125J
<a href="#">SN54HC125J</a>	Active	Production	CDIP (J)   14	25   TUBE	No	SNPB	N/A for Pkg Type	-55 to 125	SN54HC125J
SN54HC125J.A	Active	Production	CDIP (J)   14	25   TUBE	No	SNPB	N/A for Pkg Type	-55 to 125	SN54HC125J
<a href="#">SN74HC125D</a>	Obsolete	Production	SOIC (D)   14	-	-	Call TI	Call TI	-40 to 85	HC125
<a href="#">SN74HC125DBR</a>	Active	Production	SSOP (DB)   14	2000   LARGE T&R	Yes	NIPDAU	Level-1-260C-UNLIM	-40 to 85	HC125
SN74HC125DBR.A	Active	Production	SSOP (DB)   14	2000   LARGE T&R	Yes	NIPDAU	Level-1-260C-UNLIM	-40 to 85	HC125
<a href="#">SN74HC125DR</a>	Active	Production	SOIC (D)   14	2500   LARGE T&R	Yes	NIPDAU   SN	Level-1-260C-UNLIM	-40 to 85	HC125
SN74HC125DR.A	Active	Production	SOIC (D)   14	2500   LARGE T&R	Yes	NIPDAU	Level-1-260C-UNLIM	-40 to 85	HC125
<a href="#">SN74HC125DRG4</a>	Active	Production	SOIC (D)   14	2500   LARGE T&R	Yes	NIPDAU	Level-1-260C-UNLIM	-40 to 85	HC125
SN74HC125DRG4.A	Active	Production	SOIC (D)   14	2500   LARGE T&R	Yes	NIPDAU	Level-1-260C-UNLIM	-40 to 85	HC125
<a href="#">SN74HC125DT</a>	Obsolete	Production	SOIC (D)   14	-	-	Call TI	Call TI	-40 to 85	HC125
<a href="#">SN74HC125N</a>	Active	Production	PDIP (N)   14	25   TUBE	Yes	NIPDAU	N/A for Pkg Type	-40 to 85	SN74HC125N
SN74HC125N.A	Active	Production	PDIP (N)   14	25   TUBE	Yes	NIPDAU	N/A for Pkg Type	-40 to 85	SN74HC125N
SN74HC125NE4	Active	Production	PDIP (N)   14	25   TUBE	Yes	NIPDAU	N/A for Pkg Type	-40 to 85	SN74HC125N
<a href="#">SN74HC125NSR</a>	Active	Production	SOP (NS)   14	2000   LARGE T&R	Yes	NIPDAU	Level-1-260C-UNLIM	-40 to 85	HC125
SN74HC125NSR.A	Active	Production	SOP (NS)   14	2000   LARGE T&R	Yes	NIPDAU	Level-1-260C-UNLIM	-40 to 85	HC125
<a href="#">SN74HC125PWR</a>	Active	Production	TSSOP (PW)   14	2000   LARGE T&R	Yes	NIPDAU   SN	Level-1-260C-UNLIM	-40 to 85	HC125
SN74HC125PWR.A	Active	Production	TSSOP (PW)   14	2000   LARGE T&R	Yes	NIPDAU	Level-1-260C-UNLIM	-40 to 85	HC125
<a href="#">SN74HC125PWRG4</a>	Active	Production	TSSOP (PW)   14	2000   LARGE T&R	Yes	NIPDAU	Level-1-260C-UNLIM	-40 to 85	HC125
SN74HC125PWRG4.A	Active	Production	TSSOP (PW)   14	2000   LARGE T&R	Yes	NIPDAU	Level-1-260C-UNLIM	-40 to 85	HC125
<a href="#">SN74HC125PWT</a>	Obsolete	Production	TSSOP (PW)   14	-	-	Call TI	Call TI	-40 to 85	HC125
<a href="#">SNJ54HC125FK</a>	Active	Production	LCCC (FK)   20	55   TUBE	No	SNPB	N/A for Pkg Type	-55 to 125	5962-87721012A SNJ54HC 125FK



Orderable part number	Status (1)	Material type (2)	Package   Pins	Package qty   Carrier	RoHS (3)	Lead finish/ Ball material (4)	MSL rating/ Peak reflow (5)	Op temp (°C)	Part marking (6)
SNJ54HC125FK.A	Active	Production	LCCC (FK)   20	55   TUBE	No	SNPB	N/A for Pkg Type	-55 to 125	5962- 87721012A SNJ54HC 125FK
<a href="#">SNJ54HC125J</a>	Active	Production	CDIP (J)   14	25   TUBE	No	SNPB	N/A for Pkg Type	-55 to 125	5962-8772101CA SNJ54HC125J
SNJ54HC125J.A	Active	Production	CDIP (J)   14	25   TUBE	No	SNPB	N/A for Pkg Type	-55 to 125	5962-8772101CA SNJ54HC125J

<sup>(1)</sup> **Status:** For more details on status, see our [product life cycle](#).

<sup>(2)</sup> **Material type:** When designated, preproduction parts are prototypes/experimental devices, and are not yet approved or released for full production. Testing and final process, including without limitation quality assurance, reliability performance testing, and/or process qualification, may not yet be complete, and this item is subject to further changes or possible discontinuation. If available for ordering, purchases will be subject to an additional waiver at checkout, and are intended for early internal evaluation purposes only. These items are sold without warranties of any kind.

<sup>(3)</sup> **RoHS values:** Yes, No, RoHS Exempt. See the [TI RoHS Statement](#) for additional information and value definition.

<sup>(4)</sup> **Lead finish/Ball material:** Parts may have multiple material finish options. Finish options are separated by a vertical ruled line. Lead finish/Ball material values may wrap to two lines if the finish value exceeds the maximum column width.

<sup>(5)</sup> **MSL rating/Peak reflow:** The moisture sensitivity level ratings and peak solder (reflow) temperatures. In the event that a part has multiple moisture sensitivity ratings, only the lowest level per JEDEC standards is shown. Refer to the shipping label for the actual reflow temperature that will be used to mount the part to the printed circuit board.

<sup>(6)</sup> **Part marking:** There may be an additional marking, which relates to the logo, the lot trace code information, or the environmental category of the part.

Multiple part markings will be inside parentheses. Only one part marking contained in parentheses and separated by a "~" will appear on a part. If a line is indented then it is a continuation of the previous line and the two combined represent the entire part marking for that device.

**Important Information and Disclaimer:**The information provided on this page represents TI's knowledge and belief as of the date that it is provided. TI bases its knowledge and belief on information provided by third parties, and makes no representation or warranty as to the accuracy of such information. Efforts are underway to better integrate information from third parties. TI has taken and continues to take reasonable steps to provide representative and accurate information but may not have conducted destructive testing or chemical analysis on incoming materials and chemicals. TI and TI suppliers consider certain information to be proprietary, and thus CAS numbers and other limited information may not be available for release.

In no event shall TI's liability arising out of such information exceed the total purchase price of the TI part(s) at issue in this document sold by TI to Customer on an annual basis.

**OTHER QUALIFIED VERSIONS OF SN54HC125, SN74HC125 :**

- Catalog : [SN74HC125](#)
- Automotive : [SN74HC125-Q1](#), [SN74HC125-Q1](#)
- Military : [SN54HC125](#)

## NOTE: Qualified Version Definitions:

- Catalog - TI's standard catalog product
- Automotive - Q100 devices qualified for high-reliability automotive applications targeting zero defects
- Military - QML certified for Military and Defense Applications

**TAPE AND REEL INFORMATION**

**QUADRANT ASSIGNMENTS FOR PIN 1 ORIENTATION IN TAPE**

\*All dimensions are nominal

Device	Package Type	Package Drawing	Pins	SPQ	Reel Diameter (mm)	Reel Width W1 (mm)	A0 (mm)	B0 (mm)	K0 (mm)	P1 (mm)	W (mm)	Pin1 Quadrant
SN74HC125DBR	SSOP	DB	14	2000	330.0	16.4	8.35	6.6	2.4	12.0	16.0	Q1
SN74HC125DRG4	SOIC	D	14	2500	330.0	16.4	6.5	9.0	2.1	8.0	16.0	Q1
SN74HC125NSR	SOP	NS	14	2000	330.0	16.4	8.45	10.55	2.5	12.0	16.2	Q1
SN74HC125PWR	TSSOP	PW	14	2000	330.0	12.4	6.9	5.6	1.6	8.0	12.0	Q1
SN74HC125PWRG4	TSSOP	PW	14	2000	330.0	12.4	6.9	5.6	1.6	8.0	12.0	Q1

**TAPE AND REEL BOX DIMENSIONS**

\*All dimensions are nominal

Device	Package Type	Package Drawing	Pins	SPQ	Length (mm)	Width (mm)	Height (mm)
SN74HC125DBR	SSOP	DB	14	2000	353.0	353.0	32.0
SN74HC125DRG4	SOIC	D	14	2500	353.0	353.0	32.0
SN74HC125NSR	SOP	NS	14	2000	353.0	353.0	32.0
SN74HC125PWR	TSSOP	PW	14	2000	356.0	356.0	35.0
SN74HC125PWRG4	TSSOP	PW	14	2000	353.0	353.0	32.0

**TUBE**

\*All dimensions are nominal

Device	Package Name	Package Type	Pins	SPQ	L (mm)	W (mm)	T (μm)	B (mm)
5962-87721012A	FK	LCCC	20	55	506.98	12.06	2030	NA
SN74HC125N	N	PDIP	14	25	506	13.97	11230	4.32
SN74HC125N	N	PDIP	14	25	506	13.97	11230	4.32
SN74HC125N.A	N	PDIP	14	25	506	13.97	11230	4.32
SN74HC125N.A	N	PDIP	14	25	506	13.97	11230	4.32
SN74HC125NE4	N	PDIP	14	25	506	13.97	11230	4.32
SN74HC125NE4	N	PDIP	14	25	506	13.97	11230	4.32
SNJ54HC125FK	FK	LCCC	20	55	506.98	12.06	2030	NA
SNJ54HC125FK.A	FK	LCCC	20	55	506.98	12.06	2030	NA

D0014A



# PACKAGE OUTLINE

## SOIC - 1.75 mm max height

SMALL OUTLINE INTEGRATED CIRCUIT



4220718/A 09/2016

NOTES:

1. All linear dimensions are in millimeters. Dimensions in parenthesis are for reference only. Dimensioning and tolerancing per ASME Y14.5M.
2. This drawing is subject to change without notice.
3. This dimension does not include mold flash, protrusions, or gate burrs. Mold flash, protrusions, or gate burrs shall not exceed 0.15 mm, per side.
4. This dimension does not include interlead flash. Interlead flash shall not exceed 0.43 mm, per side.
5. Reference JEDEC registration MS-012, variation AB.

# EXAMPLE BOARD LAYOUT

D0014A

SOIC - 1.75 mm max height

SMALL OUTLINE INTEGRATED CIRCUIT



LAND PATTERN EXAMPLE  
SCALE:8X



SOLDER MASK DETAILS

4220718/A 09/2016

NOTES: (continued)

- 6. Publication IPC-7351 may have alternate designs.
- 7. Solder mask tolerances between and around signal pads can vary based on board fabrication site.

# EXAMPLE STENCIL DESIGN

D0014A

SOIC - 1.75 mm max height

SMALL OUTLINE INTEGRATED CIRCUIT



SOLDER PASTE EXAMPLE  
BASED ON 0.125 mm THICK STENCIL  
SCALE:8X

4220718/A 09/2016

NOTES: (continued)

8. Laser cutting apertures with trapezoidal walls and rounded corners may offer better paste release. IPC-7525 may have alternate design recommendations.
9. Board assembly site may have different recommendations for stencil design.



# MECHANICAL DATA

NS (R-PDSO-G\*\*)

PLASTIC SMALL-OUTLINE PACKAGE

14-PINS SHOWN



- NOTES:
- A. All linear dimensions are in millimeters.
  - B. This drawing is subject to change without notice.
  - C. Body dimensions do not include mold flash or protrusion, not to exceed 0,15.

# DB0014A



# PACKAGE OUTLINE

## SSOP - 2 mm max height

SMALL OUTLINE PACKAGE



4220762/A 05/2024

### NOTES:

1. All linear dimensions are in millimeters. Any dimensions in parenthesis are for reference only. Dimensioning and tolerancing per ASME Y14.5M.
2. This drawing is subject to change without notice.
3. This dimension does not include mold flash, protrusions, or gate burrs. Mold flash, protrusions, or gate burrs shall not exceed 0.15 mm per side.
4. Reference JEDEC registration MO-150.

# EXAMPLE BOARD LAYOUT

DB0014A

SSOP - 2 mm max height

SMALL OUTLINE PACKAGE



LAND PATTERN EXAMPLE  
EXPOSED METAL SHOWN  
SCALE: 10X



4220762/A 05/2024

NOTES: (continued)

5. Publication IPC-7351 may have alternate designs.
6. Solder mask tolerances between and around signal pads can vary based on board fabrication site.

# EXAMPLE STENCIL DESIGN

DB0014A

SSOP - 2 mm max height

SMALL OUTLINE PACKAGE



SOLDER PASTE EXAMPLE  
BASED ON 0.125 mm THICK STENCIL  
SCALE: 10X

4220762/A 05/2024

NOTES: (continued)

7. Laser cutting apertures with trapezoidal walls and rounded corners may offer better paste release. IPC-7525 may have alternate design recommendations.
8. Board assembly site may have different recommendations for stencil design.

## GENERIC PACKAGE VIEW

**FK 20**

**LCCC - 2.03 mm max height**

8.89 x 8.89, 1.27 mm pitch

LEADLESS CERAMIC CHIP CARRIER

This image is a representation of the package family, actual package may vary.  
Refer to the product data sheet for package details.



4229370VA\

J 14

**GENERIC PACKAGE VIEW**  
**CDIP - 5.08 mm max height**  
CERAMIC DUAL IN LINE PACKAGE

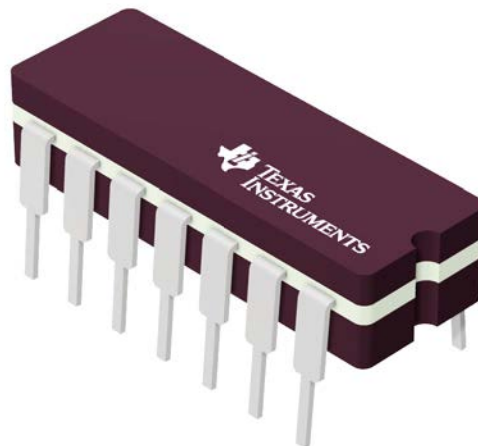

Images above are just a representation of the package family, actual package may vary.  
Refer to the product data sheet for package details.

4040083-5/G



# J0014A

# PACKAGE OUTLINE

## CDIP - 5.08 mm max height

CERAMIC DUAL IN LINE PACKAGE



4214771/A 05/2017

### NOTES:

1. All controlling linear dimensions are in inches. Dimensions in brackets are in millimeters. Any dimension in brackets or parenthesis are for reference only. Dimensioning and tolerancing per ASME Y14.5M.
2. This drawing is subject to change without notice.
3. This package is hermetically sealed with a ceramic lid using glass frit.
4. Index point is provided on cap for terminal identification only and on press ceramic glass frit seal only.
5. Falls within MIL-STD-1835 and GDIP1-T14.

# EXAMPLE BOARD LAYOUT

J0014A

CDIP - 5.08 mm max height

CERAMIC DUAL IN LINE PACKAGE



LAND PATTERN EXAMPLE  
NON-SOLDER MASK DEFINED  
SCALE: 5X



4214771/A 05/2017



N (R-PDIP-T\*\*)

PLASTIC DUAL-IN-LINE PACKAGE

16 PINS SHOWN



- NOTES:
- A. All linear dimensions are in inches (millimeters).
  - B. This drawing is subject to change without notice.
  - Falls within JEDEC MS-001, except 18 and 20 pin minimum body length (Dim A).
  - The 20 pin end lead shoulder width is a vendor option, either half or full width.

PW0014A

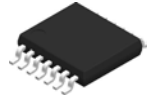

# PACKAGE OUTLINE

## TSSOP - 1.2 mm max height

SMALL OUTLINE PACKAGE



4220202/B 12/2023

NOTES:

1. All linear dimensions are in millimeters. Any dimensions in parenthesis are for reference only. Dimensioning and tolerancing per ASME Y14.5M.
2. This drawing is subject to change without notice.
3. This dimension does not include mold flash, protrusions, or gate burrs. Mold flash, protrusions, or gate burrs shall not exceed 0.15 mm per side.
4. This dimension does not include interlead flash. Interlead flash shall not exceed 0.25 mm per side.
5. Reference JEDEC registration MO-153.

# EXAMPLE BOARD LAYOUT

PW0014A

TSSOP - 1.2 mm max height

SMALL OUTLINE PACKAGE



LAND PATTERN EXAMPLE  
EXPOSED METAL SHOWN  
SCALE: 10X

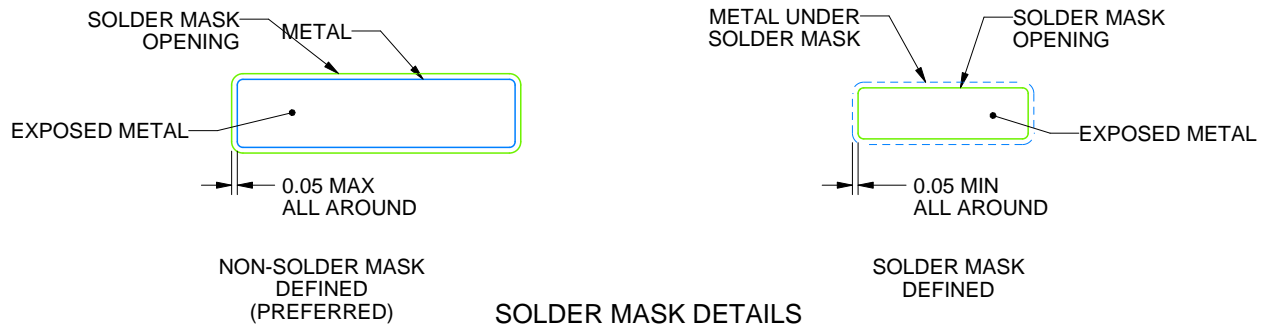

4220202/B 12/2023

NOTES: (continued)

- 6. Publication IPC-7351 may have alternate designs.
- 7. Solder mask tolerances between and around signal pads can vary based on board fabrication site.

# EXAMPLE STENCIL DESIGN

PW0014A

TSSOP - 1.2 mm max height

SMALL OUTLINE PACKAGE



SOLDER PASTE EXAMPLE  
BASED ON 0.125 mm THICK STENCIL  
SCALE: 10X

4220202/B 12/2023

NOTES: (continued)

8. Laser cutting apertures with trapezoidal walls and rounded corners may offer better paste release. IPC-7525 may have alternate design recommendations.
9. Board assembly site may have different recommendations for stencil design.

## IMPORTANT NOTICE AND DISCLAIMER

TI PROVIDES TECHNICAL AND RELIABILITY DATA (INCLUDING DATASHEETS), DESIGN RESOURCES (INCLUDING REFERENCE DESIGNS), APPLICATION OR OTHER DESIGN ADVICE, WEB TOOLS, SAFETY INFORMATION, AND OTHER RESOURCES "AS IS" AND WITH ALL FAULTS, AND DISCLAIMS ALL WARRANTIES, EXPRESS AND IMPLIED, INCLUDING WITHOUT LIMITATION ANY IMPLIED WARRANTIES OF MERCHANTABILITY, FITNESS FOR A PARTICULAR PURPOSE OR NON-INFRINGEMENT OF THIRD PARTY INTELLECTUAL PROPERTY RIGHTS.

These resources are intended for skilled developers designing with TI products. You are solely responsible for (1) selecting the appropriate TI products for your application, (2) designing, validating and testing your application, and (3) ensuring your application meets applicable standards, and any other safety, security, regulatory or other requirements.

These resources are subject to change without notice. TI grants you permission to use these resources only for development of an application that uses the TI products described in the resource. Other reproduction and display of these resources is prohibited. No license is granted to any other TI intellectual property right or to any third party intellectual property right. TI disclaims responsibility for, and you fully indemnify TI and its representatives against any claims, damages, costs, losses, and liabilities arising out of your use of these resources.

TI's products are provided subject to [TI's Terms of Sale](#), [TI's General Quality Guidelines](#), or other applicable terms available either on [ti.com](http://ti.com) or provided in conjunction with such TI products. TI's provision of these resources does not expand or otherwise alter TI's applicable warranties or warranty disclaimers for TI products. Unless TI explicitly designates a product as custom or customer-specified, TI products are standard, catalog, general purpose devices.

TI objects to and rejects any additional or different terms you may propose.

Copyright © 2026, Texas Instruments Incorporated

Last updated 10/2025