

SN75LVPE802 Two-Channel 8 Gbps SATA Express Equalizer and Redriver

1 Features

- SATA Express Support
- Selectable Equalization and De-Emphasis
- Hot Plug Capable
- Receiver Detect and OOB Support
- Integrated Output Squelch
- Multirate Operation
 - SATA: 1.5 Gbps, 3 Gbps, 6 Gbps
 - PCIe: 2.5 Gbps, 5 Gbps, 8 Gbps
- Excellent Jitter and Loss Compensation Capability to Over 24-Inch (61-cm) FR4 Trace
- Low Power
 - < 220 mW (Typical)
 - < 50 mW (in Auto Low-Power Mode)
 - < 5 mW (in Standby Mode)
- 20-Pin 4-mm × 4-mm QFN Package
- High Protection Against ESD Transient
 - HBM: 10,000 V
 - CDM: 1,500 V
 - MM: 200 V
- Extended Commercial Temperature Support 0°C to 85°C

2 Applications

- Tablets
- Notebooks
- Desktops
- Docking Stations

3 Description

The SN75LVPE802 is a versatile dual channel, SATA Express signal conditioner supporting data rates up to 8 Gbps. The device supports SATA Gen 1, 2, and 3 specifications as well as PCIe 1, 2, 3. The SN75LVPE802 operates from a single 3.3-V supply and has 100-Ω line termination with self-biasing feature, making the device suitable for AC coupling. The inputs incorporate an out-of-band (OOB) detector, which automatically squelches the output when the input differential voltage falls below threshold while maintaining a stable common-mode voltage. The device is also designed to handle spread spectrum clocking (SSC) transmission per SATA standard.

The SN75LVPE802 handles interconnect losses at its input with selectable equalization settings that can be programmed to match the loss in the channel. For data rates of 3 Gbps and lower, the SN75LVPE802 equalizes signals for a span of up to 50 inches of FR4 board material. For data rates of 8 Gbps, the device compensates up to 40 in of FR4 material. The equalization level is controlled by the setting of the signal control pin EQ.

Two de-emphasis levels can be selected on the transmit side to provide 0 or 1.2 dB of additional high-frequency loss compensation at the output.

Device Information⁽¹⁾

PART NUMBER	PACKAGE	BODY SIZE (NOM)
SN75LVPE802	WQFN (20)	4.00 mm x 4.00 mm

(1) For all available packages, see the orderable addendum at the end of the data sheet.

Simplified Schematics

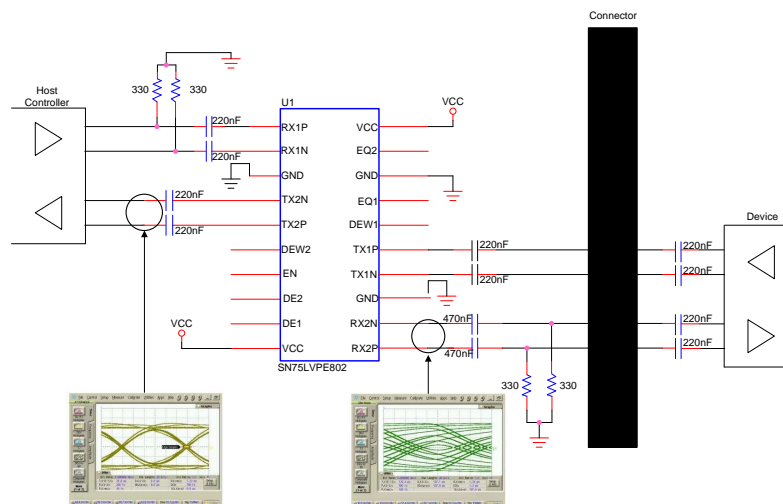

Copyright © 2017, Texas Instruments Incorporated



Table of Contents

1 Features	1	8.3 Feature Description	15
2 Applications	1	8.4 Device Functional Modes	18
3 Description	1	9 Application and Implementation	19
4 Revision History	2	9.1 Application Information	19
5 Description (continued)	2	9.2 Typical SATA Application	19
6 Pin Configuration and Functions	3	9.3 SATA Express Applications	25
7 Specifications	4	10 Power Supply Recommendations	26
7.1 Absolute Maximum Ratings	4	11 Layout	27
7.2 ESD Ratings	4	11.1 Layout Guidelines	27
7.3 Recommended Operating Conditions	4	11.2 Layout Example	28
7.4 Thermal Information	4	12 Device and Documentation Support	29
7.5 Electrical Characteristics	5	12.1 Receiving Notification of Documentation Updates	29
7.6 Timing Requirements	6	12.2 Community Resources	29
7.7 Switching Characteristics	7	12.3 Trademarks	29
7.8 Typical Characteristics	9	12.4 Electrostatic Discharge Caution	29
8 Detailed Description	15	12.5 Glossary	29
8.1 Overview	15	13 Mechanical, Packaging, and Orderable Information	29
8.2 Functional Block Diagram	15		

4 Revision History

Changes from Revision A (September 2016) to Revision B	Page
• Changed Figure 27 note From: Input Trace Length = 53 in. To: Input Trace Length = 3 in.	22
• Changed title of Figure 35 From: Output Eye (TP2) to: Input Eye (TP2)	23
• Changed Figure 37 note From: Input Trace Length = 36 in. To: Input Trace Length = 48 in.	23
• Changed Figure 38 note From: Input Trace Length = 36 in. To: Input Trace Length = 48 in.	23
• Changed title of Figure 38 From: Input Eye (TP4) To: Output Eye (TP4)	23
• Changed note in Figure 40 From: Output Trace Length = 0 in To: Output Trace Length = 3 in.	24
• Changed note in Figure 42 From: Output Trace Length = 6 in To: Output Trace Length = 12 in.	24

Changes from Original (January 2016) to Revision A	Page
• Changed the device From: Product Preview To: Production	1

5 Description (continued)

The device is hot-plug capable (requires use of AC coupling capacitors at differential inputs and outputs) preventing device damage under device hot-insertion such as async signal plug/removal, unpowered plug/removal, powered plug/removal, or surprise plug/removal.

6 Pin Configuration and Functions

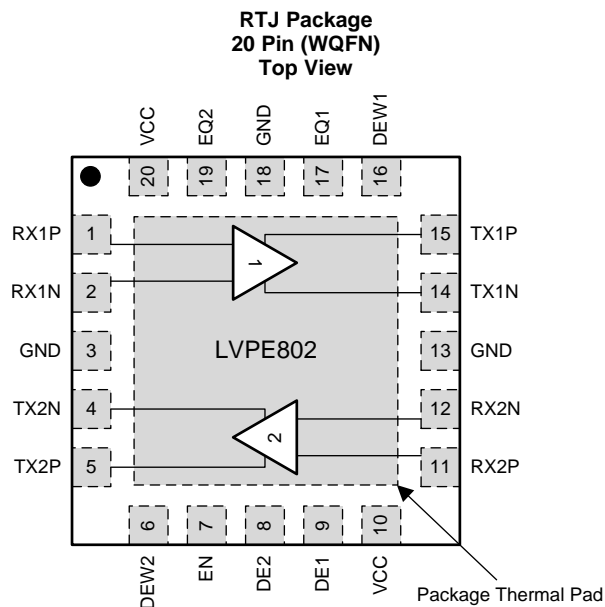

PIN		I/O	DESCRIPTION
NAME	NO.		
Control Pins			
DE1 ⁽¹⁾	9	I, LVCMOS	Selects de-emphasis settings for CH 1 and CH 2 per Table 1 .
DE2 ⁽¹⁾	8	I, LVCMOS	Internally tied to $V_{CC} / 2$.
DEW1	16	I, LVCMOS	De-emphasis width control for CH 1 and CH 2. 0 = De-emphasis pulse duration, short 1 = De-emphasis pulse duration, long (default)
DEW2	6	I, LVCMOS	
EN	7	I, LVCMOS	Device enable and disable pin, internally pulled to V_{CC} . 0 = Device in standby mode 1 = Device enabled (default)
EQ1 ⁽¹⁾	17	I, LVCMOS	Select equalization settings for CH 1 and CH 2 per Table 1 .
EQ2 ⁽¹⁾	19	I, LVCMOS	Internally tied to $V_{CC} / 2$.
High Speed Differential I/O			
RX1N	2	I, CML	Non-inverting and inverting CML differential input for CH 1 and CH 2. These pins connect to an internal voltage bias via a dual termination resistor circuit.
RX1P	1	I, CML	
RX2N	12	I, CML	
RX2P	11	I, CML	
TX1N	14	O, VML	Non-inverting and inverting VML differential input for CH 1 and CH 2. These pins connect to an internal voltage bias via a dual termination resistor circuit.
TX1P	15	O, VML	
TX2N	4	O, VML	
TX2P	5	O, VML	
POWER			
GND	3, 13, 18	Power	Supply ground
VCC	10, 20	Power	Positive supply must be $3.3V \pm 10\%$

(1) Internally biased to $V_{CC} / 2$ with $>200\text{-}\Omega$ k pullup or pulldown. When 3-state pins are left as NC, board leakage at the pin pad must be $< 1 \mu\text{A}$; otherwise, drive to $V_{CC} / 2$ to assert mid-level state.

7 Specifications

7.1 Absolute Maximum Ratings

over operating free-air temperature range (unless otherwise noted)⁽¹⁾

		MIN	MAX	UNIT
Supply Voltage Range ⁽²⁾ , V_{CC}		-0.5	4	V
Voltage Range	Differential I/O	-0.5	4	V
	Control I/O	-0.5	$V_{CC} + 0.5$	V
Continuous power dissipation		See Thermal Information		
Storage temperature, T_{stg}			150	°C

- (1) Stresses beyond those listed under *Absolute Maximum Ratings* may cause permanent damage to the device. These are stress ratings only, which do not imply functional operation of the device at these or any other conditions beyond those indicated under *Recommended Operating Conditions*. Exposure to absolute-maximum-rated conditions for extended periods may affect device reliability.
- (2) All voltage values, except differential voltages, are with respect to network ground terminal.

7.2 ESD Ratings

		VALUE	UNIT
$V_{(ESD)}$ Electrostatic discharge	Human-body model (HBM), per ANSI/ESDA/JEDEC JS-001 ⁽¹⁾	±10000	V
	Charged-device model (CDM), per JEDEC specification JESD22-C101 ⁽²⁾	±1500	
	Machine model ⁽³⁾	±200	

- (1) JEDEC document JEP155 states that 500-V HBM allows safe manufacturing with a standard ESD control process.
- (2) JEDEC document JEP157 states that 250-V CDM allows safe manufacturing with a standard ESD control process.
- (3) Tested in accordance with JEDEC Standard 22, Test Method A115-A

7.3 Recommended Operating Conditions

over operating free-air temperature range (unless otherwise noted)

		MIN	NOM	MAX	UNIT
V_{CC}	Supply Voltage	3	3.3	3.6	V
$C_{(coupling)}$	Coupling Capacitor		12		nF
T_A	Operating free-air temperature	0		85	°C

7.4 Thermal Information

THERMAL METRIC ⁽¹⁾		SN75LVPE802	UNIT
		RTJ (WQFN)	
		20 PINS	
$R_{\theta JA}$	Junction-to-ambient thermal resistance	38	°C/W
$R_{\theta JC(top)}$	Junction-to-case (top) thermal resistance	40	°C/W
$R_{\theta JB}$	Junction-to-board thermal resistance	10	°C/W
Ψ_{JT}	Junction-to-top characterization parameter	0.5	°C/W
Ψ_{JB}	Junction-to-board characterization parameter	0.9	°C/W
$R_{\theta JC(bot)}$	Junction-to-case (bottom) thermal resistance	15.2	°C/W

- (1) For more information about traditional and new thermal metrics, see the [Semiconductor and IC Package Thermal Metrics](#) application report.

7.5 Electrical Characteristics

over operating free-air temperature range (unless otherwise noted)

PARAMETER		TEST CONDITIONS	MIN	TYP	MAX	UNIT
P_D	Power dissipation in active mode	DEWX = EN = VCC, EQX = DEX = NC, K28.5 pattern at 6 Gbps, $V_{ID} = 700$ mVpp		188	205	mW
P_{SD}	Power dissipation in standby mode	EN = 0 V, DEWX = EQX = DEX = NC, K28.5 pattern at 6 Gbps, $V_{ID} = 700$ mVpp			4	mW
I_{CC}	Active mode supply current	EN = 3.3 V, DEWX = EQX = DEX = NC, K28.5 pattern at 6 Gbps, $V_{ID} = 700$ mVpp		57	62	mA
$I_{CC(STDBY)}$	Standby mode supply current	EN = 0 V			1	mA
	Maximum data rate				8	Gbps
OOB						
$V_{(OOB)}$	Input OOB threshold	F = 750 MHz	50	78	150	mVpp
$DV_{diff(OOB)}$	OOB differential delta				25	mV
$DV_{CM(OOB)}$	OOB common-mode delta				50	mV
CONTROL LOGIC						
V_{IH}	High-level input voltage	For all control pins	1.4			V
V_{IL}	Low-level input voltage				0.5	V
$V_{IN(HYS)}$	Input hysteresis			115		mV
I_{IH}	High-level input current	EQX, DEX = VCC			30	μ A
		EN, DEWX = VCC			1	μ A
I_{IL}	Low-level input current	EQX, DEX = GND	-30			μ A
		EN, DEWX = GND	-10			μ A
RECEIVER AC/DC						
$Z_{(DIFFRX)}$	Differential-Input Impedance		85	100	115	Ω
$Z_{(SERX)}$	Single-Ended Input Impedance		40			Ω
$V_{CM(RX)}$	Common-mode voltage			1.8		V
$R_{L(DIFFRX)}$	Differential mode return Loss (R_L)	f = 150 MHz – 300 MHz	22	28		dB
		f = 300 MHz – 600 MHz	14	17		dB
		f = 600 MHz – 1.2 GHz	10	12		dB
		f = 1.2 GHz – 2.4 GHz	8	9		dB
		f = 2.4 GHz – 3 GHz	7	9		dB
		f = 3 GHz – 5 GHz	6	8		dB
$R_{X(DIFFRLSlope)}$	Differential mode R_L slope	f = 300 MHz – 6 GHz		14		dB/dec
$R_{L(CMRX)}$	Common mode return loss	f = 150 MHz – 300 MHz	9	10		dB
		f = 300 MHz – 600 MHz	14	17		dB
		f = 600 MHz – 1.2 GHz	15	23		dB
		f = 1.2 GHz – 2.4 GHz	13	16		dB
		f = 2.4 GHz – 3 GHz	10	12		dB
		f = 3 GHz – 5 GHz	4	6		dB
$V_{(diffRX)}$	Differential input voltage PP	f = 1.5 GHz and 3 GHz	120		1600	mVppd
$I_{B(RX)}$	Impedance Balance	f = 150 MHz – 300 MHz	30	41		dB
		f = 300 MHz – 600 MHz	30	38		dB
		f = 600 MHz – 1.2 GHz	20	32		dB
		f = 1.2 GHz – 2.4 GHz	10	26		dB
		f = 2.4 GHz – 3 GHz	10	25		dB
		f = 3 GHz – 5 GHz	4	20		dB
		f = 5 GHz – 6.5 GHz	4	17		dB
TRANSMITTER AC/DC						
$Z_{(diffTX)}$	Pair differential impedance		85	100	122	Ω
$Z_{(SETX)}$	Single-Ended input Impedance		40			Ω
$V_{(TXtrans)}$	Sequencing transient voltage	Transient voltages on the serial data bus during power sequencing (lab load)	-1.2		1.2	V

Electrical Characteristics (continued)

over operating free-air temperature range (unless otherwise noted)

PARAMETER		TEST CONDITIONS	MIN	TYP	MAX	UNIT
$R_{L(DiffTX)}$	Diff Mode return Loss	f = 150 MHz – 300 MHz	19	25		dB
		f = 300 MHz – 600 MHz	17	19		dB
		f = 600 MHz – 1.2 GHz	11	14		dB
		f = 1.2 GHz – 2.4 GHz	8	10		dB
		f = 2.4 GHz – 3 GHz	8	10		dB
		f = 3 GHz – 5 GHz	8	10		dB
$T_{X(DiffRLslope)}$	Differential-mode R_L slope	f = 300 MHz to 3 GHz		14		dB/dec
$R_{L(CMTX)}$	Common Mode return Loss	f = 150 MHz – 300 MHz	16	20		dB
		f = 300 MHz – 600 MHz	15	19		dB
		f = 600 MHz – 1.2 GHz	14	17		dB
		f = 1.2 GHz – 2.4 GHz	10	12		dB
		f = 2.4 GHz – 3 GHz	9	11		dB
		f = 3 GHz – 5 GHz	6	7		dB
$I_{(BTX)}$	Impedance Balance	f = 150 MHz – 300 MHz	30	41		dB
		f = 300 MHz – 600 MHz	30	38		dB
		f = 600 MHz – 1.2 GHz	20	33		dB
		f = 1.2 GHz – 2.4 GHz	10	24		dB
		f = 2.4 MHz – 3 GHz	10	26		dB
		f = 3 GHz – 5 GHz	4	22		dB
		f = 5 GHz – 6.5 GHz	4	21		dB
DE	Output de-emphasis (relative to transition bit)	DE1 0r DE2 = 0		0		dB
		DE1 0r DE2 = 1		–2		dB
		DE1 0r DE2 = NC		–4		dB
$Diff_{(VppTX_DE)}$	Differential output-voltage swing dc level	DE1 0r DE2 = 0		550		mV
		DE1 0r DE2 = 1		830		mV
		DE1 0r DE2 = NC		630		mV
$V_{(CMAC_TX)}$	TX AC CM Voltage	At 1.5 GHz		20	50	mVppd
		At 3 GHz		12	26	dBmV (rms)
		At 6 GHz		13	30	dBmV (rms)
$V_{(CMTX)}$	Common-Mode Voltage			1.8		V
$T_{X(R/Fimb)}$	TX rise-fall imbalance	At 3 GHz		6%	20%	V
$T_{X(Amplimb)}$	TX amplitude imbalance			2%	10%	V

7.6 Timing Requirements

			MIN	NOM	MAX	UNIT
DEVICE PARAMETERS						
	Auto low-power entry time	Electrical idle at input (see Figure 24)	80	105	130	ps
	Auto low-power exit time	After first signal activity (see Figure 24)		42	50	ps
TRANSMITTER AC/DC						
t_{DE}	Input OOB threshold	DEW1 or DEW2 = 0		94		ps
		DEW1 or DEW2 = 1		215		ps
OUT-OF-BAND (OOB)						
t_{OOB1}	OOB mode enter	See Figure 23		3	5	ns
t_{OOB2}	OOB mode exit			3	5	ns

7.7 Switching Characteristics

over operating free-air temperature range (unless otherwise noted)

PARAMETER		TEST CONDITIONS	MIN	TYP	MAX	UNIT
DEVICE PARAMETERS						
t_{PDelay}	Propagation delay	Measured using K28.5 pattern (see Figure 1)		323	400	ps
t_{ENB}	Device enable time	EN 0 → 1			5	μs
t_{DIS}	Device disable time	EN 1 → 0			2	μs
RECEIVER AC/DC						
$t_{20-80RX}$	Rise/fall time	Rise times and fall times measured between 20% and 80% of the signal. SATA 6-Gbps speed measured 1 in, (2.5 cm) from device pin.	62		75	ps
t_{SKEWRX}	Differential skew	Difference between the single-ended midpoint of the RX+ signal rising or falling edge, and the single-ended midpoint of the RX– signal falling or rising edge.			30	ps
TRANSMITTER AC/DC						
$t_{20-80TX}$	Rise/fall time	Rise times and fall times measured between 20% and 80% of the signal. At 6 Gbps under no load conditions.	42	55	75	ps
t_{SKEWTX}	Differential skew	Difference between the single-ended midpoint of the TX+ signal rising or falling edge, and the single-ended midpoint of the TX– signal falling or rising edge.		6	20	ps
TRANSMITTER JITTER						
DJ _{TX}	Deterministic jitter ⁽¹⁾ at CP in	$V_{ID} = 500$ mVpp, UI = 333 ps, K28.5 control character		0.06	5	Ulp-p
RJ _{TX}	Residual Random jitter ⁽¹⁾	$V_{ID} = 500$ mVpp, UI = 333 ps, K28.7 control character		0.01	5	ps-rms
DJ _{TX}	Deterministic jitter ⁽¹⁾ at CP in	$V_{ID} = 500$ mVpp, UI = 167 ps, K28.5 control character		0.08	0.16	Ulp-p
RJ _{TX}	Residual random jitter ⁽¹⁾	$V_{ID} = 500$ mVpp, UI = 167 ps, K28.7 control character		0.09	2	ps-rms
DJ _{TX}	Deterministic jitter ⁽¹⁾ at CP in	$V_{ID} = 500$ mVpp, UI = 125 ps, K28.5 control character		0.1	0.2	Ulp-p
RJ _{TX}	Residual random jitter ⁽¹⁾	$V_{ID} = 500$ mVpp, UI = 125 ps, K28.7 control character		0.3	1.5	ps-rms

 (1) $T_J = (14.1 \times RJSD + DJ)$, where RJSD is one standard deviation value

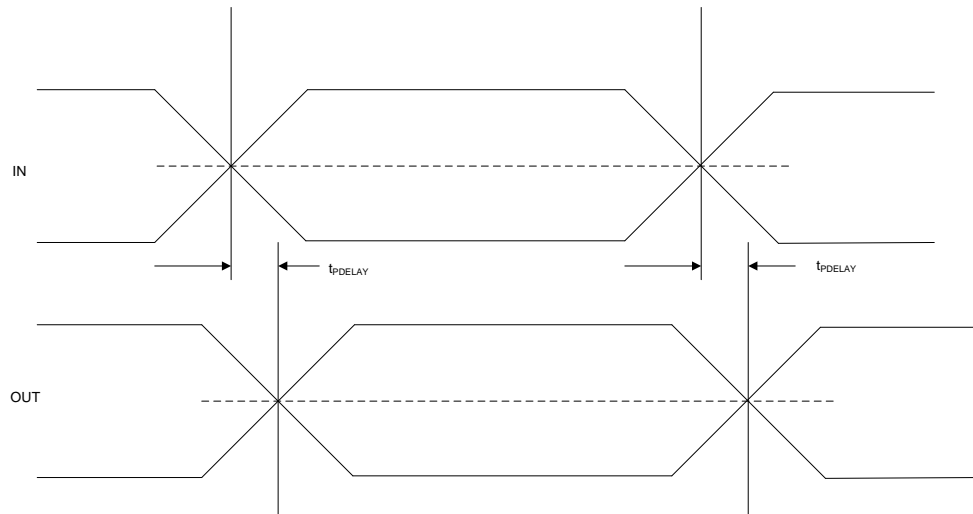

Copyright © 2016, Texas Instruments Incorporated

Figure 1. Propagation Delay Timing Diagram

7.8 Typical Characteristics

Input signal characteristics:

- Data rate = 8 Gbps 6 bps, 3 Gbps, 1.5 Gbps
- Amplitude = 500 mVpp
- o Data pattern = K28.5

SN75LVPE802 device setup:

- Temperature = 25°C
- Voltage = 3.3 V
- De-emphasis duration = 117 ps (short)
- Equalization and de-emphasis set to optimize performance at 6 Gbps

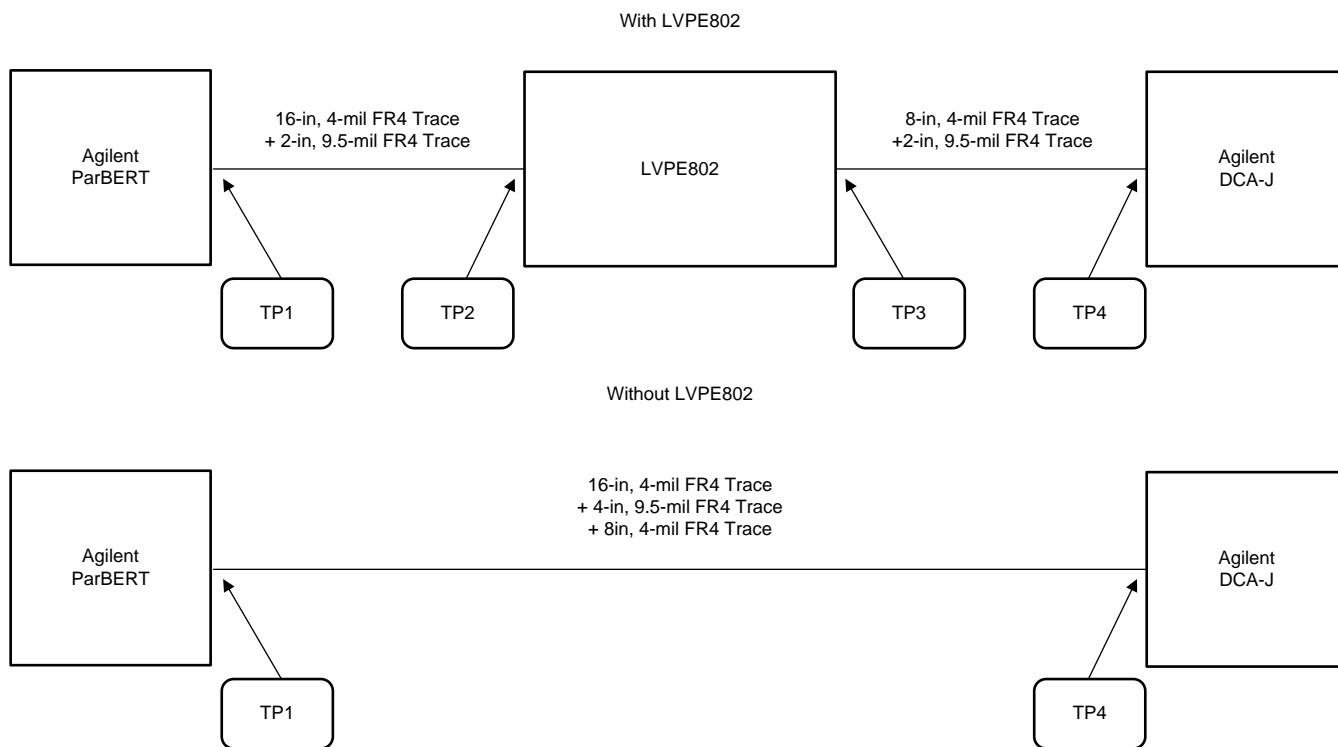

Copyright © 2016, Texas Instruments Incorporated

Figure 2. Performance Curve Measurement Setup

Typical Characteristics (continued)

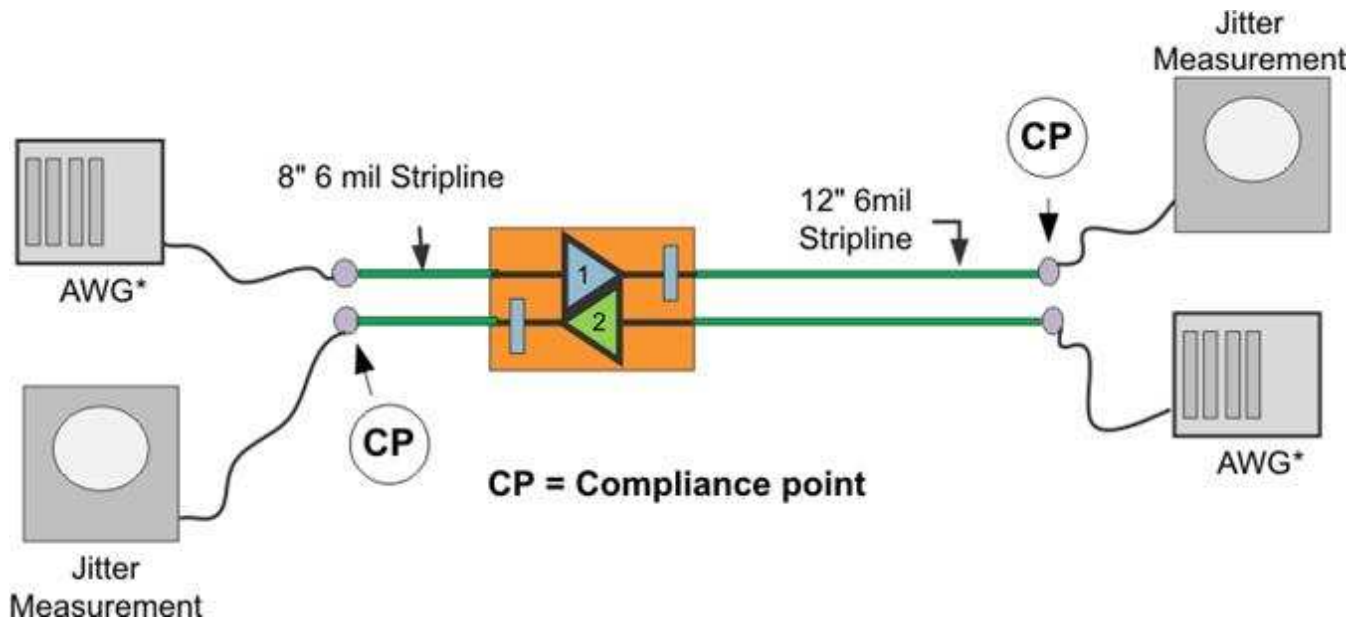
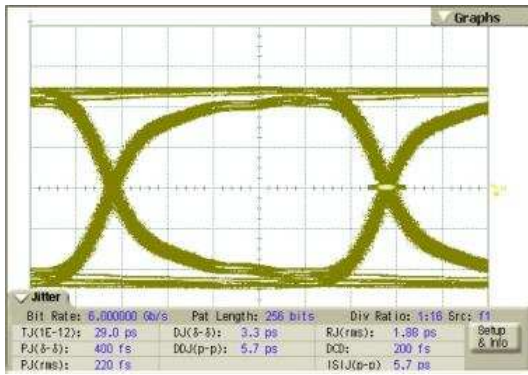

Figure 3. Jitter Measurement Test Condition

7.8.1 Jitter and VOD results: Case 1 at 6 Gbps



TJ	DJ	RJ	Eye	Eye	Eye
(1e-12) ps	(σ-σ) ps	(rms) ps	Amplitude mV	Width ps	Opening (mV)
29	3.3	1.88	412.4	159.2	350.52

Figure 4. Test Point 1

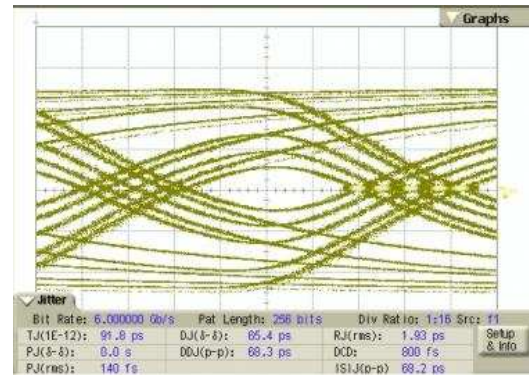

TJ	DJ	RJ	Eye	Eye	Eye
(1e-12) ps	(σ-σ) ps	(rms) ps	Amplitude mV	Width ps	Opening (mV)
91.8	65.4	1.93	240	28.9	81.24

Figure 5. Test Point 2

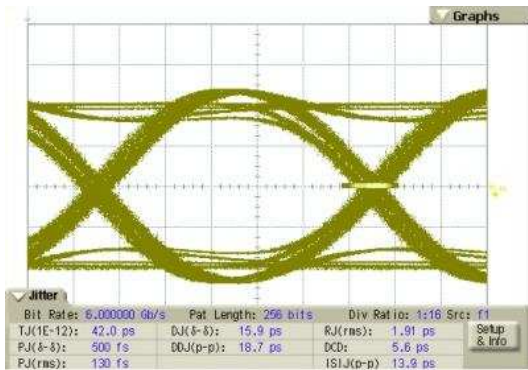

TJ	DJ	RJ	Eye	Eye	Eye
(1e-12) ps	(σ-σ) ps	(rms) ps	Amplitude mV	Width ps	Opening (mV)
42	15.9	1.91	788.8	141.3	623.02

Figure 6. Test Point 3

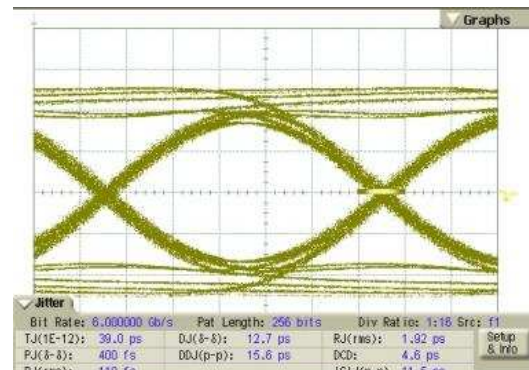

TJ	DJ	RJ	Eye	Eye	Eye
(1e-12) ps	(σ-σ) ps	(rms) ps	Amplitude mV	Width ps	Opening (mV)
39	12.7	1.92	557.1	149.7	459.62

Figure 7. Test Point 4 With LVPE802

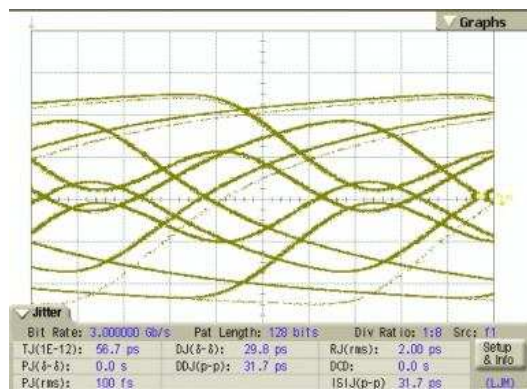

TJ	DJ	RJ	Eye	Eye	Eye
(1e-12) ps	(σ-σ) ps	(rms) ps	Amplitude mV	Width ps	Opening (mV)
56.7	29.8	2	165.4	101	13.24

Figure 8. Test Point 4 Without LVPE802

7.8.2 Jitter and VOD Results: Case 2 at 3 Gbps

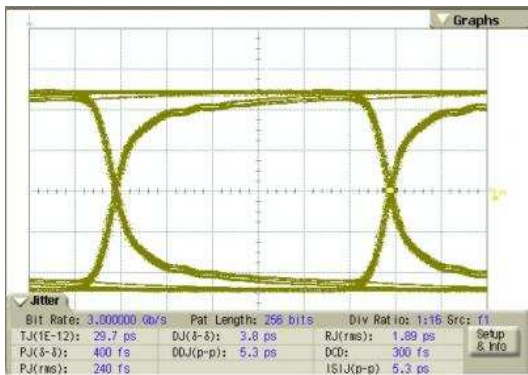

TJ	DJ	RJ	Eye	Eye	Eye
(1e-12) ps	(σ-σ) ps	(rms) ps	Amplitude mV	Width ps	Opening (mV)
29.7	3.8	1.89	430.9	326	392.84

Figure 9. Test Point 1

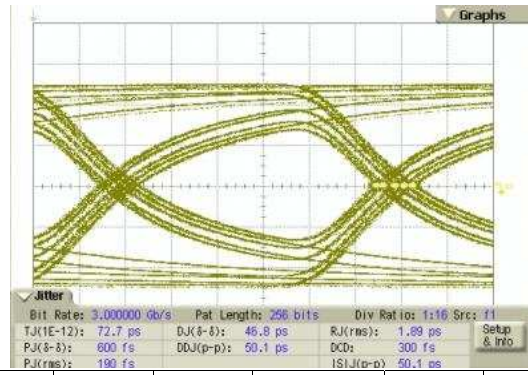

TJ	DJ	RJ	Eye	Eye	Eye
(1e-12) ps	(σ-σ) ps	(rms) ps	Amplitude mV	Width ps	Opening (mV)
72.7	46.8	1.89	314.9	237	222.36

Figure 10. Test Point 2

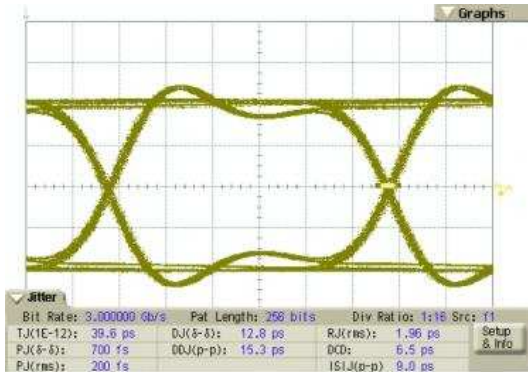

TJ	DJ	RJ	Eye	Eye	Eye
(1e-12) ps	(σ-σ) ps	(rms) ps	Amplitude mV	Width ps	Opening (mV)
39.6	12.8	1.96	714.5	321	611.62

Figure 11. Test Point 3

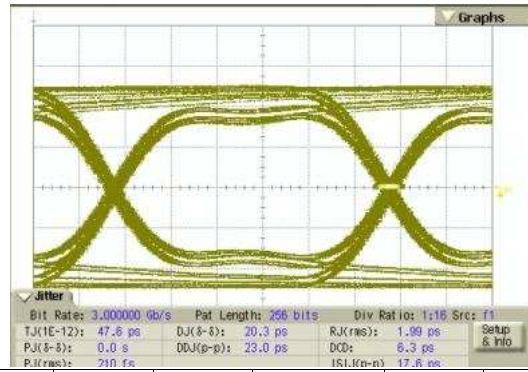

TJ	DJ	RJ	Eye	Eye	Eye
(1e-12) ps	(σ-σ) ps	(rms) ps	Amplitude mV	Width ps	Opening (mV)
47.9	20.3	1.99	615.3	305.0	463.42

Figure 12. Test Point 4 With LVPE802

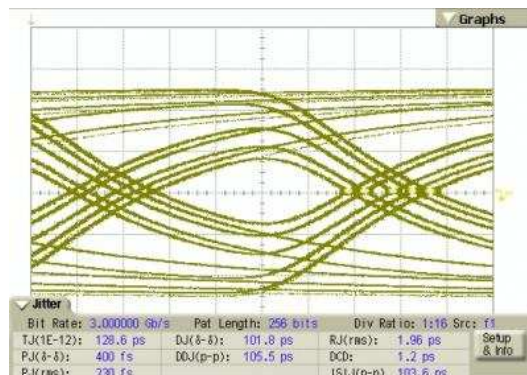

TJ	DJ	RJ	Eye	Eye	Eye
(1e-12) ps	(σ-σ) ps	(rms) ps	Amplitude mV	Width ps	Opening (mV)
128.6	101.8	1.96	258.8	118	122.26

Figure 13. Test Point 4 Without LVPE802

7.8.3 Jitter and VOD Results: Case 3 at 1.5 Gbps

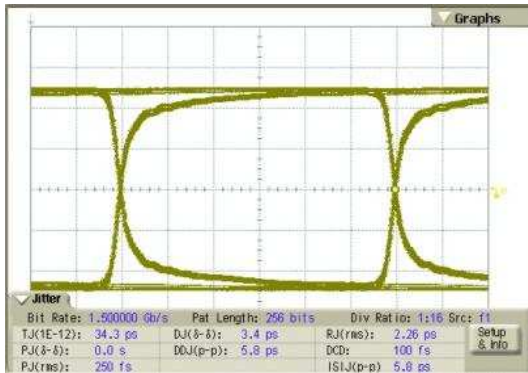

TJ	DJ	RJ	Eye	Eye	Eye
(1e-12) ps	(σ - σ) ps	(rms) ps	Amplitude mV	Width ps	Opening (mV)
34.3	3.4	2.26	448	659	417.28

Figure 14. Test Point 1

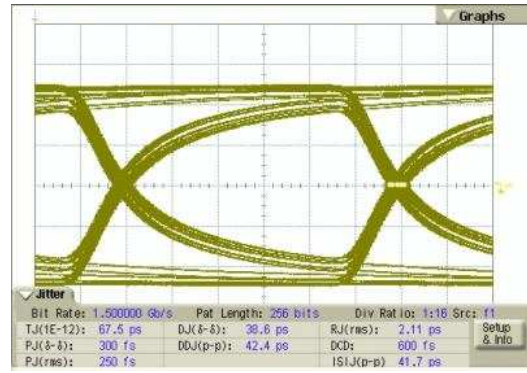

TJ	DJ	RJ	Eye	Eye	Eye
(1e-12) ps	(σ - σ) ps	(rms) ps	Amplitude mV	Width ps	Opening (mV)
67.5	38.6	2.11	363.4	595	318.48

Figure 15. Test Point 2

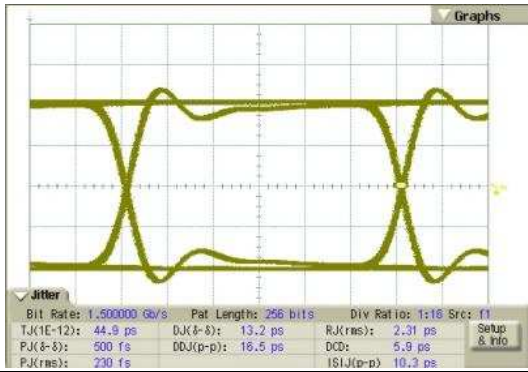

TJ	DJ	RJ	Eye	Eye	Eye
(1e-12) ps	(σ - σ) ps	(rms) ps	Amplitude mV	Width ps	Opening (mV)
44.9	13.2	2.31	753.1	649	604.02

Figure 16. Test Point 3

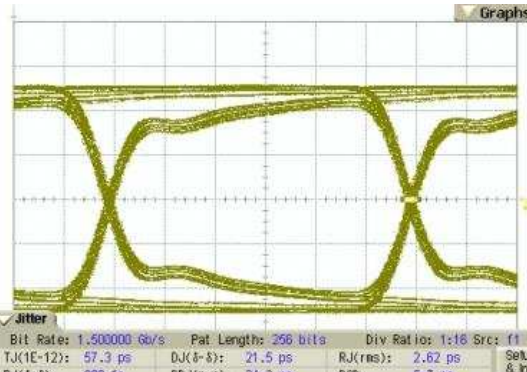

TJ	DJ	RJ	Eye	Eye	Eye
(1e-12) ps	(σ - σ) ps	(rms) ps	Amplitude mV	Width ps	Opening (mV)
57.3	21.5	2.62	672.8	632	442.42

Figure 17. Test Point 4 With LVPE802

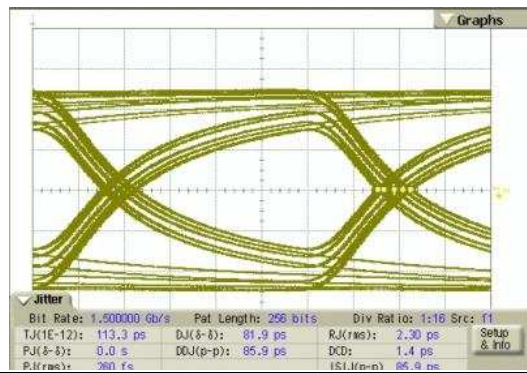

TJ	DJ	RJ	Eye	Eye	Eye
(1e-12) ps	(σ - σ) ps	(rms) ps	Amplitude mV	Width ps	Opening (mV)
113.3	81.9	2.3	322.8	493	217.48

Figure 18. Test Point 4 Without LVPE802

7.8.4 Jitter and VOD Results: Case 4 at 8 Gbps

Figure 21 Test Point 3 and Figure 22 Test Point 4 were taken without pre-emphasis.

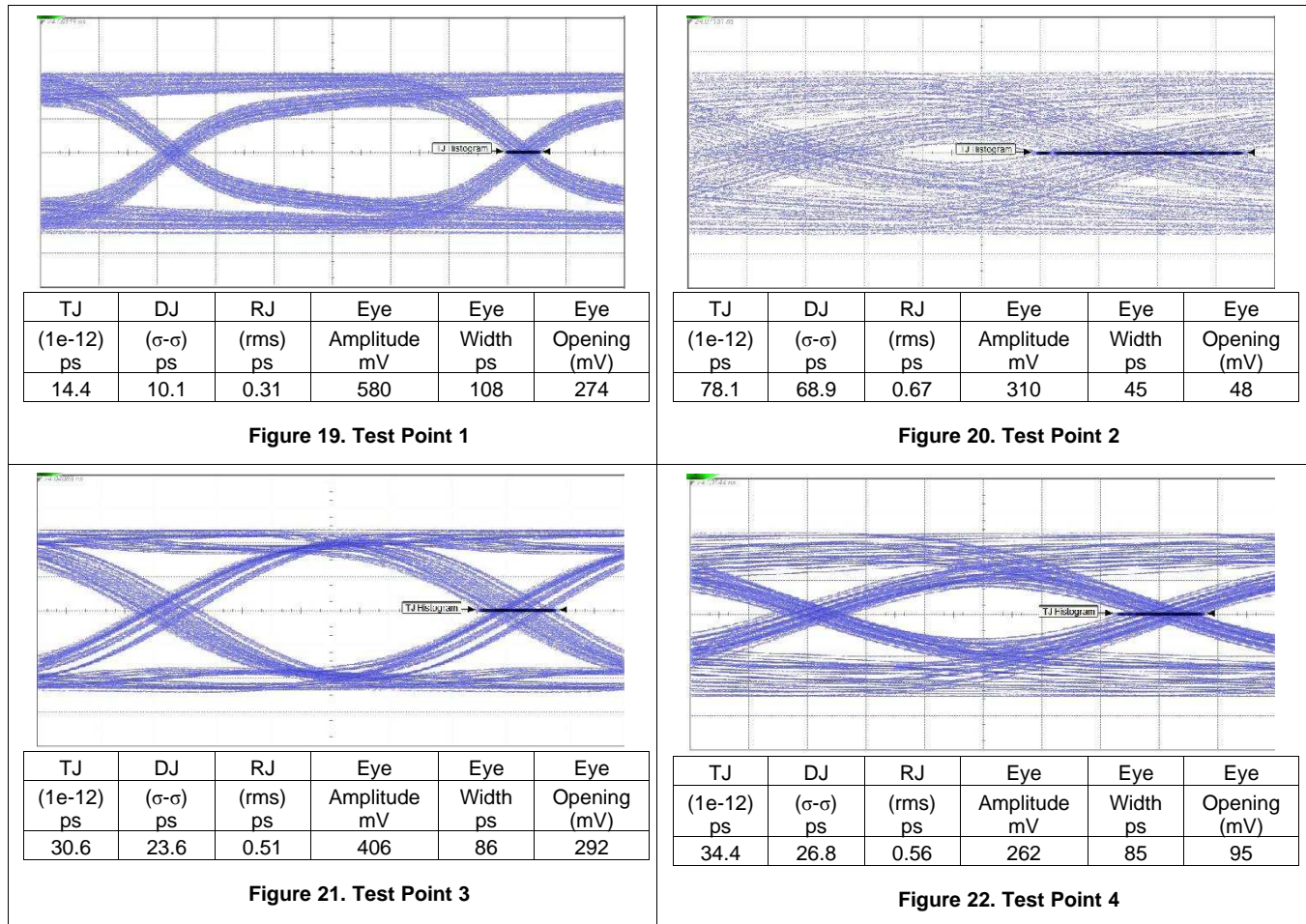

8 Detailed Description

8.1 Overview

The SN75LVPE802 is a dual channel equalizer and redriver. The device operates over a wide range of signaling rates, supporting operation from DC to 8 Gbps. The wide operating range supports SATA Gen 1, 2, 3 (1.5 Gbps, 3.0 Gbps, and 6.0 Gbps respectively) as well as PCI Express 1.0, 2.0, 3.0 (2.5 Gbps, 5.0 Gbps, and 8.0 Gbps). The device also supports SATA Express (SATA 3.2) which is a form factor specification that allows for SATA and PCI Express signaling over a single connector.

8.2 Functional Block Diagram

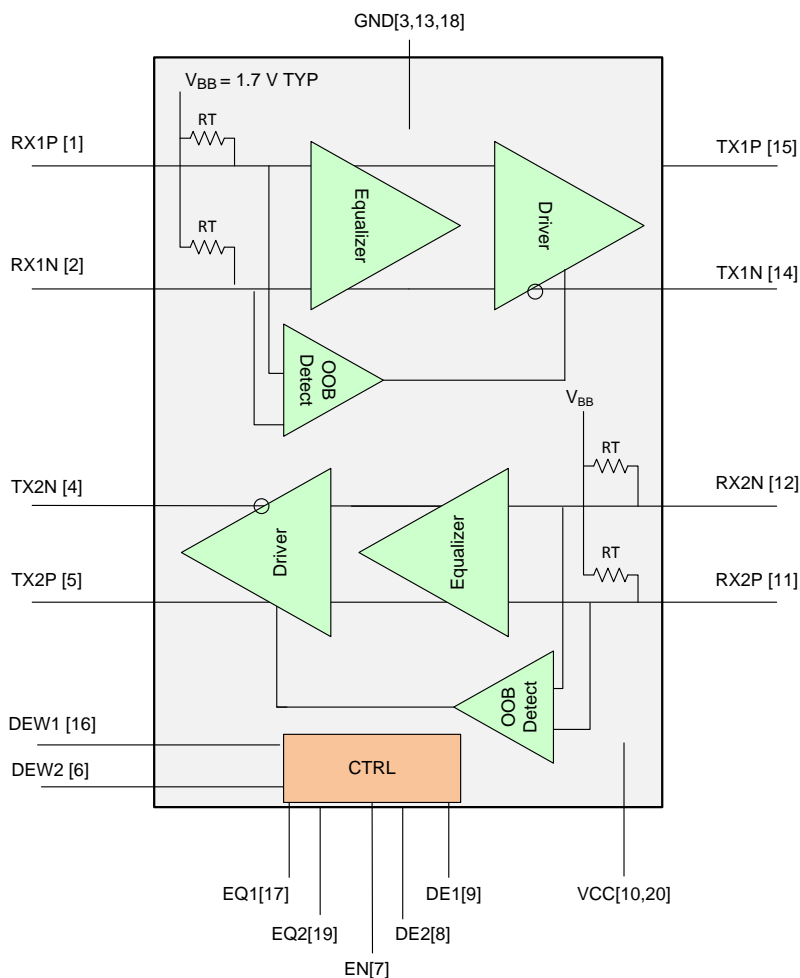

Copyright © 2016, Texas Instruments Incorporated

8.3 Feature Description

8.3.1 SATA Express

SATA Express (sometimes SATAe) is an electro-mechanical standard that supports both SATA and PCI Express storage devices. SATAe is standardized in the SATA 3.2 standard. The standard is concerned with providing a smooth transition from SATA to PCIe storage devices. The standard provides for standardized cables and connectors, and muxes the PCIe and SATA lanes at the host side so that either SATA compliant or PCIe compliant devices may operate with a host.

SATAe provides support for SATA1, SATA2 and SATA3 devices (operating from 1.5 Gbps to 6.0 Gbps), as well as PCIe1, PCIe2 and PCIe3 devices (operating from 2.5 Gbps to 8.0 Gbps).

Feature Description (continued)

The SN75LVPE802 provides for equalization and re-drive of a single channel input signal complying with any of the SATA or PCIe standards available with SATAe.

The SATAe standard provides for a mechanism for a host to recognize and detect whether a SATA or PCIe device is plugged into the host. See the [Typical SATA Application](#) section for the details of the SATA Express Interface Detect operation.

8.3.2 Receiver Termination

The receiver has integrated terminations to an internal bias voltage. The receiver differential input impedance is nominally 100 Ω , with a $\pm 15\%$ variation.

8.3.3 Receiver Internal Bias

The SN75LVPE802 receiver is internally biased to 1.7 V, providing support for AC coupled inputs.

8.3.4 Input Equalization

The SN75LVPE802 incorporates programmable equalization. The EQ input controls the level of equalization that is used to open the eye of the received input signal. If the EQ input is left open, or pulled LO, 6 dB (at 3 GHz) of equalization is applied. When the EQ input is HIGH, the equalization is set to 13 dB (again at 3 GHz). [Table 1](#) shows the equalization values discussed.

Table 1. EQ and DE Settings

EQ1 OR EQ2	CH1 OR CH2 EQUALIZATION dB (at 6 Gbps)	CH1 OR CH2 EQUALIZATION dB (at 8 Gbps)	DE1 OR DE2	CH1 OR CH2 DE-EMPHASIS dB (at 6 Gbps)
NC (default)	0	0	NC (default)	-4
0	6	7	0	0
1	13	15	1	-2

8.3.5 OOB/Squelch

The SN75LVPE802 receiver incorporates an Out-Of-Band (OOB) detection circuit in addition to the main signal chain receiver. The OOB detector continuously monitors the differential input signal to the device. The OOB detector has a 50-mVpp entry threshold. If the differential signal at the receiver input is less than the OOB entry threshold, the device transmitter transitions to squelch. The SN75LVPE802 enters squelch within 5 ns of the input signal falling below the OOB entry threshold. The SN75LVPE802 continues to monitor the input signal while in squelch. While in squelch, if the OOB detector determines that the input signal now exceeds the 90 mVpp exit threshold, the SN75LVPE802 exits squelch within 5 ns.

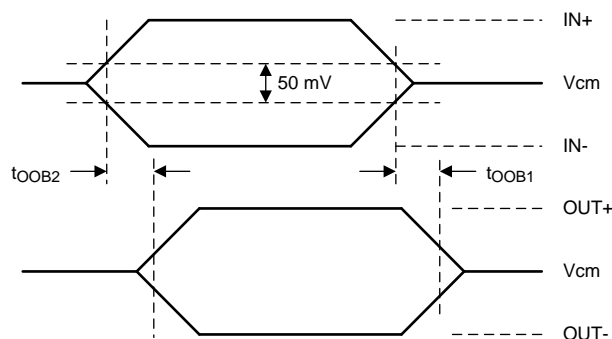

Figure 23. OOB Enter and Exit Timing Receiver Input Termination Is Disabled

When the SN75LVPE802 enters squelch state the transmitter output is squelched. The transmitter non-inverting (TX+) output and the transmitter inverting output (TX-) are both driven to the transmitter nominal common mode voltage which is 1.7 V.

8.3.6 Auto Low Power

The SN75LVPE801 also includes an Auto Low Power Mode (ALP). ALP is entered when the differential input signal has been less than 50 mV for > 10 μs. The device enters and exits Low Power Mode by actively monitoring the input signal level. In this state the device selectively shuts off internal circuitry to lower power by > 90% of its normal operating power. While in ALP mode the device continues to actively monitor input signal levels. When the input signal exceeds the OOB exit threshold level, the device reverts to the active state. Exit time from Auto Low Power Mode is < 50 ns (max).

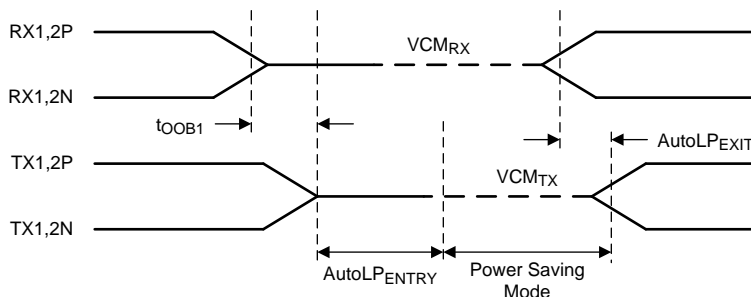

Figure 24. Auto Low Power Mode Entry and Exit Timing

8.3.7 Transmitter Output Signal

The SN75LVPE802 differential output signal is 650 mVpp when de-emphasis is disabled (DE input is open or pulled low).

8.3.8 Transmitter Common Mode

The SN75LVPE802 transmitter common mode output is set to 1.7 V.

8.3.9 De-Emphasis

The SN75LVPE802 device provides the de-emphasis settings shown in Table 2. De-emphasis control is independent for each channel, controlled by the DE1 and DE2 pin settings as shown in Table 2. The reference for the de-emphasis settings available in the device is the transition bit amplitude for each given configuration; this transition bit amplitude is different at 0 dB than the -2-dB and -4-dB settings by design. DEW1 and DEW2 control the DE durations for channels one and two, respectively. Table 2 lists the recommended settings for these control pins. Output de-emphasis is capable of supporting FR4 trace at the output anywhere from 2 in. (5.1 cm) to 12 in. (30.5 cm) at SATA 3G/6G speed.

Table 2. TX and Rx EQ and DE Pulse-Duration Settings

DEW1 OR DEW2	DEVICE FUNCTION → DE WIDTH FOR CH1/CH2
0	De-emphasis pulse duration, short
1 (default)	De-emphasis pulse duration, long

8.3.10 Transmitter Termination

The SN75LVPE802 transmitter includes integrated terminations. The receiver differential output impedance is nominally 100 Ω, with a ≤ 22% variation.

8.4 Device Functional Modes

8.4.1 Low-Power Mode

There are two low-power modes supported by the SN75LVPE802 device, listed as follows:

1. Standby mode (triggered by the EN pin, EN = 0 V)
 - The enable (EN) pin controls the low-power mode. Pulling this pin LOW puts the device in standby mode within 2 μ s (max). In this mode, the device drives all its active components to their quiescent level, and differential outputs Hi-Z (open). Maximum power dissipation in this mode is 5 mW. Exiting from this mode to normal operation requires a maximum latency of 5 μ s.
2. Auto low-power mode (triggered when a given channel is in the electrically idle state for more than 100 μ s and EN = VCC)
 - The device enters and exits low-power mode by actively monitoring the input signal (V_{IDp-p}) level on each of its channels independently. When the input signal on either or both channels is in the electrically idle state, that is, $V_{IDp-p} < 50$ mV and stays in this state for > 100 μ s, the associated channel enters into the low-power state. In this state, output of the associated channel goes to VCM and the device selectively shuts off some circuitry to lower power by $> 80\%$ of its normal operating power. Exit time from the auto low-power mode is < 50 ns.

9 Application and Implementation

NOTE

Information in the following applications sections is not part of the TI component specification, and TI does not warrant its accuracy or completeness. TI's customers are responsible for determining suitability of components for their purposes. Customers should validate and test their design implementation to confirm system functionality.

9.1 Application Information

The SN75LVPE802 can be used for SATA applications as well as SATA Express applications. The device supports SATA Gen1, Gen2, and Gen3 applications with data rates from 1.5 to 6 Gbps. The built-in equalization circuits provide up to 13 dB of equalization at 3 GHz. This equalization can support SATA GEN2 (3 Gbps) applications over up to 50 inches of FR-4 material. The same 13 dB equalizer is suited to SATA Gen3 (6 Gbps) applications up to 40 inches of FR4.

In addition to SATA applications, the SN75LVPE802 can support SATA Express applications. SATA Express provides a standardized interface to support both SATA (Gen1, Gen2, and Gen3) and PCI Express (PCIe 1, 2 and 3).

All applications of the SN75LVPE802 share some common applications issues. For example, power supply filtering, board layout, and equalization performance with varying interconnect losses. Other applications issues are specific, such as implementing receiver detection for SATA Express applications. The Typical Application examples demonstrate common implementations of the SN75LVPE802 supporting SATA, as well as SATA Express applications.

9.2 Typical SATA Application

This typical application describes how to configure the EQ, DE, and DEW configuration pins of the SN75LVPE802 device based on board trace length between the SATA Host and the SN75LVPE802 and the SN75LVPE802 and SATA Device. Actual configuration settings may differ due to additional factors such as board layout, trace widths, and connectors used in the signal path.

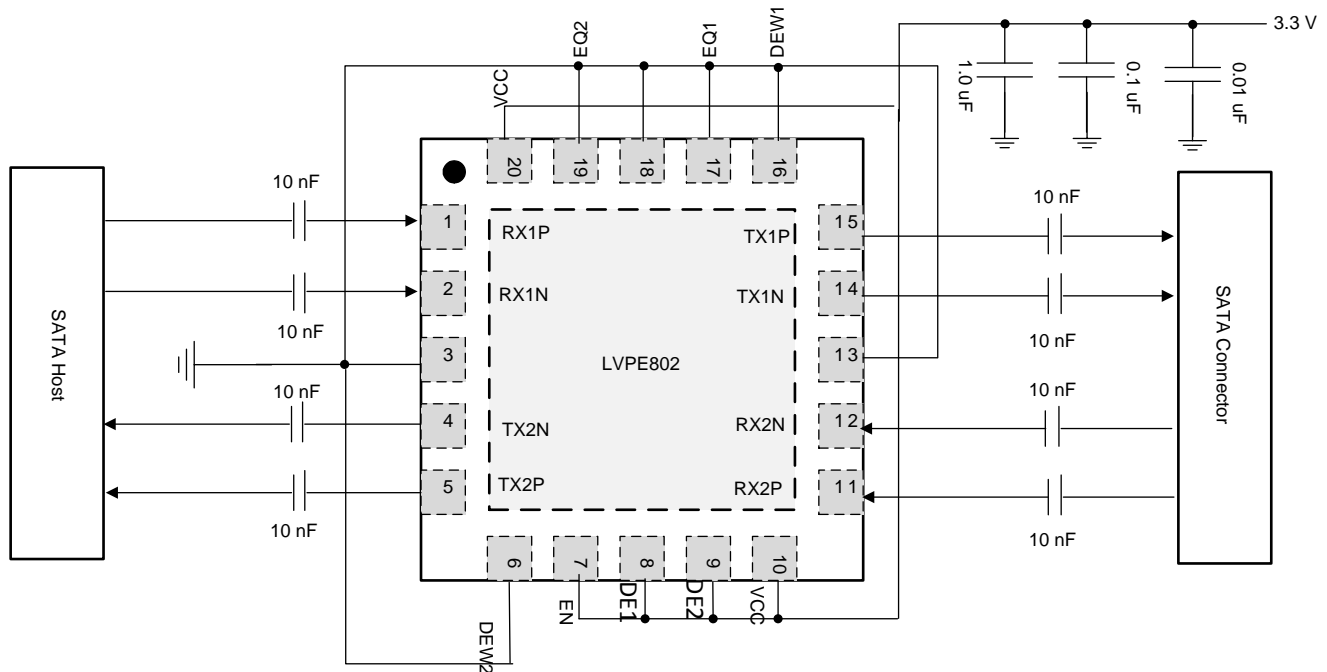
Typical SATA Application (continued)

Copyright © 2016, Texas Instruments Incorporated

- (1) Place supply caps close to device pin
- (2) EN can be left open or tied to supply when no external control is implemented
- (3) Output de-emphasis selection is set at -3 dB, EQ at 7 dB and DE width for SATA I/II/III operation for both channels.
- (4) Actual EQ/DE/DE width settings will depend on device placement relative to host and SATA connector.

Figure 25. Typical Device Implementation
9.2.1 Design Requirements

Typically, system trace length from the SATA host to the SN75LVPE802 device and trace length from the SN75LVPE802 device to a SATA device differ and require different equalization and de-emphasis settings for the host side and device side.

For example:

- A system with a 6-inch trace from the SN75LVPE802 device to a SATA host may set EQ1 (Rx1±) to 7 dB, and DE2 (Tx2±) to -2 dB and DEW2 (Tx2±) to long pulse duration.
- The same system with a 1-inch trace from the SN75LVPE802 device to a SATA HDD may set EQ2 (Rx2±) to 0 dB, and DE1 (Tx1±) to 0 dB and DEW1 (Tx1±) to short pulse duration.

Refer to [Application Curves](#) for recommended EQ, DE and DEW settings based on trace length. It is highly recommended to add both pullup- and pulldown-resistor options in the layout to fine-tune the settings if needed. Input Signal Characteristics:

- Data Rate: 6 Gbps
- Pattern: PRBS7
- No pre-emphasis
- Signal amplitude: 500 mVpp
- 18-inch SMA cable from test equipment to input and output trace

Typical SATA Application (continued)

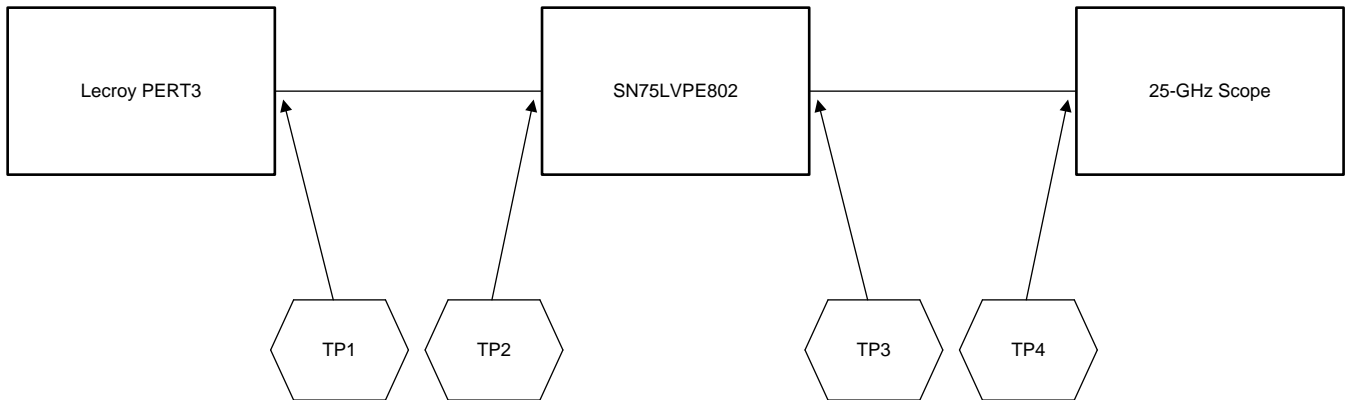

Figure 26. Measurement Set-up

9.2.2 Detailed Design Procedure

9.2.2.1 Equalization Configuration

Each differential input of the SN75LVPE802 device has programmable equalization in the front stage. The equalization setting is shown in [Table 1](#). The input equalizer is designed to recover a signal even when no eye is present at the receiver and effectively supports FR4 trace input from 3 inches to greater than 24 inches at SATA 6 Gbps speed.

9.2.3 De-emphasis Configuration

The SN75LVPE802 device provides the de-emphasis settings shown in [Table 1](#) and [Table 2](#). TX and Rx EQ and DE Pulse-Duration Settings. De-emphasis is controlled independently for each channel and is set by the DE1, DE2, DEW1 and DEW2 pins of the SN75LVPE802 device.

Typical SATA Application (continued)

9.2.4 Application Curves

Typical application curves correspond to SATA application at 6 Gbps.

9.2.4.1 SN75LVPE802 Equalization Settings for Various Input Trace Length

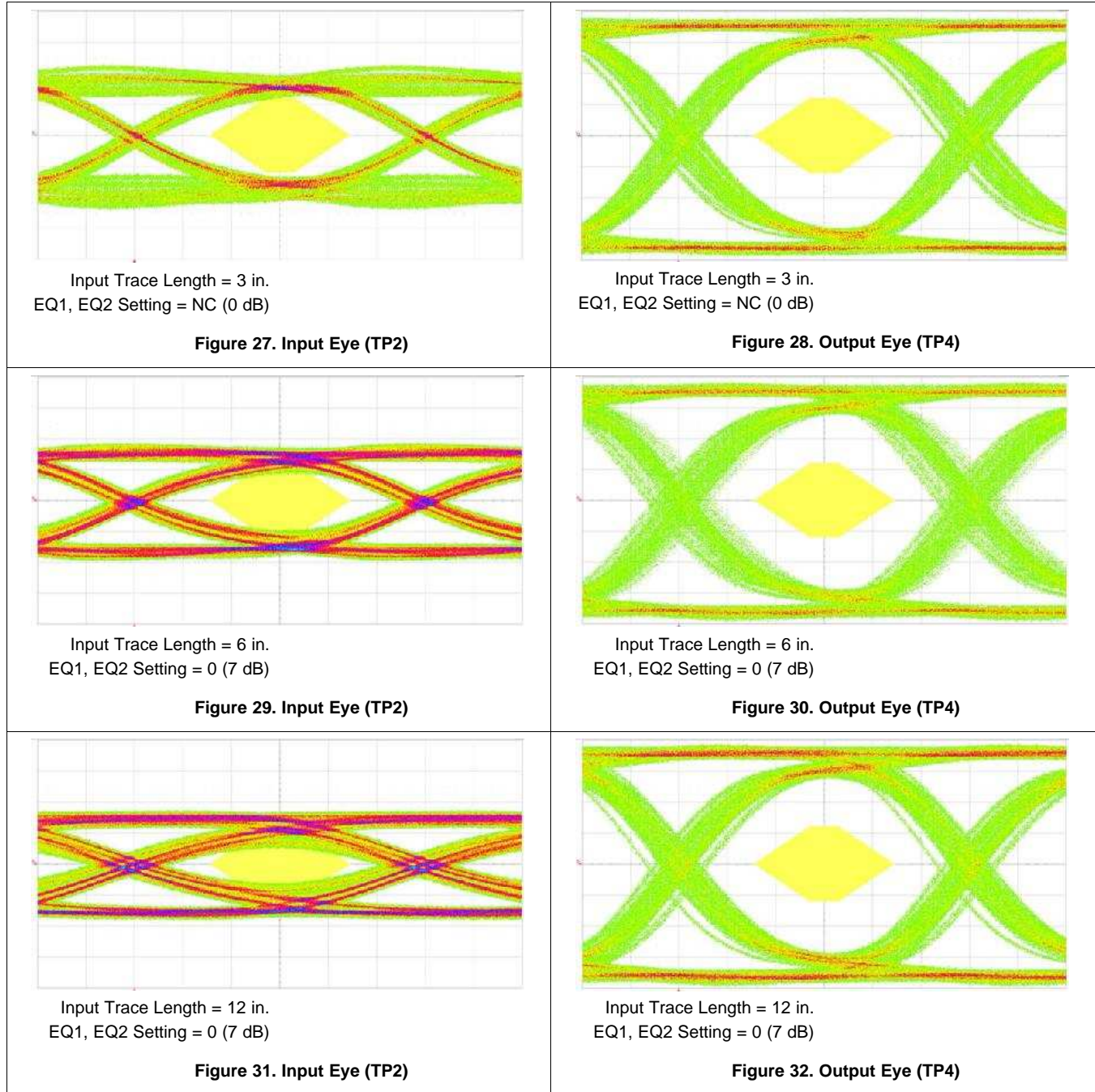

Typical SATA Application (continued)

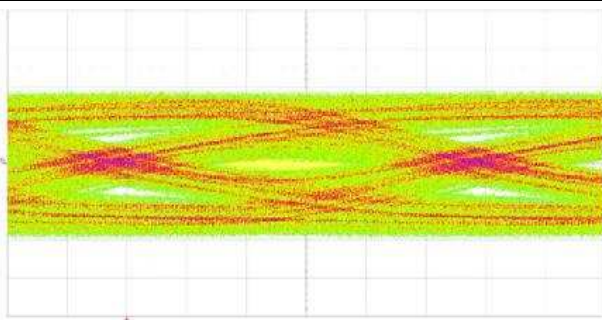

Input Trace Length = 24 in.
EQ1, EQ2 Setting = 0 (7 dB)

Figure 33. Input Eye (TP2)

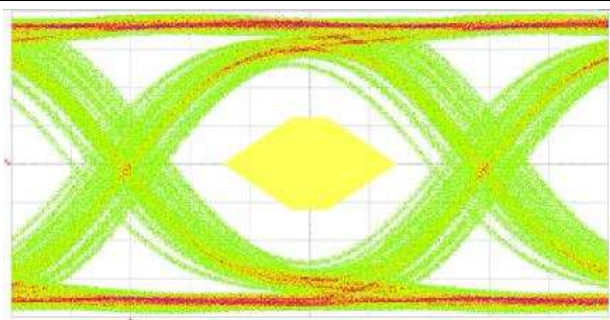

Input Trace Length = 24 in.
EQ1, EQ2 Setting = 0 (7 dB)

Figure 34. Output Eye (TP4)

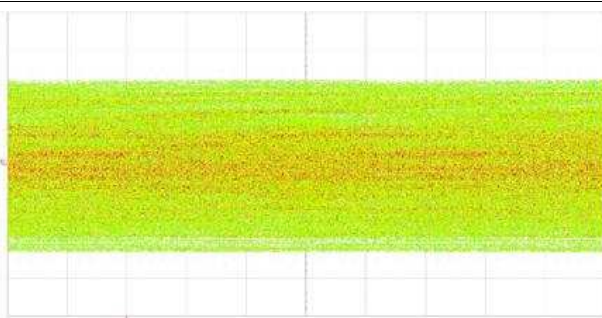

Input Trace Length = 36 in.
EQ1, EQ2 Setting = 1 (14 dB)

Figure 35. Input Eye (TP2)

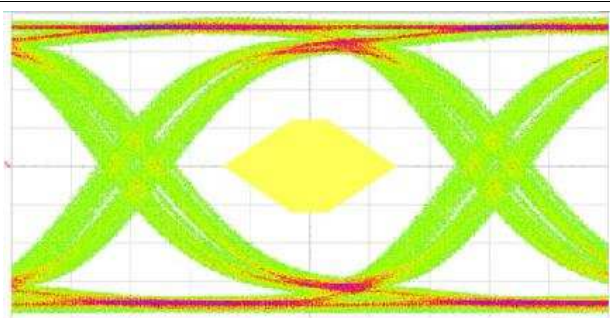

Input Trace Length = 36 in.
EQ1, EQ2 Setting = 1 (14 dB)

Figure 36. Output Eye (TP4)

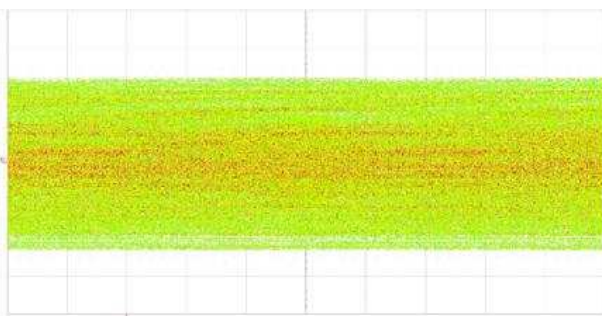

Input Trace Length = 48 in.
EQ1, EQ2 Setting = 1 (14 dB)

Figure 37. Input Eye (TP2)

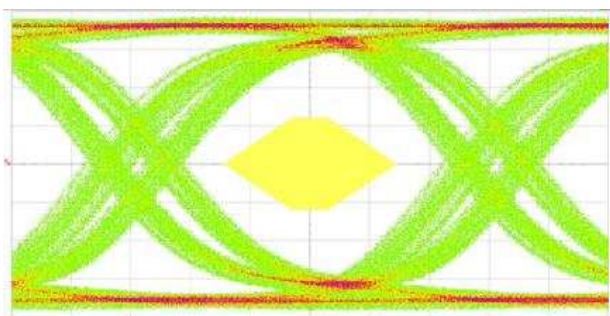

Input Trace Length = 48 in.
EQ1, EQ2 Setting = 1 (14 dB)

Figure 38. Output Eye (TP4)

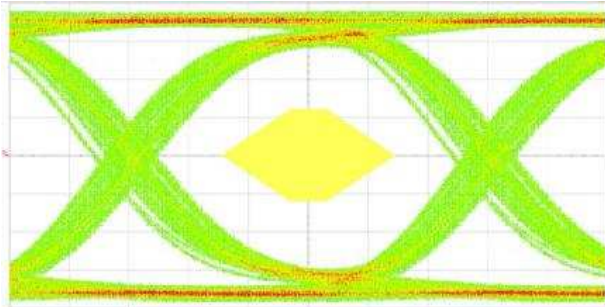
Typical SATA Application (continued)
9.2.4.2 SN75LVCP802 De-emphasis Settings For various Output Trace Lengths

Output Trace Length = 0 in. DE, DE2 Setting = 0 (0 dB)
DEW1, DEW2 Setting = 0 (Short pulse duration)

Figure 39. Output Eye (TP4)

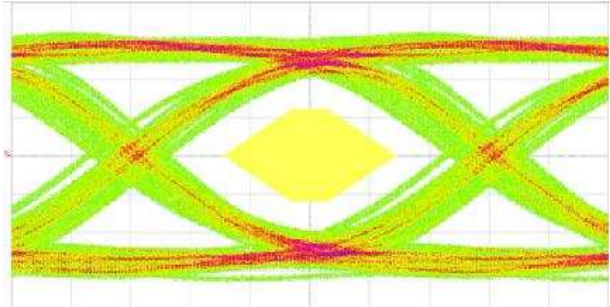

Output Trace Length = 3 in. DE, DE2 Setting = 0 (0 dB)
DEW1, DEW2 Setting = 0 (Short pulse duration)

Figure 40. Output Eye (TP4)

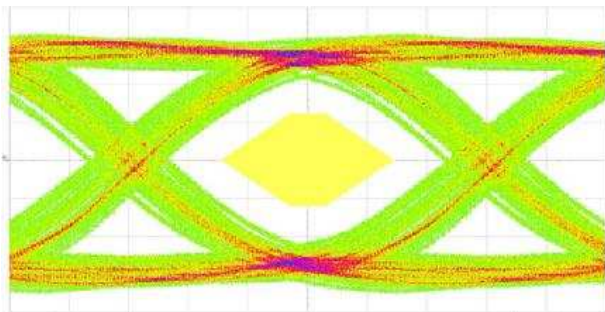

Output Trace Length = 6 in. DE, DE2 Setting = 1 (-2 dB)
DEW1, DEW2 Setting = 1 (Long pulse duration)

Figure 41. Output Eye (TP4)

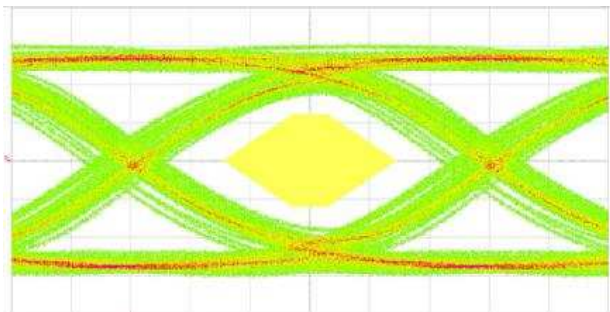

Output Trace Length = 12 in. DE, DE2 Setting = 1 (-2 dB)
DEW1, DEW2 Setting = 1 (Long pulse duration)

Figure 42. Output Eye (TP4)

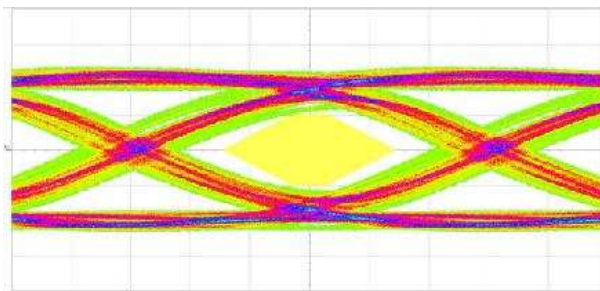

Output Trace Length = 12 in. DE, DE2 Setting = NC (-4 dB)
DEW1, DEW2 Setting = 1 (Long pulse duration)

Figure 43. Output Eye (TP4)

9.3 SATA Express Applications

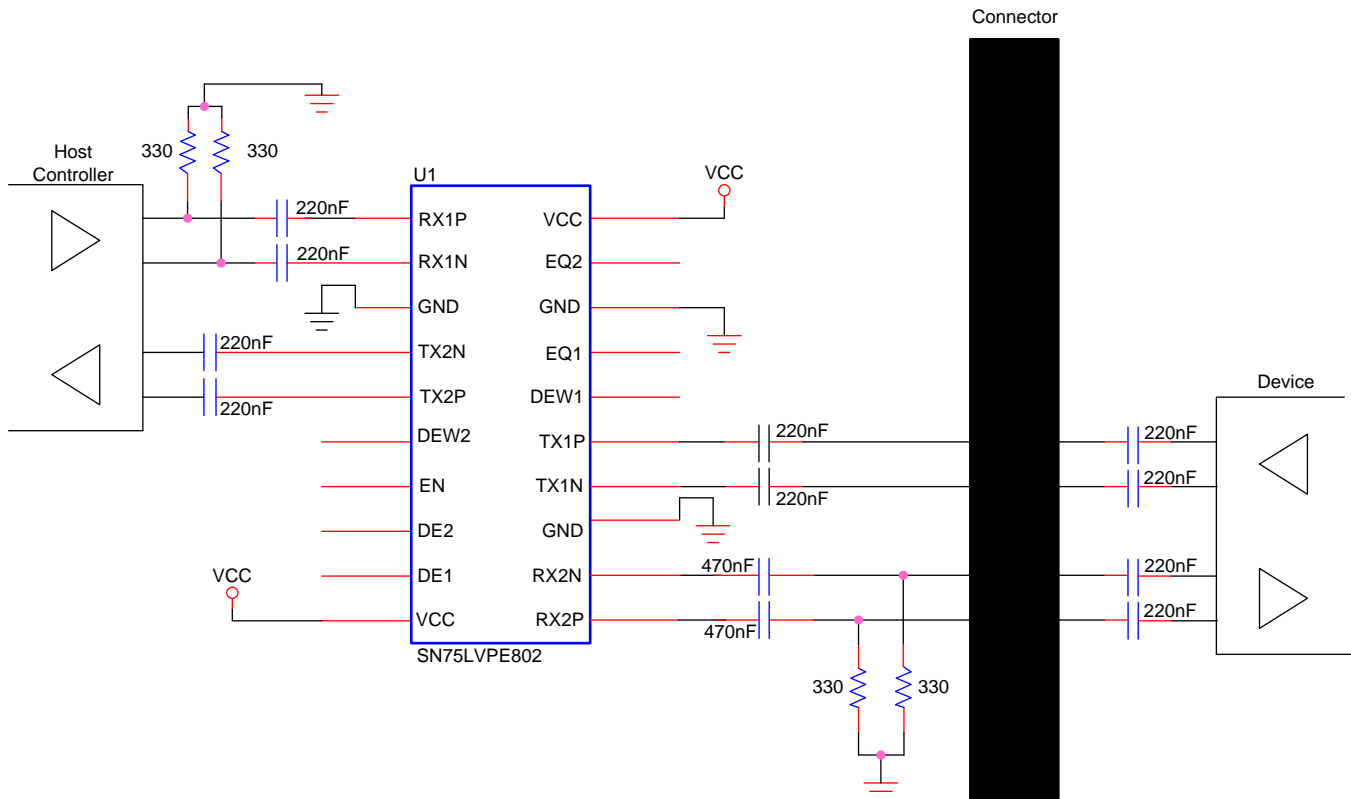

Copyright © 2017, Texas Instruments Incorporated

Figure 44. SATAe Reference Schematic

9.3.1 Detailed Design Procedure

Figure 44 is a reference schematic of a SATAe implementation using the SN75LVPE802. With a SATAe design, both SATA and PCI Express must be supported. SATAe supports both cabled and direct connections. Using a cabled application as an example, the SATAe power connector includes an Interface Detect (IFDet, power connector pin P4) signal that indicates whether a SATA client or a PCIe client is connected.

When the SATAe host determines that a PCIe client is connected, the SATAe host performs receiver detection. Receiver detection determines the presence of a client by detecting the load impedance. The transmitter performs a common mode voltage shift, and measures the rate at which the voltage at the transmitter output changes. The rate of change indicates if a client is present (fast charging when a low impedance load is present, or slow charging when the load is open or high impedance). With the implementation in Figure 44, 330- Ω pulldowns have been inserted between the host and the SN75LVPE802. The pulldown resistors indicate to the host that a client is present. While an actual client would be expected to have an active load of 50 Ω single ended, the 330 Ω is chosen here to meet two requirements. The 330 Ω is low enough to force the SATAe host to decide that a receiver is present, while also high enough to only marginally affect the load when the SN75LVPE802 is active, and presenting a 50- Ω load. With the 50 Ω and 330 Ω are both present, the parallel combination of 43 Ω is satisfactory for most applications.

Assuming that the SATAe host has detected (via IFDet) that a SATA client is present, the SATAe host communicates with the client via the SN75LVPE802. The SATA standard does not have a receiver detection mode as is present in PCIe. A SATA host does use OOB signaling to communicate identification information. The SN75LVPE802 incorporates an OOB detector in order to support OOB signaling through the device. The OOB detector drives a squelch circuit on the SN75LVPE802 output transmitter. (See [OOB/Squelch](#) for more details on the OOB/Squelch circuitry.)

SATA Express Applications (continued)

Returning to [Figure 44](#), there is a 200-nF AC coupling capacitors on the device or client side of the interface. These capacitors allow interfacing to both SATA and PCIe clients. In the case of a PCIe client, the 200 nF is within the acceptable range for all PCIe devices. When a SATA client is present, the 200 nF capacitor has little effect on the overall link, as it appears in series with the 12-nF (max) AC coupling capacitor incorporated into the SATA client. The 200 nF in series with the 12 nF presents an effective capacitance of 11.3 nF, as expected less than the 12-nF maximum permitted.

9.3.2 PCIe Applications

PCIe-only applications are implemented in a manner very similar to SATA Express applications as covered in [Detailed Design Procedure](#). Looking at [Figure 45](#) and comparing it to the SATA Express application in [Figure 8](#) 20 SATAe Reference Schematic, a single change is noted. For PCIe applications the 220 nF AC-coupling capacitors on the Host-to-Device link are relocated from the Device side of the connector to the Host side. No other changes are required.

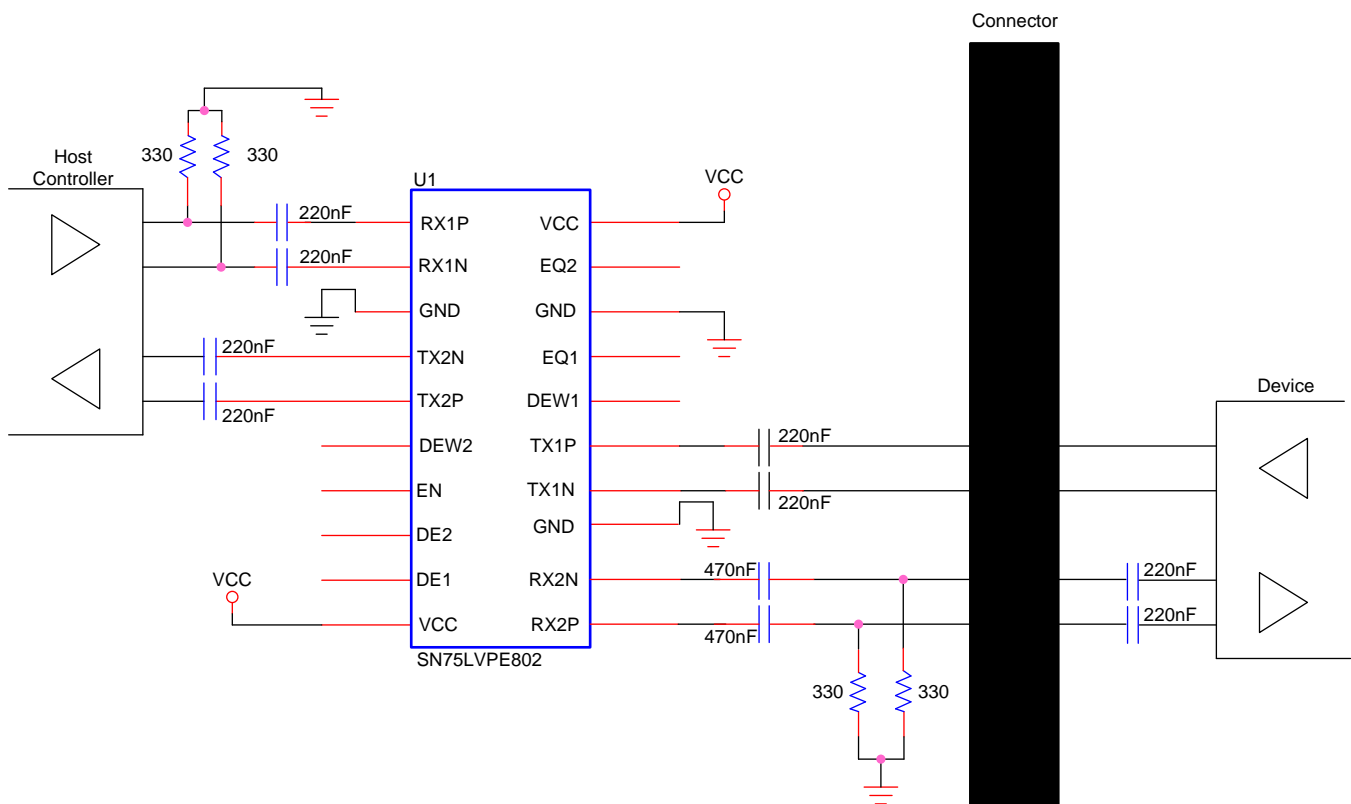

Copyright © 2017, Texas Instruments Incorporated

Figure 45. SN75LVPE802 PCIe Reference Schematic

10 Power Supply Recommendations

The design of SN75LVPE802 device is for operation from one 3.3-V supply. Always practice proper power supply sequencing procedure. Apply VCC first, before application of any input signals to the device. The power down sequence is in reverse order.

11 Layout

11.1 Layout Guidelines

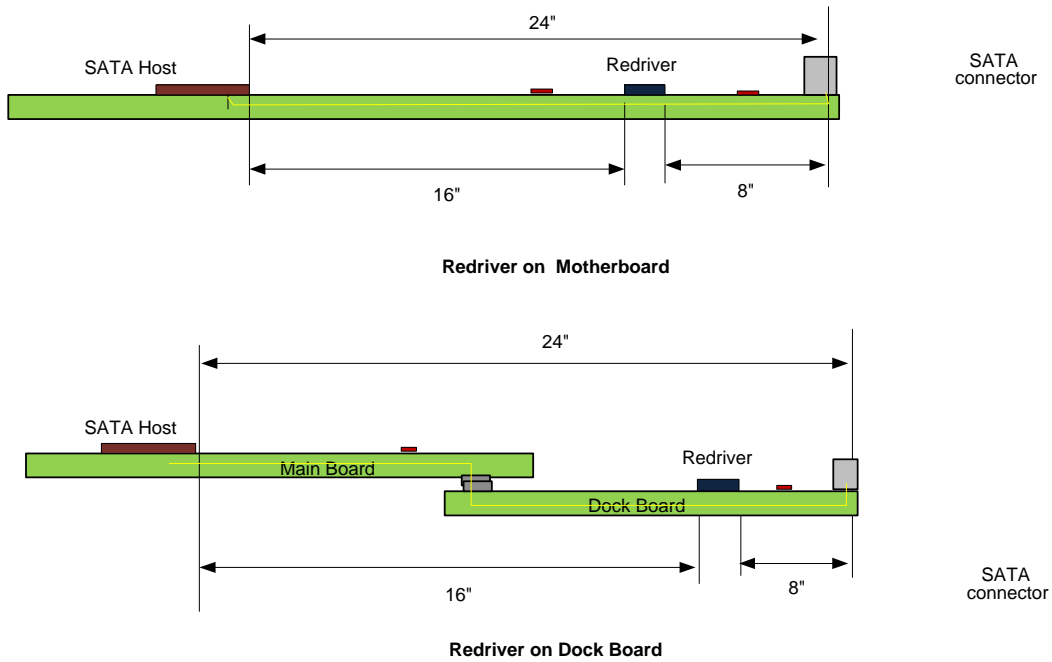

Copyright © 2016, Texas Instruments Incorporated

- (1) Trace lengths are suggested values based on TI spice simulations (done over programmable limits of input EQ and output de-emphasis) to meet SATA loss and jitter spec. Actual trace length supported by the LVPE802 may be more or less than suggested values and will depend on board layout, trace widths and number of connectors used in the SATA signal path.

Figure 46. Trace Length Example for LVPE802

11.2 Layout Example

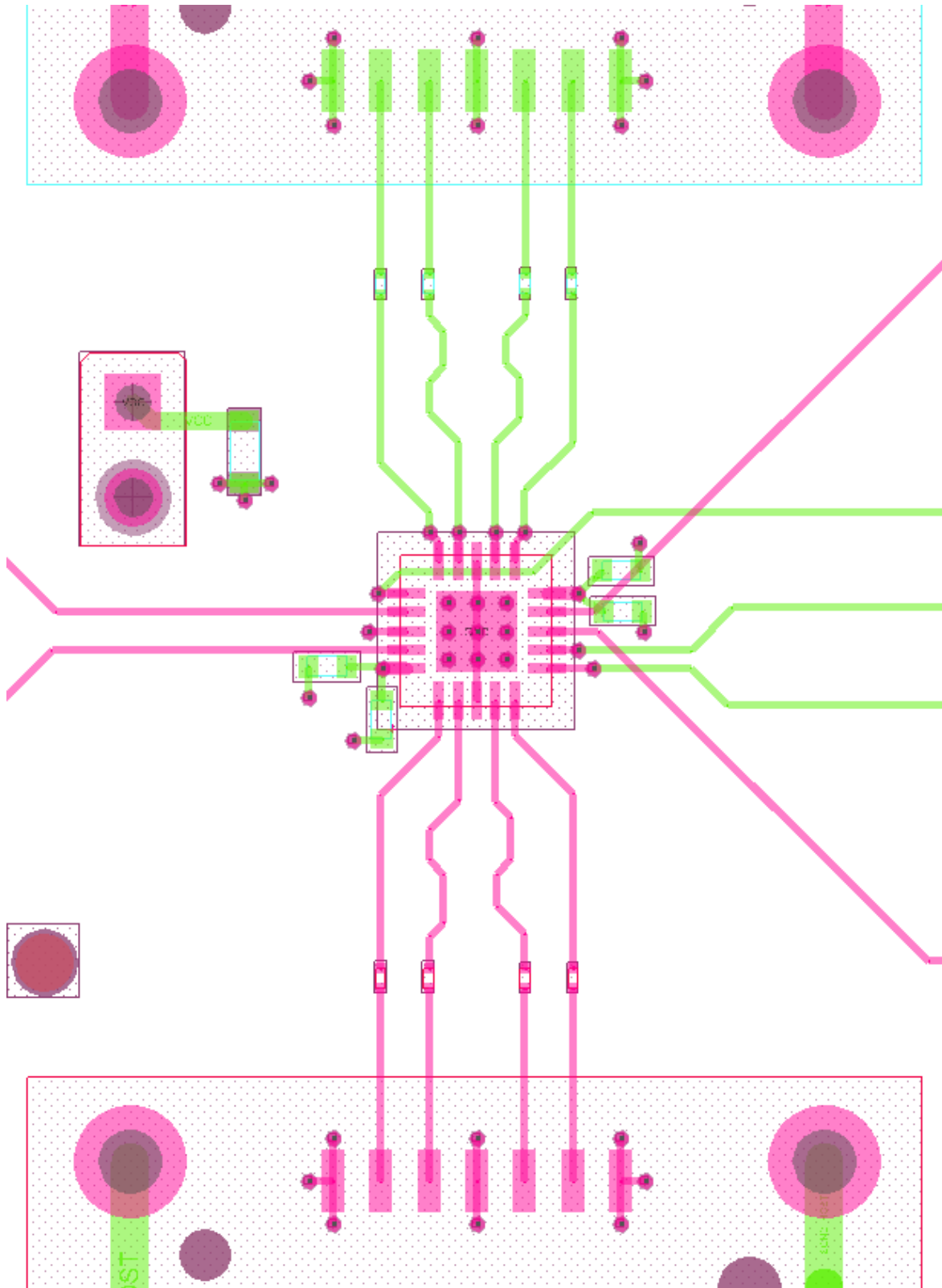

Figure 47. Example Layout

12 Device and Documentation Support

12.1 Receiving Notification of Documentation Updates

To receive notification of documentation updates, navigate to the device product folder on ti.com. In the upper right corner, click on *Alert me* to register and receive a weekly digest of any product information that has changed. For change details, review the revision history included in any revised document.

12.2 Community Resources

The following links connect to TI community resources. Linked contents are provided "AS IS" by the respective contributors. They do not constitute TI specifications and do not necessarily reflect TI's views; see TI's [Terms of Use](#).

TI E2E™ Online Community *TI's Engineer-to-Engineer (E2E) Community*. Created to foster collaboration among engineers. At e2e.ti.com, you can ask questions, share knowledge, explore ideas and help solve problems with fellow engineers.

Design Support *TI's Design Support* Quickly find helpful E2E forums along with design support tools and contact information for technical support.

12.3 Trademarks

E2E is a trademark of Texas Instruments.
All other trademarks are the property of their respective owners.

12.4 Electrostatic Discharge Caution



These devices have limited built-in ESD protection. The leads should be shorted together or the device placed in conductive foam during storage or handling to prevent electrostatic damage to the MOS gates.

12.5 Glossary

[SLYZ022](#) — *TI Glossary*.

This glossary lists and explains terms, acronyms, and definitions.

13 Mechanical, Packaging, and Orderable Information

The following pages include mechanical, packaging, and orderable information. This information is the most current data available for the designated devices. This data is subject to change without notice and revision of this document. For browser-based versions of this data sheet, refer to the left-hand navigation.

PACKAGING INFORMATION

Orderable part number	Status (1)	Material type (2)	Package Pins	Package qty Carrier	RoHS (3)	Lead finish/ Ball material (4)	MSL rating/ Peak reflow (5)	Op temp (°C)	Part marking (6)
SN75LVPE802RTJR	Active	Production	QFN (RTJ) 20	3000 LARGE T&R	Yes	NIPDAU	Level-2-260C-1 YEAR	0 to 85	LVP802
SN75LVPE802RTJR.B	Active	Production	QFN (RTJ) 20	3000 LARGE T&R	Yes	NIPDAU	Level-2-260C-1 YEAR	0 to 85	LVP802
SN75LVPE802RTJT	Active	Production	QFN (RTJ) 20	250 SMALL T&R	Yes	NIPDAU	Level-2-260C-1 YEAR	0 to 85	LVP802
SN75LVPE802RTJT.B	Active	Production	QFN (RTJ) 20	250 SMALL T&R	Yes	NIPDAU	Level-2-260C-1 YEAR	0 to 85	LVP802

(1) **Status:** For more details on status, see our [product life cycle](#).

(2) **Material type:** When designated, preproduction parts are prototypes/experimental devices, and are not yet approved or released for full production. Testing and final process, including without limitation quality assurance, reliability performance testing, and/or process qualification, may not yet be complete, and this item is subject to further changes or possible discontinuation. If available for ordering, purchases will be subject to an additional waiver at checkout, and are intended for early internal evaluation purposes only. These items are sold without warranties of any kind.

(3) **RoHS values:** Yes, No, RoHS Exempt. See the [TI RoHS Statement](#) for additional information and value definition.

(4) **Lead finish/Ball material:** Parts may have multiple material finish options. Finish options are separated by a vertical ruled line. Lead finish/Ball material values may wrap to two lines if the finish value exceeds the maximum column width.

(5) **MSL rating/Peak reflow:** The moisture sensitivity level ratings and peak solder (reflow) temperatures. In the event that a part has multiple moisture sensitivity ratings, only the lowest level per JEDEC standards is shown. Refer to the shipping label for the actual reflow temperature that will be used to mount the part to the printed circuit board.

(6) **Part marking:** There may be an additional marking, which relates to the logo, the lot trace code information, or the environmental category of the part.

Multiple part markings will be inside parentheses. Only one part marking contained in parentheses and separated by a "-" will appear on a part. If a line is indented then it is a continuation of the previous line and the two combined represent the entire part marking for that device.

Important Information and Disclaimer: The information provided on this page represents TI's knowledge and belief as of the date that it is provided. TI bases its knowledge and belief on information provided by third parties, and makes no representation or warranty as to the accuracy of such information. Efforts are underway to better integrate information from third parties. TI has taken and continues to take reasonable steps to provide representative and accurate information but may not have conducted destructive testing or chemical analysis on incoming materials and chemicals. TI and TI suppliers consider certain information to be proprietary, and thus CAS numbers and other limited information may not be available for release.

In no event shall TI's liability arising out of such information exceed the total purchase price of the TI part(s) at issue in this document sold by TI to Customer on an annual basis.

TAPE AND REEL INFORMATION

QUADRANT ASSIGNMENTS FOR PIN 1 ORIENTATION IN TAPE

*All dimensions are nominal

Device	Package Type	Package Drawing	Pins	SPQ	Reel Diameter (mm)	Reel Width W1 (mm)	A0 (mm)	B0 (mm)	K0 (mm)	P1 (mm)	W (mm)	Pin1 Quadrant
SN75LVPE802RTJR	QFN	RTJ	20	3000	330.0	12.4	4.25	4.25	1.15	8.0	12.0	Q2
SN75LVPE802RTJT	QFN	RTJ	20	250	180.0	12.4	4.25	4.25	1.15	8.0	12.0	Q2

TAPE AND REEL BOX DIMENSIONS

*All dimensions are nominal

Device	Package Type	Package Drawing	Pins	SPQ	Length (mm)	Width (mm)	Height (mm)
SN75LVPE802RTJR	QFN	RTJ	20	3000	346.0	346.0	33.0
SN75LVPE802RTJT	QFN	RTJ	20	250	210.0	185.0	35.0

GENERIC PACKAGE VIEW

RTJ 20

WQFN - 0.8 mm max height

4 x 4, 0.5 mm pitch

PLASTIC QUAD FLATPACK - NO LEAD

This image is a representation of the package family, actual package may vary.
Refer to the product data sheet for package details.

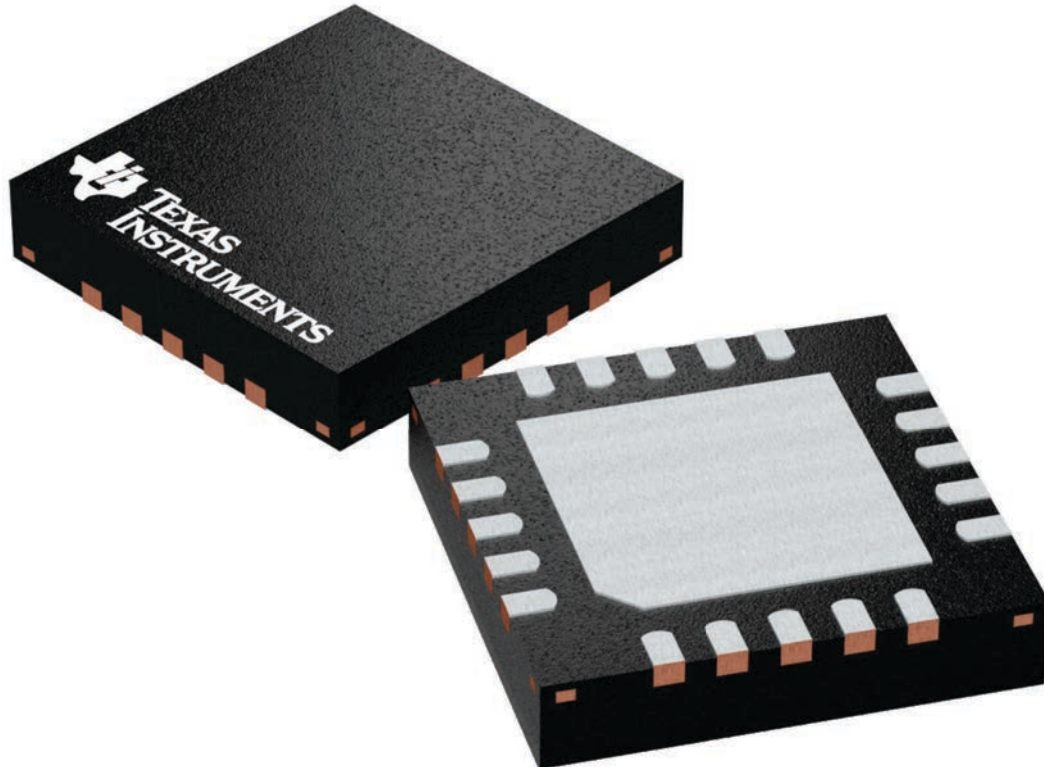

4224842/A

MECHANICAL DATA

RTJ (S-PWQFN-N20)

PLASTIC QUAD FLATPACK NO-LEAD

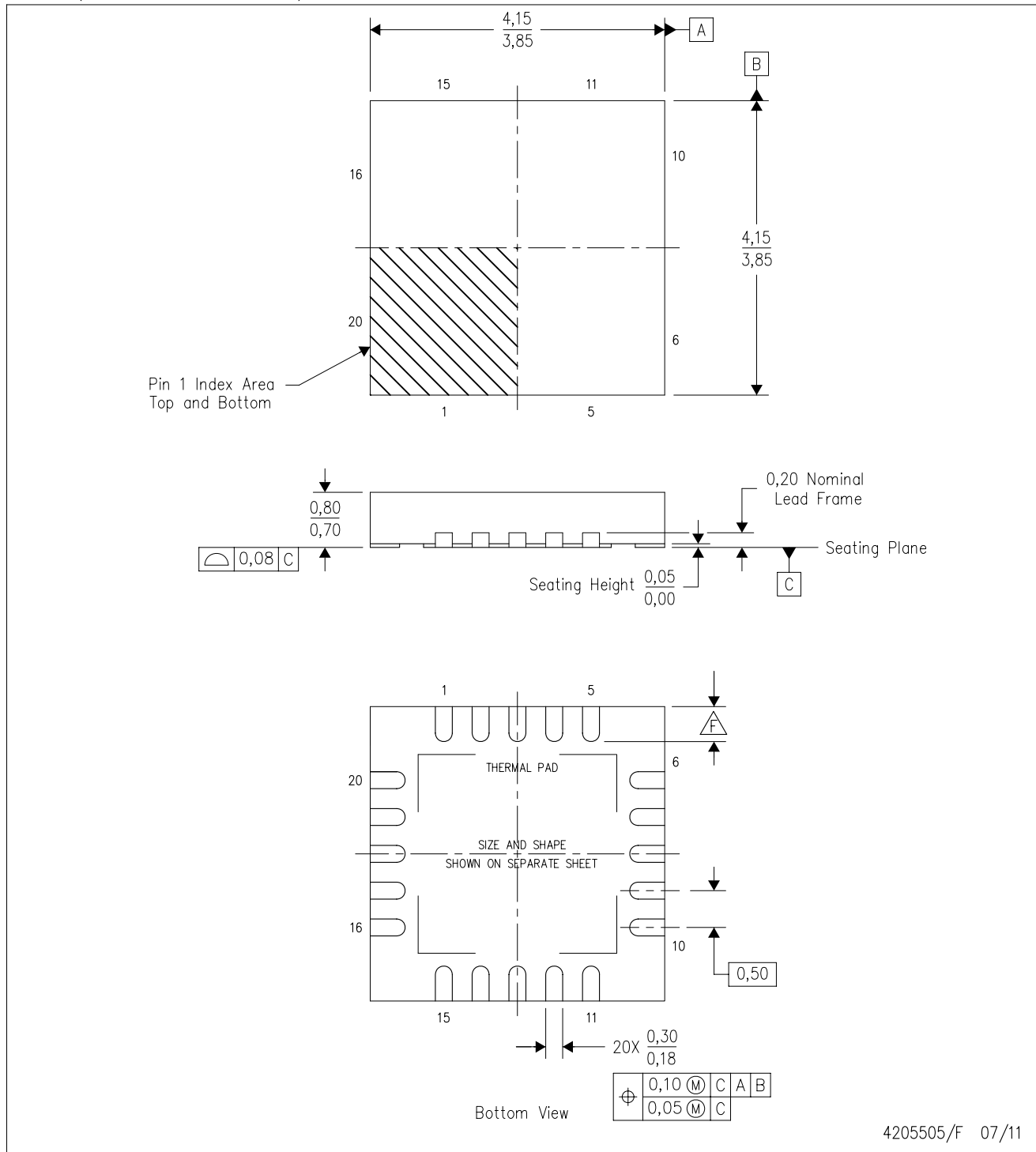

- NOTES:
- All linear dimensions are in millimeters. Dimensioning and tolerancing per ASME Y14.5-1994.
 - This drawing is subject to change without notice.
 - QFN (Quad Flatpack No-Lead) package configuration.
 - The package thermal pad must be soldered to the board for thermal and mechanical performance.
 - See the additional figure in the Product Data Sheet for details regarding the exposed thermal pad features and dimensions.
- ⚠ Check thermal pad mechanical drawing in the product datasheet for nominal lead length dimensions.

RTJ (S-PWQFN-N20)

PLASTIC QUAD FLATPACK NO-LEAD

THERMAL INFORMATION

This package incorporates an exposed thermal pad that is designed to be attached directly to an external heatsink. The thermal pad must be soldered directly to the printed circuit board (PCB). After soldering, the PCB can be used as a heatsink. In addition, through the use of thermal vias, the thermal pad can be attached directly to the appropriate copper plane shown in the electrical schematic for the device, or alternatively, can be attached to a special heatsink structure designed into the PCB. This design optimizes the heat transfer from the integrated circuit (IC).

For information on the Quad Flatpack No-Lead (QFN) package and its advantages, refer to Application Report, QFN/SON PCB Attachment, Texas Instruments Literature No. SLUA271. This document is available at www.ti.com.

The exposed thermal pad dimensions for this package are shown in the following illustration.

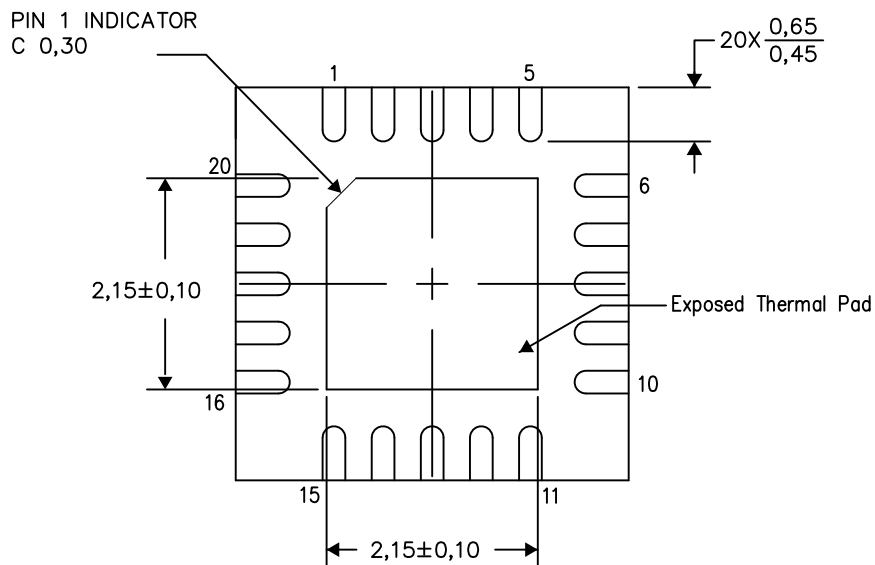

Bottom View

Exposed Thermal Pad Dimensions

4206256-3/V 05/15

NOTE: All linear dimensions are in millimeters

IMPORTANT NOTICE AND DISCLAIMER

TI PROVIDES TECHNICAL AND RELIABILITY DATA (INCLUDING DATASHEETS), DESIGN RESOURCES (INCLUDING REFERENCE DESIGNS), APPLICATION OR OTHER DESIGN ADVICE, WEB TOOLS, SAFETY INFORMATION, AND OTHER RESOURCES "AS IS" AND WITH ALL FAULTS, AND DISCLAIMS ALL WARRANTIES, EXPRESS AND IMPLIED, INCLUDING WITHOUT LIMITATION ANY IMPLIED WARRANTIES OF MERCHANTABILITY, FITNESS FOR A PARTICULAR PURPOSE OR NON-INFRINGEMENT OF THIRD PARTY INTELLECTUAL PROPERTY RIGHTS.

These resources are intended for skilled developers designing with TI products. You are solely responsible for (1) selecting the appropriate TI products for your application, (2) designing, validating and testing your application, and (3) ensuring your application meets applicable standards, and any other safety, security, regulatory or other requirements.

These resources are subject to change without notice. TI grants you permission to use these resources only for development of an application that uses the TI products described in the resource. Other reproduction and display of these resources is prohibited. No license is granted to any other TI intellectual property right or to any third party intellectual property right. TI disclaims responsibility for, and you fully indemnify TI and its representatives against any claims, damages, costs, losses, and liabilities arising out of your use of these resources.

TI's products are provided subject to [TI's Terms of Sale](#), [TI's General Quality Guidelines](#), or other applicable terms available either on ti.com or provided in conjunction with such TI products. TI's provision of these resources does not expand or otherwise alter TI's applicable warranties or warranty disclaimers for TI products. Unless TI explicitly designates a product as custom or customer-specified, TI products are standard, catalog, general purpose devices.

TI objects to and rejects any additional or different terms you may propose.

Copyright © 2025, Texas Instruments Incorporated

Last updated 10/2025