

TAC5112 Low-power stereo audio codec with 105dB dynamic range ADC and 114dB dynamic range DAC

1 Features

- Stereo low-power audio ADC
 - Performance:
 - Line/Microphone differential input dynamic range: 105dB
 - THD+N: –97dB
 - Channel summing mode supports high SNR: 108dB
 - Input voltage:
 - Differential, 2V_{RMS} full-scale input
 - Single-ended, 1V_{RMS} full-scale input
 - Input mix/mux options
 - ADC sample rate (f_S) = 4kHz to 768kHz
 - Programmable microphone bias (up to 3V)
 - Up to 4 Record Channels
 - 2 Channel Analog + 2 Channel Digital
 - 1 Channel Analog + 3 Channel Digital
 - 4 Channel Digital
- Stereo differential or Quad single-ended high performance audio DAC
 - Performance:
 - DAC to differential line-out dynamic range: 114dB
 - DAC to differential headphone-out dynamic range: 114dB
 - THD+N: –96dB
 - Line-out/headphone output voltage :
 - Differential, 2V_{RMS} full-scale
 - Pseudo-differential, 1V_{RMS} full-scale
 - Single-ended, 1V_{RMS} full-scale
 - DAC sample rate (f_S) = 4kHz to 768kHz
- Common features
 - Analog input to output bypass
 - Voice activity detection
 - Ultrasonic activity detection
 - Battery and thermal foldback protection
 - Signal distortion limiter
 - Low and Ultra-low latency filter options
 - Programmable HPF and Biquad filters
 - I²C or SPI control interface
 - Audio serial interface
 - Format: TDM, I²S or Left-justified (LJ)
 - Word length: 16, 20, 24 or 32 bits
 - Bus controller and target modes
 - Programmable PLL for flexible clocking
 - Auto clock and sample rate detection

- Low power modes
 - 8mW for 2-Ch recording (1.8V Supply)
 - 10.5mW for 2-Ch playback (1.8V Supply)
- Single supply operation AVDD: 1.8V or 3.3V
- I/O supply operation: 1.2V or 1.8V or 3.3V
- Temperature grade 1: –40°C ≤ T_A ≤ +125°C

2 Applications

- [Land Mobile Radio](#)
- [IP Network Camera](#)
- [IP Telephone](#)
- [Video Conference System](#)
- [Smart Speakers](#)
- [Professional audio mixer/control surface](#)

3 Description

The TAC5112 is a low-power stereo audio codec with 2V_{RMS} differential input, 105dB stereo ADC and 2V_{RMS} differential output, 114dB stereo or 1V_{RMS} single-ended output, 107dB quad DAC. The TAC5112 supports both differential and single-ended inputs and outputs. The ADC supports both line/microphone input signals with options for AC or DC coupling configurations. The DAC outputs can be configured for either line-output or headphone loads. The DAC can drive up to 62.5mW into a 16Ω headphone load. The TAC5112 integrates programmable channel gain, digital volume control, a low-jitter phase-locked loop (PLL), a programmable high-pass filter (HPF), programmable EQ and biquad filters, low-latency and ultra-low latency filter modes, and allows for sample rates up to 768kHz for both ADC and DAC signal chains. The TAC5112 supports time-division multiplexing (TDM), I²S, or left-justified (LJ) audio formats, and can be controlled with I²C or SPI. These integrated high-performance features, along with a single supply operation, makes TAC5112 an excellent choice for space-constrained audio applications.

Device Information

PART NUMBER	PACKAGE ⁽¹⁾	PACKAGE SIZE (NOM) ⁽²⁾
TAC5112	VQFN (24)	4mm x 4mm with 0.5mm pitch

- (1) For all available packages, see the orderable addendum at the end of the data sheet.
- (2) The package size (length × width) is a nominal value and includes pins, where applicable.



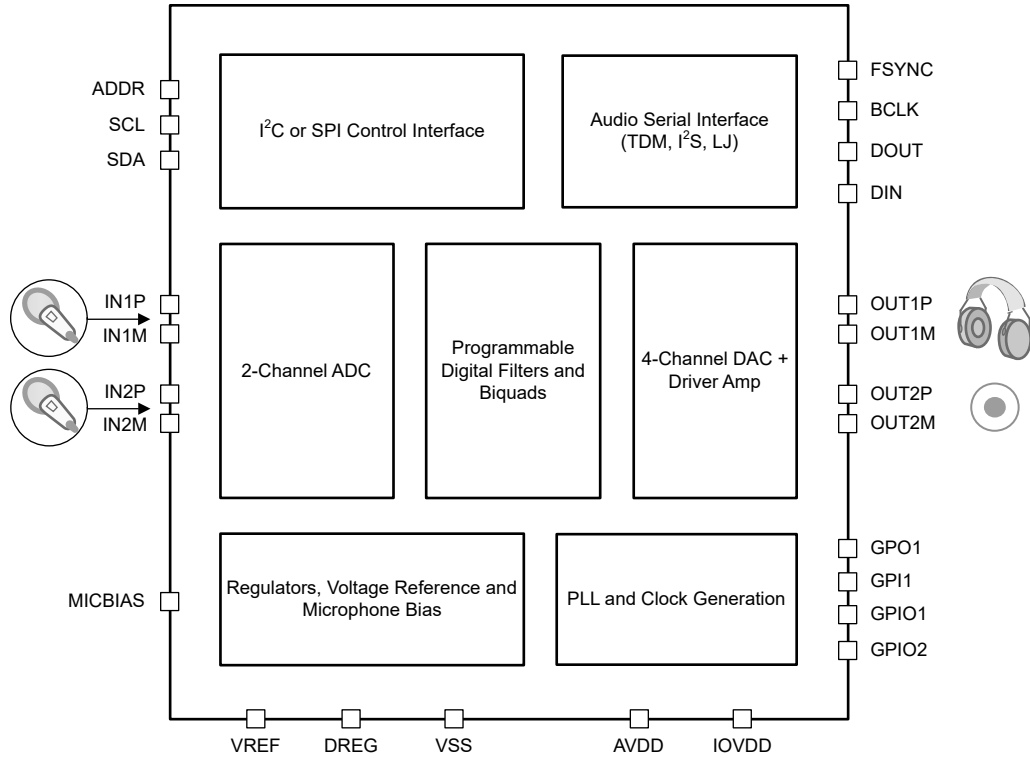

Simplified Block Diagram

Table of Contents

<p>1 Features..... 1</p> <p>2 Applications..... 1</p> <p>3 Description..... 1</p> <p>4 Device Comparison Table..... 4</p> <p>5 Pin Configuration and Functions..... 5</p> <p>6 Specifications..... 7</p> <p> 6.1 Absolute Maximum Ratings..... 7</p> <p> 6.2 ESD Ratings..... 7</p> <p> 6.3 Recommended Operating Conditions..... 7</p> <p> 6.4 Thermal Information..... 8</p> <p> 6.5 Electrical Characteristics..... 8</p> <p> 6.6 Timing Requirements: I²C Interface..... 17</p> <p> 6.7 Switching Characteristics: I²C Interface..... 18</p> <p> 6.8 Timing Requirements: SPI Interface..... 18</p> <p> 6.9 Switching Characteristics: SPI Interface..... 18</p> <p> 6.10 Timing Requirements: TDM, I²S or LJ Interface..... 18</p> <p> 6.11 Switching Characteristics: TDM, I²S or LJ Interface..... 19</p> <p> 6.12 Timing Requirements: PDM Digital Microphone Interface..... 20</p> <p> 6.13 Switching Characteristics: PDM Digital Microphone Interface..... 20</p> <p> 6.14 Timing Diagrams..... 20</p> <p> 6.15 Typical Characteristics..... 22</p>	<p>7 Detailed Description..... 28</p> <p> 7.1 Overview..... 28</p> <p> 7.2 Functional Block Diagram..... 29</p> <p> 7.3 Feature Description..... 29</p> <p> 7.4 Device Functional Modes..... 89</p> <p> 7.5 Programming..... 89</p> <p>8 Register Maps..... 95</p> <p> 8.1 Device Configuration Registers..... 95</p> <p> 8.2 Programmable Coefficient Registers..... 197</p> <p>9 Application and Implementation..... 229</p> <p> 9.1 Application Information..... 229</p> <p> 9.2 Typical Application..... 229</p> <p> 9.3 Power Supply Recommendations..... 233</p> <p> 9.4 Layout..... 234</p> <p>10 Device and Documentation Support..... 236</p> <p> 10.1 Documentation Support..... 236</p> <p> 10.2 Receiving Notification of Documentation Updates..... 236</p> <p> 10.3 Support Resources..... 236</p> <p> 10.4 Trademarks..... 236</p> <p> 10.5 Electrostatic Discharge Caution..... 236</p> <p> 10.6 Glossary..... 236</p> <p>11 Revision History..... 237</p> <p>12 Mechanical, Packaging, and Orderable Information..... 237</p>
---	---

4 Device Comparison Table

FEATURE	TAC5212	TAC5112	TAC5211	TAC5111	TAC5242	TAC5142
Control interface	I ² C or SPI				Pin or Hardware control	
Digital audio serial interface	TDM or I ² S or left-justified (LJ)					
Audio ADC channels	2		1		2	
Digital microphone channels	4		4		Not available (N/A)	
Microphone bias	Yes (Programmable voltage)				Yes (Fixed voltage)	
ADC Dynamic range	119dB	105dB	119dB	105dB	119dB	103dB
Audio DAC Channels	4		2		2	
DAC Dynamic Range	120dB	114dB	120dB	114dB	120dB	110dB
Compatibility	Pin-to-pin, package, and control registers compatible; drop-in replacements of each other		Pin-to-pin, package, and control registers compatible; drop-in replacements of each other		Pin-to-pin, package, and control configuration compatible; drop-in replacements of each other	
Package	VQFN, 24-pins, 4.00mm × 4.00mm with 0.5mm pitch					

5 Pin Configuration and Functions

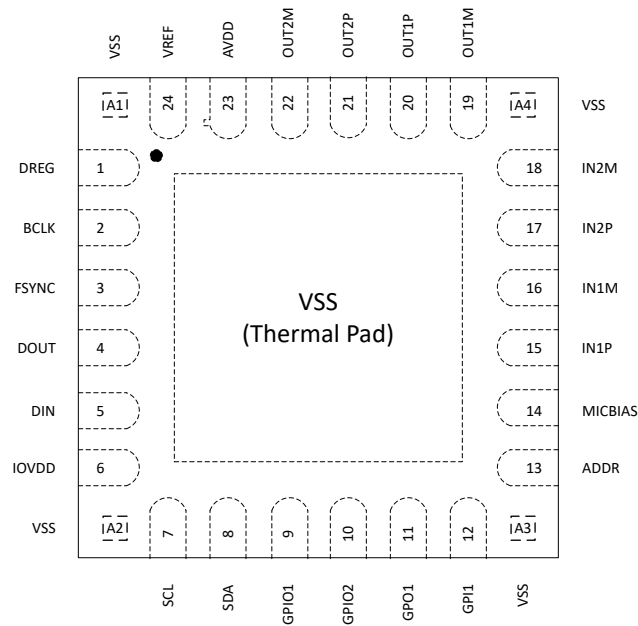

Notes:-
Not to Scale

Figure 5-1. 24-Pin QFN Package with Exposed Thermal Pad and Corner Pins, Top View

Table 5-1. Pin Functions

PIN		TYPE ⁽¹⁾	DESCRIPTION
NAME	NO.		
VSS	A1	Ground	Ground pin. Short directly to board ground plane.
DREG	1	Digital Supply	Digital on-chip regulator output voltage for digital supply (1.55V, nominal)
BCLK	2	Digital I/O	Audio serial data interface bus bit clock
FSYNC	3	Digital I/O	Audio serial data interface bus frame synchronization signal
DOUT	4	Digital I/O	Audio serial data interface bus output
DIN	5	Digital Input	Audio serial data interface bus input
IOVDD	6	Digital Supply	Digital I/O power supply (1.2V or 1.8V or 3.3V, nominal)
VSS	A2	Ground	Ground pin. Short directly to board ground plane.
SCL	7	Digital Input	Clock for I ² C control interface
SDA	8	Digital Input	Data for I ² C control interface
GPIO1	9	Digital I/O	General-purpose digital input/output 1 (multipurpose functions such as daisy-chain input, audio data output, PLL input clock source, interrupt, and so forth)
GPIO2	10	Digital I/O	General-purpose digital input/output 2 (multipurpose functions such as daisy-chain input, audio data output, PLL input clock source, interrupt, and so forth)
GPO1	11	Digital Output	General-purpose digital output 1 (multipurpose functions such as audio data output, interrupt, and so forth)
GPI1	12	Digital Input	General-purpose digital input 1 (multipurpose functions such as daisy-chain input, PLL input clock source, and so forth)

Table 5-1. Pin Functions (continued)

PIN		TYPE ⁽¹⁾	DESCRIPTION
NAME	NO.		
VSS	A3	Ground	Ground pin. Short directly to board ground plane.
ADDR	13	Analog Input	I ² C address pin
MICBIAS	14	Analog	Microphone bias output (Programmable output up to 3V)
IN1P	15	Analog Input	Analog input 1P pin
IN1M	16	Analog Input	Analog input 1M pin
IN2P	17	Analog Input	Analog input 2P pin
IN2M	18	Analog Input	Analog input 2M pin
VSS	A4	Ground	Ground pin. Short directly to board ground plane.
OUT1M	19	Analog Output	Analog output 1M pin
OUT1P	20	Analog Output	Analog output 1P pin
OUT2P	21	Analog Output	Analog output 2P pin
OUT2M	22	Analog Output	Analog output 2M pin
AVDD	23	Analog Supply	Analog power supply (1.8V or 3.3V, nominal)
VREF	24	Analog	Analog reference voltage filter output
VSS	Thermal Pad	Ground	Thermal pad shorted to internal device ground. Short directly to board ground plane.

(1) I = Input, O = Output, I/O = Input or Output, G = Ground, P = Power.

6 Specifications

6.1 Absolute Maximum Ratings

over the operating ambient temperature range (unless otherwise noted)⁽¹⁾

		MIN	MAX	UNIT
Supply voltage	AVDD to VSS (thermal pad)	-0.3	3.9	V
Supply voltage	IOVDD to VSS (thermal pad)	-0.3	3.9	V
Ground voltage differences	VSS to VSS (thermal pad)	-0.3	0.3	V
Analog input voltage	Analog input pins voltage to VSS (thermal pad)	-0.3	5.656	V
Digital input voltage	Digital input pins voltage to VSS (thermal pad)	-0.3	IOVDD + 0.3	V
Temperature	Functional ambient, T _A	-55	125	°C
	Operating ambient, T _A	-40	125	
	Junction, T _J	-40	150	
	Storage, T _{stg}	-65	150	

- (1) Operation outside the Absolute Maximum Ratings may cause permanent device damage. Absolute Maximum Ratings do not imply functional operation of the device at these or any other conditions beyond those listed under Recommended Operating Conditions. If used outside the Recommended Operating Conditions but within the Absolute Maximum Ratings, the device may not be fully functional, and this may affect device reliability, functionality, performance, and shorten the device lifetime.

6.2 ESD Ratings

			VALUE	UNIT
V _(ESD)	Electrostatic discharge	Human-body model (HBM), per ANSI/ESDA/JEDEC JS-001 ⁽¹⁾	±2000	V
V _(ESD)	Electrostatic discharge	Charged-device model (CDM), per ANSI/ESDA/JEDEC JS-002 ⁽²⁾	±500	

- (1) JEDEC document JEP155 states that 500V HBM allows safe manufacturing with a standard ESD control process.
(2) JEDEC document JEP157 states that 250V CDM allows safe manufacturing with a standard ESD control process.

6.3 Recommended Operating Conditions

over the operating ambient temperature range (unless otherwise noted)

		MIN	NOM	MAX	UNIT
POWER					
AVDD ⁽¹⁾	Analog supply voltage to VSS (thermal pad) - AVDD 3.3V operation	3.0	3.3	3.6	V
	Analog supply voltage to VSS (thermal pad) - AVDD 1.8V operation ⁽²⁾	1.65	1.8	1.95	
IOVDD	IO supply voltage to VSS (thermal pad) - IOVDD 3.3V operation	3.0	3.3	3.6	V
	IO supply voltage to VSS (thermal pad) - IOVDD 1.8V operation ⁽³⁾	1.65	1.8	1.95	
	IO supply voltage to VSS (thermal pad) - IOVDD 1.2V operation ⁽³⁾	1.08	1.2	1.32	
INPUTS					
INxx	Analog input pins voltage to VSS (thermal pad) for line-in recording	0		5.6	V
IO	Digital input pins voltage to VSS (thermal pad)	0		IOVDD	V
ADDR	ADDR pin w.r.t VSS (thermal pad)	0		AVDD	V
TEMPERATURE					
T _A	Operating ambient temperature	-40		125	°C

over the operating ambient temperature range (unless otherwise noted)

		MIN	NOM	MAX	UNIT
OTHERS					
CCLK	GPIOx or GPIx controller mode clock frequency (CCLK)			36.864 ⁽⁴⁾	MHz
C _b	SCL and SDA bus capacitance for I ² C interface supports standard-mode and fast-mode			400	pF
	SCL and SDA bus capacitance for I ² C interface supports fast-mode plus			550	
C _L	Digital output load capacitance		20	50	pF

- (1) VSS and VSS (thermal pad); all ground pins must be tied together and must not differ in voltage by more than 0.2V.
- (2) Set the AVDD_MODE bit correctly for AVDD 1.8V Operation. Refer Section 9.3 for more details.
- (3) Set the IOVDD_IO_MODE bit correctly for IOVDD 1.8V and 1.2V Operation. Refer Section 9.3 for more details.
- (4) CCLK input rise time (V_{IL} to V_{IH}) and fall time (V_{IH} to V_{IL}) must be less than 5ns. For better audio noise performance, CCLK input must be used with low jitter.

6.4 Thermal Information

THERMAL METRIC ⁽¹⁾		TAC5112	UNIT
		RGE (VQFN)	
		24 PINS	
R _{θJA}	Junction-to-ambient thermal resistance	38.4	°C/W
R _{θJC(top)}	Junction-to-case (top) thermal resistance	26.3	°C/W
R _{θJB}	Junction-to-board thermal resistance	15.9	°C/W
Ψ _{JT}	Junction-to-top characterization parameter	0.5	°C/W
Ψ _{JB}	Junction-to-board characterization parameter	15.8	°C/W
R _{θJC(bot)}	Junction-to-case (bottom) thermal resistance	13.8	°C/W

- (1) For more information about traditional and new thermal metrics, see the [Semiconductor and IC Package Thermal Metrics](#) application report.

6.5 Electrical Characteristics

At T_A = 25°C, AVDD = 3.3V, IOVDD = 3.3V, f_{IN} = 1kHz sinusoidal signal, f_S = 48kHz, 32-bit audio data, BCLK = 256×f_S, TDM target mode, linear phase decimation/interpolation filters, 5kΩ input impedance setting, AC-coupled differential input with ADC_CHX_CM_TOL = 2'b00 or DC-coupled differential input with ADC_CHX_CM_TOL = 2'b10 as applicable, 1200Ω/600Ω line-out load in differential/single-ended configuration or 32Ω/16Ω receiver/headphone load as applicable, PLL on, channel gain = 0dB, MICBIAS programmed to VREF and other default configurations; measured filter free with an Audio Precision with a 20Hz to 20kHz un-weighted bandwidth, unless otherwise noted

PARAMETER	TEST CONDITIONS	MIN	NOM	MAX	UNIT
ADC PERFORMANCE FOR INPUT RECORDING					
	Differential input full-scale DC signal voltage	AC-coupled or DC-coupled input		2	V _{RMS}
		DC-coupled input (High Swing Mode) ⁽³⁾		4	
	Single-ended input full-scale AC signal voltage	AC-coupled or DC-coupled input		1	V _{RMS}
		DC-coupled input (High Swing Mode) ⁽³⁾		2	
SNR	Signal-to-noise ratio, A-weighted ^{(1) (2)}	INxx differential AC-coupled input and AC signal shorted to ground, 0dB channel gain		104	dB
		INxx differential AC-coupled input and AC signal shorted to ground, 12dB channel gain		102	
		INxx differential DC-coupled input and AC signal shorted to ground, 0dB channel gain		102	
		INxx differential DC-coupled input and AC signal shorted to ground, 12dB channel gain		99	
SNR	Signal-to-noise ratio, A-weighted ^{(1) (2)}	Wideband Mode ⁽⁴⁾ : INxx differential AC-coupled input and AC signal shorted to ground, 0dB channel gain (Integrated till 20kHz and A-Weighted)		103	dB

At $T_A = 25^\circ\text{C}$, $AVDD = 3.3\text{V}$, $IOVDD = 3.3\text{V}$, $f_{IN} = 1\text{kHz}$ sinusoidal signal, $f_S = 48\text{kHz}$, 32-bit audio data, $BCLK = 256 \times f_S$, TDM target mode, linear phase decimation/interpolation filters, $5\text{k}\Omega$ input impedance setting, AC-coupled differential input with $ADC_CHx_CM_TOL = 2'b00$ or DC-coupled differential input with $ADC_CHx_CM_TOL = 2'b10$ as applicable, $1200\Omega/600\Omega$ line-out load in differential/single-ended configuration or $32\Omega/16\Omega$ receiver/headphone load as applicable, PLL on, channel gain = 0dB , MICBIAS programmed to VREF and other default configurations; measured filter free with an Audio Precision with a 20Hz to 20kHz un-weighted bandwidth, unless otherwise noted

PARAMETER		TEST CONDITIONS	MIN	NOM	MAX	UNIT
SNR	Signal-to-noise ratio ⁽¹⁾	Wideband Mode ⁽⁴⁾ : INxx differential AC-coupled input and AC signal shorted to ground, 0dB channel gain (Integrated till 85kHz)		91		dB
SNR	Signal-to-noise ratio, A-weighted ^{(1) (2)}	Power Tune Mode ⁽⁵⁾ : INxx differential AC-coupled input and AC signal shorted to ground, 0dB channel gain		101		dB
		Power Tune Mode ⁽⁵⁾ : INxx differential DC-coupled input and AC signal shorted to ground, 0dB channel gain		101		
SNR	Signal-to-noise ratio, A-weighted ^{(1) (2)}	INxx differential AC-coupled input and AC signal shorted to ground, 0dB channel gain, $AVDD = 1.8\text{V}$		103		dB
		INxx differential DC-coupled input and AC signal shorted to ground, 0dB channel gain, $AVDD = 1.8\text{V}$		101		
		INxx differential DC-coupled input selected and AC signal shorted to ground, 12dB channel gain, $AVDD = 1.8\text{V}$		94		
SNR	Signal-to-noise ratio, A-weighted ^{(1) (2)}	Power Tune Mode ⁽⁵⁾ : INxx differential AC-coupled input and AC signal shorted to ground, 0dB channel gain, $AVDD = 1.8\text{V}$		101		dB
		Power Tune Mode ⁽⁵⁾ : INxx differential DC-coupled input and AC signal shorted to ground, 0dB channel gain, $AVDD = 1.8\text{V}$		101		
SNR	Signal-to-noise ratio, A-weighted ^{(1) (2)}	INxx single-ended AC-coupled input and AC signal shorted to ground, 0dB channel gain		102		dB
	Signal-to-noise ratio, A-weighted ^{(1) (2)}	INxx single-ended AC-coupled input and AC signal shorted to ground, 12dB channel gain		97		
SNR	Signal-to-noise ratio, A-weighted ^{(1) (2)}	INxx single-ended DC-coupled input and AC signal shorted to ground, 0dB channel gain		101		dB
	Signal-to-noise ratio, A-weighted ^{(1) (2)}	INxx single-ended DC-coupled input and AC signal shorted to ground, 12dB channel gain		92		
SNR	Signal-to-noise ratio, A-weighted ^{(1) (2)}	INxx single-ended mux AC-coupled input and AC signal shorted to ground, 0dB channel gain, $10\text{k}\Omega$ input impedance		97		dB
	Signal-to-noise ratio, A-weighted ^{(1) (2)}	INxx single-ended mux DC-coupled input and AC signal shorted to ground, 0dB channel gain $10\text{k}\Omega$ input impedance		96		
DR	Dynamic range, A-weighted ⁽²⁾	INxx differential AC-coupled input and -60dBFS AC signal input, 0dB channel gain		105		dB
		INxx differential DC-coupled input and -60dBFS AC signal input, 0dB channel gain		104		
		INxx differential DC-coupled input and -72dBFS AC signal input, 12dB channel gain		99		
DR	Dynamic range, A-weighted ⁽²⁾	Power Tune Mode ⁽⁵⁾ : INxx differential AC-coupled input and -60dBFS AC signal input, 0dB channel gain		103		dB
		Power Tune Mode ⁽⁵⁾ : INxx differential DC-coupled input and -60dBFS AC signal input, 0dB channel gain		102		

TAC5112

SLASF24A – DECEMBER 2023 – REVISED JANUARY 2025

At $T_A = 25^\circ\text{C}$, $AVDD = 3.3\text{V}$, $IOVDD = 3.3\text{V}$, $f_{IN} = 1\text{kHz}$ sinusoidal signal, $f_S = 48\text{kHz}$, 32-bit audio data, $BCLK = 256 \times f_S$, TDM target mode, linear phase decimation/interpolation filters, $5\text{k}\Omega$ input impedance setting, AC-coupled differential input with $ADC_CHX_CM_TOL = 2'b00$ or DC-coupled differential input with $ADC_CHX_CM_TOL = 2'b10$ as applicable, $1200\Omega/600\Omega$ line-out load in differential/single-ended configuration or $32\Omega/16\Omega$ receiver/headphone load as applicable, PLL on, channel gain = 0dB, MICBIAS programmed to VREF and other default configurations; measured filter free with an Audio Precision with a 20Hz to 20kHz un-weighted bandwidth, unless otherwise noted

PARAMETER		TEST CONDITIONS	MIN	NOM	MAX	UNIT
DR	Dynamic range, A-weighted ⁽²⁾	INxx differential AC-coupled input and –60dBFS AC signal input, 0dB channel gain, AVDD = 1.8V		104		dB
		INxx differential DC-coupled input and –60dBFS AC signal input, 0dB channel gain, AVDD = 1.8V		103		
		INxx differential DC-coupled input and –72dBFS AC signal input, 12dB channel gain, AVDD = 1.8V		94		
DR	Dynamic range, A-weighted ⁽²⁾	Power Tune Mode: INxx differential AC-coupled input and –60dBFS AC signal input, 0dB channel gain, AVDD = 1.8V		102		dB
		Power Tune Mode: INxx differential DC-coupled input and –60dBFS AC signal input, 0dB channel gain, AVDD = 1.8V		101		
DR	Dynamic range, A-weighted ⁽²⁾	INxx single-ended AC-coupled input and –60dBFS AC signal input, 0dB channel gain		104		dB
DR	Dynamic range, A-weighted ⁽²⁾	INxx single-ended DC-coupled input and –60dBFS AC signal input, 0dB channel gain		102		dB
		INxx single-ended DC-coupled input and –72dBFS AC signal input, 12dB channel gain		92		
DR	Dynamic range, A-weighted ⁽²⁾	INxx single-ended mux AC-coupled input and –60dBFS AC signal input, 0dB channel gain, 10k Ω input impedance		97		dB
THD+N	Total harmonic distortion ⁽²⁾	INxx differential AC-coupled input and –1dBFS AC signal input, 0dB channel gain		–97		dB
		INxx differential DC-coupled input and –1dBFS AC signal input, 0dB channel gain		–97		
		INxx differential DC-coupled input and –13dBFS AC signal input, 12dB channel gain		–96		
THD+N	Total harmonic distortion ⁽²⁾	INxx single-ended AC-coupled input and –1dBFS AC signal input, 0dB channel gain		–94		dB
		INxx single-ended DC-coupled input and –1dBFS AC signal input, 0dB channel gain		–85		
		INxx single-ended mux AC-coupled input and –1dBFS AC signal input, 0dB channel gain, 10k Ω input impedance		–93		
ADC OTHER PARAMETERS						
	Input impedance	Input pins INxP or INxM, 5k Ω Input Impedance Mode		5.5		k Ω
		Input pins INxP or INxM, 10k Ω Input Impedance Mode		11		
		Input pins INxP or INxM, 40k Ω Input Impedance Mode		44		
	Digital volume control range	Programmable 0.5dB steps	–80		47	dB
	Input Signal Bandwidth	Upto 192KSPS FS Rate		0.46		FS
		>192KSPS		90		kHz
	Output data sample rate	Programmable	4		768	kHz
	Output data sample word length	Programmable	16		32	Bits

At $T_A = 25^\circ\text{C}$, $AVDD = 3.3\text{V}$, $IOVDD = 3.3\text{V}$, $f_{IN} = 1\text{kHz}$ sinusoidal signal, $f_S = 48\text{kHz}$, 32-bit audio data, $BCLK = 256 \times f_S$, TDM target mode, linear phase decimation/interpolation filters, $5\text{k}\Omega$ input impedance setting, AC-coupled differential input with $ADC_CHx_CM_TOL = 2'b00$ or DC-coupled differential input with $ADC_CHx_CM_TOL = 2'b10$ as applicable, $1200\Omega/600\Omega$ line-out load in differential/single-ended configuration or $32\Omega/16\Omega$ receiver/headphone load as applicable, PLL on, channel gain = 0dB , MICBIAS programmed to VREF and other default configurations; measured filter free with an Audio Precision with a 20Hz to 20kHz un-weighted bandwidth, unless otherwise noted

PARAMETER	TEST CONDITIONS	MIN	NOM	MAX	UNIT
Digital high-pass filter cutoff frequency	First-order IIR filter with programmable coefficients, -3dB point (default setting)		1		Hz
Interchannel isolation	-1dBFS AC signal line-in differential input to nonmeasurement channel		-134		dB
Interchannel gain mismatch	-6dBFS AC signal line-in differential input, 1kHz sinusoidal signal, 0dB channel gain		± 0.1		dB
Interchannel phase mismatch	-6dBFS AC signal line-in differential input, 1kHz sinusoidal signal		± 0.01		Degrees
PSRR	Power-supply rejection ratio 100mV_{PP} , 1kHz sinusoidal signal on AVDD, differential input, 0dB channel gain		107		dB
CMRR	Common-mode rejection ratio Differential DC-coupled input, 0dB channel gain, -6dBFS AC input, 1kHz signal on both pins and measured level at output		60		dB
MICROPHONE BIAS					
MICBIAS noise	Bandwidth = 20Hz to 20kHz, A-weighted, $1\mu\text{F}$ capacitor between MICBIAS and VSS (thermal pad)		2		μV_{RMS}
MICBIAS voltage	Bypass to AVDD		AVDD		V
MICBIAS voltage	AVDD=1.8V		1.375		V
MICBIAS voltage	AVDD=3.3V		2.75		V
Analog Bypass to Line Out/Head Phone Amplifier					
Input impedance	Input pins INxP or INxM, $4.4\text{k}\Omega$ Input Impedance Mode		4.4		k Ω
	Input pins INxP or INxM, $20\text{k}\Omega$ Input Impedance Mode		20		
Differential Full Scale Output	AVDD=3.3V		2		Vrms
	AVDD=1.8V		1		Vrms
Single Ended Full Scale Output	AVDD=3.3V		1		Vrms
Gain Error	AC-Coupled Input, -6dBFS input		± 0.1		dB
Noise, A-Weighted	Idle Channel, AC-Coupled Input Shorted to Ground, Differential output		4.1		μV_{RMS}
Noise, A-Weighted	Idle Channel, AC-Coupled Input Shorted to Ground, Single-ended output		21		μV_{RMS}
SNR	Signal-to-noise ratio, A-weighted ⁽¹⁾ ⁽²⁾ Idle Channel, AC-Coupled Input Shorted to Ground, Differential output		113		dB
SNR	Signal-to-noise ratio, A-weighted ⁽¹⁾ ⁽²⁾ Idle Channel, AC-Coupled Input Shorted to Ground, Single-ended output		94		dB
THD+N	Total harmonic distortion ⁽²⁾ IN1 differential AC-coupled Input and -1dBFS AC signal input, 0dB channel gain		-102		dB
DAC Performance for Line Output/Head Phone Playback					

TAC5112

SLASF24A – DECEMBER 2023 – REVISED JANUARY 2025

At $T_A = 25^\circ\text{C}$, $AVDD = 3.3\text{V}$, $IOVDD = 3.3\text{V}$, $f_{IN} = 1\text{kHz}$ sinusoidal signal, $f_S = 48\text{kHz}$, 32-bit audio data, $BCLK = 256 \times f_S$, TDM target mode, linear phase decimation/interpolation filters, $5\text{k}\Omega$ input impedance setting, AC-coupled differential input with $ADC_CHx_CM_TOL = 2'b00$ or DC-coupled differential input with $ADC_CHx_CM_TOL = 2'b10$ as applicable, $1200\Omega/600\Omega$ line-out load in differential/single-ended configuration or $32\Omega/16\Omega$ receiver/headphone load as applicable, PLL on, channel gain = 0dB, MICBIAS programmed to VREF and other default configurations; measured filter free with an Audio Precision with a 20Hz to 20kHz un-weighted bandwidth, unless otherwise noted

PARAMETER		TEST CONDITIONS	MIN	NOM	MAX	UNIT
	Full Scale Output Voltage	Differential output between OUTxP and OUTxM, AVDD=3.3V		2		V_{RMS}
		Differential output between OUTxP and OUTxM, AVDD=1.8V		1		
		Single-ended output, AVDD=3.3V		1		
		Single-ended output, AVDD=1.8V		0.5		
		Pseudo-differential output between OUTxP and OUTxM, AVDD=3.3V		1		
		Pseudo-differential output between OUTxP and OUTxM, AVDD=1.8V		0.5		
SNR	Signal-to-noise ratio, A-weighted ^{(1) (2)}	Differential output, 0dBFS signal, AVDD=3.3V		114		dB
		Single-ended output, 0dBFS signal, AVDD=3.3V		107		
		Pseudo-differential output, 0dBFS signal, AVDD=3.3V		105		
		Differential output, 0dBFS signal, AVDD=1.8V		109		
		Single-ended output, 0dBFS Signal, AVDD=1.8V		101		
		Pseudo-differential output, 0dBFS signal, AVDD=1.8V		99		
		Differential output, 0dBFS signal, AVDD=3.3V, Power Tune Mode ⁽⁵⁾		114		
		Single-ended output, 0dBFS signal, AVDD=3.3V, Power Tune Mode ⁽⁵⁾		103		
		Pseudo-differential output, 0dBFS signal, AVDD=3.3V, Power Tune Mode ⁽⁵⁾		105		
		Differential output, 0dBFS signal, AVDD=1.8V, Power Tune Mode ⁽⁵⁾		108		
		Single-ended output, 0dBFS signal, AVDD=1.8V, Power Tune Mode ⁽⁵⁾		98		
		Pseudo-differential output, 0dBFS signal, AVDD=1.8V, Power Tune Mode		99		
SNR	Signal-to-noise ratio, A-weighted ^{(1) (2)}	Differential output, Receiver load, 0dBFS signal, AVDD=3.3V		114		dB
		Single-ended output, Headphone load, 0dBFS signal, AVDD=3.3V		107		
		Pseudo-differential output, Receiver load, 0dBFS signal, AVDD=3.3V		105		
		Differential output, Receiver load, 0dBFS signal, AVDD=1.8V		109		
		Single-ended output, Headphone load, 0dBFS signal, AVDD=1.8V		101		
		Pseudo-differential output, Receiver load, 0dBFS signal, AVDD=1.8V		99		

At $T_A = 25^\circ\text{C}$, $AVDD = 3.3\text{V}$, $IOVDD = 3.3\text{V}$, $f_{IN} = 1\text{kHz}$ sinusoidal signal, $f_S = 48\text{kHz}$, 32-bit audio data, $BCLK = 256 \times f_S$, TDM target mode, linear phase decimation/interpolation filters, $5\text{k}\Omega$ input impedance setting, AC-coupled differential input with $ADC_CHx_CM_TOL = 2'b00$ or DC-coupled differential input with $ADC_CHx_CM_TOL = 2'b10$ as applicable, $1200\Omega/600\Omega$ line-out load in differential/single-ended configuration or $32\Omega/16\Omega$ receiver/headphone load as applicable, PLL on, channel gain = 0dB , MICBIAS programmed to VREF and other default configurations; measured filter free with an Audio Precision with a 20Hz to 20kHz un-weighted bandwidth, unless otherwise noted

PARAMETER		TEST CONDITIONS	MIN	NOM	MAX	UNIT
DR	Dynamic range, A-weighted ⁽²⁾	Differential output, -60dBFS signal, AVDD=3.3V		114		dB
		Single-ended output, -60dBFS signal, AVDD=3.3V		107		
		Pseudo-differential output, -60dBFS signal, AVDD=3.3V		106		
		Differential output, -60dBFS signal, AVDD=1.8V		110		
		Single-ended output, -60dBFS Signal, AVDD=1.8V		101		
		Pseudo-differential output, -60dBFS signal, AVDD=1.8V		100		
		Differential output, -60dBFS signal, AVDD=3.3V, Power Tune Mode ⁽⁵⁾		114		
		Single-ended output, -60dBFS signal, AVDD=3.3V, Power Tune Mode ⁽⁵⁾		104		
		Pseudo-differential output, -60dBFS signal, AVDD=3.3V, Power Tune Mode ⁽⁵⁾		105		
		Differential output, -60dBFS signal, AVDD=1.8V, Power Tune Mode ⁽⁵⁾		109		
		Single-ended output, -60dBFS signal, AVDD=1.8V, Power Tune Mode ⁽⁵⁾		99		
Pseudo-differential output, -60dBFS signal, AVDD=1.8V, Power Tune Mode		99				
DR	Dynamic range, A-weighted ⁽²⁾	Differential-output, Receiver load, -60dBFS signal, AVDD=3.3V		114		dB
		Single-ended output, Headphone load, -60dBFS signal, AVDD=3.3V		107		
		Pseudo-differential output, Receiver load, -60dBFS signal, AVDD=3.3V		106		
		Differential-output, Receiver load, -60dBFS signal, AVDD=1.8V		110		
		Single-ended output, Headphone load, -60dBFS signal, AVDD=1.8V		102		
		Pseudo-differential output, Receiver load, -60dBFS signal, AVDD=1.8V		100		
THD+N	Total harmonic distortion ⁽²⁾	Differential output, -1dBFS signal, AVDD= 3.3V		-96		dB
		Single-ended output, -1dBFS signal, AVDD= 3.3V		-94		
		Psuedo-differential output, -1dBFS signal, AVDD= 3.3V		-93		
	Headphone load range	Single-ended	4	16	600	Ω
	Line-out load range	Single-ended	600			Ω
	Headphone/Line-out Cap load	Single-ended	0		2	nF
DAC Channel OTHER PARAMETERS						
	Output Offset	0 Input, Differential line-output		± 0.5		mV

TAC5112

SLASF24A – DECEMBER 2023 – REVISED JANUARY 2025

At $T_A = 25^\circ\text{C}$, $AVDD = 3.3\text{V}$, $IOVDD = 3.3\text{V}$, $f_{IN} = 1\text{kHz}$ sinusoidal signal, $f_S = 48\text{kHz}$, 32-bit audio data, $BCLK = 256 \times f_S$, TDM target mode, linear phase decimation/interpolation filters, $5\text{k}\Omega$ input impedance setting, AC-coupled differential input with $ADC_CHx_CM_TOL = 2'b00$ or DC-coupled differential input with $ADC_CHx_CM_TOL = 2'b10$ as applicable, $1200\Omega/600\Omega$ line-out load in differential/single-ended configuration or $32\Omega/16\Omega$ receiver/headphone load as applicable, PLL on, channel gain = 0dB , MICBIAS programmed to VREF and other default configurations; measured filter free with an Audio Precision with a 20Hz to 20kHz un-weighted bandwidth, unless otherwise noted

PARAMETER		TEST CONDITIONS	MIN	NOM	MAX	UNIT
	Output Common Mode	Common Mode Level for OUTxP and OUTxM, $AVDD = 1.8\text{V}$ (Register Configurable)		0.9		V
		Common Mode Level for OUTxP and OUTxM, $AVDD = 3.3\text{V}$ (Register Configurable)		1.65		
	Common Mode Error	DC Error in Common Mode Voltage		± 20		mV
	Output Signal Bandwidth	Upto 192KSPS FS Rate		0.46		FS
		>192KSPS		90		kHz
	Input data sample rate	Programmable	4		768	kHz
	Input data sample word length	Programmable	16		32	Bits
	Digital high-pass filter cutoff frequency	First-order IIR filter with programmable coefficients, -3dB point (default setting)		1		Hz
	Interchannel isolation	Differential output, -1dBFS input signal on nonmeasurement channel		-120		dB
	Gain Error	Differential output, -6dBFS Input signal		± 0.1		dB
	Interchannel gain mismatch	Differential output, -6dBFS Input signal		± 0.1		dB
	Interchannel phase mismatch	Differential output, -6dBFS Input signal		± 0.01		Degrees
PSRR	Power-supply rejection ratio	100-mV_{PP} , 1kHz sinusoidal signal on $AVDD$, differential input selected, 0dB channel gain		110		dB
	Mute Attenuation			-130		dB
P_{out}	Output Power Delivery	Single-ended/Pseudo-differential headphone $R_L = 16\Omega$, $THD+N < 0.1\%$		62.5		mW
DIGITAL I/O						
V_{IL}	Low-level digital input logic voltage threshold	All digital pins except SDA and SCL, $IOVDD$ 1.8V or 1.2V operation	-0.3		$0.35 \times IOVDD$	V
		All digital pins except SDA and SCL, $IOVDD$ 3.3V operation	-0.3		0.8	
V_{IH}	High-level digital input logic voltage threshold	All digital pins except SDA and SCL, $IOVDD$ 1.8V or 1.2V operation	$0.65 \times IOVDD$		$IOVDD + 0.3$	V
		All digital pins except SDA and SCL, $IOVDD$ 3.3V operation	2		$IOVDD + 0.3$	
V_{OL}	Low-level digital output voltage	All digital pins except SDA and SCL, $I_{OL} = -2\text{mA}$, $IOVDD$ 1.8V or 1.2V operation			0.45	V
		All digital pins except SDA and SCL, $I_{OL} = -2\text{mA}$, $IOVDD$ 3.3V operation			0.4	
V_{OH}	High-level digital output voltage	All digital pins except SDA and SCL, $I_{OH} = 2\text{mA}$, $IOVDD$ 1.8V or 1.2V operation	$IOVDD - 0.45$			V
		All digital pins except SDA and SCL, $I_{OH} = 2\text{mA}$, $IOVDD$ 3.3V operation	2.4			
$V_{IL(I2C)}$	Low-level digital input logic voltage threshold	SDA and SCL	-0.5		$0.3 \times IOVDD$	V
$V_{IH(I2C)}$	High-level digital input logic voltage threshold	SDA and SCL	$0.7 \times IOVDD$		$IOVDD + 0.5$	V
$V_{OL1(I2C)}$	Low-level digital output voltage	SDA, $I_{OL(I2C)} = -3\text{mA}$, $IOVDD$ 3.3V operation			0.4	V

At $T_A = 25^\circ\text{C}$, $AVDD = 3.3\text{V}$, $IOVDD = 3.3\text{V}$, $f_{IN} = 1\text{kHz}$ sinusoidal signal, $f_S = 48\text{kHz}$, 32-bit audio data, $BCLK = 256 \times f_S$, TDM target mode, linear phase decimation/interpolation filters, $5\text{k}\Omega$ input impedance setting, AC-coupled differential input with $ADC_CHx_CM_TOL = 2'b00$ or DC-coupled differential input with $ADC_CHx_CM_TOL = 2'b10$ as applicable, $1200\Omega/600\Omega$ line-out load in differential/single-ended configuration or $32\Omega/16\Omega$ receiver/headphone load as applicable, PLL on, channel gain = 0dB , MICBIAS programmed to VREF and other default configurations; measured filter free with an Audio Precision with a 20Hz to 20kHz un-weighted bandwidth, unless otherwise noted

PARAMETER		TEST CONDITIONS	MIN	NOM	MAX	UNIT
$V_{OL2(I2C)}$	Low-level digital output voltage	SDA, $I_{OL(I2C)} = -2\text{mA}$, $IOVDD = 1.8\text{V}$ or 1.2V operation			$0.2 \times IOVDD$	V
$I_{OL(I2C)}$	Low-level digital output current	SDA, $V_{OL(I2C)} = 0.4\text{V}$, standard-mode or fast-mode	3			mA
		SDA, $V_{OL(I2C)} = 0.4\text{V}$, fast-mode plus	20			
I_{IL}	Input logic-low leakage for digital inputs	All digital pins, Input = 0V	-5	0.1	5	μA
I_{IH}	Input logic-high leakage for digital inputs	All digital pins, Input = $IOVDD$	-5	0.1	5	μA
C_{IN}	Input capacitance for digital inputs	All digital pins		5		pF
R_{PD}	Pulldown resistance for digital I/O pins when asserted on			20		$\text{k}\Omega$
TYPICAL SUPPLY CURRENT CONSUMPTION						
I_{AVDD}	Current consumption in sleep mode (software shutdown mode)	All device external clocks stopped			9	μA
I_{IOVDD}					1	
I_{AVDD}	Current consumption with MICBIAS ON, 5mA load, ADC off	$f_S = 48\text{kHz}$, $BCLK = 256 \times f_S$			1.5	mA
I_{IOVDD}					0.02	
I_{AVDD}	Current consumption with ADC 2-channel operation, MICBIAS off, PLL on	$f_S = 16\text{kHz}$, $BCLK = 512 \times f_S$			8.6	mA
I_{IOVDD}					0.1	
I_{AVDD}	Current consumption with ADC 2-channel operation, MICBIAS off, PLL off	$f_S = 48\text{kHz}$, $BCLK = 512 \times f_S$			5.7	mA
I_{IOVDD}					0.3	
I_{AVDD}	Current consumption with ADC 2-channel operation, MICBIAS on, PLL off	$f_S = 48\text{kHz}$, $BCLK = 512 \times f_S$			6.6	mA
I_{IOVDD}					0.3	
I_{AVDD}	Current consumption with DAC to Headphone 2-channel operation, MICBIAS off, PLL on	$f_S = 16\text{kHz}$, $BCLK = 512 \times f_S$			17.9	mA
I_{IOVDD}					0.02	
I_{AVDD}	Current consumption with DAC to Headphone 2-channel operation, MICBIAS on, PLL off	$f_S = 48\text{kHz}$, $BCLK = 512 \times f_S$			15.2	mA
I_{IOVDD}					0.04	
I_{AVDD}	Current consumption with ADC 2-channel operation and DAC to Headphone 2-channel operation, MICBIAS on, PLL on	$f_S = 48\text{kHz}$, $BCLK = 512 \times f_S$			27.6	mA
I_{IOVDD}					0.3	
I_{AVDD}	Power Tune Mode ⁽⁵⁾ : Current consumption with ADC 2-channel operation, MICBIAS off, PLL off, $AVDD=1.8\text{V}$	$f_S = 48\text{kHz}$, $BCLK = 128 \times f_S$			4.1	mA

TAC5112

SLASF24A – DECEMBER 2023 – REVISED JANUARY 2025

At $T_A = 25^\circ\text{C}$, $AVDD = 3.3\text{V}$, $IOVDD = 3.3\text{V}$, $f_{IN} = 1\text{kHz}$ sinusoidal signal, $f_S = 48\text{kHz}$, 32-bit audio data, $BCLK = 256 \times f_S$, TDM target mode, linear phase decimation/interpolation filters, $5\text{k}\Omega$ input impedance setting, AC-coupled differential input with $ADC_CHx_CM_TOL = 2'b00$ or DC-coupled differential input with $ADC_CHx_CM_TOL = 2'b10$ as applicable, $1200\Omega/600\Omega$ line-out load in differential/single-ended configuration or $32\Omega/16\Omega$ receiver/headphone load as applicable, PLL on, channel gain = 0dB, MICBIAS programmed to VREF and other default configurations; measured filter free with an Audio Precision with a 20Hz to 20kHz un-weighted bandwidth, unless otherwise noted

PARAMETER		TEST CONDITIONS	MIN	NOM	MAX	UNIT
I_{AVDD}	Power Tune Mode ⁽⁵⁾ : Current consumption with DAC to Lineout 2-channel single-ended operation, MICBIAS off, PLL off, $AVDD=1.8\text{V}$	$f_S = 48\text{kHz}$, $BCLK = 128 \times f_S$		5.5		mA
I_{AVDD}	Power Tune Mode ⁽⁵⁾ : Current consumption with DAC to Lineout 2-channel operation, MICBIAS off, PLL on	$f_S = 48\text{kHz}$, $BCLK = 512 \times f_S$		9.2		mA
I_{IOVDD}	Current consumption with DAC to Lineout 2-channel operation, MICBIAS off, PLL on			0.04		

- (1) Ratio of output level with 1kHz full-scale sine-wave input, to the output level with the AC signal input shorted to ground, measured A-weighted over a 20Hz to 20kHz bandwidth using an audio analyzer.
- (2) All performance measurements done with 20kHz low-pass filter and, where noted, an A-weighted filter. Failure to use such a filter can result in higher THD+N and lower SNR and dynamic range readings than shown in the Electrical Characteristics. The low-pass filter removes out-of-band noise, which, although not audible, can affect dynamic specification values.
- (3) $ADC_CHx_FULLSCALE_VAL = 1'b1$ and $10\text{k}\Omega$ input impedance for High Swing Mode
- (4) $ADC_CHx_BW_MODE = 1'b1$ and $40\text{k}\Omega$ input impedance for Wideband Mode
- (5) $PWR_TUNE_CFG0 = 0xD4$, $PWR_TUNE_CFG1 = 0x86$ and $PLL_DIS = 1'b1$ for Power Tune Mode

6.6 Timing Requirements: I²C Interface

At $T_A = 25^\circ\text{C}$, IOVDD = 3.3V or 1.8V or 1.2V (unless otherwise noted); see Figure 5-1 for timing diagram. Set the IOVDD_IO_MODE bit correctly for IOVDD 1.8V and 1.2V Operation. Refer Section 9.3 for more details.

		MIN	NOM	MAX	UNIT
STANDARD-MODE					
f _{SCL}	SCL clock frequency	0		100	kHz
t _{HD,STA}	Hold time (repeated) START condition. After this period, the first clock pulse is generated.	4			μs
t _{LOW}	Low period of the SCL clock	4.7			μs
t _{HIGH}	High period of the SCL clock	4			μs
t _{SU,STA}	Setup time for a repeated START condition	4.7			μs
t _{HD,DAT}	Data hold time	0		3.45	μs
t _{SU,DAT}	Data setup time	250			ns
t _r	SDA and SCL rise time			1000	ns
t _f	SDA and SCL fall time			300	ns
t _{SU,STO}	Setup time for STOP condition	4			μs
t _{BUF}	Bus free time between a STOP and START condition	4.7			μs
FAST-MODE					
f _{SCL}	SCL clock frequency	0		400	kHz
t _{HD,STA}	Hold time (repeated) START condition. After this period, the first clock pulse is generated.	0.6			μs
t _{LOW}	Low period of the SCL clock	1.3			μs
t _{HIGH}	High period of the SCL clock	0.6			μs
t _{SU,STA}	Setup time for a repeated START condition	0.6			μs
t _{HD,DAT}	Data hold time	0		0.9	μs
t _{SU,DAT}	Data setup time	100			ns
t _r	SDA and SCL rise time	20		300	ns
t _f	SDA and SCL fall time		$20 \times$ (IOVDD / 5.5 V)	300	ns
t _{SU,STO}	Setup time for STOP condition	0.6			μs
t _{BUF}	Bus free time between a STOP and START condition	1.3			μs
FAST-MODE PLUS					
f _{SCL}	SCL clock frequency	0		1000	kHz
t _{HD,STA}	Hold time (repeated) START condition. After this period, the first clock pulse is generated.	0.26			μs
t _{LOW}	Low period of the SCL clock	0.5			μs
t _{HIGH}	High period of the SCL clock	0.26			μs
t _{SU,STA}	Setup time for a repeated START condition	0.26			μs
t _{HD,DAT}	Data hold time	0			μs
t _{SU,DAT}	Data setup time	50			ns
t _r	SDA and SCL Rise Time			120	ns
t _f	SDA and SCL Fall Time		$20 \times$ (IOVDD / 5.5 V)	120	ns
t _{SU,STO}	Setup time for STOP condition	0.26			μs
t _{BUF}	Bus free time between a STOP and START condition	0.5			μs

6.7 Switching Characteristics: I²C Interface

At $T_A = 25^\circ\text{C}$, IOVDD = 3.3V or 1.8V or 1.2V (unless otherwise noted); see Figure 5-1 for timing diagram. Set the IOVDD_IO_MODE bit correctly for IOVDD 1.8V and 1.2V Operation. Refer Section 9.3 for more details.

PARAMETER		TEST CONDITIONS	MIN	TYP	MAX	UNIT
$t_{d(\text{SDA})}$	SCL to SDA delay	Standard-mode	200		1250	ns
		Fast-mode	200		850	ns
		Fast-mode plus			400	ns

6.8 Timing Requirements: SPI Interface

At $T_A = 25^\circ\text{C}$, IOVDD = 3.3V or 1.8V or 1.2V and 20pF load on all outputs (unless otherwise noted); see Figure 5-2 for timing diagram. Set the IOVDD_IO_MODE bit correctly for IOVDD 1.8V and 1.2V Operation. Refer Section 9.3 for more details.

PARAMETER		TEST CONDITIONS	MIN	NOM	MAX	UNIT
$t_{(\text{SCLK})}$	SCLK period		40			ns
$t_{H(\text{SCLK})}$	SCLK high pulse duration		18			ns
$t_{L(\text{SCLK})}$	SCLK low pulse duration		18			ns
t_{LEAD}	Enable lead time		16			ns
t_{TRAIL}	Enable trail time		16			ns
t_{DSEQ}	Sequential transfer delay		20			ns
$t_{\text{SU(PICO)}}$	PICO data setup time		8			ns
$t_{\text{HLD(PICO)}}$	PICO data hold time		8			ns
$t_{r(\text{SCLK})}$	SCLK rise time	10% - 90% rise time			6	ns
$t_{f(\text{SCLK})}$	SCLK fall time	90% - 10% fall time			6	ns

6.9 Switching Characteristics: SPI Interface

At $T_A = 25^\circ\text{C}$, IOVDD = 3.3V or 1.8V or 1.2V and 20pF load on all outputs (unless otherwise noted); see Figure 5-2 for timing diagram. Set the IOVDD_IO_MODE bit correctly for IOVDD 1.8V and 1.2V Operation. Refer Section 9.3 for more details.

PARAMETER		TEST CONDITIONS	MIN	TYP	MAX	UNIT
$t_{a(\text{POCI})}$	POCI access time	IOVDD = 1.2V			18	ns
		IOVDD = 1.8V			18	ns
		IOVDD = 3.3V			14	ns
$t_{d(\text{POCI})}$	SCLK to POCI delay	50% of SCLK to 50% of POCI, IOVDD = 1.2V			19	ns
		50% of SCLK to 50% of POCI, IOVDD = 1.8V			19	ns
		50% of SCLK to 50% of POCI, IOVDD = 3.3V			15	ns
$t_{\text{dis(POCI)}}$	POCI disable time	IOVDD = 1.2V			18	ns
		IOVDD = 1.8V			18	ns
		IOVDD = 3.3V			14	ns

6.10 Timing Requirements: TDM, I²S or LJ Interface

At $T_A = 25^\circ\text{C}$, IOVDD = 3.3V or 1.8V or 1.2V and 20pF load on all outputs (unless otherwise noted); see Figure 5-3 for timing diagram. Set the IOVDD_IO_MODE bit correctly for IOVDD 1.8V and 1.2V Operation. Refer Section 9.3 for more details.

PARAMETER		TEST CONDITIONS	MIN	NOM	MAX	UNIT
$t_{(\text{BCLK})}$	BCLK period		40			ns
$t_{H(\text{BCLK})}$	BCLK high pulse duration ⁽¹⁾		18			ns
$t_{L(\text{BCLK})}$	BCLK low pulse duration ⁽¹⁾		18			ns
$t_{\text{SU(FSYNC)}}$	FSYNC setup time		8			ns
$t_{\text{HLD(FSYNC)}}$	FSYNC hold time		8			ns
$t_{\text{SU(DIN)}}$	DIN setup time		8			ns

At $T_A = 25^\circ\text{C}$, IOVDD = 3.3V or 1.8V or 1.2V and 20pF load on all outputs (unless otherwise noted); see Figure 5-3 for timing diagram. Set the IOVDD_IO_MODE bit correctly for IOVDD 1.8V and 1.2V Operation. Refer Section 9.3 for more details.

		MIN	NOM	MAX	UNIT
$t_{\text{HLD(DIN)}}$	DIN hold time	8			ns
$t_{\text{r(BCLK)}}$	BCLK rise time	10% - 90% rise time		10	ns
$t_{\text{f(BCLK)}}$	BCLK fall time	90% - 10% fall time		10	ns

- (1) To meet the timing specifications, the BCLK minimum high or low pulse duration must be higher than 25ns, if the DOUT data line is latched on the opposite BCLK edge polarity from the one used by the device to transmit the DOUT data.

6.11 Switching Characteristics: TDM, I²S or LJ Interface

At $T_A = 25^\circ\text{C}$, IOVDD = 3.3V or 1.8V or 1.2V and 20pF load on all outputs (unless otherwise noted); see Figure 5-3 for timing diagram. Set the IOVDD_IO_MODE bit correctly for IOVDD 1.8V and 1.2V Operation. Refer Section 9.3 for more details.

PARAMETER		TEST CONDITIONS	MIN	TYP	MAX	UNIT
$t_{\text{d(DOUT-BCLK)}}$	BCLK to DOUT delay	50% of BCLK to 50% of DOUT, IOVDD = 1.2V			18	ns
		50% of BCLK to 50% of DOUT, IOVDD = 1.8V			18	
		50% of BCLK to 50% of DOUT, IOVDD = 3.3V			14	
$t_{\text{d(DOUT-FSYNC)}}$	FSYNC to DOUT delay in TDM or LJ mode (for MSB data with TX_OFFSET = 0)	50% of FSYNC to 50% of DOUT, IOVDD = 1.2V			18	ns
		50% of FSYNC to 50% of DOUT, IOVDD = 1.8V			18	
		50% of FSYNC to 50% of DOUT, IOVDD = 3.3V			14	
$f_{\text{(BCLK)}}$	BCLK output clock frequency; controller mode ⁽¹⁾				24.576	MHz
$t_{\text{H(BCLK)}}$	BCLK high pulse duration; controller mode	IOVDD = 1.2V	14			ns
		IOVDD = 1.8V	14			
		IOVDD = 3.3V	14			
$t_{\text{L(BCLK)}}$	BCLK low pulse duration; controller mode	IOVDD = 1.2V	14			ns
		IOVDD = 1.8V	14			
		IOVDD = 3.3V	14			
$t_{\text{d(FSYNC)}}$	BCLK to FSYNC delay; controller mode	50% of BCLK to 50% of FSYNC, IOVDD = 1.2V			18	ns
		50% of BCLK to 50% of FSYNC, IOVDD = 1.8V			18	
		50% of BCLK to 50% of FSYNC, IOVDD = 3.3V			14	
$t_{\text{r(BCLK)}}$	BCLK rise time; controller mode	10% - 90% rise time, IOVDD = 1.2V			10	ns
		10% - 90% rise time, IOVDD = 1.8V			10	
		10% - 90% rise time, IOVDD = 3.3V			10	
$t_{\text{f(BCLK)}}$	BCLK fall time; controller mode	90% - 10% fall time, IOVDD = 1.2V			8	ns
		90% - 10% fall time, IOVDD = 1.8V			8	
		90% - 10% fall time, IOVDD = 3.3V			8	

- (1) To meet the timing specifications, the BCLK output clock frequency must be lower than 18.5 MHz, if the DOUT data line is latched on the opposite BCLK edge polarity from the one used by the device to transmit DOUT data.

6.12 Timing Requirements: PDM Digital Microphone Interface

At $T_A = 25^\circ\text{C}$, IOVDD = 3.3V or 1.8V or 1.2V and 20pF load on all outputs (unless otherwise noted); see Figure 5-4 for timing diagram. Set the IOVDD_IO_MODE bit correctly for IOVDD 1.8V and 1.2V Operation. Refer Section 9.3 for more details.

		MIN	NOM	MAX	UNIT
$t_{\text{SU}}(\text{PDMINx})$	PDMINx setup time	30			ns
$t_{\text{HLD}}(\text{PDMINx})$	PDMINx hold time	0			ns

6.13 Switching Characteristics: PDM Digital Microphone Interface

At $T_A = 25^\circ\text{C}$, IOVDD = 3.3V or 1.8V or 1.2V and 20pF load on all outputs (unless otherwise noted); see Figure 5-4 for timing diagram. Set the IOVDD_IO_MODE bit correctly for IOVDD 1.8V and 1.2V Operation. Refer Section 9.3 for more details.

PARAMETER	TEST CONDITIONS	MIN	TYP	MAX	UNIT
f_{PDMCLK}	PDMCLK clock frequency	0.768		6.144	MHz
$t_{\text{H}}(\text{PDMCLK})$	PDMCLK high pulse duration	72			ns
$t_{\text{L}}(\text{PDMCLK})$	PDMCLK low pulse duration	72			ns
$t_{\text{r}}(\text{PDMCLK})$	PDMCLK rise time	10% - 90% rise time		18	ns
$t_{\text{f}}(\text{PDMCLK})$	PDMCLK fall time	90% - 10% fall time		18	ns

6.14 Timing Diagrams

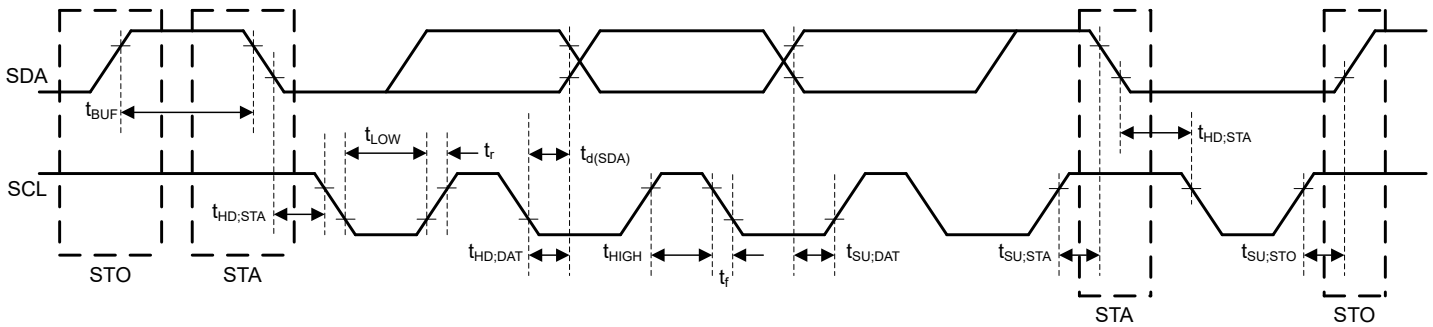

Figure 6-1. I²C Interface Timing Diagram

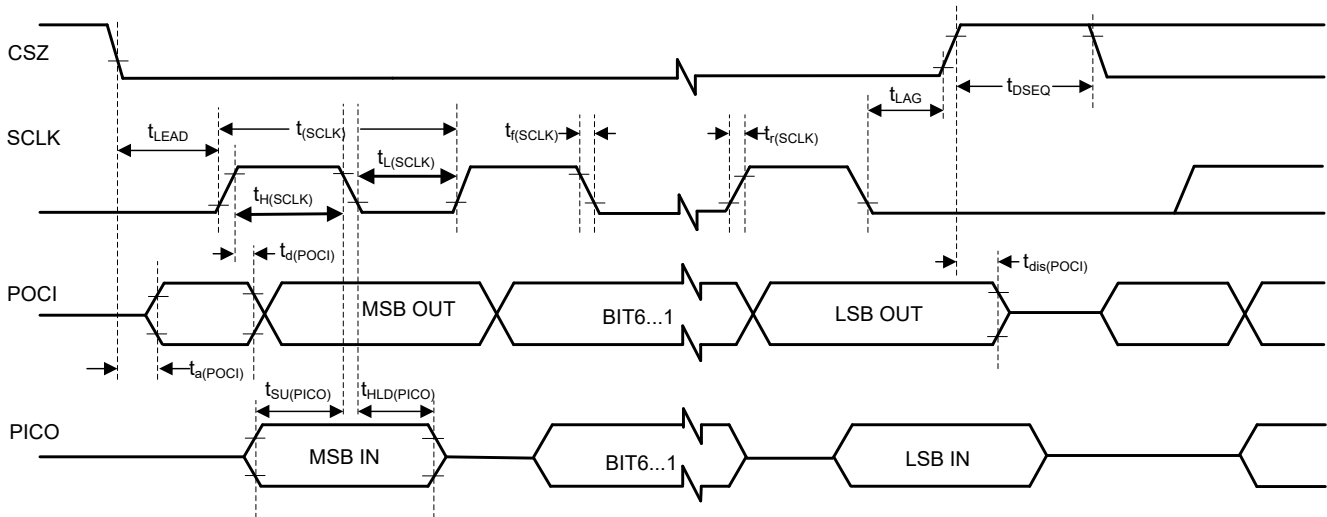

Figure 6-2. SPI Interface Timing Diagram

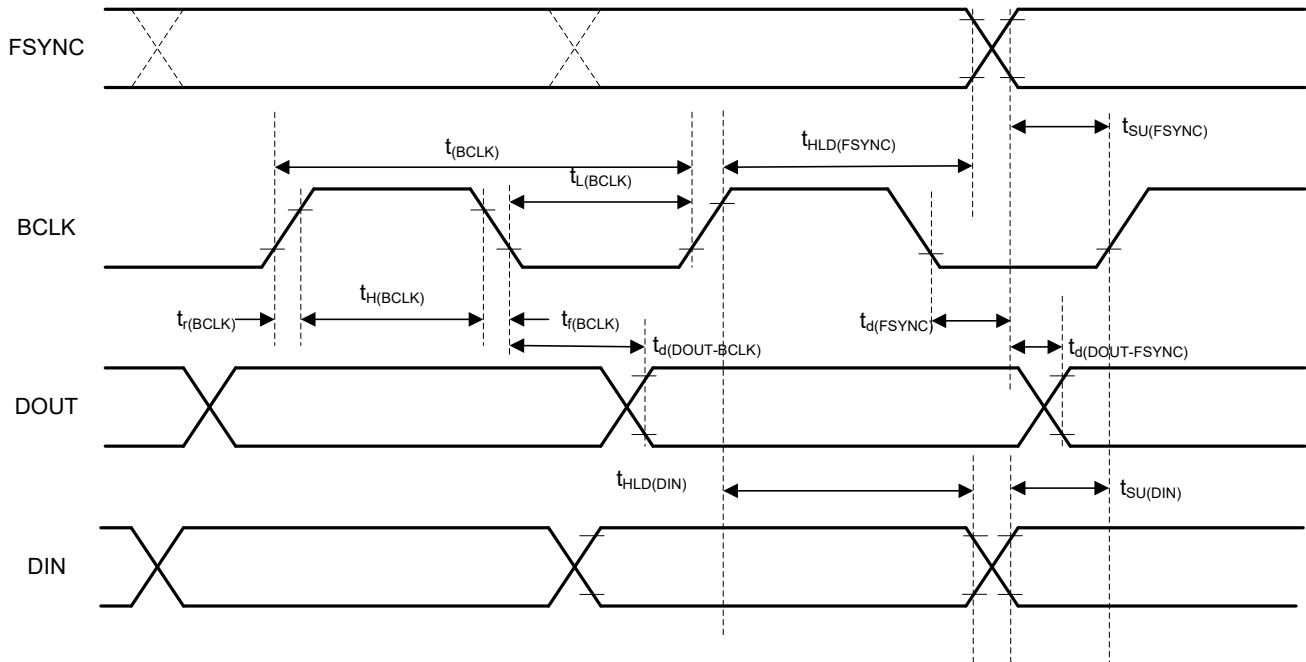

Figure 6-3. TDM (With BCLK_POL = 1), I²S, and LJ Interface Timing Diagram

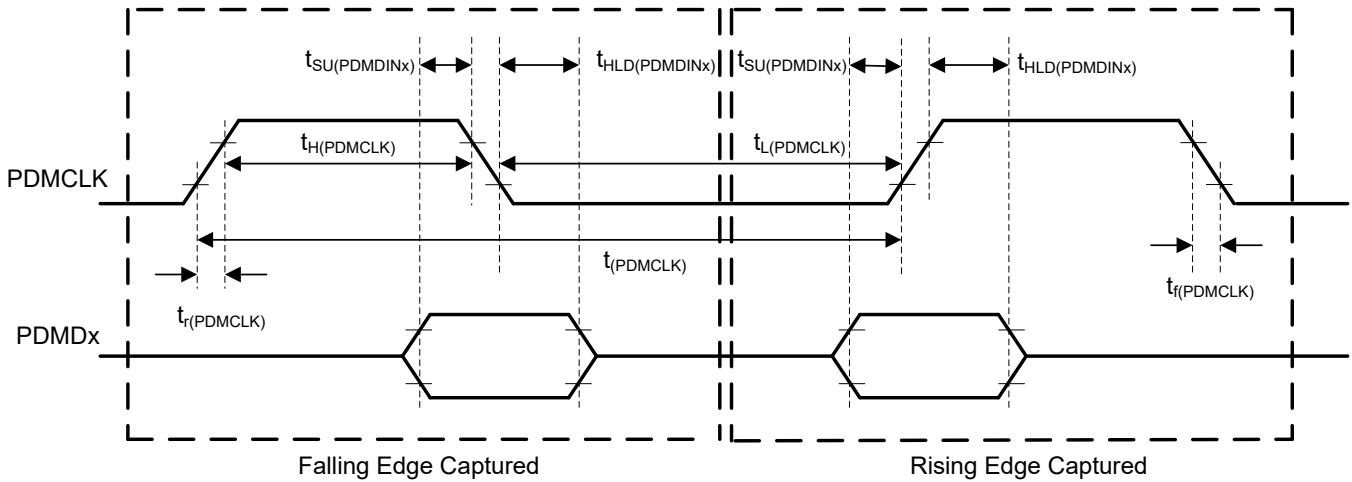
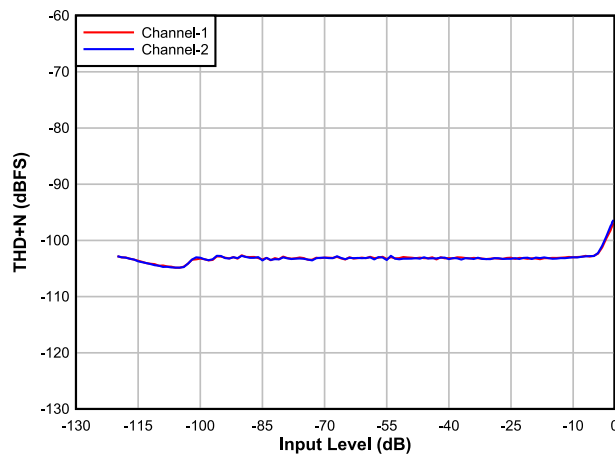

Figure 6-4. PDM Digital Microphone Interface Timing Diagram

6.15 Typical Characteristics

At $T_A = 25^\circ\text{C}$, $AV_{DD} = 3.3\text{ V}$, $IOV_{DD} = 3.3\text{ V}$, $f_{IN} = 1\text{ kHz}$ sinusoidal signal, $f_S = 48\text{ kHz}$, 32-bit audio data, $BCLK = 256 \times f_S$, TDM target mode, PLL on, channel gain = 0dB, linear phase decimation/interpolation filters, $5\text{ k}\Omega$ input impedance setting, AC-coupled differential input with $ADC_CHx_CM_TOL = 2'b00$ or DC-coupled differential input with $ADC_CHx_CM_TOL = 2'b10$ as applicable, $1200\Omega/600\Omega$ line-out load in differential/single-ended configuration or $32\Omega/16\Omega$ receiver/headphone load as applicable, MICBIAS programmed to VREF and other default configurations; measured filter free with an Audio Precision with a 20Hz to 20kHz un-weighted bandwidth, unless otherwise noted



AC-coupled differential line input

Figure 6-5. ADC THD+N Level vs Input

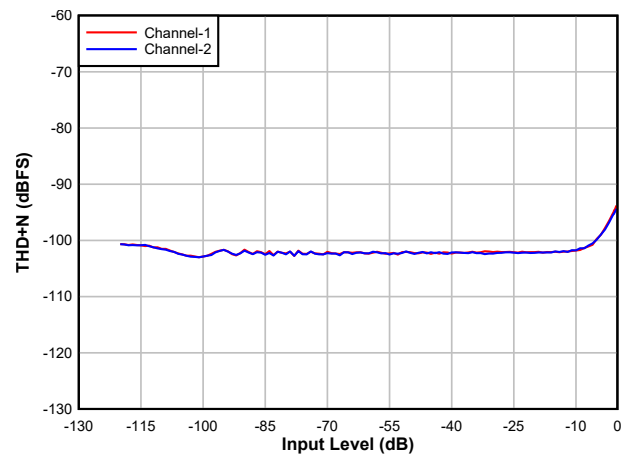

AC-coupled single-ended line input

Figure 6-6. ADC THD+N Level vs Input

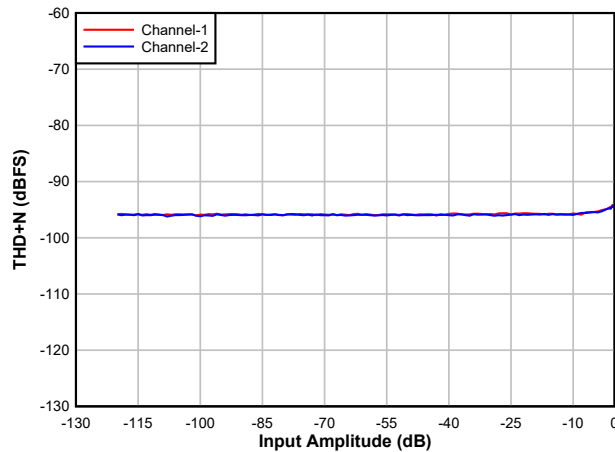

AC-coupled single-ended mux line input with 10kΩ input impedance setting

Figure 6-7. ADC THD+N Level vs Input

AC-coupled differential line input, $AV_{DD} = 1.8\text{ V}$

Figure 6-8. ADC THD+N Level vs Input



AC-coupled differential line input (-60dBFS)

Figure 6-9. ADC A-weighted DR vs Frequency

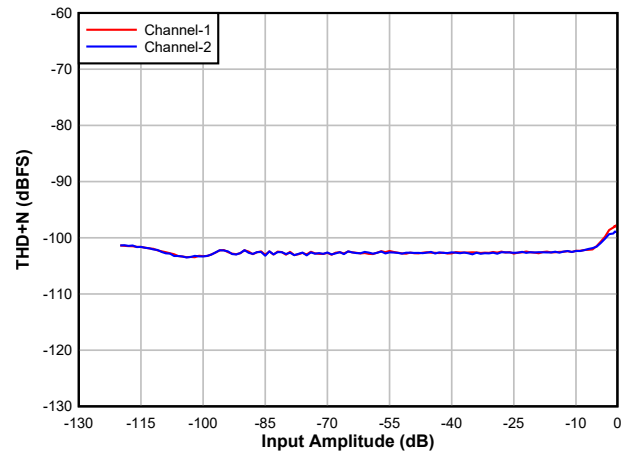
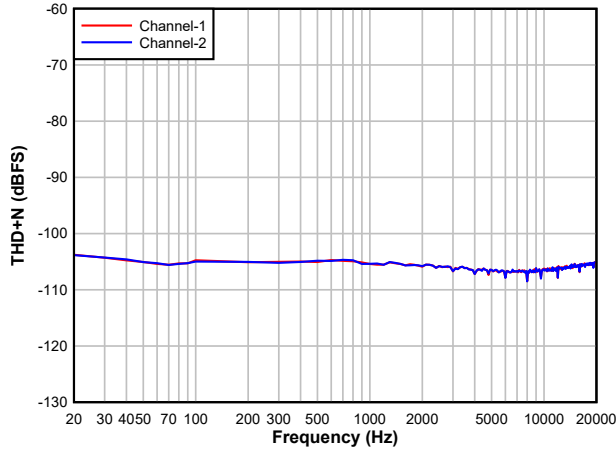
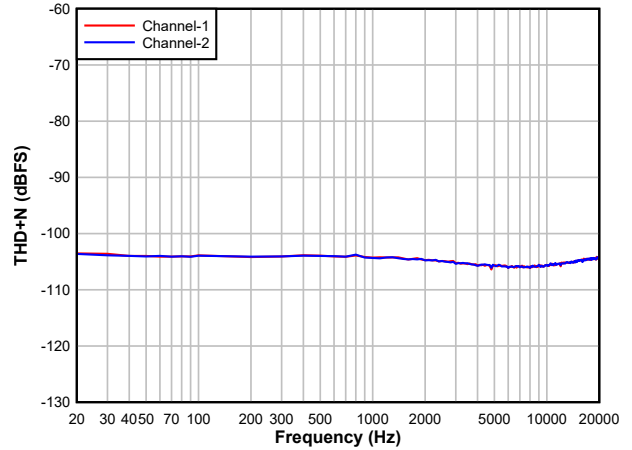

AC-coupled single-ended line input (-60dBFS)

Figure 6-10. ADC A-weighted DR vs Frequency

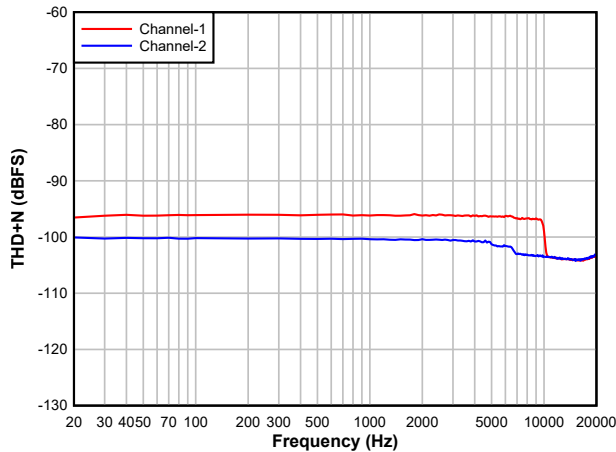

AC-coupled differential line input (-1dBFS)

Figure 6-11. ADC THD+N vs Frequency

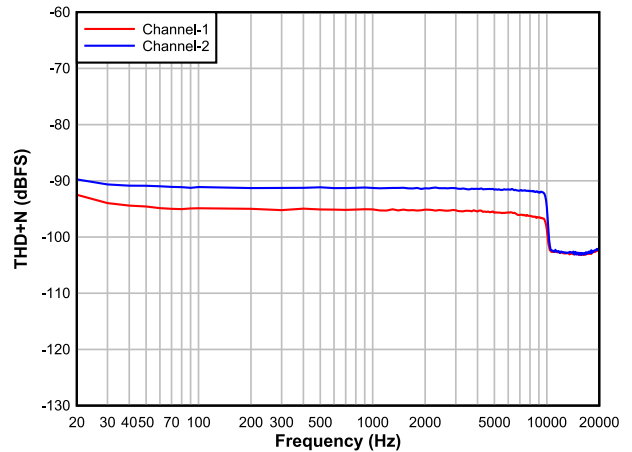

AC-coupled single-ended line input (-1dBFS)

Figure 6-12. ADC THD+N vs Frequency

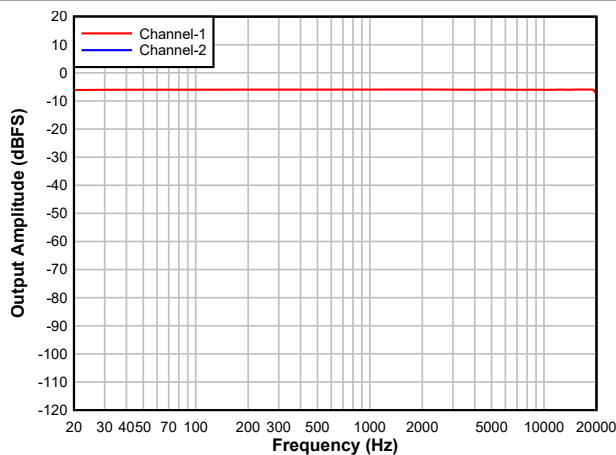

AC-coupled differential line input (-6dBFS)

Figure 6-13. ADC Frequency Response

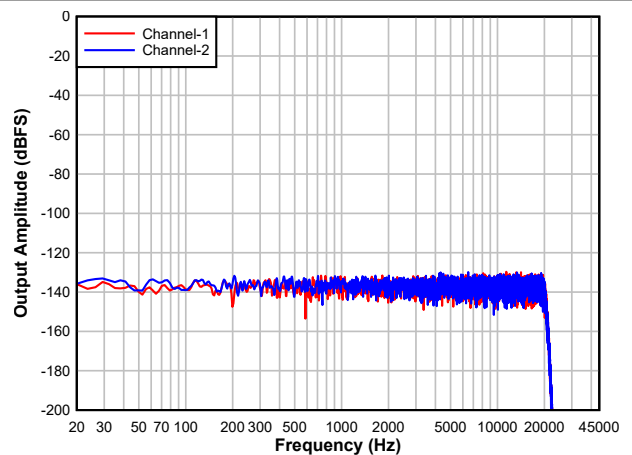

AC-coupled differential line input

Figure 6-14. ADC FFT With Idle Channel Input

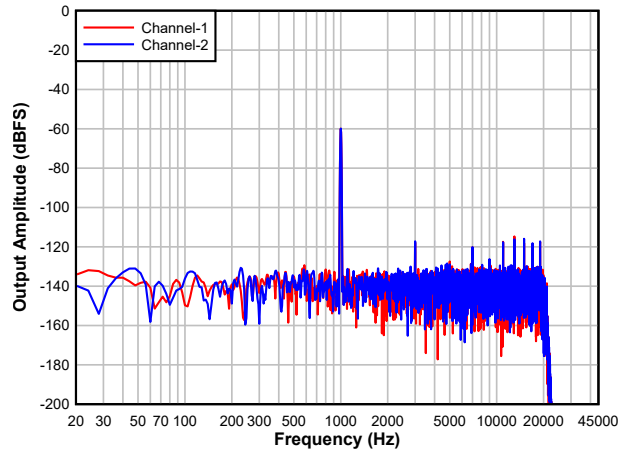

AC-coupled differential line input

Figure 6-15. ADC FFT with -60dBFS Input

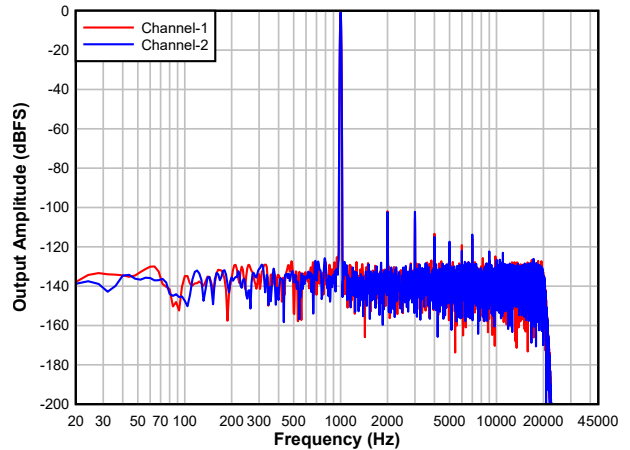

AC-coupled differential line input

Figure 6-16. ADC FFT with -1dBFS Input

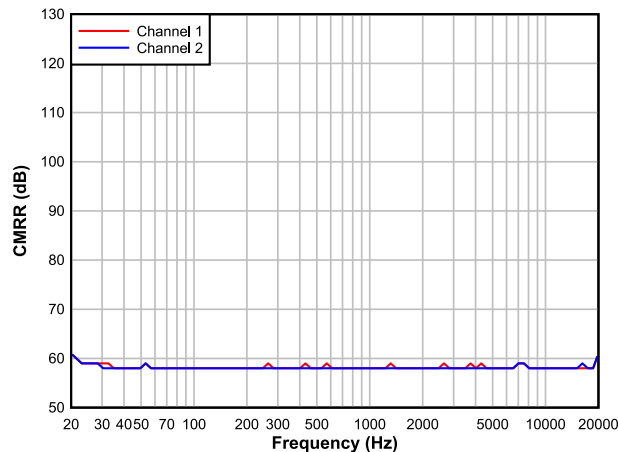

DC-coupled differential input with ADC_CHx_CM_TOL = 2'b10 (High CMRR mode)

Figure 6-17. ADC CMRR vs Frequency

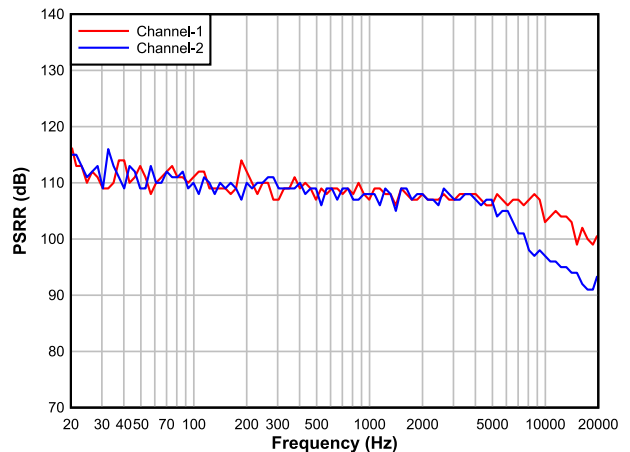

AC-coupled differential line input

Figure 6-18. ADC PSRR vs Frequency

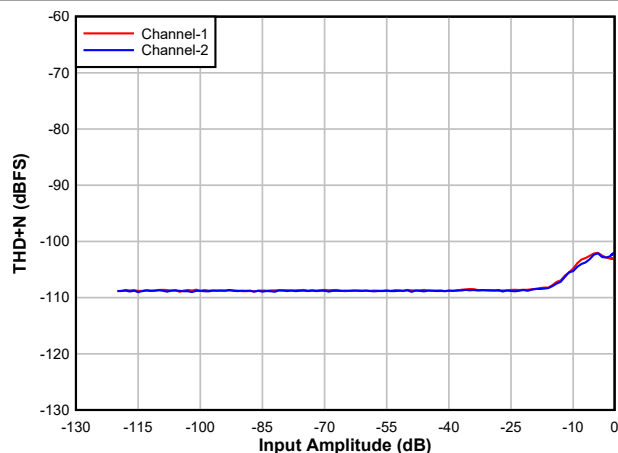

Differential output

Figure 6-19. DAC THD+N Level vs Input

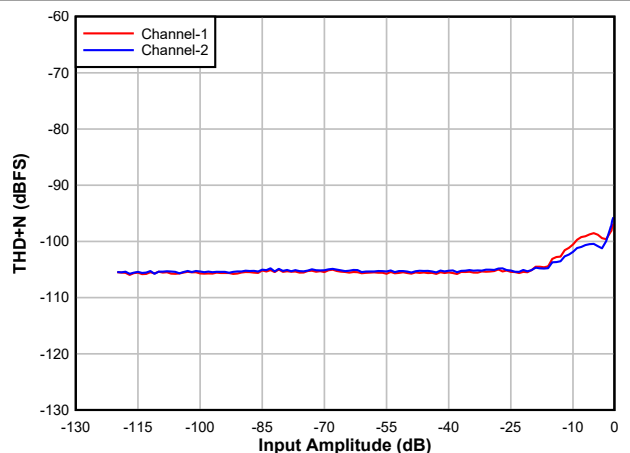

Single-ended output

Figure 6-20. DAC THD+N Level vs Input

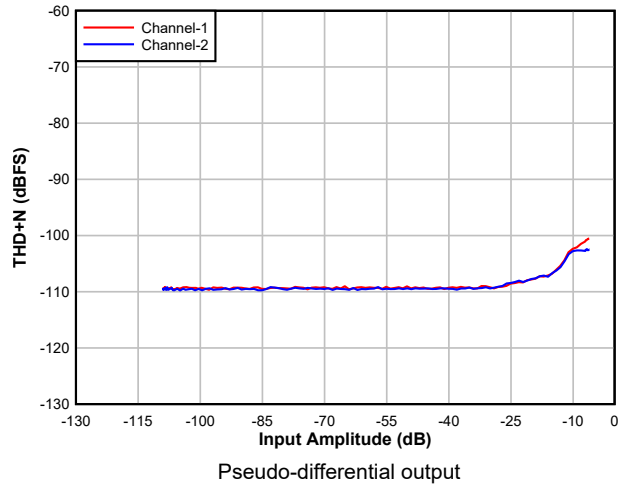

Figure 6-21. DAC THD+N Level vs Input

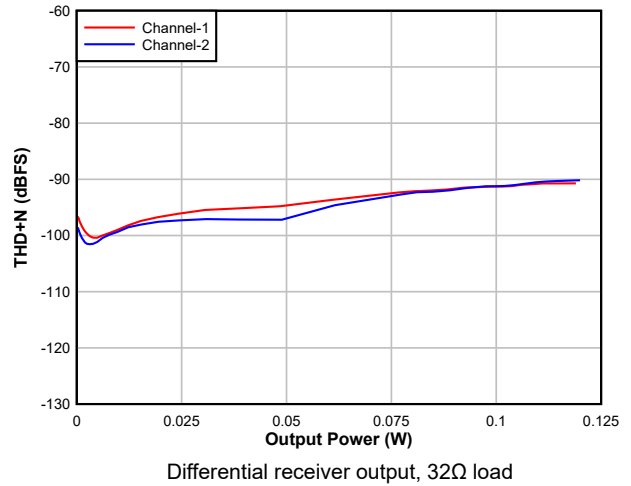

Figure 6-22. DAC THD+N Level vs output power

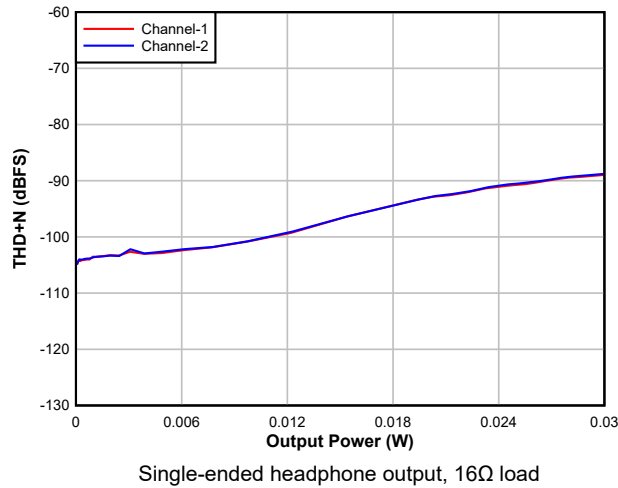

Figure 6-23. DAC THD+N Level vs output power

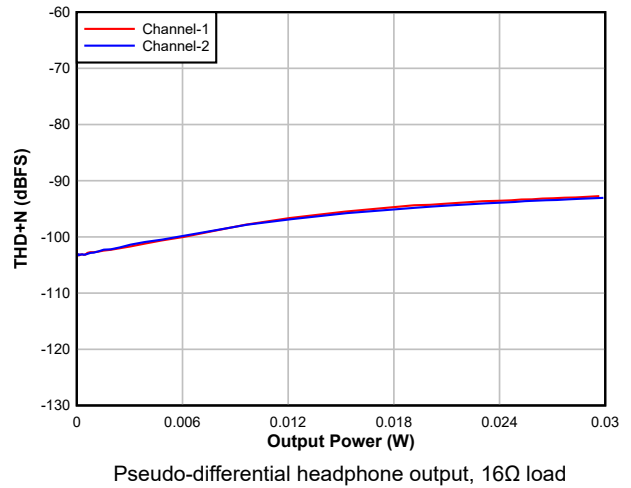

Figure 6-24. DAC THD+N Level vs output power

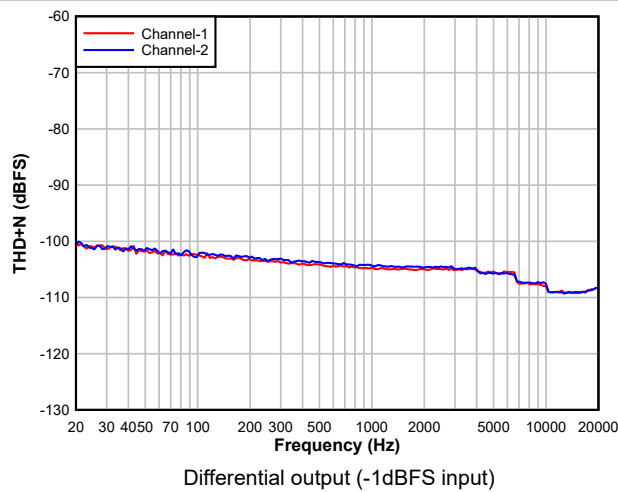

Figure 6-25. DAC THD+N Level vs Frequency

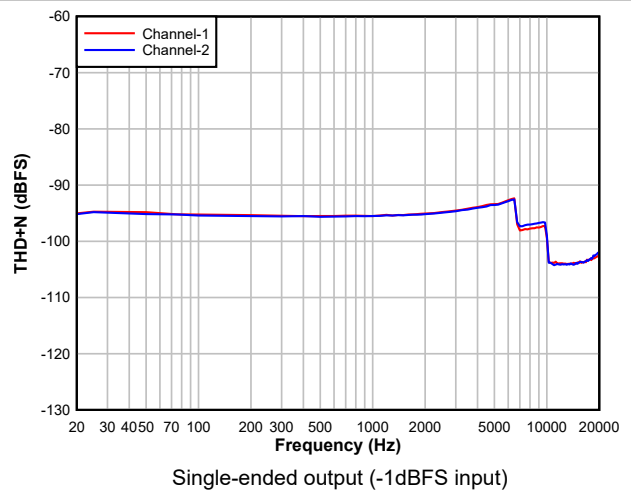
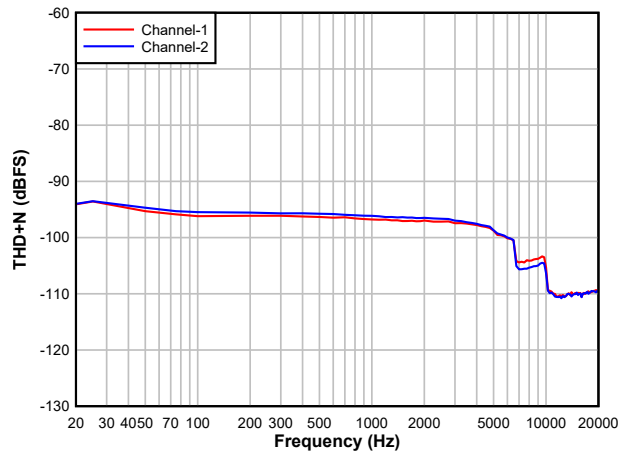
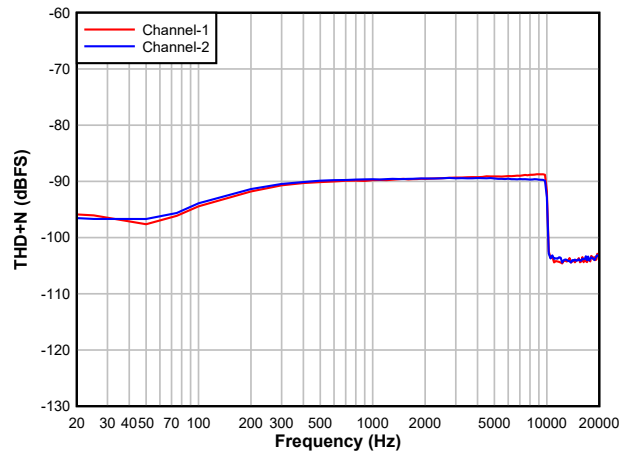

Figure 6-26. DAC THD+N Level vs Frequency



Differential receiver output, 32Ω load (-1dBFS input)

Figure 6-27. DAC THD+N Level vs Frequency



Single-ended headphone output, 16Ω load (-1dBFS input)

Figure 6-28. DAC THD+N Level vs Frequency

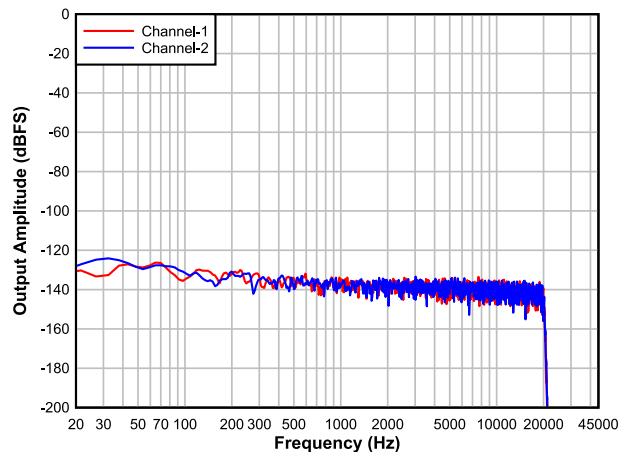

Differential output

Figure 6-29. DAC FFT with Idle Channel Input

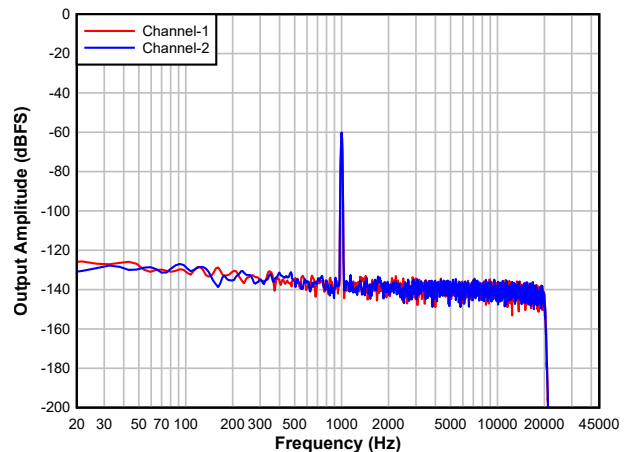

Differential output

Figure 6-30. DAC FFT with -60dBFS Input

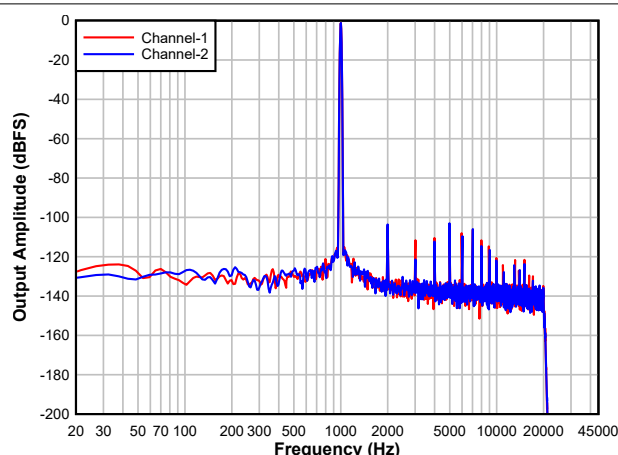

Differential output

Figure 6-31. DAC FFT with -1dBFS Input

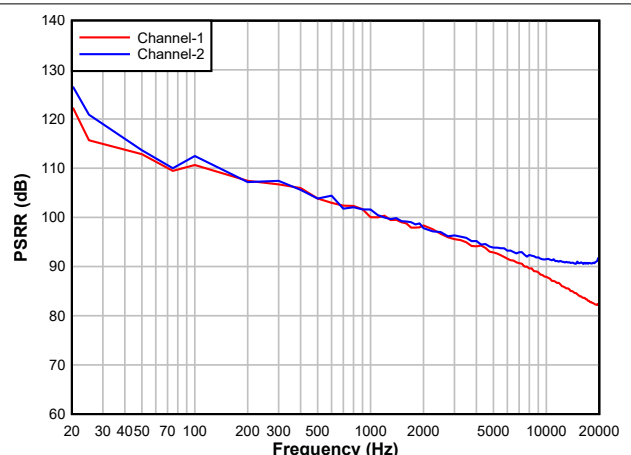

Differential output

Figure 6-32. DAC PSRR vs Frequency

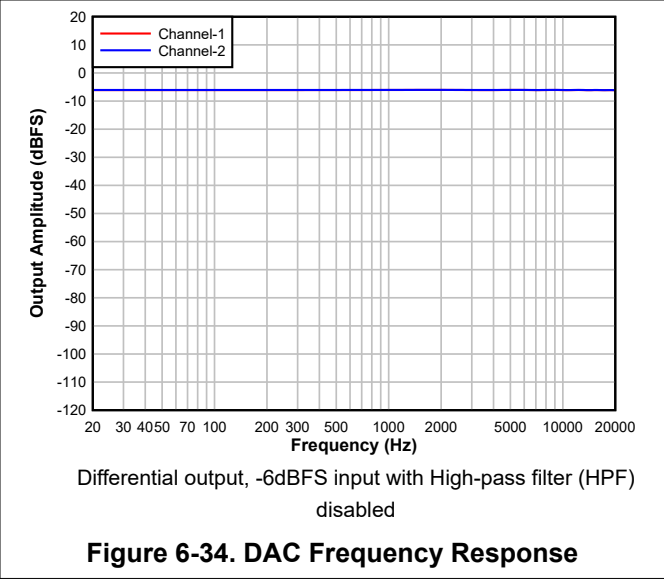
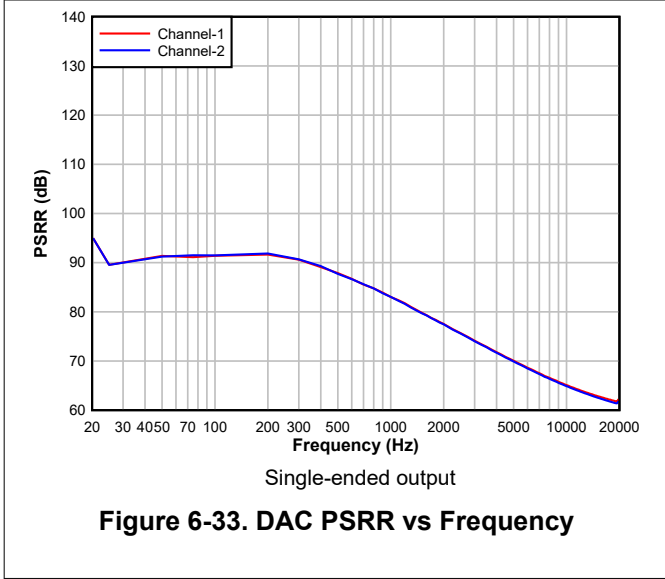

7 Detailed Description

7.1 Overview

The TAC5112 is from a scalable family of audio converter devices. As part of the extended family of devices, the TAC5112 consists of a low-power, flexible, stereo audio analog-to-digital converter (ADC) and audio digital-to-analog converter (DAC) with extensive feature integration. This device is intended for broad market applications such as ruggedized communication equipment, IP network cameras and phones, professional audio and multimedia applications. The high dynamic range of this device enables far-field audio recording and playback with high fidelity. This device integrates a host of features that reduce cost, board space, and power consumption in space-constrained system designs. Package, performance, and compatible configuration registers across extended families make this device well-suited for scalable system designs.

The TAC5112 consists of the following blocks:

- 2-channel, multibit, high-performance delta-sigma ($\Delta\Sigma$) ADCs
- Configurable single-ended or differential audio inputs
- Low-noise programmable microphone bias output
- 4-channel, multibit, high-performance delta-sigma ($\Delta\Sigma$) DACs
- Configurable single-ended, differential, or pseudo-differential audio outputs
- Over current diagnostics and protection for MICBIAS and analog outputs
- Automatic gain controller (AGC) for ADC channels and Dynamic range controller (DRC) for DAC channels
- Advanced thermal foldback and protection
- Advanced battery guard and distortion limiter
- Programmable decimation and interpolation filters with linear-phase, low-latency and ultra low-latency response options
- Programmable channel gain, volume control, and biquad filters for each ADC and DAC channel
- Programmable phase and gain calibration with fine resolution for each ADC channel
- Programmable high-pass filter (HPF) and digital channel mixer for ADC and DAC channels
- Incremental ADC support for DC measurement and low frequency signal monitoring/sensing applications
- Up to 4 pulse density modulation (PDM) digital microphone interface with a high-performance decimation filter
- Dual I²S or TDM interface with independent sample rate (synchronous)
- Synchronous sample rate converter (SRC)
- Integrated low-jitter, phase-locked loop (PLL) supporting a wide range of system clocks
- Integrated digital and analog voltage regulators to support single-supply operation

Communication to the TAC5112 for configuring the control registers is supported using an I²C or SPI interface. The device supports a highly flexible audio serial interface [time-division multiplexing (TDM), I²S, or left-justified (LJ)] to transmit audio data seamlessly in the system across devices.

The TAC5112 can support multiple devices by sharing the common TDM bus across devices. Moreover, the device includes a daisy-chain feature as well. These features relax the shared TDM bus timing requirements and board design complexities when operating multiple devices for applications requiring high audio data bandwidth.

[Table 7-1](#) lists the reference abbreviations used throughout this document to registers that control the device.

Table 7-1. Abbreviations for Register References

REFERENCE	ABBREVIATION	DESCRIPTION	EXAMPLE
Page y, register z, bit k	Py_Rz_D[k]	Single data bit. The value of a single bit in a register.	Page 1, register 36, bit 0 = P1_R36_D[0]
Page y, register z, bits k-m	Py_Rz_D[k:m]	Range of data bits. A range of data bits (inclusive).	Page 1, register 36, bits 3-0 = P1_R36_D[3:0]
Page y, register z	Py_Rz	One entire register. All eight bits in the register as a unit.	Page 1, register 36 = P1_R36
Page y, registers z-n	Py_Rz-Rn	Range of registers. A range of registers in the same page.	Page 1, registers 36, 37, 38 = P1_R36-R38

7.2 Functional Block Diagram

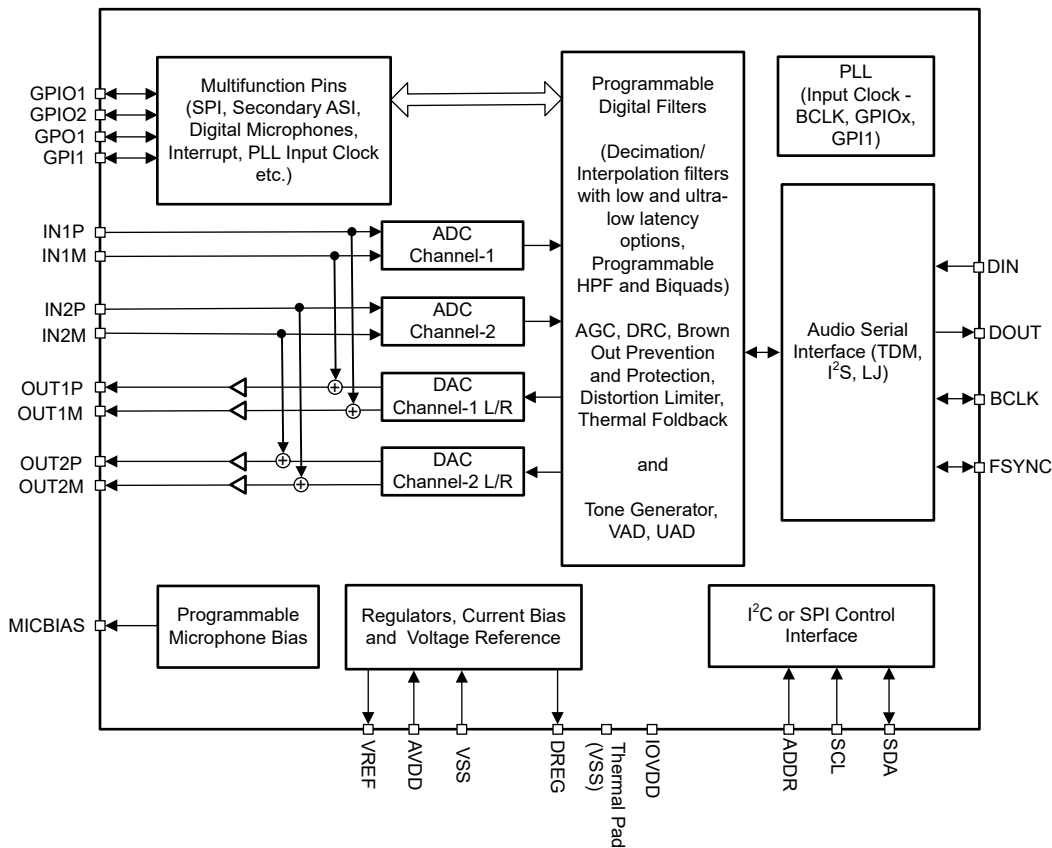

Figure 7-1. Functional Block Diagram

7.3 Feature Description

7.3.1 Serial Interfaces

This device has two serial interfaces: control and audio data. The control serial interface is used for device configuration. The audio data serial interface is used for transmitting audio data to the host device.

7.3.1.1 Control Serial Interfaces

The device contains configuration registers and programmable coefficients that can be set to the desired values for a specific system and application use. All these registers can be accessed using either I²C or SPI communication to the device. For more information, see [Section 7.5](#) and [Section 8](#).

7.3.1.2 Audio Serial Interfaces

Digital audio data flows between the host processor and the TAC5112 on the digital audio serial interface (ASI), or audio bus. This highly flexible ASI bus includes a TDM mode for multichannel operation, support for I²S or left-justified protocols format, programmable data length options, very flexible controller-target configurability for bus clock lines, and the ability to communicate with multiple devices within a system directly.

The TAC5112 supports up to two ASI Interfaces. Secondary ASI Clock and Data Pins can be configured by setting GPIO's. Frame Sync of two ASI's must be synchronous. See the [TAX5X1X Synchronous Sample Rate Conversion application report](#) for more details on Secondary ASI.

The bus protocol TDM, I²S, or left-justified (LJ) format can be selected for primary ASI by using the PASI_FORMAT[1:0] (P0_R26_D[7:6]) register bits. As shown in [Table 7-2](#) and [Table 7-3](#), these modes are all most significant byte (MSB)-first, pulse code modulation (PCM) data format, with the output channel data word-length programmable as 16, 20, 24, or 32 bits by configuring the PASI_WLEN[1:0] (P0_R26_D[5:4]) register bits.

Table 7-2. Primary Audio Serial Interface Format

P0_R26_D[7:6] : PASI_FORMAT[1:0]	PRIMARY AUDIO SERIAL INTERFACE FORMAT
00 (default)	Time-division multiplexing (TDM) mode
01	Inter IC sound (I ² S) mode
10	Left-justified (LJ) mode
11	Reserved (do not use this setting)

Table 7-3. Primary Audio Serial Interface Data Word-Length

P0_R26_D[5:4] : PASI_WLEN[1:0]	PRIMARY AUDIO OUTPUT CHANNEL DATA WORD-LENGTH
00	Data word-length set to 16 bits
01	Data word-length set to 20 bits
10	Data word-length set to 24 bits
11 (default)	Data word-length set to 32 bits

The frame sync pin, FSYNC, is used in this audio bus protocol to define the beginning of a frame and has the same frequency as the output data sample rates. The bit clock pin, BCLK, is used to clock out the digital audio data across the serial bus. The number of bit-clock cycles in a frame must accommodate multiple device active output channels with the programmed data word length.

A frame consists of multiple time-division channel slots (up to 32) to allow all input/output channel audio data transmissions to be completed on the audio bus by a device or multiple devices sharing the same audio bus. The device supports up to eight input channels and eight output channels that can be configured on the primary ASI bus to place their audio data on bus slot 0 to slot 31. [Table 7-4](#) lists the output channel-1 slot configuration settings. In I²S and LJ mode, the slots are divided into two sets, left-channel slots, and right-channel slots, as described in [Section 7.3.1.2.2](#) and [Section 7.3.1.2.3](#).

Table 7-4. Output Channel-1 Slot Assignment Settings

P0_R30_D[4:0] : PASI_TX_CH1_SLOT[4:0]	OUTPUT CHANNEL 1 SLOT ASSIGNMENT
0 0000 = 0d (default)	Slot 0 for TDM or left slot 0 for I ² S, LJ.
0 0001 = 1d	Slot 1 for TDM or left slot 1 for LJ.
...	...
0 1111 = 15d	Slot 15 for TDM or left slot 15 for LJ.
1 0000 = 16d	Slot 16 for TDM or right slot 0 for I ² S, LJ.
...	...
1 1110 = 30d	Slot 30 for TDM or right slot 14 for LJ.
1 1111 = 31d	Slot 31 for TDM or right slot 15 for LJ.

Similarly, the slot assignment setting for output channel 2 to channel 8 can be done using the PASI_TX_CH2_SLOT_NUM (P0_R31_D[4:0]) to PASI_TX_CH8_SLOT_NUM (P0_R37) registers and for input channel 1 to channel 8 by using the PASI_RX_CH1_SLOT (P0_R40) to PAS_RX_CH8_SLOT (P0_R47_D[4:0]) registers, respectively.

The slot word length is the same as the primary ASI channel word length set for the device. The output channel data word length must be set to the same value for all TAC5112 devices if all devices share the same ASI bus in a system. The maximum number of slots possible for the ASI bus in a system is limited by the available bus

bandwidth, which depends upon the BCLK frequency, output data sample rate used, and the channel data word length configured.

The device also includes a feature that offsets the start of the slot data transfer concerning the frame sync by up to 31 cycles of the bit clock. Offset can be configured independently for input and output data paths. [Table 7-5](#) and [Table 7-6](#) lists the programmable offset configuration settings for transmission and receive paths respectively.

Table 7-5. Programmable Offset Settings for the ASI Slot Start for transmission

P0_R28_D[4:0] : PASI_TX_OFFSET[4:0]	PROGRAMMABLE OFFSET SETTING FOR SLOT DATA TRANSMISSION START
0 0000 = 0d (default)	The device follows the standard protocol timing without any offset.
0 0001 = 1d	Slot start is offset by one BCLK cycle, as compared to standard protocol timing. For I ² S or LJ, the left and right slot start is offset by one BCLK cycle, as compared to standard protocol timing.
.....
1 1110 = 30d	Slot start is offset by 30 BCLK cycles, as compared to standard protocol timing. For I ² S or LJ, the left and right slot start is offset by 30 BCLK cycles, as compared to standard protocol timing.
1 1111 = 31d	Slot start is offset by 31 BCLK cycles, as compared to standard protocol timing. For I ² S or LJ, the left and right slot start is offset by 31 BCLK cycles, as compared to standard protocol timing.

Table 7-6. Programmable Offset Settings for the ASI Slot Start for Receive

P0_R38_D[4:0] : PASI_RX_OFFSET[4:0]	PROGRAMMABLE OFFSET SETTING FOR SLOT DATA RECEIVE START
0 0000 = 0d (default)	The device follows the standard protocol timing without any offset.
0 0001 = 1d	Slot start is offset by one BCLK cycle, as compared to standard protocol timing. For I ² S or LJ, the left and right slot start is offset by one BCLK cycle, as compared to standard protocol timing.
.....
1 1110 = 30d	Slot start is offset by 30 BCLK cycles, as compared to standard protocol timing. For I ² S or LJ, the left and right slot start is offset by 30 BCLK cycles, as compared to standard protocol timing.
1 1111 = 31d	Slot start is offset by 31 BCLK cycles, as compared to standard protocol timing. For I ² S or LJ, the left and right slot start is offset by 31 BCLK cycles, as compared to standard protocol timing.

The device also features the ability to invert the polarity of the frame sync pin, FSYNC, used to transfer the audio data as compared to the default FSYNC polarity used in standard protocol timing. This feature can be set using the PASI_FSYNC_POL (P0_R26_D[3]) register bit. Similarly, the device can invert the polarity of the bit clock pin, BCLK, which can be set using the PASI_BCLK_POL (P0_R26_D[2]) register bit.

In addition, the word clock and bit clock can be independently configured in either controller or target mode, for flexible connectivity to a wide variety of processors. The word clock is used to define the beginning of a frame and may be programmed as either a pulse or a square-wave signal. The frequency of this clock corresponds to the maximum of the selected ADC and DAC sampling frequencies.

7.3.1.2.1 Time Division Multiplexed Audio (TDM) Interface

In TDM mode, also known as DSP mode, the rising edge of FSYNC starts the data transfer with the slot 0 data first. Immediately after the slot 0 data transmission, the remaining slot data are transmitted in order. FSYNC and each data bit (except the MSB of slot 0 when TX_OFFSET equals 0) is transmitted on the rising edge of BCLK. [Figure 7-2](#) to [Figure 7-5](#) illustrate the protocol timing for TDM operation with various configurations for transmit DOUT line. The same protocol is applicable for the receive DIN line as well.

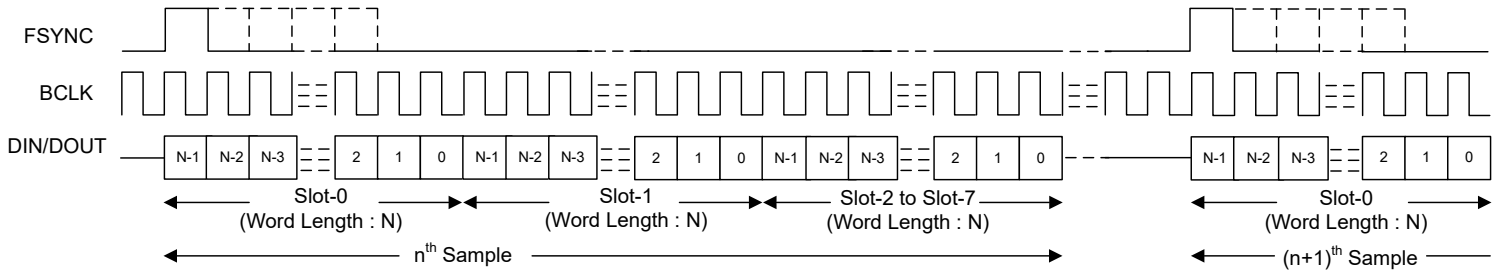

Figure 7-2. TDM Mode Standard Protocol Timing ($PASI_TX_OFFSET = 0$)

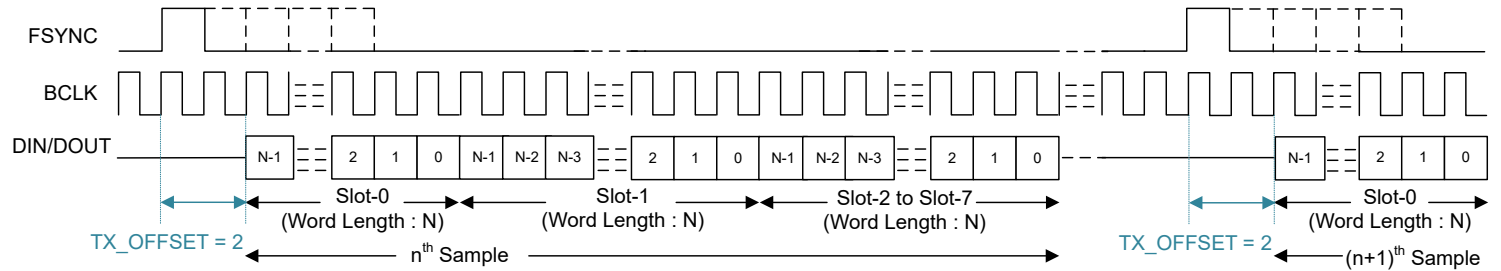

Figure 7-3. TDM Mode Protocol Timing ($PASI_TX_OFFSET = 2$)

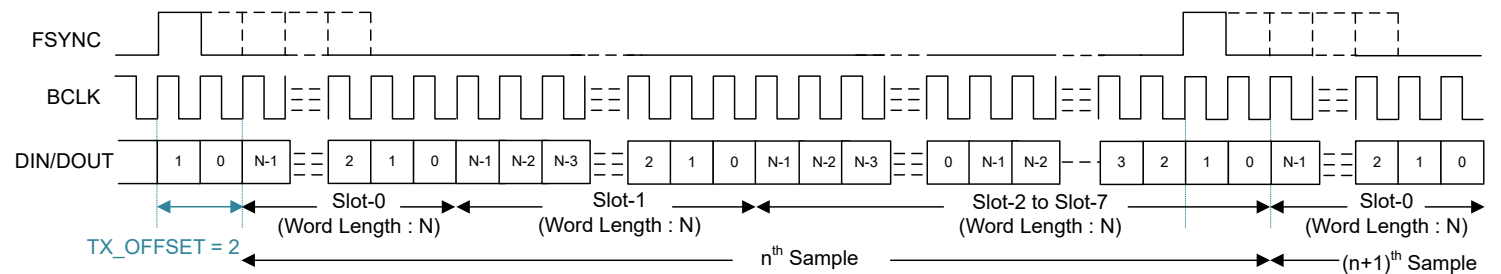

Figure 7-4. TDM Mode Protocol Timing (No Idle BCLK Cycles, $PASI_TX_OFFSET = 2$)

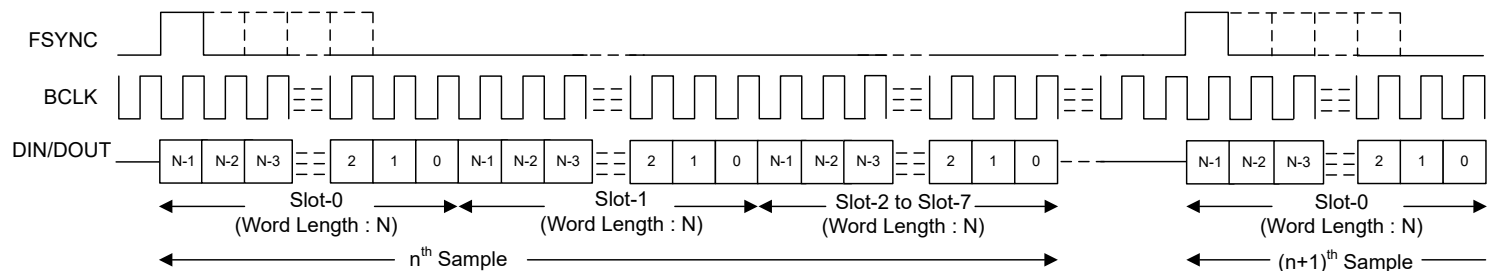

Figure 7-5. TDM Mode Protocol Timing ($PASI_TX_OFFSET = 0$ and $PASI_BCLK_POL = 1$)

For proper operation of the audio bus in TDM mode, the number of bit clocks per frame must be greater than or equal to the number of active output channels times the programmed word length of the output channel data. The device supports FSYNC as a pulse with a 1-cycle-wide bit clock but also supports multiples as well. For a higher BCLK frequency operation, using TDM mode with a $PASI_TX_OFFSET$ value higher than 0 is recommended.

7.3.1.2.2 Inter IC Sound (I^2S) Interface

The standard I^2S protocol is defined for only two channels: left and right. The device extends the same protocol timing for multichannel operation. In I^2S mode, the MSB of the left slot 0 is transmitted on the falling edge of BCLK in the second cycle after the falling edge of FSYNC. Immediately after the left slot 0 data transmission, the remaining left slot data are transmitted in order. The MSB of the right slot 0 is transmitted on the falling edge of

BCLK in the second cycle after the *rising* edge of FSYNC. Immediately after the right slot 0 data transmission, the remaining right slot data are transmitted in order. FSYNC and each data bit is transmitted on the falling edge of BCLK. Figure 7-6 to Figure 7-9 illustrate the protocol timing for I²S operation with various configurations for the transmit DOUT line. The same protocol is applicable for the receive DIN line as well.

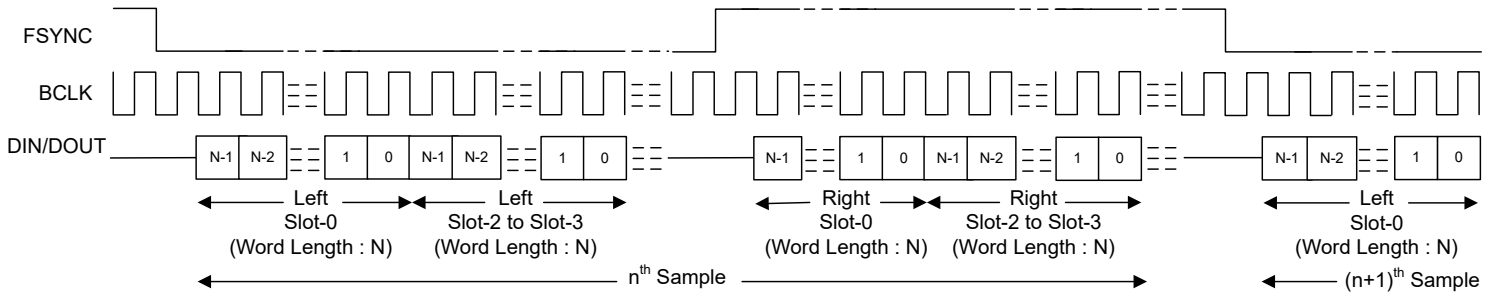

Figure 7-6. I²S Mode Standard Protocol Timing (PASI_TX_OFFSET = 0)

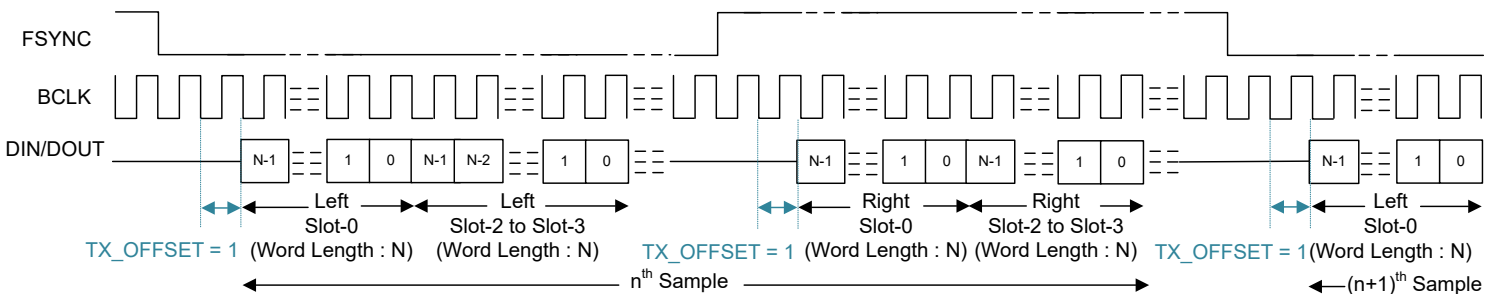

Figure 7-7. I²S Protocol Timing (PASI_TX_OFFSET = 1)

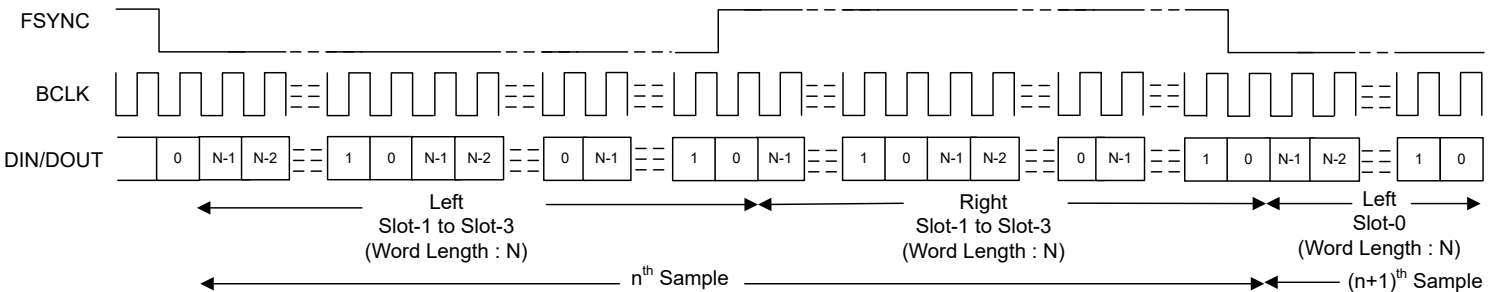

Figure 7-8. I²S Protocol Timing (No Idle BCLK Cycles, PASI_TX_OFFSET = 0)

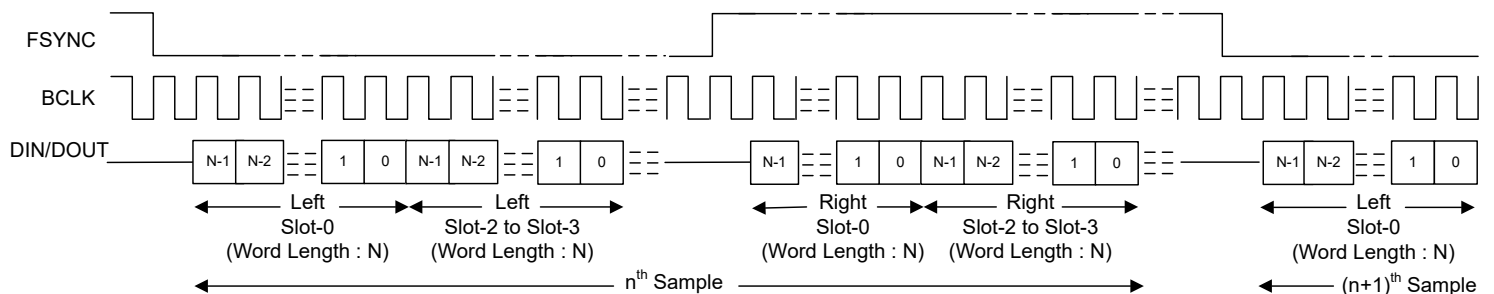

Figure 7-9. I²S Protocol Timing (PASI_TX_OFFSET = 0 and PASI_BCLK_POL = 1)

For proper operation of the audio bus in I²S mode, the number of bit clocks per frame must be greater than or equal to the number of active output channels (including left and right slots) times the programmed word length of the output channel data. The device FSYNC low pulse must be several BCLK cycles wide that is greater than

or equal to the number of active left slots times the data word length configured. Similarly, the FSYNC high pulse must be several BCLK cycles wide that is greater than or equal to the number of active right slots times the data word length configured.

7.3.1.2.3 Left-Justified (LJ) Interface

The standard LJ protocol is defined for only two channels: left and right. The device extends the same protocol timing for multichannel operation. In LJ mode, the MSB of the left slot 0 is transmitted in the same BCLK cycle after the rising edge of FSYNC. Each subsequent data bit is transmitted on the falling edge of BCLK. Immediately after the left slot 0 data transmission, the remaining left slot data are transmitted in order. The MSB of the right slot 0 is transmitted in the same BCLK cycle after the falling edge of FSYNC. Each subsequent data bit is transmitted on the falling edge of BCLK. Immediately after the right slot 0 data transmission, the remaining right slot data are transmitted in order. FSYNC is transmitted on the falling edge of BCLK. Figure 7-10 to Figure 7-13 illustrate the protocol timing for LJ operation with various configurations for the transmit DOUT line. The same protocol is applicable for the receive DIN line as well.

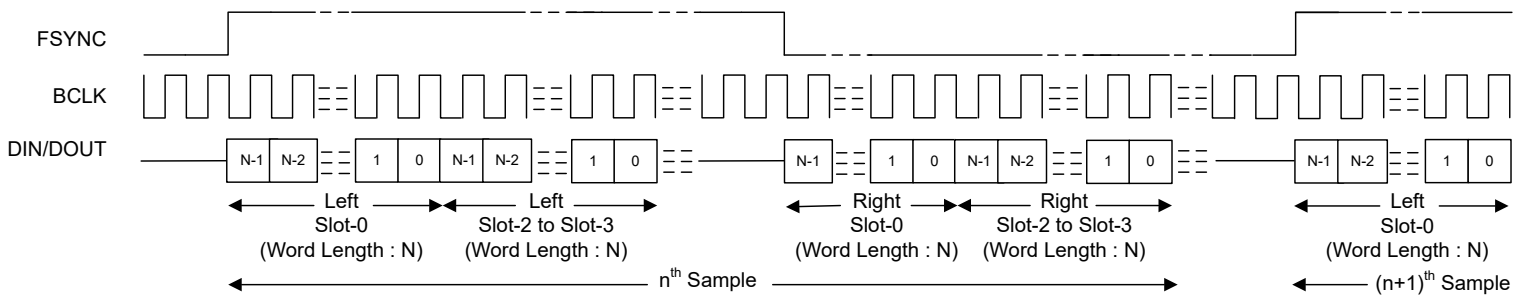

Figure 7-10. LJ Mode Standard Protocol Timing (TX_OFFSET = 0)

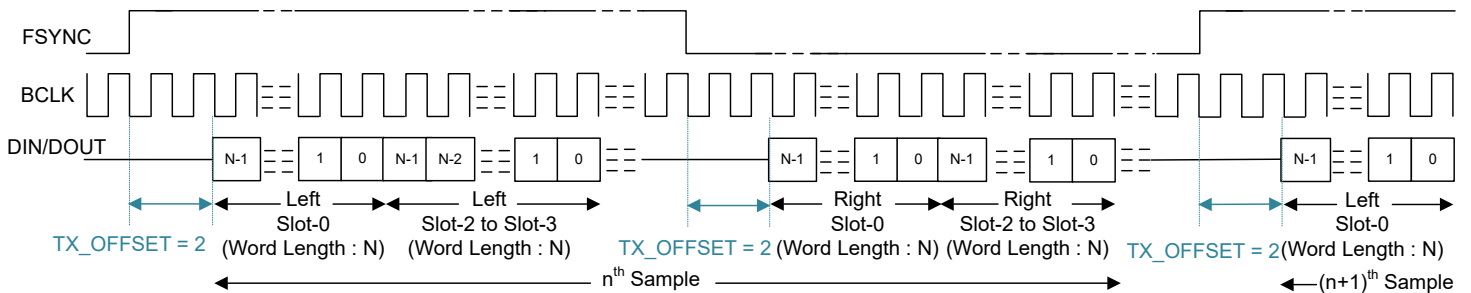

Figure 7-11. LJ Protocol Timing (TX_OFFSET = 2)

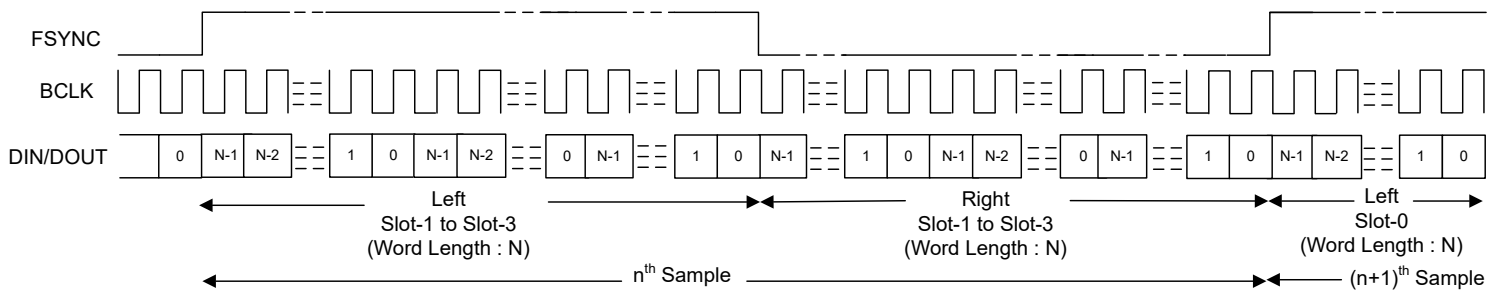

Figure 7-12. LJ Protocol Timing (No Idle BCLK Cycles, TX_OFFSET = 0)

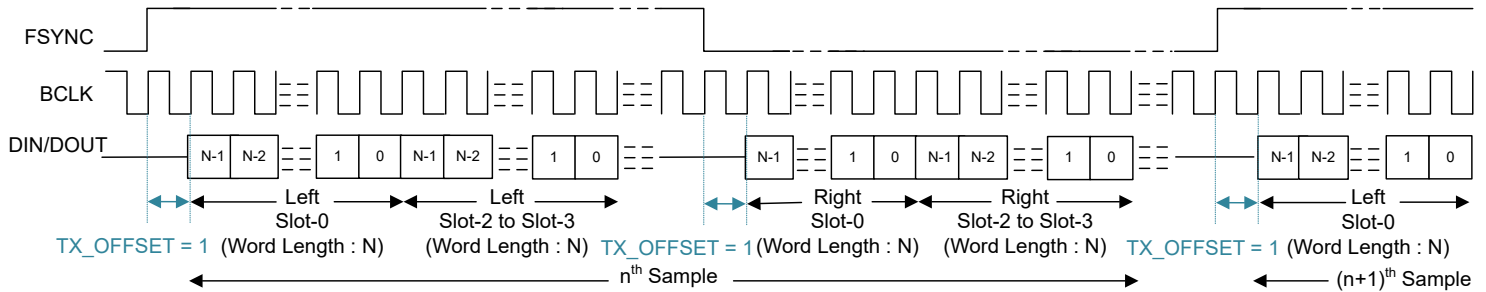

Figure 7-13. LJ Protocol Timing (TX_OFFSET = 1 and BCLK_POL = 1)

For proper operation of the audio bus in LJ mode, the number of bit clocks per frame must be greater than or equal to the number of active output channels (including left and right slots) times the programmed word length of the output channel data. The device FSYNC high pulse must be several BCLK cycles wide that is greater than or equal to the number of active left slots times the data word length configured. Similarly, the FSYNC low pulse must be several BCLK cycles wide that is greater than or equal to the number of active right slots times the data word length configured. For a higher BCLK frequency operation, using LJ mode with a TX_OFFSET value higher than 0 is recommended.

7.3.1.3 Using Multiple Devices With Shared Buses

The device has many supported features and flexible options that can be used in the system to seamlessly connect multiple TAC5112 devices by sharing a single common I²C or SPI control bus and an audio serial interface bus. This architecture enables multiple applications to be applied to a system that require a microphone or speaker array for beam-forming operation, audio conferencing, noise cancellation, and so forth. [Figure 7-14](#) shows a diagram of multiple TAC5112 devices in a configuration where the control and audio data buses are shared.

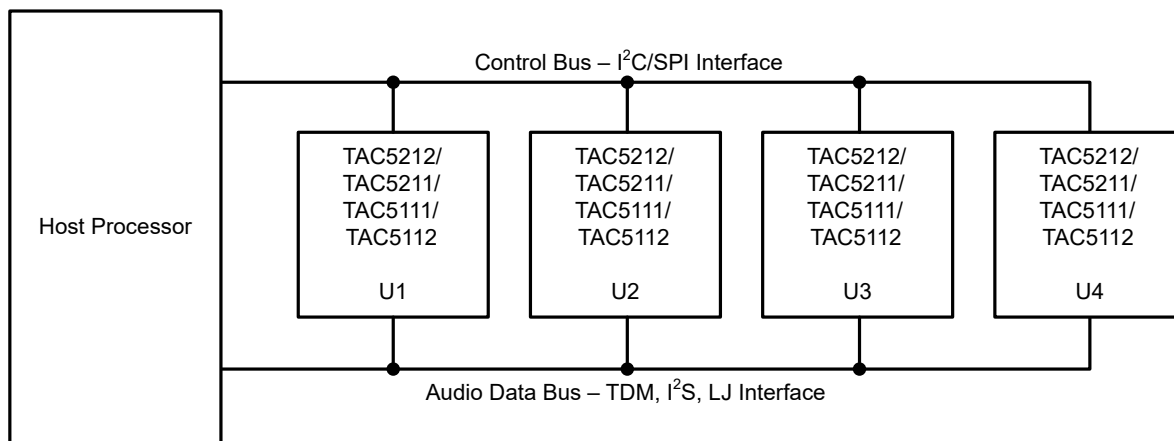

Figure 7-14. Multiple TAC5112 Devices With Shared Control and Audio Data Buses

The TAC5112 consists of the following features to enable seamless connection and interaction of multiple devices using a shared bus:

- Supports up to four pin-programmable I²C target addresses
- I²C broadcast simultaneously writes to (or triggers) all TAC5112 devices
- Supports up to 32 configuration input/output channel slots for the audio serial interface
- Tri-state feature (with enable and disable) for the unused audio data slots of the device
- Supports a bus-holder feature (with enable and disable) to keep the last driven value on the audio bus
- The GPIOx, GPI1 or GPO1 pin can be configured as a secondary input/output data lane or as a secondary audio serial interface
- The GPIOx, GPI1 or GPO1 pin can be used in a daisy-chain configuration of multiple TAC5112 devices

- Supports one BCLK cycle data latching timing to relax the timing requirement for the high-speed interface
- Programmable controller and target options for both primary and secondary audio serial interface
- Ability to synchronize the multiple devices for the simultaneous sampling requirement across devices
- Inter Channel Gain Alignment (ICGA) feature to align the DAC Channel gain across devices.

See the [Multiple TAC5x1x Devices With a Shared TDM and I²C/SPI Bus application report](#) for further details.

7.3.2 Phase-Locked Loop (PLL) and Clock Generation

The device has a smart auto-configuration block to generate all necessary internal clocks required for the ADC and DAC modulators and the digital filter engine used for signal processing. This configuration is done by monitoring the frequency of the FSYNC and BCLK signals on the audio buses.

The device supports the various data sample rates (of the FSYNC signal frequency) and the BCLK to FSYNC ratio to configure all clock dividers, including the PLL configuration, internally without host programming. [Table 7-7](#) and [Table 7-8](#) list the supported FSYNC and BCLK frequencies.

Table 7-7. Supported FSYNC (Multiples or Submultiples of 48 kHz) and BCLK Frequencies

BCLK TO FSYNC RATIO	BCLK (MHz)									
	FSYNC (4 kHz)	FSYNC (8 kHz)	FSYNC (16 kHz)	FSYNC (24 kHz)	FSYNC (32 kHz)	FSYNC (48 kHz)	FSYNC (96 kHz)	FSYNC (192 kHz)	FSYNC (384 kHz)	FSYNC (768 kHz)
16	Reserved	Reserved	0.256	0.384	0.512	0.768	1.536	3.072	6.144	12.288
24	Reserved	Reserved	0.384	0.576	0.768	1.152	2.304	4.608	9.216	18.432
32	Reserved	0.256	0.512	0.768	1.024	1.536	3.072	6.144	12.288	24.576
48	Reserved	0.384	0.768	1.152	1.536	2.304	4.608	9.216	18.432	Reserved
64	0.256	0.512	1.024	1.536	2.048	3.072	6.144	12.288	24.576	Reserved
96	0.384	0.768	1.536	2.304	3.072	4.608	9.216	18.432	Reserved	Reserved
128	0.512	1.024	2.048	3.072	4.096	6.144	12.288	24.576	Reserved	Reserved
192	0.768	1.536	3.072	4.608	6.144	9.216	18.432	Reserved	Reserved	Reserved
256	1.024	2.048	4.096	6.144	8.192	12.288	24.576	Reserved	Reserved	Reserved
384	1.536	3.072	6.144	9.216	12.288	18.432	Reserved	Reserved	Reserved	Reserved
512	2.048	4.096	8.192	12.288	16.384	24.576	Reserved	Reserved	Reserved	Reserved
1024	4.096	8.192	16.384	24.576	Reserved	Reserved	Reserved	Reserved	Reserved	Reserved
2048	8.192	16.384	Reserved	Reserved	Reserved	Reserved	Reserved	Reserved	Reserved	Reserved

Table 7-8. Supported FSYNC (Multiples or Submultiples of 44.1 kHz) and BCLK Frequencies

BCLK TO FSYNC RATIO	BCLK (MHz)									
	FSYNC (7.35 kHz)	FSYNC (7.35 kHz)	FSYNC (14.7 kHz)	FSYNC (22.05 kHz)	FSYNC (29.4 kHz)	FSYNC (44.1 kHz)	FSYNC (88.2 kHz)	FSYNC (176.4 kHz)	FSYNC (352.8 kHz)	FSYNC (705.6 kHz)
16	Reserved	Reserved	Reserved	0.3528	0.4704	0.7056	1.4112	2.8224	5.6448	11.2896
24	Reserved	Reserved	0.3528	0.5292	0.7056	1.0584	2.1168	4.2336	8.4672	16.9344
32	Reserved	Reserved	0.4704	0.7056	0.9408	1.4112	2.8224	5.6448	11.2896	22.5792
48	0.3528	0.3528	0.7056	1.0584	1.4112	2.1168	4.2336	8.4672	16.9344	Reserved
64	0.4704	0.4704	0.9408	1.4112	1.8816	2.8224	5.6448	11.2896	22.5792	Reserved
96	0.7056	0.7056	1.4112	2.1168	2.8224	4.2336	8.4672	16.9344	Reserved	Reserved
128	0.9408	0.9408	1.8816	2.8224	3.7632	5.6448	11.2896	22.5792	Reserved	Reserved
192	1.4112	1.4112	2.8224	4.2336	5.6448	8.4672	16.9344	Reserved	Reserved	Reserved
256	1.8816	1.8816	3.7632	5.6448	7.5264	11.2896	22.5792	Reserved	Reserved	Reserved
384	2.8224	2.8224	5.6448	8.4672	11.2896	16.9344	Reserved	Reserved	Reserved	Reserved
512	3.7632	3.7632	7.5264	11.2896	15.0528	22.5792	Reserved	Reserved	Reserved	Reserved
1024	7.5264	7.5264	15.0528	22.5792	Reserved	Reserved	Reserved	Reserved	Reserved	Reserved
2048	15.0528	15.0528	Reserved	Reserved	Reserved	Reserved	Reserved	Reserved	Reserved	Reserved

The TAC5112 also supports non-Audio sample rates beyond those listed in prior tables. Refer to [Clocking Configuration of Device and Flexible Clocking For TAx5x1x Family application report](#) for more details.

The TAC5112 sample rate can be configured using registers CLK_CFG0 (P0_R50) and CLK_CFG1 (P0_R51) for primary and secondary ASI respectively. CLK_DET_STS0 (P0_R62) and CLK_DET_STS1 (P0_R63)

registers also capture the device auto detect result for the FSYNC frequency in auto detection mode for the primary and secondary ASI respectively. The registers CLK_DET_STS2 (P0_R64) and CLK_DET_STS3 (P0_R65) capture the BCLK to FSYNC ratio detected by the device in the auto detection mode for the selected ASI which is chosen to be the PLL reference through the CLK_SRC_SEL (P0_R52_D[3:1]) registers. If the device finds any unsupported combinations of FSYNC frequency and BCLK to FSYNC ratios, the device generates an ASI clock-error interrupt and shuts down various blocks of the device accordingly.

The TAC5112 also supports enabling channels while ADC or DAC channels are already in operation. This requires a pre-configuration before power to describe the maximum number of channels that can be enabled while in operation to ensure proper clock generation and use. This can be configured by using register DYN_PUPD_CFG (P0_R119). ADC_DYN_PUPD_EN (P0_R119_D[7]) and DAC_DYN_PUPD_EN (P0_R119_D[5]) bits can be used to independently enable ADC or DAC Channels' dynamic power up. Number of maximum channels supported for dynamic power-up and power-down can be configured using ADC_DYN_MAXCH_SEL (P0_R119_D[6]) and DAC_DYN_MAXCH_SEL (P0_R119_D[4]) bits.

The device uses an integrated, low-jitter, phase-locked loop (PLL) to generate internal clocks required for the modulators and digital filter engine, as well as other control blocks. The device also supports an option to use BCLK, GPIOx, or the GPI1 pin (as CCLK) as the audio clock source without using the PLL to reduce power consumption. However, the ADC performance may degrade based on jitter from the external clock source, and some processing features may not be supported if the external audio clock source frequency is not high enough. Therefore, TI recommends using the PLL for high-performance applications. More details and information on how to configure and use the device in low-power mode without using the PLL are discussed in the [TAC5x1x Power Consumption Matrix Across Various Usage Scenarios application report](#).

The device also supports an audio bus controller mode operation using the GPIOx or GPI1 pin (as CCLK) as the reference input clock source and supports various flexible options and a wide variety of system clocks. More details and information on controller mode configuration and operation are discussed in the [Clocking Configuration of Device and Flexible Clocking For TAx5x1x Family application report](#).

The audio bus clock error detection and auto-detect feature automatically generates all internal clocks, but can be disabled using the IGNORE_CLK_ERR (P0_R4_D[6]) and CUSTOM_CLK_CFG (P0_R50_D[0]) register bits, respectively. In the system, this disable feature can be used to support custom clock frequencies that are not covered by the auto detect scheme. For such application use cases, care must be taken to ensure that the multiple clock dividers are all configured appropriately. TI recommends using the PPC3 GUI for device configuration settings; for more details see the [TAC5212EVM-PDK Evaluation module user's guide](#) and the [PurePath™ console graphical development suite](#). The [Clocking Configuration of Device and Flexible Clocking For TAx5x1x Family application report](#) also covers various aspects of the custom clock configurations. Refer [Clock Error Configuration, Detection, and Modes Supported in TAx5x1x Family application report](#) for more details about the clock detection module of the device.

When the PLL is turned off, the digital volume control and other features using programmable coefficients like biquads, mixer, AGC etc., except the high pass filter (HPF) are not applicable.

7.3.3 Input Channel Configurations

The TAC5112 consists of two pairs of analog input pins (INxP and INxM) that can be configured as differential inputs or single-ended inputs for the recording channel. The device supports simultaneous recording of up to two analog channels using the high-performance multichannel ADC. The input source for the analog pins can be from electret condenser analog microphones, microelectrical-mechanical system (MEMS) analog microphones, or line-in (auxiliary) inputs from the system board. Analog inputs support differential input, single-ended inputs (two pin and one-pin) with AC and DC coupling options. [Table 7-9](#) shows the input source selection for the record channel 1.

Table 7-9. Input Source Selection for the Record Channel

P0_R80_D[7:6] : ADC_CH1_INSRC[1:0]	INPUT CHANNEL 1 RECORD SOURCE SELECTION
00 (default)	Analog differential input for channel 1 using IN1P and IN1M
01	Analog single-ended input for channel 1 using IN1P and IN1M (signal on one input pin and ground on other pin)

Table 7-9. Input Source Selection for the Record Channel (continued)

P0_R80_D[7:6] : ADC_CH1_INSRC[1:0]	INPUT CHANNEL 1 RECORD SOURCE SELECTION
10	Analog single-ended input on IN1P
11	Analog single-ended Input on IN1M

Similarly, the input source selection setting for input channel 2 can be configured using the ADC_CH2_INSRC[1:0] (P0_R85_D[7:6]) register bits.

Typically, voice or audio signal inputs are capacitively coupled (AC-coupled) to the device and the common-mode variation at the device input is limited to less than 100mVpp for differential inputs for best performance. However, for applications that cannot avoid large common-mode fluctuations or when needed to save board space, the device also supports options for increasing the common mode tolerance and for DC-coupled inputs. This configuration can be done independently for each channel by setting the input common mode tolerance in ADC_CH1_CM_TOL (P0_R80_D[3:2]) and ADC_CH2_CM_TOL (P0_R85_D[3:2]) register bits. [Table 7-10](#) shows these options for Channel 1. Setting higher common mode tolerance offers improved CMRR performance at the expense of noise performance by a few decibels.

Table 7-10. Common-Mode Tolerance Mode Selection for Record Channel

P0_R80_D[3:2] : ADC_CH1_CM_TOL[1:0]	CHANNEL 1 INPUT COMMON-MODE TOLERANCE
00 (default)	AC-coupled input with common mode variance tolerance of 50mVpp for single-ended and 100mVpp for differential configuration
01	AC-coupled / DC-coupled input with common mode variance tolerance supported 500mVpp for single-ended and 1Vpp for differential configuration
10	AC-coupled / DC-coupled input with common mode variance tolerance supported rail to rail (supply to ground) (High CMRR tolerance mode)
11	Reserved (do not use this setting)

Table 7-11. Input Common Mode Tolerance for the Record Channel

P0_R80_D[3:2] : ADC_CH1_CM_TOL[1:0]	INPUT CHANNEL 1 COMMON MODE TOLERANCE
00 (default)	AC-coupled input with common mode variance tolerance supported 50mVpp for single ended and 100mVpp for differential configuration
01	AC-coupled / DC-coupled input with common mode variance tolerance supported 500mVpp for single ended and 1Vpp for differential configuration
10	AC-coupled / DC-coupled input with common mode variance tolerance supported rail to rail (supply to ground) (High CMRR tolerance mode)
11	Reserved

See [Figure 7-15](#) to [Figure 7-20](#) for the various typical input configuration diagrams. For single-ended inputs, the INxM pin can be directly grounded in DC-coupled configuration, but the INxM pin must be grounded after the AC-coupling capacitor in the AC-coupled configuration. For the best dynamic range performance, the differential AC-coupled input setting should be used and the common-mode variation at the device input should be limited to less than 100mVpp. For more details, refer [Analog Input Configurations, Mixing and Muxing of TAx5x1x Devices application report](#).

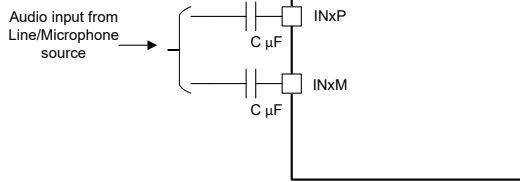

Figure 7-15. Differential AC-Coupled Input Connection (ADC_CHx_INSRC set to 2'b00 and ADC_CHx_CM_TOL set to 2'b00 or 2'b01 or 2'10)

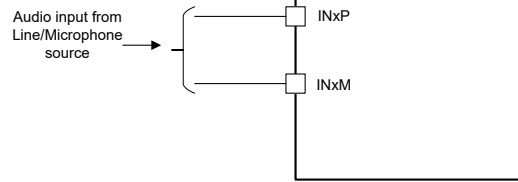

Figure 7-16. Differential DC-Coupled Input Connection (ADC_CHx_INSRC set to 2'b00 and ADC_CHx_CM_TOL set to 2'b01 or 2'10)

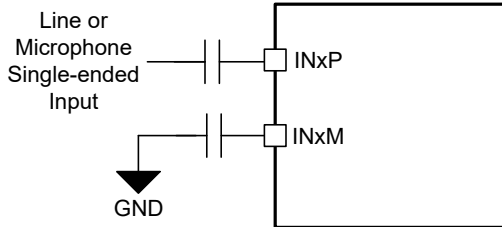

Figure 7-17. Single-ended AC-Coupled Input Connection (ADC_CHx_INSRC set to 2'b01 and ADC_CHx_CM_TOL set to 2'b00 or 2'b01 or 2'10)

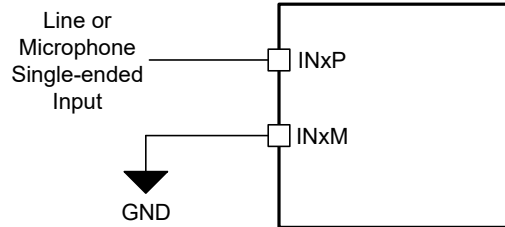

Figure 7-18. Single-ended DC-Coupled Input Connection (ADC_CHx_INSRC set to 2'b01 and ADC_CHx_CM_TOL set to 2'b01 or 2'10)

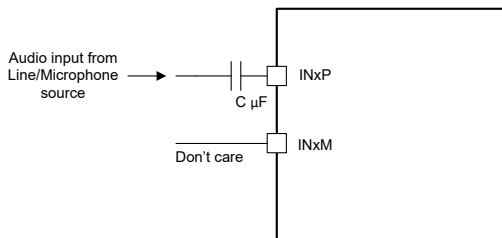

Figure 7-19. Single-ended mux on INxP AC-Coupled Input Connection (ADC_CHx_INSRC set to 2'b10 and ADC_CHx_CM_TOL set to 2'b00 or 2'b01 or 2'10)

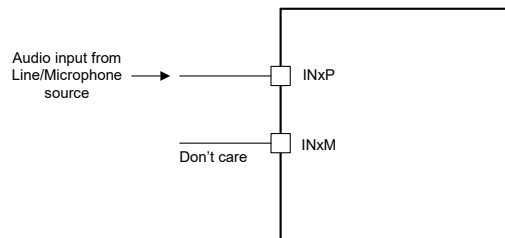

Figure 7-20. Single-ended mux on INxP DC-Coupled Input Connection (ADC_CHx_INSRC set to 2'b10 and ADC_CHx_CM_TOL set to 2'b01 or 2'10)

The device also allows for flexibility in choosing the typical input impedance on INxP or INxM from 5kΩ (default), 10kΩ, and 40kΩ based on the input source impedance selection. There can be a ±20% variation on the selected input impedance value. The higher input impedance results in slightly higher noise or lower dynamic range. [Table 7-12](#) lists the configuration register settings for the input impedance for the record channel.

Table 7-12. Input Impedance Selection for the Record Channel

P0_R80_D[5:4] : ADC_CH1_IMP[1:0]	CHANNEL 1 INPUT IMPEDANCE SELECTION
00 (default)	Channel 1 input impedance typical value is 5 kΩ on INxP or INxM
01	Channel 1 input impedance typical value is 10 kΩ on INxP or INxM
10	Channel 1 input impedance typical value is 40 kΩ on INxP or INxM
11	Reserved (do not use this setting)

Similarly, the input impedance selection setting for input channel 2 can be configured using the ADC_CH2_IMP[1:0] (P0_R85_D[5:4]).

Input impedance setting of 5 kΩ is not supported when the ADC inputs are configured for single ended mux (ADC_CHx_INSRC = 2'b10 or 2'b11) and also not supported in the high swing mode ([Section 7.3.5](#)).

The value of the coupling capacitor in AC-coupled mode must be chosen so that the high-pass filter formed by the coupling capacitor and the input impedance do not affect the signal content. Before proper recording can begin, this coupling capacitor must be charged up to the common-mode voltage at power-up. To enable quick charging, the device has modes to speed up the charging of the coupling capacitor. The default value of the quick-charge timing is set for a coupling capacitor up to 1 μ F. However, if a higher-value capacitor is used in the system, then the quick-charging timing can be increased by using the INCAP_QCHG (P0_R5_D[7:6]) register bits. For low distortion performance, use the low-voltage coefficient capacitors for AC coupling.

Additionally, if the application uses digital PDM microphones for the recording, GPIOx, GPI1 and GPO1 pins can be reconfigured in the device to support up to four channels for the digital microphone recording (when the analog channels are not used). The device can also support simultaneous recording on two analog and two digital microphone channels or one analog channel and three digital microphone channels. These combinations can be enabled using the INTF4_CFG (B0_P0_R19) register. More details on enabling the PDM channels are present [Section 7.3.7](#).

The TAC5112 also supports an incremental mode of ADC where analog input channels can be used for DC measurements. This can be configured by setting IADC_EN (P0_R81_D[7]). For more details on the incremental mode of ADC, refer [Section 7.3.8](#).

7.3.4 Output Channel Configurations

The device consists of two pairs of analog output pins (OUTxP and OUTxM) that can be configured as differential inputs or single-ended outputs for playback channels. The device supports simultaneous playback of up to four channels of single-ended outputs or up to two channel differential output using the high-performance multichannel DAC. [Table 7-13](#) shows the input source selection for the playback channels.

Table 7-13. Input Source Selection for the Playback Channel

P0_R100_D[7:5] : OUT1x_SRC[2:0]	OUT1P/OUT1M Input Source Selection
000	Output driver disabled
001 (default)	DAC signal chain
010	Analog bypass signal chain
011	Mixing of DAC and Analog bypass signal chains
100	OUT1P for DAC and OUT1M for Analog bypass signal chain
101	OUT1P for Analog bypass and OUT1M for DAC signal chain.
11x	Reserved. Do not use this setting.

Similarly, the input source selection setting for output channel 2 can be configured using the OUT2x_SRC[2:0] (P0_R107_D[7:5]) register bits.

The TAC5112 supports up to 2-channel differential output, up to 2-channel pseudo-differential output, and up to 4-channel single-ended output. Each of the output channels can be independently configured for differential or single-ended output.

[Table 7-14](#) shows the configuration modes for the output pins.

Table 7-14. Output Pin Configuration for the Playback Channel

P0_R100_D[4:2] : OUT1x_CFG[2:0]	OUT1P/OUT1M Pin Configuration
000 (default)	OUT1P/OUT1M as a differential pair
001	OUT1P and OUT1M as independent single-ended outputs
010	Mono single-ended output on OUT1P only
011	Mono single-ended output on OUT1M only
100	Pseudo-differential output with OUT1P as signal and OUT1M as VCOM
101	Pseudo differential output with OUT1P as signal, OUT1M as VCOM and OUT2M as VCOM sense (external common mode sense).
110	Pseudo-differential output with OUT1M as signal and OUT1P as VCOM

Table 7-14. Output Pin Configuration for the Playback Channel (continued)

P0_R100_D[4:2] : OUT1x_CFG[2:0]	OUT1P/OUT1M Pin Configuration
111	Reserved. Do not use this setting.

Similarly, the output pin configuration for output channel 2 can be done using the OUT2x_CFG[2:0] (P0_R107_D[4:2]) register bits.

See Figure 7-21 to Figure 7-24 for the various typical output configuration diagrams.

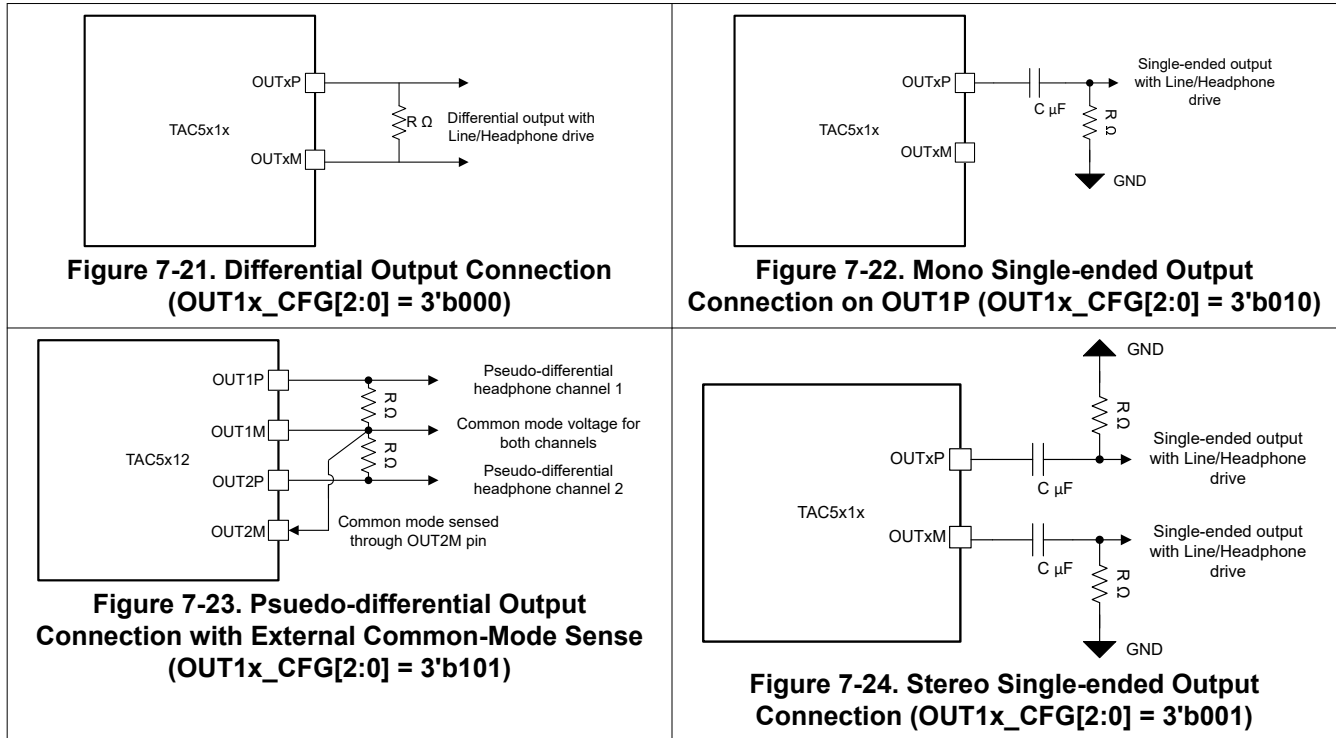

The TAC5112 can support a variety of loads including headphone, lineout, and receiver amplifiers. Load drive configurations are available for each pin independently. OUT1P_DRIVE[1:0] (P0_R101_D[7:6]) configures the load drive capability for the OUT1P pin. Similarly, OUT1M_DRIVE[1:0], OUT2P_DRIVE[1:0], OUT2M_DRIVE[1:0] control the output drive for OUT1M, OUT2P and OUT2M respectively.

7.3.5 Reference Voltage

All audio data converters require a DC reference voltage. The TAC5112 achieves low-noise performance by internally generating a low-noise reference voltage. This reference voltage is generated using a band-gap circuit with high PSRR performance. This audio converter reference voltage must be filtered externally using a minimum 1μF capacitor connected from the VREF pin to the device ground (VSS).

The value of this reference voltage can be configured using the VREF_FSCALE (P0_R77_D[1:0]) register bits and must be set to an appropriate value based on the desired full-scale input for the device and the AVDD supply voltage available in the system. The default VREF value is set to 2.75V, which in turn supports a 2V_{RMS} differential full-scale input to the device. The required minimum AVDD voltage for this mode is 3V. The TAC5112 also supports a high swing mode with 4V_{RMS} differential swing which can be enabled by setting ADC_CHx_FULLSCALE_VAL (P0_R80_D[1] and P0_R85_D[1]) to 1'b1 for each channel independently. Table 7-15 lists the various VREF settings supported along with the required AVDD range and the supported full-scale input signal for that configuration.

Table 7-15. VREF Programmable Settings

P0_R77_D[1:0]: VREF_FSCALE[1:0]	VREF OUTPUT VOLTAGE	DIFFERENTIAL FULL- SCALE INPUT SUPPORTED	SINGLE-ENDED FULL- SCALE INPUT SUPPORTED	AVDD OPERATION MODE
00 (default)	2.75V	2V _{RMS} (4 V _{RMS} supported in high swing mode)	1V _{RMS} (2 V _{RMS} supported in high swing mode)	AVDD 3.3V Operation
01	2.5V	1.818V _{RMS}	0.909V _{RMS}	AVDD 3.3V Operation
10	1.375V	1V _{RMS}	0.5V _{RMS}	AVDD 1.8V Operation
11	Reserved	Reserved	Reserved	Reserved

To achieve low power consumption, this audio reference block is powered down during the sleep or software shutdown modes as described in [Section 7.4](#). When exiting sleep mode, the audio reference block should be powered up by setting SLEEP_EXIT_VREF_EN (P0_R2_D[3]) to 1'b1. An internal fast-charge scheme helps the VREF pin settle to its steady-state voltage after the settling time (which is a function of the decoupling capacitor on the VREF pin). This time is approximately equal to 3.5ms when using a 1µF decoupling capacitor. If a higher-value decoupling capacitor is used on the VREF pin, the fast-charge setting must be reconfigured using the VREF_QCHG (P0_R2_D[5:4]) register bits, which support options of 3.5ms (default), 10ms, 50ms, or 100ms.

7.3.6 Programmable Microphone Bias

The device integrates a built-in, low-noise microphone bias pin that can be used in the system for biasing electret-condenser microphones or providing the supply to the MEMS analog or digital microphone. The integrated bias amplifier supports up to 5mA of load current that can be used for multiple microphones and is designed to provide a combination of high PSRR, low noise, and programmable bias voltages to allow the biasing to be fine-tuned for specific microphone combinations.

When using this MICBIAS pin for biasing or supplying to multiple microphones, avoid any common impedance on the board layout for the MICBIAS connection to minimize coupling across microphones. [Table 7-16](#) shows the available microphone bias programmable options.

Table 7-16. MICBIAS Programmable Settings

P0_R77_D[3:2] : MICBIAS_VAL[1:0]	P0_R77_D[1:0] : VREF_FSCALE[1:0]	MICBIAS OUTPUT VOLTAGE
00 (default)	00 (default)	2.75 V (same as the VREF output)
	01	2.5 V (same as the VREF output)
	10	1.375 V (same as the VREF output)
	11	Reserved (do not use these settings)
01	00 (default)	1.375 V (0.5 times the VREF output)
	01	1.250 V (0.5 times the VREF output)
	10 or 11	Reserved (do not use these settings)
10	XX	Reserved (do not use these settings)
11	XX	Same as AVDD

The microphone bias output can be powered on or powered off (default) by configuring the MICBIAS_PDZ (P0_R120_D[5]) register bit. Additionally, the device provides an option to configure the GPIOx or GPI1 pin to directly control the microphone bias output powering on or off. This feature is useful to control the microphone directly without engaging the host for I²C or SPI communication. The MICBIAS_PDZ (P0_R120_D[5]) register bit value is ignored if the GPIOx or GPI1 pin is configured to set the microphone bias on or off.

7.3.7 Digital PDM Microphone Record Channel

In addition to supporting analog microphones, the TAC5112 also interfaces to digital pulse-density-modulation (PDM) microphones and uses high-order and high-performance decimation filters to generate pulse code modulation (PCM) output data that can be transmitted on the audio serial interface to the host. The device supports up to four digital microphone recording channels (when the analog channels are not used). The device

can also support simultaneous recording on two analog and two digital microphone channels or one analog channel and three digital microphone channels.

The GPIOx, GPI1 and GPO1 pins can be configured for the PDM data lines (PDM DINx) and PDM Clock (PDMCLK) functions as per the Table 7-70 for the digital PDM microphone recording.

The device internally generates PDMCLK with a programmable frequency of either 6.144MHz, 3.072MHz, 1.536MHz, or 768kHz (for output data sample rates in multiples or submultiples of 48kHz) or 5.6448MHz, 2.8224MHz, 1.4112MHz, or 705.6kHz (for output data sample rates in multiples or submultiples of 44.1kHz) using the PDM_CLK_CFG[1:0] (P0_R53_D[7:6]) register bits. PDMCLK can be routed on the GPIOx and GPO1 pins using the respective configuration registers: GPIO1_CFG (P0_R10[7:4]), GPIO2_CFG (P0_R11[7:4]) and GPO1_CFG (P0_R12[7:4]). This clock can be connected to the external digital microphone device. Figure 7-25 shows a connection diagram of the digital PDM microphones.

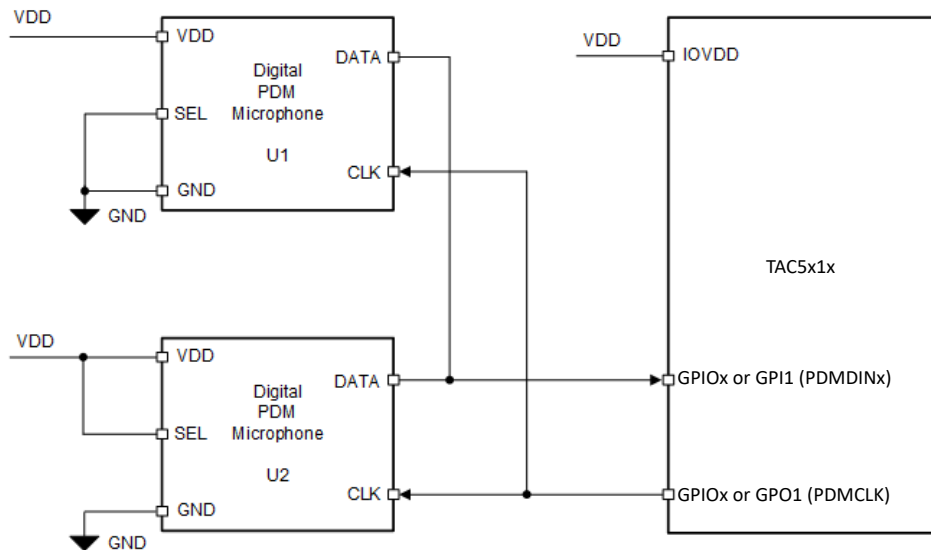

Figure 7-25. Digital PDM Microphones Connection Diagram for the TAC5112

The single-bit output of the external digital microphone device can be connected to the GPI1 or GPIOx pin. The device supports two PDM data lines: PDM DIN1 and PDM DIN2 set through the registers PDM DIN1_SEL (P0_R19_D[3:2]) and PDM DIN2_SEL (P0_R19_D[1:0]). When using GPI1, make sure that the GPI1 function is enabled using the GPI1_CFG (P0_R13[1]). This single data line can be shared by two digital microphones to place their data on the opposite edge of PDMCLK. Internally, the device latches the steady value of the data on either the rising or falling edge of PDMCLK based on the configuration register bits set in PDM DIN1_EDGE (P0_R19_D[4]) and PDM DIN2_EDGE (P0_R19_D[5]). Figure 7-26 shows the digital PDM microphone interface timing diagram.

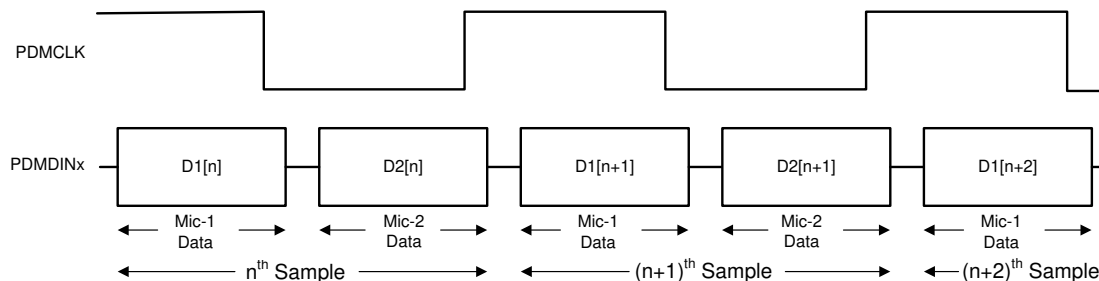

Figure 7-26. Digital PDM Microphone Protocol Timing Diagram

When the digital microphone is used for recording, the analog blocks of the respective ADC channel are powered down and bypassed for power efficiency. Channel 3 and channel 4 support only the digital microphone

interface. Use the PDM_CH1_SEL[1:0] (P0_R19_D[7]) and PDM_CH2_SEL[1:0] (P0_R19_D[6]) register bits to select the analog microphone or digital microphone for channel 1 to channel 2 respectively.

7.3.8 Incremental ADC (IADC) Mode

In the incremental ADC (IADC) mode user can convert the average value of the input, into a 24-bit code. This is useful for applications that need to sense a voltage rather than needing a continuous time domain capture.

The various configurations for the IADC mode can be set using IADC_CH_CFG (P0_R81) register. The IADC_MODE (P0_R81_D[6:5]) can be configured for single shot conversion or sequential conversion. In single shot conversion, the device enters into the conversion cycle when the user enables conversion. At the end of conversion, the IADC_ONESHOT_CONV_DONE_STS (P0_R81_D[2]) bit is set. The user can read the data register after this bit is set. In sequential conversion, the device keeps converting the input sequentially. The rate of conversion is dependent on the “SKIP”, “CONVERT” and “RESET” values set in the IADC_CFG (P0_R76) registers.

This operation has 3 distinct phases “SKIP”, “CONVERT” and “RESET”. In “SKIP” phase, the input is converted, however the output corresponding to the first “SKIP” number of cycles isn’t considered for final code generation. During “CONVERT” phase the ADC outputs are considered for final code generation. During “RESET” phase the various memory elements inside the ADC are reset.

The IADC inputs can also be configured as single-ended or differential using the ADC_CHx_CFG0 registers to configure the ADC_CHx_INSRC.

GPIOx or GP11 pins can be used by the user to begin the IADC mode through the IADC_CONVST_GPIO (P0_R21_D[5:4]) register for ease of control. In this case the setting of IADC_EN (P0_R81_D[7]) will be ignored.

For more details, refer the [Configuring and using the IADC Mode in TAx5x1x device application report](#).

7.3.9 Signal-Chain Processing

The TAC5112 signal chain is comprised of very low-noise, high-performance, and low-power analog blocks and highly flexible and programmable digital processing blocks. The high performance and flexibility combined with a compact package make the TAC5112 is optimized for a variety of end-equipments and applications that require multichannel audio capture and playback. [Section 7.3.9.1](#) and [Section 7.3.9.2](#) describes key components in ADC and DAC signal chain further.

7.3.9.1 ADC Signal-Chain

Figure 7-27 shows the key components of the record path signal chain.

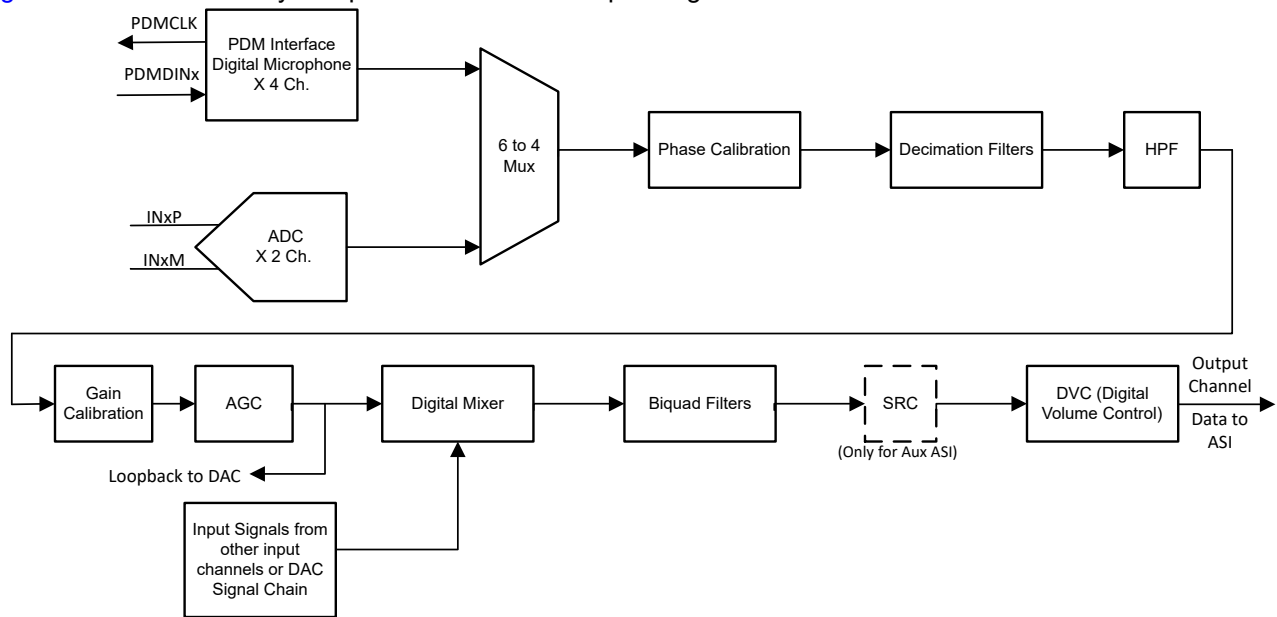

Figure 7-27. ADC Signal-Chain Processing Flowchart

The front-end ADC is very low noise, with a 105dB dynamic range performance. This low-noise and low-distortion, multibit, delta-sigma ADC enables the TAC5112 to record a far-field audio signal with very high fidelity, both in quiet and loud environments. Moreover, the ADC architecture has inherent antialias filtering with a high rejection of out-of-band frequency noise around multiple modulator frequency components. Therefore, the device prevents noise from aliasing into the audio band during ADC sampling. Further on in the signal chain, an integrated, high-performance multistage digital decimation filter sharply cuts off any out-of-band frequency noise with high stop-band attenuation.

The device also has an integrated programmable biquad filter that allows for custom low-pass, high-pass, or any other desired frequency shaping. Thus, the overall signal chain architecture removes the requirement to add external components for antialiasing low-pass filtering and thus saves drastically on the external system component cost and board space. See the [TAC5212 Integrated Analog Antialiasing Filter and Flexible Digital Filter application report](#) for further details.

The signal chain also consists of various highly programmable digital processing blocks such as phase calibration, gain calibration, high-pass filter, digital summer or mixer, biquad filters, synchronous sample rate converter, and volume control. The details of these processing blocks are discussed further in this section. The device also supports up to four digital PDM microphone recording channels when the analog recording channels are not used.

The desired input channels for recording can be enabled or disabled by using the CH_EN (P0_R118) register, and the output channels for the audio serial interface can be enabled or disabled by using the ASI_TX_CHx_CFG registers. In general, the device supports simultaneous power-up and power-down of all active channels for simultaneous recording. However, based on the application's needs, if some channels must be powered up or powered down dynamically when the other channel recording is on, then that use case is supported by setting the DYN_PUPD_CFG (P0_R119) register.

The device supports an input signal bandwidth up to 90kHz, which allows the high-frequency non-audio signal to be recorded by using a 216kHz (or higher) sample rate. Wide bandwidth mode can be enabled or disabled by setting ADC_CHx_BW_MODE bit (P0_R80_D[0] and P0_R85_D[0]). Wide bandwidth mode is supported only with the 40kΩ input impedance setting (Table 7-12) and not supported for the high swing mode (Section 7.3.5).

For sample rates of 48kHz or lower, the device supports all features and various programmable processing blocks. However, for sample rates higher than 48kHz, there are limitations in the number of simultaneous channel recordings and playback supported and the number of biquad filters and such. See the [TAC5212 Sampling Rates and Programmable Processing Blocks Supported application report](#) for further details.

7.3.9.1.1 6 to 4 Input Select Multiplexer (6:4 MUX)

The device supports up to two analog and up to four digital microphone channels and can support the simultaneous recording on four channels at a given time. The ADC input signal chain consists of a 6:4 Multiplexer to enable these combinations:

1. All 4 digital PDM channels.
2. 3 digital PDM channels and 1 analog channel.
3. 2 digital PDM channels and 2 analog channels

These combinations can be enabled using the INTF4_CFG (B0_P0_R19) register. More details on enabling the PDM channels are present in [Section 7.3.7](#).

7.3.9.1.2 Programmable Channel Gain and Digital Volume Control

The device has an independent programmable channel gain setting for each input channel that can be set to the appropriate value based on the maximum input signal expected in the system and the ADC VREF setting used (see the [Section 7.3.5](#)), which determines the ADC full-scale signal level.

The device has a programmable digital volume control with a range from –80dB to 47dB in steps of 0.5dB with the option to mute the channel recording. The digital volume control value can be changed dynamically while the ADC channel is powered up and recorded. During volume control changes, the soft ramp-up or ramp-down volume feature is used internally to avoid any audible artifacts. Soft-stepping can be entirely disabled using the ADC_DSP_DISABLE_SOFT_STEP (P0_R114_D[1]) register bit.

The digital volume control setting is independently available for each output channel, including the digital microphone record channel. However, the device also supports an option to gang up the volume control setting for all channels together using the channel 1 digital volume control setting, regardless if channel 1 is powered up or powered down. This gang-up can be enabled using the ADC_DSP_DVOL_GANG (P0_R114_D[0]) register bit.

[Table 7-17](#) shows the programmable options available for the digital volume control.

Table 7-17. Digital Volume Control (DVC) Programmable Settings

P0_R82_D[7:0] : ADC_CH1_DVOL[7:0]	DVC SETTING FOR OUTPUT CHANNEL 1
0000 0000 = 0d	Output channel 1 DVC is set to mute
0000 0001 = 1d	Output channel 1 DVC is set to –80dB
0000 0010 = 2d	Output channel 1 DVC is set to –79.5dB
0000 0011 = 3d	Output channel 1 DVC is set to –79dB
...	...
1010 0000 = 160d	Output channel 1 DVC is set to –0.5dB
1010 0001 = 161d (default)	Output channel 1 DVC is set to 0dB
1010 0010 = 162d	Output channel 1 DVC is set to 0.5dB
...	...
1111 1101 = 253d	Output channel 1 DVC is set to 46dB
1111 1110 = 254d	Output channel 1 DVC is set to 46.5dB
1111 1111 = 255d	Output channel 1 DVC is set to 47dB

Similarly, the digital volume control setting for output channel 2 to channel 4 can be configured using the CH2_DVOL (P0_R87) to CH4_DVOL (P0_R95) register bits, respectively.

The internal digital processing engine soft ramps up the volume from a muted level to the programmed volume level when the channel is powered up, and the internal digital processing engine soft ramps down the volume from a programmed volume to mute when the channel is powered down. This soft-stepping of volume is done to prevent abruptly powering up and powering down the record channel. This feature can also be entirely disabled using the ADC_DSP_DISABLE_SOFT_STEP (P0_R114_D[1]) register bit.

The programmable channel digital volume control feature is not applicable if the PLL is turned off. For setting channel attenuation, user can configure this by using the programmable high pass filter coefficients as described in [Section 8.2.4](#).

7.3.9.1.3 Programmable Channel Gain Calibration

Along with the digital volume control, this device also provides programmable channel gain calibration. The gain of each channel can be finely calibrated or adjusted in steps of 0.1dB for a range of –0.8dB to 0.7dB gain error. This adjustment is useful when trying to match the gain across channels resulting from external components and microphone sensitivity. This feature, in combination with the regular digital volume control, allows the gains across all channels to be matched for a wide gain error range with a resolution of 0.1dB. [Table 7-18](#) shows the programmable options available for the channel gain calibration.

Table 7-18. Channel Gain Calibration Programmable Settings

P0_R83_D[7:4] : ADC_CH1_FGAIN[3:0]	CHANNEL GAIN CALIBRATION SETTING FOR INPUT CHANNEL 1
0000 = 0d	Input channel 1 gain calibration is set to –0.8dB
0001 = 1d	Input channel 1 gain calibration is set to –0.7dB
...	...
1000 = 8d (default)	Input channel 1 gain calibration is set to 0dB
...	...
1110 = 14d	Input channel 1 gain calibration is set to 0.6dB
1111 = 15d	Input channel 1 gain calibration is set to 0.7dB

Similarly, the channel gain calibration setting for input channel 2 to channel 4 can be configured using the ADC_CH2_CFG3 (P0_R88) to ADC_CH4_CFG3 (P0_R96) register bits, respectively.

7.3.9.1.4 Programmable Channel Phase Calibration

In addition to the gain calibration, the phase delay in each record channel can be finely calibrated or adjusted in steps of one modulator clock cycle for a cycle range of 1 to 63 for the phase error. The modulator clock for analog and digital microphones is set independently. For analog microphones, it is the clock used for ADC MOD CLK, and is 3.072MHz (the output data sample rate is multiples or submultiples of 48kHz) or 2.8224MHz (the output data sample rate is multiples or submultiples of 44.1 kHz) in default configurations. For power savings, the ADC modulator clock can also be reduced to 1.536MHz (the output data sample rate is multiples or submultiples of 48kHz) or 1.4112MHz (the output data sample rate is multiples or submultiples of 44.1 kHz) by using ADC_CLK_BY2_MODE (B0_P78_D[7]) register bit. For the digital microphone use case, it is the clock used for PDM_CLK, and is also 3.072MHz (the output data sample rate is multiples or submultiples of 48kHz) or 2.8224MHz (the output data sample rate is multiples or submultiples of 44.1 kHz) in default configurations. User can configure the PDM_CLK using the PDM_CLK_CFG[1:0] (P0_R53_D[7:6]) register bits. The programmable channel phase calibration feature is very useful for many applications that must match the phase with fine resolution between each channel, including any phase mismatch across channels resulting from external components or microphones. [Table 7-19](#) shows the available programmable options for channel phase calibration when operating with default modulator clocks.

Table 7-19. Channel Phase Calibration Programmable Settings

P0_R84_D[7:2] : ADC_CH1_PCAL[5:0]	CHANNEL PHASE CALIBRATION SETTINGS FOR INPUT CHANNEL 1
00 0000 = 0d (default)	No phase calibration
00 0001 = 1d	Phase calibration delay is set to one cycle of the modulator clock
...	...

Table 7-19. Channel Phase Calibration Programmable Settings (continued)

P0_R84_D[7:2] : ADC_CH1_PCAL[5:0]	CHANNEL PHASE CALIBRATION SETTINGS FOR INPUT CHANNEL 1
11 1111 = 63d	Phase calibration delay is set to 63 cycles of the modulator clock

Similarly, the channel phase calibration setting for input channel 2 to channel 4 can be configured using the ADC_CH2_PCAL (P0_R89_D[7:2]) to ADC_CH4_PCAL (P0_R97_D[7:2]) register bits, respectively.

By default, the phase calibration is enabled for both analog and digital microphone channels. This can be changed to only analog or only digital microphones through the PCAL_ANA_DIG_SEL (P0_R84_D[1:0]) register bits. When using analog input and PDM input together for simultaneous conversion, there is a limit on the available phase calibration options for the analog channels when analog and PDM clocks are different. When using ADC MOD CLK = 1.536MHz or 1.4112MHz and PDM_CLK = 6.144MHz or 5.6448MHz, phase calibration delays of only up to 16 cycles of the modulator clock are supported for the analog channels. When using ADC MOD CLK = 3.072MHz or 2.8224 and PDM_CLK = 6.144MHz or 5.6448MHz, phase calibration delays of only up to 32 cycles of the modulator clock are supported for the analog channels. When using ADC MOD CLK = 1.536MHz or 1.4112MHz and PDM_CLK = 3.072MHz or 2.8224MHz also, phase calibration delays of only up to 32 cycles of the modulator clock are supported for the analog channels.

7.3.9.1.5 Programmable Digital High-Pass Filter

To remove the DC offset component and attenuate the undesired low-frequency noise content in the record data, the device supports a programmable high-pass filter (HPF). The HPF is not a channel-independent filter setting but is globally applicable for all ADC channels. This HPF is constructed using the first-order infinite impulse response (IIR) filter and is efficient enough to filter out possible DC components of the signal. Table 7-20 shows the predefined -3dB cutoff frequencies available that can be set by using the ADC_DSP_HPF_SEL[1:0] register bits of P0_R114_D[5:4]. Additionally, to achieve a custom -3dB cutoff frequency for a specific application, the device also allows the first-order IIR filter coefficients to be programmed when the HPF_SEL[1:0] register bits are set to 2'b00. Figure 7-28 illustrates the frequency response plot for the HPF filter.

Table 7-20. HPF Programmable Settings

P0_R114_D[5:4] : ADC_DSP_HPF_SEL L[1:0]	-3dB CUTOFF FREQUENCY SETTING	-3dB CUTOFF FREQUENCY AT 16kHz SAMPLE RATE	-3dB CUTOFF FREQUENCY AT 48-kHz SAMPLE RATE
00	Programmable 1st-order IIR filter	Programmable 1st-order IIR filter	Programmable 1st-order IIR filter
01 (default)	$0.00002 \times f_s$	0.25 Hz	1 Hz
10	$0.00025 \times f_s$	4 Hz	12 Hz
11	$0.002 \times f_s$	32 Hz	96 Hz

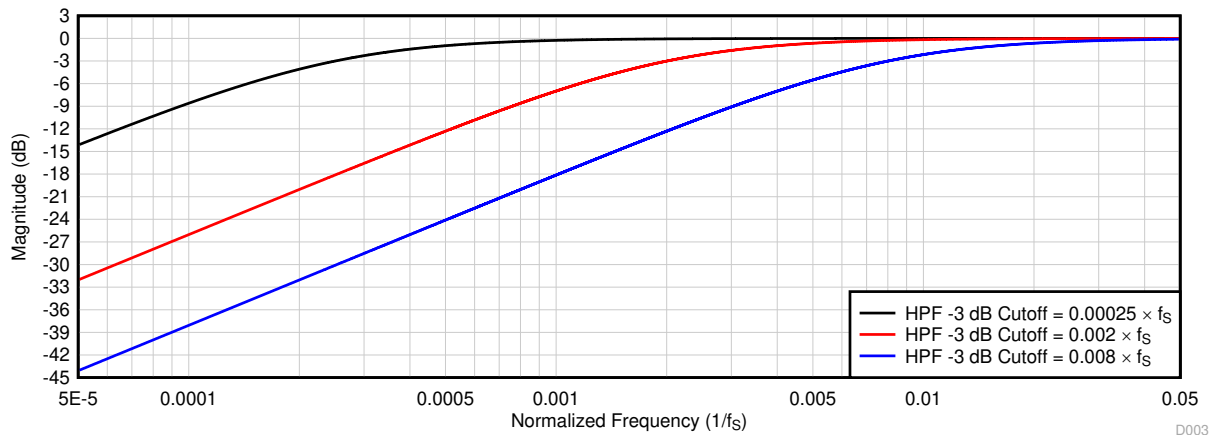

Figure 7-28. HPF Filter Frequency Response Plot

Equation 1 gives the transfer function for the first-order programmable IIR filter:

$$H(z) = \frac{N_0 + N_1 z^{-1}}{2^{31} - D_1 z^{-1}} \quad (1)$$

The frequency response for this first-order programmable IIR filter with default coefficients is flat at a gain of 0 dB (all-pass filter). The host device can override the frequency response by programming the IIR coefficients in Table 7-21 to achieve the desired frequency response for high-pass filtering or any other desired filtering. If ADC_DSP_HP_SEL[1:0] is set to 2'b00, the host device must write these coefficient values for the desired frequency response before powering-up any ADC channel for recording. Table 7-21 shows the filter coefficients for the first-order IIR filter. For additional details on configuring the programmable coefficients, refer Section 8.2.

Table 7-21. 1st-Order IIR Filter Coefficients

FILTER	FILTER COEFFICIENT	DEFAULT COEFFICIENT VALUE	COEFFICIENT REGISTER MAPPING
Programmable 1st-order IIR filter (can be allocated to HPF or any other desired filter)	N ₀	0x7FFFFFFF	P10_R120-R123
	N ₁	0x00000000	P10_R124-R127
	D ₁	0x00000000	P11_R8-R11

7.3.9.1.6 Programmable Digital Biquad Filters

The device supports up to 12 programmable digital biquad filters available for ADC signal chain limited to 3/channel. These highly efficient filters achieve the desired frequency response. The TAC5112 also supports on-the-fly programmable Biquad filters for two-channel record use cases. In digital signal processing, a digital biquad filter is a second-order, recursive linear filter with two poles and two zeros. Equation 2 gives the transfer function of each biquad filter:

$$H(z) = \frac{N_0 + 2N_1 z^{-1} + N_2 z^{-2}}{2^{31} - 2D_1 z^{-1} - D_2 z^{-2}} \quad (2)$$

The frequency response for the biquad filter section with default coefficients is flat at a gain of 0dB (all-pass filter). The host device can override the frequency response by programming the biquad coefficients to achieve the desired frequency response for low-pass, high-pass, or any other desired frequency shaping. The programmable coefficients for the biquads are located in the Section 8.2.1 and Section 8.2.2. If biquad filtering is required, then the host device must write these coefficient values before powering up any ADC channels for recording. In two-channel use case, the TAC5112 also supports on-the-fly programmable filters. In this case, the device uses two banks of filters for one channel with a switch bit to perform the switch from one filter bank to the other. As described in Table 7-22, these biquad filters can be allocated for each output channel based on the ADC_DSP_BQ_CFG[1:0] register setting of P0_R114_D[3:2]. By setting ADC_DSP_BQ_CFG[1:0] to 2'b00, the biquad filtering for all record channels is disabled and the host device can choose this setting if no additional filtering is required for the system application. See the [TAC5x1x and TAC5x1x-Q1 Programmable Biquad Filters - Configuration and Applications application report](#) for further details.

Table 7-22. Biquad Filter Allocation to the Record Output Channel

PROGRAMMABLE BIQUAD FILTER	RECORD OUTPUT CHANNEL ALLOCATION USING P0_R114_D[3:2] REGISTER SETTING		
	ADC_DSP_BQ_CFG[1:0] = 2'b01 (1 Biquad per Channel)	ADC_DSP_BQ_CFG[1:0] = 2'b10 (Default) (2 Biquads per Channel)	ADC_DSP_BQ_CFG[1:0] = 2'b11 (3 Biquads per Channel)
Biquad filter 1	Allocated to output channel 1	Allocated to output channel 1	Allocated to output channel 1
Biquad filter 2	Allocated to output channel 2	Allocated to output channel 2	Allocated to output channel 2
Biquad filter 3	Allocated to output channel 3	Allocated to output channel 3	Allocated to output channel 3
Biquad filter 4	Allocated to output channel 4	Allocated to output channel 4	Allocated to output channel 4
Biquad filter 5	Not used	Allocated to output channel 1	Allocated to output channel 1

Table 7-22. Biquad Filter Allocation to the Record Output Channel (continued)

PROGRAMMABLE BIQUAD FILTER	RECORD OUTPUT CHANNEL ALLOCATION USING P0_R114_D[3:2] REGISTER SETTING		
	ADC_DSP_BQ_CFG[1:0] = 2'b01 (1 Biquad per Channel)	ADC_DSP_BQ_CFG[1:0] = 2'b10 (Default) (2 Biquads per Channel)	ADC_DSP_BQ_CFG[1:0] = 2'b11 (3 Biquads per Channel)
Biquad filter 6	Not used	Allocated to output channel 2	Allocated to output channel 2
Biquad filter 7	Not used	Allocated to output channel 3	Allocated to output channel 3
Biquad filter 8	Not used	Allocated to output channel 4	Allocated to output channel 4
Biquad filter 9	Not used	Not used	Allocated to output channel 1
Biquad filter 10	Not used	Not used	Allocated to output channel 2
Biquad filter 11	Not used	Not used	Allocated to output channel 3
Biquad filter 12	Not used	Not used	Allocated to output channel 4

Table 7-23 shows the biquad filter coefficients mapping to the register space.

Table 7-23. Biquad Filter Coefficients Register Mapping

PROGRAMMABLE BIQUAD FILTER	BIQUAD FILTER COEFFICIENTS REGISTER MAPPING	PROGRAMMABLE BIQUAD FILTER	BIQUAD FILTER COEFFICIENTS REGISTER MAPPING
Biquad filter 1	P8_R8-R27	Biquad filter 7	P9_R8-R27
Biquad filter 2	P8_R28-R47	Biquad filter 8	P9_R28-R47
Biquad filter 3	P8_R48-R67	Biquad filter 9	P9_R48-R67
Biquad filter 4	P8_R68-R87	Biquad filter 10	P9_R68-R87
Biquad filter 5	P8_R88-R107	Biquad filter 11	P9_R88-R107
Biquad filter 6	P8_R108-R127	Biquad filter 12	P9_R108-R127

7.3.9.1.7 Programmable Channel Summer and Digital Mixer

For applications that require an even higher SNR than that supported for each channel, the device's digital summing mode can be used. In this mode, the digital record data are summed up across the channel with an equal weightage factor, which helps in reducing the effective record noise. The device supports a fully programmable mixer feature that can mix the various input channels with their custom programmable scale factor to generate the final output channels. Figure 7-29 shows a block diagram that describes the mixer 1 operation to generate output channel 1. The programmable coefficients for the mixer operation are located in the Section 8.2.3. The co-efficient of programmable mixer range starts from 7FFFFFFF to FFFFFFFF(-1 to +1), where 7FFFFFFF = +1, FFFFFFFF = -1 and 00000000 = 0.

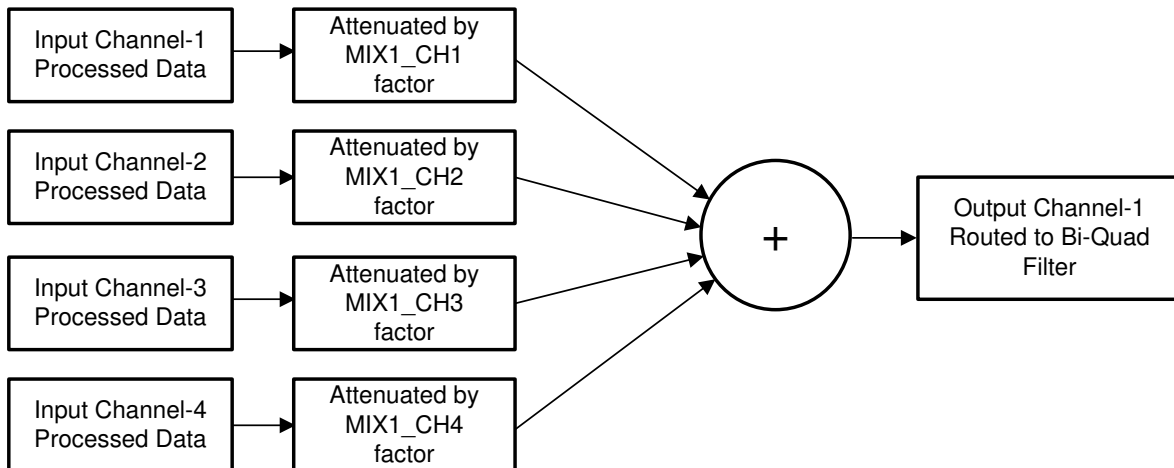

Figure 7-29. Programmable Digital Mixer Block Diagram

A similar mixer operation is performed by mixer 2, mixer 3, and mixer 4 to generate output channel 2, channel 3, and channel 4, respectively. TI recommends using the PPC3 GUI for configuring the programmable coefficients settings; for more details see the [Mixer Configuration for TAC5x1x and TAC5x1x-Q1 CODECs](#) and the [PurePath™ console graphical development suite](#). Additional details on the configurations can be found in the [Using the TAx5x1x Programmable Digital Channel Mixer](#) application report.

7.3.9.1.8 Configurable Digital Decimation Filters

The device record channel includes a high dynamic range and a built-in digital decimation filter to process the oversampled data from the multibit delta-sigma ($\Delta\Sigma$) modulator to generate digital data at the same Nyquist sampling rate as the FSYNC rate. As illustrated in Figure 7-27, this decimation filter can also be used for processing the oversampled PDM stream from the digital microphone. The decimation filter can be chosen from four different types, depending on the required frequency response, group delay, power consumption, and phase linearity requirements for the target application. The selection of the decimation filter option can be done by configuring the ADC_DSP_DECI_FILTER (P0_R114_D[7:6]) register bits. Low power filter can be configured by setting ADC_LOW_PWR_FILTER (P0_R78_D[2]) bit. Table 7-24 shows the configuration register setting for the decimation filter mode selection for the record channel. This makes them suitable for a wide variety of audio applications.

Table 7-24. Decimation Filter Mode Selection for the Record Channel

P0_R78_D[2] : ADC_LOW_PWR_FILTER	P0_R114_D[7:6] : ADC_DSP_DECI_FILTER[1:0]	DECIMATION FILTER MODE SELECTION
0	00 (default)	Linear phase filters are used for the decimation
0	01	Low latency filters are used for the decimation
0	10	Ultra-low latency filters are used for the decimation
0	11	Reserved (do not use this setting)
1	x	Low power filters are used for the decimation

The following sections describe the filter response for the different latency options and samples rates.

7.3.9.1.8.1 Linear-phase filters

The linear-phase decimation filters are the default filters set by the device and can be used for all applications that require a perfect linear phase with zero-phase deviation within the pass-band specification of the filter. The filter performance specifications and various plots for all supported output sampling rates are listed in this section.

7.3.9.1.8.1.1 Sampling Rate: 8kHz or 7.35kHz

Figure 7-30 and Figure 7-31 respectively show the magnitude response and the pass-band ripple for this decimation filter with a sampling rate of 8kHz or 7.35kHz, Table 7-25 and lists its specifications.

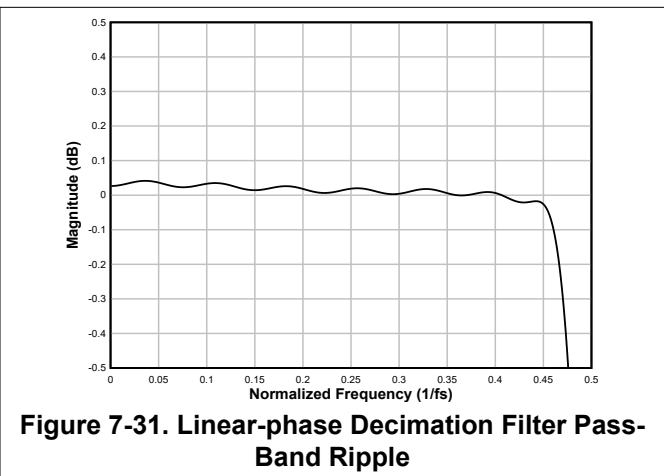
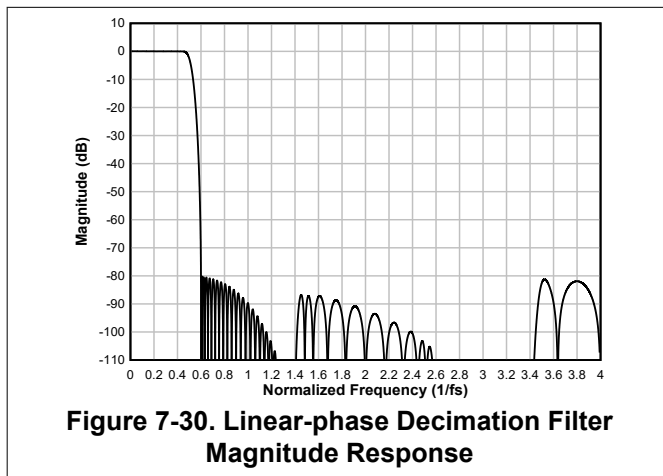

Table 7-25. Linear-phase Decimation Filter Specifications

PARAMETER	TEST CONDITIONS	MIN	TYP	MAX	UNIT
Pass-band ripple	Frequency range is 0 to $0.454 \times f_S$	-0.04		0.04	dB
Stop-band attenuation	Frequency range is $0.6 \times f_S$ to $4 \times f_S$	80.2			dB
	Frequency range is $4 \times f_S$ onwards	84.7			

Table 7-25. Linear-phase Decimation Filter Specifications (continued)

PARAMETER	TEST CONDITIONS	MIN	TYP	MAX	UNIT
Group delay or latency	Frequency range is 0 to $0.454 \times f_S$		16.1		$1/f_S$

7.3.9.1.8.1.2 Sampling Rate: 16kHz or 14.7kHz

Figure 7-32 and Figure 7-33 respectively show the magnitude response and the pass-band ripple for this decimation filter with a sampling rate of 16kHz or 14.7kHz, and Table 7-26 lists its specifications.

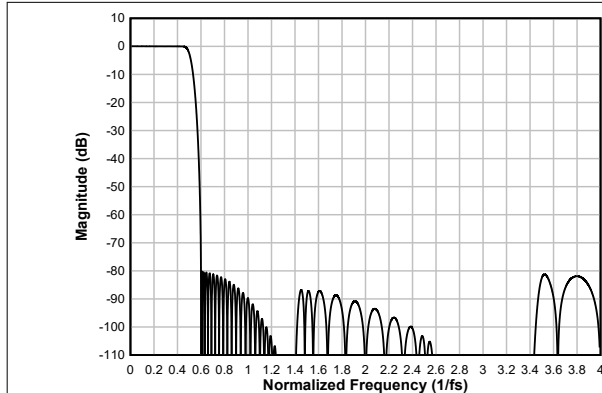
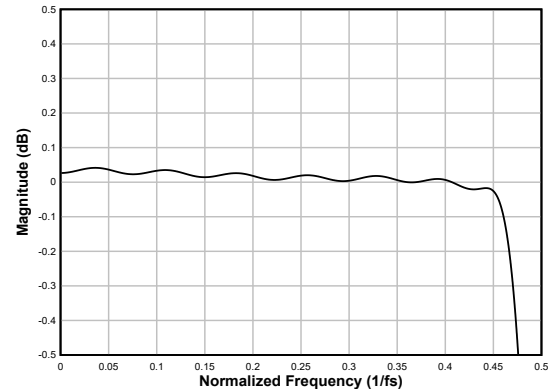
**Figure 7-32. Linear-phase Decimation Filter Magnitude Response****Figure 7-33. Linear-phase Decimation Filter Pass-Band Ripple****Table 7-26. Linear-phase Decimation Filter Specifications**

PARAMETER	TEST CONDITIONS	MIN	TYP	MAX	UNIT
Pass-band ripple	Frequency range is 0 to $0.454 \times f_S$	-0.04		0.04	dB
Stop-band attenuation	Frequency range is $0.6 \times f_S$ to $4 \times f_S$	80.2			dB
	Frequency range is $4 \times f_S$ onwards	84.7			
Group delay or latency	Frequency range is 0 to $0.454 \times f_S$		16.1		$1/f_S$

7.3.9.1.8.1.3 Sampling Rate: 24kHz or 22.05kHz

Figure 7-34 and Figure 7-35 respectively show the magnitude response and the pass-band ripple for this decimation filter with a sampling rate of 24kHz or 22.05kHz, and Table 7-27 lists its specifications.

**Figure 7-34. Linear-phase Decimation Filter Magnitude Response****Figure 7-35. Linear-phase Decimation Filter Pass-Band Ripple**

Table 7-27. Linear-phase Decimation Filter Specifications

PARAMETER	TEST CONDITIONS	MIN	TYP	MAX	UNIT
Pass-band ripple	Frequency range is 0 to $0.455 \times f_S$	-0.05		0.05	dB
Stop-band attenuation	Frequency range is $0.6 \times f_S$ to $4 \times f_S$	80.6			dB
	Frequency range is $4 \times f_S$ onwards	93			
Group delay or latency	Frequency range is 0 to $0.455 \times f_S$		14.7		$1/f_S$

7.3.9.1.8.1.4 Sampling Rate: 32kHz or 29.4kHz

Figure 7-36 and Figure 7-37 respectively show the magnitude response and the pass-band ripple for this decimation filter with a sampling rate of 32kHz or 29.4kHz, and Table 7-28 lists its specifications.

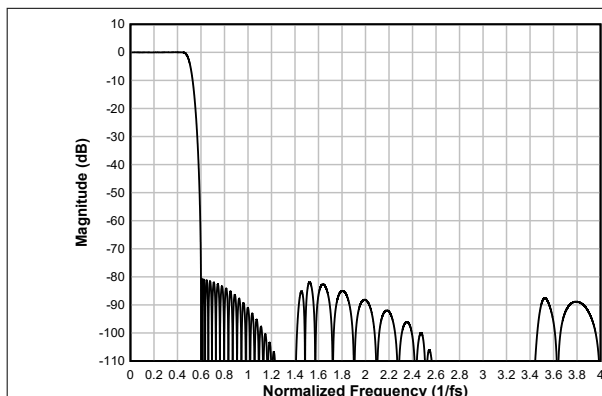
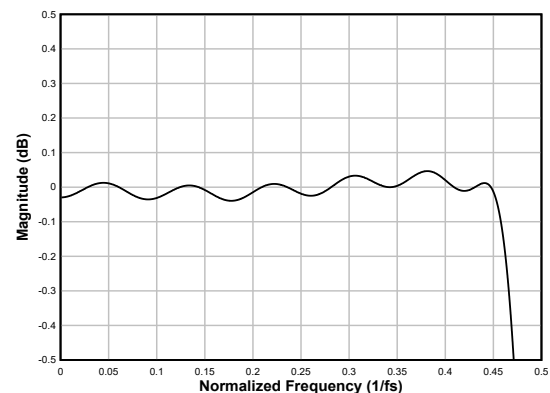
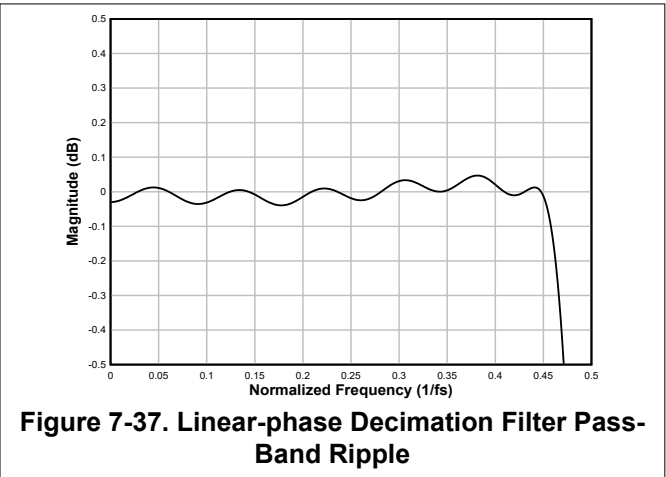
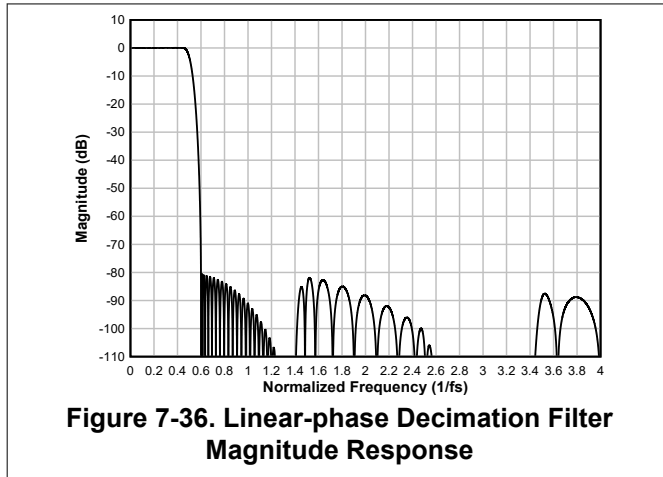

Table 7-28. Linear-phase Decimation Filter Specifications

PARAMETER	TEST CONDITIONS	MIN	TYP	MAX	UNIT
Pass-band ripple	Frequency range is 0 to $0.455 \times f_S$	-0.05		0.05	dB
Stop-band attenuation	Frequency range is $0.6 \times f_S$ to $4 \times f_S$	80.6			dB
	Frequency range is $4 \times f_S$ onwards	92.9			
Group delay or latency	Frequency range is 0 to $0.455 \times f_S$		14.7		$1/f_S$

7.3.9.1.8.1.5 Sampling Rate: 48kHz or 44.1kHz

Figure 7-38 and Figure 7-39 respectively show the magnitude response and the pass-band ripple for this decimation filter with a sampling rate of 48kHz or 44.1kHz, and Table 7-29 lists its specifications.

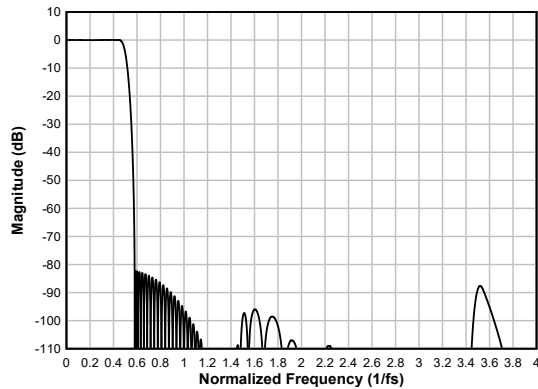

Figure 7-38. Linear-phase Decimation Filter Magnitude Response

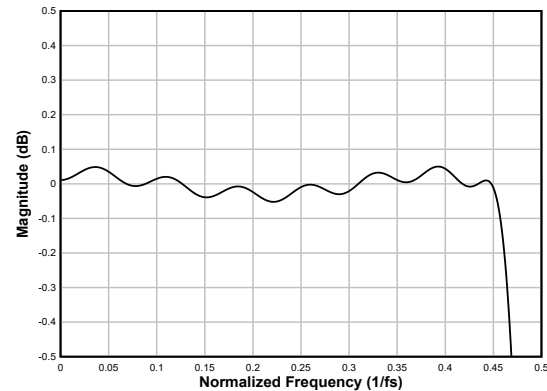

Figure 7-39. Linear-phase Decimation Filter Pass-Band Ripple

Table 7-29. Linear-phase Decimation Filter Specifications

PARAMETER	TEST CONDITIONS	MIN	TYP	MAX	UNIT
Pass-band ripple	Frequency range is 0 to $0.454 \times f_S$	-0.05		0.05	dB
Stop-band attenuation	Frequency range is $0.58 \times f_S$ to $4 \times f_S$	82.2			dB
	Frequency range is $4 \times f_S$ onwards	98			
Group delay or latency	Frequency range is 0 to $0.454 \times f_S$		17		$1/f_S$

7.3.9.1.8.1.6 Sampling Rate: 96kHz or 88.2kHz

Figure 7-40 and Figure 7-41 respectively show the magnitude response and the pass-band ripple for this decimation filter with a sampling rate of 96kHz or 88.2kHz, and Table 7-30 lists its specifications.

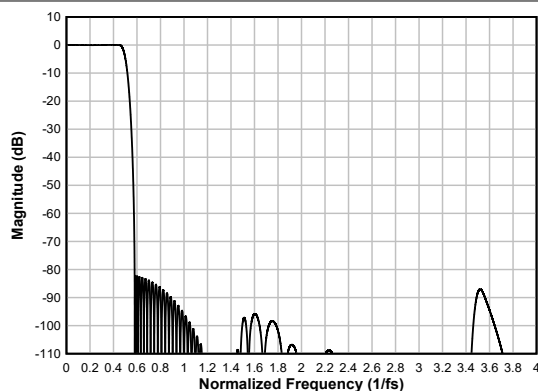

Figure 7-40. Linear-phase Decimation Filter Magnitude Response

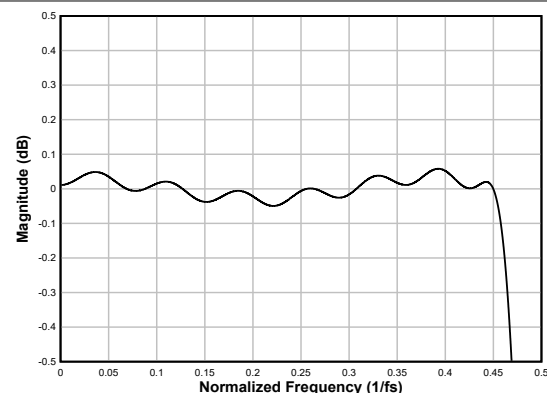

Figure 7-41. Linear-phase Decimation Filter Pass-Band Ripple

Table 7-30. Linear-phase Decimation Filter Specifications

PARAMETER	TEST CONDITIONS	MIN	TYP	MAX	UNIT
Pass-band ripple	Frequency range is 0 to $0.455 \times f_S$	-0.05		0.06	dB
Stop-band attenuation	Frequency range is $0.58 \times f_S$ to $4 \times f_S$	82.2			dB
	Frequency range is $4 \times f_S$ onwards	87			
Group delay or latency	Frequency range is 0 to $0.455 \times f_S$		16.9		$1/f_S$

7.3.9.1.8.1.7 Sampling Rate: 192kHz or 176.4kHz

Figure 7-42 and Figure 7-43 respectively show the magnitude response and the pass-band ripple for this decimation filter with a sampling rate of 192kHz or 176.4kHz, and Table 7-31 lists its specifications.

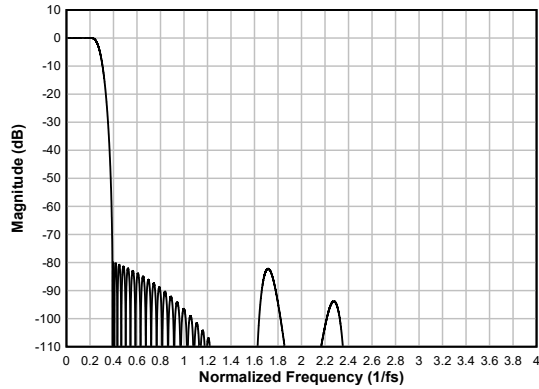

Figure 7-42. Linear-phase Decimation Filter Magnitude Response

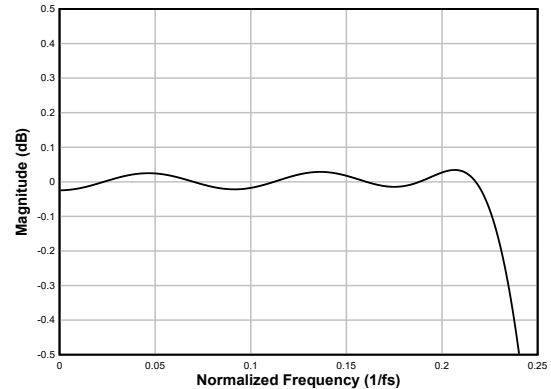

Figure 7-43. Linear-phase Decimation Filter Pass-Band Ripple

Table 7-31. Linear-phase Decimation Filter Specifications

PARAMETER	TEST CONDITIONS	MIN	TYP	MAX	UNIT
Pass-band ripple	Frequency range is 0 to $0.223 \times f_S$	-0.04		0.04	dB
Stop-band attenuation	Frequency range is $0.391 \times f_S$ to $4 \times f_S$	80			dB
	Frequency range is $4 \times f_S$ onwards	82.2			
Group delay or latency	Frequency range is 0 to $0.223 \times f_S$		11.6		$1/f_S$

Sampling Rate: 384kHz or 352.8kHz

Figure 7-44 and Figure 7-45 respectively show the magnitude response and the pass-band ripple for this decimation filter with a sampling rate of 384kHz or 352.8kHz, and Table 7-32 lists its specifications

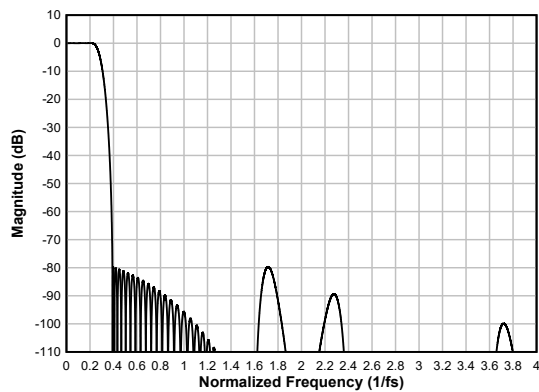

Figure 7-44. Linear-phase Decimation Filter Magnitude Response

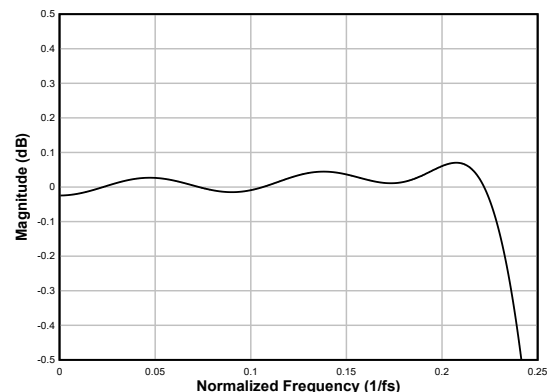

Figure 7-45. Linear-phase Decimation Filter Pass-Band Ripple

Table 7-32. Linear-phase Decimation Filter Specifications

PARAMETER	TEST CONDITIONS	MIN	TYP	MAX	UNIT
Pass-band ripple	Frequency range is 0 to $0.227 \times f_S$	-0.07		0.07	dB
Stop-band attenuation	Frequency range is $0.391 \times f_S$ to $4 \times f_S$	80			dB
	Frequency range is $4 \times f_S$ onwards	88.1			
Group delay or latency	Frequency range is 0 to $0.227 \times f_S$		11.4		$1/f_S$

Sampling Rate: 768kHz or 705.6 kHz

Figure 7-46 and Figure 7-47 respectively show the magnitude response and the pass-band ripple for this decimation filter with a sampling rate of 768kHz or 705.6kHz, and Table 7-33 lists its specifications

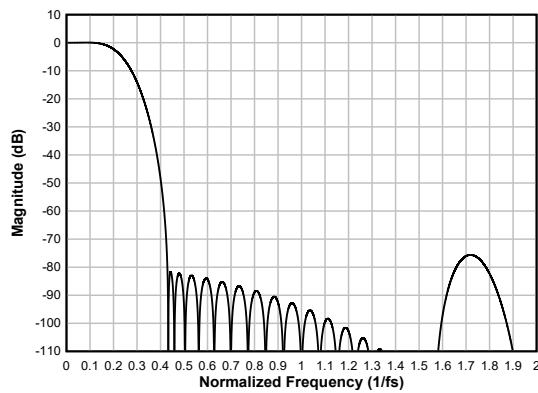

Figure 7-46. Linear-phase Decimation Filter Magnitude Response

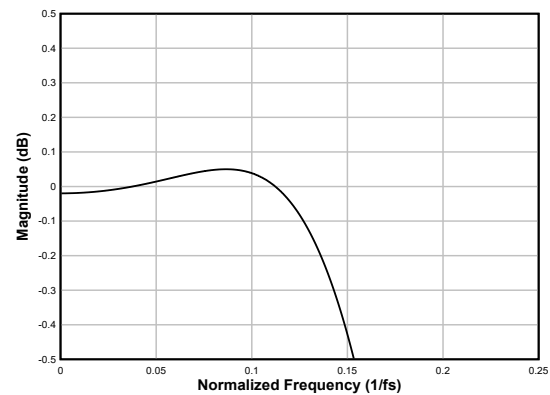

Figure 7-47. Linear-phase Decimation Filter Pass-Band Ripple

Table 7-33. Linear-phase Decimation Filter Specifications

PARAMETER	TEST CONDITIONS	MIN	TYP	MAX	UNIT
Pass-band ripple	Frequency range is 0 to $0.121 \times f_S$	-0.05		0.05	dB
Stop-band attenuation	Frequency range is $0.433 \times f_S$ to $4 \times f_S$	82.6			dB
	Frequency range is $4 \times f_S$ onwards	83.6			
Group delay or latency	Frequency range is 0 to $0.258 \times f_S$		6.4		$1/f_S$

7.3.9.1.8.2 Low-latency Filters

For applications where low latency with minimal phase deviation (within the audio band) is critical, the low-latency decimation filters on the TAC5112 can be used. The device supports these filters with a group delay of approximately seven samples with an almost linear phase response within the $0.376 \times f_S$ frequency band. This section provides the filter performance specifications and various plots for all supported output sampling rates for the low-latency filters.

7.3.9.1.8.2.1 Sampling Rate: 24kHz or 22.05kHz

Figure 7-48 shows the magnitude response and Figure 7-49 shows the pass-band ripple and phase deviation for this decimation filter with a sampling rate of 24kHz or 22.05kHz. Table 7-34 lists its specifications.

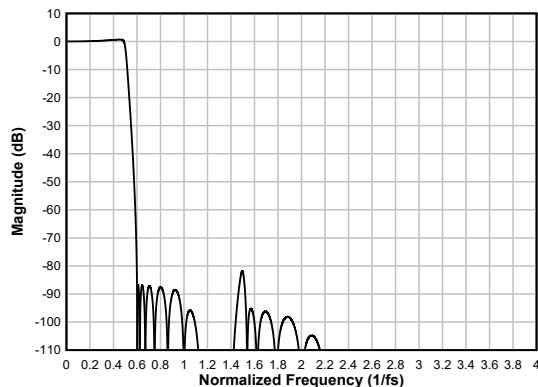

Figure 7-48. Low-latency Decimation Filter Magnitude Response

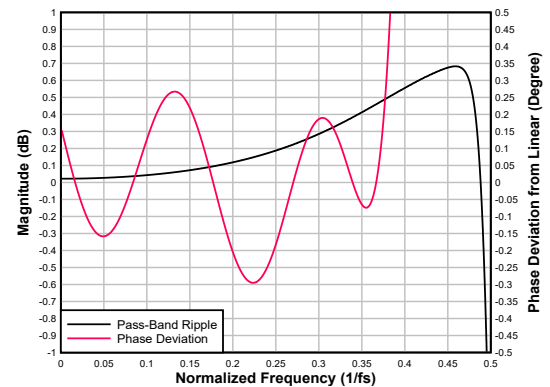

Figure 7-49. Low-latency Decimation Filter Pass-Band Ripple and Phase Deviation

Table 7-34. Low-latency Decimation Filter Specifications

PARAMETER	TEST CONDITIONS	MIN	TYP	MAX	UNIT
Pass-band ripple	Frequency range is 0 to $0.492 \times f_S$	-0.67		0.67	dB
Stop-band attenuation	Frequency range is $0.6 \times f_S$ to $4 \times f_S$	81.8			dB
	Frequency range is $4 \times f_S$ onwards	115			
Group delay or latency	Frequency range is 0 to $0.376 \times f_S$		6.5		$1/f_S$
Group delay deviation	Frequency range is 0 to $0.376 \times f_S$	-0.092		0.029	$1/f_S$
Phase deviation	Frequency range is 0 to $0.376 \times f_S$	-0.3		0.27	Degrees

7.3.9.1.8.2.2 Sampling Rate: 32kHz or 29.4kHz

Figure 7-50 shows the magnitude response and Figure 7-51 shows the pass-band ripple and phase deviation for this decimation filter with a sampling rate of 32kHz or 29.4kHz. Table 7-35 lists its specifications.

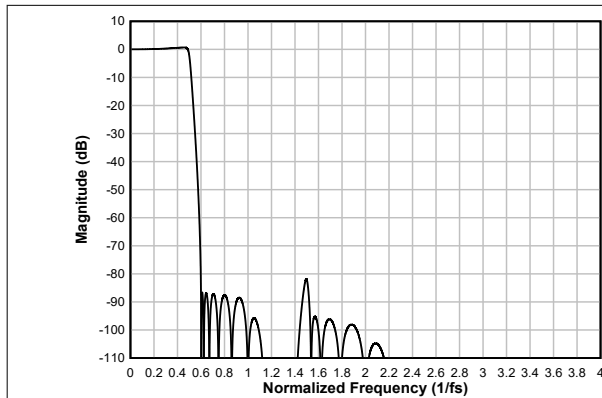

Figure 7-50. Low-latency Decimation Filter Magnitude Response

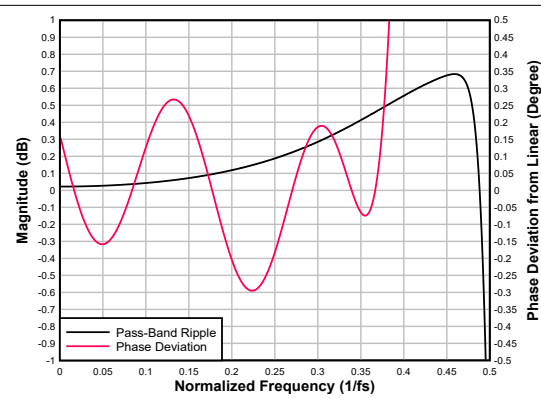

Figure 7-51. Low-latency Decimation Filter Pass-Band Ripple and Phase Deviation

Table 7-35. Low-latency Decimation Filter Specifications

PARAMETER	TEST CONDITIONS	MIN	TYP	MAX	UNIT
Pass-band ripple	Frequency range is 0 to $0.492 \times f_S$	-0.67		0.67	dB
Stop-band attenuation	Frequency range is $0.6 \times f_S$ to $4 \times f_S$	81.8			dB
	Frequency range is $4 \times f_S$ onwards	115			
Group delay or latency	Frequency range is 0 to $0.376 \times f_S$		6.5		$1/f_S$
Group delay deviation	Frequency range is 0 to $0.376 \times f_S$	-0.092		0.029	$1/f_S$
Phase deviation	Frequency range is 0 to $0.376 \times f_S$	-0.3		0.27	Degrees

7.3.9.1.8.2.3 Sampling Rate: 48kHz or 44.1kHz

Figure 7-52 shows the magnitude response and Figure 7-53 shows the pass-band ripple and phase deviation for this decimation filter with a sampling rate of 48kHz or 44.1kHz. Table 7-36 lists its specifications.

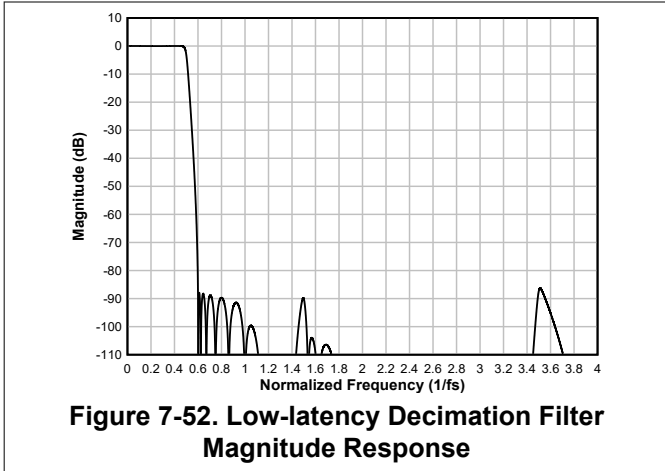

Figure 7-52. Low-latency Decimation Filter Magnitude Response

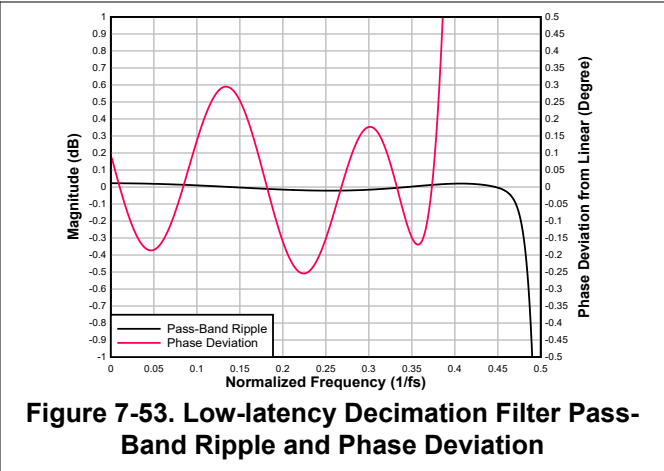

Figure 7-53. Low-latency Decimation Filter Pass-Band Ripple and Phase Deviation

Table 7-36. Low-latency Decimation Filter Specifications

PARAMETER	TEST CONDITIONS	MIN	TYP	MAX	UNIT
Pass-band ripple	Frequency range is 0 to $0.456 \times f_S$	-0.02		0.02	dB
Stop-band attenuation	Frequency range is $0.6 \times f_S$ to $4 \times f_S$	86.3			
	Frequency range is $4 \times f_S$ onwards	96.8			
Group delay or latency	Frequency range is 0 to $0.376 \times f_S$		6.6		$1/f_S$
Group delay deviation	Frequency range is 0 to $0.376 \times f_S$	-0.086		0.027	$1/f_S$
Phase deviation	Frequency range is 0 to $0.376 \times f_S$	-0.25		0.3	Degrees

7.3.9.1.8.2.4 Sampling Rate: 96kHz or 88.2kHz

Figure 7-54 shows the magnitude response and Figure 7-55 shows the pass-band ripple and phase deviation for this decimation filter with a sampling rate of 96kHz or 88.2kHz. Table 7-37 lists its specifications.

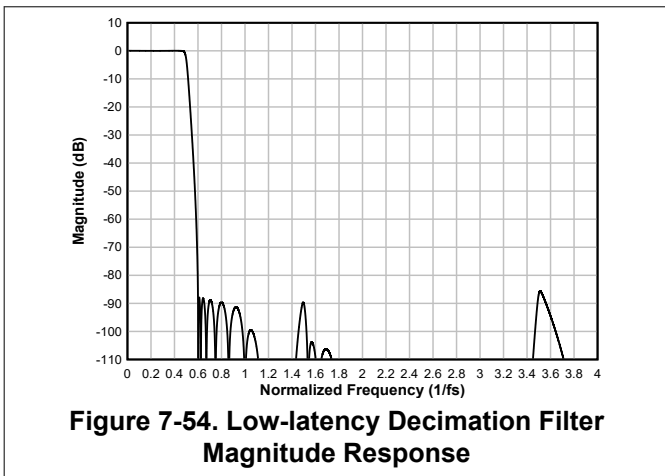

Figure 7-54. Low-latency Decimation Filter Magnitude Response

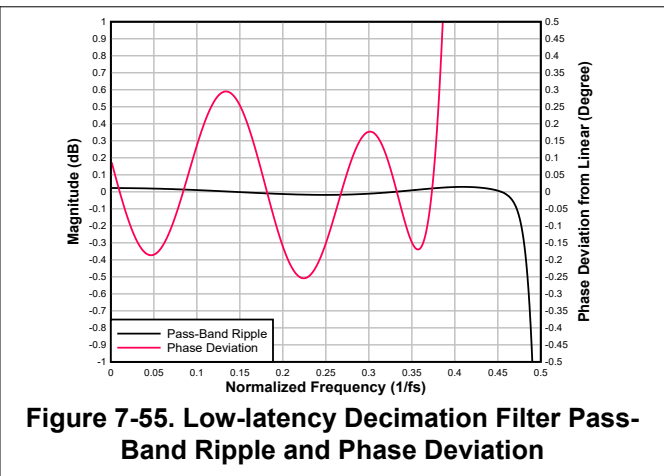

Figure 7-55. Low-latency Decimation Filter Pass-Band Ripple and Phase Deviation

Table 7-37. Low-latency Decimation Filter Specifications

PARAMETER	TEST CONDITIONS	MIN	TYP	MAX	UNIT
Pass-band ripple	Frequency range is 0 to $0.456 \times f_S$	-0.02		0.03	dB
Stop-band attenuation	Frequency range is $0.599 \times f_S$ to $4 \times f_S$	85.6			
	Frequency range is $4 \times f_S$ onwards	95.7			
Group delay or latency	Frequency range is 0 to $0.376 \times f_S$		6.6		$1/f_S$
Group delay deviation	Frequency range is 0 to $0.376 \times f_S$	-0.086		0.022	$1/f_S$

Table 7-37. Low-latency Decimation Filter Specifications (continued)

PARAMETER	TEST CONDITIONS	MIN	TYP	MAX	UNIT
Phase deviation	Frequency range is 0 to $0.376 \times f_S$	-0.25		0.30	Degrees

7.3.9.1.8.2.5 Sampling Rate: 192kHz or 176.4kHz

Figure 7-56 shows the magnitude response and Figure 7-57 shows the pass-band ripple and phase deviation for this decimation filter with a sampling rate of 192kHz or 176.4kHz. Table 7-38 lists its specifications.

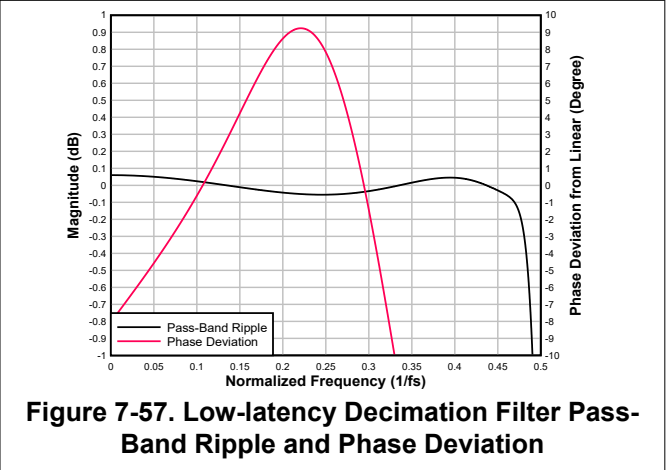
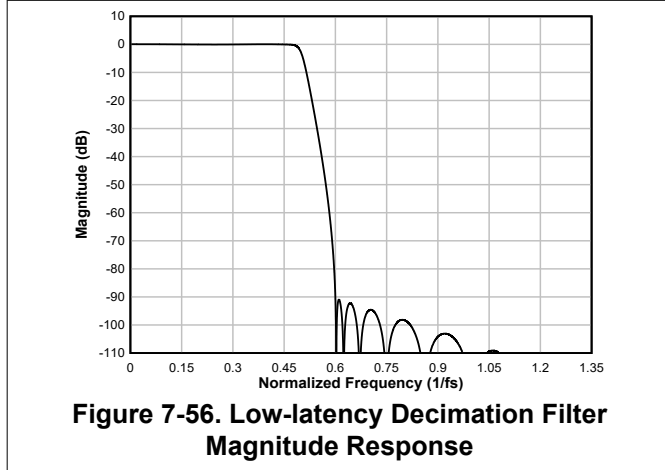

Table 7-38. Low-latency Decimation Filter Specifications

PARAMETER	TEST CONDITIONS	MIN	TYP	MAX	UNIT
Pass-band ripple	Frequency range is 0 to $0.456 \times f_S$	-0.06		0.06	dB
Stop-band attenuation	Frequency range is $0.571 \times f_S$ to $1.35 \times f_S$	90.5			dB
	Frequency range is $1 \times f_S$ onwards	86.9			
Group delay or latency	Frequency range is 0 to $0.327 \times f_S$		6.8		$1/f_S$
Group delay deviation	Frequency range is 0 to $0.327 \times f_S$	-0.296		0.829	$1/f_S$
Phase deviation	Frequency range is 0 to $0.327 \times f_S$	-9.24		9.24	Degrees

7.3.9.1.8.3 Ultra Low-latency Filters

For applications where ultra low latency with minimal phase deviation (within the audio band) is critical, the ultra low-latency decimation filters on the TAC5112 can be used. The device supports these filters with a group delay of approximately four samples with a fair phase response within the $0.325 \times f_S$ frequency band. This section provides the filter performance specifications and various plots for all supported output sampling rates for the ultra low-latency filters.

7.3.9.1.8.3.1 Sampling Rate: 24kHz or 22.05kHz

Figure 7-58 shows the magnitude response and Figure 7-59 shows the pass-band ripple and phase deviation for this decimation filter with a sampling rate of 24kHz or 22.05kHz. Table 7-39 lists its specifications.

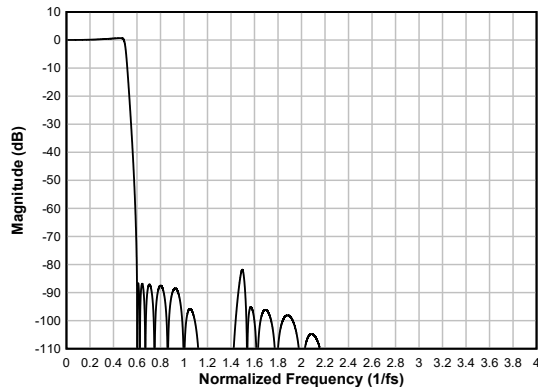

Figure 7-58. Ultra Low-latency Decimation Filter Magnitude Response

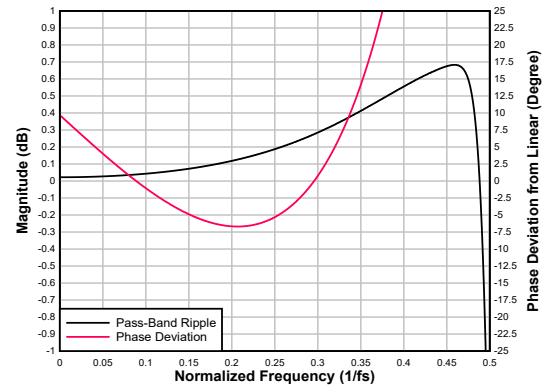

Figure 7-59. Ultra Low-latency Decimation Filter Pass-Band Ripple and Phase Deviation

Table 7-39. Ultra Low-latency Decimation Filter Specifications

PARAMETER	TEST CONDITIONS	MIN	TYP	MAX	UNIT
Pass-band ripple	Frequency range is 0 to $0.492 \times f_S$	-0.67		-0.67	dB
Stop-band attenuation	Frequency range is $0.6 \times f_S$ to $4 \times f_S$	81.8			dB
	Frequency range is $4 \times f_S$ onwards	115			
Group delay or latency	Frequency range is 0 to $0.325 \times f_S$		2.8		$1/f_S$
Group delay deviation	Frequency range is 0 to $0.325 \times f_S$	-0.292		0.765	$1/f_S$
Phase deviation	Frequency range is 0 to $0.325 \times f_S$	-6.7		9.7	Degrees

7.3.9.1.8.3.2 Sampling Rate: 32kHz or 29.4kHz

Figure 7-60 shows the magnitude response and Figure 7-61 shows the pass-band ripple and phase deviation for this decimation filter with a sampling rate of 32kHz or 29.4kHz. Table 7-40 lists its specifications.

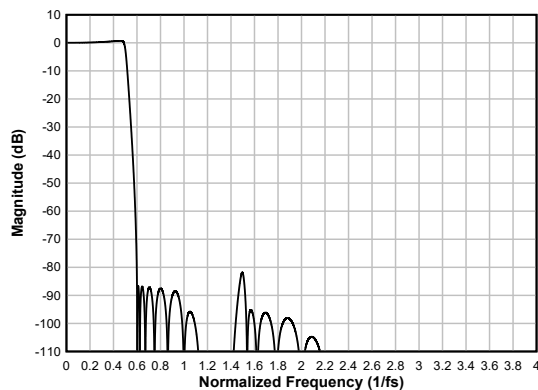

Figure 7-60. Ultra Low-latency Decimation Filter Magnitude Response

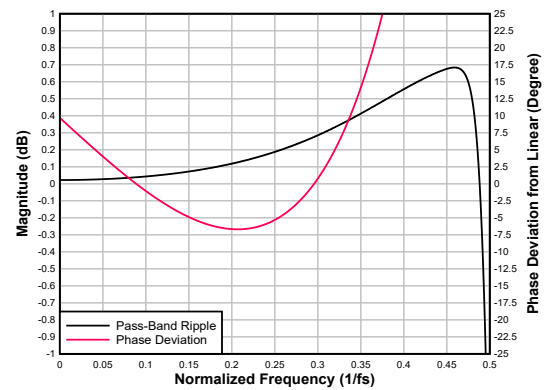

Figure 7-61. Ultra Low-latency Decimation Filter Pass-Band Ripple and Phase Deviation

Table 7-40. Ultra Low-latency Decimation Filter Specifications

PARAMETER	TEST CONDITIONS	MIN	TYP	MAX	UNIT
Pass-band ripple	Frequency range is 0 to $0.492 \times f_S$	-0.67		-0.67	dB
Stop-band attenuation	Frequency range is $0.6 \times f_S$ to $4 \times f_S$	81.8			dB
	Frequency range is $4 \times f_S$ onwards	115			
Group delay or latency	Frequency range is 0 to $0.325 \times f_S$		2.7		$1/f_S$
Group delay deviation	Frequency range is 0 to $0.325 \times f_S$	-0.292		0.765	$1/f_S$

Table 7-40. Ultra Low-latency Decimation Filter Specifications (continued)

PARAMETER	TEST CONDITIONS	MIN	TYP	MAX	UNIT
Phase deviation	Frequency range is 0 to $0.325 \times f_S$	-6.7		9.7	Degrees

7.3.9.1.8.3.3 Sampling Rate: 48kHz or 44.1kHz

Figure 7-62 shows the magnitude response and Figure 7-63 shows the pass-band ripple and phase deviation for this decimation filter with a sampling rate of 48kHz or 44.1kHz. Table 7-41 lists its specifications.

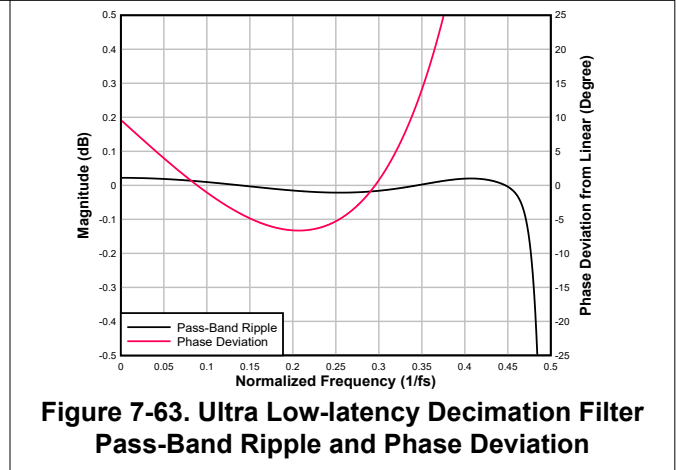
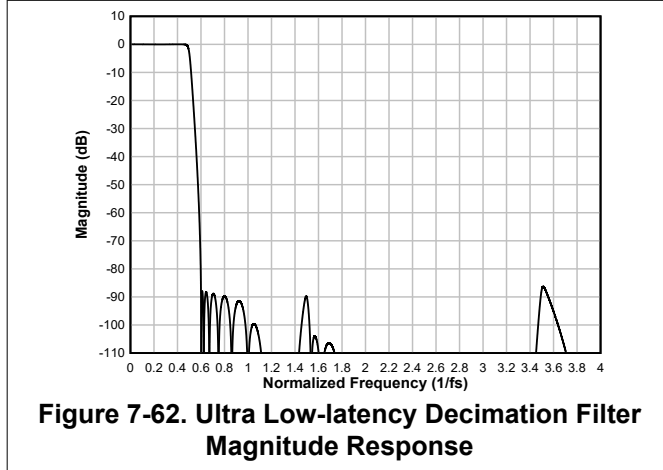

Table 7-41. Ultra Low-latency Decimation Filter Specifications

PARAMETER	TEST CONDITIONS	MIN	TYP	MAX	UNIT
Pass-band ripple	Frequency range is 0 to $0.456 \times f_S$	-0.02		-0.02	dB
Stop-band attenuation	Frequency range is $0.6 \times f_S$ to $4 \times f_S$	86.3			dB
	Frequency range is $4 \times f_S$ onwards	96.8			
Group delay or latency	Frequency range is 0 to $0.325 \times f_S$		2.8		$1/f_S$
Group delay deviation	Frequency range is 0 to $0.325 \times f_S$	-0.29		0.761	$1/f_S$
Phase deviation	Frequency range is 0 to $0.325 \times f_S$	-6.6		9.6	Degrees

7.3.9.1.8.3.4 Sampling Rate: 96kHz or 88.2kHz

Figure 7-64 shows the magnitude response and Figure 7-65 shows the pass-band ripple and phase deviation for this decimation filter with a sampling rate of 96kHz or 88.2kHz. Table 7-42 lists its specifications.

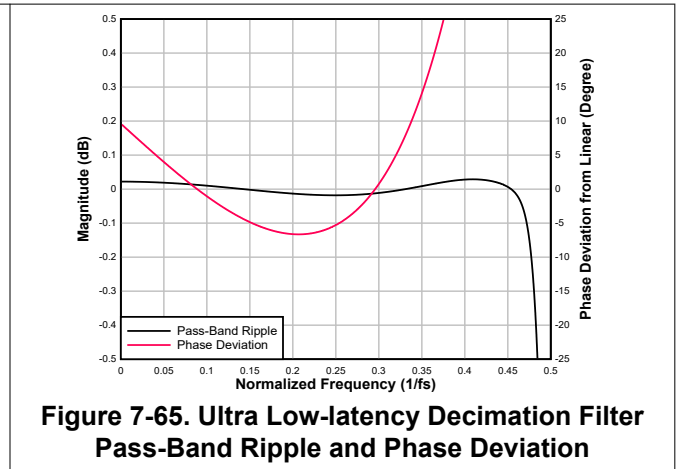
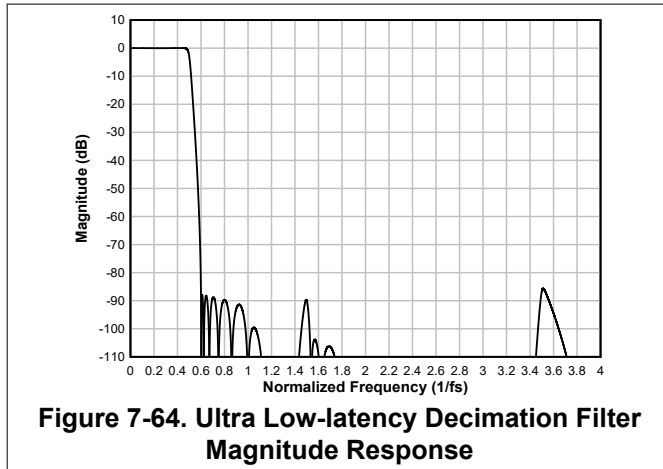
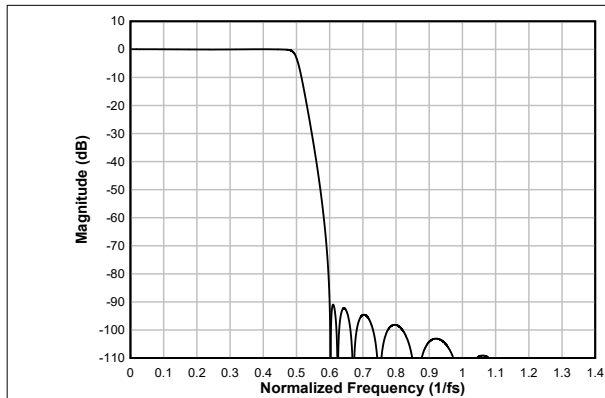
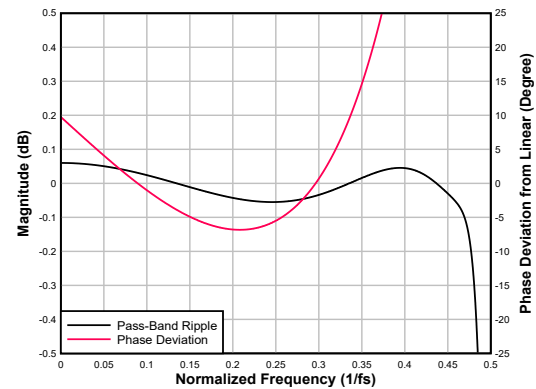

Table 7-42. Ultra Low-latency Decimation Filter Specifications

PARAMETER	TEST CONDITIONS	MIN	TYP	MAX	UNIT
Pass-band ripple	Frequency range is 0 to $0.456 \times f_S$	-0.02		0.03	dB
Stop-band attenuation	Frequency range is $0.599 \times f_S$ to $4 \times f_S$	85.6			dB
	Frequency range is $4 \times f_S$ onwards	95.7			
Group delay or latency	Frequency range is 0 to $0.325 \times f_S$		2.7		$1/f_S$
Group delay deviation	Frequency range is 0 to $0.325 \times f_S$	-0.29		0.761	$1/f_S$
Phase deviation	Frequency range is 0 to $0.325 \times f_S$	-6.6		9.6	Degrees

7.3.9.1.8.3.5 Sampling Rate: 192kHz or 176.4kHz

Figure 7-66 shows the magnitude response and Figure 7-67 shows the pass-band ripple and phase deviation for this decimation filter with a sampling rate of 192kHz or 176.4kHz. Table 7-43 lists its specifications.

**Figure 7-66. Ultra Low-latency Decimation Filter Magnitude Response****Figure 7-67. Ultra Low-latency Decimation Filter Pass-Band Ripple and Phase Deviation****Table 7-43. Ultra Low-latency Decimation Filter Specifications**

PARAMETER	TEST CONDITIONS	MIN	TYP	MAX	UNIT
Pass-band ripple	Frequency range is 0 to $0.456 \times f_S$	-0.06		0.06	dB
Stop-band attenuation	Frequency range is $0.571 \times f_S$ to $1.35 \times f_S$	90.5			dB
	Frequency range is $1.35 \times f_S$ onwards	86.9			
Group delay or latency	Frequency range is 0 to $0.325 \times f_S$		2.7		$1/f_S$
Group delay deviation	Frequency range is 0 to $0.325 \times f_S$	-0.293		0.794	$1/f_S$
Phase deviation	Frequency range is 0 to $0.325 \times f_S$	-6.8		9.8	Degrees

7.3.9.1.9 Automatic Gain Controller (AGC)

The device includes an automatic gain controller (AGC) for ADC recording. As shown in Figure 7-68, the AGC can be used to maintain a nominally constant output level when recording speech. Instead of manually setting the channel gain in AGC mode, the circuitry automatically adjusts the channel gain when the input signal becomes overly loud or very weak, such as when a person speaking into a microphone moves closer to or farther from the microphone. The AGC algorithm has several programmable parameters, including target level, maximum gain allowed, attack and release (or decay) time constants, and noise thresholds that allow the algorithm to be fine-tuned for any particular application. These are part of the programmable coefficients of the device for flexibility and can be configured using the registers in Section 8.2.12 and Section 8.2.13.

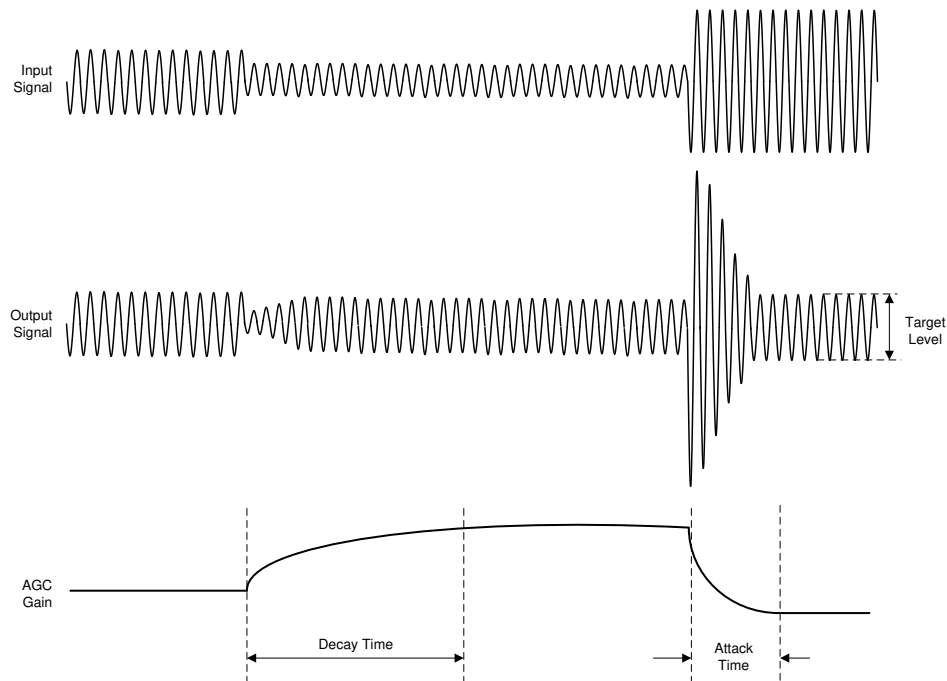

Figure 7-68. AGC Characteristics

The target level (AGC_LVL) represents the nominal approximate output level at which the AGC attempts to hold the ADC output signal level. The TAC5112 allows programming of different target levels. The target level is recommended to be set with enough margin to prevent clipping when loud sounds occur. For further details on the AGC various configurable parameter and application use, see [Using the Automatic Gain Controller \(AGC\) in TAx5x1x Family application report](#). TI recommends using the PPC3 GUI for configuring the programmable coefficients settings; for more details see the [TAC5212EVM-PDK Evaluation module user's guide](#) and the [PurePath™ console graphical development suite](#).

7.3.9.1.10 Voice Activity Detection (VAD)

The TAC5112 supports voice activity detection (VAD) mode as part of low power activity detection (LPAD) schemes. In this mode, the TAC5112 continuously monitors one of the input channels for voice detection. The device consumes low quiescent current from the AVDD supply in this mode. This feature can be enabled by setting VAD_EN (P0_R120_D[2]) to 1'b1. On detecting voice activity, the TAC5112 can alert the host through an interrupt or auto wake up and start recording based on the I²C programmed configuration. This alert can be configured through the LPAD_MODE (P1_R30_D[7:6]) register bits.

This feature is supported on both the analog and digital microphone interfaces. For lowest power VAD, the digital microphone interface is recommended. The input channel for the VAD can be selected by setting the LPAD_CH_SEL (P1_R30_D[5:4]) register bits to an appropriate value. See the [How to use the Voice Activity Detection in the TAx511x and TAx521x application report](#) for further details.

7.3.9.1.11 Ultrasonic Activity Detection (UAD)

The TAC5112 supports ultrasonic activity detection (UAD) mode as part of low power activity detection (LPAD) schemes. In this mode, the TAC5112 continuously monitors one of the input channels for signals in the ultrasonic frequency band. The device consumes low quiescent current from the AVDD supply in this mode. This feature can be enabled by setting UAD_EN (P0_R120_D[3]) to 1'b1. On detecting ultrasonic activity, the TAC5112 can alert the host through an interrupt or auto wake up and start recording based on the I²C programmed configuration. This alert can be configured through the LPAD_MODE (P1_R30_D[7:6]) register bits.

This feature is supported on both the analog and digital microphone interfaces. For lowest power UAD, the digital microphone interface is recommended. The input channel for the UAD can be selected by setting the LPAD_CH_SEL (P1_R30_D[5:4]) register bits to an appropriate value. See the [How to use the Ultrasonic Activity Detection in the TAx511x and TAx521x](#) for further details.

7.3.9.2 DAC Signal-Chain

Figure 7-69 shows the key components of the playback signal chain.

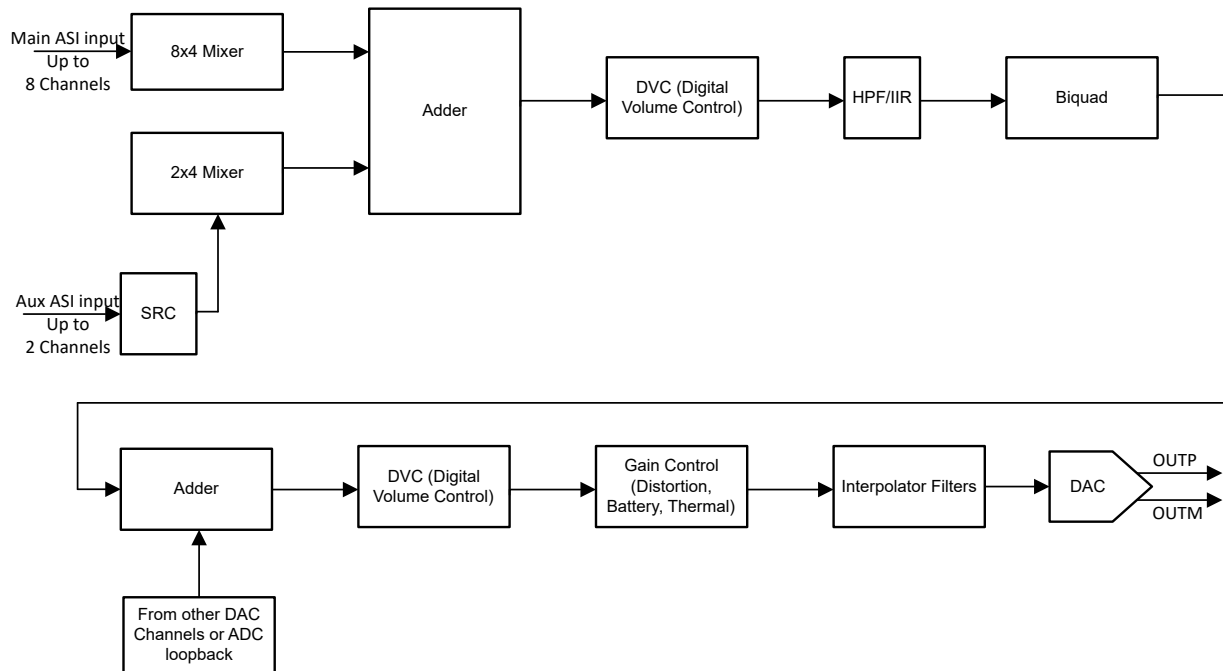

Figure 7-69. DAC Signal-Chain Processing Flowchart

The DAC signal chain offers a highly flexible low-noise playback path for low-noise and high-fidelity audio applications. This low-noise and low-distortion, multibit, delta-sigma DAC enables the TAC5112 to achieve 114dB dynamic range in very low power. Moreover, the DAC architecture has inherent antialias filtering with a high rejection of out-of-band frequency noise around multiple modulator frequency components. Therefore, the device prevents noise from aliasing into the audio band. Further on in the signal chain, an integrated, high-performance multistage digital interpolation filter sharply cuts off any out-of-band frequency noise with high stop-band attenuation.

The signal chain also consists of various highly programmable digital processing blocks such as biquad filters, phase calibration, gain calibration, high-pass filter, digital summer or mixer, synchronous sample rate converter, distortion limiter, thermal foldback, brownout prevention, and volume control. The details of these processing blocks are discussed further in this section. The device also supports up to four-channel single-ended output modes and an analog bypass option from ADC input to DAC output.

The output channels for playback can be enabled or disabled by using the CH_EN (P0_R118) register, and the input channels for the audio serial interface can be enabled or disabled by using the PASI_RX_CHx_CFG or SASI_RX_CHx_CFG bits. The device supports simultaneous power-up and power-down of all active channels for simultaneous playback. However, based on the application needs, if some channels must be powered-up or powered-down dynamically when the other channel playback is on, then that use case is supported by setting the DYN_PUPD_CFG (P0_R119) register.

The device supports multiple data mixing options where up to 8 Input Channels from Main ASI, 2 Input Channels from Aux ASI, ADC loopback data, and tone generator can be mixed with flexible gain options for each path before playback on DAC output. By default, these mixers are disabled and channels are configured for only one channel of data. Mixers can be configured by setting ASI_DIN_Mixers programmable coefficient registers described in [Section 8.2.7](#).

The device supports an output signal bandwidth of up to 90kHz, which allows the high-frequency non-audio signal to be played by using a 216kHz (or higher) sample rate. Wideband mode can be enabled or disabled by using the DAC_CHx_BW_Mode bit (P0_R101_D[0], P0_R108_D[0]).

For sample rates of 48kHz or lower, the device supports all features and various programmable processing blocks. However, for sample rates higher than 48kHz, there are limitations in the number of simultaneous channel recordings and playback supported and the number of biquad filters and such. See the [TAC5212 Sampling Rates and Programmable Processing Blocks Supported application report](#) for further details.

7.3.9.2.1 Programmable Channel Gain and Digital Volume Control

The device has an independent programmable channel gain setting for each output channel that can be set to the appropriate value based on the maximum input signal expected in the system. This can be done by configuring OUT1x_LVL_CTRL and OUT2x_LVL_CTRL bits. Coarse gain configuration from -12dB to +12dB is available with these controls in steps of 6dB.

The device has a programmable digital volume control with a range from -100dB to 27dB in steps of 0.5dB with the option to mute the channel recording. The digital volume control value can be changed dynamically while the DAC channel is powered-up and playing. During volume control changes, the soft ramp-up or ramp-down volume feature is used internally to avoid any audible artifacts. Soft-stepping can be entirely disabled using the DAC_DSP_DISABLE_SOFT_STEP (P0_R115_D[1]) register bit.

The digital volume control setting is independently available for each of the 4 single-ended output channels. In the case of 2-Channel Differential DAC, only settings for DAC_CH1A and DAC_CH2A are applicable. The device also supports an option to gang up the volume control setting for all channels together using the channel 1A digital volume control setting, regardless if channel 1A is powered up or powered down. This gang-up can be enabled using the DAC_DSP_DVOL_GANG (P0_R115_D[0]) register bit.

Table 7-44 shows the programmable options available for the digital volume control.

Table 7-44. Digital Volume Control (DVC) Programmable Settings

P0_R103_D[7:0] : DAC_CH1A_DVOL[7:0]	DVC SETTING FOR OUTPUT CHANNEL 1A
0000 0000 = 0d	Output channel 1 DVC is set to mute
0000 0001 = 1d	Output channel 1 DVC is set to -100dB
0000 0010 = 2d	Output channel 1 DVC is set to -99.5dB
0000 0011 = 3d	Output channel 1 DVC is set to -99dB
...	...
1100 1000 = 200d	Output channel 1 DVC is set to -0.5dB
1100 1001 = 201d (default)	Output channel 1 DVC is set to 0dB
1100 1010 = 202d	Output channel 1 DVC is set to 0.5dB
...	...
1111 1101 = 253d	Output channel 1 DVC is set to 26dB
1111 1110 = 254d	Output channel 1 DVC is set to 26.5dB
1111 1111 = 255d	Output channel 1 DVC is set to 27dB

Similarly, the digital volume control setting for output channels 1B, 2A, and 2B can be configured using the CH1B_DVOL (P0_R103) to CH2B_DVOL (P0_R112) register bits, respectively.

The internal digital processing engine soft ramps up the volume from a muted level to the programmed volume level when the channel is powered up, and the internal digital processing engine soft ramps down the volume from a programmed volume to mute when the channel is powered down. This soft-stepping of volume is done to prevent abruptly powering up and powering down the playback channel which can cause audible artifacts. This feature can also be entirely disabled using the DAC_DSP_DISABLE_SOFT_STEP (P0_R115_D[1]) register bit.

7.3.9.2.2 Programmable Channel Gain Calibration

Along with the digital volume control, this device also provides programmable channel gain calibration. The gain of each channel can be finely calibrated or adjusted in steps of 0.1dB for a range of -0.8dB to 0.7dB gain error. This adjustment is useful when trying to match the gain across channels resulting from transducer sensitivity and load impedance mismatch. This feature, in combination with the regular digital volume control, allows the gains

across all channels to be matched for a wide gain error range with a resolution of 0.1dB. [Table 7-45](#) shows the programmable options available for the channel gain calibration.

Table 7-45. DAC Channel Gain Calibration Programmable Settings

P0_R104_D[7:4] : DAC_CH1A_FGAIN[3:0]	CHANNEL GAIN CALIBRATION SETTING FOR INPUT CHANNEL 1A
0000 = 0d	Input channel 1 gain calibration is set to -0.8 dB
0001 = 1d	Input channel 1 gain calibration is set to -0.7 dB
...	...
1000 = 8d (default)	Input channel 1 gain calibration is set to 0 dB
...	...
1110 = 14d	Input channel 1 gain calibration is set to 0.6 dB
1111 = 15d	Input channel 1 gain calibration is set to 0.7 dB

Similarly, the channel gain calibration setting for input channel 1B, 2A and 2B can be configured using the DAC_CH1B_CFG1 (P0_R106), DAC_CH2A_CFG1 (P0_R111), and DAC_CH2B_CFG1 (P0_R113) register bits, respectively.

7.3.9.2.3 Programmable Digital High-Pass Filter

To remove the DC offset component and attenuate the undesired low-frequency noise content in the record data, the device supports a programmable high-pass filter (HPF). The HPF is not a channel-independent filter setting but is globally applicable for all DAC channels. This HPF is constructed using the first-order infinite impulse response (IIR) filter, and is efficient enough to filter out possible DC components of the signal. [Table 7-46](#) shows the predefined -3dB cutoff frequencies available that can be set by using the DAC_DSP_HPF_SEL[1:0] register bits of P0_R115. Additionally, to achieve a custom -3dB cutoff frequency for a specific application, the device also allows the first-order IIR filter coefficients to be programmed when the DAC_DSP_HPF_SEL[1:0] register bits are set to 2'b00. [Figure 7-70](#) illustrates a frequency response plot for the HPF filter.

Table 7-46. HPF Programmable Settings

P0_R115_D[5:4] : DAC_DSP_HPF_SEL[1:0]	-3dB CUTOFF FREQUENCY SETTING	-3dB CUTOFF FREQUENCY AT 16kHz SAMPLE RATE	-3dB CUTOFF FREQUENCY AT 48-kHz SAMPLE RATE
00	Programmable 1st-order IIR filter	Programmable 1st-order IIR filter	Programmable 1st-order IIR filter
01 (default)	$0.00002 \times f_s$	0.25 Hz	1 Hz
10	$0.00025 \times f_s$	4 Hz	12 Hz
11	$0.002 \times f_s$	32 Hz	96 Hz

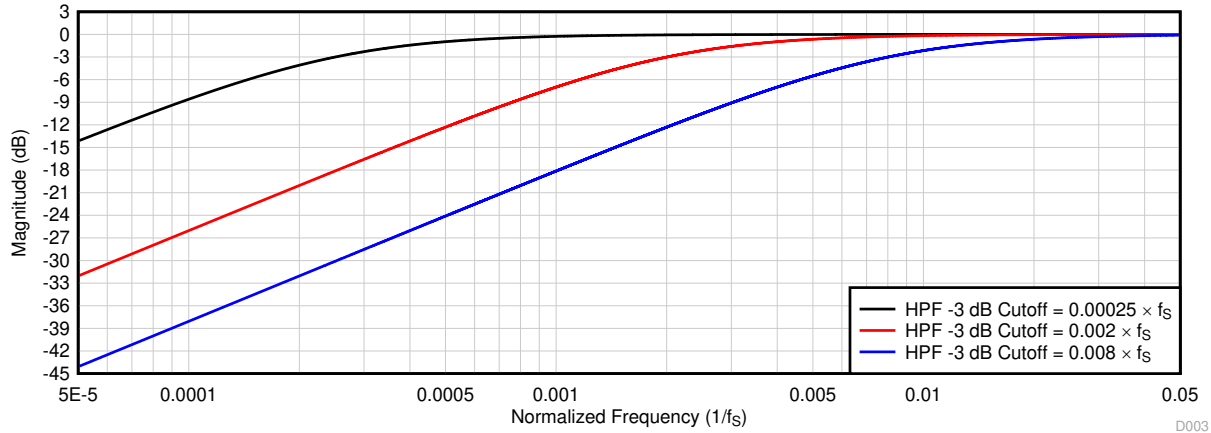

Figure 7-70. HPF Filter Frequency Response Plot

D003

Equation 3 gives the transfer function for the first-order programmable IIR filter:

$$H(z) = \frac{N_0 + N_1 z^{-1}}{2^{31} - D_1 z^{-1}} \quad (3)$$

The frequency response for this first-order programmable IIR filter with default coefficients is flat at a gain of 0dB (all-pass filter). The host device can override the frequency response by programming the IIR coefficients in Table 7-47 to achieve the desired frequency response for high-pass filtering or any other desired filtering. If DAC_DSP_HP_SEL[1:0] are set to 2'b00, the host device must write these coefficients values for the desired frequency response before powering-up any DAC channel for playback. Table 7-47 shows the filter coefficients for the first-order IIR filter. For additional details on configuring the programmable coefficients, refer Section 8.2.

Table 7-47. 1st-Order IIR Filter Coefficients

FILTER	FILTER COEFFICIENT	DEFAULT COEFFICIENT VALUE	COEFFICIENT REGISTER MAPPING
Programmable 1st-order IIR filter (can be allocated to HPF or any other desired filter)	N ₀	0x7FFFFFFF	P17_R120-R124
	N ₁	0x00000000	P17_R125-R128
	D ₁	0x00000000	P18_R8-R11

7.3.9.2.4 Programmable Digital Biquad Filters

The device supports up to 12 programmable digital biquad filters available for DAC signal chain limited to 3/channel. These highly efficient filters achieve the desired frequency response. The TAC5112 also supports on the fly programmable Biquad filters for two channel playback use case. In digital signal processing, a digital biquad filter is a second-order, recursive linear filter with two poles and two zeros. Equation 2 gives the transfer function of each biquad filter:

$$H(z) = \frac{N_0 + 2N_1 z^{-1} + N_2 z^{-2}}{2^{31} - 2D_1 z^{-1} - D_2 z^{-2}} \quad (4)$$

The frequency response for the biquad filter section with default coefficients is flat at a gain of 0dB (all-pass filter). The host device can override the frequency response by programming the biquad coefficients to achieve the desired frequency response for a low-pass, high-pass, or any other desired frequency shaping. The programmable coefficients for the biquads are located in the Section 8.2.5 and Section 8.2.6. If biquad filtering is required, then the host device must write these coefficients values before powering up any ADC channels for recording or DAC channels for playback. In two channel use case, the TAC5112 also supports on the fly programmable filters. In this case, the device uses two banks of filters for one channel with a switch bit to

perform the switch from one filter bank to the other. As described in [Table 7-48](#), these biquad filters can be allocated for each output channel based on the DAC_DSP_BQ_CFG[1:0] register setting of P0_R115. By setting DAC_DSP_BQ_CFG[1:0] to 2'b00, the biquad filtering for all playback channels are disabled and the host device can choose this setting if no additional filtering is required for the system application. See the [TAC5x1x and TAC5x1x-Q1 Programmable Biquad Filters - Configuration and Applications application report](#) for further details.

Table 7-48. Biquad Filter Allocation to the Record Output Channel

PROGRAMMABLE BIQUAD FILTER	PLAYBACK OUTPUT CHANNEL ALLOCATION USING P0_R115_D[3:2] REGISTER SETTING		
	DAC_DSP_BQ_CFG[1:0] = 2'b01 (1 Biquad per Channel)	DAC_DSP_BQ_CFG[1:0] = 2'b10 (Default) (2 Biquads per Channel)	DAC_DSP_BQ_CFG[1:0] = 2'b11 (3 Biquads per Channel)
Biquad filter 1	Allocated to output channel 1	Allocated to output channel 1	Allocated to output channel 1
Biquad filter 2	Allocated to output channel 2	Allocated to output channel 2	Allocated to output channel 2
Biquad filter 3	Allocated to output channel 3	Allocated to output channel 3	Allocated to output channel 3
Biquad filter 4	Allocated to output channel 4	Allocated to output channel 4	Allocated to output channel 4
Biquad filter 5	Not used	Allocated to output channel 1	Allocated to output channel 1
Biquad filter 6	Not used	Allocated to output channel 2	Allocated to output channel 2
Biquad filter 7	Not used	Allocated to output channel 3	Allocated to output channel 3
Biquad filter 8	Not used	Allocated to output channel 4	Allocated to output channel 4
Biquad filter 9	Not used	Not used	Allocated to output channel 1
Biquad filter 10	Not used	Not used	Allocated to output channel 2
Biquad filter 11	Not used	Not used	Allocated to output channel 3
Biquad filter 12	Not used	Not used	Allocated to output channel 4

[Table 7-49](#) shows the biquad filter coefficients mapping to the register space.

Table 7-49. Biquad Filter Coefficients Register Mapping

PROGRAMMABLE BIQUAD FILTER	BIQUAD FILTER COEFFICIENTS REGISTER MAPPING	PROGRAMMABLE BIQUAD FILTER	BIQUAD FILTER COEFFICIENTS REGISTER MAPPING
Biquad filter 1	P16_R8-R27	Biquad filter 7	P17_R8-R27
Biquad filter 2	P16_R28-R47	Biquad filter 8	P17_R28-R47
Biquad filter 3	P16_R48-R67	Biquad filter 9	P17_R48-R67
Biquad filter 4	P16_R68-R87	Biquad filter 10	P17_R68-R87
Biquad filter 5	P16_R88-R107	Biquad filter 11	P17_R88-R107
Biquad filter 6	P16_R108-R127	Biquad filter 12	P17_R108-R127

7.3.9.2.5 Programmable Digital Mixer

The device supports a fully programmable mixer feature that can mix the various input channels with their custom programmable scale factor to generate the final output channels. [Figure 7-29](#) shows a block diagram that describes the mixer 1 operation to generate output channel 1. The programmable coefficients for the mixer operation are located in the section.

A similar mixer operation is performed by mixer 2, mixer 3, and mixer 4 to generate output channel 2, channel 3, and channel 4, respectively.

7.3.9.2.6 Configurable Digital Interpolation Filters

The device playback channel includes a high dynamic range, built-in digital interpolation filter to process the input data stream to generate digital data stream for multibit delta-sigma ($\Delta\Sigma$) modulator. The interpolation filter can be chosen from four different types, depending on the required frequency response, group delay, power consumption, and phase linearity requirements for the target application. The selection of the interpolation filter option can be done by configuring the DAC_DSP_INTX_FILT (P0_R115_D[7:6]) register bits. Low power filter can be configured by setting DAC_LOW_PWR_FILT (P0_R79_D[2]) bit. Table 7-50 shows the configuration register setting for the decimation filter mode selection for the record channel.

Table 7-50. Interpolation Filter Mode Selection for the Playback Channel

P0_R79_D[2] : DAC_LOW_PWR_FILT	P0_R115_D[7:6] : DAC_DSP_INTX_FILT[1:0]	INTERPOLATION FILTER MODE SELECTION
0	00 (default)	Linear phase filters are used for the interpolation
0	01	Low latency filters are used for the interpolation
0	10	Ultra-low latency filters are used for the interpolation
0	11	Reserved (do not use this setting)
1	XX	Low power filters are used for the interpolation

7.3.9.2.6.1 Linear-phase filters

The linear-phase interpolation filters are the default filters set by the device and can be used for all applications that require a perfect linear phase with zero-phase deviation within the pass-band specification of the filter. The filter performance specifications and various plots for all supported output sampling rates are listed in this section.

7.3.9.2.6.1.1 Sampling Rate: 8kHz or 7.35kHz

Figure 7-71 and Figure 7-72 respectively show the magnitude response and the pass-band ripple for this interpolation filter with a sampling rate of 8kHz or 7.35kHz, and Table 7-51 lists its specifications.

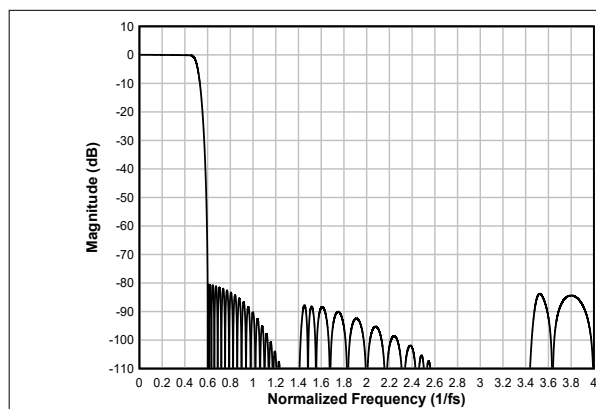

Figure 7-71. Linear-phase Interpolation Filter Magnitude Response

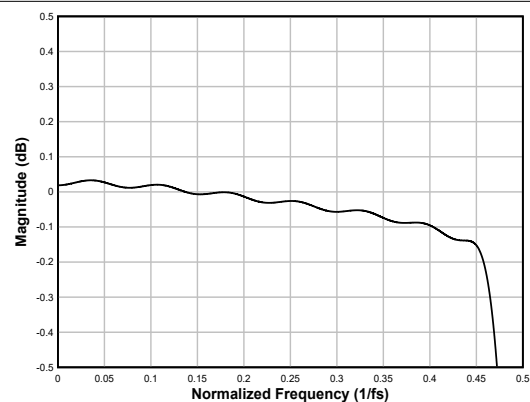

Figure 7-72. Linear-phase Interpolation Filter Pass-Band Ripple

Table 7-51. Linear-phase Interpolation Filter Specifications

PARAMETER	TEST CONDITIONS	MIN	TYP	MAX	UNIT
Pass-band ripple	Frequency range is 0 to $0.455 \times f_s$	-0.17		0.03	dB
Stop-band attenuation	Frequency range is $0.6 \times f_s$ to $4 \times f_s$	80.4			dB
	Frequency range is $4 \times f_s$ to $7.431 \times f_s$	86.9			
Group delay or latency	Frequency range is 0 to $0.455 \times f_s$		16		$1/f_s$

7.3.9.2.6.1.2 Sampling Rate: 16kHz or 14.7kHz

Figure 7-73 and Figure 7-74 respectively show the magnitude response and the pass-band ripple for this interpolation filter with a sampling rate of 16kHz or 14.7kHz, and Table 7-52 lists its specifications.

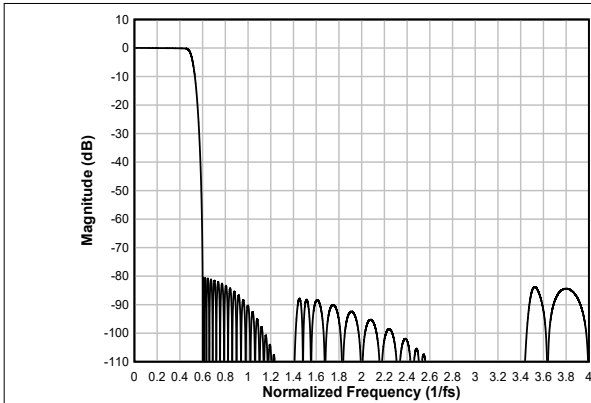

Figure 7-73. Linear-phase Interpolation Filter Magnitude Response

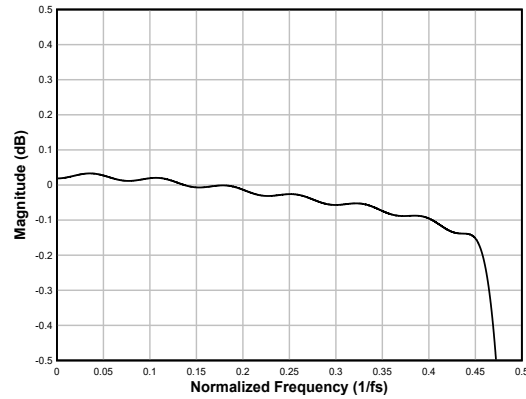

Figure 7-74. Linear-phase Interpolation Filter Pass-Band Ripple

Table 7-52. Linear-phase Interpolation Filter Specifications

PARAMETER	TEST CONDITIONS	MIN	TYP	MAX	UNIT
Pass-band ripple	Frequency range is 0 to $0.455 \times f_s$	-0.17		0.03	dB
Stop-band attenuation	Frequency range is $0.6 \times f_s$ to $4 \times f_s$	80.4			dB
	Frequency range is $4 \times f_s$ to $7.431 \times f_s$	86.9			
Group delay or latency	Frequency range is 0 to $0.455 \times f_s$		16		$1/f_s$

7.3.9.2.6.1.3 Sampling Rate: 24kHz or 22.05kHz

Figure 7-75 and Figure 7-76 respectively show the magnitude response and the pass-band ripple for this interpolation filter with a sampling rate of 24kHz or 22.05kHz, and Table 7-53 lists its specifications.

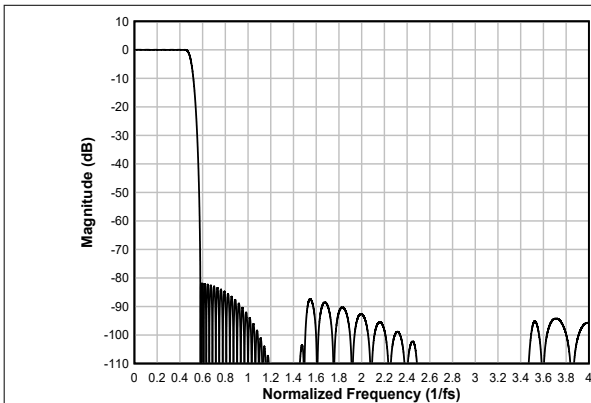

Figure 7-75. Linear-phase Interpolation Filter Magnitude Response

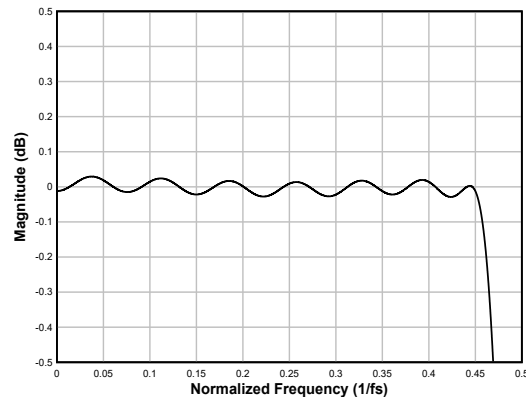

Figure 7-76. Linear-phase Interpolation Filter Pass-Band Ripple

Table 7-53. Linear-phase Interpolation Filter Specifications

PARAMETER	TEST CONDITIONS	MIN	TYP	MAX	UNIT
Pass-band ripple	Frequency range is 0 to $0.455 \times f_s$	-0.05		0.03	dB
Stop-band attenuation	Frequency range is $0.58 \times f_s$ to $4 \times f_s$	81.9			dB
	Frequency range is $4 \times f_s$ to $8 \times f_s$	87.7			

Table 7-53. Linear-phase Interpolation Filter Specifications (continued)

PARAMETER	TEST CONDITIONS	MIN	TYP	MAX	UNIT
Group delay or latency	Frequency range is 0 to $0.455 \times f_S$		17.6		$1/f_S$

7.3.9.2.6.1.4 Sampling Rate: 32kHz or 29.4kHz

Figure 7-77 and Figure 7-78 respectively show the magnitude response and the pass-band ripple for this interpolation filter with a sampling rate of 32kHz or 29.4kHz, and Table 7-54 lists its specifications.

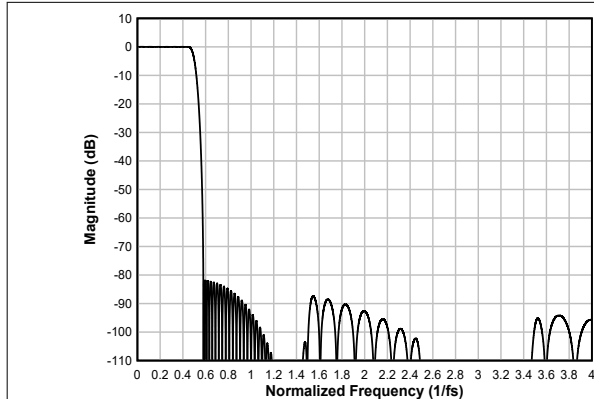
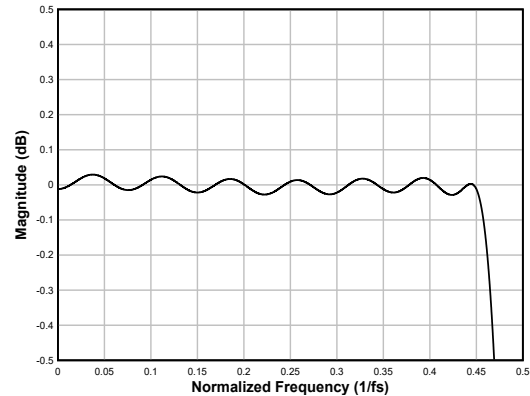
**Figure 7-77. Linear-phase Interpolation Filter Magnitude Response****Figure 7-78. Linear-phase Interpolation Filter Pass-Band Ripple****Table 7-54. Linear-phase Interpolation Filter Specifications**

PARAMETER	TEST CONDITIONS	MIN	TYP	MAX	UNIT
Pass-band ripple	Frequency range is 0 to $0.455 \times f_S$	-0.05		0.03	dB
Stop-band attenuation	Frequency range is $0.58 \times f_S$ to $4 \times f_S$	81.9			
	Frequency range is $4 \times f_S$ to $8 \times f_S$	87.6			
Group delay or latency	Frequency range is 0 to $0.455 \times f_S$		17.6		$1/f_S$

7.3.9.2.6.1.5 Sampling Rate: 48kHz or 44.1kHz

Figure 7-79 and Figure 7-80 respectively show the magnitude response and the pass-band ripple for this interpolation filter with a sampling rate of 48kHz or 44.1kHz, and Table 7-55 lists its specifications.

**Figure 7-79. Linear-phase Interpolation Filter Magnitude Response****Figure 7-80. Linear-phase Interpolation Filter Pass-Band Ripple**

Table 7-55. Linear-phase Interpolation Filter Specifications

PARAMETER	TEST CONDITIONS	MIN	TYP	MAX	UNIT
Pass-band ripple	Frequency range is 0 to $0.455 \times f_S$	-0.09		0.02	dB
Stop-band attenuation	Frequency range is $0.58 \times f_S$ to $4 \times f_S$	82			dB
	Frequency range is $4 \times f_S$ to $7.423 \times f_S$	89.1			
Group delay or latency	Frequency range is 0 to $0.455 \times f_S$		17.3		$1/f_S$

7.3.9.2.6.1.6 Sampling Rate: 96kHz or 88.2kHz

Figure 7-81 and Figure 7-82 respectively show the magnitude response and the pass-band ripple for this interpolation filter with a sampling rate of 96kHz or 88.2kHz, and Table 7-56 lists its specifications.

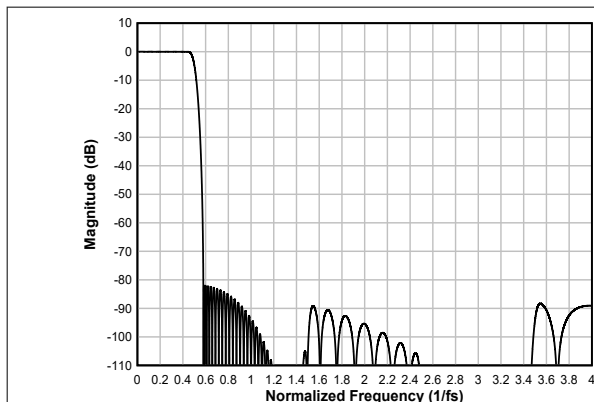
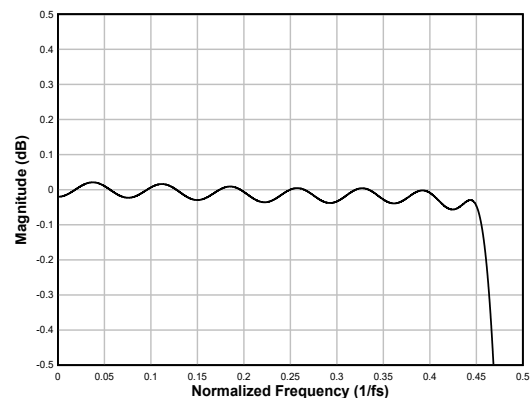
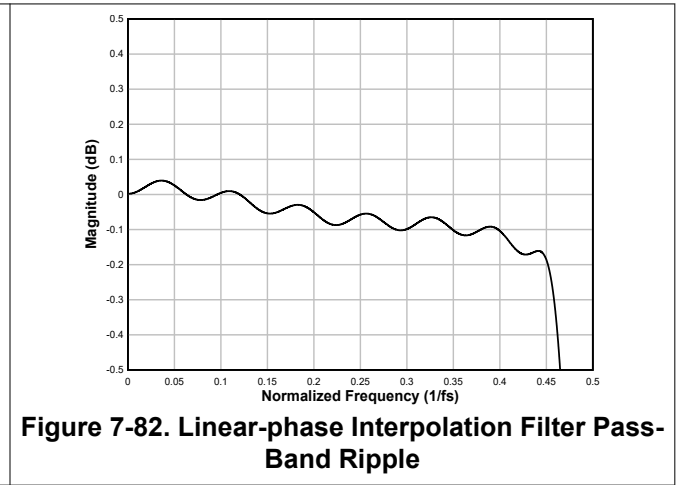
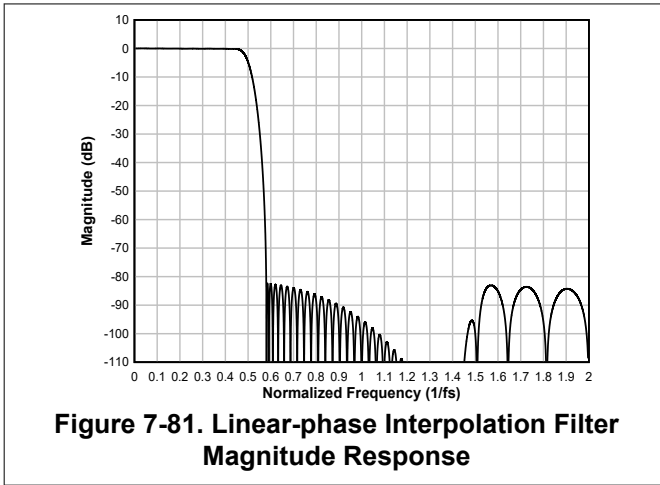

Table 7-56. Linear-phase Interpolation Filter Specifications

PARAMETER	TEST CONDITIONS	MIN	TYP	MAX	UNIT
Pass-band ripple	Frequency range is 0 to $0.455 \times f_S$	-0.23		0.04	dB
Stop-band attenuation	Frequency range is $0.58 \times f_S$ to $2 \times f_S$	82.4			dB
	Frequency range is $2 \times f_S$ to $3.422 \times f_S$	85.1			
Group delay or latency	Frequency range is 0 to $0.455 \times f_S$		16.7		$1/f_S$

7.3.9.2.6.1.7 Sampling Rate: 192kHz or 176.4kHz

Figure 7-83 and Figure 7-84 respectively show the magnitude response and the pass-band ripple for this interpolation filter with a sampling rate of 192kHz or 176.4kHz, and Table 7-57 lists its specifications.

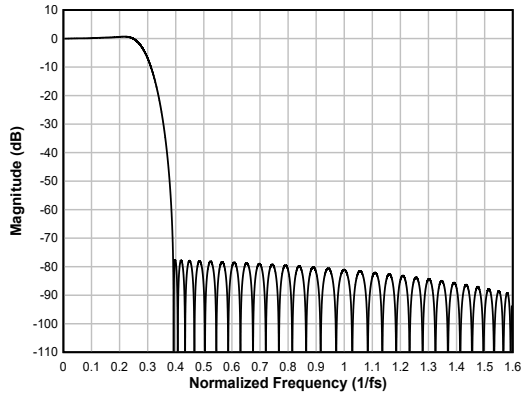

Figure 7-83. Linear-phase Interpolation Filter Magnitude Response

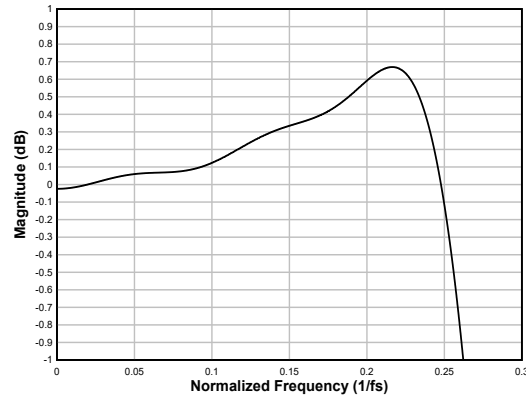

Figure 7-84. Linear-phase Interpolation Filter Pass-Band Ripple

Table 7-57. Linear-phase Interpolation Filter Specifications

PARAMETER	TEST CONDITIONS	MIN	TYP	MAX	UNIT
Pass-band ripple	Frequency range is 0 to $0.258 \times f_S$	-0.67		0.67	dB
Stop-band attenuation	Frequency range is $0.391 \times f_S$ to $1 \times f_S$	77.7			dB
	Frequency range is $1 \times f_S$ to $1.612 \times f_S$	81.1			
Group delay or latency	Frequency range is 0 to $0.258 \times f_S$		10.7		$1/f_S$

7.3.9.2.6.1.8 Sampling Rate: 384kHz or 352.8kHz

Figure 7-85 and Figure 7-86 respectively show the magnitude response and the pass-band ripple for this interpolation filter with a sampling rate of 384kHz or 352.8kHz, and Table 7-58 lists its specifications.

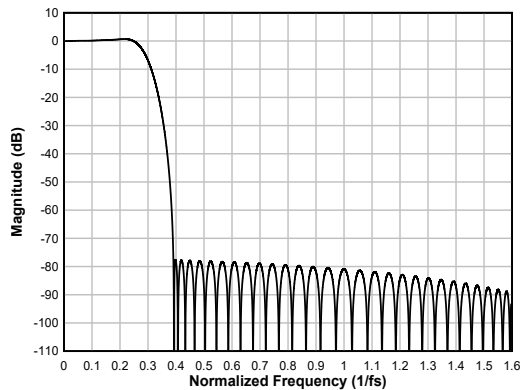

Figure 7-85. Linear-phase Interpolation Filter Magnitude Response

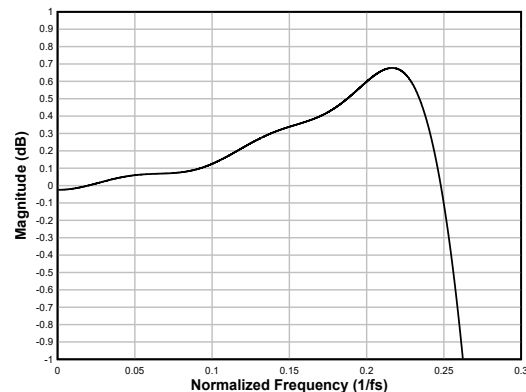

Figure 7-86. Linear-phase Interpolation Filter Pass-Band Ripple

Table 7-58. Linear-phase Interpolation Filter Specifications

PARAMETER	TEST CONDITIONS	MIN	TYP	MAX	UNIT
Pass-band ripple	Frequency range is 0 to $0.258 \times f_S$	-0.67		0.67	dB
Stop-band attenuation	Frequency range is $0.391 \times f_S$ to $1 \times f_S$	77.7			dB
	Frequency range is $1 \times f_S$ to $1.612 \times f_S$	81.1			
Group delay or latency	Frequency range is 0 to $0.258 \times f_S$		10.7		$1/f_S$

7.3.9.2.6.1.9 Sampling Rate 768kHz or 705.6kHz

Figure 7-87 and Figure 7-88 respectively show the magnitude response and the pass-band ripple for this interpolation filter with a sampling rate of 768kHz or 705.6kHz, and Table 7-59 lists its specifications.

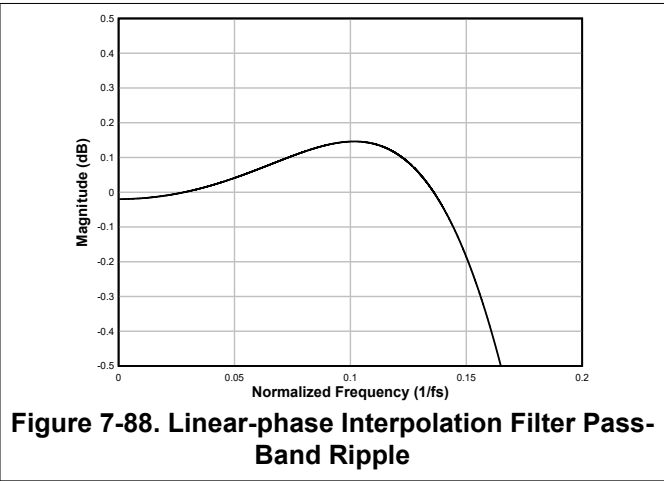
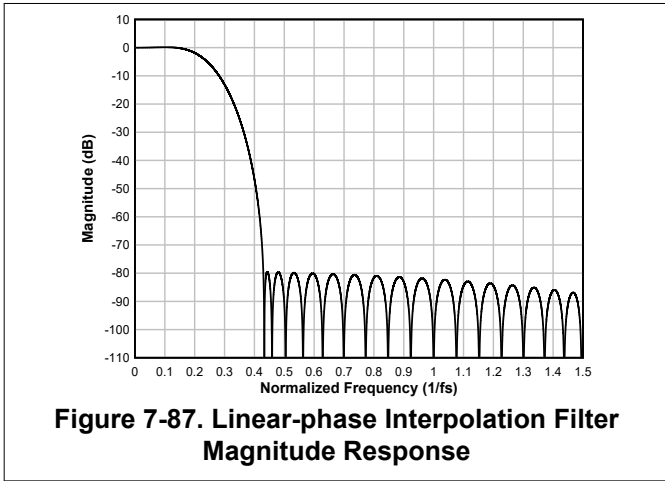

Table 7-59. Linear-phase Interpolation Filter Specifications

PARAMETER	TEST CONDITIONS	MIN	TYP	MAX	UNIT
Pass-band ripple	Frequency range is 0 to $0.153 \times f_s$	-0.15		0.15	dB
Stop-band attenuation	Frequency range is $0.43 \times f_s$ to $1 \times f_s$	79.1			dB
	Frequency range is $1 \times f_s$ onwards	82.2			
Group delay or latency	Frequency range is 0 to $0.113 \times f_s$		5.9		$1/f_s$

7.3.9.2.6.2 Low-latency Filters

For applications where low latency with minimal phase deviation (within the audio band) is critical, the low-latency interpolation filters on the TAC5112 can be used. The device supports these filters with a group delay of approximately seven samples with an almost linear phase response within the $0.376 \times f_S$ frequency band. This section provides the filter performance specifications and various plots for all supported output sampling rates for the low-latency filters.

7.3.9.2.6.2.1 Sampling Rate: 24kHz or 22.05kHz

Figure 7-89 shows the magnitude response and Figure 7-90 shows the pass-band ripple and phase deviation for this interpolation filter with a sampling rate of 24kHz or 22.05kHz. Table 7-60 lists its specifications.

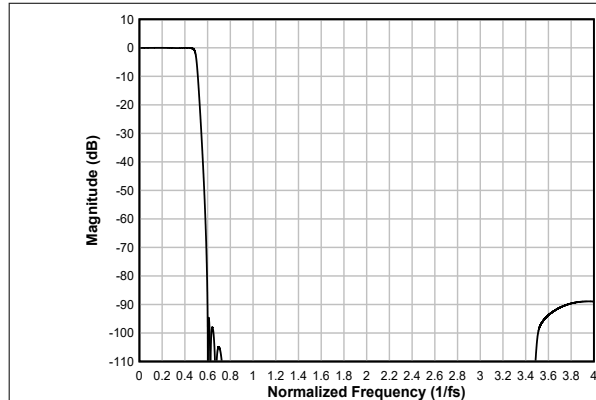

Figure 7-89. Low-latency Interpolation Filter Magnitude Response

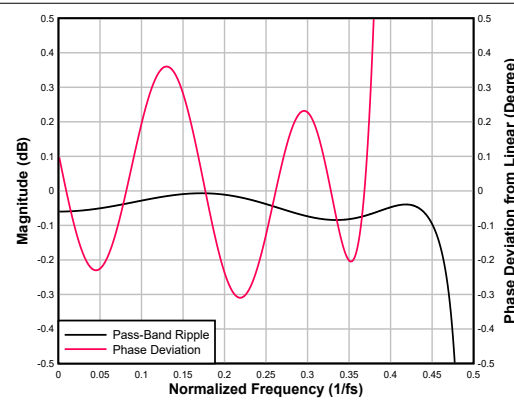

Figure 7-90. Low-latency Interpolation Filter Pass-Band Ripple and Phase Deviation

Table 7-60. Low-latency Interpolation Filter Specifications

PARAMETER	TEST CONDITIONS	MIN	TYP	MAX	UNIT
Pass-band ripple	Frequency range is 0 to $0.455 \times f_S$	-0.12		-0.01	dB
Stop-band attenuation	Frequency range is $0.599 \times f_S$ to $4 \times f_S$	88.9			dB
	Frequency range is $4 \times f_S$ to $7.414 \times f_S$	89			
Group delay or latency	Frequency range is 0 to $0.376 \times f_S$		7.19		$1/f_S$
Group delay deviation	Frequency range is 0 to $0.376 \times f_S$	-0.088		0.088	$1/f_S$
Phase deviation	Frequency range is 0 to $0.376 \times f_S$	-0.31		0.36	Degrees

7.3.9.2.6.2.2 Sampling Rate: 32kHz or 29.4kHz

Figure 7-91 shows the magnitude response and Figure 7-92 shows the pass-band ripple and phase deviation for this interpolation filter with a sampling rate of 32kHz or 29.4kHz. Table 7-61 lists its specifications.

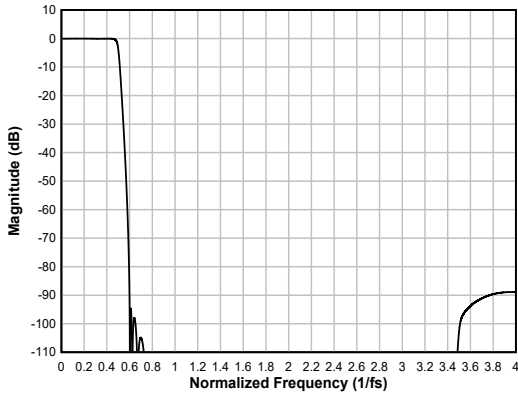

Figure 7-91. Low-latency Interpolation Filter Magnitude Response

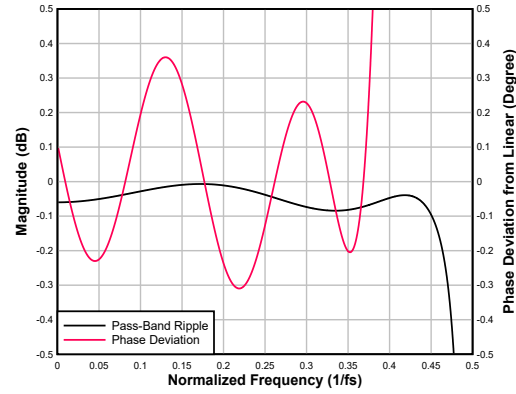

Figure 7-92. Low-latency Interpolation Filter Pass-Band Ripple and Phase Deviation

Table 7-61. Low-latency Interpolation Filter Specifications

PARAMETER	TEST CONDITIONS	MIN	TYP	MAX	UNIT
Pass-band ripple	Frequency range is 0 to $0.455 \times f_S$	-0.12		-0.01	dB
Stop-band attenuation	Frequency range is $0.599 \times f_S$ to $4 \times f_S$	88.9			dB
	Frequency range is $4 \times f_S$ to $7.414 \times f_S$	89			
Group delay or latency	Frequency range is 0 to $0.376 \times f_S$		7.19		$1/f_S$
Group delay deviation	Frequency range is 0 to $0.376 \times f_S$	-0.088		0.088	$1/f_S$
Phase deviation	Frequency range is 0 to $0.376 \times f_S$	-0.31		0.36	Degrees

7.3.9.2.6.2.3 Sampling Rate: 48kHz or 44.1kHz

Figure 7-93 shows the magnitude response and Figure 7-94 shows the pass-band ripple and phase deviation for this interpolation filter with a sampling rate of 48kHz or 44.1kHz. Table 7-62 lists its specifications.

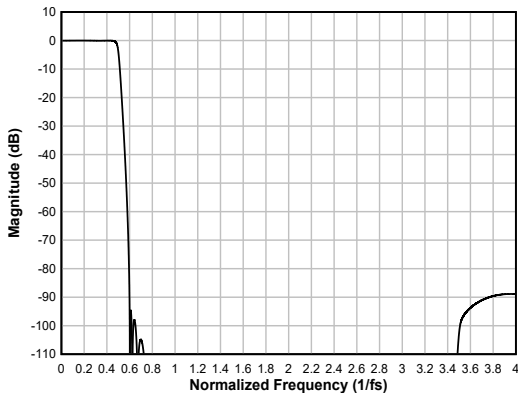

Figure 7-93. Low-latency Interpolation Filter Magnitude Response

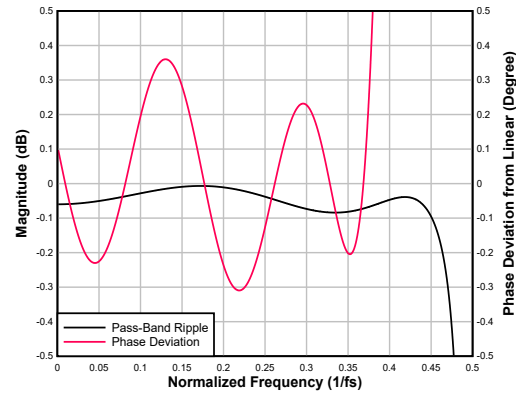

Figure 7-94. Low-latency Interpolation Filter Pass-Band Ripple and Phase Deviation

Table 7-62. Low-latency Interpolation Filter Specifications

PARAMETER	TEST CONDITIONS	MIN	TYP	MAX	UNIT
Pass-band ripple	Frequency range is 0 to $0.455 \times f_S$	-0.12		-0.01	dB
Stop-band attenuation	Frequency range is $0.599 \times f_S$ to $4 \times f_S$	88.9			dB
	Frequency range is $4 \times f_S$ to $7.414 \times f_S$	89			
Group delay or latency	Frequency range is 0 to $0.376 \times f_S$		7.19		$1/f_S$
Group delay deviation	Frequency range is 0 to $0.376 \times f_S$	-0.088		0.088	$1/f_S$

Table 7-62. Low-latency Interpolation Filter Specifications (continued)

PARAMETER	TEST CONDITIONS	MIN	TYP	MAX	UNIT
Phase deviation	Frequency range is 0 to $0.376 \times f_S$	-0.31		0.36	Degrees

7.3.9.2.6.2.4 Sampling Rate: 96kHz or 88.2kHz

Figure 7-95 shows the magnitude response and Figure 7-96 shows the pass-band ripple and phase deviation for this interpolation filter with a sampling rate of 96kHz or 88.2kHz. Table 7-63 lists its specifications.

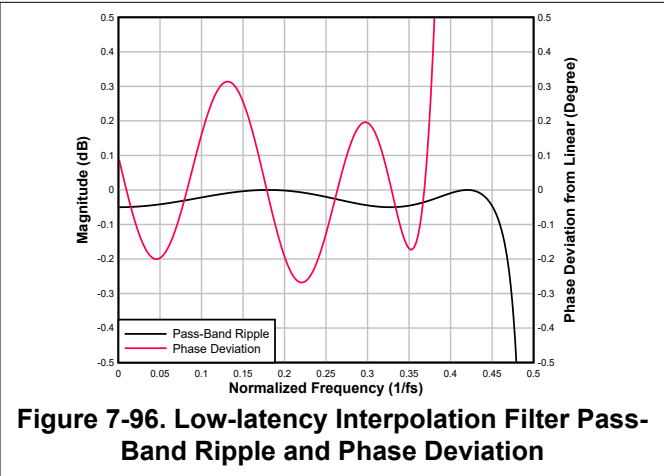
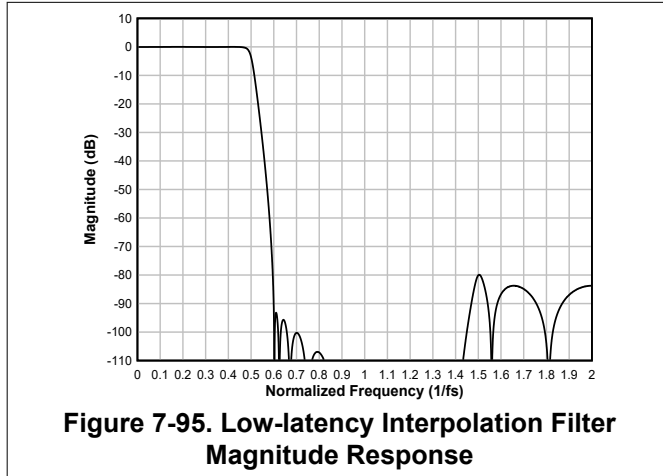

Table 7-63. Low-latency Interpolation Filter Specifications

PARAMETER	TEST CONDITIONS	MIN	TYP	MAX	UNIT
Pass-band ripple	Frequency range is 0 to $0.456 \times f_S$	-0.07		0	dB
Stop-band attenuation	Frequency range is $0.595 \times f_S$ to $2 \times f_S$	79.9			dB
	Frequency range is $2 \times f_S$ to $3.405 \times f_S$	79.9			
Group delay or latency	Frequency range is 0 to $0.376 \times f_S$		6.39		$1/f_S$
Group delay deviation	Frequency range is 0 to $0.376 \times f_S$	-0.078		0.022	$1/f_S$
Phase deviation	Frequency range is 0 to $0.376 \times f_S$	-0.268		0.022	Degrees

7.3.9.2.6.2.5 Sampling Rate: 192kHz or 176.4kHz

Figure 7-97 shows the magnitude response and Figure 7-98 shows the pass-band ripple and phase deviation for this interpolation filter with a sampling rate of 192kHz or 176.4kHz. Table 7-64 lists its specifications.

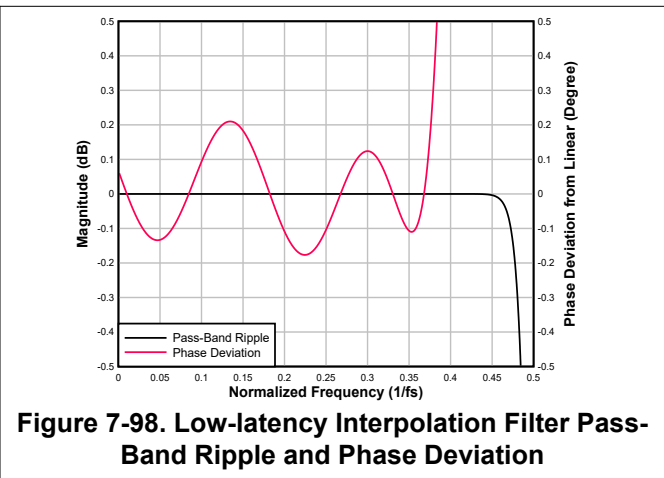
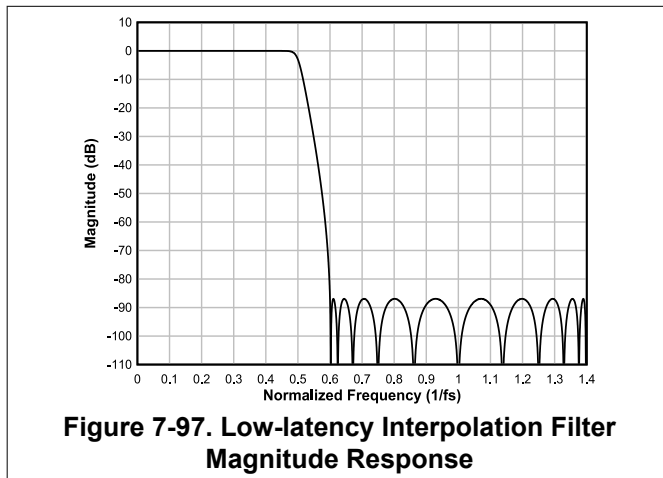

Table 7-64. Low-latency Interpolation Filter Specifications

PARAMETER	TEST CONDITIONS	MIN	TYP	MAX	UNIT
Pass-band ripple	Frequency range is 0 to $0.452 \times f_S$	-0.005		0	dB
Stop-band attenuation	Frequency range is $0.6 \times f_S$ to $1 \times f_S$	86.9			dB
	Frequency range is $1 \times f_S$ to $1.401 \times f_S$	86.9			
Group delay or latency	Frequency range is 0 to $0.376 \times f_S$		5.41		$1/f_S$
Group delay deviation	Frequency range is 0 to $0.376 \times f_S$	-0.055		0.055	$1/f_S$
Phase deviation	Frequency range is 0 to $0.376 \times f_S$	-0.177		0.21	Degrees

7.3.9.2.6.3 Ultra-Low-Latency Filters

For applications where ultra-low latency (within the audio band) is critical, the ultra-low-latency interpolation filters on the TAC5112 can be used. The device supports these filters with a group delay of approximately four samples with an almost linear phase response within the $0.325 \times f_S$ frequency band. This section provides the filter performance specifications and various plots for all supported output sampling rates for the ultra-low-latency filters.

7.3.9.2.6.3.1 Sampling Rate: 24 kHz or 22.05 kHz

Figure 7-99 shows the magnitude response and Figure 7-100 shows the pass-band ripple and phase deviation for a interpolation filter with a sampling rate of 24 kHz or 22.05 kHz. Table 7-65 lists its specifications.

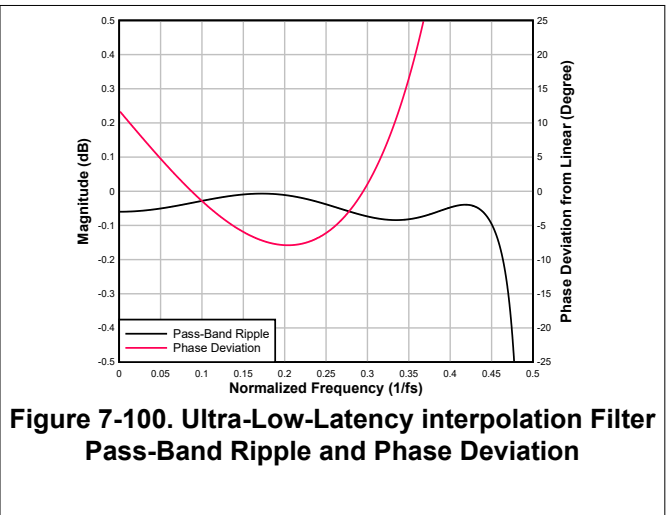
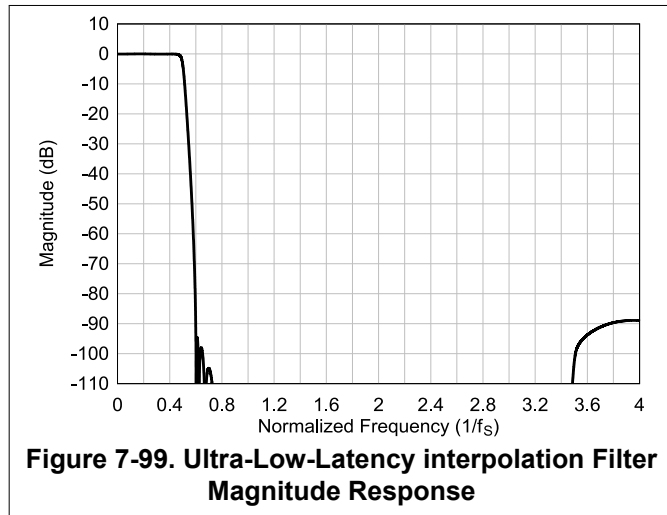

Table 7-65. Ultra-Low-Latency interpolation Filter Specifications

PARAMETER	TEST CONDITIONS	MIN	TYP	MAX	UNIT
Pass-band ripple	Frequency range is 0 to $0.42 \times f_s$	-0.005		0.01	dB
Stop-band attenuation	Frequency range is $0.6 \times f_s$ to $4 \times f_s$	88.9			dB
	Frequency range is $4 \times f_s$ to $7.41 \times f_s$	88.9			
Group delay or latency	Frequency range is 0 to $0.325 \times f_s$		3.2		$1/f_s$
Group delay deviation	Frequency range is 0 to $0.325 \times f_s$	-0.888		0.363	$1/f_s$
Phase deviation	Frequency range is 0 to $0.325 \times f_s$	-7.9		11.7	Degrees

7.3.9.2.6.3.2 Sampling Rate: 32 kHz or 29.4 kHz

Figure 7-101 shows the magnitude response and Figure 7-102 shows the pass-band ripple and phase deviation for a interpolation filter with a sampling rate of 32 kHz or 29.4 kHz. Table 7-66 lists its specifications.

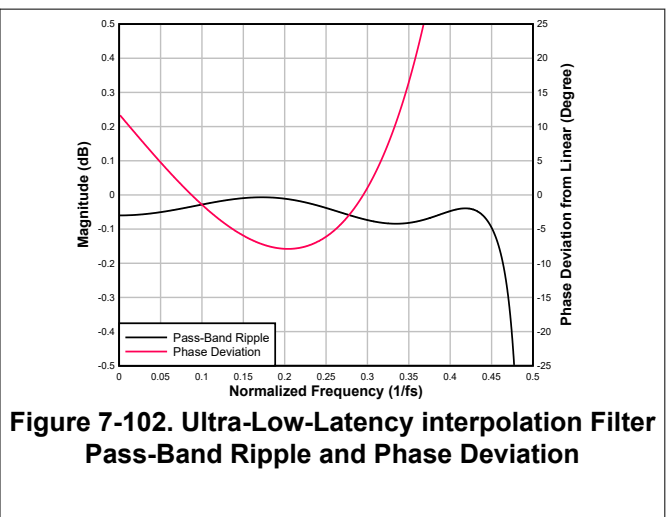
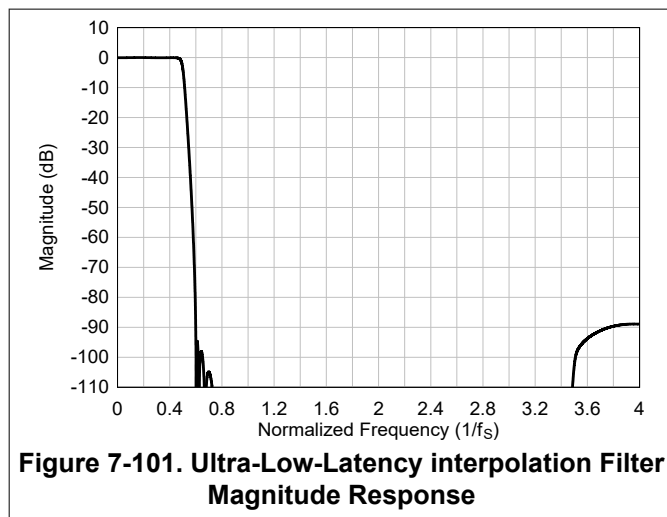

Table 7-66. Ultra-Low-Latency interpolation Filter Specifications

PARAMETER	TEST CONDITIONS	MIN	TYP	MAX	UNIT
Pass-band ripple	Frequency range is 0 to $0.42 \times f_S$	-0.005		0.01	dB
Stop-band attenuation	Frequency range is $0.6 \times f_S$ to $4 \times f_S$	88.9			dB
	Frequency range is $4 \times f_S$ to $7.41 \times f_S$	88.9			
Group delay or latency	Frequency range is 0 to $0.325 \times f_S$		3.2		$1/f_S$
Group delay deviation	Frequency range is 0 to $0.325 \times f_S$	-0.888		0.363	$1/f_S$
Phase deviation	Frequency range is 0 to $0.325 \times f_S$	-7.9		11.7	Degrees

7.3.9.2.6.3.3 Sampling Rate: 48 kHz or 44.1 kHz

Figure 7-103 shows the magnitude response and Figure 7-104 shows the pass-band ripple and phase deviation for a interpolation filter with a sampling rate of 48 kHz or 44.1 kHz. Table 7-67 lists its specifications.

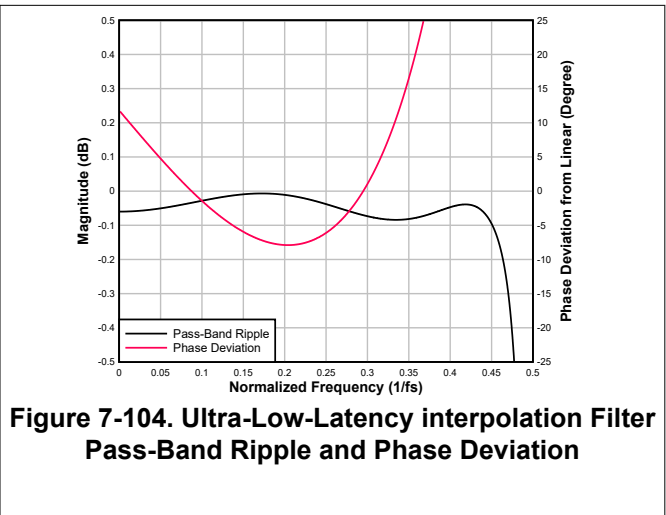
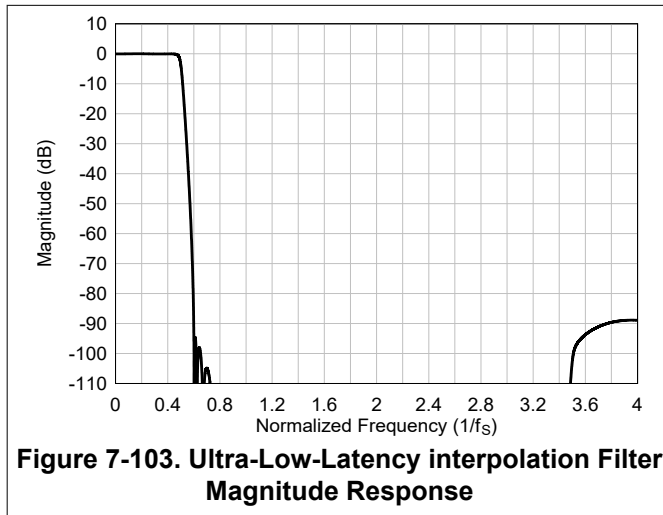

Table 7-67. Ultra-Low-Latency interpolation Filter Specifications

PARAMETER	TEST CONDITIONS	MIN	TYP	MAX	UNIT
Pass-band ripple	Frequency range is 0 to $0.42 \times f_S$	-0.005		0.01	dB
Stop-band attenuation	Frequency range is $0.6 \times f_S$ to $4 \times f_S$	88.9			dB
	Frequency range is $4 \times f_S$ to $7.41 \times f_S$	88.9			
Group delay or latency	Frequency range is 0 to $0.325 \times f_S$		3.2		$1/f_S$
Group delay deviation	Frequency range is 0 to $0.325 \times f_S$	-0.888		0.363	$1/f_S$
Phase deviation	Frequency range is 0 to $0.325 \times f_S$	-7.9		11.7	Degrees

7.3.9.2.6.3.4 Sampling Rate: 96 kHz or 88.2 kHz

Figure 7-105 shows the magnitude response and Figure 7-106 shows the pass-band ripple and phase deviation for a interpolation filter with a sampling rate of 96 kHz or 88.2 kHz. Table 7-68 lists its specifications.

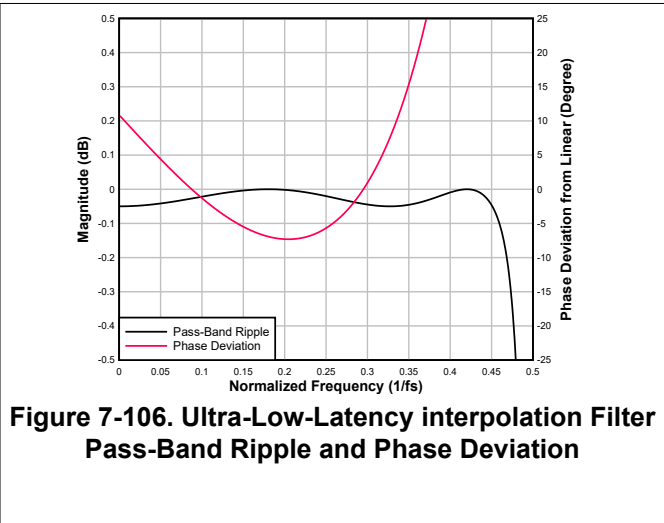
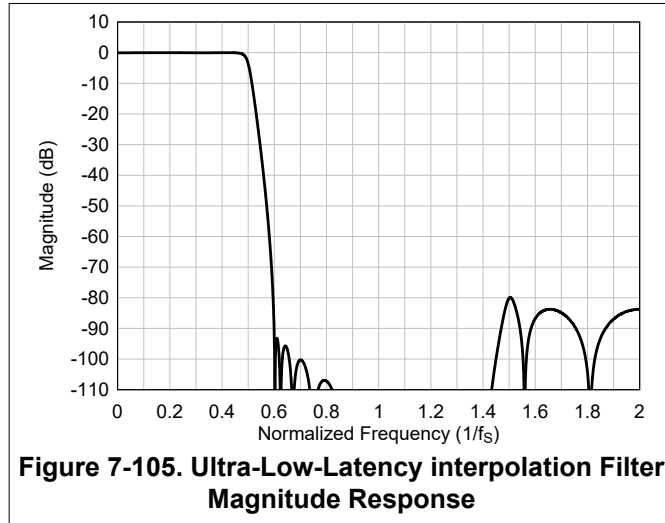

Table 7-68. Ultra-Low-Latency interpolation Filter Specifications

PARAMETER	TEST CONDITIONS	MIN	TYP	MAX	UNIT
Pass-band ripple	Frequency range is 0 to $0.45 \times f_s$	-0.05		0.001	dB
Stop-band attenuation	Frequency range is $0.6 \times f_s$ to $2 \times f_s$	80.6			
Group delay or latency	Frequency range is 0 to $0.325 \times f_s$		2.5		$1/f_s$
Group delay deviation	Frequency range is 0 to $0.325 \times f_s$	-0.826		0.333	$1/f_s$
Phase deviation	Frequency range is 0 to $0.325 \times f_s$	-0.86		1.30	Degrees

7.3.9.2.6.3.5 Sampling Rate 192 kHz or 176.4 kHz

Figure 7-107 shows the magnitude response and Figure 7-108 shows the pass-band ripple and phase deviation for a interpolation filter with a sampling rate of 192 kHz or 176.4 kHz. Table 7-69 lists its specifications.

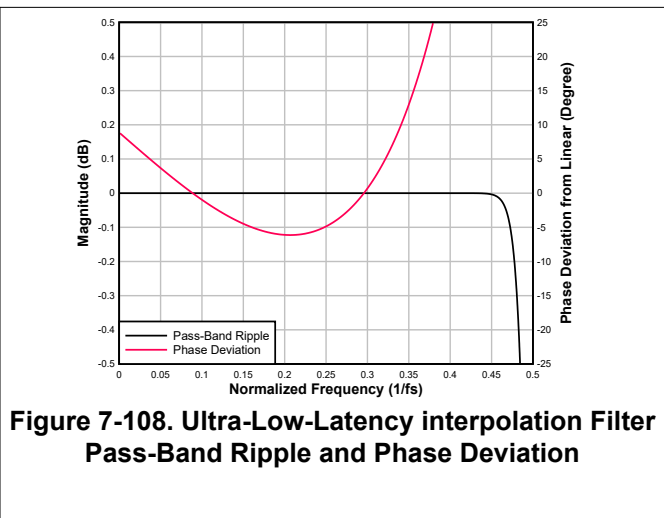
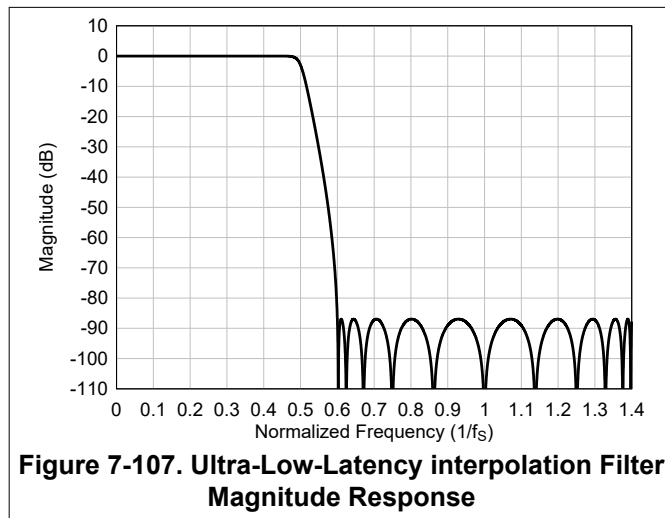

Table 7-69. Ultra-Low-Latency Interpolation Filter Specifications 192

PARAMETER	TEST CONDITIONS	MIN	TYP	MAX	UNIT
Pass-band ripple	Frequency range is 0 to $0.463 \times f_S$	-0.001		0.001	dB
Stop-band attenuation	Frequency range is $0.6 \times f_S$ to $1 \times f_S$	86.9			dB
	Frequency range is $1 \times f_S$ to $1.4 \times f_S$	86.9			
Group delay or latency	Frequency range is 0 to $0.325 \times f_S$		1.7		$1/f_S$
Group delay deviation	Frequency range is 0 to $0.325 \times f_S$	-0.702		0.268	$1/f_S$
Phase deviation	Frequency range is 0 to $0.325 \times f_S$	-0.12		0.18	Degrees

7.3.10 Interrupts, Status, and Digital I/O Pin Multiplexing

Certain events in the device require host processor intervention and can be used to trigger interrupts to the host processor. One such event is an audio serial interface (ASI) bus error. The device powers down the record channels if any faults are detected with the ASI bus error clocks, such as:

- Invalid FSYNC frequency
- Invalid BCLK to FSYNC ratio
- Long pauses of the BCLK or FSYNC clocks

When an ASI bus clock error is detected, the device shuts down all the record and playback channels as quickly as possible. After all ASI bus clock errors are resolved, the device volume ramps back to its previous state to recover the audio. During an ASI bus clock error, the internal interrupt request (IRQ) interrupt signal asserts low if the clock error interrupt mask register bit INT_MASK0[7] (P1_R47_D[7]) is set low. The clock fault is also available for readback in the latched fault status register bit INT_LTCH0 (P1_R52), which is a read-only register. Reading the latched fault status register, INT_LTCH0, clears all latched fault status. The device can be additionally configured to route the internal IRQ interrupt signal on the GPIOx or GPO1 pins and also can be configured as open-drain outputs so that these pins can be wire-ANDed to the open-drain interrupt outputs of other devices.

The IRQ interrupt signal can either be configured as active low or active high polarity by setting the INT_POL (P0_R66_D[7]) register bit. This signal can also be configured as a single pulse or a series of pulses by programming the INT_EVENT[1:0] (P0_R66_D[6:5]) register bits. If the interrupts are configured as a series of pulses, the events trigger the start of pulses that stop when the latched fault status register is read to determine the cause of the interrupt.

The device also supports read-only live-status registers to determine if the channels are powered up or down and if the device is in sleep mode or not. These status registers are located in the DEV_STS0 (P0_R121) and DEV_STS1 (P0_R122) register bits.

The device has a multifunctional GPIOx, GPI1 and GPO1 pins that can be configured for a desired specific function. [Table 7-70](#) lists all possible allocations of these multifunctional pins for the various features.

Table 7-70. Multifunction Pin Assignments

ROW	PIN FUNCTION	GPIO1	GPIO2	GPO1	GPI1
—	—	GPIO1_CFG	GPIO2_CFG	GPO1_CFG	GPI1_CFG
—	—	P0_R10[7:4]	P0_R11[7:4]	P0_R12[7:4]	P0_R13[1]
A	Pin disabled	S ⁽¹⁾	S (default)	S (default)	S (default)
B	General-purpose output (GPO)	S	S	S	NS ⁽²⁾
C	Interrupt output (IRQ)	S (default)	S	S	NS
D	Power down for all ADC channels	S	S	NS	S
E	Power down for all DAC channels	S	S	NS	S
F	PDM clock output (PDMCLK)	S	S	S	NS
G	MiCBIAS on/off input (BIASEN)	S	S	NS	S
H	General-purpose input (GPI)	S	S	NS	S
I	Controller clock input (CCLK)	S	S	S	S
J	ASI daisy-chain input	S	S	NS	S
K	PDM data input 1 (PDMIN1)	S	S	NS	S
L	PDM data input 2 (PDMIN2)	S	S	NS	S
M	ASI DOUT	S	S	S	NS
N	ASI BCLK	S	S	S	S
O	ASI FSYNC	S	S	S	S
P	General Purpose Clock Out	S	S	S	NS
Q	ASI daisy-chain output	S	S	S	NS
R	Incremental ADC Conversion Start	S	S	NS	S

(1) S means the feature mentioned in this row is *supported* for the respective GPIO1, GPOx, or GPIx pin mentioned in this column.

(2) NS means the feature mentioned in this row is *not supported* for the respective GPIO1, GPOx, or GPIx pin mentioned in this column.

Each GPO1 or GPIOx pin can be independently set for the desired drive configurations setting using the GPIOx_DRV[2:0] or GPO1_DRV[2:0] register bits in P0_R10_D[2:0], P0_R11_D[2:0] and P0_R12_D[2:0] respectively. [Table 7-71](#) lists the drive configuration settings.

Table 7-71. GPIO or GPOx Pins Drive Configuration Settings

P0_R10_D[2:0] : GPIO1_DRV[2:0]	GPIO OUTPUT DRIVE CONFIGURATION SETTINGS FOR GPIO1
000	The GPIO1 pin is set to high impedance (floated)
001	The GPIO1 pin is set to be driven active low or active high
010 (default)	The GPIO1 pin is set to be driven active low or weak high (on-chip pullup)
011	The GPIO1 pin is set to be driven active low or Hi-Z (floated)
100	The GPIO1 pin is set to be driven weak low (on-chip pulldown) or active high
101	The GPIO1 pin is set to be driven Hi-Z (floated) or active high
110 and 111	Reserved (do not use these settings)

When configured as a general-purpose output (GPO), the GPIOx or GPO1 pin values can be driven by writing the GPO_GPI_VAL (P0_R14) registers. The GPIO_MON bits (P0_R14_D[3:1]) can be used to readback the status of the GPIOx or GPI1 pin when configured as a general-purpose input (GPI).

7.3.11 Power Tune Mode

For low power applications, the TAC5112 offers options to configure the device in a power tune mode with typical power consumption 8mW for 2-Ch recording and 10.5mW for 2-Ch playback for a 1.8V supply. This mode can be configured by setting the PWR_TUNE_CFG0 (P0_R78) register to 0xD4 and PWR_TUNE_CFG1 (P0_R79) register to 0x86. For power savings, the ADC and DAC modulator clocks are set to run at 1.536MHz (the input and output data sample rates are multiples or submultiples of 48kHz) or 1.4112MHz (the input and output data sample rates are multiples or submultiples of 44.1kHz). In this mode, not all combinations of VREF voltages, common mode tolerance (ADC_CHx_CM_TOL) settings and input channel configuration (ADC_CHx_INSRC) settings are recommended. For more details refer the [TAC5x1x Power Consumption Matrix Across Various Usage Scenarios application report](#) for the supported input impedance, VREF voltages, common mode tolerance (ADC_CHx_CM_TOL) settings and input channel configuration (ADC_CHx_INSRC) settings in this mode.

7.4 Device Functional Modes

7.4.1 Sleep Mode or Software Shutdown

In sleep mode or software shutdown mode, the device consumes very low quiescent current from the AVDD supply and, at the same time, allows the I²C or SPI communication to wake the device for active operation.

The device can also enter sleep mode when the host device sets the SLEEP_ENZ (P0_R2_D[0]) bit to 1'b0. If the SLEEP_ENZ bit is asserted low when the device is in active mode, the device ramps down the volume on the record and playback data, powers down the analog and digital blocks, and enters sleep mode. However, the device still continues to retain the last programmed value of the device configuration registers and programmable coefficients.

In sleep mode, do not perform any I²C or SPI transactions, except for exiting sleep mode in order to enter active mode. After entering sleep mode, wait at least 10ms before starting I²C or SPI transactions to exit sleep mode.

7.4.2 Active Mode

If the host device exits sleep mode by setting the SLEEP_ENZ bit to 1'b1, the device enters active mode. In active mode, I²C or SPI transactions can be done to configure and power-up the device for active operation. After entering active mode, wait at least 2ms before starting any I²C or SPI transactions in order to allow the device to complete the internal wake-up sequence.

Read and write operations to the programmable coefficient registers (Section 8.2), and to the channel configuration registers must be done 10ms after exiting sleep mode.

After configuring all other registers for the target application and system settings, configure the input channel enable registers, P0_R118 (CH_EN). Lastly, configure the device power-up register, P0_R120 (PWR_CFG). All the programmable coefficient values must be written before powering up the respective channel.

In active mode, the power-up and power-down status of various blocks is monitored by reading the read-only device status bits located in the P0_R121 (DEV_STS0) and P0_R122 (DEV_STS1) registers.

7.4.3 Software Reset

A software reset can be done any time by asserting the SW_RESET bit (P0_R1_D[0]), which is a self-clearing bit. This software reset immediately shuts down the device, and restores all device configuration registers and programmable coefficients to their default values.

7.5 Programming

The device contains configuration registers and programmable coefficients that can be set to the desired values for a specific system and application use. These registers are called *device control registers* and are each eight bits in width, mapped using a page scheme.

Each page contains 128 configuration registers. All device configuration registers are stored in page 0, which is the default page setting at power up and after a software reset. All programmable coefficient registers are located in page 0, page 1, and page 3. The current page of the device can be switched to a new desired page by using the PAGE[7:0] bits located in register 0 of every page.

7.5.1 Control Serial Interfaces

The device control registers can be accessed using either I²C or SPI communication to the device.

By monitoring the SDA_PICO, SCL_SCLK, GPO1_POCI, and GPI1_CSZ device pins, which are the multiplexed pins for the I²C or SPI Interface, the device automatically detects whether the host device is using I²C or SPI communication to configure the device. For a given end application, the host device must always use either the I²C or SPI interface, but not both, to configure the device refer to the [Table 7-72](#).

Table 7-72. I²C and SPI Address Configuration

ADDR Setting	Mode	Device Address (7-bit)	Device Address (8-bit)
Short to Ground	I ² C	0x50	0xA0

Table 7-72. I²C and SPI Address Configuration (continued)

ADDR Setting	Mode	Device Address (7-bit)	Device Address (8-bit)
Pull down 4.7KOhm to ground	I ² C	0x51	0xA2
Pull up 22KOhm to AVDD	I ² C	0x52	0xA4
Pull up 4.7KOhm to AVDD	I ² C	0x53	0xA6
Short to AVDD	SPI	NA	NA

7.5.1.1 I²C Control Interface

The device supports the I²C control protocol as a target device, and is capable of operating in standard mode, fast mode, and fast mode plus. The I²C control protocol requires a 7-bit target address. The five most significant bits (MSBs) of the target address are fixed at 5'b10100 and cannot be changed. The two least significant bits (LSBs) are programmable and are controlled by the ADDR pin. Refer [Table 7-72](#) for the four possible device addresses supported by TAC5112 in I²C mode. If the I2C_BRDCAST_EN (P0_R4_D[1]) bit is set to 1'b1, then the 7-bit I²C target address is fixed to 7'b1010000 in order to allow simultaneous I²C broadcast communication to all TAC5112 devices in the system.

7.5.1.1.1 General I²C Operation

The I²C bus employs two signals, SDA (data) and SCL (clock), to communicate between integrated circuits in a system using serial data transmission. The address and data 8-bit bytes are transferred MSB first. In addition, each byte transferred on the bus is acknowledged by the receiving device with an acknowledge bit. Each transfer operation begins with the controller device driving a start condition on the bus and ends with the controller device driving a stop condition on the bus. The bus uses transitions on the data pin (SDA) while the clock is at logic high to indicate start and stop conditions. A high-to-low transition on SDA indicates a start, and a low-to-high transition indicates a stop. Normal data-bit transitions must occur within the low time of the clock period.

The controller device drives a start condition followed by the 7-bit target address and the read/write (R/W) bit to open communication with another device and then waits for an acknowledgment condition. The target device holds SDA low during the acknowledge clock period to indicate acknowledgment. When this occurs, the controller device transmits the next byte of the sequence. Each target device is addressed by a unique 7-bit target address plus the R/W bit (1 byte). All compatible devices share the same signals via a bidirectional bus using a wired-AND connection.

There is no limit on the number of bytes that can be transmitted between start and stop conditions. When the last word transfers, the controller device generates a stop condition to release the bus. Figure 7-109 shows a generic data transfer sequence.

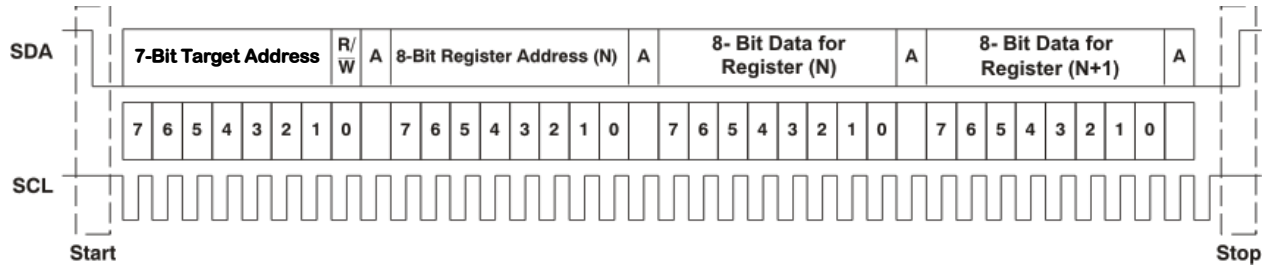

Figure 7-109. Typical I²C Sequence

In the system, use external pullup resistors for the SDA and SCL signals to set the logic high level for the bus. The SDA and SCL voltages must not exceed the device supply voltage, IOVDD.

7.5.1.1.2 I²C Single-Byte and Multiple-Byte Transfers

The device I²C interface supports both single-byte and multiple-byte read/write operations for all registers. During multiple-byte read operations, the device responds with data, a byte at a time, starting at the register assigned, as long as the controller device continues to respond with acknowledgements.

The device supports sequential I²C addressing. For write transactions, if a register is issued followed by data for that register and all the remaining registers that follow, a sequential I²C write transaction takes place. For I²C sequential write transactions, the register issued then serves as the starting point, and the amount of data subsequently transmitted, before a stop or start is transmitted, determines how many registers are written.

7.5.1.1.2.1 I²C Single-Byte Write

As shown in Figure 7-110, a single-byte data write transfer begins with the controller device transmitting a start condition followed by the I²C device address and the read/write bit. The read/write bit determines the direction of the data transfer. For a write-data transfer, the read/write bit must be set to 0. After receiving the correct I²C target address and the read/write bit, the device responds with an acknowledge bit (ACK). Next, the controller device transmits the register byte corresponding to the device internal register address being accessed. After receiving the register byte, the device again responds with an acknowledge bit (ACK). Then, the controller device transmits the byte of data to be written to the specified register. When finished, the target device responds with an acknowledge bit (ACK). Finally, the controller device transmits a stop condition to complete the single-byte data write transfer.

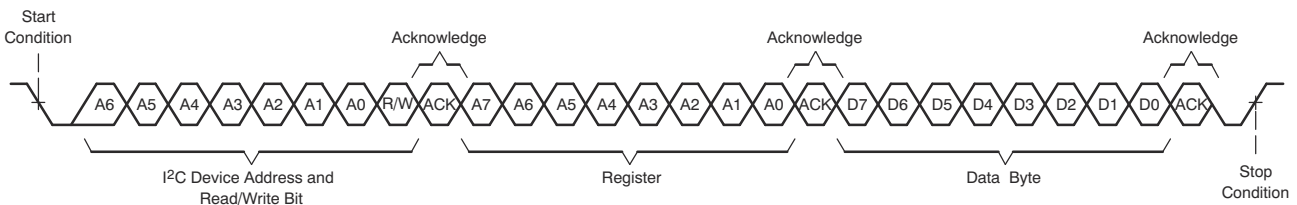

Figure 7-110. I²C Single-Byte Write Transfer

7.5.1.1.2.2 I²C Multiple-Byte Write

As shown in Figure 7-111, a multiple-byte data write transfer is identical to a single-byte data write transfer except that multiple data bytes are transmitted by the controller device to the target device. After receiving each data byte, the device responds with an acknowledge bit (ACK). Finally, the controller device transmits a stop condition after the last data-byte write transfer.

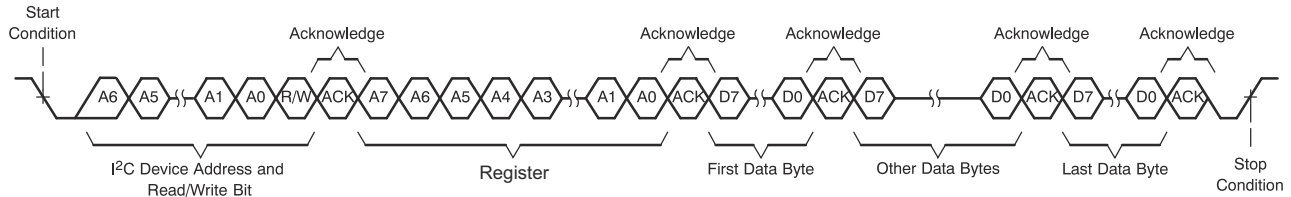

Figure 7-111. I²C Multiple-Byte Write Transfer

7.5.1.1.2.3 I²C Single-Byte Read

As shown in Figure 7-112, a single-byte data read transfer begins with the controller device transmitting a start condition followed by the I²C target address and the read/write bit. For the data read transfer, both a write followed by a read are done. Initially, a write is done to transfer the address byte of the internal register address to be read. As a result, the read/write bit is set to 0.

After receiving the target address and the read/write bit, the device responds with an acknowledge bit (ACK). The controller device then sends the internal register address byte, after which the device issues an acknowledge bit (ACK). The controller device transmits another start condition followed by the target address and the read/write bit again. This time, the read/write bit is set to 1, indicating a read transfer. Next, the device transmits the data byte from the register address being read. After receiving the data byte, the controller device transmits a not-acknowledge (NACK) followed by a stop condition to complete the single-byte data read transfer.

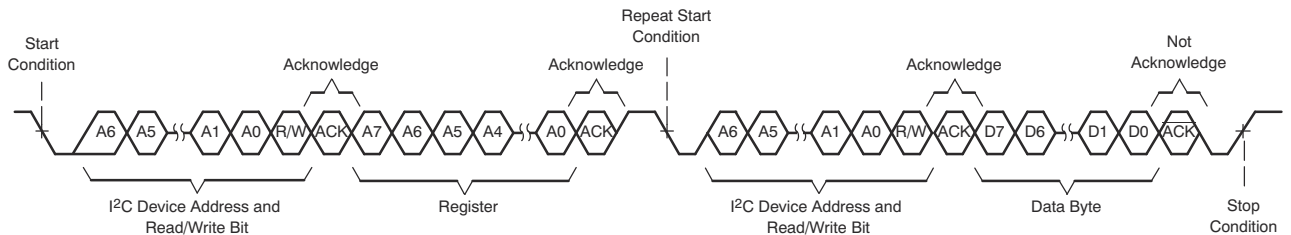

Figure 7-112. I²C Single-Byte Read Transfer

7.5.1.1.2.4 I²C Multiple-Byte Read

As shown in Figure 7-113, a multiple-byte data read transfer is identical to a single-byte data read transfer except that multiple data bytes are transmitted by the device to the controller device. With the exception of the last data byte, the controller device responds with an acknowledge bit after receiving each data byte. After receiving the last data byte, the controller device transmits a not-acknowledge (NACK) followed by a stop condition to complete the data read transfer.

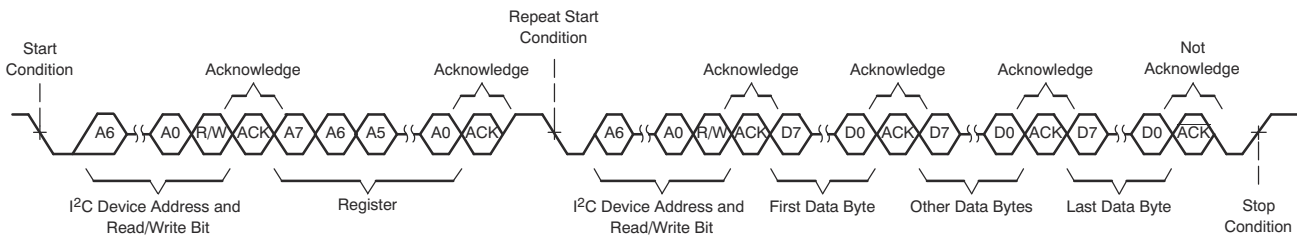

Figure 7-113. I²C Multiple-Byte Read Transfer

7.5.1.2 SPI Control Interface

The general SPI protocol allows full-duplex, synchronous, serial communication between a host processor (the controller) and peripheral devices. The SPI controller (in this case, the host processor) generates the synchronizing clock (driven on to SCLK) and initiates transmissions by taking the peripheral-select pin CSZ from high to low. The SPI peripheral devices (such as the TAC5112) depend on a controller device to start and synchronize transmissions. A transmission begins when initiated by an SPI controller. The byte from the SPI controller begins shifting in on the peripheral PICO pin under the control of the controller serial clock (driven onto SCLK). When the byte shifts in on the PICO pin, a byte shifts out on the POCI pin to the controller shift register.

Refer to [Table 7-73](#) to configure the device for SPI control. [Table 7-73](#) mentions the pin assignment for SPI mode of control.

Table 7-73. Pin Assignments for SPI Control

Pin Number	Pin Name	Pin Name in SPI Mode	Description
7	SCL	SCLK	SPI serial bit clock
8	SDA	PICO	SPI peripheral input pin
11	GP01	POCI	SPI peripheral output pin
12	GPI1	CSZ	SPI chip select pin

The TAC5112 supports a standard SPI control protocol with a clock polarity setting of 0 (typical microprocessor SPI control bit CPOL = 0) and a clock phase setting of 1 (typical microprocessor SPI control bit CPHA = 1). The CSZ pin can remain low between transmissions; however, the device only interprets the first eight bits transmitted after the falling edge of CSZ as a command byte, and the next eight bits as a data byte only if writing to a register. The device is entirely controlled by registers. Reading and writing these registers is accomplished by an 8-bit command sent to the PICO pin prior to the data for that register. [Table 7-74](#) shows the command structure. The first seven bits specify the address of the register that is being written or read, from 0 to 127 (decimal). The command word ends with an R/W bit, which specifies the direction of data flow on the serial bus.

In the case of a register write, set the R/W bit to 0. A second byte of data is sent to the PICO pin and contains the data to be written to the register. A register read is accomplished in a similar fashion. The 8-bit command word sends the 7-bit register address, followed by the R/W bit equal to 1 to signify a register read. The 8-bit register data is then clocked out of the device on the POCI pin during the second eight SCLK clocks in the frame. The device supports sequential SPI addressing for a multiple-byte data write/read transfer until the CSZ pin is pulled high. A multiple-byte data write or read transfer is identical to a single-byte data write or read transfer, respectively, until all data byte transfers complete. The host device must keep the CSZ pin low during all data byte transfers. [Figure 7-114](#) shows the single-byte write transfer and [Figure 7-115](#) shows the single-byte read transfer.

Table 7-74. SPI Command Word

BIT 7	BIT 6	BIT 5	BIT 4	BIT 3	BIT 2	BIT 1	BIT 0
ADDR(6)	ADDR(5)	ADDR(4)	ADDR(3)	ADDR(2)	ADDR(1)	ADDR(0)	R/WZ

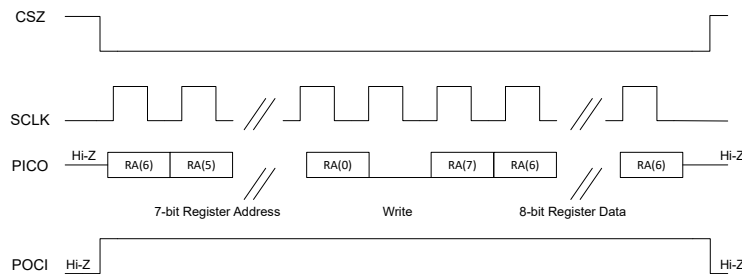

Figure 7-114. SPI Single-Byte Write Transfer

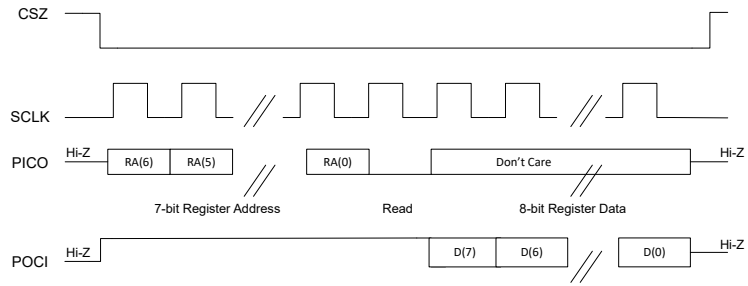

Figure 7-115. SPI Single-Byte Read Transfer

8 Register Maps

This section describes the control registers for the device in detail. All these registers are eight bits in width and allocated to device configuration and programmable coefficients settings. These registers are mapped internally using a page scheme that can be controlled using either I²C or SPI communication to the device. Each page contains 128 bytes of registers. All device configuration registers are stored in page 0, page 1 and page 3. Page 0 is the default page setting at power up (and after a software reset). The device current page can be switch to a new desired page by using the PAGE[7:0] bits located in register 0 of every page.

Do not read from or write to reserved pages or reserved registers. Write only default values for the reserved bits in the valid registers.

The procedure for register access across pages is:

- Select page *N* (write data *N* to register 0 regardless of the current page number)
- Read or write data from or to valid registers in page *N*
- Select the new page *M* (write data *M* to register 0 regardless of the current page number)
- Read or write data from or to valid registers in page *M*
- Repeat as needed

8.1 Device Configuration Registers

This section describes the device configuration registers for Page 0, Page 1 and Page 3 of the device. [Table 8-1](#) lists the access codes for the device registers.

Table 8-1. Access Type Codes

Access Type	Code	Description
Read Type		
R	R	Read
R-W	R/W	Read or write
Write Type		
W	W	Write

8.1.1 Book0_P0 Registers

Table 8-2 lists the memory-mapped registers for the Book0_P0 registers. All register offset addresses not listed in Table 8-2 should be considered as reserved locations and the register contents should not be modified.

Table 8-2. BOOK0_P0 Registers

Address	Acronym	Register Name	Reset Value	Section
0x0	PAGE_CFG	Device page register	0x00	Section 8.1.1.1
0x1	SW_RESET	Software reset register	0x00	Section 8.1.1.2
0x2	DEV_MISC_CFG	Device miscellaneous configuration register	0x00	Section 8.1.1.3
0x3	AVDD_IOVDD_STS	Supply status Register	0x00	Section 8.1.1.4
0x4	MISC_CFG	Miscellaneous configuration register	0x00	Section 8.1.1.5
0x5	MISC_CFG1	Miscellaneous configuration register 1	0x15	Section 8.1.1.6
0x6	DAC_CFG_A0	DAC de-pop configuration register	0x35	Section 8.1.1.7
0x7	MISC_CFG0	Miscellaneous configuration register 0	0x00	Section 8.1.1.8
0xA	GPIO1_CFG0	GPIO1 configuration register 0	0x32	Section 8.1.1.9
0xB	GPIO2_CFG0	GPIO2 configuration register 0	0x00	Section 8.1.1.10
0xC	GPO1_CFG0	GPO1 configuration register 0	0x00	Section 8.1.1.11
0xD	GPI_CFG	GPI1 configuration register 0	0x00	Section 8.1.1.12
0xE	GPO_GPI_VAL	GPIO, GPO output value register	0x00	Section 8.1.1.13
0xF	INTF_CFG0	Interface configuration register 0	0x00	Section 8.1.1.14
0x10	INTF_CFG1	Interface configuration register 1	0x52	Section 8.1.1.15
0x11	INTF_CFG2	Interface configuration register 2	0x80	Section 8.1.1.16
0x12	INTF_CFG3	Interface configuration register 3	0x00	Section 8.1.1.17
0x13	INTF_CFG4	Interface configuration register 4	0x00	Section 8.1.1.18
0x14	INTF_CFG5	Interface configuration register 5	0x00	Section 8.1.1.19
0x15	INTF_CFG6	Interface configuration register 6	0x00	Section 8.1.1.20
0x18	ASI_CFG0	ASI configuration register 0	0x40	Section 8.1.1.21
0x19	ASI_CFG1	ASI configuration register 1	0x00	Section 8.1.1.22
0x1A	PASI_CFG0	Primary ASI configuration register 0	0x30	Section 8.1.1.23
0x1B	PASI_TX_CFG0	PASI TX configuration register 0	0x00	Section 8.1.1.24
0x1C	PASI_TX_CFG1	PASI TX configuration register 1	0x00	Section 8.1.1.25
0x1D	PASI_TX_CFG2	PASI TX configuration register 2	0x00	Section 8.1.1.26
0x1E	PASI_TX_CH1_CFG	PASI TX Channel 1 configuration register	0x20	Section 8.1.1.27
0x1F	PASI_TX_CH2_CFG	PASI TX Channel 2 configuration register	0x21	Section 8.1.1.28
0x20	PASI_TX_CH3_CFG	PASI TX Channel 3 configuration register	0x02	Section 8.1.1.29
0x21	PASI_TX_CH4_CFG	PASI TX Channel 4 configuration register	0x03	Section 8.1.1.30
0x22	PASI_TX_CH5_CFG	PASI TX Channel 5 configuration register	0x04	Section 8.1.1.31
0x23	PASI_TX_CH6_CFG	PASI TX Channel 6 configuration register	0x05	Section 8.1.1.32
0x24	PASI_TX_CH7_CFG	PASI TX Channel 7 configuration register	0x06	Section 8.1.1.33
0x25	PASI_TX_CH8_CFG	PASI TX Channel 8 configuration register	0x07	Section 8.1.1.34
0x26	PASI_RX_CFG0	PASI RX configuration register 0	0x00	Section 8.1.1.35
0x27	PASI_RX_CFG1	PASI RX configuration register 1	0x00	Section 8.1.1.36
0x28	PASI_RX_CH1_CFG	PASI RX Channel 1 configuration register	0x20	Section 8.1.1.37
0x29	PASI_RX_CH2_CFG	PASI RX Channel 2 configuration register	0x21	Section 8.1.1.38
0x2A	PASI_RX_CH3_CFG	PASI RX Channel 3 configuration register	0x02	Section 8.1.1.39
0x2B	PASI_RX_CH4_CFG	PASI RX Channel 4 configuration register	0x03	Section 8.1.1.40
0x2C	PASI_RX_CH5_CFG	PASI RX Channel 5 configuration register	0x04	Section 8.1.1.41
0x2D	PASI_RX_CH6_CFG	PASI RX Channel 6 configuration register	0x05	Section 8.1.1.42

Table 8-2. BOOK0_P0 Registers (continued)

Address	Acronym	Register Name	Reset Value	Section
0x2E	PASI_RX_CH7_CFG	PASI RX Channel 7 configuration register	0x06	Section 8.1.1.43
0x2F	PASI_RX_CH8_CFG	PASI RX Channel 8 configuration register	0x07	Section 8.1.1.44
0x32	CLK_CFG0	Clock configuration register 0	0x00	Section 8.1.1.45
0x33	CLK_CFG1	Clock configuration register 1	0x00	Section 8.1.1.46
0x34	CLK_CFG2	Clock configuration register 2	0x40	Section 8.1.1.47
0x35	CNT_CLK_CFG0	Controller mode clock configuration register 0	0x00	Section 8.1.1.48
0x36	CNT_CLK_CFG1	Controller mode clock configuration register 1	0x00	Section 8.1.1.49
0x37	CNT_CLK_CFG2	Controller mode clock configuration register 2	0x20	Section 8.1.1.50
0x38	CNT_CLK_CFG3	Controller mode clock configuration register 3	0x00	Section 8.1.1.51
0x39	CNT_CLK_CFG4	Controller mode clock configuration register 4	0x00	Section 8.1.1.52
0x3A	CNT_CLK_CFG5	Controller mode clock configuration register 5	0x00	Section 8.1.1.53
0x3B	CNT_CLK_CFG6	Controller mode clock configuration register 6	0x00	Section 8.1.1.54
0x3C	CLK_ERR_STS0	Clock error and status register 0	0x00	Section 8.1.1.55
0x3D	CLK_ERR_STS1	Clock error and status register 1	0x00	Section 8.1.1.56
0x3E	CLK_DET_STS0	Clock ratio detection register 0	0x00	Section 8.1.1.57
0x3F	CLK_DET_STS1	Clock ratio detection register 1	0x00	Section 8.1.1.58
0x40	CLK_DET_STS2	Clock ratio detection register 2	0x00	Section 8.1.1.59
0x41	CLK_DET_STS3	Clock ratio detection register 3	0x00	Section 8.1.1.60
0x42	INT_CFG	Interrupt configuration register	0x00	Section 8.1.1.61
0x43	DAC_FLT_CFG	Interrupt configuration register	0x54	Section 8.1.1.62
0x4B	ADC_DAC_MISC_CFG	ADC overload response configuration register	0x00	Section 8.1.1.63
0x4C	IADC_CFG	IADC configuration register	0x5C	Section 8.1.1.64
0x4D	VREF_MICBIAS_CFG	VREF and MICBIAS configuration register	0x00	Section 8.1.1.65
0x4E	PWR_TUNE_CFG0	Power tune configuration register 0	0x00	Section 8.1.1.66
0x4F	PWR_TUNE_CFG1	Power tune configuration register 1	0x00	Section 8.1.1.67
0x50	ADC_CH1_CFG0	ADC Channel 1 configuration register 0	0x00	Section 8.1.1.68
0x51	IADC_CH_CFG	IADC Channel configuration register	0x00	Section 8.1.1.69
0x52	ADC_CH1_CFG2	ADC Channel 1 configuration register 2	0xA1	Section 8.1.1.70
0x53	ADC_CH1_CFG3	ADC Channel 1 configuration register 3	0x80	Section 8.1.1.71
0x54	ADC_CH1_CFG4	ADC Channel 1 configuration register 4	0x00	Section 8.1.1.72
0x55	ADC_CH2_CFG0	ADC Channel 2 configuration register 0	0x00	Section 8.1.1.73
0x57	ADC_CH2_CFG2	Channel 2 configuration register 2	0xA1	Section 8.1.1.74
0x58	ADC_CH2_CFG3	ADC Channel 2 configuration register 3	0x80	Section 8.1.1.75
0x59	ADC_CH2_CFG4	ADC Channel 2 configuration register 4	0x00	Section 8.1.1.76
0x5A	ADC_CH3_CFG0	ADC Channel 3 configuration register 0	0x00	Section 8.1.1.77
0x5B	ADC_CH3_CFG2	ADC Channel 3 configuration register 2	0xA1	Section 8.1.1.78
0x5C	ADC_CH3_CFG3	ADC Channel 3 configuration register 3	0x80	Section 8.1.1.79
0x5D	ADC_CH3_CFG4	ADC Channel 3 configuration register 4	0x00	Section 8.1.1.80
0x5E	ADC_CH4_CFG0	ADC Channel 4 configuration register 0	0x00	Section 8.1.1.81
0x5F	ADC_CH4_CFG2	Channel 4 configuration register 2	0xA1	Section 8.1.1.82
0x60	ADC_CH4_CFG3	ADC Channel 4 configuration register 3	0x80	Section 8.1.1.83
0x61	ADC_CH4_CFG4	ADC Channel 4 configuration register 4	0x00	Section 8.1.1.84
0x62	ADC_CFG1	ADC configuration register 1	0x00	Section 8.1.1.85
0x64	OUT1x_CFG0	Channel OUT1x configuration register 0	0x20	Section 8.1.1.86
0x65	OUT1x_CFG1	Channel OUT1x configuration register 1	0x20	Section 8.1.1.87

Table 8-2. BOOK0_P0 Registers (continued)

Address	Acronym	Register Name	Reset Value	Section
0x66	OUT1x_CFG2	Channel OUT2x configuration register 2	0x20	Section 8.1.1.88
0x67	DAC_CH1A_CFG0	DAC Channel 1A configuration register 0	0xC9	Section 8.1.1.89
0x68	DAC_CH1A_CFG1	DAC Channel 1A configuration register 1	0x80	Section 8.1.1.90
0x69	DAC_CH1B_CFG0	DAC Channel 1B configuration register 0	0xC9	Section 8.1.1.91
0x6A	DAC_CH1B_CFG1	DAC Channel 1B configuration register 1	0x80	Section 8.1.1.92
0x6B	OUT2x_CFG0	Channel OUT2x configuration register 0	0x20	Section 8.1.1.93
0x6C	OUT2x_CFG1	Channel OUT2x configuration register 1	0x20	Section 8.1.1.94
0x6D	OUT2x_CFG2	Channel OUT2x configuration register 2	0x20	Section 8.1.1.95
0x6E	DAC_CH2A_CFG0	DAC Channel 2A configuration register 0	0xC9	Section 8.1.1.96
0x6F	DAC_CH2A_CFG1	DAC Channel 2A configuration register 1	0x80	Section 8.1.1.97
0x70	DAC_CH2B_CFG0	DAC Channel 2B configuration register 0	0xC9	Section 8.1.1.98
0x71	DAC_CH2B_CFG1	DAC Channel 2B configuration register 1	0x80	Section 8.1.1.99
0x72	DSP_CFG0	DSP configuration register 0	0x18	Section 8.1.1.100
0x73	DSP_CFG1	DSP configuration register 0	0x18	Section 8.1.1.101
0x76	CH_EN	Channel enable configuration register	0xCC	Section 8.1.1.102
0x77	DYN_PUPD_CFG	Power up configuration register	0x00	Section 8.1.1.103
0x78	PWR_CFG	Power up configuration register	0x00	Section 8.1.1.104
0x79	DEV_STS0	Device status value register 0	0x00	Section 8.1.1.105
0x7A	DEV_STS1	Device status value register 1	0x80	Section 8.1.1.106
0x7E	I2C_CKSUM	I ² C checksum register	0x00	Section 8.1.1.107

8.1.1.1 PAGE_CFG Register (Address = 0x0) [Reset = 0x00]

PAGE_CFG is shown in [Table 8-3](#).

Return to the [Summary Table](#).

The device memory map is divided into pages. This register sets the page.

Table 8-3. PAGE_CFG Register Field Descriptions

Bit	Field	Type	Reset	Description
7-0	PAGE[7:0]	R/W	00000000b	These bits set the device page. 0d = Page 0 1d = Page 1 2d to 254d = Page 2 to page 254 respectively 255d = Page 255

8.1.1.2 SW_RESET Register (Address = 0x1) [Reset = 0x00]

SW_RESET is shown in [Table 8-4](#).

Return to the [Summary Table](#).

This register is the software reset register. Asserting a software reset places all register values in their default power-on-reset (POR) state.

Table 8-4. SW_RESET Register Field Descriptions

Bit	Field	Type	Reset	Description
7-1	RESERVED	R	0b	Reserved bits; Write only reset value

Table 8-4. SW_RESET Register Field Descriptions (continued)

Bit	Field	Type	Reset	Description
0	SW_RESET	R/W	0b	Software reset. This bit is self clearing. 0d = Do not reset 1d = Reset all registers to their reset values

8.1.1.3 DEV_MISC_CFG Register (Address = 0x2) [Reset = 0x00]

DEV_MISC_CFG is shown in [Table 8-5](#).

Return to the [Summary Table](#).

This register configures miscellaneous device registers.

Table 8-5. DEV_MISC_CFG Register Field Descriptions

Bit	Field	Type	Reset	Description
7-6	RESERVED	R	0b	Reserved bits; Write only reset values
5-4	VREF_QCHG[1:0]	R/W	00b	The duration of the quick-charge for the VREF external capacitor is set using an internal series impedance of 200Ω. 0d = VREF quick-charge duration of 3.5 ms (typical) 1d = VREF quick-charge duration of 10 ms (typical) 2d = VREF quick-charge duration of 50 ms (typical) 3d = VREF quick-charge duration of 100 ms (typical)
3	SLEEP_EXIT_VREF_EN	R/W	0b	Sleep mode exit configuration 0d = Only DREG Enabled 1d = DREG and VREF enabled
2	AVDD_MODE	R/W	0b	AVDD mode configuration. 0d = Internal AREG regulator is used (Should be used for AVDD 3.3V Operation) 1d = AVDD 1.8V used directly for AREG (Strictly use this setting for AVDD 1.8V Operation)
1	IOVDD_IO_MODE	R/W	0b	IOVDD mode configuration. 0d = IOVDD at 3.3V / 1.8V / 1.2V (speed limitation applicable for 1.8V and 1.2V Operation) 1d = IOVDD at 1.8V / 1.2V only (no speed limitation - Strictly don't use this setting for IOVDD 3.3V Operation).
0	SLEEP_ENZ	R/W	0b	Sleep mode setting. 0d = Device is in sleep mode 1d = Device is not in sleep mode

8.1.1.4 AVDD_IOVDD_STS Register (Address = 0x3) [Reset = 0x00]

AVDD_IOVDD_STS is shown in [Table 8-6](#).

Return to the [Summary Table](#).

This register contains status of the supply detection and brown-out.

Table 8-6. AVDD_IOVDD_STS Register Field Descriptions

Bit	Field	Type	Reset	Description
7	AVDD_MODE_STS	R	0b	AVDD mode status flag register. 0d = AVDD_MODE as per configured 1d = AVDD 3.3V Operation (AVDD_MODE forced to 0d)
6	IOVDD_IO_MODE_STS	R	0b	IOVDD mode status flag register. 0d = IOVDD_MODE as per configured 1d = IOVDD 3.3V Operation (IOVDD_IO_MODE forced to 0d)
5-2	RESERVED	R	0b	Reserved bits; Write only reset values

Table 8-6. AVDD_IOVDD_STS Register Field Descriptions (continued)

Bit	Field	Type	Reset	Description
1	BRWNOUT_SHDN_STS	R	0b	Brownout shutdown status 0d = No brownout shutdown 1d = Brownout shutdown
0	BRWNOUT_SHDN_EXIT_SLEEP	R/W	0b	Brownout shutdown sleep exit config 0d = Stay in sleep mode 1d = Exit sleep mode

8.1.1.5 MISC_CFG Register (Address = 0x4) [Reset = 0x00]

MISC_CFG is shown in [Table 8-7](#).

Return to the [Summary Table](#).

This register configures miscellaneous configuration registers.

Table 8-7. MISC_CFG Register Field Descriptions

Bit	Field	Type	Reset	Description
7	RESERVED	R	0b	Reserved bit; Write only reset value
6	IGNORE_CLK_ERR	R/W	0b	Clock error detection action 0b = Clock error enabled 1b = Clock error disabled
5	RESERVED	R	0b	Reserved bit; Write only reset value
4	RESERVED	R	0b	Reserved bit; Write only reset value
3	RESERVED	R	0b	Reserved bit; Write only reset value
2	RESERVED	R	0b	Reserved bit; Write only reset value
1	I2C_BRDCAST_EN	R/W	0b	I ² C broadcast addressing setting. 0d = I ² C broadcast mode disabled 1d = I ² C broadcast mode enabled; the I ² C target address is fixed with pin-controlled LSB bits as '0'
0	RESERVED	R	0b	Reserved bit; Write only reset value

8.1.1.6 MISC_CFG1 Register (Address = 0x5) [Reset = 0x15]

MISC_CFG1 is shown in [Table 8-8](#).

Return to the [Summary Table](#).

This register configures the miscellaneous configuration register 1.

Table 8-8. MISC_CFG1 Register Field Descriptions

Bit	Field	Type	Reset	Description
7-6	INCAP_QCHG[1:0]	R/W	00b	The duration of the quick-charge for the external AC-coupling capacitor is set using an internal series impedance of 800Ω. 0d = INxP, INxM quick-charge duration of 2.5 ms (typical) 1d = INxP, INxM quick-charge duration of 12.5 ms (typical) 2d = INxP, INxM quick-charge duration of 25 ms (typical) 3d = INxP, INxM quick-charge duration of 50 ms (typical)
5-4	SHDN_CFG[1:0]	R/W	01b	Shutdown configuration. 0d = DREG is powered down immediately after IOVDD is deasserted 1d = DREG remains active to enable a clean shut down until a time-out (DREG_KA_TIME) is reached; after the time-out period, DREG is forced to power off 2d = DREG remains active until the device cleanly shuts down 3d = Reserved; Don't use

Table 8-8. MISC_CFG1 Register Field Descriptions (continued)

Bit	Field	Type	Reset	Description
3-2	DREG_KA_TIME[1:0]	R/W	01b	These bits set how long DREG remains active after IOVDD is deasserted. 0d = DREG remains active for 30 ms (typical) 1d = DREG remains active for 25 ms (typical) 2d = DREG remains active for 10 ms (typical) 3d = DREG remains active for 5 ms (typical)
1-0	RESERVED	R	0b	Reserved bits; Write only reset values

8.1.1.7 DAC_CFG_A0 Register (Address = 0x6) [Reset = 0x35]

DAC_CFG_A0 is shown in [Table 8-9](#).

Return to the [Summary Table](#).

This register configures the device DAC de-pop.

Table 8-9. DAC_CFG_A0 Register Field Descriptions

Bit	Field	Type	Reset	Description
7-6	RSERIES_DE_POP_INT[1:0]	R/W	00b	HP Amp series resistor select config. 0d = 1K 1d = 0.5K 2d = 0.33K 3d = 0.25k
5-4	RSERIES_DE_POP_MID[1:0]	R/W	11b	HP Amp series resistor select config. 0d = 1K 1d = 0.5K 2d = 0.33K 3d = 0.25k
3-0	PWR_UP_TIME_DE_PO P[3:0]	R/W	0101b	HP Amp external cap charging time config. 0d = 2ms 1d = 4ms 2d = 8ms 3d = 16ms 4d = 50ms 5d = 100ms 6d = 250ms 7d = 500ms 8d = 1s 9d = 5s 10d-15d = Reserved

8.1.1.8 MISC_CFG0 Register (Address = 0x7) [Reset = 0x00]

MISC_CFG0 is shown in [Table 8-10](#).

Return to the [Summary Table](#).

This register configures the miscellaneous configuration register 0.

Table 8-10. MISC_CFG0 Register Field Descriptions

Bit	Field	Type	Reset	Description
7	DAC_ST_W_CAP_DIS	R/W	0b	DAC start with dc blocking capacitor discharge sequence. 0d = disable 1d = enable
6	DAC_DLYD_PWRUP	R/W	0b	DAC power up delayed config. 0d = disable 1d = enable (Delay power-up by based on DAC_DLYD_PWRUP_TIME config)

Table 8-10. MISC_CFG0 Register Field Descriptions (continued)

Bit	Field	Type	Reset	Description
5	DAC_DLYD_PWRUP_TIME	R/W	0b	DAC power up delayed time config. 0d = 64-128ms 1d = 256-512ms
4	HW_RESET_ON_CLK_S TOP_EN	R/W	0b	Assertion of Hard Reset when clock selected by CLK_SRC_SEL is not available for 2ms config 0d = disable 1d = enable
3-0	RESERVED	R	0b	Reserved bits; Write only reset values

8.1.1.9 GPIO1_CFG0 Register (Address = 0xA) [Reset = 0x32]

GPIO1_CFG0 is shown in [Table 8-11](#).

Return to the [Summary Table](#).

This register is the GPIO1 configuration register 0.

Table 8-11. GPIO1_CFG0 Register Field Descriptions

Bit	Field	Type	Reset	Description
7-4	GPIO1_CFG[3:0]	R/W	0011b	GPIO1 configuration. 0d = GPIO1 is disabled 1d = GPIO1 is configured as a general-purpose input (GPI) or any other input function 2d = GPIO1 is configured as a general-purpose output (GPO) 3d = GPIO1 is configured as a chip interrupt output (IRQ) 4d = GPIO1 is configured as a PDM clock output (PDMCLK) 5d = GPIO1 is configured as primary ASI DOUT 6d = GPIO1 is configured as primary ASI DOUT2 7d = GPIO1 is configured as secondary ASI DOUT 8d = GPIO1 is configured as secondary ASI DOUT2 9d = GPIO1 is configured as secondary ASI BCLK output 10d = GPIO1 is configured as secondary ASI FSYNC output 11d = GPIO1 is configured as general purpose CLKOUT 12d = GPIO1 is configured as PASI DOUT and SASI DOUT muxed 13d = GPIO1 is configured as DAISY_OUT for DIN Daisy 14d to 15d = Reserved
3	RESERVED	R	0b	Reserved bit; Write only reset value
2-0	GPIO1_DRV[2:0]	R/W	010b	GPIO1 output drive configuration. (Not valid if GPIO1_CFG configured as I ² S out) 0d = Hi-Z output 1d = Drive active low and active high 2d = Drive active low and weak high 3d = Drive active low and Hi-Z 4d = Drive weak low and active high 5d = Drive Hi-Z and active high 6d to 7d = Reserved; Don't use

8.1.1.10 GPIO2_CFG0 Register (Address = 0xB) [Reset = 0x00]

GPIO2_CFG0 is shown in [Table 8-12](#).

Return to the [Summary Table](#).

This register is the GPIO2 configuration register 0.

Table 8-12. GPIO2_CFG0 Register Field Descriptions

Bit	Field	Type	Reset	Description
7-4	GPIO2_CFG[3:0]	R/W	0000b	GPIO2 configuration. 0d = GPIO2 is disabled 1d = GPIO2 is configured as a general-purpose input (GPI) or any other input function 2d = GPIO2 is configured as a general-purpose output (GPO) 3d = GPIO2 is configured as a chip interrupt output (IRQ) 4d = GPIO2 is configured as a PDM clock output (PDMCLK) 5d = GPIO2 is configured as primary ASI DOUT 6d = GPIO2 is configured as primary ASI DOUT2 7d = GPIO2 is configured as secondary ASI DOUT 8d = GPIO2 is configured as secondary ASI DOUT2 9d = GPIO2 is configured as secondary ASI BCLK output 10d = GPIO2 is configured as secondary ASI FSYNC output 11d = GPIO2 is configured as general purpose CLKOUT 12d = GPIO2 is configured as PASI DOUT and SASI DOUT muxed 13d = GPIO2 is configured as DAISY_OUT for DIN Daisy 14d to 15d = Reserved
3	RESERVED	R	0b	Reserved bit; Write only reset value
2-0	GPIO2_DRV[2:0]	R/W	000b	GPIO2 output drive configuration. (Not valid if GPIO2_CFG configured as I ² S out) 0d = Hi-Z output 1d = Drive active low and active high 2d = Drive active low and weak high 3d = Drive active low and Hi-Z 4d = Drive weak low and active high 5d = Drive Hi-Z and active high 6d to 7d = Reserved; Don't use

8.1.1.11 GPO1_CFG0 Register (Address = 0xC) [Reset = 0x00]

GPO1_CFG0 is shown in [Table 8-13](#).

Return to the [Summary Table](#).

This register is the GPO1 configuration register 0.

Table 8-13. GPO1_CFG0 Register Field Descriptions

Bit	Field	Type	Reset	Description
7-4	GPO1_CFG[3:0]	R/W	0000b	GPO1 configuration. (For SPI mode, this pin act as POCI and the below configuration settings are not applicable) (Always buskeeper en is not supported when used as DOUT) 0d = GPO1 is disabled 1d = Reserved 2d = GPO1 is configured as a general-purpose output (GPO) 3d = GPO1 is configured as a chip interrupt output (IRQ) 4d = GPO1 is configured as a PDM clock output (PDMCLK) 5d = GPO1 is configured as primary ASI DOUT 6d = GPO1 is configured as primary ASI DOUT2 7d = GPO1 is configured as secondary ASI DOUT 8d = GPO1 is configured as secondary ASI DOUT2 9d = GPO1 is configured as secondary ASI BCLK output 10d = GPO1 is configured as secondary ASI FSYNC output 11d = GPO1 is configured as general purpose CLKOUT 12d = GPO1 is configured as PASI DOUT and SASI DOUT muxed 13d = GPO1 is configured as DAISY_OUT for DIN Daisy 14d to 15d = Reserved
3	RESERVED	R	0b	Reserved bit; Write only reset value

Table 8-13. GPO1_CFG0 Register Field Descriptions (continued)

Bit	Field	Type	Reset	Description
2-0	GPO1_DRV[2:0]	R/W	000b	GPO1 output drive configuration. (Not valid if GPO1_CFG configured as I ² S out) (For SPI mode, this pin act as CSZ and the below configuration settings are not applicable) 0d = Hi-Z output 1d = Drive active low and active high 2d = Drive active low and weak high 3d = Drive active low and Hi-Z 4d = Drive weak low and active high 5d = Drive Hi-Z and active high 6d to 7d = Reserved; Don't use

8.1.1.12 GPI_CFG Register (Address = 0xD) [Reset = 0x00]

GPI_CFG is shown in [Table 8-14](#).

Return to the [Summary Table](#).

This register is the GPI1 configuration register 0.

Table 8-14. GPI_CFG Register Field Descriptions

Bit	Field	Type	Reset	Description
7-2	RESERVED	R	0b	Reserved bits; Write only reset values
1	GPI1_CFG	R/W	0b	GPI1 configuration. (For SPI mode, this pin act as CSZ and the below configuration settings are not applicable) 0d = GPI1 is disabled 1d = GPI1 is configured as a general-purpose input (GPI) or any other input function
0	RESERVED	R	0b	Reserved bit; Write only reset value

8.1.1.13 GPO_GPI_VAL Register (Address = 0xE) [Reset = 0x00]

GPO_GPI_VAL is shown in [Table 8-15](#).

Return to the [Summary Table](#).

This register is the GPIO and GPO output value register.

Table 8-15. GPO_GPI_VAL Register Field Descriptions

Bit	Field	Type	Reset	Description
7	GPIO1_VAL	R/W	0b	GPIO1 output value when configured as a GPO. 0d = Drive the output with a value of 0 1d = Drive the output with a value of 1
6	GPIO2_VAL	R/W	0b	GPIO2 output value when configured as a GPO. 0d = Drive the output with a value of 0 1d = Drive the output with a value of 1
5	GPO1_VAL	R/W	0b	GPO1 output value when configured as a GPO. 0d = Drive the output with a value of 0 1d = Drive the output with a value of 1
4	RESERVED	R	0b	Reserved bit; Write only reset value
3	GPIO1_MON	R	0b	GPIO1 monitor value when configured as a GPI. 0d = Input monitor value 0 1d = Input monitor value 1
2	GPIO2_MON	R	0b	GPIO2 monitor value when configured as a GPI. 0d = Input monitor value 0 1d = Input monitor value 1

Table 8-15. GPO_GPI_VAL Register Field Descriptions (continued)

Bit	Field	Type	Reset	Description
1	GPI1_MON	R	0b	GPI1 monitor value when configured as a GPI. 0d = Input monitor value 0 1d = Input monitor value 1
0	RESERVED	R	0b	Reserved bit; Write only reset value

8.1.1.14 INTF_CFG0 Register (Address = 0xF) [Reset = 0x00]

INTF_CFG0 is shown in [Table 8-16](#).

Return to the [Summary Table](#).

This register is the interface configuration register 0.

Table 8-16. INTF_CFG0 Register Field Descriptions

Bit	Field	Type	Reset	Description
7	RESERVED	R	0b	Reserved bit; Write only reset value
6-5	CCLK_SEL[1:0]	R/W	00b	CCLK select configuration. 0d = CCLK is disabled 1d = GPIO1 2d = GPIO2 3d = GPI1
4-2	PASI_DIN2_SEL[2:0]	R/W	000b	Primary ASI DIN2 select configuration. 0d = Primary ASI DIN2 is disabled 1d = GPIO1 2d = GPIO2 3d = GPI1 4d = DOUT 5d = Primary ASI DIN 6d to 7d = Reserved
1	PASI_BCLK_SEL	R/W	0b	Primary ASI BCLK select configuration. 0d = Primary ASI BCLK is BCLK 1d = Primary ASI BCLK is Secondary ASI BCLK
0	PASI_FSYNC_SEL	R/W	0b	Primary ASI FSYNC select configuration. 0d = Primary ASI FSYNC is FSYNC 1d = Primary ASI FSYNC is Secondary ASI FSYNC

8.1.1.15 INTF_CFG1 Register (Address = 0x10) [Reset = 0x52]

INTF_CFG1 is shown in [Table 8-17](#).

Return to the [Summary Table](#).

This register is the interface configuration register 1.

Table 8-17. INTF_CFG1 Register Field Descriptions

Bit	Field	Type	Reset	Description
7-4	DOUT_SEL[3:0]	R/W	0101b	DOUT select configuration. 0d = DOUT is disabled 1d = DOUT is configured as input 2d = DOUT is configured as a general-purpose output (GPO) 3d = DOUT is configured as a chip interrupt output (IRQ) 4d = DOUT is configured as a PDM clock output (PDMCLK) 5d = DOUT is configured as primary ASI DOUT 6d = DOUT is configured as primary ASI DOUT2 7d = DOUT is configured as secondary ASI DOUT 8d = DOUT is configured as secondary ASI DOUT2 9d = DOUT is configured as secondary ASI BCLK output 10d = DOUT is configured as secondary ASI FSYNC output 11d = DOUT is configured as general purpose CLKOUT 12d = DOUT is configured as PASI DOUT and SASI DOUT muxed 13d = DOUT is configured as DAISY_OUT for DIN Daisy 14d = DOUT is configured as DIN (LOOPBACK) 15d = Reserved
3	DOUT_VAL	R/W	0b	DOUT output value when configured as a GPO. 0d = Drive the output with a value of 0 1d = Drive the output with a value of 1
2-0	DOUT_DRV[2:0]	R/W	010b	DOUT output drive configuration. 0d = Hi-Z output 1d = Drive active low and active high 2d = Drive active low and weak high 3d = Drive active low and Hi-Z 4d = Drive weak low and active high 5d = Drive Hi-Z and active high 6d to 7d = Reserved; Don't use

8.1.1.16 INTF_CFG2 Register (Address = 0x11) [Reset = 0x80]

INTF_CFG2 is shown in [Table 8-18](#).

Return to the [Summary Table](#).

This register is the interface configuration register 2.

Table 8-18. INTF_CFG2 Register Field Descriptions

Bit	Field	Type	Reset	Description
7	PASI_DIN_EN	R/W	1b	Primary ASI DIN enable configuration. 0d = Primary ASI DIN is disabled 1d = Primary ASI DIN is enabled
6-4	SASI_FSYNC_SEL[2:0]	R/W	000b	Secondary ASI FSYNC select configuration. 0d = Secondary ASI disabled 1d = GPIO1 2d = GPIO2 3d = GPI1 4d = Reserved 5d = Primary ASI FSYNC 6d to 7d = Reserved
3-1	SASI_BCLK_SEL[2:0]	R/W	000b	Secondary ASI BCLK select configuration. 0d = Secondary ASI disabled 1d = GPIO1 2d = GPIO2 3d = GPI1 4d = Reserved 5d = Primary ASI BCLK 6d to 7d = Reserved
0	RESERVED	R	0b	Reserved bit; Write only reset value

8.1.1.17 INTF_CFG3 Register (Address = 0x12) [Reset = 0x00]

INTF_CFG3 is shown in [Table 8-19](#).

Return to the [Summary Table](#).

This register is the interface configuration register 3.

Table 8-19. INTF_CFG3 Register Field Descriptions

Bit	Field	Type	Reset	Description
7-5	SASI_DIN_SEL[2:0]	R/W	000b	Secondary ASI DIN select configuration. 0d = Secondary ASI DIN is disabled 1d = GPIO1 2d = GPIO2 3d = GPI1 4d = DOUT 5d = Primary ASI DIN 6d to 7d = Reserved
4-2	SASI_DIN2_SEL[2:0]	R/W	000b	Secondary ASI DIN2 select configuration. 0d = Secondary ASI DIN2 is disabled 1d = GPIO1 2d = GPIO2 3d = GPI1 4d = DOUT 5d = Primary ASI DIN 6d to 7d = Reserved
1-0	RESERVED	R	0b	Reserved bits; Write only reset values

8.1.1.18 INTF_CFG4 Register (Address = 0x13) [Reset = 0x00]

INTF_CFG4 is shown in [Table 8-20](#).

Return to the [Summary Table](#).

This register is the interface configuration register 4.

Table 8-20. INTF_CFG4 Register Field Descriptions

Bit	Field	Type	Reset	Description
7	PDM_CH1_SEL	R/W	0b	PDM select configuration for channel 1 of record path. 0d = Channel 1 is analog (ADC) type on the record path 1d = Channel 1 is digital (PDM) type on the record path
6	PDM_CH2_SEL	R/W	0b	PDM select configuration for channel 2 of record path. 0d = Channel 2 is analog (ADC) type on the record path 1d = Channel 2 is digital (PDM) type on the record path
5	PDMDIN1_EDGE	R/W	0b	PDMCLK latching edge used for channel 1 and channel 2 data. 0d = Channel 1 data are latched on the negative edge, channel 2 data are latched on the positive edge 1d = Channel 1 data are latched on the positive edge, channel 2 data are latched on the negative edge
4	PDMDIN2_EDGE	R/W	0b	PDMCLK latching edge used for channel 3 and channel 4 data. 0d = Channel 3 data are latched on the negative edge, channel 4 data are latched on the positive edge 1d = Channel 3 data are latched on the positive edge, channel 4 data are latched on the negative edge
3-2	PDM_DIN1_SEL[1:0]	R/W	00b	PDM data channels 1 and 2 select configuration. 0d = PDM data channels 1 and 2 are disabled 1d = GPIO1 2d = GPIO2 3d = GPI1

Table 8-20. INTF_CFG4 Register Field Descriptions (continued)

Bit	Field	Type	Reset	Description
1-0	PDM_DIN2_SEL[1:0]	R/W	00b	PDM data channels 3 and 4 select configuration. 0d = PDM data channels 3 and 4 are disabled 1d = GPIO1 2d = GPIO2 3d = GPI1

8.1.1.19 INTF_CFG5 Register (Address = 0x14) [Reset = 0x00]

INTF_CFG5 is shown in [Table 8-21](#).

Return to the [Summary Table](#).

This register is the interface configuration register 5.

Table 8-21. INTF_CFG5 Register Field Descriptions

Bit	Field	Type	Reset	Description
7	PDM_DIN_SEL_OVRD	R/W	0b	PDM data channels (1 and 2)/(3 and 4) select configuration override. 0d = No Override 1d = PDM_DIN1/2_SEL if configured as GPI1 will be overridden as DIN
6	DOOUT_WITH_DIN	R/W	0b	DOOUT used as both ASI OUT and ASI IN 0d = DOOUT based on DOOUT_SEL 1d = DOOUT used as both ASI OUT and ASI DIN
5-4	PD_ADC_GPIO[1:0]	R/W	00b	Power down ADC using GPIO select configuration.(ADC powered down if any one of the PD_ADC_GPIO/ADC_PDZ is configured power down) 0d = Power down ADC using GPIO is disabled 1d = Power down ADC using GPIO1 2d = Power down ADC using GPIO2 3d = Power down ADC using GPI1
3-2	PD_DAC_GPIO[1:0]	R/W	00b	Power down DAC using GPIO select configuration.(DAC powered down if any one of the PD_DAC_GPIO/DAC_PDZ is configured power down) 0d = Power down DAC using GPIO is disabled 1d = Power down DAC using GPIO1 2d = Power down DAC using GPIO2 3d = Power down DAC using GPI1
1	PLIM_GPIO	R/W	0b	PLIM using GPIO1 configuration. 0d = PLIM using GPIO1 is disabled 1d = PLIM using GPIO1
0	GPA_GPIO	R/W	0b	GPA using GPIO1 configuration. 0d = GPA using GPIO1 is disabled 1d = GPA using GPIO1

8.1.1.20 INTF_CFG6 Register (Address = 0x15) [Reset = 0x00]

INTF_CFG6 is shown in [Table 8-22](#).

Return to the [Summary Table](#).

This register is the interface configuration register 6.

Table 8-22. INTF_CFG6 Register Field Descriptions

Bit	Field	Type	Reset	Description
7-6	EN_MBIAS_GPIO[1:0]	R/W	00b	Enable MICBIAS using GPIO select configuration. 0d = Enable MICBIAS using GPIO is disabled 1d = Enable MICBIAS using GPIO1 2d = Enable MICBIAS using GPIO2 3d = Enable MICBIAS using GPI1

Table 8-22. INTF_CFG6 Register Field Descriptions (continued)

Bit	Field	Type	Reset	Description
5-4	IADC_CONVST_GPIO[1:0]]	R/W	00b	IADC conversion start using GPIO select configuration. 0d = Enable IADC using GPIO is disabled 1d = Enable IADC using GPIO1 2d = Enable IADC using GPIO2 3d = Enable IADC using GPI1
3-0	RESERVED	R	0b	Reserved bits; Write only reset value

8.1.1.21 ASI_CFG0 Register (Address = 0x18) [Reset = 0x40]

ASI_CFG0 is shown in [Table 8-23](#).

Return to the [Summary Table](#).

This register is the ASI configuration register 0.

Table 8-23. ASI_CFG0 Register Field Descriptions

Bit	Field	Type	Reset	Description
7	PASI_DIS	R/W	0b	Disable or enable primary ASI (PASI). 0d = Primary ASI enabled 1d = Primary ASI disabled
6	SASI_DIS	R/W	1b	Disable or enable secondary ASI (SASI). 0d = Secondary ASI enabled 1d = Secondary ASI disabled
5	SASI_CFG_GANG	R/W	0b	All configurations of secondary ASI ganged with primary ASI. 0d = Secondary ASI has independent configurations 1d = Secondary ASI configurations same as primary ASI
4-3	DAISY_EN[1:0]	R/W	00b	Daisy chain feature enable (Only 1 ASI with 1 DOUT AND DIN available) 0d = Daisy chain disabled 1d = PASI daisy chain enabled (Secondary ASI not available) 2d = SASI daisy chain enabled (Primary ASI not available) 3d = Reserved; Don't use
2-0	DAISY_IN_SEL[2:0]	R/W	000b	Daisy input select configuration. 0d = Daisy input disabled 1d = GPIO1 2d = GPIO2 3d = GPI1 4d = Reserved 5d = DIN 6d to 7d = Reserved

8.1.1.22 ASI_CFG1 Register (Address = 0x19) [Reset = 0x00]

ASI_CFG1 is shown in [Table 8-24](#).

Return to the [Summary Table](#).

This register is the ASI configuration register 1.

Table 8-24. ASI_CFG1 Register Field Descriptions

Bit	Field	Type	Reset	Description
7-6	ASI_DOUT_CFG[1:0]	R/W	00b	ASI data output configuration. 0d = 1 data output for Primary ASI and 1 data output for Secondary ASI 1d = 2 data outputs for Primary ASI 2d = 2 data outputs for Secondary ASI 3d = Reserved; Don't use

Table 8-24. ASI_CFG1 Register Field Descriptions (continued)

Bit	Field	Type	Reset	Description
5-4	ASI_DIN_CFG[1:0]	R/W	00b	ASI data input configuration. 0d = 1 data input for Primary ASI and 1 data input for Secondary ASI 1d = 2 data inputs for Primary ASI 2d = 2 data inputs for Secondary ASI 3d = Reserved; Don't use
3	DAISY_DIR	R/W	0b	Daisy direction configuration. 0d = ASI DOUT daisy 1d = ASI DIN daisy
2	RESERVED	R	0b	Reserved bit; Write only reset value
1	RESERVED	R	0b	Reserved bit; Write only reset value
0	RESERVED	R	0b	Reserved bit; Write only reset value

8.1.1.23 PASI_CFG0 Register (Address = 0x1A) [Reset = 0x30]

PASI_CFG0 is shown in [Table 8-25](#).

Return to the [Summary Table](#).

This register is the ASI configuration register 0.

Table 8-25. PASI_CFG0 Register Field Descriptions

Bit	Field	Type	Reset	Description
7-6	PASI_FORMAT[1:0]	R/W	00b	Primary ASI protocol format. 0d = TDM mode 1d = I ² S mode 2d = LJ (left-justified) mode 3d = Reserved; Don't use
5-4	PASI_WLEN[1:0]	R/W	11b	Primary ASI word or slot length. 0d = 16 bits (Recommended this setting to be used with 10kΩ input impedance configuration) 1d = 20 bits 2d = 24 bits 3d = 32 bits
3	PASI_FSYNC_POL	R/W	0b	ASI FSYNC polarity (for PASI protocol only). 0d = Default polarity as per standard protocol 1d = Inverted polarity with respect to standard protocol
2	PASI_BCLK_POL	R/W	0b	ASI BCLK polarity (for PASI protocol only). 0d = Default polarity as per standard protocol 1d = Inverted polarity with respect to standard protocol
1	PASI_BUS_ERR	R/W	0b	ASI bus error detection. 0d = Enable bus error detection 1d = Disable bus error detection
0	PASI_BUS_ERR_RCOV	R/W	0b	ASI bus error auto resume. 0d = Enable auto resume after bus error recovery 1d = Disable auto resume after bus error recovery and remain powered down until host configures the device

8.1.1.24 PASI_TX_CFG0 Register (Address = 0x1B) [Reset = 0x00]

PASI_TX_CFG0 is shown in [Table 8-26](#).

Return to the [Summary Table](#).

This register is the PASI TX configuration register 0.

Table 8-26. PASI_TX_CFG0 Register Field Descriptions

Bit	Field	Type	Reset	Description
7	PASI_TX_EDGE	R/W	0b	Primary ASI data output (on the primary and secondary data pin) transmit edge. 0d = Default edge as per the protocol configuration setting in PASI_BCLK_POL 1d = Inverted following edge (half cycle delay) with respect to the default edge setting
6	PASI_TX_FILL	R/W	0b	Primary ASI data output (on the primary and secondary data pin) for any unused cycles 0d = Always transmit 0 for unused cycles 1d = Always use Hi-Z for unused cycles
5	PASI_TX_LSB	R/W	0b	Primary ASI data output (on the primary and secondary data pin) for LSB transmissions. 0d = Transmit the LSB for a full cycle 1d = Transmit the LSB for the first half cycle and Hi-Z for the second half cycle
4-3	PASI_TX_KEEPER[1:0]	R/W	00b	Primary ASI data output (on the primary and secondary data pin) bus keeper. 0d = Bus keeper is always disabled 1d = Bus keeper is always enabled 2d = Bus keeper is enabled during LSB transmissions only for one cycle 3d = Bus keeper is enabled during LSB transmissions only for one and half cycles
2	PASI_TX_USE_INT_FSYN C	R/W	0b	Primary ASI uses internal FSYNC for output data generation in Controller mode configuration as applicable. 0d = Use external FSYNC for ASI protocol data generation 1d = Use internal FSYNC for ASI protocol data generation
1	PASI_TX_USE_INT_BCL K	R/W	0b	Primary ASI uses internal BCLK for output data generation in Controller mode configuration. 0d = Use external BCLK for ASI protocol data generation 1d = Use internal BCLK for ASI protocol data generation
0	PASI_TDM_PULSE_WIDT H	R/W	0b	Primary ASI fsync pulse width in TDM format. (Valid for Controller mode) 0d = Fsync pulse is 1 bclk period wide 1d = Fsync pulse is 2 bclk period wide

8.1.1.25 PASI_TX_CFG1 Register (Address = 0x1C) [Reset = 0x00]

PASI_TX_CFG1 is shown in [Table 8-27](#).

Return to the [Summary Table](#).

This register is the PASI TX configuration register 1.

Table 8-27. PASI_TX_CFG1 Register Field Descriptions

Bit	Field	Type	Reset	Description
7-5	RESERVED	R	0b	Reserved bits; Write only reset values

Table 8-27. PASI_TX_CFG1 Register Field Descriptions (continued)

Bit	Field	Type	Reset	Description
4-0	PASI_TX_OFFSET[4:0]	R/W	00000b	Primary ASI output data MSB slot 0 offset (on the primary and secondary data pin). 0d = ASI data MSB location has no offset and is as per standard protocol 1d = ASI data MSB location (TDM mode is slot 0 or I ² S, LJ mode is the left and right slot 0) offset of one BCLK cycle with respect to standard protocol 2d = ASI data MSB location (TDM mode is slot 0 or I ² S, LJ mode is the left and right slot 0) offset of two BCLK cycles with respect to standard protocol 3d to 30d = ASI data MSB location (TDM mode is slot 0 or I ² S, LJ mode is the left and right slot 0) offset assigned as per configuration 31d = ASI data MSB location (TDM mode is slot 0 or I ² S, LJ mode is the left and right slot 0) offset of 31 BCLK cycles with respect to standard protocol

8.1.1.26 PASI_TX_CFG2 Register (Address = 0x1D) [Reset = 0x00]

PASI_TX_CFG2 is shown in [Table 8-28](#).

Return to the [Summary Table](#).

This register is the PASI TX configuration register 2.

Table 8-28. PASI_TX_CFG2 Register Field Descriptions

Bit	Field	Type	Reset	Description
7	PASI_TX_CH8_SEL	R/W	0b	Primary ASI output channel 8 select. 0d = Primary ASI channel 8 output is on DOUT 1d = Primary ASI channel 8 output is on DOUT2
6	PASI_TX_CH7_SEL	R/W	0b	Primary ASI output channel 7 select. 0d = Primary ASI channel 7 output is on DOUT 1d = Primary ASI channel 7 output is on DOUT2
5	PASI_TX_CH6_SEL	R/W	0b	Primary ASI output channel 6 select. 0d = Primary ASI channel 6 output is on DOUT 1d = Primary ASI channel 6 output is on DOUT2
4	PASI_TX_CH5_SEL	R/W	0b	Primary ASI output channel 5 select. 0d = Primary ASI channel 5 output is on DOUT 1d = Primary ASI channel 5 output is on DOUT2
3	PASI_TX_CH4_SEL	R/W	0b	Primary ASI output channel 4 select. 0d = Primary ASI channel 4 output is on DOUT 1d = Primary ASI channel 4 output is on DOUT2
2	PASI_TX_CH3_SEL	R/W	0b	Primary ASI output channel 3 select. 0d = Primary ASI channel 3 output is on DOUT 1d = Primary ASI channel 3 output is on DOUT2
1	PASI_TX_CH2_SEL	R/W	0b	Primary ASI output channel 2 select. 0d = Primary ASI channel 2 output is on DOUT 1d = Primary ASI channel 2 output is on DOUT2
0	PASI_TX_CH1_SEL	R/W	0b	Primary ASI output channel 1 select. 0d = Primary ASI channel 1 output is on DOUT 1d = Primary ASI channel 1 output is on DOUT2

8.1.1.27 PASI_TX_CH1_CFG Register (Address = 0x1E) [Reset = 0x20]

PASI_TX_CH1_CFG is shown in [Table 8-29](#).

Return to the [Summary Table](#).

This register is the PASI TX Channel 1 configuration register.

Table 8-29. PASI_TX_CH1_CFG Register Field Descriptions

Bit	Field	Type	Reset	Description
7-6	RESERVED	R	0b	Reserved bits; Write only reset values
5	PASI_TX_CH1_CFG	R/W	1b	Primary ASI output channel 1 configuration. 0d = Primary ASI channel 1 output is in a tri-state condition 1d = Primary ASI channel 1 output corresponds to ADC/PDM Channel 1 data
4-0	PASI_TX_CH1_SLOT_NUM[4:0]	R/W	00000b	Primary ASI output channel 1 slot assignment. 0d = TDM is slot 0 or I ² S, LJ is left slot 0 1d = TDM is slot 1 or I ² S, LJ is left slot 1 2d to 14d = Slot assigned as per configuration 15d = TDM is slot 15 or I ² S, LJ is left slot 15 16d = TDM is slot 16 or I ² S, LJ is right slot 0 17d = TDM is slot 17 or I ² S, LJ is right slot 1 18d to 30d = Slot assigned as per configuration 31d = TDM is slot 31 or I ² S, LJ is right slot 15

8.1.1.28 PASI_TX_CH2_CFG Register (Address = 0x1F) [Reset = 0x21]

PASI_TX_CH2_CFG is shown in [Table 8-30](#).

Return to the [Summary Table](#).

This register is the PASI TX Channel 2 configuration register.

Table 8-30. PASI_TX_CH2_CFG Register Field Descriptions

Bit	Field	Type	Reset	Description
7-6	RESERVED	R	0b	Reserved bits; Write only reset values
5	PASI_TX_CH2_CFG	R/W	1b	Primary ASI output channel 2 configuration. 0d = Primary ASI channel 2 output is in a tri-state condition 1d = Primary ASI channel 2 output corresponds to ADC/PDM Channel 2 data
4-0	PASI_TX_CH2_SLOT_NUM[4:0]	R/W	00001b	Primary ASI output channel 2 slot assignment. 0d = TDM is slot 0 or I ² S, LJ is left slot 0 1d = TDM is slot 1 or I ² S, LJ is left slot 1 2d to 14d = Slot assigned as per configuration 15d = TDM is slot 15 or I ² S, LJ is left slot 15 16d = TDM is slot 16 or I ² S, LJ is right slot 0 17d = TDM is slot 17 or I ² S, LJ is right slot 1 18d to 30d = Slot assigned as per configuration 31d = TDM is slot 31 or I ² S, LJ is right slot 15

8.1.1.29 PASI_TX_CH3_CFG Register (Address = 0x20) [Reset = 0x02]

PASI_TX_CH3_CFG is shown in [Table 8-31](#).

Return to the [Summary Table](#).

This register is the PASI TX Channel 3 configuration register.

Table 8-31. PASI_TX_CH3_CFG Register Field Descriptions

Bit	Field	Type	Reset	Description
7	RESERVED	R	0b	Reserved bit; Write only reset value
6-5	PASI_TX_CH3_CFG[1:0]	R/W	00b	Primary ASI output channel 3 configuration. 0d = Primary ASI channel 3 output is in a tri-state condition 1d = Primary ASI channel 3 output corresponds to PDM Channel 3 data 2d = Primary ASI channel 3 output corresponds to VBAT data 3d = Reserved

Table 8-31. PASI_TX_CH3_CFG Register Field Descriptions (continued)

Bit	Field	Type	Reset	Description
4-0	PASI_TX_CH3_SLOT_NUM[4:0]	R/W	00010b	Primary ASI output channel 3 slot assignment. 0d = TDM is slot 0 or I ² S, LJ is left slot 0 1d = TDM is slot 1 or I ² S, LJ is left slot 1 2d to 14d = Slot assigned as per configuration 15d = TDM is slot 15 or I ² S, LJ is left slot 15 16d = TDM is slot 16 or I ² S, LJ is right slot 0 17d = TDM is slot 17 or I ² S, LJ is right slot 1 18d to 30d = Slot assigned as per configuration 31d = TDM is slot 31 or I ² S, LJ is right slot 15

8.1.1.30 PASI_TX_CH4_CFG Register (Address = 0x21) [Reset = 0x03]

PASI_TX_CH4_CFG is shown in [Table 8-32](#).

Return to the [Summary Table](#).

This register is the PASI TX Channel 4 configuration register.

Table 8-32. PASI_TX_CH4_CFG Register Field Descriptions

Bit	Field	Type	Reset	Description
7	RESERVED	R	0b	Reserved bit; Write only reset value
6-5	PASI_TX_CH4_CFG[1:0]	R/W	00b	Primary ASI output channel 4 configuration. 0d = Primary ASI channel 4 output is in a tri-state condition 1d = Primary ASI channel 4 output corresponds to PDM Channel 4 data 2d = Primary ASI channel 4 output corresponds to TEMP data 3d = Reserved
4-0	PASI_TX_CH4_SLOT_NUM[4:0]	R/W	00011b	Primary ASI output channel 4 slot assignment. 0d = TDM is slot 0 or I ² S, LJ is left slot 0 1d = TDM is slot 1 or I ² S, LJ is left slot 1 2d to 14d = Slot assigned as per configuration 15d = TDM is slot 15 or I ² S, LJ is left slot 15 16d = TDM is slot 16 or I ² S, LJ is right slot 0 17d = TDM is slot 17 or I ² S, LJ is right slot 1 18d to 30d = Slot assigned as per configuration 31d = TDM is slot 31 or I ² S, LJ is right slot 15

8.1.1.31 PASI_TX_CH5_CFG Register (Address = 0x22) [Reset = 0x04]

PASI_TX_CH5_CFG is shown in [Table 8-33](#).

Return to the [Summary Table](#).

This register is the PASI TX Channel 5 configuration register.

Table 8-33. PASI_TX_CH5_CFG Register Field Descriptions

Bit	Field	Type	Reset	Description
7	RESERVED	R	0b	Reserved bit; Write only reset value
6-5	PASI_TX_CH5_CFG[1:0]	R/W	00b	Primary ASI output channel 5 configuration. 0d = Primary ASI channel 5 output is in a tri-state condition 1d = Primary ASI channel 5 output corresponds to ASI Input Channel 1 loopback data 2d = Primary ASI channel 5 output corresponds to echo reference Channel 1 data 3d = Reserved

Table 8-33. PASI_TX_CH5_CFG Register Field Descriptions (continued)

Bit	Field	Type	Reset	Description
4-0	PASI_TX_CH5_SLOT_NUM[4:0]	R/W	00100b	Primary ASI output channel 5 slot assignment. 0d = TDM is slot 0 or I ² S, LJ is left slot 0 1d = TDM is slot 1 or I ² S, LJ is left slot 1 2d to 14d = Slot assigned as per configuration 15d = TDM is slot 15 or I ² S, LJ is left slot 15 16d = TDM is slot 16 or I ² S, LJ is right slot 0 17d = TDM is slot 17 or I ² S, LJ is right slot 1 18d to 30d = Slot assigned as per configuration 31d = TDM is slot 31 or I ² S, LJ is right slot 15

8.1.1.32 PASI_TX_CH6_CFG Register (Address = 0x23) [Reset = 0x05]

PASI_TX_CH6_CFG is shown in [Table 8-34](#).

Return to the [Summary Table](#).

This register is the PASI TX Channel 6 configuration register.

Table 8-34. PASI_TX_CH6_CFG Register Field Descriptions

Bit	Field	Type	Reset	Description
7	RESERVED	R	0b	Reserved bit; Write only reset value
6-5	PASI_TX_CH6_CFG[1:0]	R/W	00b	Primary ASI output channel 6 configuration. 0d = Primary ASI channel 6 output is in a tri-state condition 1d = Primary ASI channel 6 output corresponds to ASI Input Channel 2 loopback data 2d = Primary ASI channel 6 output corresponds to echo reference Channel 2 data 3d = Reserved
4-0	PASI_TX_CH6_SLOT_NUM[4:0]	R/W	00101b	Primary ASI output channel 6 slot assignment. 0d = TDM is slot 0 or I ² S, LJ is left slot 0 1d = TDM is slot 1 or I ² S, LJ is left slot 1 2d to 14d = Slot assigned as per configuration 15d = TDM is slot 15 or I ² S, LJ is left slot 15 16d = TDM is slot 16 or I ² S, LJ is right slot 0 17d = TDM is slot 17 or I ² S, LJ is right slot 1 18d to 30d = Slot assigned as per configuration 31d = TDM is slot 31 or I ² S, LJ is right slot 15

8.1.1.33 PASI_TX_CH7_CFG Register (Address = 0x24) [Reset = 0x06]

PASI_TX_CH7_CFG is shown in [Table 8-35](#).

Return to the [Summary Table](#).

This register is the PASI TX Channel 7 configuration register.

Table 8-35. PASI_TX_CH7_CFG Register Field Descriptions

Bit	Field	Type	Reset	Description
7	RESERVED	R	0b	Reserved bit; Write only reset value
6-5	PASI_TX_CH7_CFG[1:0]	R/W	00b	Primary ASI output channel 7 configuration. 0d = Primary ASI channel 7 output is in a tri-state condition 1d = Primary ASI channel 7 output corresponds to {VBAT_WLby2, TEMP_WLby2} 2d = Primary ASI channel 7 output corresponds to {echo_ref_ch1, echo_ref_ch2} 3d = Reserved

Table 8-35. PASI_TX_CH7_CFG Register Field Descriptions (continued)

Bit	Field	Type	Reset	Description
4-0	PASI_TX_CH7_SLOT_NUM[4:0]	R/W	00110b	Primary ASI output channel 7 slot assignment. 0d = TDM is slot 0 or I ² S, LJ is left slot 0 1d = TDM is slot 1 or I ² S, LJ is left slot 1 2d to 14d = Slot assigned as per configuration 15d = TDM is slot 15 or I ² S, LJ is left slot 15 16d = TDM is slot 16 or I ² S, LJ is right slot 0 17d = TDM is slot 17 or I ² S, LJ is right slot 1 18d to 30d = Slot assigned as per configuration 31d = TDM is slot 31 or I ² S, LJ is right slot 15

8.1.1.34 PASI_TX_CH8_CFG Register (Address = 0x25) [Reset = 0x07]

PASI_TX_CH8_CFG is shown in [Table 8-36](#).

Return to the [Summary Table](#).

This register is the PASI TX Channel 8 configuration register.

Table 8-36. PASI_TX_CH8_CFG Register Field Descriptions

Bit	Field	Type	Reset	Description
7-6	RESERVED	R	0b	Reserved bits; Write only reset values
5	PASI_TX_CH8_CFG	R/W	0b	Primary ASI output channel 8 configuration. 0d = Primary ASI channel 8 output is in a tri-state condition 1d = Primary ASI channel 8 output corresponds to ICLA data
4-0	PASI_TX_CH8_SLOT_NUM[4:0]	R/W	00111b	Primary ASI output channel 8 slot assignment. 0d = TDM is slot 0 or I ² S, LJ is left slot 0 1d = TDM is slot 1 or I ² S, LJ is left slot 1 2d to 14d = Slot assigned as per configuration 15d = TDM is slot 15 or I ² S, LJ is left slot 15 16d = TDM is slot 16 or I ² S, LJ is right slot 0 17d = TDM is slot 17 or I ² S, LJ is right slot 1 18d to 30d = Slot assigned as per configuration 31d = TDM is slot 31 or I ² S, LJ is right slot 15

8.1.1.35 PASI_RX_CFG0 Register (Address = 0x26) [Reset = 0x00]

PASI_RX_CFG0 is shown in [Table 8-37](#).

Return to the [Summary Table](#).

This register is the PASI RX configuration register 0.

Table 8-37. PASI_RX_CFG0 Register Field Descriptions

Bit	Field	Type	Reset	Description
7	PASI_RX_EDGE	R/W	0b	Primary ASI data input (on the primary and secondary data pin) receive edge. 0d = Default edge as per the protocol configuration setting in PASI_BCLK_POL 1d = Inverted following edge (half cycle delay) with respect to the default edge setting
6	PASI_RX_USE_INT_FSYNCH	R/W	0b	Primary ASI uses internal FSYNCH for input data latching in Controller mode configuration as applicable. 0d = Use external FSYNCH for ASI protocol data latching 1d = Use internal FSYNCH for ASI protocol data latching
5	PASI_RX_USE_INT_BCLK	R/W	0b	Primary ASI uses internal BCLK for input data latching in Controller mode configuration. 0d = Use external BCLK for ASI protocol data latching 1d = Use internal BCLK for ASI protocol data latching

Table 8-37. PASI_RX_CFG0 Register Field Descriptions (continued)

Bit	Field	Type	Reset	Description
4-0	PASI_RX_OFFSET[4:0]	R/W	00000b	Primary ASI data input MSB slot 0 offset (on the primary and secondary data pin). 0d = ASI data MSB location has no offset and is as per standard protocol 1d = ASI data MSB location (TDM mode is slot 0 or I ² S, LJ mode is the left and right slot 0) offset of one BCLK cycle with respect to standard protocol 2d = ASI data MSB location (TDM mode is slot 0 or I ² S, LJ mode is the left and right slot 0) offset of two BCLK cycles with respect to standard protocol 3d to 30d = ASI data MSB location (TDM mode is slot 0 or I ² S, LJ mode is the left and right slot 0) offset assigned as per configuration 31d = ASI data MSB location (TDM mode is slot 0 or I ² S, LJ mode is the left and right slot 0) offset of 31 BCLK cycles with respect to standard protocol

8.1.1.36 PASI_RX_CFG1 Register (Address = 0x27) [Reset = 0x00]

PASI_RX_CFG1 is shown in [Table 8-38](#).

Return to the [Summary Table](#).

This register is the PASI RX configuration register 1.

Table 8-38. PASI_RX_CFG1 Register Field Descriptions

Bit	Field	Type	Reset	Description
7	PASI_RX_CH8_SEL	R/W	0b	Primary ASI input channel 8 select. 0d = Primary ASI channel 8 input is on DIN 1d = Primary ASI channel 8 input is on DIN2
6	PASI_RX_CH7_SEL	R/W	0b	Primary ASI input channel 7 select. 0d = Primary ASI channel 7 input is on DIN 1d = Primary ASI channel 7 input is on DIN2
5	PASI_RX_CH6_SEL	R/W	0b	Primary ASI input channel 6 select. 0d = Primary ASI channel 6 input is on DIN 1d = Primary ASI channel 6 input is on DIN2
4	PASI_RX_CH5_SEL	R/W	0b	Primary ASI input channel 5 select. 0d = Primary ASI channel 5 input is on DIN 1d = Primary ASI channel 5 input is on DIN2
3	PASI_RX_CH4_SEL	R/W	0b	Primary ASI input channel 4 select. 0d = Primary ASI channel 4 input is on DIN 1d = Primary ASI channel 4 input is on DIN2
2	PASI_RX_CH3_SEL	R/W	0b	Primary ASI input channel 3 select. 0d = Primary ASI channel 3 input is on DIN 1d = Primary ASI channel 3 input is on DIN2
1	PASI_RX_CH2_SEL	R/W	0b	Primary ASI input channel 2 select. 0d = Primary ASI channel 2 input is on DIN 1d = Primary ASI channel 2 input is on DIN2
0	PASI_RX_CH1_SEL	R/W	0b	Primary ASI input channel 1 select. 0d = Primary ASI channel 1 input is on DIN 1d = Primary ASI channel 1 input is on DIN2

8.1.1.37 PASI_RX_CH1_CFG Register (Address = 0x28) [Reset = 0x20]

PASI_RX_CH1_CFG is shown in [Table 8-39](#).

Return to the [Summary Table](#).

This register is the PASI RX Channel 1 configuration register.

Table 8-39. PASI_RX_CH1_CFG Register Field Descriptions

Bit	Field	Type	Reset	Description
7-6	RESERVED	R	0b	Reserved bits; Write only reset values
5	PASI_RX_CH1_CFG	R/W	1b	Primary ASI input channel 1 configuration. 0d = Primary ASI channel 1 input is disabled 1d = Primary ASI channel 1 input corresponds to DAC Channel 1 data
4-0	PASI_RX_CH1_SLOT_NUM[4:0]	R/W	00000b	Primary ASI input channel 1 slot assignment. 0d = TDM is slot 0 or I ² S, LJ is left slot 0 1d = TDM is slot 1 or I ² S, LJ is left slot 1 2d to 14d = Slot assigned as per configuration 15d = TDM is slot 15 or I ² S, LJ is left slot 15 16d = TDM is slot 16 or I ² S, LJ is right slot 0 17d = TDM is slot 17 or I ² S, LJ is right slot 1 18d to 30d = Slot assigned as per configuration 31d = TDM is slot 31 or I ² S, LJ is right slot 15

8.1.1.38 PASI_RX_CH2_CFG Register (Address = 0x29) [Reset = 0x21]

PASI_RX_CH2_CFG is shown in [Table 8-40](#).

Return to the [Summary Table](#).

This register is the PASI RX Channel 2 configuration register.

Table 8-40. PASI_RX_CH2_CFG Register Field Descriptions

Bit	Field	Type	Reset	Description
7-6	RESERVED	R	0b	Reserved bits; Write only reset values
5	PASI_RX_CH2_CFG	R/W	1b	Primary ASI input channel 2 configuration. 0d = Primary ASI channel 2 input is disabled 1d = Primary ASI channel 2 input corresponds to DAC Channel 2 data
4-0	PASI_RX_CH2_SLOT_NUM[4:0]	R/W	00001b	Primary ASI input channel 2 slot assignment. 0d = TDM is slot 0 or I ² S, LJ is left slot 0 1d = TDM is slot 1 or I ² S, LJ is left slot 1 2d to 14d = Slot assigned as per configuration 15d = TDM is slot 15 or I ² S, LJ is left slot 15 16d = TDM is slot 16 or I ² S, LJ is right slot 0 17d = TDM is slot 17 or I ² S, LJ is right slot 1 18d to 30d = Slot assigned as per configuration 31d = TDM is slot 31 or I ² S, LJ is right slot 15

8.1.1.39 PASI_RX_CH3_CFG Register (Address = 0x2A) [Reset = 0x02]

PASI_RX_CH3_CFG is shown in [Table 8-41](#).

Return to the [Summary Table](#).

This register is the PASI RX Channel 3 configuration register.

Table 8-41. PASI_RX_CH3_CFG Register Field Descriptions

Bit	Field	Type	Reset	Description
7-6	RESERVED	R	0b	Reserved bits; Write only reset values
5	PASI_RX_CH3_CFG	R/W	0b	Primary ASI input channel 3 configuration. 0d = Primary ASI channel 3 input is disabled 1d = Primary ASI channel 3 input corresponds to DAC Channel 3 data

Table 8-41. PASI_RX_CH3_CFG Register Field Descriptions (continued)

Bit	Field	Type	Reset	Description
4-0	PASI_RX_CH3_SLOT_NUM[4:0]	R/W	00010b	Primary ASI input channel 3 slot assignment. 0d = TDM is slot 0 or I ² S, LJ is left slot 0 1d = TDM is slot 1 or I ² S, LJ is left slot 1 2d to 14d = Slot assigned as per configuration 15d = TDM is slot 15 or I ² S, LJ is left slot 15 16d = TDM is slot 16 or I ² S, LJ is right slot 0 17d = TDM is slot 17 or I ² S, LJ is right slot 1 18d to 30d = Slot assigned as per configuration 31d = TDM is slot 31 or I ² S, LJ is right slot 15

8.1.1.40 PASI_RX_CH4_CFG Register (Address = 0x2B) [Reset = 0x03]

PASI_RX_CH4_CFG is shown in [Table 8-42](#).

Return to the [Summary Table](#).

This register is the PASI RX Channel 4 configuration register.

Table 8-42. PASI_RX_CH4_CFG Register Field Descriptions

Bit	Field	Type	Reset	Description
7-6	RESERVED	R	0b	Reserved bits; Write only reset values
5	PASI_RX_CH4_CFG	R/W	0b	Primary ASI input channel 4 configuration. 0d = Primary ASI channel 4 input is disabled 1d = Primary ASI channel 4 input corresponds to DAC Channel 4 data
4-0	PASI_RX_CH4_SLOT_NUM[4:0]	R/W	00011b	Primary ASI input channel 4 slot assignment. 0d = TDM is slot 0 or I ² S, LJ is left slot 0 1d = TDM is slot 1 or I ² S, LJ is left slot 1 2d to 14d = Slot assigned as per configuration 15d = TDM is slot 15 or I ² S, LJ is left slot 15 16d = TDM is slot 16 or I ² S, LJ is right slot 0 17d = TDM is slot 17 or I ² S, LJ is right slot 1 18d to 30d = Slot assigned as per configuration 31d = TDM is slot 31 or I ² S, LJ is right slot 15

8.1.1.41 PASI_RX_CH5_CFG Register (Address = 0x2C) [Reset = 0x04]

PASI_RX_CH5_CFG is shown in [Table 8-43](#).

Return to the [Summary Table](#).

This register is the PASI RX Channel 5 configuration register.

Table 8-43. PASI_RX_CH5_CFG Register Field Descriptions

Bit	Field	Type	Reset	Description
7	RESERVED	R	0b	Reserved bit; Write only reset value
6-5	PASI_RX_CH5_CFG[1:0]	R/W	00b	Primary ASI input channel 5 configuration. 0d = Primary ASI channel 5 input is disabled 1d = Primary ASI channel 5 input corresponds to DAC Channel 5 data 2d = Primary ASI channel 5 input corresponds to ADC Channel 1 output loopback 3d = Reserved

Table 8-43. PASI_RX_CH5_CFG Register Field Descriptions (continued)

Bit	Field	Type	Reset	Description
4-0	PASI_RX_CH5_SLOT_NUM[4:0]	R/W	00100b	Primary ASI input channel 5 slot assignment. 0d = TDM is slot 0 or I ² S, LJ is left slot 0 1d = TDM is slot 1 or I ² S, LJ is left slot 1 2d to 14d = Slot assigned as per configuration 15d = TDM is slot 15 or I ² S, LJ is left slot 15 16d = TDM is slot 16 or I ² S, LJ is right slot 0 17d = TDM is slot 17 or I ² S, LJ is right slot 1 18d to 30d = Slot assigned as per configuration 31d = TDM is slot 31 or I ² S, LJ is right slot 15

8.1.1.42 PASI_RX_CH6_CFG Register (Address = 0x2D) [Reset = 0x05]

PASI_RX_CH6_CFG is shown in [Table 8-44](#).

Return to the [Summary Table](#).

This register is the PASI RX Channel 6 configuration register.

Table 8-44. PASI_RX_CH6_CFG Register Field Descriptions

Bit	Field	Type	Reset	Description
7	RESERVED	R	0b	Reserved bit; Write only reset value
6-5	PASI_RX_CH6_CFG[1:0]	R/W	00b	Primary ASI input channel 6 configuration. 0d = Primary ASI channel 6 input is disabled 1d = Primary ASI channel 6 input corresponds to DAC Channel 6 data 2d = Primary ASI channel 6 input corresponds to ADC Channel 2 output loopback 3d = Primary ASI channel 6 input corresponds to ICLA device 1 data
4-0	PASI_RX_CH6_SLOT_NUM[4:0]	R/W	00101b	Primary ASI input channel 6 slot assignment. 0d = TDM is slot 0 or I ² S, LJ is left slot 0 1d = TDM is slot 1 or I ² S, LJ is left slot 1 2d to 14d = Slot assigned as per configuration 15d = TDM is slot 15 or I ² S, LJ is left slot 15 16d = TDM is slot 16 or I ² S, LJ is right slot 0 17d = TDM is slot 17 or I ² S, LJ is right slot 1 18d to 30d = Slot assigned as per configuration 31d = TDM is slot 31 or I ² S, LJ is right slot 15

8.1.1.43 PASI_RX_CH7_CFG Register (Address = 0x2E) [Reset = 0x06]

PASI_RX_CH7_CFG is shown in [Table 8-45](#).

Return to the [Summary Table](#).

This register is the PASI RX Channel 7 configuration register.

Table 8-45. PASI_RX_CH7_CFG Register Field Descriptions

Bit	Field	Type	Reset	Description
7	RESERVED	R	0b	Reserved bit; Write only reset value
6-5	PASI_RX_CH7_CFG[1:0]	R/W	00b	Primary ASI input channel 7 configuration. 0d = Primary ASI channel 7 input is disabled 1d = Primary ASI channel 7 input corresponds to DAC Channel 7 data 2d = Primary ASI channel 7 input corresponds to ADC Channel 3 output loopback 3d = Primary ASI channel 7 input corresponds to ICLA device 2 data

Table 8-45. PASI_RX_CH7_CFG Register Field Descriptions (continued)

Bit	Field	Type	Reset	Description
4-0	PASI_RX_CH7_SLOT_NUM[4:0]	R/W	00110b	Primary ASI input channel 7 slot assignment. 0d = TDM is slot 0 or I ² S, LJ is left slot 0 1d = TDM is slot 1 or I ² S, LJ is left slot 1 2d to 14d = Slot assigned as per configuration 15d = TDM is slot 15 or I ² S, LJ is left slot 15 16d = TDM is slot 16 or I ² S, LJ is right slot 0 17d = TDM is slot 17 or I ² S, LJ is right slot 1 18d to 30d = Slot assigned as per configuration 31d = TDM is slot 31 or I ² S, LJ is right slot 15

8.1.1.44 PASI_RX_CH8_CFG Register (Address = 0x2F) [Reset = 0x07]

PASI_RX_CH8_CFG is shown in [Table 8-46](#).

Return to the [Summary Table](#).

This register is the PASI RX Channel 8 configuration register.

Table 8-46. PASI_RX_CH8_CFG Register Field Descriptions

Bit	Field	Type	Reset	Description
7	RESERVED	R	0b	Reserved bit; Write only reset value
6-5	PASI_RX_CH8_CFG[1:0]	R/W	00b	Primary ASI input channel 8 configuration. 0d = Primary ASI channel 8 input is disabled 1d = Primary ASI channel 8 input corresponds to DAC Channel 8 data 2d = Primary ASI channel 8 input corresponds to ADC Channel 4 output loopback 3d = Primary ASI channel 8 input corresponds to ICLA device 3 data
4-0	PASI_RX_CH8_SLOT_NUM[4:0]	R/W	00111b	Primary ASI input channel 8 slot assignment. 0d = TDM is slot 0 or I ² S, LJ is left slot 0 1d = TDM is slot 1 or I ² S, LJ is left slot 1 2d to 14d = Slot assigned as per configuration 15d = TDM is slot 15 or I ² S, LJ is left slot 15 16d = TDM is slot 16 or I ² S, LJ is right slot 0 17d = TDM is slot 17 or I ² S, LJ is right slot 1 18d to 30d = Slot assigned as per configuration 31d = TDM is slot 31 or I ² S, LJ is right slot 15

8.1.1.45 CLK_CFG0 Register (Address = 0x32) [Reset = 0x00]

CLK_CFG0 is shown in [Table 8-47](#).

Return to the [Summary Table](#).

This register is the clock configuration register 0.

Table 8-47. CLK_CFG0 Register Field Descriptions

Bit	Field	Type	Reset	Description
7-2	PASI_SAMP_RATE[5:0]	R/W	000000b	Primary ASI sample rate configuration. -Typical (Allowed Range) 0d = Primary ASI sampling rate auto detected in the device 1d = 768000 (670320-791040) 2d = 614400 (536256-632832) 3d = 512000 (446880-527360) 4d = 438857 (383040-452022) 5d = 384000 (335160-395520) 6d = 341333 (297920-351573) 7d = 307200 (268128-316416) 8d = 256000 (223440-263680) 9d = 219429 (191520-226011) 10d = 192000 (167580-197760) 11d = 170667 (148960-175786) 12d = 153600 (134064-158208) 13d = 128000 (111720-131840) 14d = 109714 (95760-113005) 15d = 96000 (83790-98880) 16d = 85333 (74480-87893) 17d = 76800 (67032-79104) 18d = 64000 (55860-65920) 19d = 54857 (47880-56502) 20d = 48000 (41895-49440) 21d = 42667 (37240-43946) 22d = 38400 (33516-39552) 23d = 32000 (27930-32960) 24d = 27429 (23940-28251) 25d = 24000 (20947-24720) 26d = 21333 (18620-21973) 27d = 19200 (16758-19776) 28d = 16000 (13965-16480) 29d = 13714 (11970-14125) 30d = 12000 (10473-12360) 31d = 10667 (9310-10986) 32d = 9600 (8379-9888) 33d = 8000 (6982-8240) 34d = 6857 (5985-7062) 35d = 6000 (5236-6180) 36d = 5333 (4655-5493) 37d = 4800 (4189-4944) 38d = 4000 (3491-4120) 39d = 3429 (2992-3531) 40d = 3000 (2618-3090) 41d-63d = Reserved
1	PASI_FS_RATE_NO_LIM	R/W	0b	Limit sampling rate to standard audio sample rates only. 0d = Standard audio rates with 1% tolerance supported using auto mode 1d = Standard audio rates with 5% tolerance supported using auto mode
0	CUSTOM_CLK_CFG	R/W	0b	Custom clock configuration enable, all dividers and mux selects need to be manually configured. 0d = Auto clock configuration 1d = Custom clock configuration

8.1.1.46 CLK_CFG1 Register (Address = 0x33) [Reset = 0x00]

CLK_CFG1 is shown in [Table 8-48](#).

Return to the [Summary Table](#).

This register is the clock configuration register 1.

Table 8-48. CLK_CFG1 Register Field Descriptions

Bit	Field	Type	Reset	Description
7-2	SASI_SAMP_RATE[5:0]	R/W	000000b	Secondary ASI sample rate configuration. -Typical (Range) 0d = Secondary ASI sampling rate auto detected in the device 1d = 768000 (670320-791040) 2d = 614400 (536256-632832) 3d = 512000 (446880-527360) 4d = 438857 (383040-452022) 5d = 384000 (335160-395520) 6d = 341333 (297920-351573) 7d = 307200 (268128-316416) 8d = 256000 (223440-263680) 9d = 219429 (191520-226011) 10d = 192000 (167580-197760) 11d = 170667 (148960-175786) 12d = 153600 (134064-158208) 13d = 128000 (111720-131840) 14d = 109714 (95760-113005) 15d = 96000 (83790-98880) 16d = 85333 (74480-87893) 17d = 76800 (67032-79104) 18d = 64000 (55860-65920) 19d = 54857 (47880-56502) 20d = 48000 (41895-49440) 21d = 42667 (37240-43946) 22d = 38400 (33516-39552) 23d = 32000 (27930-32960) 24d = 27429 (23940-28251) 25d = 24000 (20947-24720) 26d = 21333 (18620-21973) 27d = 19200 (16758-19776) 28d = 16000 (13965-16480) 29d = 13714 (11970-14125) 30d = 12000 (10473-12360) 31d = 10667 (9310-10986) 32d = 9600 (8379-9888) 33d = 8000 (6982-8240) 34d = 6857 (5985-7062) 35d = 6000 (5236-6180) 36d = 5333 (4655-5493) 37d = 4800 (4189-4944) 38d = 4000 (3491-4120) 39d = 3429 (2992-3531) 40d = 3000 (2618-3090) 41d-63d = Reserved
1	SASI_FS_RATE_NO_LIM	R/W	0b	Limit sampling rate to standard audio sample rates only. 0d = Standard audio rates with 1% tolerance supported using auto mode 1d = Standard audio rates with 5% tolerance supported using auto mode
0	RESERVED	R	0b	Reserved bit; Write only reset value

8.1.1.47 CLK_CFG2 Register (Address = 0x34) [Reset = 0x40]

CLK_CFG2 is shown in [Table 8-49](#).

Return to the [Summary Table](#).

This register is the clock configuration register 2.

Table 8-49. CLK_CFG2 Register Field Descriptions

Bit	Field	Type	Reset	Description
7	PLL_DIS	R/W	0b	Custom/Auto clock mode PLL setting. 0d = PLL is always enabled in custom clk mode/PLL is enabled based on DSP MIPS requirement in auto clock mode 1d = PLL is disabled
6	AUTO_PLL_FR_ALLOW	R/W	1b	Allow the PLL to operate in fractional mode of operation. 0d = PLL fractional mode disabled 1d = PLL fractional mode allowed
5	RESERVED	R	0b	Reserved bit; Write only reset value
4	RESERVED	R	0b	Reserved bit; Write only reset value
3-1	CLK_SRC_SEL[2:0]	R/W	000b	Input clock source select. 0d = Primary ASI BCLK is the input clock source 1d = CCLK synchronized with Primary ASI FSYNC is the input clock source 2d = Secondary ASI BCLK is the input clock source 3d = CCLK synchronized with Secondary ASI FSYNC is the input clock source 4d = Fixed CCLK frequency (used only in controller mode configuration) 5d = Internal oscillator clock is the input clock source (only supported in custom clock configuration) 6d to 7d = Reserved
0	RATIO_CLK_EDGE	R/W	0b	Edge selection for clock source ratio detection. 0d = Use rising edge of clock source to check ratio with primary or secondary FSYNC 1d = Use falling edge of clock source to check ratio with primary or secondary FSYNC

8.1.1.48 CNT_CLK_CFG0 Register (Address = 0x35) [Reset = 0x00]

CNT_CLK_CFG0 is shown in [Table 8-50](#).

Return to the [Summary Table](#).

This register is the controller mode clock configuration register 0.

Table 8-50. CNT_CLK_CFG0 Register Field Descriptions

Bit	Field	Type	Reset	Description
7-6	PDM_CLK_CFG[1:0]	R/W	00b	PDM_CLK configuration. 0d = PDM_CLK is 2.8224 MHz or 3.072 MHz 1d = PDM_CLK is 1.4112 MHz or 1.536 MHz 2d = PDM_CLK is 705.6 kHz or 768 kHz 3d = PDM_CLK is 5.6448 MHz or 6.144 MHz
5-0	CCLK_FS_RATIO_MSB[5:0]	R/W	000000b	Most significant bits for selecting the ratio between CCLK and primary/secondary ASI FSYNC with which CCLK is synchronized. 0d = Auto detect the ratio (assumption is CCLK is synchronized with primary/secondary FSYNC) 1d to 16383d = Ratio as per configuration

8.1.1.49 CNT_CLK_CFG1 Register (Address = 0x36) [Reset = 0x00]

CNT_CLK_CFG1 is shown in [Table 8-51](#).

Return to the [Summary Table](#).

This register is the controller mode clock configuration register 1.

Table 8-51. CNT_CLK_CFG1 Register Field Descriptions

Bit	Field	Type	Reset	Description
7-0	CCLK_FS_RATIO_LSB[7:0]	R/W	00000000b	Select the ratio between CCLK and primary/secondary ASI FSYNC with which CCLK is synchronized. 0d = Auto detect the ratio (assumption is CCLK is synchronized with primary/secondary FSYNC) 1d to 16383d = Ratio as per configuration

8.1.1.50 CNT_CLK_CFG2 Register (Address = 0x37) [Reset = 0x20]

CNT_CLK_CFG2 is shown in [Table 8-52](#).

Return to the [Summary Table](#).

This register is the controller mode clock configuration register 2.

Table 8-52. CNT_CLK_CFG2 Register Field Descriptions

Bit	Field	Type	Reset	Description
7-5	CCLK_FREQ_SEL[2:0]	R/W	001b	These bits select the CCLK input frequency (used only in controller mode configuration). 0d = 12 MHz 1d = 12.288 MHz 2d = 13 MHz 3d = 16 MHz 4d = 19.2 MHz 5d = 19.68 MHz 6d = 24 MHz 7d = 24.576 MHz
4	PASI_CNT_CFG	R/W	0b	Primary ASI controller or target configuration 0d = Primary ASI in target configuration 1d = Primary ASI in controller configuration
3	SASI_CNT_CFG	R/W	0b	Secondary ASI controller or target configuration 0d = Secondary ASI in target configuration 1d = Secondary ASI in controller configuration
2	RESERVED	R	0b	Reserved bit; Write only reset value
1	RESERVED	R	0b	Reserved bit; Write only reset value
0	FS_MODE	R/W	0b	Sample rate setting (valid when the device is in controller mode). This is applicable for both PASI and SASI. 0d = sampling rate is a multiple (or submultiple) of 48 kHz 1d = sampling rate is a multiple (or submultiple) of 44.1 kHz

8.1.1.51 CNT_CLK_CFG3 Register (Address = 0x38) [Reset = 0x00]

CNT_CLK_CFG3 is shown in [Table 8-53](#).

Return to the [Summary Table](#).

This register is the controller mode clock configuration register 3.

Table 8-53. CNT_CLK_CFG3 Register Field Descriptions

Bit	Field	Type	Reset	Description
7	PASI_USE_INT_BCLK_F OR_FSYNC	R/W	0b	Use internal BCLK for FSYNC generation in PASI during controller mode configuration. 0d = Use external BCLK for FSYNC generation 1d = Use internal BCLK for FSYNC generation
6	PASI_INV_BCLK_FOR_F SYNC	R/W	0b	Invert PASI BCLK polarity only for PASI FSYNC generation in controller mode configuration. 0d = Do not invert PASI BCLK polarity for PASI FSYNC generation 1d = Invert PASI BCLK polarity for PASI FSYNC generation

Table 8-53. CNT_CLK_CFG3 Register Field Descriptions (continued)

Bit	Field	Type	Reset	Description
5-0	PASI_BCLK_FS_RATIO_MSB[5:0]	R/W	000000b	MSB bits for primary ASI BCLK to FSYNC ratio in controller mode.

8.1.1.52 CNT_CLK_CFG4 Register (Address = 0x39) [Reset = 0x00]

CNT_CLK_CFG4 is shown in [Table 8-54](#).

Return to the [Summary Table](#).

This register is the controller mode clock configuration register 4.

Table 8-54. CNT_CLK_CFG4 Register Field Descriptions

Bit	Field	Type	Reset	Description
7-0	PASI_BCLK_FS_RATIO_LSB[7:0]	R/W	00000000b	LSB byte for primary ASI BCLK to FSYNC ratio in controller mode.

8.1.1.53 CNT_CLK_CFG5 Register (Address = 0x3A) [Reset = 0x00]

CNT_CLK_CFG5 is shown in [Table 8-55](#).

Return to the [Summary Table](#).

This register is the controller mode clock configuration register 5.

Table 8-55. CNT_CLK_CFG5 Register Field Descriptions

Bit	Field	Type	Reset	Description
7	SASI_USE_INT_BCLK_F OR_FSYNC	R/W	0b	Use internal BCLK for FSYNC generation in SASI during controller mode configuration. 0d = Use external BCLK for FSYNC generation 1d = Use internal BCLK for FSYNC generation
6	SASI_INV_BCLK_FOR_F SYNC	R/W	0b	Invert SASI BCLK polarity only for SASI FSYNC generation in controller mode configuration. 0d = Do not invert SASI BCLK polarity for SASI FSYNC generation 1d = Invert SASI BCLK polarity for SASI FSYNC generation
5-0	SASI_BCLK_FS_RATIO_MSB[5:0]	R/W	000000b	MSB bits for secondary ASI BCLK to FSYNC ratio in controller mode.

8.1.1.54 CNT_CLK_CFG6 Register (Address = 0x3B) [Reset = 0x00]

CNT_CLK_CFG6 is shown in [Table 8-56](#).

Return to the [Summary Table](#).

This register is the controller mode clock configuration register 6.

Table 8-56. CNT_CLK_CFG6 Register Field Descriptions

Bit	Field	Type	Reset	Description
7-0	SASI_BCLK_FS_RATIO_LSB[7:0]	R/W	00000000b	LSB byte for secondary ASI BCLK to FSYNC ratio in controller mode.

8.1.1.55 CLK_ERR_STS0 Register (Address = 0x3C) [Reset = 0x00]

CLK_ERR_STS0 is shown in [Table 8-57](#).

Return to the [Summary Table](#).

This register is the clock error and status register 0.

Table 8-57. CLK_ERR_STS0 Register Field Descriptions

Bit	Field	Type	Reset	Description
7	DSP_CLK_ERR	R	0b	Flag indicating ratio error between FSYNC and selected clock source. 0d = No ratio error 1d = Ratio error between primary or secondary ASI FSYNC and selected clock source
6	RESERVED	R	0b	Reserved bit; Write only reset value
5	RESERVED	R	0b	Reserved bit; Write only reset value
4	SRC_RATIO_ERR	R	0b	Flag indicating that SRC m:n ratio is unsupported. (not valid for custom m/n ratio config). 0d = m:n ratio supported 1d = Unsupported m:n ratio error
3	DEM_RATE_ERR	R	0b	Flag indicating that clock configuration does not allow valid DEM rate. 0d = No DEM clock rate error 1d = DEM clock rate error in selected clock configuration
2	PDM_CLK_ERR	R	0b	Flag indicating that clock configuration does not allow valid PDM clock generation. 0d = No PDM clock generation error 1d = PDM clock generation error in selected clock configuration
1	RESET_ON_CLK_STOP_DET_STS	R	0b	Flag indicating that audio clock source stopped for at least 1ms. 0d = No audio clock source error 1d = Audio clock source stopped for at least 1ms
0	RESERVED	R	0b	Reserved bit; Write only reset value

8.1.1.56 CLK_ERR_STS1 Register (Address = 0x3D) [Reset = 0x00]

CLK_ERR_STS1 is shown in [Table 8-58](#).

Return to the [Summary Table](#).

This register is the clock error and status register 1.

Table 8-58. CLK_ERR_STS1 Register Field Descriptions

Bit	Field	Type	Reset	Description
7	PASI_BCLK_FS_RATIO_ERR	R	0b	Flag indicating PASI bclk fsync ratio error. 0d = No PASI bclk fsync ratio error 1d = PASI bclk fsync ratio error in selected clock configuration
6	SASI_BCLK_FS_RATIO_ERR	R	0b	Flag indicating SASI bclk fsync ratio error. 0d = No SASI bclk fsync ratio error 1d = SASI bclk fsync ratio error in selected clock configuration
5	CCLK_FS_RATIO_ERR	R	0b	Flag indicating CCLK fsync ratio error. 0d = No CCLK fsync ratio error 1d = CCLK fsync ratio error
4	PASI_FS_ERR	R	0b	Flag indicating PASI FS rate change or halt error. 0d = No PASI FS error 1d = PASI FS rate change or halt detected
3	SASI_FS_ERR	R	0b	Flag indicating SASI FS rate change or halt error. 0d = No SASI FS error 1d = SASI FS rate change or halt detected
2-0	RESERVED	R	0b	Reserved bits; Write only reset values

8.1.1.57 CLK_DET_STS0 Register (Address = 0x3E) [Reset = 0x00]

CLK_DET_STS0 is shown in [Table 8-59](#).

Return to the [Summary Table](#).

This register is the clock ratio detection register 0.

Table 8-59. CLK_DET_STS0 Register Field Descriptions

Bit	Field	Type	Reset	Description
7-2	PASI_SAMP_RATE_STS[5:0]	R	000000b	Primary ASI Sample rate detected status. 0d = Reserved 1d = 768000 (670320-791040) 2d = 614400 (536256-632832) 3d = 512000 (446880-527360) 4d = 438857 (383040-452022) 5d = 384000 (335160-395520) 6d = 341333 (297920-351573) 7d = 307200 (268128-316416) 8d = 256000 (223440-263680) 9d = 219429 (191520-226011) 10d = 192000 (167580-197760) 11d = 170667 (148960-175786) 12d = 153600 (134064-158208) 13d = 128000 (111720-131840) 14d = 109714 (95760-113005) 15d = 96000 (83790-98880) 16d = 85333 (74480-87893) 17d = 76800 (67032-79104) 18d = 64000 (55860-65920) 19d = 54857 (47880-56502) 20d = 48000 (41895-49440) 21d = 42667 (37240-43946) 22d = 38400 (33516-39552) 23d = 32000 (27930-32960) 24d = 27429 (23940-28251) 25d = 24000 (20947-24720) 26d = 21333 (18620-21973) 27d = 19200 (16758-19776) 28d = 16000 (13965-16480) 29d = 13714 (11970-14125) 30d = 12000 (10473-12360) 31d = 10667 (9310-10986) 32d = 9600 (8379-9888) 33d = 8000 (6982-8240) 34d = 6857 (5985-7062) 35d = 6000 (5236-6180) 36d = 5333 (4655-5493) 37d = 4800 (4189-4944) 38d = 4000 (3491-4120) 39d = 3429 (2992-3531) 40d = 3000 (2618-3090) 41d-63d = Reserved
1-0	PLL_MODE_STS[1:0]	R	00b	PLL usage status. 0d = PLL used in integer mode 1d = PLL used in fractional mode 2d = PLL not used 3d = Reserved

8.1.1.58 CLK_DET_STS1 Register (Address = 0x3F) [Reset = 0x00]

CLK_DET_STS1 is shown in [Table 8-60](#).

Return to the [Summary Table](#).

This register is the clock ratio detection register 1.

Table 8-60. CLK_DET_STS1 Register Field Descriptions

Bit	Field	Type	Reset	Description
7-2	SASI_SAMP_RATE_STS[5:0]	R	000000b	Secondary ASI Sample rate detected status. 0d = Reserved 1d = 768000 (670320-791040) 2d = 614400 (536256-632832) 3d = 512000 (446880-527360) 4d = 438857 (383040-452022) 5d = 384000 (335160-395520) 6d = 341333 (297920-351573) 7d = 307200 (268128-316416) 8d = 256000 (223440-263680) 9d = 219429 (191520-226011) 10d = 192000 (167580-197760) 11d = 170667 (148960-175786) 12d = 153600 (134064-158208) 13d = 128000 (111720-131840) 14d = 109714 (95760-113005) 15d = 96000 (83790-98880) 16d = 85333 (74480-87893) 17d = 76800 (67032-79104) 18d = 64000 (55860-65920) 19d = 54857 (47880-56502) 20d = 48000 (41895-49440) 21d = 42667 (37240-43946) 22d = 38400 (33516-39552) 23d = 32000 (27930-32960) 24d = 27429 (23940-28251) 25d = 24000 (20947-24720) 26d = 21333 (18620-21973) 27d = 19200 (16758-19776) 28d = 16000 (13965-16480) 29d = 13714 (11970-14125) 30d = 12000 (10473-12360) 31d = 10667 (9310-10986) 32d = 9600 (8379-9888) 33d = 8000 (6982-8240) 34d = 6857 (5985-7062) 35d = 6000 (5236-6180) 36d = 5333 (4655-5493) 37d = 4800 (4189-4944) 38d = 4000 (3491-4120) 39d = 3429 (2992-3531) 40d = 3000 (2618-3090) 41d-63d = Reserved
1-0	RESERVED	R	0b	Reserved bits; Write only reset values

8.1.1.59 CLK_DET_STS2 Register (Address = 0x40) [Reset = 0x00]

CLK_DET_STS2 is shown in [Table 8-61](#).

Return to the [Summary Table](#).

This register is the clock ratio detection register 2.

Table 8-61. CLK_DET_STS2 Register Field Descriptions

Bit	Field	Type	Reset	Description
7-6	RESERVED	R	0b	Reserved bits; Write only reset values
5-0	FS_CLKSRC_RATIO_DETECT_MSB_STS[5:0]	R	000000b	MSB bits for primary ASI or secondary ASI FSYNC to clock source ratio detected.

8.1.1.60 CLK_DET_STS3 Register (Address = 0x41) [Reset = 0x00]

CLK_DET_STS3 is shown in [Table 8-62](#).

Return to the [Summary Table](#).

This register is the clock ratio detection register 3.

Table 8-62. CLK_DET_STS3 Register Field Descriptions

Bit	Field	Type	Reset	Description
7-0	FS_CLKSRC_RATIO_DE T_LSB_STS[7:0]	R	00000000b	LSB byte for primary ASI or secondary ASI FSYNC to clock source ratio detected.

8.1.1.61 INT_CFG Register (Address = 0x42) [Reset = 0x00]

INT_CFG is shown in [Table 8-63](#).

Return to the [Summary Table](#).

This register is the interrupt configuration register.

Table 8-63. INT_CFG Register Field Descriptions

Bit	Field	Type	Reset	Description
7	INT_POL	R/W	0b	Interrupt polarity. 0b = Active low (IRQZ) 1b = Active high (IRQ)
6-5	INT_EVENT[1:0]	R/W	00b	Interrupt event configuration. 0d = INT asserts on any unmasked latched interrupts event 1d = INT asserts on any unmasked live interrupts event 2d = INT asserts for 2 ms (typical) for every 4-ms (typical) duration on any unmasked latched interrupts event 3d = INT asserts for 2 ms (typical) one time on each pulse for any unmasked interrupts event
4-3	PD_ON_FLT_CFG[1:0]	R/W	00b	Power down configuration during fault for chx and micbias. 0d = Faults are not considered for power down 1d = Only unmasked faults are considered for power down 2d = All faults are considered for power down 3d = Reserved
2	LTCH_READ_CFG	R/W	0b	Interrupt latch registers readback configuration. 0b = All interrupts can be read through the LTCH registers 1b = Only unmasked interrupts can be read through the LTCH registers
1	PD_ON_FLT_RCV_CFG	R/W	0b	Configuration for Power down ADC channels on fault 0b = Auto recovery, ADC channels are re-powered up when fault goes away 1b = Manual recovery, ADC channels are not re-powered up when fault goes away
0	LTCH_CLR_ON_READ	R/W	0b	Cfgn for clearing LTCH register bits 0 = LTCH reg bits are cleared on reg read only if live status is zero 1 = LTCH reg bits are cleared on reg read irrespective of live status

8.1.1.62 DAC_FLT_CFG Register (Address = 0x43) [Reset = 0x54]

DAC_FLT_CFG is shown in [Table 8-64](#).

Return to the [Summary Table](#).

This register is the interrupt configuration register.

Table 8-64. DAC_FLT_CFG Register Field Descriptions

Bit	Field	Type	Reset	Description
7	RESERVED	R	0b	Reserved bit; Write only reset value
6-5	DAC_PD_ON_FLT_CFG[1:0]	R/W	10b	Power down configuration during fault for DAC . 0d = Faults are not considered for power down 1d = Only unmasked faults are considered for power down 2d = All faults are considered for power down 3d = Reserved
4	DAC_PD_ON_FLT_RCV_CFG	R/W	1b	Configuration for Power down DAC channels on fault 0b = Auto recovery, DAC channels are re-powered up when fault goes away 1b = Manual recovery, DAC channels are not re-powered up when fault goes away
3	OUT_CHx_PD_FLT_STS	R	0b	Status for PD on OUTxx faults 0d = No DAC Channel is Powered Down due to fault/s 1d = Some DAC Channel is Powered Down due to fault/s
2	DAC_DIS_PD_W_PU	R/W	1b	Disable power down on DRVR VG fault while powering up DAC 0b = Power down DAC on DRVR VG fault while power up 1b = Disable power down DAC on DRVR VG fault while power up
1	DAC_FLT_DET_DIS	R/W	0b	DAC vg_fault/sc_fault detect config 0b = enable 1b = disable
0	AREG_SC_FLAG_DET_DIS	R/W	0b	AREG short circuit detect config 0b = enable 1b = disable

8.1.1.63 ADC_DAC_MISC_CFG Register (Address = 0x4B) [Reset = 0x00]

ADC_DAC_MISC_CFG is shown in [Table 8-65](#).

Return to the [Summary Table](#).

This register is the ADC overload response configuration register. It gives option to mute the ADC channel in overload recovery phase to avoid audible artifacts. Overload recovery phase is protection mechanism for inputs like step input where there is abrupt change in level.

Table 8-65. ADC_DAC_MISC_CFG Register Field Descriptions

Bit	Field	Type	Reset	Description
7	RESERVED	R	0b	Reserved bit; Write only reset value
6	RESERVED	R	0b	Reserved bit; Write only reset value
5	RESERVED	R	0b	Reserved bit; Write only reset value
4	ADC_CH1_MUTE_ON_OVRLD	R/W	0b	Mute ADC channel 1 while ADC1 is in Overload Recovery Phase 0b = Disable 1b = Enable
3	ADC_CH2_MUTE_ON_OVRLD	R/W	0b	Mute ADC channel 2 while ADC2 is in Overload Recovery Phase 0b = Disable 1b = Enable
2-0	RESERVED	R	0b	Reserved bits; Write only reset values

8.1.1.64 IADC_CFG Register (Address = 0x4C) [Reset = 0x5C]

IADC_CFG is shown in [Table 8-66](#).

Return to the [Summary Table](#).

This register is the IADC configuration register.

Table 8-66. IADC_CFG Register Field Descriptions

Bit	Field	Type	Reset	Description
7-6	IADC_NSkip_SEL[1:0]	R/W	01b	IADC NSkip configuration. 0d = 384 mod clks 1d = 576 mod clks 2d = 896 mod clks 3d = 1024 mod clks 4d = 2048 mod clks 5d = 4096 mod clks 6d-7d = Reserved
5-4	IADC_NRESET_SEL[1:0]	R/W	01b	IADC NRESET configuration. 0d = 50 mod clks 1d = 75 mod clks 2d = 100 mod clks 3d = 150 mod clks
3-2	IADC_OSR_SEL[1:0]	R/W	11b	IADC OSR select configuration. 0d = 32 1d = 64 2d = 96 3d = 128
1-0	RESERVED	R	0b	Reserved bits; Write only reset values

8.1.1.65 VREF_MICBIAS_CFG Register (Address = 0x4D) [Reset = 0x00]

VREF_MICBIAS_CFG is shown in [Table 8-67](#).

Return to the [Summary Table](#).

This register is the configuration register for VREF and MICBIAS.

Table 8-67. VREF_MICBIAS_CFG Register Field Descriptions

Bit	Field	Type	Reset	Description
7-5	RESERVED	R	0b	Reserved bits; Write only reset values
4	MICBIAS_LDO_GAIN	R/W	0b	MICBIAS Output Gain Setting 0d = LDO gain = 1 1d = LDO gain = 1.096
3-2	MICBIAS_VAL[1:0]	R/W	00b	MICBIAS Output Setting 0d = Microphone Bias is set to VREF 1d = Microphone Bias is set to VREF/2 (Valid only for VREF_FSCALE 0 or 1 setting) 2d = Reserved 3d = Microphone Bias output is bypassed to AVDD
1-0	VREF_FSCALE[1:0]	R/W	00b	VREF/Full-Scale Setting (Need to configure this based on AVDD min voltage used) 0d = VREF set to 2.75 V to support 2 V _{RMS} for Differential Input or 1 V _{RMS} for Single-Ended Input 1d = VREF set to 2.5 V to support 1.818 V _{RMS} for Differential Input or 0.909 V _{RMS} for Single-Ended Input 2d = VREF set to 1.375 V to support 1 V _{RMS} for Differential Input or 0.5 V _{RMS} for Single-Ended Input 3d = Reserved

8.1.1.66 PWR_TUNE_CFG0 Register (Address = 0x4E) [Reset = 0x00]

PWR_TUNE_CFG0 is shown in [Table 8-68](#).

Return to the [Summary Table](#).

This register is configuration register 0 for power tune configuration.

Table 8-68. PWR_TUNE_CFG0 Register Field Descriptions

Bit	Field	Type	Reset	Description
7	ADC_CLK_BY2_MODE	R/W	0b	ADC MOD CLK select configuration. 0d = MOD CLK 3.072MHz or 2.8224MHz 1d = MOD CLK 1.536MHz or 1.4112MHz
6	ADC_CIC_ORDER	R/W	0b	ADC CIC order configuration. 0d = 5th order CIC 1d = 4th order CIC
5	ADC_FIR_BYPASS	R/W	0b	ADC FIR bypass configuration. 0d = Bypass disable 1d = Bypass enable
4	ADC_DEM_RATE_OVRD	R/W	0b	ADC DEM rate override configuration. 0d = Default 1d = 2x
3	RESERVED	R	0b	Reserved bit; Write only reset value
2	ADC_LOW_PWR_FILTER	R/W	0b	Low Power filter configuration for ADC 0d = Disable 1d = Enable
1-0	RESERVED	R	0b	Reserved bits; Write only reset values

8.1.1.67 PWR_TUNE_CFG1 Register (Address = 0x4F) [Reset = 0x00]

PWR_TUNE_CFG1 is shown in [Table 8-69](#).

Return to the [Summary Table](#).

This register is configuration register for power tune configuration.

Table 8-69. PWR_TUNE_CFG1 Register Field Descriptions

Bit	Field	Type	Reset	Description
7	DAC_CLK_BY2_MODE	R/W	0b	DAC MOD CLK select configuration. 0d = MOD CLK 3MHz 1d = MOD CLK 1.5MHz
6	RESERVED	R	0b	Reserved bit; Write only reset value
5	RESERVED	R	0b	Reserved bit; Write only reset value
4	DAC_DEM_RATE_OVRD	R/W	0b	DAC DEM rate override configuration. 0d = Default 1d = 2x
3	RESERVED	R	0b	Reserved bit; Write only reset value
2	DAC_LOW_PWR_FILTER	R/W	0b	Low Power Filter configuration for DAC 0d = Disable 1d = Enable
1	DAC_POWER_SCAL	R/W	0b	DAC IREF select configuration. 0d = Vref/R 1d = Vref/2R
0	RESERVED	R	0b	Reserved bit; Write only reset value

8.1.1.68 ADC_CH1_CFG0 Register (Address = 0x50) [Reset = 0x00]

ADC_CH1_CFG0 is shown in [Table 8-70](#).

Return to the [Summary Table](#).

This register is configuration register 0 for ADC channel 1.

Table 8-70. ADC_CH1_CFG0 Register Field Descriptions

Bit	Field	Type	Reset	Description
7-6	ADC_CH1_INSRC[1:0]	R/W	00b	ADC Channel 1 input configuration. 0d = Analog differential input 1d = Analog single-ended input 2d = Analog single-ended mux INP1 input 3d = Analog single-ended mux INM1 input
5-4	ADC_CH1_IMP[1:0]	R/W	00b	ADC Channel 1 input impedance (applicable for the analog input). 0d = Typical 5kΩ input impedance (For 4 Vrms case it will be 10kΩ) 1d = Typical 10kΩ input impedance 2d = Typical 40kΩ input impedance 3d = Reserved
3-2	ADC_CH1_CM_TOL[1:0]	R/W	00b	ADC Channel 1 input coupling (applicable for the analog input). 0d = AC-coupled input with common mode variance tolerance supported 50 mVpp for single ended and 100 mVpp for differential configuration 1d = AC-coupled / DC-coupled input with common mode variance tolerance supported 500 mVpp for single ended and 1 Vpp for differential configuration 2d = AC-coupled / DC-coupled input with common mode variance tolerance supported rail to rail (supply to ground) (High CMRR tolerance mode) 3d = Reserved
1	ADC_CH1_FULLSCALE_VAL	R/W	0b	ADC Channel 1 Full-scale value for VREF=2.75 V (applicable for the analog input). 0d = 2 Vrms differential (1 Vrms for single ended operation) 1d = 4 Vrms differential (2 Vrms for single ended operation) (For AC-coupled configuration external biasing is required for input common mode, this mode supported with common mode variance tolerance rail to rail) (only 2.75 VREF supported, only supported in audio band-width mode)
0	ADC_CH1_BW_MODE	R/W	0b	ADC Channel 1 band-width selection. coupling (applicable for the analog input). 0d = audio band-width (24 kHz mode) 1d = wide band-width (96 kHz mode) (Supported only for 40kΩ input impedance case)

8.1.1.69 IADC_CH_CFG Register (Address = 0x51) [Reset = 0x00]

IADC_CH_CFG is shown in [Table 8-71](#).

Return to the [Summary Table](#).

This register is configuration register for ADC channels in IADC mode.

Table 8-71. IADC_CH_CFG Register Field Descriptions

Bit	Field	Type	Reset	Description
7	IADC_EN	R/W	0b	IADC enable configuration. 0d = IADC disabled 1d = IADC enabled
6-5	IADC_MODE[1:0]	R/W	00b	IADC mode configuration. (for single channel mode channel select is controlled by ADC_INSRC SE_MUX config) 0d = One-shot single channel 1d = One-shot multi channel 2d = Sequential single channel 3d = Sequential multi channel
4	IADC_CONVST_ONESHOT	R/W	0b	IADC conversion start one short configuration. 0d = No conversion 1d = Start one shot conversion
3	IADC_STOP_SEQ_CONV	R/W	0b	IADC stop sequential conversion configuration. 0d = Sequential conversion running 1d = Stop sequential conversion

Table 8-71. IADC_CH_CFG Register Field Descriptions (continued)

Bit	Field	Type	Reset	Description
2	IADC_ONESHOT_CONV_DONE_STS	R	0b	IADC one shot conversion done configuration. 0d = Conversion not done 1d = One shot conversion done
1-0	RESERVED	R	0b	Reserved bits; Write only reset value

8.1.1.70 ADC_CH1_CFG2 Register (Address = 0x52) [Reset = 0xA1]

ADC_CH1_CFG2 is shown in [Table 8-72](#).

Return to the [Summary Table](#).

This register is configuration register 2 for ADC channel 1.

Table 8-72. ADC_CH1_CFG2 Register Field Descriptions

Bit	Field	Type	Reset	Description
7-0	ADC_CH1_DVOL[7:0]	R/W	10100001b	Channel 1 digital volume control. 0d = Digital volume is muted 1d = Digital volume control is set to -80 dB 2d = Digital volume control is set to -79.5 dB 3d to 160d = Digital volume control is set as per configuration 161d = Digital volume control is set to 0 dB 162d = Digital volume control is set to 0.5 dB 163d to 253d = Digital volume control is set as per configuration 254d = Digital volume control is set to 46.5 dB 255d = Digital volume control is set to 47 dB

8.1.1.71 ADC_CH1_CFG3 Register (Address = 0x53) [Reset = 0x80]

ADC_CH1_CFG3 is shown in [Table 8-73](#).

Return to the [Summary Table](#).

This register is configuration register 3 for ADC channel 1.

Table 8-73. ADC_CH1_CFG3 Register Field Descriptions

Bit	Field	Type	Reset	Description
7-4	ADC_CH1_FGAIN[3:0]	R/W	1000b	ADC channel 1 fine gain calibration. 0d = Fine gain is set to -0.8 dB 1d = Fine gain is set to -0.7 dB 2d = Fine gain is set to -0.6 dB 3d to 7d = Fine gain is set as per configuration 8d = Fine gain is set to 0 dB 9d = Fine gain is set to 0.1 dB 10d to 13d = Fine gain is set as per configuration 14d = Fine gain is set to 0.6 dB 15d = Fine gain is set to 0.7 dB
3-0	RESERVED	R	0b	Reserved bits; Write only reset value

8.1.1.72 ADC_CH1_CFG4 Register (Address = 0x54) [Reset = 0x00]

ADC_CH1_CFG4 is shown in [Table 8-74](#).

Return to the [Summary Table](#).

This register is configuration register 4 for ADC channel 1.

Table 8-74. ADC_CH1_CFG4 Register Field Descriptions

Bit	Field	Type	Reset	Description
7-2	ADC_CH1_PCAL[5:0]	R/W	000000b	ADC channel 1 phase calibration with modulator clock resolution. 0d = No phase calibration 1d = Phase calibration delay is set to one cycle of the modulator clock 2d = Phase calibration delay is set to two cycles of the modulator clock 3d to 62d = Phase calibration delay as per configuration 63d = Phase calibration delay is set to 63 cycles of the modulator clock
1-0	PCAL_ANA_DIG_SEL[1:0]	R/W	00b	PCAL support configuration. 0d = Pcal for both Ana-Dig supported 1d = Pcal for only Ana 2d = Pcal for only Dig 3d = Reserved

8.1.1.73 ADC_CH2_CFG0 Register (Address = 0x55) [Reset = 0x00]

ADC_CH2_CFG0 is shown in [Table 8-75](#).

Return to the [Summary Table](#).

This register is configuration register 0 for ADC channel 2.

Table 8-75. ADC_CH2_CFG0 Register Field Descriptions

Bit	Field	Type	Reset	Description
7-6	ADC_CH2_INSRC[1:0]	R/W	00b	ADC Channel 2 input configuration. 0d = Analog differential input 1d = Analog single-ended input 2d = Analog single-ended mux INP2 input 3d = Analog single-ended mux INM2 input
5-4	ADC_CH2_IMP[1:0]	R/W	00b	ADC Channel 2 input impedance (applicable for the analog input). 0d = Typical 5kΩ input impedance (For 4 Vrms case it will be 10kΩ) 1d = Typical 10kΩ input impedance 2d = Typical 40kΩ input impedance 3d = Reserved
3-2	ADC_CH2_CM_TOL[1:0]	R/W	00b	ADC Channel 2 input coupling (applicable for the analog input). 0d = AC-coupled input with common mode variance tolerance supported 50 mVpp for single ended and 100 mVpp for differential configuration 1d = AC-coupled / DC-coupled input with common mode variance tolerance supported 500 mVpp for single ended and 1 Vpp for differential configuration 2d = AC-coupled / DC-coupled input with common mode variance tolerance supported rail to rail (supply to ground) (High CMRR tolerance mode) 3d = Reserved
1	ADC_CH2_FULLSCALE_VAL	R/W	0b	ADC Channel 2 Full-scale value for VREF=2.75 V (applicable for the analog input). 0d = 2 Vrms differential (1 Vrms for single ended operation) 1d = 4 Vrms differential (2 Vrms for single ended operation) (For AC-coupled configuration external biasing is required for input common mode, this mode supported with common mode variance tolerance rail to rail) (only 2.75 VREF supported, only supported in audio band-width mode)
0	ADC_CH2_BW_MODE	R/W	0b	ADC Channel 2 band-width selection. coupling (applicable for the analog input). 0d = audio band-width (24 kHz mode) 1d = wide band-width (96 kHz mode) (Supported only for 40kΩ input impedance case)

8.1.1.74 ADC_CH2_CFG2 Register (Address = 0x57) [Reset = 0xA1]

ADC_CH2_CFG2 is shown in [Table 8-76](#).

Return to the [Summary Table](#).

This register is configuration register 2 for channel 2.

Table 8-76. ADC_CH2_CFG2 Register Field Descriptions

Bit	Field	Type	Reset	Description
7-0	ADC_CH2_DVOL[7:0]	R/W	10100001b	Channel 1 digital volume control. 0d = Digital volume is muted 1d = Digital volume control is set to -80 dB 2d = Digital volume control is set to -79.5 dB 3d to 160d = Digital volume control is set as per configuration 161d = Digital volume control is set to 0 dB 162d = Digital volume control is set to 0.5 dB 163d to 253d = Digital volume control is set as per configuration 254d = Digital volume control is set to 46.5 dB 255d = Digital volume control is set to 47 dB

8.1.1.75 ADC_CH2_CFG3 Register (Address = 0x58) [Reset = 0x80]

ADC_CH2_CFG3 is shown in [Table 8-77](#).

Return to the [Summary Table](#).

This register is configuration register 3 for ADC Channel 2.

Table 8-77. ADC_CH2_CFG3 Register Field Descriptions

Bit	Field	Type	Reset	Description
7-4	ADC_CH2_FGAIN[3:0]	R/W	1000b	ADC Channel 2 fine gain calibration. 0d = Fine gain is set to -0.8 dB 1d = Fine gain is set to -0.7 dB 2d = Fine gain is set to -0.6 dB 3d to 7d = Fine gain is set as per configuration 8d = Fine gain is set to 0 dB 9d = Fine gain is set to 0.1 dB 10d to 13d = Fine gain is set as per configuration 14d = Fine gain is set to 0.6 dB 15d = Fine gain is set to 0.7 dB
3-0	RESERVED	R	0b	Reserved bits; Write only reset value

8.1.1.76 ADC_CH2_CFG4 Register (Address = 0x59) [Reset = 0x00]

ADC_CH2_CFG4 is shown in [Table 8-78](#).

Return to the [Summary Table](#).

This register is configuration register 4 for ADC Channel 2.

Table 8-78. ADC_CH2_CFG4 Register Field Descriptions

Bit	Field	Type	Reset	Description
7-2	ADC_CH2_PCAL[5:0]	R/W	000000b	ADC Channel 2 phase calibration with modulator clock resolution. 0d = No phase calibration 1d = Phase calibration delay is set to one cycle of the modulator clock 2d = Phase calibration delay is set to two cycles of the modulator clock 3d to 62d = Phase calibration delay as per configuration 63d = Phase calibration delay is set to 63 cycles of the modulator clock

Table 8-78. ADC_CH2_CFG4 Register Field Descriptions (continued)

Bit	Field	Type	Reset	Description
1-0	RESERVED	R	0b	Reserved bits; Write only reset value

8.1.1.77 ADC_CH3_CFG0 Register (Address = 0x5A) [Reset = 0x00]

ADC_CH3_CFG0 is shown in [Table 8-79](#).

Return to the [Summary Table](#).

This register is configuration register 0 for ADC channel 3.

Table 8-79. ADC_CH3_CFG0 Register Field Descriptions

Bit	Field	Type	Reset	Description
7	ADC_CH3_CLONE	R/W	0b	ADC Channel 3 input configuration. 0d = clone disabled 1d = Channel 3 Digital Filter Input is generated same as Channel 1 Digital Filter Input (Cloned Input)
6-0	RESERVED	R	0b	Reserved bits; Write only reset value

8.1.1.78 ADC_CH3_CFG2 Register (Address = 0x5B) [Reset = 0xA1]

ADC_CH3_CFG2 is shown in [Table 8-80](#).

Return to the [Summary Table](#).

This register is configuration register 2 for ADC channel 3.

Table 8-80. ADC_CH3_CFG2 Register Field Descriptions

Bit	Field	Type	Reset	Description
7-0	ADC_CH3_DVOL[7:0]	R/W	10100001b	Channel 3 digital volume control. 0d = Digital volume is muted 1d = Digital volume control is set to -80 dB 2d = Digital volume control is set to -79.5 dB 3d to 160d = Digital volume control is set as per configuration 161d = Digital volume control is set to 0 dB 162d = Digital volume control is set to 0.5 dB 163d to 253d = Digital volume control is set as per configuration 254d = Digital volume control is set to 46.5 dB 255d = Digital volume control is set to 47 dB

8.1.1.79 ADC_CH3_CFG3 Register (Address = 0x5C) [Reset = 0x80]

ADC_CH3_CFG3 is shown in [Table 8-81](#).

Return to the [Summary Table](#).

This register is configuration register 3 for ADC channel 3.

Table 8-81. ADC_CH3_CFG3 Register Field Descriptions

Bit	Field	Type	Reset	Description
7-4	ADC_CH3_FGAIN[3:0]	R/W	1000b	ADC channel 3 fine gain calibration. 0d = Fine gain is set to -0.8 dB 1d = Fine gain is set to -0.7 dB 2d = Fine gain is set to -0.6 dB 3d to 7d = Fine gain is set as per configuration 8d = Fine gain is set to 0 dB 9d = Fine gain is set to 0.1 dB 10d to 13d = Fine gain is set as per configuration 14d = Fine gain is set to 0.6 dB 15d = Fine gain is set to 0.7 dB
3-0	RESERVED	R	0b	Reserved bits; Write only reset value

8.1.1.80 ADC_CH3_CFG4 Register (Address = 0x5D) [Reset = 0x00]

ADC_CH3_CFG4 is shown in [Table 8-82](#).

Return to the [Summary Table](#).

This register is configuration register 4 for ADC channel 3.

Table 8-82. ADC_CH3_CFG4 Register Field Descriptions

Bit	Field	Type	Reset	Description
7-2	ADC_CH3_PCAL[5:0]	R/W	000000b	ADC channel 3 phase calibration with modulator clock resolution. 0d = No phase calibration 1d = Phase calibration delay is set to one cycle of the modulator clock 2d = Phase calibration delay is set to two cycles of the modulator clock 3d to 62d = Phase calibration delay as per configuration 63d = Phase calibration delay is set to 63 cycles of the modulator clock
1-0	RESERVED	R	0b	Reserved bits; Write only reset value

8.1.1.81 ADC_CH4_CFG0 Register (Address = 0x5E) [Reset = 0x00]

ADC_CH4_CFG0 is shown in [Table 8-83](#).

Return to the [Summary Table](#).

This register is configuration register 0 for ADC Channel 4.

Table 8-83. ADC_CH4_CFG0 Register Field Descriptions

Bit	Field	Type	Reset	Description
7	ADC_CH4_CLONE	R/W	0b	ADC Channel 4 input configuration. 0d = clone disabled 1d = Channel 4 Digital Filter Input is generated same as Channel 2 Digital Filter Input (Cloned Input)
6-0	RESERVED	R	0b	Reserved bits; Write only reset value

8.1.1.82 ADC_CH4_CFG2 Register (Address = 0x5F) [Reset = 0xA1]

ADC_CH4_CFG2 is shown in [Table 8-84](#).

Return to the [Summary Table](#).

This register is configuration register 2 for channel 4.

Table 8-84. ADC_CH4_CFG2 Register Field Descriptions

Bit	Field	Type	Reset	Description
7-0	ADC_CH4_DVOL[7:0]	R/W	10100001b	Channel 4 digital volume control. 0d = Digital volume is muted 1d = Digital volume control is set to -80 dB 2d = Digital volume control is set to -79.5 dB 3d to 160d = Digital volume control is set as per configuration 161d = Digital volume control is set to 0 dB 162d = Digital volume control is set to 0.5 dB 163d to 253d = Digital volume control is set as per configuration 254d = Digital volume control is set to 46.5 dB 255d = Digital volume control is set to 47 dB

8.1.1.83 ADC_CH4_CFG3 Register (Address = 0x60) [Reset = 0x80]

ADC_CH4_CFG3 is shown in [Table 8-85](#).

Return to the [Summary Table](#).

This register is configuration register 3 for ADC Channel 4.

Table 8-85. ADC_CH4_CFG3 Register Field Descriptions

Bit	Field	Type	Reset	Description
7-4	ADC_CH4_FGAIN[3:0]	R/W	1000b	ADC Channel 4 fine gain calibration. 0d = Fine gain is set to -0.8 dB 1d = Fine gain is set to -0.7 dB 2d = Fine gain is set to -0.6 dB 3d to 7d = Fine gain is set as per configuration 8d = Fine gain is set to 0 dB 9d = Fine gain is set to 0.1 dB 10d to 13d = Fine gain is set as per configuration 14d = Fine gain is set to 0.6 dB 15d = Fine gain is set to 0.7 dB
3-0	RESERVED	R	0b	Reserved bits; Write only reset value

8.1.1.84 ADC_CH4_CFG4 Register (Address = 0x61) [Reset = 0x00]

ADC_CH4_CFG4 is shown in [Table 8-86](#).

Return to the [Summary Table](#).

This register is configuration register 4 for ADC Channel 4.

Table 8-86. ADC_CH4_CFG4 Register Field Descriptions

Bit	Field	Type	Reset	Description
7-2	ADC_CH4_PCAL[5:0]	R/W	000000b	ADC Channel 4 phase calibration with modulator clock resolution. 0d = No phase calibration 1d = Phase calibration delay is set to one cycle of the modulator clock 2d = Phase calibration delay is set to two cycles of the modulator clock 3d to 62d = Phase calibration delay as per configuration 63d = Phase calibration delay is set to 63 cycles of the modulator clock
1-0	RESERVED	R	0b	Reserved bits; Write only reset value

8.1.1.85 ADC_CFG1 Register (Address = 0x62) [Reset = 0x00]

ADC_CFG1 is shown in [Table 8-87](#).

Return to the [Summary Table](#).

This register is configuration register 1 for the ADC.

Table 8-87. ADC_CFG1 Register Field Descriptions

Bit	Field	Type	Reset	Description
7-6	RESERVED	R	0b	Reserved bits; Write only reset value
5-4	ADC_PINCM_TRIM[1:0]	R/W	00b	Bit to tweak the Input common mode voltage of the ADC channel in AC coupled mode. Connects the following resistor from input pin to AVDD to have slight adjustments (increments) to the common mode voltage 01 = 500k 10 = 250k 11 = Reserved
3	RESERVED	R	0b	Reserved bit; Write only reset value
2	ADC_DATA_INVERT	R/W	0b	Bit to Invert ADC Data
1-0	RESERVED	R	0b	Reserved bits; Write only reset value

8.1.1.86 OUT1x_CFG0 Register (Address = 0x64) [Reset = 0x20]

OUT1x_CFG0 is shown in [Table 8-88](#).

Return to the [Summary Table](#).

This register is configuration register 0 for Channel OUT1x.

Table 8-88. OUT1x_CFG0 Register Field Descriptions

Bit	Field	Type	Reset	Description
7-5	OUT1x_SRC[2:0]	R/W	001b	OUT1x Source Configuration. 0d = Reserved; Don't use 1d = Input from DAC signal chain 2d = Input from Analog bypass path 3d = Input from both DAC signal chain and Analog bypass path 4d = Independent input from both DAC signal chain and Analog bypass path (DAC -> OUT1P, IN1P -> OUT1M) 5d = Independent input from both DAC signal chain and Analog bypass path (IN1M -> OUT1P, DAC -> OUT1M) 6d-7d = Reserved; Don't use
4-2	OUT1x_CFG[2:0]	R/W	000b	OUT1x DAC / Analog Bypass Routing Configuration. (Don't use if OUT1x_SRC configured 4d or 5d) 0d = Differential (DAC1AP + DAC1BP / IN1M -> OUT1P ; DAC1AM + DAC1BM / IN1P -> OUT1M) 1d = Stereo single-ended (DAC1A / IN1M -> OUT1P ; DAC1B / IN1P -> OUT1M) 2d = Mono single-ended with output at OUT1P only (DAC1A + DAC1B / IN1M -> OUT1P) 3d = Mono single-ended with output at OUT1M only (DAC1A + DAC1B / IN1P -> OUT1M) 4d = Pseudo differential with OUT1M as VCOM (DAC1A, DAC1B / IN1M -> OUT1P, VCOM -> OUT1M) 5d = Pseudo differential with OUT1M as VCOM and OUT2M for external sensing (DAC1A, DAC1B / IN1M -> OUT1P, VCOM -> OUT1M) 6d = Pseudo differential with OUT1P as VCOM (IN1P -> OUT1M, VCOM -> OUT1P) 7d = Reserved; Don't use
1	OUT1x_VCOM	R/W	0b	Channel OUT1x VCOM configuration. 0d = 0.6 * Vref (for 1.375V VREF mode alone as 0.654*Vref) 1d = AVDD by 2
0	RESERVED	R	0b	Reserved bit; Write only reset value

8.1.1.87 OUT1x_CFG1 Register (Address = 0x65) [Reset = 0x20]

OUT1x_CFG1 is shown in [Table 8-89](#).

Return to the [Summary Table](#).

This register is configuration register 1 for Channel OUT1x.

Table 8-89. OUT1x_CFG1 Register Field Descriptions

Bit	Field	Type	Reset	Description
7-6	OUT1P_DRIVE[1:0]	R/W	00b	Channel OUT1P drive configuration. 0d = Line out driver with minimum 300Ω single ended impedance 1d = Headphone driver with minimum 16Ω single ended impedance 2d = To drive minimum of 4Ω single ended impedance 3d = For higher DR/SNR for FD receiver loads
5-3	OUT1P_LVL_CTRL[2:0]	R/W	100b	Channel OUT1P level control configuration. 0d = Reserved; Don't use 1d = Reserved; Don't use 2d = 12 dB (only valid in bypass only mode configured in OUT1x_SRC{B0_P0_R100}) 3d = 6 dB (only valid if ana bypass mode or ana-dig mix mode configured in OUT1x_SRC{B0_P0_R100}) 4d = 0 dB 5d = -6 dB (only valid if ana bypass mode or ana-dig mix mode configured in OUT1x_SRC{B0_P0_R100}) 6d = -12 dB (only valid if ana bypass mode or ana-dig mix mode configured in OUT1x_SRC{B0_P0_R100} and AIN1M_BY_P_IMP configured 4.4kΩ) 7d = Reserved; Don't use
2	AIN1M_BY_P_IMP	R/W	0b	AIN1M Analog Bypass input impedance. 0d = 4.4kΩ 1d = 20kΩ
1	AIN1x_BY_P_CFG	R/W	0b	IN1x Analog Bypass input config. 0d = FD / Pseudo Diff 1d = SE
0	DAC_CH1_BW_MODE	R/W	0b	DAC Channel 1 band-width selection. 0d = audio band-width (24 kHz mode) 1d = wide band-width (96 kHz mode)

8.1.1.88 OUT1x_CFG2 Register (Address = 0x66) [Reset = 0x20]

OUT1x_CFG2 is shown in [Table 8-90](#).

Return to the [Summary Table](#).

This register is configuration register 2 for Channel OUT2x.

Table 8-90. OUT1x_CFG2 Register Field Descriptions

Bit	Field	Type	Reset	Description
7-6	OUT1M_DRIVE[1:0]	R/W	00b	Channel OUT1M drive configuration. 0d = Line out driver with minimum 300Ω single ended impedance 1d = Headphone driver with minimum 16Ω single ended impedance 2d = To drive minimum of 4Ω single ended impedance 3d = For higher DR/SNR for FD receiver loads

Table 8-90. OUT1x_CFG2 Register Field Descriptions (continued)

Bit	Field	Type	Reset	Description
5-3	OUT1M_LVL_CTRL[2:0]	R/W	100b	Channel OUT1M level control configuration. 0d = Reserved; Don't use 1d = Reserved; Don't use 2d = 12 dB (only valid in bypass only mode configured in OUT1x_SRC{B0_P0_R100}) 3d = 6 dB (only valid if ana bypass mode or ana-dig mix mode configured in OUT1x_SRC{B0_P0_R100}) 4d = 0 dB 5d = -6 dB (only valid if ana bypass mode or ana-dig mix mode configured in OUT1x_SRC{B0_P0_R100}) 6d = -12 dB (only valid if ana bypass mode or ana-dig mix mode configured in OUT1x_SRC{B0_P0_R100} and AIN1M_BYP_IMP configured 4.4kΩ) 7d = Reserved; Don't use
2	AIN1P_BYP_IMP	R/W	0b	AIN1P Analog Bypass input impedance. 0d = 4.4kΩ 1d = 20kΩ
1	RESERVED	R	0b	Reserved bit; Write only reset value
0	DAC_CH1_CM_TOL	R/W	0b	DAC Channel 1 input coupling (applicable for the analog input). 0d = AC-coupled input 1d = AC-coupled / DC-coupled input

8.1.1.89 DAC_CH1A_CFG0 Register (Address = 0x67) [Reset = 0xC9]

DAC_CH1A_CFG0 is shown in [Table 8-91](#).

Return to the [Summary Table](#).

This register is configuration register 0 for DAC channel 1A.

Table 8-91. DAC_CH1A_CFG0 Register Field Descriptions

Bit	Field	Type	Reset	Description
7-0	DAC_CH1A_DVOL[7:0]	R/W	11001001b	Channel 1A digital volume control. 0d = Digital Volume is muted 1d = Digital Volume Control set to -100 dB 2d = Digital Volume Control set to -99.5 dB 3d to 200d = Digital Volume Control set to as per configuration 201d = Digital Volume Control set to 0 dB 202d = Digital Volume Control set to +0.5 dB 203d to 253d = Digital Volume Control set to as per configuration 254d = Digital Volume Control set to +26.5 dB 255d = Digital Volume Control set to +27 dB

8.1.1.90 DAC_CH1A_CFG1 Register (Address = 0x68) [Reset = 0x80]

DAC_CH1A_CFG1 is shown in [Table 8-92](#).

Return to the [Summary Table](#).

This register is configuration register 1 for DAC channel 1A.

Table 8-92. DAC_CH1A_CFG1 Register Field Descriptions

Bit	Field	Type	Reset	Description
7-4	DAC_CH1A_FGAIN[3:0]	R/W	1000b	DAC channel 1A fine gain calibration. 0d = Fine gain is set to -0.8 dB 1d = Fine gain is set to -0.7 dB 2d = Fine gain is set to -0.6 dB 3d to 7d = Fine gain is set as per configuration 8d = Fine gain is set to 0 dB 9d = Fine gain is set to 0.1 dB 10d to 13d = Fine gain is set as per configuration 14d = Fine gain is set to 0.6 dB 15d = Fine gain is set to 0.7 dB
3-0	RESERVED	R	0b	Reserved bits; Write only reset value

8.1.1.91 DAC_CH1B_CFG0 Register (Address = 0x69) [Reset = 0xC9]

DAC_CH1B_CFG0 is shown in [Table 8-93](#).

Return to the [Summary Table](#).

This register is configuration register 0 for DAC channel 1B.

Table 8-93. DAC_CH1B_CFG0 Register Field Descriptions

Bit	Field	Type	Reset	Description
7-0	DAC_CH1B_DVOL[7:0]	R/W	11001001b	Channel 1B digital volume control. 0d = Digital Volume is muted 1d = Digital Volume Control set to -100 dB 2d = Digital Volume Control set to -99.5 dB 3d to 200d = Digital Volume Control set to as per configuration 201d = Digital Volume Control set to 0 dB 202d = Digital Volume Control set to +0.5 dB 203d to 253d = Digital Volume Control set to as per configuration 254d = Digital Volume Control set to +26.5 dB 255d = Digital Volume Control set to +27 dB

8.1.1.92 DAC_CH1B_CFG1 Register (Address = 0x6A) [Reset = 0x80]

DAC_CH1B_CFG1 is shown in [Table 8-94](#).

Return to the [Summary Table](#).

This register is configuration register 1 for DAC channel 1B.

Table 8-94. DAC_CH1B_CFG1 Register Field Descriptions

Bit	Field	Type	Reset	Description
7-4	DAC_CH1B_FGAIN[3:0]	R/W	1000b	DAC channel 1B fine gain calibration. 0d = Fine gain is set to -0.8 dB 1d = Fine gain is set to -0.7 dB 2d = Fine gain is set to -0.6 dB 3d to 7d = Fine gain is set as per configuration 8d = Fine gain is set to 0 dB 9d = Fine gain is set to 0.1 dB 10d to 13d = Fine gain is set as per configuration 14d = Fine gain is set to 0.6 dB 15d = Fine gain is set to 0.7 dB
3-0	RESERVED	R	0b	Reserved bits; Write only reset value

8.1.1.93 OUT2x_CFG0 Register (Address = 0x6B) [Reset = 0x20]

OUT2x_CFG0 is shown in [Table 8-95](#).

Return to the [Summary Table](#).

This register is configuration register 0 for Channel OUT2x.

Table 8-95. OUT2x_CFG0 Register Field Descriptions

Bit	Field	Type	Reset	Description
7-5	OUT2x_SRC[2:0]	R/W	001b	OUT2x Source Configuration. 0d = Reserved; Don't use 1d = Input from DAC signal chain 2d = Input from Analog bypass path 3d = Input from both DAC signal chain and Analog bypass path 4d = Independent input from both DAC signal chain and Analog bypass path (DAC -> OUT2P , IN2P -> OUT2M) 5d = Independent input from both DAC signal chain and Analog bypass path (IN2M -> OUT2P, DAC -> OUT2M) 6d-7d = Reserved; Don't use
4-2	OUT2x_CFG[2:0]	R/W	000b	OUT2x DAC / Analog Bypass Routing Configuration. (Don't use if OUT1x_SRC configured 4d or 5d) 0d = Differential (DAC2AP + DAC2BP / IN2M -> OUT2P ; DAC2AM + DAC2BM / IN2P -> OUT2M) 1d = Stereo single-ended (DAC2A / IN2M -> OUT2P ; DAC2B / IN2P -> OUT2M) 2d = Mono single-ended with output at OUT2P only (DAC2A + DAC2B / IN2M-> OUT2P) 3d = Mono single-ended with output at OUT2M only (DAC2A + DAC2B / IN2P -> OUT2M) 4d = Pseudo differential with OUT2M as VCOM (DAC2A, DAC2B / IN2M -> OUT2P, VCOM -> OUT2M) 5d =Reserved; Don't use 6d = Pseudo differential with OUT2P as VCOM (IN2P -> OUT2M, VCOM -> OUT2P) 7d = Reserved; Don't use
1	OUT2x_VCOM	R/W	0b	Channel OUT2x VCOM configuration. 0d = $0.6 * V_{ref}$ (for 1.375V VREF mode alone as $0.654 * V_{ref}$) 2d = AVDD by 2
0	RESERVED	R	0b	Reserved bit; Write only reset value

8.1.1.94 OUT2x_CFG1 Register (Address = 0x6C) [Reset = 0x20]

OUT2x_CFG1 is shown in [Table 8-96](#).

Return to the [Summary Table](#).

This register is configuration register 1 for Channel OUT2x.

Table 8-96. OUT2x_CFG1 Register Field Descriptions

Bit	Field	Type	Reset	Description
7-6	OUT2P_DRIVE[1:0]	R/W	00b	Channel OUT2P drive configuration. 0d = Line out driver with minimum 300Ω single ended impedance 1d = Headphone driver with minimum 16Ω single ended impedance 2d = To drive minimum of 4Ω single ended impedance 3d = For higher DR/SNR for FD receiver loads

Table 8-96. OUT2x_CFG1 Register Field Descriptions (continued)

Bit	Field	Type	Reset	Description
5-3	OUT2P_LVL_CTRL[2:0]	R/W	100b	Channel OUT2P level control configuration. 0d = Reserved; Don't use 1d = Reserved; Don't use 2d = 12 dB (only valid in bypass only mode configured in OUT2x_SRC{B0_P0_R107}) 3d = 6 dB (only valid if ana bypass mode or ana-dig mix mode configured in OUT2x_SRC{B0_P0_R107}) 4d = 0 dB 5d = -6 dB (only valid if ana bypass mode or ana-dig mix mode configured in OUT2x_SRC{B0_P0_R107}) 6d = -12 dB (only valid if ana bypass mode or ana-dig mix mode configured in OUT2x_SRC{B0_P0_R107} and AIN1M_BYP_IMP configured 4.4kΩ) 7d = Reserved; Don't use
2	AIN2M_BYP_IMP	R/W	0b	AIN2M Analog Bypass input impedance. 0d = 4.4kΩ 1d = 20kΩ
1	AIN2x_BYP_CFG	R/W	0b	IN2x Analog Bypass input config. 0d = FD / Pseudo Diff 1d = SE
0	DAC_CH2_BW_MODE	R/W	0b	DAC Channel 2 band-width selection. 0d = audio band-width (24 kHz mode) 1d = wide band-width (96 kHz mode)

8.1.1.95 OUT2x_CFG2 Register (Address = 0x6D) [Reset = 0x20]

OUT2x_CFG2 is shown in [Table 8-97](#).

Return to the [Summary Table](#).

This register is configuration register 2 for Channel OUT2x.

Table 8-97. OUT2x_CFG2 Register Field Descriptions

Bit	Field	Type	Reset	Description
7-6	OUT2M_DRIVE[1:0]	R/W	00b	Channel OUT2M drive configuration. 0d = Line out driver with minimum 300Ω single ended impedance 1d = Headphone driver with minimum 16Ω single ended impedance 2d = To drive minimum of 4Ω single ended impedance 3d = For higher DR/SNR for FD receiver loads
5-3	OUT2M_LVL_CTRL[2:0]	R/W	100b	Channel OUT2M level control configuration. 0d = Reserved; Don't use 1d = Reserved; Don't use 2d = 12 dB (only valid in bypass only mode configured in OUT2x_SRC{B0_P0_R107}) 3d = 6 dB (only valid if ana bypass mode or ana-dig mix mode configured in OUT2x_SRC{B0_P0_R107}) 4d = 0 dB 5d = -6 dB (only valid if ana bypass mode or ana-dig mix mode configured in OUT2x_SRC{B0_P0_R107}) 6d = -12 dB (only valid if ana bypass mode or ana-dig mix mode configured in OUT2x_SRC{B0_P0_R107} and AIN1M_BYP_IMP configured 4.4kΩ) 7d = Reserved; Don't use
2	AIN2P_BYP_IMP	R/W	0b	AIN2P Analog Bypass input impedance. 0d = 4.4kΩ 1d = 20kΩ
1	RESERVED	R	0b	Reserved bit; Write only reset value

Table 8-97. OUT2x_CFG2 Register Field Descriptions (continued)

Bit	Field	Type	Reset	Description
0	DAC_CH2_CM_TOL	R/W	0b	DAC Channel 2 input coupling (applicable for the analog input). 0d = AC-coupled input 1d = AC-coupled / DC-coupled input

8.1.1.96 DAC_CH2A_CFG0 Register (Address = 0x6E) [Reset = 0xC9]

DAC_CH2A_CFG0 is shown in [Table 8-98](#).

Return to the [Summary Table](#).

This register is configuration register 0 for DAC channel 2A.

Table 8-98. DAC_CH2A_CFG0 Register Field Descriptions

Bit	Field	Type	Reset	Description
7-0	DAC_CH2A_DVOL[7:0]	R/W	11001001b	Channel 2A digital volume control. 0d = Digital Volume is muted 1d = Digital Volume Control set to -100 dB 2d = Digital Volume Control set to -99.5 dB 3d to 200d = Digital Volume Control set to as per configuration 201d = Digital Volume Control set to 0 dB 202d = Digital Volume Control set to +0.5 dB 203d to 253d = Digital Volume Control set to as per configuration 254d = Digital Volume Control set to +26.5 dB 255d = Digital Volume Control set to +27 dB

8.1.1.97 DAC_CH2A_CFG1 Register (Address = 0x6F) [Reset = 0x80]

DAC_CH2A_CFG1 is shown in [Table 8-99](#).

Return to the [Summary Table](#).

This register is configuration register 1 for DAC channel 2A.

Table 8-99. DAC_CH2A_CFG1 Register Field Descriptions

Bit	Field	Type	Reset	Description
7-4	DAC_CH2A_FGAIN[3:0]	R/W	1000b	DAC channel 2A fine gain calibration. 0d = Fine gain is set to -0.8 dB 1d = Fine gain is set to -0.7 dB 2d = Fine gain is set to -0.6 dB 3d to 7d = Fine gain is set as per configuration 8d = Fine gain is set to 0 dB 9d = Fine gain is set to 0.1 dB 10d to 13d = Fine gain is set as per configuration 14d = Fine gain is set to 0.6 dB 15d = Fine gain is set to 0.7 dB
3-0	RESERVED	R	0b	Reserved bits; Write only reset value

8.1.1.98 DAC_CH2B_CFG0 Register (Address = 0x70) [Reset = 0xC9]

DAC_CH2B_CFG0 is shown in [Table 8-100](#).

Return to the [Summary Table](#).

This register is configuration register 0 for DAC channel 2B.

Table 8-100. DAC_CH2B_CFG0 Register Field Descriptions

Bit	Field	Type	Reset	Description
7-0	DAC_CH2B_DVOL[7:0]	R/W	11001001b	Channel 2B digital volume control. 0d = Digital Volume is muted 1d = Digital Volume Control set to -100 dB 2d = Digital Volume Control set to -99.5 dB 3d to 200d = Digital Volume Control set to as per configuration 201d = Digital Volume Control set to 0 dB 202d = Digital Volume Control set to +0.5 dB 203d to 253d = Digital Volume Control set to as per configuration 254d = Digital Volume Control set to +26.5 dB 255d = Digital Volume Control set to +27 dB

8.1.1.99 DAC_CH2B_CFG1 Register (Address = 0x71) [Reset = 0x80]

DAC_CH2B_CFG1 is shown in [Table 8-101](#).

Return to the [Summary Table](#).

This register is configuration register 1 for DAC channel 2B.

Table 8-101. DAC_CH2B_CFG1 Register Field Descriptions

Bit	Field	Type	Reset	Description
7-4	DAC_CH2B_FGAIN[3:0]	R/W	1000b	DAC channel 2B fine gain calibration. 0d = Fine gain is set to -0.8 dB 1d = Fine gain is set to -0.7 dB 2d = Fine gain is set to -0.6 dB 3d to 7d = Fine gain is set as per configuration 8d = Fine gain is set to 0 dB 9d = Fine gain is set to 0.1 dB 10d to 13d = Fine gain is set as per configuration 14d = Fine gain is set to 0.6 dB 15d = Fine gain is set to 0.7 dB
3-0	RESERVED	R	0b	Reserved bits; Write only reset value

8.1.1.100 DSP_CFG0 Register (Address = 0x72) [Reset = 0x18]

DSP_CFG0 is shown in [Table 8-102](#).

Return to the [Summary Table](#).

This register is the digital signal processor (DSP) configuration register 0.

Table 8-102. DSP_CFG0 Register Field Descriptions

Bit	Field	Type	Reset	Description
7-6	ADC_DSP_DECI_FILT[1:0]	R/W	00b	ADC channel decimation filter response. 0d = Linear phase 1d = Low latency 2d = Ultra-low latency 3d = Reserved; Don't use
5-4	ADC_DSP_HPF_SEL[1:0]	R/W	01b	ADC channel high-pass filter (HPF) selection. 0d = Programmable first-order IIR filter for a custom HPF with default coefficient values in P10_R120-127 and P11_R8-11 set as the all-pass filter 1d = HPF with a cutoff of $0.00002 \times f_S$ (1 Hz at $f_S = 48$ kHz) is selected 2d = HPF with a cutoff of $0.00025 \times f_S$ (12 Hz at $f_S = 48$ kHz) is selected 3d = HPF with a cutoff of $0.002 \times f_S$ (96 Hz at $f_S = 48$ kHz) is selected

Table 8-102. DSP_CFG0 Register Field Descriptions (continued)

Bit	Field	Type	Reset	Description
3-2	ADC_DSP_BQ_CFG[1:0]	R/W	10b	Number of biquads per ADC channel configuration. 0d = No biquads per channel; biquads are all disabled 1d = 1 biquad per channel 2d = 2 biquads per channel 3d = 3 biquads per channel
1	ADC_DSP_DISABLE_SOFT_STEP	R/W	0b	ADC Soft-stepping disable during DVOL change, mute, and unmute. 0d = Soft-stepping enabled 1d = Soft-stepping disabled
0	ADC_DSP_DVOL_GANG	R/W	0b	DVOL control ganged across ADC channels. 0d = Each channel has its own DVOL CTRL settings as programmed in the ADC_CHx_DVOL bits 1d = All active channels must use the channel 1 DVOL setting (ADC_CH1_DVOL) irrespective of whether channel 1 is turned on or not

8.1.1.101 DSP_CFG1 Register (Address = 0x73) [Reset = 0x18]

DSP_CFG1 is shown in [Table 8-103](#).

Return to the [Summary Table](#).

This register is the digital signal processor (DSP) configuration register 0.

Table 8-103. DSP_CFG1 Register Field Descriptions

Bit	Field	Type	Reset	Description
7-6	DAC_DSP_INTX_FILTER[1:0]	R/W	00b	DAC channel decimation filter response. 0d = Linear phase 1d = Low latency 2d = Ultra-low latency 3d = Reserved; Don't use
5-4	DAC_DSP_HPF_SEL[1:0]	R/W	01b	DAC channel high-pass filter (HPF) selection. 0d = Programmable first-order IIR filter for a custom HPF with default coefficient values in P17_R120-127 and P18_R8-11 set as the all-pass filter 1d = HPF with a cutoff of $0.00002 \times f_s$ (1 Hz at $f_s = 48$ kHz) is selected 2d = HPF with a cutoff of $0.00025 \times f_s$ (12 Hz at $f_s = 48$ kHz) is selected 3d = HPF with a cutoff of $0.002 \times f_s$ (96 Hz at $f_s = 48$ kHz) is selected
3-2	DAC_DSP_BQ_CFG[1:0]	R/W	10b	Number of biquads per DAC channel configuration. 0d = No biquads per channel; biquads are all disabled 1d = 1 biquad per channel 2d = 2 biquads per channel 3d = 3 biquads per channel
1	DAC_DSP_DISABLE_SOFT_STEP	R/W	0b	DAC Soft-stepping disable during DVOL change, mute, and unmute. 0d = Soft-stepping enabled 1d = Soft-stepping disabled
0	DAC_DSP_DVOL_GANG	R/W	0b	DVOL control ganged across DAC channels. 0d = Each DAC channel has its own DVOL CTRL settings as programmed in the DAC_CHx_DVOL bits 1d = All active channels must use the channel 1 DVOL setting (DAC_CH1_DVOL) irrespective of whether channel 1 is turned on or not

8.1.1.102 CH_EN Register (Address = 0x76) [Reset = 0xCC]

CH_EN is shown in [Table 8-104](#).

Return to the [Summary Table](#).

This register is the channel enable configuration register.

Table 8-104. CH_EN Register Field Descriptions

Bit	Field	Type	Reset	Description
7	IN_CH1_EN	R/W	1b	Input channel 1 enable setting. 0d = Input channel 1 is disabled 1d = Input channel 1 is enabled
6	IN_CH2_EN	R/W	1b	Input channel 2 enable setting. 0d = Input channel 2 is disabled 1d = Input channel 2 is enabled
5	IN_CH3_EN	R/W	0b	Input channel 3 enable setting. 0d = Input channel 3 is disabled 1d = Input channel 3 is enabled
4	IN_CH4_EN	R/W	0b	Input channel 4 enable setting. 0d = Input channel 4 is disabled 1d = Input channel 4 is enabled
3	OUT_CH1_EN	R/W	1b	Output channel 1 enable setting. 0d = Output channel 1 is disabled 1d = Output channel 1 is enabled
2	OUT_CH2_EN	R/W	1b	Output channel 2 enable setting. 0d = Output channel 2 is disabled 1d = Output channel 2 is enabled
1	OUT_CH3_EN	R/W	0b	Output channel 3 enable setting. 0d = Output channel 3 is disabled 1d = Output channel 3 is enabled
0	OUT_CH4_EN	R/W	0b	Output channel 4 enable setting. 0d = Output channel 4 is disabled 1d = Output channel 4 is enabled

8.1.1.103 DYN_PUPD_CFG Register (Address = 0x77) [Reset = 0x00]

DYN_PUPD_CFG is shown in [Table 8-105](#).

Return to the [Summary Table](#).

This register is the power-up configuration register.

Table 8-105. DYN_PUPD_CFG Register Field Descriptions

Bit	Field	Type	Reset	Description
7	ADC_DYN_PUPD_EN	R/W	0b	Dynamic channel power-up, power-down enable for record path. 0d = Channel power-up, power-down is not supported if any channel recording is on 1d = Channel can be powered up or down individually, even if channel recording is on
6	ADC_DYN_MAXCH_SEL	R/W	0b	Dynamic mode maximum channel select configuration for record path. 0d = Channel 1 and channel 2 are used with dynamic channel power-up, power-down feature enabled 1d = Channel 1 to channel 4 are used with dynamic channel power-up, power-down feature enabled
5	DAC_DYN_PUPD_EN	R/W	0b	Dynamic channel power-up, power-down enable for playback path. 0d = Channel power-up, power-down is not supported if any channel playback is on 1d = Channel can be powered up or down individually, even if channel playback is on

Table 8-105. DYN_PUPD_CFG Register Field Descriptions (continued)

Bit	Field	Type	Reset	Description
4	DAC_DYN_MAXCH_SEL	R/W	0b	Dynamic mode maximum channel select configuration for playback path. 0d = Channel 1 and channel 2 are used with dynamic channel power-up, power-down feature enabled 1d = Channel 1 to channel 4 are used with dynamic channel power-up, power-down feature enabled
3	DYN_PUPD_ADC_PDM_DIFF_CLK	R/W	0b	Dynamic power-up power-down with different adc mod clock and pdm clock configuration. 0d = Same ADC MOD CLK and PDM CLK in dynamic pupd 1d = Different ADC MOD CLK and PDM CLK in dynamic pupd
2	RESERVED	R	0b	Reserved bit; Write only reset value
1	ADC_CH_SWAP	R/W	0b	ADC channel swap enable configuration. 1d = No swap 1d = ADC channel 1 and 2 are swapped
0	DAC_CH_SWAP	R/W	0b	DAC channel swap enable configuration. 1d = No swap 1d = DAC channel 1 and 2 are swapped

8.1.1.104 PWR_CFG Register (Address = 0x78) [Reset = 0x00]

PWR_CFG is shown in [Table 8-106](#).

Return to the [Summary Table](#).

This register is the power-up configuration register.

Table 8-106. PWR_CFG Register Field Descriptions

Bit	Field	Type	Reset	Description
7	ADC_PDZ	R/W	0b	Power control for ADC and PDM channels. 0d = Power down all ADC and PDM channels 1d = Power up all enabled ADC and PDM channels
6	DAC_PDZ	R/W	0b	Power control for DAC channels. 0d = Power down all DAC channels 1d = Power up all enabled DAC channels
5	MICBIAS_PDZ	R/W	0b	Power control for MICBIAS. 0d = Power down MICBIAS 1d = Power up MICBIAS
4	RESERVED	R	0b	Reserved bit; Write only reset value
3	UAD_EN	R/W	0b	Enable ultrasound activity detection (UAD) algorithm. 0d = UAD is disabled 1d = UAD is enabled
2	VAD_EN	R/W	0b	Enable voice activity detection (VAD) algorithm. 0d = VAD is disabled 1d = VAD is enabled
1	UAG_EN	R/W	0b	Enable ultrasound activity detection (UAG) algorithm. 0d = UAG is disabled 1d = UAG is enabled
0	RESERVED	R	0b	Reserved bit; Write only reset value

8.1.1.105 DEV_STS0 Register (Address = 0x79) [Reset = 0x00]

DEV_STS0 is shown in [Table 8-107](#).

Return to the [Summary Table](#).

This register is the device status value register 0.

Table 8-107. DEV_STS0 Register Field Descriptions

Bit	Field	Type	Reset	Description
7	IN_CH1_STATUS	R	0b	ADC or PDM channel 1 power status. 0d = ADC or PDM channel is powered down 1d = ADC or PDM channel is powered up
6	IN_CH2_STATUS	R	0b	ADC or PDM channel 2 power status. 0d = ADC or PDM channel is powered down 1d = ADC or PDM channel is powered up
5	IN_CH3_STATUS	R	0b	ADC or PDM channel 1 power status. 0d = ADC or PDM channel is powered down 1d = ADC or PDM channel is powered up
4	IN_CH4_STATUS	R	0b	ADC or PDM channel 2 power status. 0d = ADC or PDM channel is powered down 1d = ADC or PDM channel is powered up
3	OUT_CH1_STATUS	R	0b	DAC channel 1 power status. 0d = DAC channel is powered down 1d = DAC channel is powered up
2	OUT_CH2_STATUS	R	0b	DAC channel 2 power status. 0d = DAC channel is powered down 1d = DAC channel is powered up
1	OUT_CH3_STATUS	R	0b	DAC channel 3 power status. 0d = DAC channel is powered down 1d = DAC channel is powered up
0	OUT_CH4_STATUS	R	0b	DAC channel 4 power status. 0d = DAC channel is powered down 1d = DAC channel is powered up

8.1.1.106 DEV_STS1 Register (Address = 0x7A) [Reset = 0x80]

DEV_STS1 is shown in [Table 8-108](#).

Return to the [Summary Table](#).

This register is the device status value register 1.

Table 8-108. DEV_STS1 Register Field Descriptions

Bit	Field	Type	Reset	Description
7-5	MODE_STS[2:0]	R	100b	Device mode status. 0-3d = Reserved 4d = Device is in sleep mode or software shutdown mode 5d = Reserved 6d = Device is in active mode with all record and playback channels turned off 7d = Device is in active mode with at least one record or playback channel turned on
4	PLL_STS	R	0b	PLL status. 0d = PLL is not enabled 1d = PLL is enabled
3	MICBIAS_STS	R	0b	MICBIAS status. 0d = MICBIAS is disabled 1d = MICBIAS is enabled
2	BOOST_STS	R	0b	Boost status. 0d = Boost is disabled 1d = Boost is enabled
1	CHx_PD_FLT_STS	R	0b	Status for PD on INxx Analog inputs faults 0d = No ADC Channel is Powered Down due to fault/s on Analog inputs INxx 1d = Some ADC Channel is Powered Down due to fault/s on Analog inputs INxx

Table 8-108. DEV_STS1 Register Field Descriptions (continued)

Bit	Field	Type	Reset	Description
0	ALL_CHx_PD_FLT_STS	R	0b	Status for PD on Micbias faults 0d = No ADC Channel is Powered Down due to fault/s related to Micbias 1d = All ADC Channels are Powered Down due to fault/s related to Micbias

8.1.1.107 I2C_CKSUM Register (Address = 0x7E) [Reset = 0x00]

I2C_CKSUM is shown in [Table 8-109](#).

Return to the [Summary Table](#).

This register returns the I²C transactions checksum value.

Table 8-109. I2C_CKSUM Register Field Descriptions

Bit	Field	Type	Reset	Description
7-0	I2C_CKSUM[7:0]	R/W	00000000b	These bits return the I ² C transactions checksum value. Writing to this register resets the checksum to the written value. This register is updated on writes to other registers on all pages.

8.1.2 B0_P1 Registers

Table 8-110 lists the memory-mapped registers for the B0_P1 registers. All register offset addresses not listed in Table 8-110 should be considered as reserved locations and the register contents should not be modified.

Table 8-110. B0_P1 Registers

Address	Acronym	Register Name	Reset Value	Section
0x0	PAGE_CFG	Device page register	0x00	Section 8.1.2.1
0x3	DSP_CFG0	DSP configuration register 0	0x00	Section 8.1.2.2
0xD	CLK_CFG0	Clock configuration register 0	0x00	Section 8.1.2.3
0xE	CHANNEL_CFG1	ADC channel configuration register	0x00	Section 8.1.2.4
0xF	CHANNEL_CFG2	DAC channel configuration register	0x00	Section 8.1.2.5
0x17	SRC_CFG0	SRC configuration register 1	0x00	Section 8.1.2.6
0x18	SRC_CFG1	SRC configuration register 2	0x00	Section 8.1.2.7
0x19	JACK_DET_CFG0	Jack Detection configuration register 0	0x00	Section 8.1.2.8
0x1A	JACK_DET_CFG1	Jack Detection configuration register 1	0x00	Section 8.1.2.9
0x1B	JACK_DET_CFG2	Jack Detection configuration register 2	0x00	Section 8.1.2.10
0x1C	JACK_DET_CFG3	Jack Detection configuration register 3	0x00	Section 8.1.2.11
0x1E	LPAD_CFG1	Low power activity detection configuration register	0x20	Section 8.1.2.12
0x1F	LPSG_CFG1	Low power signal generation configuration register 1	0x80	Section 8.1.2.13
0x20	LPAD_LPSG_CFG1	Low power activity detection and Low power signal generation common configuration register 1	0x00	Section 8.1.2.14
0x23	LIMITER_CFG	Limiter configuration register	0x00	Section 8.1.2.15
0x24	AGC_DRC_CFG	AGC and DRC configuration register	0x00	Section 8.1.2.16
0x2B	PLIM_CFG0	PLIM configuration register 0	0x00	Section 8.1.2.17
0x2C	MIXER_CFG0	MIXER configuration register 0	0x00	Section 8.1.2.18
0x2D	MISC_CFG0	Miscellaneous configuration register 0	0x00	Section 8.1.2.19
0x2E	BRWNOUT	Brownout configuration register	0xBF	Section 8.1.2.20
0x2F	INT_MASK0	Interrupt mask register 0	0xFF	Section 8.1.2.21
0x32	INT_MASK4	Interrupt mask register 4	0x00	Section 8.1.2.22
0x33	INT_MASK5	Interrupt mask register 5	0x30	Section 8.1.2.23
0x34	INT_LTCH0	Latched interrupt readback register 0	0x00	Section 8.1.2.24
0x38	OUT_CH1_LTCH	Channel 1 output DC faults diagnostics latched status register	0x00	Section 8.1.2.25
0x39	OUT_CH2_LTCH	Channel 2 output DC faults diagnostics latched status register	0x00	Section 8.1.2.26
0x3A	INT_LTCH1	Latched interrupt readback register 1	0x00	Section 8.1.2.27
0x3B	INT_LTCH2	Latched interrupt readback register 2	0x00	Section 8.1.2.28
0x3C	INT_LIVE0	Live Interrupt readback register 0	0x00	Section 8.1.2.29
0x40	OUT_CH1_LIVE	Channel 1 output DC faults diagnostics live status register	0x00	Section 8.1.2.30
0x41	OUT_CH2_LIVE	Channel 2 output DC faults diagnostics live status register	0x00	Section 8.1.2.31
0x42	INT_LIVE1	Live interrupt readback register 1	0x00	Section 8.1.2.32
0x43	INT_LIVE2	Live interrupt readback register 2	0x00	Section 8.1.2.33
0x4E	DIAG_CFG8	Input diagnostics configuration register 8	0xBA	Section 8.1.2.34
0x4F	DIAG_CFG9	Input diagnostics configuration register 9	0x4B	Section 8.1.2.35
0x53	DIAG_CFG13	Input diagnostics configuration register 13	0x00	Section 8.1.2.36
0x54	DIAG_CFG14	Input diagnostics configuration register 14	0x48	Section 8.1.2.37
0x55	DIAGDATA_CFG	Input diagnostics data configuration register	0x00	Section 8.1.2.38
0x58	DIAG_MON_MSB_MBIAS	Diagnostics SAR MICBIAS monitor data MSB byte	0x00	Section 8.1.2.39

Table 8-110. B0_P1 Registers (continued)

Address	Acronym	Register Name	Reset Value	Section
0x59	DIAG_MON_LSB_MBIAS	Diagnostics SAR MICBIAS monitor data LSB nibble	0x01	Section 8.1.2.40
0x62	DIAG_MON_MSB_OUT1P	Diagnostics SAR OUT1P monitor data MSB byte	0x00	Section 8.1.2.41
0x63	DIAG_MON_LSB_OUT1P	Diagnostics SAR OUT1P monitor data LSB nibble	0x06	Section 8.1.2.42
0x64	DIAG_MON_MSB_OUT1M	Diagnostics SAR OUT1M monitor data MSB byte	0x00	Section 8.1.2.43
0x65	DIAG_MON_LSB_OUT1M	Diagnostics SAR OUT1M monitor data LSB nibble	0x07	Section 8.1.2.44
0x66	DIAG_MON_MSB_OUT2P	Diagnostics SAR OUT2P monitor data MSB byte	0x00	Section 8.1.2.45
0x67	DIAG_MON_LSB_OUT2P	Diagnostics SAR OUT2P monitor data LSB nibble	0x08	Section 8.1.2.46
0x68	DIAG_MON_MSB_OUT2M	Diagnostics SAR OUT2M monitor data MSB byte	0x00	Section 8.1.2.47
0x69	DIAG_MON_LSB_OUT2M	Diagnostics SAR OUT2M monitor data LSB nibble	0x09	Section 8.1.2.48
0x6A	DIAG_MON_MSB_TEMP	Diagnostics SAR Temperature monitor data MSB byte	0x00	Section 8.1.2.49
0x6B	DIAG_MON_LSB_TEMP	Diagnostics SAR Temperature monitor data LSB nibble	0x0A	Section 8.1.2.50
0x6C	DIAG_MON_MSB_MBIAS_LOAD	Diagnostics SAR MICBIAS LOAD Current monitor data MSB byte	0x00	Section 8.1.2.51
0x6D	DIAG_MON_LSB_MBIAS_LOAD	Diagnostics SAR MICBIAS LOAD Current monitor data LSB nibble	0x0B	Section 8.1.2.52
0x6E	DIAG_MON_MSB_AVDD	Diagnostics SAR AVDD monitor data MSB byte	0x00	Section 8.1.2.53
0x6F	DIAG_MON_LSB_AVDD	Diagnostics SAR AVDD monitor data LSB nibble	0x0C	Section 8.1.2.54
0x70	DIAG_MON_MSB_GPA	Diagnostics SAR GPA monitor data MSB byte	0x00	Section 8.1.2.55
0x71	DIAG_MON_LSB_GPA	Diagnostics SAR GPA monitor data LSB nibble register	0x0D	Section 8.1.2.56

8.1.2.1 PAGE_CFG Register (Address = 0x0) [Reset = 0x00]

PAGE_CFG is shown in [Table 8-111](#).

Return to the [Summary Table](#).

The device memory map is divided into pages. This register sets the page.

Table 8-111. PAGE_CFG Register Field Descriptions

Bit	Field	Type	Reset	Description
7-0	PAGE[7:0]	R/W	00000000b	These bits set the device page. 0d = Page 0 1d = Page 1 2d to 254d = Page 2 to page 254 respectively 255d = Page 255

8.1.2.2 DSP_CFG0 Register (Address = 0x3) [Reset = 0x00]

DSP_CFG0 is shown in [Table 8-112](#).

Return to the [Summary Table](#).

This register is the configuration register for on-the-fly filter updates.

Table 8-112. DSP_CFG0 Register Field Descriptions

Bit	Field	Type	Reset	Description
7	RESERVED	R	0b	Reserved bit; Write only reset value
6	RESERVED	R	0b	Reserved bit; Write only reset value
5	RESERVED	R	0b	Reserved bit; Write only reset value
4	RESERVED	R	0b	Reserved bit; Write only reset value
3	RESERVED	R	0b	Reserved bit; Write only reset value
2	RESERVED	R	0b	Reserved bit; Write only reset value

Table 8-112. DSP_CFG0 Register Field Descriptions (continued)

Bit	Field	Type	Reset	Description
1	RESERVED	R	0b	Reserved bit; Write only reset value
0	EN_BQ_OTF_CHG	R/W	0b	Enable run-time changes to Biquad settings. 0d = Disable on the fly biquad changes 1d = Enable on the fly biquad changes

8.1.2.3 CLK_CFG0 Register (Address = 0xD) [Reset = 0x00]

CLK_CFG0 is shown in [Table 8-113](#).

Return to the [Summary Table](#).

This register is the Clock configuration register 0.

Table 8-113. CLK_CFG0 Register Field Descriptions

Bit	Field	Type	Reset	Description
7	CNT_TGT_CFG_OVR_PASI	R/W	0b	ASI controller target Config Override Register 0d = controller-target Config as per PASI_CNT_CFG bit. 1d = Override the standard behavior of the PASI_CNT_CFG. In this case the clock auto detect feature is not available. PASI_CNT_CFG = 0 : BCLK is input but FSYNC is output. PASI_CNT_CFG = 1 : BCLK is output but FSYNC in input.
6	CNT_TGT_CFG_OVR_SASI	R/W	0b	ASI controller target Config Override Register 0d = controller-target Config as per SASI_CNT_CFG bit. 1d = Override the standard behavior of the SASI_CNT_CFG. In this case the clock auto detect feature is not available. SASI_CNT_CFG = 0 : BCLK is input but FSYNC is output. SASI_CNT_CFG = 1 : BCLK is output but FSYNC in input.
5-3	RESERVED	R	0b	Reserved bits; Write only reset value
2	PASI_USE_INT_FSYNC	R/W	0b	For Primary use internal FSYNC in controller mode configuration. 0d = Use external FSYNC 1d = Use internal FSYNC
1	SASI_USE_INT_FSYNC	R/W	0b	For Secondary use internal FSYNC in controller mode configuration. 0d = Use external FSYNC 1d = Use internal FSYNC
0	RESERVED	R	0b	Reserved bit; Write only reset value

8.1.2.4 CHANNEL_CFG1 Register (Address = 0xE) [Reset = 0x00]

CHANNEL_CFG1 is shown in [Table 8-114](#).

Return to the [Summary Table](#).

This is the ADC channel dynamic power-on or off configuration register.

Table 8-114. CHANNEL_CFG1 Register Field Descriptions

Bit	Field	Type	Reset	Description
7	FORCE_DYN_MODE_CUST_MAX_CH	R/W	0b	ADC Force dynamic mode custom max channel 0d = In Dynamic, Max channel is based on ADC_DYN_MAXCH_SEL 1d = In Dynamic mode, max channel is custom as DYN_MODE_CUST_MAX_CH
6-3	DYN_MODE_CUST_MAX_CH[3:0]	R/W	0000b	ADC Dynamic mode custom max channel configuration [3]->CH4_EN [2]->CH3_EN [1]->CH2_EN [0]->CH1_EN
2-0	RESERVED	R	0b	Reserved bits; Write only reset values

8.1.2.5 CHANNEL_CFG2 Register (Address = 0xF) [Reset = 0x00]

CHANNEL_CFG2 is shown in [Table 8-115](#).

Return to the [Summary Table](#).

This is the DAC channel dynamic power-on or off configuration register.

Table 8-115. CHANNEL_CFG2 Register Field Descriptions

Bit	Field	Type	Reset	Description
7	DAC_FORCE_DYN_MODE_CUST_MAX_CH	R/W	0b	DAC Force dynamic mode custom max channel 0d = In Dynamic, Max channel is based on DAC_DYN_MAXCH_SEL 1d = In Dynamic mode, max channel is custom as per DAC_DYN_MODE_CUST_MAX_CH
6-3	DAC_DYN_MODE_CUST_MAX_CH[3:0]	R/W	0000b	DAC Dynamic mode custom max channel configuration ([3]->CH4_EN, [2]->CH3_EN, [1]->CH2_EN, [0]->CH1_EN) [3]->CH4_EN [2]->CH3_EN [1]->CH2_EN [0]->CH1_EN
2-0	RESERVED	R	0b	Reserved bits; Write only reset values

8.1.2.6 SRC_CFG0 Register (Address = 0x17) [Reset = 0x00]

SRC_CFG0 is shown in [Table 8-116](#).

Return to the [Summary Table](#).

This register is configuration register 1 for SRC.

Table 8-116. SRC_CFG0 Register Field Descriptions

Bit	Field	Type	Reset	Description
7	SRC_EN	R/W	0b	SRC enable config 0b = SRC disable 1b = SRC enable
6	DIS_AUTO_SRC_DET	R/W	0b	SRC auto detect config 0b = SRC auto detect enabled 1b = SRC auto detect disabled
5-0	RESERVED	R	0b	Reserved bits; Write only reset value

8.1.2.7 SRC_CFG1 Register (Address = 0x18) [Reset = 0x00]

SRC_CFG1 is shown in [Table 8-117](#).

Return to the [Summary Table](#).

This register is configuration register 2 for SRC.

Table 8-117. SRC_CFG1 Register Field Descriptions

Bit	Field	Type	Reset	Description
7	MAIN_FS_CUSTOM_CFG	R/W	0b	Main Fs custom config 0b = Main Fs is auto inferred 1b = Main Fs need to be selected from MAIN_FS_SELECT_CFG
6	MAIN_FS_SELECT_CFG	R/W	0b	Main Fs select config 0b = PASI Fs shall be used as Main Fs 1b = SASI Fs shall be used as Main Fs

Table 8-117. SRC_CFG1 Register Field Descriptions (continued)

Bit	Field	Type	Reset	Description
5-3	MAIN_AUX_RATIO_M_C USTOM_CFG[2:0]	R/W	000b	Main and Aux Fs Ratio m:n config 0d = m is auto inferred 1d = 1 2d = 2 3d = 3 4d = 4 5d = Reserved 6d = 6 7d = Reserved
2-0	MAIN_AUX_RATIO_N_C USTOM_CFG[2:0]	R/W	000b	Main and Aux Fs Ratio m:n config 0d = n is auto inferred 1d = 1 2d = 2 3d = 3 4d = 4 5d = Reserved 6d = 6 7d = Reserved

8.1.2.8 JACK_DET_CFG0 Register (Address = 0x19) [Reset = 0x00]

JACK_DET_CFG0 is shown in [Table 8-118](#).

Return to the [Summary Table](#).

This register is the Jack Detection configuration register 0.

Table 8-118. JACK_DET_CFG0 Register Field Descriptions

Bit	Field	Type	Reset	Description
7-6	JACK_DET_MONITOR_F REQ[1:0]	R/W	00b	Headset Detection Pulse Frequency 0d = 0.5 Hz 1d = 1 Hz 2d = 7.5 Hz 3d = 15 Hz
5	JACK_DET_PULSE_WID TH	R/W	0b	Detector Pulse High Width 0d = 4ms (MICBIAS PIN Cap = 1 uF) 1d = 32ms (MICBIAS PIN Cap = 10 uF)
4	RESERVED	R	0b	Reserved bit; Write only reset value
3	RESERVED	R	0b	Reserved bit; Write only reset value
2-1	HPDET_CLOCK_SEL[1:0]	R/W	00b	Headphone Detection Clock Time period Select 0d = 1ms 1d = 2ms 2d = 4ms 3d = Reserved
0	RESERVED	R	0b	Reserved bit; Write only reset value

8.1.2.9 JACK_DET_CFG1 Register (Address = 0x1A) [Reset = 0x00]

JACK_DET_CFG1 is shown in [Table 8-119](#).

Return to the [Summary Table](#).

This register is the Jack Detection configuration register 1.

Table 8-119. JACK_DET_CFG1 Register Field Descriptions

Bit	Field	Type	Reset	Description
7	RESERVED	R	0b	Reserved bit; Write only reset value

Table 8-119. JACK_DET_CFG1 Register Field Descriptions (continued)

Bit	Field	Type	Reset	Description
6	JACK_DET_COMP_CTRL 2	R/W	0b	Hook Press Threshold Control in Fixed External Resistance case, controls the choice of Lowest Microphone impedance to be supported or Highest Hook button Impedance to be supported 0d = Minimum Microphone resistance supported, R_Mic = 800 Ωs and Max Hook button impedance supported, R_Hook = 320 Ωs for AC coupled Headphones R26<3> = 0 (else, when R26<3> = 1, R_hook = 150 Ωs) 1d = Max Hook button impedance supported, R_hook = 680 Ωs and Minimum Microphone resistance supported, R_Mic = 1350 Ωs for AC coupled Headphones R26<3> = 0 (else, when R26<3> = 1, R_Mic = 1750 Ωs)
5-4	JACK_DET_COMP_CTRL 3[1:0]	R/W	00b	Hook Pressed Jack Insertion support, valid only for External Resistor Type P0_R25_D4 = 0 else Don't care. 0d = supports minimum Hook button impedance of 150 Ωs for Hook Pressed Jack Insertion detection 1d = supports minimum Hook button impedance of 100 Ωs for Hook Pressed Jack Insertion detection 2d = supports minimum Hook button impedance of 50 Ωs for Hook Pressed Jack Insertion detection 3d = Reserved
3	HPDET_COUPLING	R/W	0b	Headphone detect coupling 0d = AC coupled 1d = DC coupled
2	HPDET_USE_2x_CURR	R/W	0b	Headset detect current sel config 0d = 2x current for headphone detection disabled 1d = 2x current for headphone detection enabled
1	JACK_DET_EN	R/W	0b	Headset Detection Enable 0d = Headset Detection Disabled 1d = Headset Detection Enabled
0	RESERVED	R	0b	Reserved bit; Write only reset value

8.1.2.10 JACK_DET_CFG2 Register (Address = 0x1B) [Reset = 0x00]

JACK_DET_CFG2 is shown in [Table 8-120](#).

Return to the [Summary Table](#).

This register is the Jack Detection configuration register 2.

Table 8-120. JACK_DET_CFG2 Register Field Descriptions

Bit	Field	Type	Reset	Description
7	RESERVED	R	0b	Reserved bit; Write only reset value
6	HPDET_DEB	R/W	0b	Headphone Detection Debounce Programmability 0d = No Debounce 1d = Debounce of 3 detections
5-3	JACK_DET_DEB_INSERT[2:0]	R/W	000b	Headset Insert Detection Debounce Programmability 0d = Debounce Time = 16ms 1d = Debounce Time = 32ms 2d = Debounce Time = 64ms 3d = Debounce Time = 128ms 4d = Debounce Time = 256ms 5d = Debounce Time = 512ms 6d = Reserved 7d = No Debounce
2	JACK_DET_DEB_REMOVE	R/W	0b	Headset Removal Detection Debounce Programmability 0d = Debounce of 5 detections 1d = Debounce of 3 detections

Table 8-120. JACK_DET_CFG2 Register Field Descriptions (continued)

Bit	Field	Type	Reset	Description
1-0	JACK_DET_DEB_HOOK_PRESS[1:0]	R/W	00b	Hook Press Debounce config 0d = No Debounce 1d = No Debounce 2d = Debounce of 2 detections 3d = Debounce of 3 detections

8.1.2.11 JACK_DET_CFG3 Register (Address = 0x1C) [Reset = 0x00]

JACK_DET_CFG3 is shown in [Table 8-121](#).

Return to the [Summary Table](#).

This register is the Jack Detection configuration register 3.

Table 8-121. JACK_DET_CFG3 Register Field Descriptions

Bit	Field	Type	Reset	Description
7-6	JACK_TYPE_FLAG[1:0]	R	00b	Headset Jack type flag 0d = Jack is not inserted 1d = Jack is inserted without Microphone 2d = Reserved. Do not use 3d = Jack is inserted with Microphone
5-4	HEADSET_TYPE_DET[1:0]	R	00b	Headset type 0d = Headset is not inserted 1d = Jack is inserted with mono-HS (RIGHT) 2d = Jack is inserted with mono-HS (LEFT) 3d = Jack is inserted with stereo-HS
3-0	RESERVED	R	0b	Reserved bits; Write only reset value

8.1.2.12 LPAD_CFG1 Register (Address = 0x1E) [Reset = 0x20]

LPAD_CFG1 is shown in [Table 8-122](#).

Return to the [Summary Table](#).

This register is the voice activity detection or ultrasonic activity detection configuration register 1.

Table 8-122. LPAD_CFG1 Register Field Descriptions

Bit	Field	Type	Reset	Description
7-6	LPAD_MODE[1:0]	R/W	00b	Auto ADC power up / power down configuration selection. 0d = User initiated ADC power-up and ADC power-down 1d = VAD/UAD interrupt based ADC power up and ADC power down 2d = VAD/UAD interrupt based ADC power up but user initiated ADC power down 3d = Reserved
5-4	LPAD_CH_SEL[1:0]	R/W	10b	VAD channel select. 0d = Channel 1 is monitored for VAD/UAD activity 1d = Channel 2 is monitored for VAD/UAD activity 2d = Channel 3 is monitored for VAD/UAD activity 3d = Channel 4 is monitored for VAD/UAD activity
3	LPAD_SDOUT_INT_CFG	R/W	0b	SDOUT interrupt configuration. 0d = SDOUT pin is not enabled for interrupt function 1d = SDOUT pin is enabled to support interrupt output when channel data in not being recorded
2	RESERVED	R	0b	Reserved bit; Write only reset value
1	LPAD_PD_DET_EN	R/W	0b	Enable ASI output data during VAD/UAD activity. 0d = VAD/UAD processing is not enabled during ADC recording 1d = VAD/UAD processing is enabled during ADC recording and VAD interrupts are generated as configured

Table 8-122. LPAD_CFG1 Register Field Descriptions (continued)

Bit	Field	Type	Reset	Description
0	RESERVED	R	0b	Reserved bit; Write only reset value

8.1.2.13 LPSG_CFG1 Register (Address = 0x1F) [Reset = 0x80]

LPSG_CFG1 is shown in [Table 8-123](#).

Return to the [Summary Table](#).

This register is configuration register 1 for Ultrasonic signal generation.

Table 8-123. LPSG_CFG1 Register Field Descriptions

Bit	Field	Type	Reset	Description
7-6	LPSG_CH_SEL[1:0]	R/W	10b	LPSG channel select.- UAG 0d = UAG activity is generated on channel 1 1d = UAG activity is generated on channel 2 2d = UAG activity is generated on channel 3 3d = UAG activity is generated on channel 4
5	RESERVED	R	0b	Reserved bit; Write only reset value
4-0	RESERVED	R	0b	Reserved bits; Write only reset values

8.1.2.14 LPAD_LPSG_CFG1 Register (Address = 0x20) [Reset = 0x00]

LPAD_LPSG_CFG1 is shown in [Table 8-124](#).

Return to the [Summary Table](#).

This register is configuration register 1 for VAD/UAD/UAG.

Table 8-124. LPAD_LPSG_CFG1 Register Field Descriptions

Bit	Field	Type	Reset	Description
7-6	LPAD_LPSG_CLK_CFG[1:0]	R/W	00b	Clock select for VAD/UAD/UAG 0d = VAD/UAD/UAG processing using internal oscillator clock 1d = VAD/UAD/UAG processing using external clock on BCLK input 2d = VAD/UAD/UAG processing using external clock on CCLK input 3d = Custom clock configuration based on CNT_CFG, CLK_SRC and CLKGEN_CFG registers in page 0
5-4	LPAD_LPSG_EXT_CLK_CFG[1:0]	R/W	00b	Clock configuration using external clock for VAD/UAD/UAG 0d = External clock is 24.576 MHz 1d = Reserved 2d = External clock is 12.288 MHz 3d = External clock is 18.432 MHz
3	RESERVED	R	0b	Reserved bit; Write only reset value
2	LPAD_PH1_EN	R/W	0b	Enable LPAD Phase 1 detection through Jack Detection comparator. 0d = LPAD phase 1 disabled 1d = LPAD phase 1 enabled
1-0	RESERVED	R	0b	Reserved bits; Write only reset values

8.1.2.15 LIMITER_CFG Register (Address = 0x23) [Reset = 0x00]

LIMITER_CFG is shown in [Table 8-125](#).

Return to the [Summary Table](#).

This register is configuration register for Limiter.

Table 8-125. LIMITER_CFG Register Field Descriptions

Bit	Field	Type	Reset	Description
7-6	LIMITER_INP_SEL[1:0]	R/W	00b	Limiter input select config 0d = max(dacin_ch0, dacin_ch1) 1d = dacin_ch1 2d = dacin_ch0 3d = avg(dacin_ch0, dacin_ch1)
5-4	LIMITER_OUT_SEL[1:0]	R/W	00b	Limiter output select config 0d = applied on both 1d = dacin_ch1 2d = dacin_ch0 3d = applied none
3-0	RESERVED	R	0b	Reserved bits; Write only reset values

8.1.2.16 AGC_DRC_CFG Register (Address = 0x24) [Reset = 0x00]

AGC_DRC_CFG is shown in [Table 8-126](#).

Return to the [Summary Table](#).

This register is configuration register for AGC and DRC.

Table 8-126. AGC_DRC_CFG Register Field Descriptions

Bit	Field	Type	Reset	Description
7	AGC_CH1_EN	R/W	0b	AGC Channel 1 enable config 0d = disable 1d = enable
6	AGC_CH2_EN	R/W	0b	AGC Channel 2 enable config 0d = disable 1d = enable
5	AGC_CH3_EN	R/W	0b	AGC Channel 3 enable config 0d = disable 1d = enable
4	AGC_CH4_EN	R/W	0b	AGC Channel 4 enable config 0d = disable 1d = enable
3	DRC_CH1_EN	R/W	0b	DRC Channel 1 enable config 0d = disable 1d = enable
2	DRC_CH2_EN	R/W	0b	DRC Channel 2 enable config 0d = disable 1d = enable
1	DRC_CH3_EN	R/W	0b	DRC Channel 3 enable config 0d = disable 1d = enable
0	DRC_CH4_EN	R/W	0b	DRC Channel 4 enable config 0d = disable 1d = enable

8.1.2.17 PLIM_CFG0 Register (Address = 0x2B) [Reset = 0x00]

PLIM_CFG0 is shown in [Table 8-127](#).

Return to the [Summary Table](#).

This register is configuration register 0 for PLIM.

Table 8-127. PLIM_CFG0 Register Field Descriptions

Bit	Field	Type	Reset	Description
7	EN_PLIM	R/W	0b	Enable PLIM 0d = Disable 1d = Enable
6-4	PLIM_ATTEN_VAL[2:0]	R/W	000b	PLIM attenuation factor 0d = 0dB 1d = -6dB 2d = -12dB 3d = -18dB 4d = -24dB 5d = -30dB 6d = -36dB 7d = -42dB
3	PLIM_BY_SAR_GPA	R/W	0b	PLIM attenuation value source 0d = Plimit attenuation based on GPIO and reg_plimi_attn_val 1d = Plimit attenuation based on GPA Analog voltage. LUT will map SAR ADC data to Attenuation factor
2	PLIM_RECOVERY	R/W	0b	PLIM attenuation recovery 0d = Plimit func doesn't recover. It stays at same attenuation level or can apply more attenuation if required 1d = Plimit func recovers (reduces the attenuation) if "gpio_val=0" or "sar_adc_gpa" data suggest that Battery Voltage has recovered then we can reduce the attenuation being applied
1-0	RESERVED	R	0b	Reserved bits; Write only reset value

8.1.2.18 MIXER_CFG0 Register (Address = 0x2C) [Reset = 0x00]

MIXER_CFG0 is shown in [Table 8-128](#).

Return to the [Summary Table](#).

This register is the MIXER configuration register 0.

Table 8-128. MIXER_CFG0 Register Field Descriptions

Bit	Field	Type	Reset	Description
7	EN_DAC_ASI_MIXER	R/W	0b	Enable DAC ASI Mixer 0b = Disabled 1b = Enabled
6	EN_SIDE_CHAIN_MIXER	R/W	0b	Enable Side Chain Mixer 0b = Disabled 1b = Enabled
5	EN_ADC_CHANNEL_MIXER	R/W	0b	Enable ADC Channel Mixer 0b = Disabled 1b = Enabled
4	EN_LOOPBACK_MIXER	R/W	0b	Enable Loopback Mixer 0b = Disabled 1b = Enabled
3-0	RESERVED	R	0b	Reserved bits; Write only reset value

8.1.2.19 MISC_CFG0 Register (Address = 0x2D) [Reset = 0x00]

MISC_CFG0 is shown in [Table 8-129](#).

Return to the [Summary Table](#).

This register is the miscellaneous configuration register 0.

Table 8-129. MISC_CFG0 Register Field Descriptions

Bit	Field	Type	Reset	Description
7	EN_DISTORTION	R/W	0b	Distortion Limiter enable config 0b = Distortion Limiter disable 1b = Distortion Limiter enable
6	EN_BOP	R/W	0b	BOP enable config 0b = BOP disable 1b = BOP enable
5	EN_THERMAL_FOLDBACK	R/W	0b	Thermal Foldback enable config 0b = Thermal Foldback disable 1b = Thermal Foldback enable
4	RESERVED	R	0b	Reserved bit; Write only reset value
3	DAC_SIGNAL_GENERATOR_1_ENABLE	R/W	0b	DAC signal generator 1 enable config 0b = Signal generator disabled 1b = Signal generator enabled
2	DAC_SIGNAL_GENERATOR_2_ENABLE	R/W	0b	DAC signal generator 2 enable config 0b = Signal generator disabled 1b = Signal generator enabled
1	DSP_AVDD_SEL	R/W	0b	SAR data source select for DSP Limiter, BOP, DRC 0b = Reserved 1b = SAR AVDD data to DSP
0	BRWNOUT_EN	R/W	0b	Brownout enable config 0b = Brownout disable 1b = Brownout enable

8.1.2.20 BRWNOUT Register (Address = 0x2E) [Reset = 0xBF]

BRWNOUT is shown in [Table 8-130](#).

Return to the [Summary Table](#).

This register is the brownout configuration register.

Table 8-130. BRWNOUT Register Field Descriptions

Bit	Field	Type	Reset	Description
7-0	BRWNOUT_THRS[7:0]	R/W	10111111b	Threshold for brownout shutdown Default = 7.8V ((IF P1_R45_D1->DSP_AVDD_SEL=1) = 2.7V) Nd = ((0.9*(N*16)/4095)-0.211764)x17 (V) ((IF P1_R45_D1->DSP_AVDD_SEL=1) = ((0.9*(N*16)/4095)-0.225)x6 (V))

8.1.2.21 INT_MASK0 Register (Address = 0x2F) [Reset = 0xFF]

INT_MASK0 is shown in [Table 8-131](#).

Return to the [Summary Table](#).

This register is the interrupt mask register 0.

Table 8-131. INT_MASK0 Register Field Descriptions

Bit	Field	Type	Reset	Description
7	INT_MASK0	R/W	1b	Clock error interrupt mask. 0b = Don't Mask 1b = Mask
6	INT_MASK0	R/W	1b	PLL Lock interrupt mask. 0b = Don't Mask 1b = Mask
5	RESERVED	R	0b	Reserved bit; Write only reset value
4	RESERVED	R	0b	Reserved bit; Write only reset value

Table 8-131. INT_MASK0 Register Field Descriptions (continued)

Bit	Field	Type	Reset	Description
3	RESERVED	R	0b	Reserved bit; Write only reset value
2	RESERVED	R	0b	Reserved bit; Write only reset value
1	RESERVED	R	0b	Reserved bit; Write only reset value
0	RESERVED	R	0b	Reserved bit; Write only reset value

8.1.2.22 INT_MASK4 Register (Address = 0x32) [Reset = 0x00]

INT_MASK4 is shown in [Table 8-132](#).

Return to the [Summary Table](#).

This register is the interrupt mask register 4.

Table 8-132. INT_MASK4 Register Field Descriptions

Bit	Field	Type	Reset	Description
7	RESERVED	R	0b	Reserved bit; Write only reset value
6	RESERVED	R	0b	Reserved bit; Write only reset value
5	INT_MASK4	R/W	0b	OUT Short Circuit Fault Interrupt Mask. 0b = Don't Mask 1b = Mask
4	INT_MASK4	R/W	0b	DRVR Virtual Ground Fault Interrupt Mask. 0b = Don't Mask 1b = Mask
3	INT_MASK4	R/W	0b	Headset insert detection interrupt mask. 0b = Don't Mask 1b = Mask
2	INT_MASK4	R/W	0b	Headset remove detection interrupt mask. 0b = Don't Mask 1b = Mask
1	INT_MASK4	R/W	0b	Headset detection hook(button) interrupt mask. 0b = Don't Mask 1b = Mask
0	RESERVED	R	0b	Reserved bit; Write only reset value

8.1.2.23 INT_MASK5 Register (Address = 0x33) [Reset = 0x30]

INT_MASK5 is shown in [Table 8-133](#).

Return to the [Summary Table](#).

This register is the interrupt mask register 5.

Table 8-133. INT_MASK5 Register Field Descriptions

Bit	Field	Type	Reset	Description
7	INT_MASK5	R/W	0b	GPA up threshold fault mask. 0b = Don't Mask 1b = Mask
6	INT_MASK5	R/W	0b	GPA low threshold fault mask. 0b = Don't Mask 1b = Mask
5	INT_MASK5	R/W	1b	VAD power up detect interrupt mask. 0b = Don't Mask 1b = Mask

Table 8-133. INT_MASK5 Register Field Descriptions (continued)

Bit	Field	Type	Reset	Description
4	INT_MASK5	R/W	1b	VAD power down detect interrupt mask. 0b = Don't Mask 1b = Mask
3	RESERVED	R	0b	Reserved bit; Write only reset value
2	RESERVED	R	0b	Reserved bit; Write only reset value
1	RESERVED	R	0b	Reserved bit; Write only reset value
0	RESERVED	R	0b	Reserved bit; Write only reset value

8.1.2.24 INT_LTCH0 Register (Address = 0x34) [Reset = 0x00]

INT_LTCH0 is shown in [Table 8-134](#).

Return to the [Summary Table](#).

This register is the latched interrupt readback register 0.

Table 8-134. INT_LTCH0 Register Field Descriptions

Bit	Field	Type	Reset	Description
7	INT_LTCH0	R	0b	Interrupt due to clock error (self clearing bit). 0b = No interrupt 1b = Interrupt
6	INT_LTCH0	R	0b	Interrupt due to PLL Lock (self clearing bit) 0b = No interrupt 1b = Interrupt
5	RESERVED	R	0b	Reserved bit; Write only reset value
4	RESERVED	R	0b	Reserved bit; Write only reset value
3	RESERVED	R	0b	Reserved bit; Write only reset value
2	RESERVED	R	0b	Reserved bit; Write only reset value
1	RESERVED	R	0b	Reserved bit; Write only reset value
0	RESERVED	R	0b	Reserved bit; Write only reset value

8.1.2.25 OUT_CH1_LTCH Register (Address = 0x38) [Reset = 0x00]

OUT_CH1_LTCH is shown in [Table 8-135](#).

Return to the [Summary Table](#).

This register is the latched status register for channel 1 output DC faults diagnostics.

Table 8-135. OUT_CH1_LTCH Register Field Descriptions

Bit	Field	Type	Reset	Description
7	OUT_CH1_LTCH	R	0b	OUT1P Short Circuit Fault (self clearing bit). 0b = No short circuit fault 1b = Short circuit fault
6	OUT_CH1_LTCH	R	0b	OUT1M Short Circuit Fault (self clearing bit). 0b = No short circuit fault 1b = Short circuit fault
5	OUT_CH1_LTCH	R	0b	Channel 1 DRVRP Virtual Ground Fault (self clearing bit). 0b = No virtual ground fault 1b = Virtual ground fault
4	OUT_CH1_LTCH	R	0b	Channel 1 DRVRM Virtual Ground Fault (self clearing bit). 0b = No virtual ground fault 1b = Virtual ground fault

Table 8-135. OUT_CH1_LTCH Register Field Descriptions (continued)

Bit	Field	Type	Reset	Description
3	MASK_ADC_CH1_OVRLD_FLAG	R/W	0b	ADC CH1 OVRLD fault mask. 0b = Don't Mask 1b = Mask
2	MASK_ADC_CH2_OVRLD_FLAG	R/W	0b	ADC CH2 OVRLD fault mask. 0b = Don't Mask 1b = Mask
1-0	RESERVED	R	0b	Reserved bits; Write only reset value

8.1.2.26 OUT_CH2_LTCH Register (Address = 0x39) [Reset = 0x00]

OUT_CH2_LTCH is shown in [Table 8-136](#).

Return to the [Summary Table](#).

This register is the latched status register for channel 2 output DC faults diagnostics.

Table 8-136. OUT_CH2_LTCH Register Field Descriptions

Bit	Field	Type	Reset	Description
7	OUT_CH2_LTCH	R	0b	OUT2P Short Circuit Fault (self clearing bit). 0b = No short circuit fault 1b = Short circuit fault
6	OUT_CH2_LTCH	R	0b	OUT2M Short Circuit Fault (self clearing bit). 0b = No short circuit fault 1b = Short circuit fault
5	OUT_CH2_LTCH	R	0b	Channel 2 DRVRP Virtual Ground Fault (self clearing bit). 0b = No virtual ground fault 1b = Virtual ground fault
4	OUT_CH2_LTCH	R	0b	Channel 2 DRVRM Virtual Ground Fault (self clearing bit). 0b = No virtual ground fault 1b = Virtual ground fault
3-2	RESERVED	R	0b	Reserved bits; Write only reset value
1	MASK_AREG_SC_FLAG	R/W	0b	AREG SC fault mask. 0b = Don't Mask 1b = Mask
0	AREG_SC_FLAG_LTCH	R	0b	AREG SC fault (self clearing bit). 0b = No AREG short circuit fault 1b = AREG short circuit fault

8.1.2.27 INT_LTCH1 Register (Address = 0x3A) [Reset = 0x00]

INT_LTCH1 is shown in [Table 8-137](#).

Return to the [Summary Table](#).

This is the register 1 for latched interrupt readback.

Table 8-137. INT_LTCH1 Register Field Descriptions

Bit	Field	Type	Reset	Description
7	RESERVED	R	0b	Reserved bit; Write only reset value
6	RESERVED	R	0b	Reserved bit; Write only reset value
5	RESERVED	R	0b	Reserved bit; Write only reset value
4	RESERVED	R	0b	Reserved bit; Write only reset value
3	INT_LTCH1	R	0b	Interrupt due to Headset Insert Detection (self clearing bit). 0b = No interrupt 1b = Interrupt

Table 8-137. INT_LTCH1 Register Field Descriptions (continued)

Bit	Field	Type	Reset	Description
2	INT_LTCH1	R	0b	Interrupt due to Headset Remove Detection (self clearing bit). 0b = No interrupt 1b = Interrupt
1	INT_LTCH1	R	0b	Interrupt due to Headset hook(button) (self clearing bit). 0b = No interrupt 1b = Interrupt
0	RESERVED	R	0b	Reserved bit; Write only reset value

8.1.2.28 INT_LTCH2 Register (Address = 0x3B) [Reset = 0x00]

INT_LTCH2 is shown in [Table 8-138](#).

Return to the [Summary Table](#).

This is the register 2 for latched interrupt readback.

Table 8-138. INT_LTCH2 Register Field Descriptions

Bit	Field	Type	Reset	Description
7	INT_LTCH2	R	0b	Interrupt due to GPA up threshold fault (self clearing bit). 0b = No interrupt 1b = Interrupt
6	INT_LTCH2	R	0b	Interrupt due to GPA low threshold fault (self clearing bit). 0b = No interrupt 1b = Interrupt
5	INT_LTCH2	R	0b	Interrupt due to VAD power up detect (self clearing bit). 0b = No interrupt 1b = Interrupt
4	INT_LTCH2	R	0b	Interrupt due to VAD power down detect (self clearing bit). 0b = No interrupt 1b = Interrupt
3	RESERVED	R	0b	Reserved bit; Write only reset value
2	RESERVED	R	0b	Reserved bit; Write only reset value
1	RESERVED	R	0b	Reserved bit; Write only reset value
0	RESERVED	R	0b	Reserved bit; Write only reset value

8.1.2.29 INT_LIVE0 Register (Address = 0x3C) [Reset = 0x00]

INT_LIVE0 is shown in [Table 8-139](#).

Return to the [Summary Table](#).

This is the register 0 for live interrupt readback.

Table 8-139. INT_LIVE0 Register Field Descriptions

Bit	Field	Type	Reset	Description
7	INT_LIVE0	R	0b	Interrupt due to clock error . 0b = No interrupt 1b = Interrupt
6	INT_LIVE0	R	0b	Interrupt due to PLL Lock 0b = No interrupt 1b = Interrupt
5	RESERVED	R	0b	Reserved bit; Write only reset value
4	RESERVED	R	0b	Reserved bit; Write only reset value
3	RESERVED	R	0b	Reserved bit; Write only reset value
2	RESERVED	R	0b	Reserved bit; Write only reset value

Table 8-139. INT_LIVE0 Register Field Descriptions (continued)

Bit	Field	Type	Reset	Description
1	RESERVED	R	0b	Reserved bit; Write only reset value
0	RESERVED	R	0b	Reserved bit; Write only reset value

8.1.2.30 OUT_CH1_LIVE Register (Address = 0x40) [Reset = 0x00]

OUT_CH1_LIVE is shown in [Table 8-140](#).

Return to the [Summary Table](#).

This register is the live status register for channel 1 output DC faults diagnostics.

Table 8-140. OUT_CH1_LIVE Register Field Descriptions

Bit	Field	Type	Reset	Description
7	OUT_CH1_LIVE	R	0b	OUT1P Short Circuit Fault . 0b = No short circuit fault 1b = Short circuit fault
6	OUT_CH1_LIVE	R	0b	OUT1M Short Circuit Fault . 0b = No short circuit fault 1b = Short circuit fault
5	OUT_CH1_LIVE	R	0b	Channel 1 DRVRP Virtual Ground Fault . 0b = No virtual ground fault 1b = Virtual ground fault
4	OUT_CH1_LIVE	R	0b	Channel 1 DRVRM Virtual Ground Fault . 0b = No virtual ground fault 1b = Virtual ground fault
3-0	RESERVED	R	0b	Reserved bits; Write only reset value

8.1.2.31 OUT_CH2_LIVE Register (Address = 0x41) [Reset = 0x00]

OUT_CH2_LIVE is shown in [Table 8-141](#).

Return to the [Summary Table](#).

This register is the live status register for channel 2 output DC faults diagnostics.

Table 8-141. OUT_CH2_LIVE Register Field Descriptions

Bit	Field	Type	Reset	Description
7	OUT_CH2_LIVE	R	0b	OUT2P Short Circuit Fault . 0b = No short circuit fault 1b = Short circuit fault
6	OUT_CH2_LIVE	R	0b	OUT2M Short Circuit Fault . 0b = No short circuit fault 1b = Short circuit fault
5	OUT_CH2_LIVE	R	0b	Channel 2 DRVRP Virtual Ground Fault . 0b = No virtual ground fault 1b = Virtual ground fault
4	OUT_CH2_LIVE	R	0b	Channel 2 DRVRM Virtual Ground Fault . 0b = No virtual ground fault 1b = Virtual ground fault
3-1	RESERVED	R	0b	Reserved bits; Write only reset value
0	AREG_SC_FLAG_LIVE	R	0b	AREG SC fault . 0b = No AREG short circuit fault 1b = AREG short circuit fault

8.1.2.32 INT_LIVE1 Register (Address = 0x42) [Reset = 0x00]

INT_LIVE1 is shown in [Table 8-142](#).

Return to the [Summary Table](#).

This is the register 1 for live interrupt readback.

Table 8-142. INT_LIVE1 Register Field Descriptions

Bit	Field	Type	Reset	Description
7	RESERVED	R	0b	Reserved bit; Write only reset value
6	RESERVED	R	0b	Reserved bit; Write only reset value
5	RESERVED	R	0b	Reserved bit; Write only reset value
4	RESERVED	R	0b	Reserved bit; Write only reset value
3	INT_LIVE1	R	0b	Interrupt due to Headset Insert Detection . 0b = No interrupt 1b = Interrupt
2	INT_LIVE1	R	0b	Interrupt due to Headset Remove Detection . 0b = No interrupt 1b = Interrupt
1	INT_LIVE1	R	0b	Interrupt due to Headset hook(button) . 0b = No interrupt 1b = Interrupt
0	RESERVED	R	0b	Reserved bit; Write only reset value

8.1.2.33 INT_LIVE2 Register (Address = 0x43) [Reset = 0x00]

INT_LIVE2 is shown in [Table 8-143](#).

Return to the [Summary Table](#).

This is the register 2 for live interrupt readback.

Table 8-143. INT_LIVE2 Register Field Descriptions

Bit	Field	Type	Reset	Description
7	INT_LIVE2	R	0b	Interrupt due to GPA up threshold fault . 0b = No interrupt 1b = Interrupt
6	INT_LIVE2	R	0b	Interrupt due to GPA low threshold fault 0b = No interrupt 1b = Interrupt
5	INT_LIVE2	R	0b	Interrupt due to VAD power up detect . 0b = No interrupt 1b = Interrupt
4	INT_LIVE2	R	0b	Interrupt due to VAD power down detect . 0b = No interrupt 1b = Interrupt
3	RESERVED	R	0b	Reserved bit; Write only reset value
2	RESERVED	R	0b	Reserved bit; Write only reset value
1	RESERVED	R	0b	Reserved bit; Write only reset value
0	RESERVED	R	0b	Reserved bit; Write only reset value

8.1.2.34 DIAG_CFG8 Register (Address = 0x4E) [Reset = 0xBA]

DIAG_CFG8 is shown in [Table 8-144](#).

Return to the [Summary Table](#).

This is the input diagnostics configuration register 8.

Table 8-144. DIAG_CFG8 Register Field Descriptions

Bit	Field	Type	Reset	Description
7-0	GPA_UP_THRS_FLT_TH RES[7:0]	R/W	10111010b	General Purpose Analog High Threshold Default = ~ 2.6V $nd = ((0.9 \cdot (N \cdot 16) / 4095) - 0.225) \times 6 \text{ (V)}$

8.1.2.35 DIAG_CFG9 Register (Address = 0x4F) [Reset = 0x4B]

DIAG_CFG9 is shown in [Table 8-145](#).

Return to the [Summary Table](#).

This is the input diagnostics configuration register 9.

Table 8-145. DIAG_CFG9 Register Field Descriptions

Bit	Field	Type	Reset	Description
7-0	GPA_LOW_THRS_FLT_T HRES[7:0]	R/W	01001011b	General Purpose Analog Low Threshold Default = ~ 0.2V $nd = ((0.9 \cdot (N \cdot 16) / 4095) - 0.225) \times 6 \text{ (V)}$

8.1.2.36 DIAG_CFG13 Register (Address = 0x53) [Reset = 0x00]

DIAG_CFG13 is shown in [Table 8-146](#).

Return to the [Summary Table](#).

This is the input diagnostics configuration register 13.

Table 8-146. DIAG_CFG13 Register Field Descriptions

Bit	Field	Type	Reset	Description
7	RESERVED	R	0b	Reserved bit; Write only reset value
6	RESERVED	R	0b	Reserved bit; Write only reset value
5	RESERVED	R	0b	Reserved bit; Write only reset value
4	RESERVED	R	0b	Reserved bit; Write only reset value
3	RESERVED	R	0b	Reserved bit; Write only reset value
2	DIAG_EN_AVDD	R/W	0b	AVDD channel enable for Diagnostics 0b = Diagnostic Disabled 1b = Diagnostic Enabled
1	DIAG_EN_GPA	R/W	0b	GPA channel enable for Diagnostics 0b = Diagnostic Disabled 1b = Diagnostic Enabled
0	RESERVED	R	0b	Reserved bit; Write only reset value

8.1.2.37 DIAG_CFG14 Register (Address = 0x54) [Reset = 0x48]

DIAG_CFG14 is shown in [Table 8-147](#).

Return to the [Summary Table](#).

This is the input diagnostics configuration register 14.

Table 8-147. DIAG_CFG14 Register Field Descriptions

Bit	Field	Type	Reset	Description
7	RESERVED	R	0b	Reserved bit; Write only reset value

Table 8-147. DIAG_CFG14 Register Field Descriptions (continued)

Bit	Field	Type	Reset	Description
6-5	AVDD_FILT_SEL[1:0]	R/W	10b	AVDD filter select 0d = 3.5MHz 1d = 200kHz 2d = 100kHz 3d = No filter
4	RESERVED	R	0b	Reserved bit; Write only reset value
3-2	RESERVED	R	0b	Reserved bits; Write only reset values
1	RESERVED	R	0b	Reserved bit; Write only reset value
0	RESERVED	R	0b	Reserved bit; Write only reset value

8.1.2.38 DIAGDATA_CFG Register (Address = 0x55) [Reset = 0x00]

DIAGDATA_CFG is shown in [Table 8-148](#).

Return to the [Summary Table](#).

This register is the input diagnostics data configuration register.

Table 8-148. DIAGDATA_CFG Register Field Descriptions

Bit	Field	Type	Reset	Description
7-4	RESERVED	R	0b	Reserved bits; Write only reset values
3	IADC_DATA_IN_DIAG_REGS	R/W	0b	IADC channel data in diagnostics channel data registers 0b= Disabled 1b= Enabled
2	HOLD_IADC_DATA	R/W	0b	Hold IADC data update during register readback 0b= Data update is not held, Data register is continuously updated 1b= Data update is held, Data register readback can be done
1	OVRD_TEMP_DATA	R/W	0b	Override TEMP data 0b= Override Disabled 1b= Override Enabled
0	HOLD_SAR_DATA	R/W	0b	Hold SAR data update during register readback 0b= Data update is not held, Data register is continuously updated 1b= Data update is held, Data register readback can be done

8.1.2.39 DIAG_MON_MSB_MBIAS Register (Address = 0x58) [Reset = 0x00]

DIAG_MON_MSB_MBIAS is shown in [Table 8-149](#).

Return to the [Summary Table](#).

This register is the diagnostics SAR MICBIAS monitor data MSB byte register.

Table 8-149. DIAG_MON_MSB_MBIAS Register Field Descriptions

Bit	Field	Type	Reset	Description
7-0	DIAG_MON_MSB_MBIAS[7:0]	R	00000000b	Diagnostic SAR Monitor Data MSB Byte

8.1.2.40 DIAG_MON_LSB_MBIAS Register (Address = 0x59) [Reset = 0x01]

DIAG_MON_LSB_MBIAS is shown in [Table 8-150](#).

Return to the [Summary Table](#).

This register is the diagnostics SAR MICBIAS monitor data LSB nibble.

Table 8-150. DIAG_MON_LSB_MBIAS Register Field Descriptions

Bit	Field	Type	Reset	Description
7-4	DIAG_MON_LSB_MBIAS[3:0]	R	0000b	Diagnostic SAR Monitor Data LSB Nibble
3-0	Channel[3:0]	R	0001b	Channel ID

8.1.2.41 DIAG_MON_MSB_OUT1P Register (Address = 0x62) [Reset = 0x00]

DIAG_MON_MSB_OUT1P is shown in [Table 8-151](#).

Return to the [Summary Table](#).

This register is the diagnostics SAR OUT1P monitor data MSB byte register.

Table 8-151. DIAG_MON_MSB_OUT1P Register Field Descriptions

Bit	Field	Type	Reset	Description
7-0	DIAG_MON_MSB_OUT_CH1P[7:0]	R	00000000b	Diagnostic SAR Monitor Data MSB Byte

8.1.2.42 DIAG_MON_LSB_OUT1P Register (Address = 0x63) [Reset = 0x06]

DIAG_MON_LSB_OUT1P is shown in [Table 8-152](#).

Return to the [Summary Table](#).

This register is the diagnostics SAR OUT1P monitor data LSB nibble register.

Table 8-152. DIAG_MON_LSB_OUT1P Register Field Descriptions

Bit	Field	Type	Reset	Description
7-4	DIAG_MON_LSB_OUT_C H1P[3:0]	R	0000b	Diagnostic SAR Monitor Data LSB Nibble
3-0	Channel[3:0]	R	0110b	Channel ID

8.1.2.43 DIAG_MON_MSB_OUT1M Register (Address = 0x64) [Reset = 0x00]

DIAG_MON_MSB_OUT1M is shown in [Table 8-153](#).

Return to the [Summary Table](#).

This register is the diagnostics SAR OUT1M monitor data MSB byte register.

Table 8-153. DIAG_MON_MSB_OUT1M Register Field Descriptions

Bit	Field	Type	Reset	Description
7-0	DIAG_MON_MSB_OUT_CH1N[7:0]	R	00000000b	Diagnostic SAR Monitor Data MSB Byte

8.1.2.44 DIAG_MON_LSB_OUT1M Register (Address = 0x65) [Reset = 0x07]

DIAG_MON_LSB_OUT1M is shown in [Table 8-154](#).

Return to the [Summary Table](#).

This register is the diagnostics SAR OUT1M monitor data LSB nibble register.

Table 8-154. DIAG_MON_LSB_OUT1M Register Field Descriptions

Bit	Field	Type	Reset	Description
7-4	DIAG_MON_LSB_OUT_C H1N[3:0]	R	0000b	Diagnostic SAR Monitor Data LSB Nibble

Table 8-154. DIAG_MON_LSB_OUT1M Register Field Descriptions (continued)

Bit	Field	Type	Reset	Description
3-0	Channel[3:0]	R	0111b	Channel ID

8.1.2.45 DIAG_MON_MSB_OUT2P Register (Address = 0x66) [Reset = 0x00]

DIAG_MON_MSB_OUT2P is shown in [Table 8-155](#).

Return to the [Summary Table](#).

This register is the diagnostics SAR OUT2P monitor data MSB byte register.

Table 8-155. DIAG_MON_MSB_OUT2P Register Field Descriptions

Bit	Field	Type	Reset	Description
7-0	DIAG_MON_MSB_OUT_CH2P[7:0]	R	00000000b	Diagnostic SAR Monitor Data MSB Byte

8.1.2.46 DIAG_MON_LSB_OUT2P Register (Address = 0x67) [Reset = 0x08]

DIAG_MON_LSB_OUT2P is shown in [Table 8-156](#).

Return to the [Summary Table](#).

This register is the diagnostics SAR OUT2P monitor data LSB nibble register.

Table 8-156. DIAG_MON_LSB_OUT2P Register Field Descriptions

Bit	Field	Type	Reset	Description
7-4	DIAG_MON_LSB_OUT_C H2P[3:0]	R	0000b	Diagnostic SAR Monitor Data LSB Nibble
3-0	Channel[3:0]	R	1000b	Channel ID

8.1.2.47 DIAG_MON_MSB_OUT2M Register (Address = 0x68) [Reset = 0x00]

DIAG_MON_MSB_OUT2M is shown in [Table 8-157](#).

Return to the [Summary Table](#).

This register is the diagnostics SAR OUT2M monitor data MSB byte register.

Table 8-157. DIAG_MON_MSB_OUT2M Register Field Descriptions

Bit	Field	Type	Reset	Description
7-0	DIAG_MON_MSB_OUT_CH2M[7:0]	R	00000000b	Diagnostic SAR Monitor Data MSB Byte

8.1.2.48 DIAG_MON_LSB_OUT2M Register (Address = 0x69) [Reset = 0x09]

DIAG_MON_LSB_OUT2M is shown in [Table 8-158](#).

Return to the [Summary Table](#).

This register is the diagnostics SAR OUT2M monitor data LSB nibble register.

Table 8-158. DIAG_MON_LSB_OUT2M Register Field Descriptions

Bit	Field	Type	Reset	Description
7-4	DIAG_MON_LSB_OUT_C H2M[3:0]	R	0000b	Diagnostic SAR Monitor Data LSB Nibble
3-0	Channel[3:0]	R	1001b	Channel ID

8.1.2.49 DIAG_MON_MSB_TEMP Register (Address = 0x6A) [Reset = 0x00]

DIAG_MON_MSB_TEMP is shown in [Table 8-159](#).

Return to the [Summary Table](#).

This register is the diagnostics SAR Temperature monitor data MSB byte register.

Table 8-159. DIAG_MON_MSB_TEMP Register Field Descriptions

Bit	Field	Type	Reset	Description
7-0	DIAG_MON_MSB_TEMP[7:0]	R	00000000b	Diagnostic SAR Monitor Data MSB Byte

8.1.2.50 DIAG_MON_LSB_TEMP Register (Address = 0x6B) [Reset = 0x0A]

DIAG_MON_LSB_TEMP is shown in [Table 8-160](#).

Return to the [Summary Table](#).

This register is the diagnostics SAR Temperature monitor data LSB nibble register.

Table 8-160. DIAG_MON_LSB_TEMP Register Field Descriptions

Bit	Field	Type	Reset	Description
7-4	DIAG_MON_LSB_TEMP[3:0]	R	0000b	Diagnostic SAR Monitor Data LSB Nibble
3-0	Channel[3:0]	R	1010b	Channel ID

8.1.2.51 DIAG_MON_MSB_MBIAS_LOAD Register (Address = 0x6C) [Reset = 0x00]

DIAG_MON_MSB_MBIAS_LOAD is shown in [Table 8-161](#).

Return to the [Summary Table](#).

This register is the diagnostics SAR MICBIAS LOAD Current monitor data MSB byte register.

Table 8-161. DIAG_MON_MSB_MBIAS_LOAD Register Field Descriptions

Bit	Field	Type	Reset	Description
7-0	DIAG_MON_MSB_MBIAS_LOAD[7:0]	R	00000000b	Diagnostic SAR Monitor Data MSB Byte

8.1.2.52 DIAG_MON_LSB_MBIAS_LOAD Register (Address = 0x6D) [Reset = 0x0B]

DIAG_MON_LSB_MBIAS_LOAD is shown in [Table 8-162](#).

Return to the [Summary Table](#).

This register is the diagnostic SAR MICBIAS LOAD Current monitor data LSB nibble register.

Table 8-162. DIAG_MON_LSB_MBIAS_LOAD Register Field Descriptions

Bit	Field	Type	Reset	Description
7-4	DIAG_MON_LSB_MBIAS_LOAD[3:0]	R	0000b	Diagnostic SAR Monitor Data LSB Nibble
3-0	Channel[3:0]	R	1011b	Channel ID

8.1.2.53 DIAG_MON_MSB_AVDD Register (Address = 0x6E) [Reset = 0x00]

DIAG_MON_MSB_AVDD is shown in [Table 8-163](#).

Return to the [Summary Table](#).

This register is the diagnostic SAR AVDD monitor data MSB byte register.

Table 8-163. DIAG_MON_MSB_AVDD Register Field Descriptions

Bit	Field	Type	Reset	Description
7-0	DIAG_MON_MSB_AVDD[7:0]	R	00000000b	Diagnostic SAR Monitor Data MSB Byte

8.1.2.54 DIAG_MON_LSB_AVDD Register (Address = 0x6F) [Reset = 0x0C]

DIAG_MON_LSB_AVDD is shown in [Table 8-164](#).

Return to the [Summary Table](#).

This register is the diagnostic SAR AVDD monitor data LSB nibble register

Table 8-164. DIAG_MON_LSB_AVDD Register Field Descriptions

Bit	Field	Type	Reset	Description
7-4	DIAG_MON_LSB_AVDD[3:0]	R	0000b	Diagnostic SAR Monitor Data LSB Nibble
3-0	Channel[3:0]	R	1100b	Channel ID

8.1.2.55 DIAG_MON_MSB_GPA Register (Address = 0x70) [Reset = 0x00]

DIAG_MON_MSB_GPA is shown in [Table 8-165](#).

Return to the [Summary Table](#).

This register is the diagnostic SAR GPA monitor data MSB byte register.

Table 8-165. DIAG_MON_MSB_GPA Register Field Descriptions

Bit	Field	Type	Reset	Description
7-0	DIAG_MON_MSB_GPA[7:0]	R	00000000b	Diagnostic SAR Monitor Data MSB Byte

8.1.2.56 DIAG_MON_LSB_GPA Register (Address = 0x71) [Reset = 0x0D]

DIAG_MON_LSB_GPA is shown in [Table 8-166](#).

Return to the [Summary Table](#).

This register is the diagnostic SAR GPA monitor data LSB nibble register.

Table 8-166. DIAG_MON_LSB_GPA Register Field Descriptions

Bit	Field	Type	Reset	Description
7-4	DIAG_MON_LSB_GPA[3:0]	R	0000b	Diagnostic SAR Monitor Data LSB Nibble
3-0	Channel[3:0]	R	1101b	Channel ID

8.1.3 Book0_Page3 Registers

Table 8-167 lists the memory-mapped registers for the Book0_Page3 registers. All register offset addresses not listed in Table 8-167 should be considered as reserved locations and the register contents should not be modified.

Table 8-167. BOOK0_PAGE3 Registers

Address	Acronym	Register Name	Reset Value	Section
0x0	PAGE_CFG	Device page register	0x00	Section 8.1.3.1
0x1A	SASI_CFG0	Secondary ASI configuration register 0	0x30	Section 8.1.3.2
0x1B	SASI_TX_CFG0	SASI TX configuration register 0	0x00	Section 8.1.3.3
0x1C	SASI_TX_CFG1	SASI TX configuration register 1	0x00	Section 8.1.3.4
0x1D	SASI_TX_CFG2	SASI TX configuration register 2	0x00	Section 8.1.3.5
0x1E	SASI_TX_CH1_CFG	SASI TX Channel 1 configuration register	0x00	Section 8.1.3.6
0x1F	SASI_TX_CH2_CFG	SASI TX Channel 2 configuration register	0x01	Section 8.1.3.7
0x20	SASI_TX_CH3_CFG	SASI TX Channel 3 configuration register	0x02	Section 8.1.3.8
0x21	SASI_TX_CH4_CFG	SASI TX Channel 4 configuration register	0x03	Section 8.1.3.9
0x22	SASI_TX_CH5_CFG	SASI TX Channel 5 configuration register	0x04	Section 8.1.3.10
0x23	SASI_TX_CH6_CFG	SASI TX Channel 6 configuration register	0x05	Section 8.1.3.11
0x24	SASI_TX_CH7_CFG	SASI TX Channel 7 configuration register	0x06	Section 8.1.3.12
0x25	SASI_TX_CH8_CFG	SASI TX Channel 8 configuration register	0x07	Section 8.1.3.13
0x26	SASI_RX_CFG0	SASI RX configuration register 0	0x00	Section 8.1.3.14
0x27	SASI_RX_CFG1	SASI RX configuration register 1	0x00	Section 8.1.3.15
0x28	SASI_RX_CH1_CFG	SASI RX Channel 1 configuration register	0x00	Section 8.1.3.16
0x29	SASI_RX_CH2_CFG	SASI RX Channel 2 configuration register	0x01	Section 8.1.3.17
0x2A	SASI_RX_CH3_CFG	SASI RX Channel 3 configuration register	0x02	Section 8.1.3.18
0x2B	SASI_RX_CH4_CFG	SASI RX Channel 4 configuration register	0x03	Section 8.1.3.19
0x2C	SASI_RX_CH5_CFG	SASI RX Channel 5 configuration register	0x04	Section 8.1.3.20
0x2D	SASI_RX_CH6_CFG	SASI RX Channel 6 configuration register	0x05	Section 8.1.3.21
0x2E	SASI_RX_CH7_CFG	SASI RX Channel 7 configuration register	0x06	Section 8.1.3.22
0x2F	SASI_RX_CH8_CFG	SASI RX Channel 8 configuration register	0x07	Section 8.1.3.23
0x32	CLK_CFG12	Clock configuration register 12	0x00	Section 8.1.3.24
0x33	CLK_CFG13	Clock configuration register 13	0x00	Section 8.1.3.25
0x34	CLK_CFG14	Clock configuration register 14	0x10	Section 8.1.3.26
0x35	CLK_CFG15	Clock configuration register 15	0x01	Section 8.1.3.27
0x36	CLK_CFG16	Clock configuration register 16	0x00	Section 8.1.3.28
0x37	CLK_CFG17	Clock configuration register 17	0x00	Section 8.1.3.29
0x38	CLK_CFG18	Clock configuration register 18	0x08	Section 8.1.3.30
0x39	CLK_CFG19	Clock configuration register 19	0x20	Section 8.1.3.31
0x3A	CLK_CFG20	Clock configuration register 20	0x04	Section 8.1.3.32
0x3B	CLK_CFG21	Clock configuration register 21	0x00	Section 8.1.3.33
0x3C	CLK_CFG22	Clock configuration register 22	0x01	Section 8.1.3.34
0x3D	CLK_CFG23	Clock configuration register 23	0x01	Section 8.1.3.35
0x3E	CLK_CFG24	Clock configuration register 24	0x01	Section 8.1.3.36
0x44	CLK_CFG30	Clock configuration register 30	0x00	Section 8.1.3.37
0x45	CLK_CFG31	Clock configuration register 31	0x00	Section 8.1.3.38
0x46	CLKOUT_CFG1	CLKOUT configuration register 1	0x00	Section 8.1.3.39
0x47	CLKOUT_CFG2	CLKOUT configuration register 2	0x01	Section 8.1.3.40
0x49	SARCLK_CFG1	SAR clock configuration register 1	0x00	Section 8.1.3.41

Table 8-167. BOOK0_PAGE3 Registers (continued)

Address	Acronym	Register Name	Reset Value	Section
0x5B	ADC_OVRD_FLAG	ADC overload flag register	0x00	Section 8.1.3.42

8.1.3.1 PAGE_CFG Register (Address = 0x0) [Reset = 0x00]

PAGE_CFG is shown in [Table 8-168](#).

Return to the [Summary Table](#).

The device memory map is divided into pages. This register sets the page.

Table 8-168. PAGE_CFG Register Field Descriptions

Bit	Field	Type	Reset	Description
7-0	PAGE[7:0]	R/W	00000000b	These bits set the device page. 0d = Page 0 1d = Page 1 2d to 254d = Page 2 to page 254 respectively 255d = Page 255

8.1.3.2 SASI_CFG0 Register (Address = 0x1A) [Reset = 0x30]

SASI_CFG0 is shown in [Table 8-169](#).

Return to the [Summary Table](#).

This register is the ASI configuration register 0.

Table 8-169. SASI_CFG0 Register Field Descriptions

Bit	Field	Type	Reset	Description
7-6	SASI_FORMAT[1:0]	R/W	00b	Secondary ASI protocol format. 0d = TDM mode 1d = I ² S mode 2d = LJ (left-justified) mode 3d = Reserved; Don't use
5-4	SASI_WLEN[1:0]	R/W	11b	Secondary ASI word or slot length. 0d = 16 bits (Recommended this setting to be used with 10kandx3A9;# input impedance configuration) 1d = 20 bits 2d = 24 bits 3d = 32 bits
3	SASI_FSYNC_POL	R/W	0b	ASI FSYNC polarity (for SASI protocol only). 0d = Default polarity as per standard protocol 1d = Inverted polarity with respect to standard protocol
2	SASI_BCLK_POL	R/W	0b	ASI BCLK polarity (for SASI protocol only). 0d = Default polarity as per standard protocol 1d = Inverted polarity with respect to standard protocol
1	SASI_BUS_ERR	R/W	0b	ASI bus error detection. 0d = Enable bus error detection 1d = Disable bus error detection
0	SASI_BUS_ERR_RCOV	R/W	0b	ASI bus error auto resume. 0d = Enable auto resume after bus error recovery 1d = Disable auto resume after bus error recovery and remain powered down until host configures the device

8.1.3.3 SASI_TX_CFG0 Register (Address = 0x1B) [Reset = 0x00]

SASI_TX_CFG0 is shown in [Table 8-170](#).

Return to the [Summary Table](#).

This register is the SASI TX configuration register 0.

Table 8-170. SASI_TX_CFG0 Register Field Descriptions

Bit	Field	Type	Reset	Description
7	SASI_TX_EDGE	R/W	0b	Secondary ASI data output (on the primary and secondary data pin) transmit edge. 0d = Default edge as per the protocol configuration setting in SASI_BCLK_POL 1d = Inverted following edge (half cycle delay) with respect to the default edge setting
6	SASI_TX_FILL	R/W	0b	Secondary ASI data output (on the primary and secondary data pin) for any unused cycles 0d = Always transmit 0 for unused cycles 1d = Always use Hi-Z for unused cycles
5	SASI_TX_LSB	R/W	0b	Secondary ASI data output (on the primary and secondary data pin) for LSB transmissions. 0d = Transmit the LSB for a full cycle 1d = Transmit the LSB for the first half cycle and Hi-Z for the second half cycle
4-3	SASI_TX_KEEPER[1:0]	R/W	00b	Secondary ASI data output (on the primary and secondary data pin) bus keeper. 0d = Bus keeper is always disabled 1d = Bus keeper is always enabled 2d = Bus keeper is enabled during LSB transmissions only for one cycle 3d = Bus keeper is enabled during LSB transmissions only for one and half cycles
2	SASI_TX_USE_INT_FSYNC	R/W	0b	Secondary ASI uses internal FSYNC for output data generation in controller mode configuration as applicable. 0d = Use external FSYNC for ASI protocol data generation 1d = Use internal FSYNC for ASI protocol data generation
1	SASI_TX_USE_INT_BCLK	R/W	0b	Secondary ASI uses internal BCLK for output data generation in controller mode configuration. 0d = Use external BCLK for ASI protocol data generation 1d = Use internal BCLK for ASI protocol data generation
0	SASI_TDM_PULSE_WIDTH	R/W	0b	Secondary ASI fsync pulse width in TDM format. 0d = Fsync pulse is 1 bclk period wide 1d = Fsync pulse is 2 bclk period wide

8.1.3.4 SASI_TX_CFG1 Register (Address = 0x1C) [Reset = 0x00]

SASI_TX_CFG1 is shown in [Table 8-171](#).

Return to the [Summary Table](#).

This register is the SASI TX configuration register 1.

Table 8-171. SASI_TX_CFG1 Register Field Descriptions

Bit	Field	Type	Reset	Description
7-5	RESERVED	R	0b	Reserved bits; Write only reset value

Table 8-171. SASI_TX_CFG1 Register Field Descriptions (continued)

Bit	Field	Type	Reset	Description
4-0	SASI_TX_OFFSET[4:0]	R/W	00000b	Secondary ASI output data MSB slot 0 offset (on the primary and secondary data pin). 0d = ASI data MSB location has no offset and is as per standard protocol 1d = ASI data MSB location (TDM mode is slot 0 or I ² S, LJ mode is the left and right slot 0) offset of one BCLK cycle with respect to standard protocol 2d = ASI data MSB location (TDM mode is slot 0 or I ² S, LJ mode is the left and right slot 0) offset of two BCLK cycles with respect to standard protocol 3d to 30d = ASI data MSB location (TDM mode is slot 0 or I ² S, LJ mode is the left and right slot 0) offset assigned as per configuration 31d = ASI data MSB location (TDM mode is slot 0 or I ² S, LJ mode is the left and right slot 0) offset of 31 BCLK cycles with respect to standard protocol

8.1.3.5 SASI_TX_CFG2 Register (Address = 0x1D) [Reset = 0x00]

SASI_TX_CFG2 is shown in [Table 8-172](#).

Return to the [Summary Table](#).

This register is the SASI TX configuration register 2.

Table 8-172. SASI_TX_CFG2 Register Field Descriptions

Bit	Field	Type	Reset	Description
7	SASI_TX_CH8_SEL	R/W	0b	Secondary ASI output channel 8 select. 0d = Secondary ASI channel 8 output is on DOUT 1d = Secondary ASI channel 8 output is on DOUT2
6	SASI_TX_CH7_SEL	R/W	0b	Secondary ASI output channel 7 select. 0d = Secondary ASI channel 7 output is on DOUT 1d = Secondary ASI channel 7 output is on DOUT2
5	SASI_TX_CH6_SEL	R/W	0b	Secondary ASI output channel 6 select. 0d = Secondary ASI channel 6 output is on DOUT 1d = Secondary ASI channel 6 output is on DOUT2
4	SASI_TX_CH5_SEL	R/W	0b	Secondary ASI output channel 5 select. 0d = Secondary ASI channel 5 output is on DOUT 1d = Secondary ASI channel 5 output is on DOUT2
3	SASI_TX_CH4_SEL	R/W	0b	Secondary ASI output channel 4 select. 0d = Secondary ASI channel 4 output is on DOUT 1d = Secondary ASI channel 4 output is on DOUT2
2	SASI_TX_CH3_SEL	R/W	0b	Secondary ASI output channel 3 select. 0d = Secondary ASI channel 3 output is on DOUT 1d = Secondary ASI channel 3 output is on DOUT2
1	SASI_TX_CH2_SEL	R/W	0b	Secondary ASI output channel 2 select. 0d = Secondary ASI channel 2 output is on DOUT 1d = Secondary ASI channel 2 output is on DOUT2
0	SASI_TX_CH1_SEL	R/W	0b	Secondary ASI output channel 1 select. 0d = Secondary ASI channel 1 output is on DOUT 1d = Secondary ASI channel 1 output is on DOUT2

8.1.3.6 SASI_TX_CH1_CFG Register (Address = 0x1E) [Reset = 0x00]

SASI_TX_CH1_CFG is shown in [Table 8-173](#).

Return to the [Summary Table](#).

This register is the SASI TX Channel 1 configuration register.

Table 8-173. SASI_TX_CH1_CFG Register Field Descriptions

Bit	Field	Type	Reset	Description
7-6	RESERVED	R	0b	Reserved bits; Write only reset value
5	SASI_TX_CH1_CFG	R/W	0b	Secondary ASI output channel 1 configuration. 0d = Secondary ASI channel 1 output is in a tri-state condition 1d = Secondary ASI channel 1 output corresponds to ADC Channel 1 data
4-0	SASI_TX_CH1_SLOT_NUM[4:0]	R/W	00000b	Secondary ASI output channel 1 slot assignment. 0d = TDM is slot 0 or I ² S, LJ is left slot 0 1d = TDM is slot 1 or I ² S, LJ is left slot 1 2d to 14d = Slot assigned as per configuration 15d = TDM is slot 15 or I ² S, LJ is left slot 15 16d = TDM is slot 16 or I ² S, LJ is right slot 0 17d = TDM is slot 17 or I ² S, LJ is right slot 1 18d to 30d = Slot assigned as per configuration 31d = TDM is slot 31 or I ² S, LJ is right slot 15

8.1.3.7 SASI_TX_CH2_CFG Register (Address = 0x1F) [Reset = 0x01]

SASI_TX_CH2_CFG is shown in [Table 8-174](#).

Return to the [Summary Table](#).

This register is the SASI TX Channel 2 configuration register.

Table 8-174. SASI_TX_CH2_CFG Register Field Descriptions

Bit	Field	Type	Reset	Description
7-6	RESERVED	R	0b	Reserved bits; Write only reset value
5	SASI_TX_CH2_CFG	R/W	0b	Secondary ASI output channel 2 configuration. 0d = Secondary ASI channel 2 output is in a tri-state condition 1d = Secondary ASI channel 2 output corresponds to ADC Channel 2 data
4-0	SASI_TX_CH2_SLOT_NUM[4:0]	R/W	00001b	Secondary ASI output channel 2 slot assignment. 0d = TDM is slot 0 or I ² S, LJ is left slot 0 1d = TDM is slot 1 or I ² S, LJ is left slot 1 2d to 14d = Slot assigned as per configuration 15d = TDM is slot 15 or I ² S, LJ is left slot 15 16d = TDM is slot 16 or I ² S, LJ is right slot 0 17d = TDM is slot 17 or I ² S, LJ is right slot 1 18d to 30d = Slot assigned as per configuration 31d = TDM is slot 31 or I ² S, LJ is right slot 15

8.1.3.8 SASI_TX_CH3_CFG Register (Address = 0x20) [Reset = 0x02]

SASI_TX_CH3_CFG is shown in [Table 8-175](#).

Return to the [Summary Table](#).

This register is the SASI TX Channel 3 configuration register.

Table 8-175. SASI_TX_CH3_CFG Register Field Descriptions

Bit	Field	Type	Reset	Description
7	RESERVED	R	0b	Reserved bit; Write only reset value
6-5	SASI_TX_CH3_CFG[1:0]	R/W	00b	Secondary ASI output channel 3 configuration. 0d = Secondary ASI channel 3 output is in a tri-state condition 1d = Secondary ASI channel 3 output corresponds to ADC Channel 3 data 2d = Reserved 3d = Reserved

Table 8-175. SASI_TX_CH3_CFG Register Field Descriptions (continued)

Bit	Field	Type	Reset	Description
4-0	SASI_TX_CH3_SLOT_NUM[4:0]	R/W	00010b	Secondary ASI output channel 3 slot assignment. 0d = TDM is slot 0 or I ² S, LJ is left slot 0 1d = TDM is slot 1 or I ² S, LJ is left slot 1 2d to 14d = Slot assigned as per configuration 15d = TDM is slot 15 or I ² S, LJ is left slot 15 16d = TDM is slot 16 or I ² S, LJ is right slot 0 17d = TDM is slot 17 or I ² S, LJ is right slot 1 18d to 30d = Slot assigned as per configuration 31d = TDM is slot 31 or I ² S, LJ is right slot 15

8.1.3.9 SASI_TX_CH4_CFG Register (Address = 0x21) [Reset = 0x03]

SASI_TX_CH4_CFG is shown in [Table 8-176](#).

Return to the [Summary Table](#).

This register is the SASI TX Channel 4 configuration register.

Table 8-176. SASI_TX_CH4_CFG Register Field Descriptions

Bit	Field	Type	Reset	Description
7	RESERVED	R	0b	Reserved bit; Write only reset value
6-5	SASI_TX_CH4_CFG[1:0]	R/W	00b	Secondary ASI output channel 4 configuration. 0d = Secondary ASI channel 4 output is in a tri-state condition 1d = Secondary ASI channel 4 output corresponds to ADC Channel 4 data 2d = Secondary ASI channel 4 output corresponds to TEMP data 3d = Reserved
4-0	SASI_TX_CH4_SLOT_NUM[4:0]	R/W	00011b	Secondary ASI output channel 4 slot assignment. 0d = TDM is slot 0 or I ² S, LJ is left slot 0 1d = TDM is slot 1 or I ² S, LJ is left slot 1 2d to 14d = Slot assigned as per configuration 15d = TDM is slot 15 or I ² S, LJ is left slot 15 16d = TDM is slot 16 or I ² S, LJ is right slot 0 17d = TDM is slot 17 or I ² S, LJ is right slot 1 18d to 30d = Slot assigned as per configuration 31d = TDM is slot 31 or I ² S, LJ is right slot 15

8.1.3.10 SASI_TX_CH5_CFG Register (Address = 0x22) [Reset = 0x04]

SASI_TX_CH5_CFG is shown in [Table 8-177](#).

Return to the [Summary Table](#).

This register is the SASI TX Channel 5 configuration register.

Table 8-177. SASI_TX_CH5_CFG Register Field Descriptions

Bit	Field	Type	Reset	Description
7	RESERVED	R	0b	Reserved bit; Write only reset value
6-5	SASI_TX_CH5_CFG[1:0]	R/W	00b	Secondary ASI output channel 5 configuration. 0d = Secondary ASI channel 5 output is in a tri-state condition 1d = Secondary ASI channel 5 output corresponds to ASI Input Channel 1 loopback data 2d = Secondary ASI channel 5 output corresponds to echo reference channel 1 data 3d = Reserved

Table 8-177. SASI_TX_CH5_CFG Register Field Descriptions (continued)

Bit	Field	Type	Reset	Description
4-0	SASI_TX_CH5_SLOT_NUM[4:0]	R/W	00100b	Secondary ASI output channel 5 slot assignment. 0d = TDM is slot 0 or I ² S, LJ is left slot 0 1d = TDM is slot 1 or I ² S, LJ is left slot 1 2d to 14d = Slot assigned as per configuration 15d = TDM is slot 15 or I ² S, LJ is left slot 15 16d = TDM is slot 16 or I ² S, LJ is right slot 0 17d = TDM is slot 17 or I ² S, LJ is right slot 1 18d to 30d = Slot assigned as per configuration 31d = TDM is slot 31 or I ² S, LJ is right slot 15

8.1.3.11 SASI_TX_CH6_CFG Register (Address = 0x23) [Reset = 0x05]

SASI_TX_CH6_CFG is shown in [Table 8-178](#).

Return to the [Summary Table](#).

This register is the SASI TX Channel 6 configuration register.

Table 8-178. SASI_TX_CH6_CFG Register Field Descriptions

Bit	Field	Type	Reset	Description
7	RESERVED	R	0b	Reserved bit; Write only reset value
6-5	SASI_TX_CH6_CFG[1:0]	R/W	00b	Secondary ASI output channel 6 configuration. 0d = Secondary ASI channel 6 output is in a tri-state condition 1d = Secondary ASI channel 6 output corresponds to ASI Input Channel 2 loopback data 2d = Secondary ASI channel 6 output corresponds to echo reference channel 2 data 3d = Reserved
4-0	SASI_TX_CH6_SLOT_NUM[4:0]	R/W	00101b	Secondary ASI output channel 6 slot assignment. 0d = TDM is slot 0 or I ² S, LJ is left slot 0 1d = TDM is slot 1 or I ² S, LJ is left slot 1 2d to 14d = Slot assigned as per configuration 15d = TDM is slot 15 or I ² S, LJ is left slot 15 16d = TDM is slot 16 or I ² S, LJ is right slot 0 17d = TDM is slot 17 or I ² S, LJ is right slot 1 18d to 30d = Slot assigned as per configuration 31d = TDM is slot 31 or I ² S, LJ is right slot 15

8.1.3.12 SASI_TX_CH7_CFG Register (Address = 0x24) [Reset = 0x06]

SASI_TX_CH7_CFG is shown in [Table 8-179](#).

Return to the [Summary Table](#).

This register is the SASI TX Channel 7 configuration register.

Table 8-179. SASI_TX_CH7_CFG Register Field Descriptions

Bit	Field	Type	Reset	Description
7	RESERVED	R	0b	Reserved bit; Write only reset value
6-5	SASI_TX_CH7_CFG[1:0]	R/W	00b	Secondary ASI output channel 7 configuration. 0d = Secondary ASI channel 7 output is in a tri-state condition 1d = Reserved 2d = Secondary ASI channel 7 output corresponds to {echo_ref_ch1_wlby2, echo_ref_ch2_wlby2} 3d = Reserved

Table 8-179. SASI_TX_CH7_CFG Register Field Descriptions (continued)

Bit	Field	Type	Reset	Description
4-0	SASI_TX_CH7_SLOT_NUM[4:0]	R/W	00110b	Secondary ASI output channel 7 slot assignment. 0d = TDM is slot 0 or I ² S, LJ is left slot 0 1d = TDM is slot 1 or I ² S, LJ is left slot 1 2d to 14d = Slot assigned as per configuration 15d = TDM is slot 15 or I ² S, LJ is left slot 15 16d = TDM is slot 16 or I ² S, LJ is right slot 0 17d = TDM is slot 17 or I ² S, LJ is right slot 1 18d to 30d = Slot assigned as per configuration 31d = TDM is slot 31 or I ² S, LJ is right slot 15

8.1.3.13 SASI_TX_CH8_CFG Register (Address = 0x25) [Reset = 0x07]

SASI_TX_CH8_CFG is shown in [Table 8-180](#).

Return to the [Summary Table](#).

This register is the SASI TX Channel 8 configuration register.

Table 8-180. SASI_TX_CH8_CFG Register Field Descriptions

Bit	Field	Type	Reset	Description
7-6	RESERVED	R	0b	Reserved bits; Write only reset value
5	SASI_TX_CH8_CFG	R/W	0b	Secondary ASI output channel 8 configuration. 0d = Secondary ASI channel 8 output is in a tri-state condition 1d = Secondary ASI channel 8 output corresponds to ICLA data
4-0	SASI_TX_CH8_SLOT_NUM[4:0]	R/W	00111b	Secondary ASI output channel 8 slot assignment. 0d = TDM is slot 0 or I ² S, LJ is left slot 0 1d = TDM is slot 1 or I ² S, LJ is left slot 1 2d to 14d = Slot assigned as per configuration 15d = TDM is slot 15 or I ² S, LJ is left slot 15 16d = TDM is slot 16 or I ² S, LJ is right slot 0 17d = TDM is slot 17 or I ² S, LJ is right slot 1 18d to 30d = Slot assigned as per configuration 31d = TDM is slot 31 or I ² S, LJ is right slot 15

8.1.3.14 SASI_RX_CFG0 Register (Address = 0x26) [Reset = 0x00]

SASI_RX_CFG0 is shown in [Table 8-181](#).

Return to the [Summary Table](#).

This register is the SASI RX configuration register 0.

Table 8-181. SASI_RX_CFG0 Register Field Descriptions

Bit	Field	Type	Reset	Description
7	SASI_RX_EDGE	R/W	0b	Secondary ASI data input (on the primary and secondary data pin) receive edge. 0d = Default edge as per the protocol configuration setting in bit 2 (BCLK_POL) 1d = Inverted following edge (half cycle delay) with respect to the default edge setting
6	SASI_RX_USE_INT_FSYNCK	R/W	0b	Secondary ASI uses internal FSYNCK for input data latching in controller mode configuration as applicable. 0d = Use external FSYNCK for ASI protocol data latching 1d = Use internal FSYNCK for ASI protocol data latching
5	SASI_RX_USE_INT_BCLK	R/W	0b	Secondary ASI uses internal BCLK for input data latching in controller mode configuration. 0d = Use external BCLK for ASI protocol data latching 1d = Use internal BCLK for ASI protocol data latching

Table 8-181. SASI_RX_CFG0 Register Field Descriptions (continued)

Bit	Field	Type	Reset	Description
4-0	SASI_RX_OFFSET[4:0]	R/W	00000b	Secondary ASI data input MSB slot 0 offset (on the primary and secondary data pin). 0d = ASI data MSB location has no offset and is as per standard protocol 1d = ASI data MSB location (TDM mode is slot 0 or I ² S, LJ mode is the left and right slot 0) offset of one BCLK cycle with respect to standard protocol 2d = ASI data MSB location (TDM mode is slot 0 or I ² S, LJ mode is the left and right slot 0) offset of two BCLK cycles with respect to standard protocol 3d to 30d = ASI data MSB location (TDM mode is slot 0 or I ² S, LJ mode is the left and right slot 0) offset assigned as per configuration 31d = ASI data MSB location (TDM mode is slot 0 or I ² S, LJ mode is the left and right slot 0) offset of 31 BCLK cycles with respect to standard protocol

8.1.3.15 SASI_RX_CFG1 Register (Address = 0x27) [Reset = 0x00]

SASI_RX_CFG1 is shown in [Table 8-182](#).

Return to the [Summary Table](#).

This register is the SASI RX configuration register 1.

Table 8-182. SASI_RX_CFG1 Register Field Descriptions

Bit	Field	Type	Reset	Description
7	SASI_RX_CH8_SEL	R/W	0b	Secondary ASI input channel 8 select. 0d = Secondary ASI channel 8 input is on DIN 1d = Secondary ASI channel 8 input is on DIN2
6	SASI_RX_CH7_SEL	R/W	0b	Secondary ASI input channel 7 select. 0d = Secondary ASI channel 7 input is on DIN 1d = Secondary ASI channel 7 input is on DIN2
5	SASI_RX_CH6_SEL	R/W	0b	Secondary ASI input channel 6 select. 0d = Secondary ASI channel 6 input is on DIN 1d = Secondary ASI channel 6 input is on DIN2
4	SASI_RX_CH5_SEL	R/W	0b	Secondary ASI input channel 5 select. 0d = Secondary ASI channel 5 input is on DIN 1d = Secondary ASI channel 5 input is on DIN2
3	SASI_RX_CH4_SEL	R/W	0b	Secondary ASI input channel 4 select. 0d = Secondary ASI channel 4 input is on DIN 1d = Secondary ASI channel 4 input is on DIN2
2	SASI_RX_CH3_SEL	R/W	0b	Secondary ASI input channel 3 select. 0d = Secondary ASI channel 3 input is on DIN 1d = Secondary ASI channel 3 input is on DIN2
1	SASI_RX_CH2_SEL	R/W	0b	Secondary ASI input channel 2 select. 0d = Secondary ASI channel 2 input is on DIN 1d = Secondary ASI channel 2 input is on DIN2
0	SASI_RX_CH1_SEL	R/W	0b	Secondary ASI input channel 1 select. 0d = Secondary ASI channel 1 input is on DIN 1d = Secondary ASI channel 1 input is on DIN2

8.1.3.16 SASI_RX_CH1_CFG Register (Address = 0x28) [Reset = 0x00]

SASI_RX_CH1_CFG is shown in [Table 8-183](#).

Return to the [Summary Table](#).

This register is the SASI RX Channel 1 configuration register.

Table 8-183. SASI_RX_CH1_CFG Register Field Descriptions

Bit	Field	Type	Reset	Description
7-6	RESERVED	R	0b	Reserved bits; Write only reset value
5	SASI_RX_CH1_CFG	R/W	0b	Secondary ASI input channel 1 configuration. 0d = Secondary ASI channel 1 input is disabled 1d = Secondary ASI channel 1 input corresponds to DAC Channel 1 data
4-0	SASI_RX_CH1_SLOT_NUM[4:0]	R/W	00000b	Secondary ASI input channel 1 slot assignment. 0d = TDM is slot 0 or I ² S, LJ is left slot 0 1d = TDM is slot 1 or I ² S, LJ is left slot 1 2d to 14d = Slot assigned as per configuration 15d = TDM is slot 15 or I ² S, LJ is left slot 15 16d = TDM is slot 16 or I ² S, LJ is right slot 0 17d = TDM is slot 17 or I ² S, LJ is right slot 1 18d to 30d = Slot assigned as per configuration 31d = TDM is slot 31 or I ² S, LJ is right slot 15

8.1.3.17 SASI_RX_CH2_CFG Register (Address = 0x29) [Reset = 0x01]

SASI_RX_CH2_CFG is shown in [Table 8-184](#).

Return to the [Summary Table](#).

This register is the SASI RX Channel 2 configuration register.

Table 8-184. SASI_RX_CH2_CFG Register Field Descriptions

Bit	Field	Type	Reset	Description
7-6	RESERVED	R	0b	Reserved bits; Write only reset value
5	SASI_RX_CH2_CFG	R/W	0b	Secondary ASI input channel 2 configuration. 0d = Secondary ASI channel 2 input is disabled 1d = Secondary ASI channel 2 input corresponds to DAC Channel 2 data
4-0	SASI_RX_CH2_SLOT_NUM[4:0]	R/W	00001b	Secondary ASI input channel 2 slot assignment. 0d = TDM is slot 0 or I ² S, LJ is left slot 0 1d = TDM is slot 1 or I ² S, LJ is left slot 1 2d to 14d = Slot assigned as per configuration 15d = TDM is slot 15 or I ² S, LJ is left slot 15 16d = TDM is slot 16 or I ² S, LJ is right slot 0 17d = TDM is slot 17 or I ² S, LJ is right slot 1 18d to 30d = Slot assigned as per configuration 31d = TDM is slot 31 or I ² S, LJ is right slot 15

8.1.3.18 SASI_RX_CH3_CFG Register (Address = 0x2A) [Reset = 0x02]

SASI_RX_CH3_CFG is shown in [Table 8-185](#).

Return to the [Summary Table](#).

This register is the SASI RX Channel 3 configuration register.

Table 8-185. SASI_RX_CH3_CFG Register Field Descriptions

Bit	Field	Type	Reset	Description
7-6	RESERVED	R	0b	Reserved bits; Write only reset value
5	SASI_RX_CH3_CFG	R/W	0b	Secondary ASI input channel 3 configuration. 0d = Secondary ASI channel 3 input is disabled 1d = Secondary ASI channel 3 input corresponds to DAC Channel 3 data

Table 8-185. SASI_RX_CH3_CFG Register Field Descriptions (continued)

Bit	Field	Type	Reset	Description
4-0	SASI_RX_CH3_SLOT_NUM[4:0]	R/W	00010b	Secondary ASI input channel 3 slot assignment. 0d = TDM is slot 0 or I ² S, LJ is left slot 0 1d = TDM is slot 1 or I ² S, LJ is left slot 1 2d to 14d = Slot assigned as per configuration 15d = TDM is slot 15 or I ² S, LJ is left slot 15 16d = TDM is slot 16 or I ² S, LJ is right slot 0 17d = TDM is slot 17 or I ² S, LJ is right slot 1 18d to 30d = Slot assigned as per configuration 31d = TDM is slot 31 or I ² S, LJ is right slot 15

8.1.3.19 SASI_RX_CH4_CFG Register (Address = 0x2B) [Reset = 0x03]

SASI_RX_CH4_CFG is shown in [Table 8-186](#).

Return to the [Summary Table](#).

This register is the SASI RX Channel 4 configuration register.

Table 8-186. SASI_RX_CH4_CFG Register Field Descriptions

Bit	Field	Type	Reset	Description
7-6	RESERVED	R	0b	Reserved bits; Write only reset value
5	SASI_RX_CH4_CFG	R/W	0b	Secondary ASI input channel 4 configuration. 0d = Secondary ASI channel 4 input is disabled 1d = Secondary ASI channel 4 input corresponds to DAC Channel 4 data
4-0	SASI_RX_CH4_SLOT_NUM[4:0]	R/W	00011b	Secondary ASI input channel 4 slot assignment. 0d = TDM is slot 0 or I ² S, LJ is left slot 0 1d = TDM is slot 1 or I ² S, LJ is left slot 1 2d to 14d = Slot assigned as per configuration 15d = TDM is slot 15 or I ² S, LJ is left slot 15 16d = TDM is slot 16 or I ² S, LJ is right slot 0 17d = TDM is slot 17 or I ² S, LJ is right slot 1 18d to 30d = Slot assigned as per configuration 31d = TDM is slot 31 or I ² S, LJ is right slot 15

8.1.3.20 SASI_RX_CH5_CFG Register (Address = 0x2C) [Reset = 0x04]

SASI_RX_CH5_CFG is shown in [Table 8-187](#).

Return to the [Summary Table](#).

This register is the SASI RX Channel 5 configuration register.

Table 8-187. SASI_RX_CH5_CFG Register Field Descriptions

Bit	Field	Type	Reset	Description
7	RESERVED	R	0b	Reserved bit; Write only reset value
6-5	SASI_RX_CH5_CFG[1:0]	R/W	00b	Secondary ASI input channel 5 configuration. 0d = Secondary ASI channel 5 input is disabled 1d = Secondary ASI channel 5 input corresponds to DAC Channel 5 data 2d = Secondary ASI channel 5 input corresponds to ADC Channel 1 output loopback 3d = Reserved

Table 8-187. SASI_RX_CH5_CFG Register Field Descriptions (continued)

Bit	Field	Type	Reset	Description
4-0	SASI_RX_CH5_SLOT_NUM[4:0]	R/W	00100b	Secondary ASI input channel 5 slot assignment. 0d = TDM is slot 0 or I ² S, LJ is left slot 0 1d = TDM is slot 1 or I ² S, LJ is left slot 1 2d to 14d = Slot assigned as per configuration 15d = TDM is slot 15 or I ² S, LJ is left slot 15 16d = TDM is slot 16 or I ² S, LJ is right slot 0 17d = TDM is slot 17 or I ² S, LJ is right slot 1 18d to 30d = Slot assigned as per configuration 31d = TDM is slot 31 or I ² S, LJ is right slot 15

8.1.3.21 SASI_RX_CH6_CFG Register (Address = 0x2D) [Reset = 0x05]

SASI_RX_CH6_CFG is shown in [Table 8-188](#).

Return to the [Summary Table](#).

This register is the SASI RX Channel 6 configuration register.

Table 8-188. SASI_RX_CH6_CFG Register Field Descriptions

Bit	Field	Type	Reset	Description
7	RESERVED	R	0b	Reserved bit; Write only reset value
6-5	SASI_RX_CH6_CFG[1:0]	R/W	00b	Secondary ASI input channel 6 configuration. 0d = Secondary ASI channel 6 input is disabled 1d = Secondary ASI channel 6 input corresponds to DAC Channel 6 data 2d = Secondary ASI channel 6 input corresponds to ADC Channel 2 output loopback 3d = Secondary ASI channel 6 input corresponds to ICLA device 1 data
4-0	SASI_RX_CH6_SLOT_NUM[4:0]	R/W	00101b	Secondary ASI input channel 6 slot assignment. 0d = TDM is slot 0 or I ² S, LJ is left slot 0 1d = TDM is slot 1 or I ² S, LJ is left slot 1 2d to 14d = Slot assigned as per configuration 15d = TDM is slot 15 or I ² S, LJ is left slot 15 16d = TDM is slot 16 or I ² S, LJ is right slot 0 17d = TDM is slot 17 or I ² S, LJ is right slot 1 18d to 30d = Slot assigned as per configuration 31d = TDM is slot 31 or I ² S, LJ is right slot 15

8.1.3.22 SASI_RX_CH7_CFG Register (Address = 0x2E) [Reset = 0x06]

SASI_RX_CH7_CFG is shown in [Table 8-189](#).

Return to the [Summary Table](#).

This register is the SASI RX Channel 7 configuration register.

Table 8-189. SASI_RX_CH7_CFG Register Field Descriptions

Bit	Field	Type	Reset	Description
7	RESERVED	R	0b	Reserved bit; Write only reset value
6-5	SASI_RX_CH7_CFG[1:0]	R/W	00b	Secondary ASI input channel 7 configuration. 0d = Secondary ASI channel 7 input is disabled 1d = Secondary ASI channel 7 input corresponds to DAC Channel 7 data 2d = Secondary ASI channel 7 input corresponds to ADC Channel 3 output loopback 3d = Secondary ASI channel 7 input corresponds to ICLA device 2 data

Table 8-189. SASI_RX_CH7_CFG Register Field Descriptions (continued)

Bit	Field	Type	Reset	Description
4-0	SASI_RX_CH7_SLOT_NUM[4:0]	R/W	00110b	Secondary ASI input channel 7 slot assignment. 0d = TDM is slot 0 or I ² S, LJ is left slot 0 1d = TDM is slot 1 or I ² S, LJ is left slot 1 2d to 14d = Slot assigned as per configuration 15d = TDM is slot 15 or I ² S, LJ is left slot 15 16d = TDM is slot 16 or I ² S, LJ is right slot 0 17d = TDM is slot 17 or I ² S, LJ is right slot 1 18d to 30d = Slot assigned as per configuration 31d = TDM is slot 31 or I ² S, LJ is right slot 15

8.1.3.23 SASI_RX_CH8_CFG Register (Address = 0x2F) [Reset = 0x07]

SASI_RX_CH8_CFG is shown in [Table 8-190](#).

Return to the [Summary Table](#).

This register is the SASI RX Channel 8 configuration register.

Table 8-190. SASI_RX_CH8_CFG Register Field Descriptions

Bit	Field	Type	Reset	Description
7	RESERVED	R	0b	Reserved bit; Write only reset value
6-5	SASI_RX_CH8_CFG[1:0]	R/W	00b	Secondary ASI input channel 8 configuration. 0d = Secondary ASI channel 8 input is disabled 1d = Secondary ASI channel 8 input corresponds to DAC Channel 8 data 2d = Secondary ASI channel 8 input corresponds to ADC Channel 4 output loopback 3d = Secondary ASI channel 8 input corresponds to ICLA device 3 data
4-0	SASI_RX_CH8_SLOT_NUM[4:0]	R/W	00111b	Secondary ASI input channel 8 slot assignment. 0d = TDM is slot 0 or I ² S, LJ is left slot 0 1d = TDM is slot 1 or I ² S, LJ is left slot 1 2d to 14d = Slot assigned as per configuration 15d = TDM is slot 15 or I ² S, LJ is left slot 15 16d = TDM is slot 16 or I ² S, LJ is right slot 0 17d = TDM is slot 17 or I ² S, LJ is right slot 1 18d to 30d = Slot assigned as per configuration 31d = TDM is slot 31 or I ² S, LJ is right slot 15

8.1.3.24 CLK_CFG12 Register (Address = 0x32) [Reset = 0x00]

CLK_CFG12 is shown in [Table 8-191](#).

Return to the [Summary Table](#).

This register is the clock configuration register 12.

Table 8-191. CLK_CFG12 Register Field Descriptions

Bit	Field	Type	Reset	Description
7-6	PDIV_CLKSRC_SEL[1:0]	R/W	00b	Source clock selection for PLL PDIV Divider. 0d = PLL_PDIV_IN_CLK is Primary ASI BCLK 1d = PLL_PDIV_IN_CLK is Secondary ASI BCLK 2d = PLL_PDIV_IN_CLK is CCLK 3d = PLL_PDIV_IN_CLK is internal Oscillator Clock (only supported in custom clock configuration)

Table 8-191. CLK_CFG12 Register Field Descriptions (continued)

Bit	Field	Type	Reset	Description
5-3	PASI_BCLK_DIV_CLK_SEL[2:0]	R/W	000b	Primary ASI BCLK divider clock source selection. 0d = Primary ASI BCLK divider clock source is PLL output 1d = Reserved 2d = Primary ASI BCLK divider clock source is secondary ASI BCLK 3d = Primary ASI BCLK divider clock source is CCLK 4d = Primary ASI BCLK divider clock source is internal oscillator clock (only supported in custom clock configuration) 5d = Primary ASI BCLK divider clock source is DSP clock 6d to 7d = Reserved
2-0	RESERVED	R	0b	Reserved bits; Write only reset value

8.1.3.25 CLK_CFG13 Register (Address = 0x33) [Reset = 0x00]

CLK_CFG13 is shown in [Table 8-192](#).

Return to the [Summary Table](#).

This register is the clock configuration register 13.

Table 8-192. CLK_CFG13 Register Field Descriptions

Bit	Field	Type	Reset	Description
7	RESERVED	R	0b	Reserved bit; Write only reset value
6-4	SASI_BCLK_DIV_CLK_SEL[2:0]	R/W	000b	Secondary ASI BCLK divider clock source selection. 0d = Secondary ASI BCLK divider clock source is PLL output 1d = Secondary ASI BCLK divider clock source is primary ASI BCLK 2d = Reserved 3d = Secondary ASI BCLK divider clock source is CCLK 4d = Secondary ASI BCLK divider clock source is internal oscillator clock (only supported in custom clock configuration) 5d = Secondary ASI BCLK divider clock source is DSP clock 6d to 7d = Reserved
3-0	RESERVED	R	0b	Reserved bits; Write only reset value

8.1.3.26 CLK_CFG14 Register (Address = 0x34) [Reset = 0x10]

CLK_CFG14 is shown in [Table 8-193](#).

Return to the [Summary Table](#).

This register is the clock configuration register 14.

Table 8-193. CLK_CFG14 Register Field Descriptions

Bit	Field	Type	Reset	Description
7-6	DIG_NM_DIV_CLK_SRC_SEL[1:0]	R/W	00b	Source clock selection for DIG NMDIV CLK clock. 0d = DIG NM divider input clock is Primary ASI BCLK 1d = DIG NM divider input clock is Secondary ASI BCLK 2d = DIG NM divider input clock is CCLK 3d = DIG NM divider input clock is internal oscillator clock (only supported in custom clock configuration)
5-4	ANA_NM_DIV_CLK_SRC_SEL[1:0]	R/W	01b	Source clock selection for NMDIV CLK clock. 0d = NM divider input clock is PLL Output 1d = NM divider input clock is PLL Output 2d = NM divider input clock is DIG NM Divider Clock Source 3d = NM divider input clock is Primary ASI BCLK (Low Jitter Path)
3-2	RESERVED	R	0b	Reserved bits; Write only reset values
1-0	RESERVED	R	0b	Reserved bits; Write only reset values

8.1.3.27 CLK_CFG15 Register (Address = 0x35) [Reset = 0x01]

CLK_CFG15 is shown in [Table 8-194](#).

Return to the [Summary Table](#).

This register is the clock configuration register 15.

Table 8-194. CLK_CFG15 Register Field Descriptions

Bit	Field	Type	Reset	Description
7-0	PLL_PDIV[7:0]	R/W	00000001b	PLL pre-scaler P-divisor value (Don't care when auto detection is enabled) 0d = PLL PDIV value is 256 1d = PLL PDIV value is 1 2d = PLL PDIV value is 2 3d to 254d = PLL PDIV value is as per configuration 255d = PLL PDIV value is 255

8.1.3.28 CLK_CFG16 Register (Address = 0x36) [Reset = 0x00]

CLK_CFG16 is shown in [Table 8-195](#).

Return to the [Summary Table](#).

This register is the clock configuration register 16.

Table 8-195. CLK_CFG16 Register Field Descriptions

Bit	Field	Type	Reset	Description
7	PLL_JMUL_MSB	R/W	0b	PLL integer portion J-multiplier value MSB bit. (Don't care when auto detection is enabled)
6	PLL_DIV_CLK_DIG_BY_2	R/W	0b	PLL DIV clock divide by 2 configuration 0d = No divide/2 inside PLL 1d = PLL does a divide/2
5-0	PLL_DMUL_MSB[5:0]	R/W	000000b	PLL fractional portion D-multiplier value MSB bits. (Don't care when auto detection is enabled)

8.1.3.29 CLK_CFG17 Register (Address = 0x37) [Reset = 0x00]

CLK_CFG17 is shown in [Table 8-196](#).

Return to the [Summary Table](#).

This register is the clock configuration register 17.

Table 8-196. CLK_CFG17 Register Field Descriptions

Bit	Field	Type	Reset	Description
7-0	PLL_DMUL_LSB[7:0]	R/W	00000000b	PLL fractional portion D-multiplier value LSB byte. Above D-multiplier value MSB bits (PLL_DMUL_MSB) along with this LSB byte (PLL_DMUL_LSB) is concatenated to determine final D-multiplier value. (Don't care when auto detection is enabled) 0d = PLL DMUL value is 0 1d = PLL DMUL value is 1 2d = PLL DMUL value is 2 3d to 9998d = PLL JMUL value is as per configuration 9999d = PLL JMUL value is 9999 10000d to 16383d = Reserved; Don't use

8.1.3.30 CLK_CFG18 Register (Address = 0x38) [Reset = 0x08]

CLK_CFG18 is shown in [Table 8-197](#).

Return to the [Summary Table](#).

This register is the clock configuration register 18.

Table 8-197. CLK_CFG18 Register Field Descriptions

Bit	Field	Type	Reset	Description
7-0	PLL_JMUL_LSB[7:0]	R/W	00001000b	PLL integer portion J-multiplier value LSB byte. Above J-multiplier value MSB bit (PLL_JMUL_MSB) along with this LSB byte (PLL_JMUL_LSB) is concatenated to determine final J-multiplier value. (Don't care when auto detection is enabled) 0d = Reserved; Don't use 1d = PLL JMUL value is 1 2d = PLL JMUL value is 2 3d to 510d = PLL JMUL value is as per configuration 511d = PLL JMUL value is 511

8.1.3.31 CLK_CFG19 Register (Address = 0x39) [Reset = 0x20]

CLK_CFG19 is shown in [Table 8-198](#).

Return to the [Summary Table](#).

This register is the clock configuration register 19.

Table 8-198. CLK_CFG19 Register Field Descriptions

Bit	Field	Type	Reset	Description
7-5	NDIV[2:0]	R/W	001b	NDIV divider value. (Don't care when auto detection is enabled) 0d = NDIV value is 8 1d = NDIV value is 1 2d = NDIV value is 2 3d to 6d = NDIV value is as per configuration 7d = NDIV value is 7
4-2	PDM_DIV[2:0]	R/W	000b	PDM divider value. (Don't care when auto detection is enabled) 0d = PDM_DIV value is 1 1d = PDM_DIV value is 2 2d = PDM_DIV value is 4 3d = PDM_DIV value is 8 4d = PDM_DIV value is 16 5d-7d Reserved
1-0	RESERVED	R	0b	Reserved bits; Write only reset values

8.1.3.32 CLK_CFG20 Register (Address = 0x3A) [Reset = 0x04]

CLK_CFG20 is shown in [Table 8-199](#).

Return to the [Summary Table](#).

This register is the clock configuration register 20.

Table 8-199. CLK_CFG20 Register Field Descriptions

Bit	Field	Type	Reset	Description
7-2	MDIV[5:0]	R/W	000001b	MDIV divider value. (Don't care when auto detection is enabled) 0d = MDIV value is 64 1d = MDIV value is 1 2d = MDIV value is 2 3d to 62d = MDIV value is as per configuration 63d = MDIV value is 63

Table 8-199. CLK_CFG20 Register Field Descriptions (continued)

Bit	Field	Type	Reset	Description
1-0	DIG_ADC_MODCLK_DIV[1:0]	R/W	00b	ADC modulator clock divider value. (Don't care when auto detection is enabled) 0d = DIG_ADC_MODCLK_DIV value is 1 1d = DIG_ADC_MODCLK_DIV value is 2 2d = DIG_ADC_MODCLK_DIV value is 4 3d = Reserved

8.1.3.33 CLK_CFG21 Register (Address = 0x3B) [Reset = 0x00]

CLK_CFG21 is shown in [Table 8-200](#).

Return to the [Summary Table](#).

This register is the clock configuration register 21.

Table 8-200. CLK_CFG21 Register Field Descriptions

Bit	Field	Type	Reset	Description
7-6	RESERVED	R	0b	Reserved bits; Write only reset values
5-4	DIG_DAC_MODCLK_DIV[1:0]	R/W	00b	DAC modulator clock divider value. (Don't care when auto detection is enabled) 0d = DIG_DAC_MODCLK_DIV value is 1 1d = DIG_DAC_MODCLK_DIV value is 2 2d = DIG_DAC_MODCLK_DIV value is 4 3d = Reserved
3	DAC_MODCLKx2_DIS	R/W	0b	DAC modulator clock select configuration. 0d = DAC MOD clock 2x enabled 1d = DAC MOD clock 2x disabled
2	PASI_BDIV_MSB	R/W	0b	Primary ASI BCLK divider value MSB bit. (Don't care when auto detection is enabled)
1	SASI_BDIV_MSB	R/W	0b	Secondary ASI BCLK divider value MSB bit. (Don't care when auto detection is enabled)
0	RESERVED	R	0b	Reserved bit; Write only reset value

8.1.3.34 CLK_CFG22 Register (Address = 0x3C) [Reset = 0x01]

CLK_CFG22 is shown in [Table 8-201](#).

Return to the [Summary Table](#).

This register is the clock configuration register 22.

Table 8-201. CLK_CFG22 Register Field Descriptions

Bit	Field	Type	Reset	Description
7-0	PASI_BDIV_LSB[7:0]	R/W	0000001b	Secondary ASI BCLK divider value. (Don't care when auto detection is enabled) 0d = SASI BCLK divider value is 512 1d = SASI BCLK divider value is 1 2d = SASI BCLK divider value is 2 3d to 62d = SASI BCLK divider value is as per configuration 63d = SASI BCLK divider value is 511

8.1.3.35 CLK_CFG23 Register (Address = 0x3D) [Reset = 0x01]

CLK_CFG23 is shown in [Table 8-202](#).

Return to the [Summary Table](#).

This register is the clock configuration register 23.

Table 8-202. CLK_CFG23 Register Field Descriptions

Bit	Field	Type	Reset	Description
7-0	SASI_BDIV_LSB[7:0]	R/W	00000001b	Secondary ASI BCLK divider value. (Don't care when auto detection is enabled) 0d = SASI BCLK divider value is 512 1d = SASI BCLK divider value is 1 2d = SASI BCLK divider value is 2 3d to 62d = SASI BCLK divider value is as per configuration 63d = SASI BCLK divider value is 511

8.1.3.36 CLK_CFG24 Register (Address = 0x3E) [Reset = 0x01]

CLK_CFG24 is shown in [Table 8-203](#).

Return to the [Summary Table](#).

This register is the clock configuration register 24.

Table 8-203. CLK_CFG24 Register Field Descriptions

Bit	Field	Type	Reset	Description
7-6	RESERVED	R	0b	Reserved bits; Write only reset value
5-0	ANA_NM_DIV[5:0]	R/W	000001b	Analog N-M DIV divider value. (Don't care when auto detection is enabled) 0d = ANA_NM_DIV value is 64 1d = ANA_NM_DIV value is 1 2d = ANA_NM_DIV value is 2 3d to 62d = ANA_NM_DIV value is as per configuration 63d = NDIV value is 63

8.1.3.37 CLK_CFG30 Register (Address = 0x44) [Reset = 0x00]

CLK_CFG30 is shown in [Table 8-204](#).

Return to the [Summary Table](#).

This register is the clock configuration register 30.

Table 8-204. CLK_CFG30 Register Field Descriptions

Bit	Field	Type	Reset	Description
7-3	RESERVED	R	0b	Reserved bits; Write only reset value
2	NDIV_EN	R/W	0b	NDIV divider enable 0d = divider disabled 1d = divider enabled
1	MDIV_EN	R/W	0b	MDIV divider enable 0d = divider disabled 1d = divider enabled
0	PDM_DIV_EN	R/W	0b	PDM divider enable 0d = divider disabled 1d = divider enabled

8.1.3.38 CLK_CFG31 Register (Address = 0x45) [Reset = 0x00]

CLK_CFG31 is shown in [Table 8-205](#).

Return to the [Summary Table](#).

This register is the clock configuration register 31.

Table 8-205. CLK_CFG31 Register Field Descriptions

Bit	Field	Type	Reset	Description
7	RESERVED	R	0b	Reserved bit; Write only reset value
6	DIG_ADC_MODCLK_DIV_EN	R/W	0b	ADC MODCLK divider enable 0d = divider disabled 1d = divider enabled
5	RESERVED	R	0b	Reserved bit; Write only reset value
4	DIG_DAC_MODCLK_DIV_EN	R/W	0b	DAC MODCLK divider enable 0d = divider disabled 1d = divider enabled
3	PASI_BDIV_EN	R/W	0b	PASI BDIV divider enable 0d = divider disabled 1d = divider enabled
2	SASI_BDIV_EN	R/W	0b	SASI BDIV divider enable 0d = divider disabled 1d = divider enabled
1	PASI_FSYNC_DIV_EN	R/W	0b	PASI FSYNC DIV divider enable 0d = divider disabled 1d = divider enabled
0	SASI_FSYNC_DIV_EN	R/W	0b	SASI FSYNC DIV divider enable 0d = divider disabled 1d = divider enabled

8.1.3.39 CLKOUT_CFG1 Register (Address = 0x46) [Reset = 0x00]

CLKOUT_CFG1 is shown in [Table 8-206](#).

Return to the [Summary Table](#).

This register is the CLKOUT configuration register 1.

Table 8-206. CLKOUT_CFG1 Register Field Descriptions

Bit	Field	Type	Reset	Description
7-3	RESERVED	R	0b	Reserved bits; Write only reset value
2-0	CLKOUT_CLK_SEL[2:0]	R/W	000b	General Purpose CLKOUT divider clock source selection. 0d = Source clock is PLL output 1d = Source clock is primary ASI BCLK 2d = Source clock is secondary ASI BCLK 3d = Source clock is CCLK 4d = Source clock is internal oscillator clock 5d = Source clock is DSP clock 6d to 7d = Reserved

8.1.3.40 CLKOUT_CFG2 Register (Address = 0x47) [Reset = 0x01]

CLKOUT_CFG2 is shown in [Table 8-207](#).

Return to the [Summary Table](#).

This register is the CLKOUT configuration register 2.

Table 8-207. CLKOUT_CFG2 Register Field Descriptions

Bit	Field	Type	Reset	Description
7	CLKOUT_DIV_EN	R/W	0b	CLKOUT divider enable. 0d = CLKOUT divider disabled 1d = CLKOUT divider enabled

Table 8-207. CLKOUT_CFG2 Register Field Descriptions (continued)

Bit	Field	Type	Reset	Description
6-0	CLKOUT_DIV[6:0]	R/W	0000001b	CLKOUT DIV divider value. 0d = CLKOUT_DIV value is 128 1d = CLKOUT_DIV value is 1 2d = CLKOUT_DIV value is 2 3d to 126d = CLKOUT_DIV value is as per configuration 127d = CLKOUT_DIV value is 127

8.1.3.41 SARCLK_CFG1 Register (Address = 0x49) [Reset = 0x00]

SARCLK_CFG1 is shown in [Table 8-208](#).

Return to the [Summary Table](#).

This register is the SAR clock configuration register 1

Table 8-208. SARCLK_CFG1 Register Field Descriptions

Bit	Field	Type	Reset	Description
7-6	SAR_CLK_FREQ_SEL[1:0]	R/W	00b	SAR clock frequency mode 0d = SAR clock frequency is ~6MHz 1d = SAR clock frequency is ~3MHz 2d = SAR clock frequency is ~1.5MHz 3d = SAR clock frequency is ~12MHz (valid only when SAR clock is generated directly using internal oscillator clock in custom clock configuration)
5	SAR_CLK_SRC_AUTO_DISABLE	R/W	0b	SAR divider source clock auto selection disable 0d = SAR divider source clock auto-selection based on clock detection scheme 1d = Reserved
4	SAR_CLK_SRC_MANUAL_SEL	R/W	0b	SAR clock source manual selection (don't care in auto mode) 0d = SAR clock generated based on Audio clock available for ADC/DAC 1d = SAR clock generated based on internal oscillator clock (only supported in custom clock configuration)
3	SAR_CLK_EN_AUTO_DISABLE	R/W	0b	SAR divider source clock auto selection disable 0d = SAR divider auto-enabled 1d = Reserved
2	SAR_CLK_MANUAL_EN	R/W	0b	SAR divider manual enable (don't care in auto mode) 0d = SAR divider disabled 1d = SAR divider enabled
1-0	SAR_CLK_MANUAL_DIV[1:0]	R/W	00b	SAR divider value (don't care in auto mode) 0d = SAR divider value is 1 1d = SAR divider value is 2 2d = SAR divider value is 4 3d = SAR divider value is 8

8.1.3.42 ADC_OVRD_FLAG Register (Address = 0x5B) [Reset = 0x00]

ADC_OVRD_FLAG is shown in [Table 8-209](#).

Return to the [Summary Table](#).

This is the ADC overload flag status register.

Table 8-209. ADC_OVRD_FLAG Register Field Descriptions

Bit	Field	Type	Reset	Description
7	ADC_CH1_OVRD_LTCH	R	0b	ADC CH1 OVRD fault (self clearing bit). 0b = No ADC CH1 OVRD fault 1b = ADC CH1 OVRD fault

Table 8-209. ADC_OVRD_FLAG Register Field Descriptions (continued)

Bit	Field	Type	Reset	Description
6	ADC_CH2_OVRD_LTCH	R	0b	ADC CH2 OVRD fault (self clearing bit). 0b = No ADC CH2 OVRD fault 1b = ADC CH2 OVRD fault
5	ADC_CH1_OVRD_LIVE	R	0b	ADC CH1 OVRD fault (self clearing bit). 0b = No ADC CH1 OVRD fault 1b = ADC CH1 OVRD fault
4	ADC_CH2_OVRD_LIVE	R	0b	ADC CH2 OVRD fault (self clearing bit). 0b = No ADC CH2 OVRD fault 1b = ADC CH2 OVRD fault
3-0	RESERVED	R	0b	Reserved bits; Write only reset value

8.2 Programmable Coefficient Registers

The register pages in this section consists of the programmable coefficients of the device. TI recommends using the PPC3 GUI for configuring the programmable coefficients settings; for more details see the [TAC5212EVM-PDK Evaluation module user's guide](#) and the [PurePath™ console graphical development suite](#). To optimize the coefficients register transaction time for the register pages in this section, the device also supports (by default) auto-incremented pages for the I²C and SPI burst writes and reads. After a transaction of register address 0x7F, the device auto increments to the next page at register 0x08 to transact the next coefficient value. These programmable coefficients are 32-bit, two's complement numbers. For a successful coefficient register transaction, the host device must write and read all four bytes starting with the most significant byte (BYT1) for a target coefficient register transaction. When using SPI for a coefficient register read transaction, the device transmits the first byte as a dummy read byte; therefore, the host must read five bytes, including the first dummy read byte and the last four bytes corresponding to the coefficient register value starting with the most significant byte (BYT1).

8.2.1 Programmable Coefficient Registers: Page 8

This register page shown in [Table 8-210](#) consists of the programmable coefficients for the ADC biquad 1 to biquad 6 filters.

Table 8-210. Page 8 Programmable Coefficient Registers

ADDRESS	REGISTER	RESET	DESCRIPTION
0x00	PAGE[7:0]	0x00	Device Page Register
0x08	ADC_BQ1_N0_BYT1[7:0]	0x7F	Programmable ADC biquad 1, N0 coefficient byte[31:24]
0x09	ADC_BQ1_N0_BYT2[7:0]	0xFF	Programmable ADC biquad 1, N0 coefficient byte[23:16]
0x0A	ADC_BQ1_N0_BYT3[7:0]	0xFF	Programmable ADC biquad 1, N0 coefficient byte[15:8]
0x0B	ADC_BQ1_N0_BYT4[7:0]	0xFF	Programmable ADC biquad 1, N0 coefficient byte[7:0]
0x0C	ADC_BQ1_N1_BYT1[7:0]	0x00	Programmable ADC biquad 1, N1 coefficient byte[31:24]
0x0D	ADC_BQ1_N1_BYT2[7:0]	0x00	Programmable ADC biquad 1, N1 coefficient byte[23:16]
0x0E	ADC_BQ1_N1_BYT3[7:0]	0x00	Programmable ADC biquad 1, N1 coefficient byte[15:8]
0x0F	ADC_BQ1_N1_BYT4[7:0]	0x00	Programmable ADC biquad 1, N1 coefficient byte[7:0]
0x10	ADC_BQ1_N2_BYT1[7:0]	0x00	Programmable ADC biquad 1, N2 coefficient byte[31:24]
0x11	ADC_BQ1_N2_BYT2[7:0]	0x00	Programmable ADC biquad 1, N2 coefficient byte[23:16]
0x12	ADC_BQ1_N2_BYT3[7:0]	0x00	Programmable ADC biquad 1, N2 coefficient byte[15:8]
0x13	ADC_BQ1_N2_BYT4[7:0]	0x00	Programmable ADC biquad 1, N2 coefficient byte[7:0]
0x14	ADC_BQ1_D1_BYT1[7:0]	0x00	Programmable ADC biquad 1, D1 coefficient byte[31:24]
0x15	ADC_BQ1_D1_BYT2[7:0]	0x00	Programmable ADC biquad 1, D1 coefficient byte[23:16]
0x16	ADC_BQ1_D1_BYT3[7:0]	0x00	Programmable ADC biquad 1, D1 coefficient byte[15:8]
0x17	ADC_BQ1_D1_BYT4[7:0]	0x00	Programmable ADC biquad 1, D1 coefficient byte[7:0]
0x18	ADC_BQ1_D2_BYT1[7:0]	0x00	Programmable ADC biquad 1, D2 coefficient byte[31:24]
0x19	ADC_BQ1_D2_BYT2[7:0]	0x00	Programmable ADC biquad 1, D2 coefficient byte[23:16]

Table 8-210. Page 8 Programmable Coefficient Registers (continued)

0x1A	ADC_BQ1_D2_BYT3[7:0]	0x00	Programmable ADC biquad 1, D2 coefficient byte[15:8]
0x1B	ADC_BQ1_D2_BYT4[7:0]	0x00	Programmable ADC biquad 1, D2 coefficient byte[7:0]
0x1C	ADC_BQ2_N0_BYT1[7:0]	0x7F	Programmable ADC biquad 2, N0 coefficient byte[31:24]
0x1D	ADC_BQ2_N0_BYT2[7:0]	0xFF	Programmable ADC biquad 2, N0 coefficient byte[23:16]
0x1E	ADC_BQ2_N0_BYT3[7:0]	0xFF	Programmable ADC biquad 2, N0 coefficient byte[15:8]
0x1F	ADC_BQ2_N0_BYT4[7:0]	0xFF	Programmable ADC biquad 2, N0 coefficient byte[7:0]
0x20	ADC_BQ2_N1_BYT1[7:0]	0x00	Programmable ADC biquad 2, N1 coefficient byte[31:24]
0x21	ADC_BQ2_N1_BYT2[7:0]	0x00	Programmable ADC biquad 2, N1 coefficient byte[23:16]
0x22	ADC_BQ2_N1_BYT3[7:0]	0x00	Programmable ADC biquad 2, N1 coefficient byte[15:8]
0x23	ADC_BQ2_N1_BYT4[7:0]	0x00	Programmable ADC biquad 2, N1 coefficient byte[7:0]
0x24	ADC_BQ2_N2_BYT1[7:0]	0x00	Programmable ADC biquad 2, N2 coefficient byte[31:24]
0x25	ADC_BQ2_N2_BYT2[7:0]	0x00	Programmable ADC biquad 2, N2 coefficient byte[23:16]
0x26	ADC_BQ2_N2_BYT3[7:0]	0x00	Programmable ADC biquad 2, N2 coefficient byte[15:8]
0x27	ADC_BQ2_N2_BYT4[7:0]	0x00	Programmable ADC biquad 2, N2 coefficient byte[7:0]
0x28	ADC_BQ2_D1_BYT1[7:0]	0x00	Programmable ADC biquad 2, D1 coefficient byte[31:24]
0x29	ADC_BQ2_D1_BYT2[7:0]	0x00	Programmable ADC biquad 2, D1 coefficient byte[23:16]
0x2A	ADC_BQ2_D1_BYT3[7:0]	0x00	Programmable ADC biquad 2, D1 coefficient byte[15:8]
0x2B	ADC_BQ2_D1_BYT4[7:0]	0x00	Programmable ADC biquad 2, D1 coefficient byte[7:0]
0x2C	ADC_BQ2_D2_BYT1[7:0]	0x00	Programmable ADC biquad 2, D2 coefficient byte[31:24]
0x2D	ADC_BQ2_D2_BYT2[7:0]	0x00	Programmable ADC biquad 2, D2 coefficient byte[23:16]
0x2E	ADC_BQ2_D2_BYT3[7:0]	0x00	Programmable ADC biquad 2, D2 coefficient byte[15:8]
0x2F	ADC_BQ2_D2_BYT4[7:0]	0x00	Programmable ADC biquad 2, D2 coefficient byte[7:0]
0x30	ADC_BQ3_N0_BYT1[7:0]	0x7F	Programmable ADC biquad 3, N0 coefficient byte[31:24]
0x31	ADC_BQ3_N0_BYT2[7:0]	0xFF	Programmable ADC biquad 3, N0 coefficient byte[23:16]
0x32	ADC_BQ3_N0_BYT3[7:0]	0xFF	Programmable ADC biquad 3, N0 coefficient byte[15:8]
0x33	ADC_BQ3_N0_BYT4[7:0]	0xFF	Programmable ADC biquad 3, N0 coefficient byte[7:0]
0x34	ADC_BQ3_N1_BYT1[7:0]	0x00	Programmable ADC biquad 3, N1 coefficient byte[31:24]
0x35	ADC_BQ3_N1_BYT2[7:0]	0x00	Programmable ADC biquad 3, N1 coefficient byte[23:16]
0x36	ADC_BQ3_N1_BYT3[7:0]	0x00	Programmable ADC biquad 3, N1 coefficient byte[15:8]
0x37	ADC_BQ3_N1_BYT4[7:0]	0x00	Programmable ADC biquad 3, N1 coefficient byte[7:0]
0x38	ADC_BQ3_N2_BYT1[7:0]	0x00	Programmable ADC biquad 3, N2 coefficient byte[31:24]
0x39	ADC_BQ3_N2_BYT2[7:0]	0x00	Programmable ADC biquad 3, N2 coefficient byte[23:16]
0x3A	ADC_BQ3_N2_BYT3[7:0]	0x00	Programmable ADC biquad 3, N2 coefficient byte[15:8]
0x3B	ADC_BQ3_N2_BYT4[7:0]	0x00	Programmable ADC biquad 3, N2 coefficient byte[7:0]
0x3C	ADC_BQ3_D1_BYT1[7:0]	0x00	Programmable ADC biquad 3, D1 coefficient byte[31:24]
0x3D	ADC_BQ3_D1_BYT2[7:0]	0x00	Programmable ADC biquad 3, D1 coefficient byte[23:16]
0x3E	ADC_BQ3_D1_BYT3[7:0]	0x00	Programmable ADC biquad 3, D1 coefficient byte[15:8]
0x3F	ADC_BQ3_D1_BYT4[7:0]	0x00	Programmable ADC biquad 3, D1 coefficient byte[7:0]
0x40	ADC_BQ3_D2_BYT1[7:0]	0x00	Programmable ADC biquad 3, D2 coefficient byte[31:24]
0x41	ADC_BQ3_D2_BYT2[7:0]	0x00	Programmable ADC biquad 3, D2 coefficient byte[23:16]
0x42	ADC_BQ3_D2_BYT3[7:0]	0x00	Programmable ADC biquad 3, D2 coefficient byte[15:8]
0x43	ADC_BQ3_D2_BYT4[7:0]	0x00	Programmable ADC biquad 3, D2 coefficient byte[7:0]
0x44	ADC_BQ4_N0_BYT1[7:0]	0x7F	Programmable ADC biquad 4, N0 coefficient byte[31:24]
0x45	ADC_BQ4_N0_BYT2[7:0]	0xFF	Programmable ADC biquad 4, N0 coefficient byte[23:16]
0x46	ADC_BQ4_N0_BYT3[7:0]	0xFF	Programmable ADC biquad 4, N0 coefficient byte[15:8]
0x47	ADC_BQ4_N0_BYT4[7:0]	0xFF	Programmable ADC biquad 4, N0 coefficient byte[7:0]

Table 8-210. Page 8 Programmable Coefficient Registers (continued)

0x48	ADC_BQ4_N1_BYT1[7:0]	0x00	Programmable ADC biquad 4, N1 coefficient byte[31:24]
0x49	ADC_BQ4_N1_BYT2[7:0]	0x00	Programmable ADC biquad 4, N1 coefficient byte[23:16]
0x4A	ADC_BQ4_N1_BYT3[7:0]	0x00	Programmable ADC biquad 4, N1 coefficient byte[15:8]
0x4B	ADC_BQ4_N1_BYT4[7:0]	0x00	Programmable ADC biquad 4, N1 coefficient byte[7:0]
0x4C	ADC_BQ4_N2_BYT1[7:0]	0x00	Programmable ADC biquad 4, N2 coefficient byte[31:24]
0x4D	ADC_BQ4_N2_BYT2[7:0]	0x00	Programmable ADC biquad 4, N2 coefficient byte[23:16]
0x4E	ADC_BQ4_N2_BYT3[7:0]	0x00	Programmable ADC biquad 4, N2 coefficient byte[15:8]
0x4F	ADC_BQ4_N2_BYT4[7:0]	0x00	Programmable ADC biquad 4, N2 coefficient byte[7:0]
0x50	ADC_BQ4_D1_BYT1[7:0]	0x00	Programmable ADC biquad 4, D1 coefficient byte[31:24]
0x51	ADC_BQ4_D1_BYT2[7:0]	0x00	Programmable ADC biquad 4, D1 coefficient byte[23:16]
0x52	ADC_BQ4_D1_BYT3[7:0]	0x00	Programmable ADC biquad 4, D1 coefficient byte[15:8]
0x53	ADC_BQ4_D1_BYT4[7:0]	0x00	Programmable ADC biquad 4, D1 coefficient byte[7:0]
0x54	ADC_BQ4_D2_BYT1[7:0]	0x00	Programmable ADC biquad 4, D2 coefficient byte[31:24]
0x55	ADC_BQ4_D2_BYT2[7:0]	0x00	Programmable ADC biquad 4, D2 coefficient byte[23:16]
0x56	ADC_BQ4_D2_BYT3[7:0]	0x00	Programmable ADC biquad 4, D2 coefficient byte[15:8]
0x57	ADC_BQ4_D2_BYT4[7:0]	0x00	Programmable ADC biquad 4, D2 coefficient byte[7:0]
0x58	ADC_BQ5_N0_BYT1[7:0]	0x7F	Programmable ADC biquad 5, N0 coefficient byte[31:24]
0x59	ADC_BQ5_N0_BYT2[7:0]	0xFF	Programmable ADC biquad 5, N0 coefficient byte[23:16]
0x5A	ADC_BQ5_N0_BYT3[7:0]	0xFF	Programmable ADC biquad 5, N0 coefficient byte[15:8]
0x5B	ADC_BQ5_N0_BYT4[7:0]	0xFF	Programmable ADC biquad 5, N0 coefficient byte[7:0]
0x5C	ADC_BQ5_N1_BYT1[7:0]	0x00	Programmable ADC biquad 5, N1 coefficient byte[31:24]
0x5D	ADC_BQ5_N1_BYT2[7:0]	0x00	Programmable ADC biquad 5, N1 coefficient byte[23:16]
0x5E	ADC_BQ5_N1_BYT3[7:0]	0x00	Programmable ADC biquad 5, N1 coefficient byte[15:8]
0x5F	ADC_BQ5_N1_BYT4[7:0]	0x00	Programmable ADC biquad 5, N1 coefficient byte[7:0]
0x60	ADC_BQ5_N2_BYT1[7:0]	0x00	Programmable ADC biquad 5, N2 coefficient byte[31:24]
0x61	ADC_BQ5_N2_BYT2[7:0]	0x00	Programmable ADC biquad 5, N2 coefficient byte[23:16]
0x62	ADC_BQ5_N2_BYT3[7:0]	0x00	Programmable ADC biquad 5, N2 coefficient byte[15:8]
0x63	ADC_BQ5_N2_BYT4[7:0]	0x00	Programmable ADC biquad 5, N2 coefficient byte[7:0]
0x64	ADC_BQ5_D1_BYT1[7:0]	0x00	Programmable ADC biquad 5, D1 coefficient byte[31:24]
0x65	ADC_BQ5_D1_BYT2[7:0]	0x00	Programmable ADC biquad 5, D1 coefficient byte[23:16]
0x66	ADC_BQ5_D1_BYT3[7:0]	0x00	Programmable ADC biquad 5, D1 coefficient byte[15:8]
0x67	ADC_BQ5_D1_BYT4[7:0]	0x00	Programmable ADC biquad 5, D1 coefficient byte[7:0]
0x68	ADC_BQ5_D2_BYT1[7:0]	0x00	Programmable ADC biquad 5, D2 coefficient byte[31:24]
0x69	ADC_BQ5_D2_BYT2[7:0]	0x00	Programmable ADC biquad 5, D2 coefficient byte[23:16]
0x6A	ADC_BQ5_D2_BYT3[7:0]	0x00	Programmable ADC biquad 5, D2 coefficient byte[15:8]
0x6B	ADC_BQ5_D2_BYT4[7:0]	0x00	Programmable ADC biquad 5, D2 coefficient byte[7:0]
0x6C	ADC_BQ6_N0_BYT1[7:0]	0x7F	Programmable ADC biquad 6, N0 coefficient byte[31:24]
0x6D	ADC_BQ6_N0_BYT2[7:0]	0xFF	Programmable ADC biquad 6, N0 coefficient byte[23:16]
0x6E	ADC_BQ6_N0_BYT3[7:0]	0xFF	Programmable ADC biquad 6, N0 coefficient byte[15:8]
0x6F	ADC_BQ6_N0_BYT4[7:0]	0xFF	Programmable ADC biquad 6, N0 coefficient byte[7:0]
0x70	ADC_BQ6_N1_BYT1[7:0]	0x00	Programmable ADC biquad 6, N1 coefficient byte[31:24]
0x71	ADC_BQ6_N1_BYT2[7:0]	0x00	Programmable ADC biquad 6, N1 coefficient byte[23:16]
0x72	ADC_BQ6_N1_BYT3[7:0]	0x00	Programmable ADC biquad 6, N1 coefficient byte[15:8]
0x73	ADC_BQ6_N1_BYT4[7:0]	0x00	Programmable ADC biquad 6, N1 coefficient byte[7:0]
0x74	ADC_BQ6_N2_BYT1[7:0]	0x00	Programmable ADC biquad 6, N2 coefficient byte[31:24]
0x75	ADC_BQ6_N2_BYT2[7:0]	0x00	Programmable ADC biquad 6, N2 coefficient byte[23:16]

Table 8-210. Page 8 Programmable Coefficient Registers (continued)

0x76	ADC_BQ6_N2_BYT3[7:0]	0x00	Programmable ADC biquad 6, N2 coefficient byte[15:8]
0x77	ADC_BQ6_N2_BYT4[7:0]	0x00	Programmable ADC biquad 6, N2 coefficient byte[7:0]
0x78	ADC_BQ6_D1_BYT1[7:0]	0x00	Programmable ADC biquad 6, D1 coefficient byte[31:24]
0x79	ADC_BQ6_D1_BYT2[7:0]	0x00	Programmable ADC biquad 6, D1 coefficient byte[23:16]
0x7A	ADC_BQ6_D1_BYT3[7:0]	0x00	Programmable ADC biquad 6, D1 coefficient byte[15:8]
0x7B	ADC_BQ6_D1_BYT4[7:0]	0x00	Programmable ADC biquad 6, D1 coefficient byte[7:0]
0x7C	ADC_BQ6_D2_BYT1[7:0]	0x00	Programmable ADC biquad 6, D2 coefficient byte[31:24]
0x7D	ADC_BQ6_D2_BYT2[7:0]	0x00	Programmable ADC biquad 6, D2 coefficient byte[23:16]
0x7E	ADC_BQ6_D2_BYT3[7:0]	0x00	Programmable ADC biquad 6, D2 coefficient byte[15:8]
0x7F	ADC_BQ6_D2_BYT4[7:0]	0x00	Programmable ADC biquad 6, D2 coefficient byte[7:0]

8.2.2 Programmable Coefficient Registers: Page 9

This register page shown in [Table 8-211](#) consists of the programmable coefficients for the ADC biquad 7 to biquad 12 filters.

Table 8-211. Page 9 Programmable Coefficient Registers

ADDRESS	REGISTER	RESET	DESCRIPTION
0x00	PAGE[7:0]	0x00	Device Page Register
0x08	ADC_BQ7_N0_BYT1[7:0]	0x7F	Programmable ADC biquad 7, N0 coefficient byte[31:24]
0x09	ADC_BQ7_N0_BYT2[7:0]	0xFF	Programmable ADC biquad 7, N0 coefficient byte[23:16]
0x0A	ADC_BQ7_N0_BYT3[7:0]	0xFF	Programmable ADC biquad 7, N0 coefficient byte[15:8]
0x0B	ADC_BQ7_N0_BYT4[7:0]	0xFF	Programmable ADC biquad 7, N0 coefficient byte[7:0]
0x0C	ADC_BQ7_N1_BYT1[7:0]	0x00	Programmable ADC biquad 7, N1 coefficient byte[31:24]
0x0D	ADC_BQ7_N1_BYT2[7:0]	0x00	Programmable ADC biquad 7, N1 coefficient byte[23:16]
0x0E	ADC_BQ7_N1_BYT3[7:0]	0x00	Programmable ADC biquad 7, N1 coefficient byte[15:8]
0x0F	ADC_BQ7_N1_BYT4[7:0]	0x00	Programmable ADC biquad 7, N1 coefficient byte[7:0]
0x10	ADC_BQ7_N2_BYT1[7:0]	0x00	Programmable ADC biquad 7, N2 coefficient byte[31:24]
0x11	ADC_BQ7_N2_BYT2[7:0]	0x00	Programmable ADC biquad 7, N2 coefficient byte[23:16]
0x12	ADC_BQ7_N2_BYT3[7:0]	0x00	Programmable ADC biquad 7, N2 coefficient byte[15:8]
0x13	ADC_BQ7_N2_BYT4[7:0]	0x00	Programmable ADC biquad 7, N2 coefficient byte[7:0]
0x14	ADC_BQ7_D1_BYT1[7:0]	0x00	Programmable ADC biquad 7, D1 coefficient byte[31:24]
0x15	ADC_BQ7_D1_BYT2[7:0]	0x00	Programmable ADC biquad 7, D1 coefficient byte[23:16]
0x16	ADC_BQ7_D1_BYT3[7:0]	0x00	Programmable ADC biquad 7, D1 coefficient byte[15:8]
0x17	ADC_BQ7_D1_BYT4[7:0]	0x00	Programmable ADC biquad 7, D1 coefficient byte[7:0]
0x18	ADC_BQ7_D2_BYT1[7:0]	0x00	Programmable ADC biquad 7, D2 coefficient byte[31:24]
0x19	ADC_BQ7_D2_BYT2[7:0]	0x00	Programmable ADC biquad 7, D2 coefficient byte[23:16]
0x1A	ADC_BQ7_D2_BYT3[7:0]	0x00	Programmable ADC biquad 7, D2 coefficient byte[15:8]
0x1B	ADC_BQ7_D2_BYT4[7:0]	0x00	Programmable ADC biquad 7, D2 coefficient byte[7:0]
0x1C	ADC_BQ8_N0_BYT1[7:0]	0x7F	Programmable ADC biquad 8, N0 coefficient byte[31:24]
0x1D	ADC_BQ8_N0_BYT2[7:0]	0xFF	Programmable ADC biquad 8, N0 coefficient byte[23:16]
0x1E	ADC_BQ8_N0_BYT3[7:0]	0xFF	Programmable ADC biquad 8, N0 coefficient byte[15:8]
0x1F	ADC_BQ8_N0_BYT4[7:0]	0xFF	Programmable ADC biquad 8, N0 coefficient byte[7:0]
0x20	ADC_BQ8_N1_BYT1[7:0]	0x00	Programmable ADC biquad 8, N1 coefficient byte[31:24]
0x21	ADC_BQ8_N1_BYT2[7:0]	0x00	Programmable ADC biquad 8, N1 coefficient byte[23:16]
0x22	ADC_BQ8_N1_BYT3[7:0]	0x00	Programmable ADC biquad 8, N1 coefficient byte[15:8]
0x23	ADC_BQ8_N1_BYT4[7:0]	0x00	Programmable ADC biquad 8, N1 coefficient byte[7:0]
0x24	ADC_BQ8_N2_BYT1[7:0]	0x00	Programmable ADC biquad 8, N2 coefficient byte[31:24]

Table 8-211. Page 9 Programmable Coefficient Registers (continued)

0x25	ADC_BQ8_N2_BYT2[7:0]	0x00	Programmable ADC biquad 8, N2 coefficient byte[23:16]
0x26	ADC_BQ8_N2_BYT3[7:0]	0x00	Programmable ADC biquad 8, N2 coefficient byte[15:8]
0x27	ADC_BQ8_N2_BYT4[7:0]	0x00	Programmable ADC biquad 8, N2 coefficient byte[7:0]
0x28	ADC_BQ8_D1_BYT1[7:0]	0x00	Programmable ADC biquad 8, D1 coefficient byte[31:24]
0x29	ADC_BQ8_D1_BYT2[7:0]	0x00	Programmable ADC biquad 8, D1 coefficient byte[23:16]
0x2A	ADC_BQ8_D1_BYT3[7:0]	0x00	Programmable ADC biquad 8, D1 coefficient byte[15:8]
0x2B	ADC_BQ8_D1_BYT4[7:0]	0x00	Programmable ADC biquad 8, D1 coefficient byte[7:0]
0x2C	ADC_BQ8_D2_BYT1[7:0]	0x00	Programmable ADC biquad 8, D2 coefficient byte[31:24]
0x2D	ADC_BQ8_D2_BYT2[7:0]	0x00	Programmable ADC biquad 8, D2 coefficient byte[23:16]
0x2E	ADC_BQ8_D2_BYT3[7:0]	0x00	Programmable ADC biquad 8, D2 coefficient byte[15:8]
0x2F	ADC_BQ8_D2_BYT4[7:0]	0x00	Programmable ADC biquad 8, D2 coefficient byte[7:0]
0x30	ADC_BQ9_N0_BYT1[7:0]	0x7F	Programmable ADC biquad 9, N0 coefficient byte[31:24]
0x31	ADC_BQ9_N0_BYT2[7:0]	0xFF	Programmable ADC biquad 9, N0 coefficient byte[23:16]
0x32	ADC_BQ9_N0_BYT3[7:0]	0xFF	Programmable ADC biquad 9, N0 coefficient byte[15:8]
0x33	ADC_BQ9_N0_BYT4[7:0]	0xFF	Programmable ADC biquad 9, N0 coefficient byte[7:0]
0x34	ADC_BQ9_N1_BYT1[7:0]	0x00	Programmable ADC biquad 9, N1 coefficient byte[31:24]
0x35	ADC_BQ9_N1_BYT2[7:0]	0x00	Programmable ADC biquad 9, N1 coefficient byte[23:16]
0x36	ADC_BQ9_N1_BYT3[7:0]	0x00	Programmable ADC biquad 9, N1 coefficient byte[15:8]
0x37	ADC_BQ9_N1_BYT4[7:0]	0x00	Programmable ADC biquad 9, N1 coefficient byte[7:0]
0x38	ADC_BQ9_N2_BYT1[7:0]	0x00	Programmable ADC biquad 9, N2 coefficient byte[31:24]
0x39	ADC_BQ9_N2_BYT2[7:0]	0x00	Programmable ADC biquad 9, N2 coefficient byte[23:16]
0x3A	ADC_BQ9_N2_BYT3[7:0]	0x00	Programmable ADC biquad 9, N2 coefficient byte[15:8]
0x3B	ADC_BQ9_N2_BYT4[7:0]	0x00	Programmable ADC biquad 9, N2 coefficient byte[7:0]
0x3C	ADC_BQ9_D1_BYT1[7:0]	0x00	Programmable ADC biquad 9, D1 coefficient byte[31:24]
0x3D	ADC_BQ9_D1_BYT2[7:0]	0x00	Programmable ADC biquad 9, D1 coefficient byte[23:16]
0x3E	ADC_BQ9_D1_BYT3[7:0]	0x00	Programmable ADC biquad 9, D1 coefficient byte[15:8]
0x3F	ADC_BQ9_D1_BYT4[7:0]	0x00	Programmable ADC biquad 9, D1 coefficient byte[7:0]
0x40	ADC_BQ9_D2_BYT1[7:0]	0x00	Programmable ADC biquad 9, D2 coefficient byte[31:24]
0x41	ADC_BQ9_D2_BYT2[7:0]	0x00	Programmable ADC biquad 9, D2 coefficient byte[23:16]
0x42	ADC_BQ9_D2_BYT3[7:0]	0x00	Programmable ADC biquad 9, D2 coefficient byte[15:8]
0x43	ADC_BQ9_D2_BYT4[7:0]	0x00	Programmable ADC biquad 9, D2 coefficient byte[7:0]
0x44	ADC_BQ10_N0_BYT1[7:0]	0x7F	Programmable ADC biquad 10, N0 coefficient byte[31:24]
0x45	ADC_BQ10_N0_BYT2[7:0]	0xFF	Programmable ADC biquad 10, N0 coefficient byte[23:16]
0x46	ADC_BQ10_N0_BYT3[7:0]	0xFF	Programmable ADC biquad 10, N0 coefficient byte[15:8]
0x47	ADC_BQ10_N0_BYT4[7:0]	0xFF	Programmable ADC biquad 10, N0 coefficient byte[7:0]
0x48	ADC_BQ10_N1_BYT1[7:0]	0x00	Programmable ADC biquad 10, N1 coefficient byte[31:24]
0x49	ADC_BQ10_N1_BYT2[7:0]	0x00	Programmable ADC biquad 10, N1 coefficient byte[23:16]
0x4A	ADC_BQ10_N1_BYT3[7:0]	0x00	Programmable ADC biquad 10, N1 coefficient byte[15:8]
0x4B	ADC_BQ10_N1_BYT4[7:0]	0x00	Programmable ADC biquad 10, N1 coefficient byte[7:0]
0x4C	ADC_BQ10_N2_BYT1[7:0]	0x00	Programmable ADC biquad 10, N2 coefficient byte[31:24]
0x4D	ADC_BQ10_N2_BYT2[7:0]	0x00	Programmable ADC biquad 10, N2 coefficient byte[23:16]
0x4E	ADC_BQ10_N2_BYT3[7:0]	0x00	Programmable ADC biquad 10, N2 coefficient byte[15:8]
0x4F	ADC_BQ10_N2_BYT4[7:0]	0x00	Programmable ADC biquad 10, N2 coefficient byte[7:0]
0x50	ADC_BQ10_D1_BYT1[7:0]	0x00	Programmable ADC biquad 10, D1 coefficient byte[31:24]
0x51	ADC_BQ10_D1_BYT2[7:0]	0x00	Programmable ADC biquad 10, D1 coefficient byte[23:16]
0x52	ADC_BQ10_D1_BYT3[7:0]	0x00	Programmable ADC biquad 10, D1 coefficient byte[15:8]

Table 8-211. Page 9 Programmable Coefficient Registers (continued)

0x53	ADC_BQ10_D1_BYT4[7:0]	0x00	Programmable ADC biquad 10, D1 coefficient byte[7:0]
0x54	ADC_BQ10_D2_BYT1[7:0]	0x00	Programmable ADC biquad 10, D2 coefficient byte[31:24]
0x55	ADC_BQ10_D2_BYT2[7:0]	0x00	Programmable ADC biquad 10, D2 coefficient byte[23:16]
0x56	ADC_BQ10_D2_BYT3[7:0]	0x00	Programmable ADC biquad 10, D2 coefficient byte[15:8]
0x57	ADC_BQ10_D2_BYT4[7:0]	0x00	Programmable ADC biquad 10, D2 coefficient byte[7:0]
0x58	ADC_BQ11_N0_BYT1[7:0]	0x7F	Programmable ADC biquad 11, N0 coefficient byte[31:24]
0x59	ADC_BQ11_N0_BYT2[7:0]	0xFF	Programmable ADC biquad 11, N0 coefficient byte[23:16]
0x5A	ADC_BQ11_N0_BYT3[7:0]	0xFF	Programmable ADC biquad 11, N0 coefficient byte[15:8]
0x5B	ADC_BQ11_N0_BYT4[7:0]	0xFF	Programmable ADC biquad 11, N0 coefficient byte[7:0]
0x5C	ADC_BQ11_N1_BYT1[7:0]	0x00	Programmable ADC biquad 11, N1 coefficient byte[31:24]
0x5D	ADC_BQ11_N1_BYT2[7:0]	0x00	Programmable ADC biquad 11, N1 coefficient byte[23:16]
0x5E	ADC_BQ11_N1_BYT3[7:0]	0x00	Programmable ADC biquad 11, N1 coefficient byte[15:8]
0x5F	ADC_BQ11_N1_BYT4[7:0]	0x00	Programmable ADC biquad 11, N1 coefficient byte[7:0]
0x60	ADC_BQ11_N2_BYT1[7:0]	0x00	Programmable ADC biquad 11, N2 coefficient byte[31:24]
0x61	ADC_BQ11_N2_BYT2[7:0]	0x00	Programmable ADC biquad 11, N2 coefficient byte[23:16]
0x62	ADC_BQ11_N2_BYT3[7:0]	0x00	Programmable ADC biquad 11, N2 coefficient byte[15:8]
0x63	ADC_BQ11_N2_BYT4[7:0]	0x00	Programmable ADC biquad 11, N2 coefficient byte[7:0]
0x64	ADC_BQ11_D1_BYT1[7:0]	0x00	Programmable ADC biquad 11, D1 coefficient byte[31:24]
0x65	ADC_BQ11_D1_BYT2[7:0]	0x00	Programmable ADC biquad 11, D1 coefficient byte[23:16]
0x66	ADC_BQ11_D1_BYT3[7:0]	0x00	Programmable ADC biquad 11, D1 coefficient byte[15:8]
0x67	ADC_BQ11_D1_BYT4[7:0]	0x00	Programmable ADC biquad 11, D1 coefficient byte[7:0]
0x68	ADC_BQ11_D2_BYT1[7:0]	0x00	Programmable ADC biquad 11, D2 coefficient byte[31:24]
0x69	ADC_BQ11_D2_BYT2[7:0]	0x00	Programmable ADC biquad 11, D2 coefficient byte[23:16]
0x6A	ADC_BQ11_D2_BYT3[7:0]	0x00	Programmable ADC biquad 11, D2 coefficient byte[15:8]
0x6B	ADC_BQ11_D2_BYT4[7:0]	0x00	Programmable ADC biquad 11, D2 coefficient byte[7:0]
0x6C	ADC_BQ12_N0_BYT1[7:0]	0x7F	Programmable ADC biquad 12, N0 coefficient byte[31:24]
0x6D	ADC_BQ12_N0_BYT2[7:0]	0xFF	Programmable ADC biquad 12, N0 coefficient byte[23:16]
0x6E	ADC_BQ12_N0_BYT3[7:0]	0xFF	Programmable ADC biquad 12, N0 coefficient byte[15:8]
0x6F	ADC_BQ12_N0_BYT4[7:0]	0xFF	Programmable ADC biquad 12, N0 coefficient byte[7:0]
0x70	ADC_BQ12_N1_BYT1[7:0]	0x00	Programmable ADC biquad 12, N1 coefficient byte[31:24]
0x71	ADC_BQ12_N1_BYT2[7:0]	0x00	Programmable ADC biquad 12, N1 coefficient byte[23:16]
0x72	ADC_BQ12_N1_BYT3[7:0]	0x00	Programmable ADC biquad 12, N1 coefficient byte[15:8]
0x73	ADC_BQ12_N1_BYT4[7:0]	0x00	Programmable ADC biquad 12, N1 coefficient byte[7:0]
0x74	ADC_BQ12_N2_BYT1[7:0]	0x00	Programmable ADC biquad 12, N2 coefficient byte[31:24]
0x75	ADC_BQ12_N2_BYT2[7:0]	0x00	Programmable ADC biquad 12, N2 coefficient byte[23:16]
0x76	ADC_BQ12_N2_BYT3[7:0]	0x00	Programmable ADC biquad 12, N2 coefficient byte[15:8]
0x77	ADC_BQ12_N2_BYT4[7:0]	0x00	Programmable ADC biquad 12, N2 coefficient byte[7:0]
0x78	ADC_BQ12_D1_BYT1[7:0]	0x00	Programmable ADC biquad 12, D1 coefficient byte[31:24]
0x79	ADC_BQ12_D1_BYT2[7:0]	0x00	Programmable ADC biquad 12, D1 coefficient byte[23:16]
0x7A	ADC_BQ12_D1_BYT3[7:0]	0x00	Programmable ADC biquad 12, D1 coefficient byte[15:8]
0x7B	ADC_BQ12_D1_BYT4[7:0]	0x00	Programmable ADC biquad 12, D1 coefficient byte[7:0]
0x7C	ADC_BQ12_D2_BYT1[7:0]	0x00	Programmable ADC biquad 12, D2 coefficient byte[31:24]
0x7D	ADC_BQ12_D2_BYT2[7:0]	0x00	Programmable ADC biquad 12, D2 coefficient byte[23:16]
0x7E	ADC_BQ12_D2_BYT3[7:0]	0x00	Programmable ADC biquad 12, D2 coefficient byte[15:8]
0x7F	ADC_BQ12_D2_BYT4[7:0]	0x00	Programmable ADC biquad 12, D2 coefficient byte[7:0]

8.2.3 Programmable Coefficient Registers: Page 10

This register page shown in [Table 8-212](#) consists of the programmable coefficients for the ADC mixer 1 to 4, ADC to DAC loopback mixer and the ADC first-order IIR filter. All channel mixer coefficients are 32-bit, two's complement numbers using a 1.31 number format. The value of 0x7FFFFFFF is equivalent to +1 (0-dB gain), the value 0x00000000 is equivalent to mute (zero data) and all values in between set the mixer attenuation computed accordingly ($hex2dec(value)/2^{31}$). If the MSB is set to '1' then the attenuation remains the same but the signal phase is inverted.

Table 8-212. Page 10 Programmable Coefficient Registers

ADDRESS	REGISTER	RESET	DESCRIPTION
0x00	PAGE[7:0]	0x00	Device Page Register
0x08	ADC_MIX1_CH1_BYT1[7:0]	0x7F	Digital mixer 1, ADC channel 1 coefficient byte[31:24]
0x09	ADC_MIX1_CH1_BYT2[7:0]	0xFF	Digital mixer 1, ADC channel 1 coefficient byte[23:16]
0x0A	ADC_MIX1_CH1_BYT3[7:0]	0xFF	Digital mixer 1, ADC channel 1 coefficient byte[15:8]
0x0B	ADC_MIX1_CH1_BYT4[7:0]	0xFF	Digital mixer 1, ADC channel 1 coefficient byte[7:0]
0x0C	ADC_MIX1_CH2_BYT1[7:0]	0x00	Digital mixer 1, ADC channel 2 coefficient byte[31:24]
0x0D	ADC_MIX1_CH2_BYT2[7:0]	0x00	Digital mixer 1, ADC channel 2 coefficient byte[23:16]
0x0E	ADC_MIX1_CH2_BYT3[7:0]	0x00	Digital mixer 1, ADC channel 2 coefficient byte[15:8]
0x0F	ADC_MIX1_CH2_BYT4[7:0]	0x00	Digital mixer 1, ADC channel 2 coefficient byte[7:0]
0x10	ADC_MIX1_CH3_BYT1[7:0]	0x00	Digital mixer 1, ADC channel 3 coefficient byte[31:24]
0x11	ADC_MIX1_CH3_BYT2[7:0]	0x00	Digital mixer 1, ADC channel 3 coefficient byte[23:16]
0x12	ADC_MIX1_CH3_BYT3[7:0]	0x00	Digital mixer 1, ADC channel 3 coefficient byte[15:8]
0x13	ADC_MIX1_CH3_BYT4[7:0]	0x00	Digital mixer 1, ADC channel 3 coefficient byte[7:0]
0x14	ADC_MIX1_CH4_BYT1[7:0]	0x00	Digital mixer 1, ADC channel 4 coefficient byte[31:24]
0x15	ADC_MIX1_CH4_BYT2[7:0]	0x00	Digital mixer 1, ADC channel 4 coefficient byte[23:16]
0x16	ADC_MIX1_CH4_BYT3[7:0]	0x00	Digital mixer 1, ADC channel 4 coefficient byte[15:8]
0x17	ADC_MIX1_CH4_BYT4[7:0]	0x00	Digital mixer 1, ADC channel 4 coefficient byte[7:0]
0x18	ADC_MIX2_CH1_BYT1[7:0]	0x00	Digital mixer 2, ADC channel 1 coefficient byte[31:24]
0x19	ADC_MIX2_CH1_BYT2[7:0]	0x00	Digital mixer 2, ADC channel 1 coefficient byte[23:16]
0x1A	ADC_MIX2_CH1_BYT3[7:0]	0x00	Digital mixer 2, ADC channel 1 coefficient byte[15:8]
0x1B	ADC_MIX2_CH1_BYT4[7:0]	0x00	Digital mixer 2, ADC channel 1 coefficient byte[7:0]
0x1C	ADC_MIX2_CH2_BYT1[7:0]	0x7F	Digital mixer 2, ADC channel 2 coefficient byte[31:24]
0x1D	ADC_MIX2_CH2_BYT2[7:0]	0xFF	Digital mixer 2, ADC channel 2 coefficient byte[23:16]
0x1E	ADC_MIX2_CH2_BYT3[7:0]	0xFF	Digital mixer 2, ADC channel 2 coefficient byte[15:8]
0x1F	ADC_MIX2_CH2_BYT4[7:0]	0xFF	Digital mixer 2, ADC channel 2 coefficient byte[7:0]
0x20	ADC_MIX2_CH3_BYT1[7:0]	0x00	Digital mixer 2, ADC channel 3 coefficient byte[31:24]
0x21	ADC_MIX2_CH3_BYT2[7:0]	0x00	Digital mixer 2, ADC channel 3 coefficient byte[23:16]
0x22	ADC_MIX2_CH3_BYT3[7:0]	0x00	Digital mixer 2, ADC channel 3 coefficient byte[15:8]
0x23	ADC_MIX2_CH3_BYT4[7:0]	0x00	Digital mixer 2, ADC channel 3 coefficient byte[7:0]
0x24	ADC_MIX2_CH4_BYT1[7:0]	0x00	Digital mixer 2, ADC channel 4 coefficient byte[31:24]
0x25	ADC_MIX2_CH4_BYT2[7:0]	0x00	Digital mixer 2, ADC channel 4 coefficient byte[23:16]
0x26	ADC_MIX2_CH4_BYT3[7:0]	0x00	Digital mixer 2, ADC channel 4 coefficient byte[15:8]

Table 8-212. Page 10 Programmable Coefficient Registers (continued)

0x27	ADC_MIX2_CH4_BYT4[7:0]	0x00	Digital mixer 2, ADC channel 4 coefficient byte[7:0]
0x28	ADC_MIX3_CH1_BYT1[7:0]	0x00	Digital mixer 3, ADC channel 1 coefficient byte[31:24]
0x29	ADC_MIX3_CH1_BYT2[7:0]	0x00	Digital mixer 3, ADC channel 1 coefficient byte[23:16]
0x2A	ADC_MIX3_CH1_BYT3[7:0]	0x00	Digital mixer 3, ADC channel 1 coefficient byte[15:8]
0x2B	ADC_MIX3_CH1_BYT4[7:0]	0x00	Digital mixer 3, ADC channel 1 coefficient byte[7:0]
0x2C	ADC_MIX3_CH2_BYT1[7:0]	0x00	Digital mixer 3, ADC channel 2 coefficient byte[31:24]
0x2D	ADC_MIX3_CH2_BYT2[7:0]	0x00	Digital mixer 3, ADC channel 2 coefficient byte[23:16]
0x2E	ADC_MIX3_CH2_BYT3[7:0]	0x00	Digital mixer 3, ADC channel 2 coefficient byte[15:8]
0x2F	ADC_MIX3_CH2_BYT4[7:0]	0x00	Digital mixer 3, ADC channel 2 coefficient byte[7:0]
0x30	ADC_MIX3_CH3_BYT1[7:0]	0x7F	Digital mixer 3, ADC channel 3 coefficient byte[31:24]
0x31	ADC_MIX3_CH3_BYT2[7:0]	0xFF	Digital mixer 3, ADC channel 3 coefficient byte[23:16]
0x32	ADC_MIX3_CH3_BYT3[7:0]	0xFF	Digital mixer 3, ADC channel 3 coefficient byte[15:8]
0x33	ADC_MIX3_CH3_BYT4[7:0]	0xFF	Digital mixer 3, ADC channel 3 coefficient byte[7:0]
0x34	ADC_MIX3_CH4_BYT1[7:0]	0x00	Digital mixer 3, ADC channel 4 coefficient byte[31:24]
0x35	ADC_MIX3_CH4_BYT2[7:0]	0x00	Digital mixer 3, ADC channel 4 coefficient byte[23:16]
0x36	ADC_MIX3_CH4_BYT3[7:0]	0x00	Digital mixer 3, ADC channel 4 coefficient byte[15:8]
0x37	ADC_MIX3_CH4_BYT4[7:0]	0x00	Digital mixer 3, ADC channel 4 coefficient byte[7:0]
0x38	ADC_MIX4_CH1_BYT1[7:0]	0x00	Digital mixer 4, ADC channel 1 coefficient byte[31:24]
0x39	ADC_MIX4_CH1_BYT2[7:0]	0x00	Digital mixer 4, ADC channel 1 coefficient byte[23:16]
0x3A	ADC_MIX4_CH1_BYT3[7:0]	0x00	Digital mixer 4, ADC channel 1 coefficient byte[15:8]
0x3B	ADC_MIX4_CH1_BYT4[7:0]	0x00	Digital mixer 4, ADC channel 1 coefficient byte[7:0]
0x3C	ADC_MIX4_CH2_BYT1[7:0]	0x00	Digital mixer 4, ADC channel 2 coefficient byte[31:24]
0x3D	ADC_MIX4_CH2_BYT2[7:0]	0x00	Digital mixer 4, ADC channel 2 coefficient byte[23:16]
0x3E	ADC_MIX4_CH2_BYT3[7:0]	0x00	Digital mixer 4, ADC channel 2 coefficient byte[15:8]
0x3F	ADC_MIX4_CH2_BYT4[7:0]	0x00	Digital mixer 4, ADC channel 2 coefficient byte[7:0]
0x40	ADC_MIX4_CH3_BYT1[7:0]	0x00	Digital mixer 4, ADC channel 3 coefficient byte[31:24]
0x41	ADC_MIX4_CH3_BYT2[7:0]	0x00	Digital mixer 4, ADC channel 3 coefficient byte[23:16]
0x42	ADC_MIX4_CH3_BYT3[7:0]	0x00	Digital mixer 4, ADC channel 3 coefficient byte[15:8]
0x43	ADC_MIX4_CH3_BYT4[7:0]	0x00	Digital mixer 4, ADC channel 3 coefficient byte[7:0]
0x44	ADC_MIX4_CH4_BYT1[7:0]	0x7F	Digital mixer 4, ADC channel 4 coefficient byte[31:24]
0x45	ADC_MIX4_CH4_BYT2[7:0]	0xFF	Digital mixer 4, ADC channel 4 coefficient byte[23:16]
0x46	ADC_MIX4_CH4_BYT3[7:0]	0xFF	Digital mixer 4, ADC channel 4 coefficient byte[15:8]
0x47	ADC_MIX4_CH4_BYT4[7:0]	0xFF	Digital mixer 4, ADC channel 4 coefficient byte[7:0]
0x48	ADC_LB_MIX1_CH1_BYT1[7:0]	0x7F	Digital loopback (ADC to DAC) mixer 1, ADC channel 1 coefficient byte[31:24]
0x49	ADC_LB_MIX1_CH1_BYT2[7:0]	0xFF	Digital loopback (ADC to DAC) mixer 1, ADC channel 1 coefficient byte[23:16]
0x4A	ADC_LB_MIX1_CH1_BYT3[7:0]	0xFF	Digital loopback (ADC to DAC) mixer 1, ADC channel 1 coefficient byte[15:8]

Table 8-212. Page 10 Programmable Coefficient Registers (continued)

0x4B	ADC_LB_MIX1_CH1_BYT4[7:0]	0xFF	Digital loopback (ADC to DAC) mixer 1, ADC channel 1 coefficient byte[7:0]
0x4C	ADC_LB_MIX1_CH2_BYT1[7:0]	0x00	Digital loopback (ADC to DAC) mixer 1, ADC channel 2 coefficient byte[31:24]
0x4D	ADC_LB_MIX1_CH2_BYT2[7:0]	0x00	Digital loopback (ADC to DAC) mixer 1, ADC channel 2 coefficient byte[23:16]
0x4E	ADC_LB_MIX1_CH2_BYT3[7:0]	0x00	Digital loopback (ADC to DAC) mixer 1, ADC channel 2 coefficient byte[15:8]
0x4F	ADC_LB_MIX1_CH2_BYT4[7:0]	0x00	Digital loopback (ADC to DAC) mixer 1, ADC channel 2 coefficient byte[7:0]
0x50	ADC_LB_MIX1_CH3_BYT1[7:0]	0x00	Digital loopback (ADC to DAC) mixer 1, ADC channel 3 coefficient byte[31:24]
0x51	ADC_LB_MIX1_CH3_BYT2[7:0]	0x00	Digital loopback (ADC to DAC) mixer 1, ADC channel 3 coefficient byte[23:16]
0x52	ADC_LB_MIX1_CH3_BYT3[7:0]	0x00	Digital loopback (ADC to DAC) mixer 1, ADC channel 3 coefficient byte[15:8]
0x53	ADC_LB_MIX1_CH3_BYT4[7:0]	0x00	Digital loopback (ADC to DAC) mixer 1, ADC channel 3 coefficient byte[7:0]
0x54	ADC_LB_MIX1_CH4_BYT1[7:0]	0x00	Digital loopback (ADC to DAC) mixer 1, ADC channel 4 coefficient byte[31:24]
0x55	ADC_LB_MIX1_CH4_BYT2[7:0]	0x00	Digital loopback (ADC to DAC) mixer 1, ADC channel 4 coefficient byte[23:16]
0x56	ADC_LB_MIX1_CH4_BYT3[7:0]	0x00	Digital loopback (ADC to DAC) mixer 1, ADC channel 4 coefficient byte[15:8]
0x57	ADC_LB_MIX1_CH4_BYT4[7:0]	0x00	Digital loopback (ADC to DAC) mixer 1, ADC channel 4 coefficient byte[7:0]
0x58	ADC_LB_MIX2_CH1_BYT1[7:0]	0x00	Digital loopback (ADC to DAC) mixer 2, ADC channel 1 coefficient byte[31:24]
0x59	ADC_LB_MIX2_CH1_BYT2[7:0]	0x00	Digital loopback (ADC to DAC) mixer 2, ADC channel 1 coefficient byte[23:16]
0x5A	ADC_LB_MIX2_CH1_BYT3[7:0]	0x00	Digital loopback (ADC to DAC) mixer 2, ADC channel 1 coefficient byte[15:8]
0x5B	ADC_LB_MIX2_CH1_BYT4[7:0]	0x00	Digital loopback (ADC to DAC) mixer 2, ADC channel 1 coefficient byte[7:0]
0x5C	ADC_LB_MIX2_CH2_BYT1[7:0]	0x7F	Digital loopback (ADC to DAC) mixer 2, ADC channel 2 coefficient byte[31:24]
0x5D	ADC_LB_MIX2_CH2_BYT2[7:0]	0xFF	Digital loopback (ADC to DAC) mixer 2, ADC channel 2 coefficient byte[23:16]
0x5E	ADC_LB_MIX2_CH2_BYT3[7:0]	0xFF	Digital loopback (ADC to DAC) mixer 2, ADC channel 2 coefficient byte[15:8]
0x5F	ADC_LB_MIX2_CH2_BYT4[7:0]	0xFF	Digital loopback (ADC to DAC) mixer 2, ADC channel 2 coefficient byte[7:0]
0x60	ADC_LB_MIX2_CH3_BYT1[7:0]	0x00	Digital loopback (ADC to DAC) mixer 2, ADC channel 3 coefficient byte[31:24]

Table 8-212. Page 10 Programmable Coefficient Registers (continued)

0x61	ADC_LB_MIX2_CH3_BYT2[7:0]	0x00	Digital loopback (ADC to DAC) mixer 2, ADC channel 3 coefficient byte[23:16]
0x62	ADC_LB_MIX2_CH3_BYT3[7:0]	0x00	Digital loopback (ADC to DAC) mixer 2, ADC channel 3 coefficient byte[15:8]
0x63	ADC_LB_MIX2_CH3_BYT4[7:0]	0x00	Digital loopback (ADC to DAC) mixer 2, ADC channel 3 coefficient byte[7:0]
0x64	ADC_LB_MIX2_CH4_BYT1[7:0]	0x00	Digital loopback (ADC to DAC) mixer 2, ADC channel 4 coefficient byte[31:24]
0x65	ADC_LB_MIX2_CH4_BYT2[7:0]	0x00	Digital loopback (ADC to DAC) mixer 2, ADC channel 4 coefficient byte[23:16]
0x66	ADC_LB_MIX2_CH4_BYT3[7:0]	0x00	Digital loopback (ADC to DAC) mixer 2, ADC channel 4 coefficient byte[15:8]
0x67	ADC_LB_MIX2_CH4_BYT4[7:0]	0x00	Digital loopback (ADC to DAC) mixer 2, ADC channel 4 coefficient byte[7:0]
0x78	ADC_IIR_N0_BYT1[7:0]	0x7F	Programmable ADC first-order IIR, N0 coefficient byte[31:24]
0x79	ADC_IIR_N0_BYT2[7:0]	0xFF	Programmable ADC first-order IIR, N0 coefficient byte[23:16]
0x7A	ADC_IIR_N0_BYT3[7:0]	0xFF	Programmable ADC first-order IIR, N0 coefficient byte[15:8]
0x7B	ADC_IIR_N0_BYT4[7:0]	0xFF	Programmable ADC first-order IIR, N0 coefficient byte[7:0]
0x7C	ADC_IIR_N1_BYT1[7:0]	0x00	Programmable ADC first-order IIR, N1 coefficient byte[31:24]
0x7D	ADC_IIR_N1_BYT2[7:0]	0x00	Programmable ADC first-order IIR, N1 coefficient byte[23:16]
0x7E	ADC_IIR_N1_BYT3[7:0]	0x00	Programmable ADC first-order IIR, N1 coefficient byte[15:8]
0x7F	ADC_IIR_N1_BYT4[7:0]	0x00	Programmable ADC first-order IIR, N1 coefficient byte[7:0]

8.2.4 Programmable Coefficient Registers: Page 11

This register page shown in [Table 8-213](#) consists of the programmable coefficients for the ADC first-order IIR filter, ADC digital volume control and fine gain control for channels 1 to 4, ADC Auxiliary mixer and UAD filters.

Table 8-213. Page 11 Programmable Coefficient Registers

ADDRESS	REGISTER	RESET	DESCRIPTION
0x00	PAGE[7:0]	0x00	Device Page Register
0x08	ADC_IIR_D1_BYT1[7:0]	0x00	Programmable ADC first-order IIR, D1 coefficient byte[31:24]
0x09	ADC_IIR_D1_BYT2[7:0]	0x00	Programmable ADC first-order IIR, D1 coefficient byte[23:16]
0x0A	ADC_IIR_D1_BYT3[7:0]	0x00	Programmable ADC first-order IIR, D1 coefficient byte[15:8]
0x0B	ADC_IIR_D1_BYT4[7:0]	0x00	Programmable ADC first-order IIR, D1 coefficient byte[7:0]
0x0C	DEV_BQ_BUFSWAP_FLAG_BYT1[7:0]	0x00	Device Biquad Buffer Swap Flag coefficient byte[31:24]
0x0D	DEV_BQ_BUFSWAP_FLAG_BYT2[7:0]	0x00	Device Biquad Buffer Swap Flag coefficient byte[23:16]
0x0E	DEV_BQ_BUFSWAP_FLAG_BYT3[7:0]	0x00	Device Biquad Buffer Swap Flag coefficient byte[15:8]
0x0F	DEV_BQ_BUFSWAP_FLAG_BYT4[7:0]	0x00	Device Biquad Buffer Swap Flag coefficient byte[7:0]
0x0C	ADC_VOL_CH1_BYT1[7:0]	0x00	Digital volume control, ADC channel 1 coefficient byte[31:24]
0x0D	ADC_VOL_CH1_BYT2[7:0]	0x80	Digital volume control, ADC channel 1 coefficient byte[23:16]
0x0E	ADC_VOL_CH1_BYT3[7:0]	0x00	Digital volume control, ADC channel 1 coefficient byte[15:8]
0x0F	ADC_VOL_CH1_BYT4[7:0]	0x00	Digital volume control, ADC channel 1 coefficient byte[7:0]

Table 8-213. Page 11 Programmable Coefficient Registers (continued)

0x10	ADC_VOL_CH2_BYT1[7:0]	0x00	Digital volume control, ADC channel 2 coefficient byte[31:24]
0x11	ADC_VOL_CH2_BYT2[7:0]	0x80	Digital volume control, ADC channel 2 coefficient byte[23:16]
0x12	ADC_VOL_CH2_BYT3[7:0]	0x00	Digital volume control, ADC channel 2 coefficient byte[15:8]
0x13	ADC_VOL_CH2_BYT4[7:0]	0x00	Digital volume control, ADC channel 2 coefficient byte[7:0]
0x14	ADC_VOL_CH3_BYT1[7:0]	0x00	Digital volume control, ADC channel 3 coefficient byte[31:24]
0x15	ADC_VOL_CH3_BYT2[7:0]	0x80	Digital volume control, ADC channel 3 coefficient byte[23:16]
0x16	ADC_VOL_CH3_BYT3[7:0]	0x00	Digital volume control, ADC channel 3 coefficient byte[15:8]
0x17	ADC_VOL_CH3_BYT4[7:0]	0x00	Digital volume control, ADC channel 3 coefficient byte[7:0]
0x18	ADC_VOL_CH4_BYT1[7:0]	0x00	Digital volume control, ADC channel 4 coefficient byte[31:24]
0x19	ADC_VOL_CH4_BYT2[7:0]	0x80	Digital volume control, ADC channel 4 coefficient byte[23:16]
0x1A	ADC_VOL_CH4_BYT3[7:0]	0x00	Digital volume control, ADC channel 4 coefficient byte[15:8]
0x1F	ADC_VOL_CH4_BYT4[7:0]	0x00	Digital volume control, ADC channel 4 coefficient byte[7:0]
0x20	ADC_SF2_CH1_BYT1[7:0]	0x40	Digital SF2 (fine gain) control, ADC channel 1 coefficient byte[31:24]
0x21	ADC_SF2_CH1_BYT2[7:0]	0x00	Digital SF2 (fine gain) control, ADC channel 1 coefficient byte[23:16]
0x22	ADC_SF2_CH1_BYT3[7:0]	0x00	Digital SF2 (fine gain) control, ADC channel 1 coefficient byte[15:8]
0x23	ADC_SF2_CH1_BYT4[7:0]	0x00	Digital SF2 (fine gain) control, ADC channel 1 coefficient byte[7:0]
0x24	ADC_SF2_CH2_BYT1[7:0]	0x40	Digital SF2 (fine gain) control, ADC channel 2 coefficient byte[31:24]
0x25	ADC_SF2_CH2_BYT2[7:0]	0x00	Digital SF2 (fine gain) control, ADC channel 2 coefficient byte[23:16]
0x26	ADC_SF2_CH2_BYT3[7:0]	0x00	Digital SF2 (fine gain) control, ADC channel 2 coefficient byte[15:8]
0x27	ADC_SF2_CH2_BYT4[7:0]	0x00	Digital SF2 (fine gain) control, ADC channel 2 coefficient byte[7:0]
0x28	ADC_SF2_CH3_BYT1[7:0]	0x40	Digital SF2 (fine gain) control, ADC channel 3 coefficient byte[31:24]
0x29	ADC_SF2_CH3_BYT2[7:0]	0x00	Digital SF2 (fine gain) control, ADC channel 3 coefficient byte[23:16]
0x2A	ADC_SF2_CH3_BYT3[7:0]	0x00	Digital SF2 (fine gain) control, ADC channel 3 coefficient byte[15:8]
0x2B	ADC_SF2_CH3_BYT4[7:0]	0x00	Digital SF2 (fine gain) control, ADC channel 3 coefficient byte[7:0]
0x2C	ADC_SF2_CH4_BYT1[7:0]	0x40	Digital SF2 (fine gain) control, ADC channel 4 coefficient byte[31:24]
0x2D	ADC_SF2_CH4_BYT2[7:0]	0x00	Digital SF2 (fine gain) control, ADC channel 4 coefficient byte[23:16]
0x2E	ADC_SF2_CH4_BYT3[7:0]	0x00	Digital SF2 (fine gain) control, ADC channel 4 coefficient byte[15:8]
0x2F	ADC_SF2_CH4_BYT4[7:0]	0x00	Digital SF2 (fine gain) control, ADC channel 4 coefficient byte[7:0]
0x30	ADC_AUX_MIX_CH1_BYT1[7:0]	0x00	ADC Auxiliary Mixer CH1 coefficient byte[31:24]
0x31	ADC_AUX_MIX_CH1_BYT2[7:0]	0x00	ADC Auxiliary Mixer CH1 coefficient byte[23:16]
0x32	ADC_AUX_MIX_CH1_BYT3[7:0]	0x00	ADC Auxiliary Mixer CH1 coefficient byte[15:8]
0x33	ADC_AUX_MIX_CH1_BYT4[7:0]	0x00	ADC Auxiliary Mixer CH1 coefficient byte[7:0]

Table 8-213. Page 11 Programmable Coefficient Registers (continued)

0x34	ADC_AUX_MIX_CH2_BYT1[7:0]	0x00	ADC Auxiliary Mixer CH2 coefficient byte[31:24]
0x35	ADC_AUX_MIX_CH2_BYT2[7:0]	0x00	ADC Auxiliary Mixer CH2 coefficient byte[23:16]
0x36	ADC_AUX_MIX_CH2_BYT3[7:0]	0x00	ADC Auxiliary Mixer CH2 coefficient byte[15:8]
0x37	ADC_AUX_MIX_CH2_BYT4[7:0]	0x00	ADC Auxiliary Mixer CH2 coefficient byte[7:0]
0x68	ADC_UAD_BPF_B0_BYT1[7:0]	0x07	UAD BQ B0 Coefficient [31:24]
0x69	ADC_UAD_BPF_B0_BYT2[7:0]	0xDF	UAD BQ B0 Coefficient [23:16]
0x6A	ADC_UAD_BPF_B0_BYT3[7:0]	0x9E	UAD BQ B0 Coefficient[15:8]
0x6B	ADC_UAD_BPF_B0_BYT4[7:0]	0x1D	UAD BQ B0 Coefficient[7:0]
0x6C	ADC_UAD_BPF_B1_BYT1[7:0]	0x00	UAD BQ B1 Coefficient [31:24]
0x6D	ADC_UAD_BPF_B1_BYT2[7:0]	0x00	UAD BQ B1 Coefficient [23:16]
0x6E	ADC_UAD_BPF_B1_BYT3[7:0]	0x00	UAD BQ B1 Coefficient[15:8]
0x6F	ADC_UAD_BPF_B1_BYT4[7:0]	0x00	UAD BQ B1 Coefficient [7:0]
0x70	ADC_UAD_BPF_B2_BYT1[7:0]	0xF8	UAD BQ B2 Coefficient [31:24]
0x71	ADC_UAD_BPF_B2_BYT2[7:0]	0x20	UAD BQ B2 Coefficient [23:16]
0x72	ADC_UAD_BPF_B2_BYT3[7:0]	0x61	UAD BQ B2 Coefficient[15:8]
0x73	ADC_UAD_BPF_B2_BYT4[7:0]	0xE2	UAD BQ B2 Coefficient[7:0]
0x74	ADC_UAD_BPF_A1_BYT1[7:0]	0x3C	UAD BQ A1 Coefficient [31:24]
0x75	ADC_UAD_BPF_A1_BYT2[7:0]	0x31	UAD BQ A1 Coefficient [23:16]
0x76	ADC_UAD_BPF_A1_BYT3[7:0]	0x2E	UAD BQ A1 Coefficient[15:8]
0x77	ADC_UAD_BPF_A1_BYT4[7:0]	0xF5	UAD BQ A1 Coefficient[7:0]
0x78	ADC_UAD_BPF_A2_BYT1[7:0]	0x70	UAD BQ A2 Coefficient [31:24]
0x79	ADC_UAD_BPF_A2_BYT2[7:0]	0x40	UAD BQ A2 Coefficient [23:16]
0x7A	ADC_UAD_BPF_A2_BYT3[7:0]	0xC3	UAD BQ A2 Coefficient[15:8]
0x7B	ADC_UAD_BPF_A2_BYT4[7:0]	0xC5	UAD BQ A2 Coefficient[7:0]

8.2.5 Programmable Coefficient Registers: Page 15

This register page shown in [Table 8-214](#) consists of the programmable coefficients for the DAC biquad 1 to biquad 6 filters.

Table 8-214. Page 15 Programmable Coefficient Registers

ADDRESS	REGISTER	RESET	DESCRIPTION
0x00	PAGE[7:0]	0x00	Device Page Register
0x08	DAC_BQ1_N0_BYT1[7:0]	0x7F	Programmable DAC biquad 1, N0 coefficient byte[31:24]
0x09	DAC_BQ1_N0_BYT2[7:0]	0xFF	Programmable DAC biquad 1, N0 coefficient byte[23:16]
0x0A	DAC_BQ1_N0_BYT3[7:0]	0xFF	Programmable DAC biquad 1, N0 coefficient byte[15:8]
0x0B	DAC_BQ1_N0_BYT4[7:0]	0xFF	Programmable DAC biquad 1, N0 coefficient byte[7:0]
0x0C	DAC_BQ1_N1_BYT1[7:0]	0x00	Programmable DAC biquad 1, N1 coefficient byte[31:24]
0x0D	DAC_BQ1_N1_BYT2[7:0]	0x00	Programmable DAC biquad 1, N1 coefficient byte[23:16]
0x0E	DAC_BQ1_N1_BYT3[7:0]	0x00	Programmable DAC biquad 1, N1 coefficient byte[15:8]
0x0F	DAC_BQ1_N1_BYT4[7:0]	0x00	Programmable DAC biquad 1, N1 coefficient byte[7:0]
0x10	DAC_BQ1_N2_BYT1[7:0]	0x00	Programmable DAC biquad 1, N2 coefficient byte[31:24]
0x11	DAC_BQ1_N2_BYT2[7:0]	0x00	Programmable DAC biquad 1, N2 coefficient byte[23:16]
0x12	DAC_BQ1_N2_BYT3[7:0]	0x00	Programmable DAC biquad 1, N2 coefficient byte[15:8]
0x13	DAC_BQ1_N2_BYT4[7:0]	0x00	Programmable DAC biquad 1, N2 coefficient byte[7:0]

Table 8-214. Page 15 Programmable Coefficient Registers (continued)

0x14	DAC_BQ1_D1_BYT1[7:0]	0x00	Programmable DAC biquad 1, D1 coefficient byte[31:24]
0x15	DAC_BQ1_D1_BYT2[7:0]	0x00	Programmable DAC biquad 1, D1 coefficient byte[23:16]
0x16	DAC_BQ1_D1_BYT3[7:0]	0x00	Programmable DAC biquad 1, D1 coefficient byte[15:8]
0x17	DAC_BQ1_D1_BYT4[7:0]	0x00	Programmable DAC biquad 1, D1 coefficient byte[7:0]
0x18	DAC_BQ1_D2_BYT1[7:0]	0x00	Programmable DAC biquad 1, D2 coefficient byte[31:24]
0x19	DAC_BQ1_D2_BYT2[7:0]	0x00	Programmable DAC biquad 1, D2 coefficient byte[23:16]
0x1A	DAC_BQ1_D2_BYT3[7:0]	0x00	Programmable DAC biquad 1, D2 coefficient byte[15:8]
0x1B	DAC_BQ1_D2_BYT4[7:0]	0x00	Programmable DAC biquad 1, D2 coefficient byte[7:0]
0x1C	DAC_BQ2_N0_BYT1[7:0]	0x7F	Programmable DAC biquad 2, N0 coefficient byte[31:24]
0x1D	DAC_BQ2_N0_BYT2[7:0]	0xFF	Programmable DAC biquad 2, N0 coefficient byte[23:16]
0x1E	DAC_BQ2_N0_BYT3[7:0]	0xFF	Programmable DAC biquad 2, N0 coefficient byte[15:8]
0x1F	DAC_BQ2_N0_BYT4[7:0]	0xFF	Programmable DAC biquad 2, N0 coefficient byte[7:0]
0x20	DAC_BQ2_N1_BYT1[7:0]	0x00	Programmable DAC biquad 2, N1 coefficient byte[31:24]
0x21	DAC_BQ2_N1_BYT2[7:0]	0x00	Programmable DAC biquad 2, N1 coefficient byte[23:16]
0x22	DAC_BQ2_N1_BYT3[7:0]	0x00	Programmable DAC biquad 2, N1 coefficient byte[15:8]
0x23	DAC_BQ2_N1_BYT4[7:0]	0x00	Programmable DAC biquad 2, N1 coefficient byte[7:0]
0x24	DAC_BQ2_N2_BYT1[7:0]	0x00	Programmable DAC biquad 2, N2 coefficient byte[31:24]
0x25	DAC_BQ2_N2_BYT2[7:0]	0x00	Programmable DAC biquad 2, N2 coefficient byte[23:16]
0x26	DAC_BQ2_N2_BYT3[7:0]	0x00	Programmable DAC biquad 2, N2 coefficient byte[15:8]
0x27	DAC_BQ2_N2_BYT4[7:0]	0x00	Programmable DAC biquad 2, N2 coefficient byte[7:0]
0x28	DAC_BQ2_D1_BYT1[7:0]	0x00	Programmable DAC biquad 2, D1 coefficient byte[31:24]
0x29	DAC_BQ2_D1_BYT2[7:0]	0x00	Programmable DAC biquad 2, D1 coefficient byte[23:16]
0x2A	DAC_BQ2_D1_BYT3[7:0]	0x00	Programmable DAC biquad 2, D1 coefficient byte[15:8]
0x2B	DAC_BQ2_D1_BYT4[7:0]	0x00	Programmable DAC biquad 2, D1 coefficient byte[7:0]
0x2C	DAC_BQ2_D2_BYT1[7:0]	0x00	Programmable DAC biquad 2, D2 coefficient byte[31:24]
0x2D	DAC_BQ2_D2_BYT2[7:0]	0x00	Programmable DAC biquad 2, D2 coefficient byte[23:16]
0x2E	DAC_BQ2_D2_BYT3[7:0]	0x00	Programmable DAC biquad 2, D2 coefficient byte[15:8]
0x2F	DAC_BQ2_D2_BYT4[7:0]	0x00	Programmable DAC biquad 2, D2 coefficient byte[7:0]
0x30	DAC_BQ3_N0_BYT1[7:0]	0x7F	Programmable DAC biquad 3, N0 coefficient byte[31:24]
0x31	DAC_BQ3_N0_BYT2[7:0]	0xFF	Programmable DAC biquad 3, N0 coefficient byte[23:16]
0x32	DAC_BQ3_N0_BYT3[7:0]	0xFF	Programmable DAC biquad 3, N0 coefficient byte[15:8]
0x33	DAC_BQ3_N0_BYT4[7:0]	0xFF	Programmable DAC biquad 3, N0 coefficient byte[7:0]
0x34	DAC_BQ3_N1_BYT1[7:0]	0x00	Programmable DAC biquad 3, N1 coefficient byte[31:24]
0x35	DAC_BQ3_N1_BYT2[7:0]	0x00	Programmable DAC biquad 3, N1 coefficient byte[23:16]
0x36	DAC_BQ3_N1_BYT3[7:0]	0x00	Programmable DAC biquad 3, N1 coefficient byte[15:8]
0x37	DAC_BQ3_N1_BYT4[7:0]	0x00	Programmable DAC biquad 3, N1 coefficient byte[7:0]
0x38	DAC_BQ3_N2_BYT1[7:0]	0x00	Programmable DAC biquad 3, N2 coefficient byte[31:24]
0x39	DAC_BQ3_N2_BYT2[7:0]	0x00	Programmable DAC biquad 3, N2 coefficient byte[23:16]
0x3A	DAC_BQ3_N2_BYT3[7:0]	0x00	Programmable DAC biquad 3, N2 coefficient byte[15:8]
0x3B	DAC_BQ3_N2_BYT4[7:0]	0x00	Programmable DAC biquad 3, N2 coefficient byte[7:0]
0x3C	DAC_BQ3_D1_BYT1[7:0]	0x00	Programmable DAC biquad 3, D1 coefficient byte[31:24]
0x3D	DAC_BQ3_D1_BYT2[7:0]	0x00	Programmable DAC biquad 3, D1 coefficient byte[23:16]
0x3E	DAC_BQ3_D1_BYT3[7:0]	0x00	Programmable DAC biquad 3, D1 coefficient byte[15:8]
0x3F	DAC_BQ3_D1_BYT4[7:0]	0x00	Programmable DAC biquad 3, D1 coefficient byte[7:0]
0x40	DAC_BQ3_D2_BYT1[7:0]	0x00	Programmable DAC biquad 3, D2 coefficient byte[31:24]
0x41	DAC_BQ3_D2_BYT2[7:0]	0x00	Programmable DAC biquad 3, D2 coefficient byte[23:16]

Table 8-214. Page 15 Programmable Coefficient Registers (continued)

0x42	DAC_BQ3_D2_BYT3[7:0]	0x00	Programmable DAC biquad 3, D2 coefficient byte[15:8]
0x43	DAC_BQ3_D2_BYT4[7:0]	0x00	Programmable DAC biquad 3, D2 coefficient byte[7:0]
0x44	DAC_BQ4_N0_BYT1[7:0]	0x7F	Programmable DAC biquad 4, N0 coefficient byte[31:24]
0x45	DAC_BQ4_N0_BYT2[7:0]	0xFF	Programmable DAC biquad 4, N0 coefficient byte[23:16]
0x46	DAC_BQ4_N0_BYT3[7:0]	0xFF	Programmable DAC biquad 4, N0 coefficient byte[15:8]
0x47	DAC_BQ4_N0_BYT4[7:0]	0xFF	Programmable DAC biquad 4, N0 coefficient byte[7:0]
0x48	DAC_BQ4_N1_BYT1[7:0]	0x00	Programmable DAC biquad 4, N1 coefficient byte[31:24]
0x49	DAC_BQ4_N1_BYT2[7:0]	0x00	Programmable DAC biquad 4, N1 coefficient byte[23:16]
0x4A	DAC_BQ4_N1_BYT3[7:0]	0x00	Programmable DAC biquad 4, N1 coefficient byte[15:8]
0x4B	DAC_BQ4_N1_BYT4[7:0]	0x00	Programmable DAC biquad 4, N1 coefficient byte[7:0]
0x4C	DAC_BQ4_N2_BYT1[7:0]	0x00	Programmable DAC biquad 4, N2 coefficient byte[31:24]
0x4D	DAC_BQ4_N2_BYT2[7:0]	0x00	Programmable DAC biquad 4, N2 coefficient byte[23:16]
0x4E	DAC_BQ4_N2_BYT3[7:0]	0x00	Programmable DAC biquad 4, N2 coefficient byte[15:8]
0x4F	DAC_BQ4_N2_BYT4[7:0]	0x00	Programmable DAC biquad 4, N2 coefficient byte[7:0]
0x50	DAC_BQ4_D1_BYT1[7:0]	0x00	Programmable DAC biquad 4, D1 coefficient byte[31:24]
0x51	DAC_BQ4_D1_BYT2[7:0]	0x00	Programmable DAC biquad 4, D1 coefficient byte[23:16]
0x52	DAC_BQ4_D1_BYT3[7:0]	0x00	Programmable DAC biquad 4, D1 coefficient byte[15:8]
0x53	DAC_BQ4_D1_BYT4[7:0]	0x00	Programmable DAC biquad 4, D1 coefficient byte[7:0]
0x54	DAC_BQ4_D2_BYT1[7:0]	0x00	Programmable DAC biquad 4, D2 coefficient byte[31:24]
0x55	DAC_BQ4_D2_BYT2[7:0]	0x00	Programmable DAC biquad 4, D2 coefficient byte[23:16]
0x56	DAC_BQ4_D2_BYT3[7:0]	0x00	Programmable DAC biquad 4, D2 coefficient byte[15:8]
0x57	DAC_BQ4_D2_BYT4[7:0]	0x00	Programmable DAC biquad 4, D2 coefficient byte[7:0]
0x58	DAC_BQ5_N0_BYT1[7:0]	0x7F	Programmable DAC biquad 5, N0 coefficient byte[31:24]
0x59	DAC_BQ5_N0_BYT2[7:0]	0xFF	Programmable DAC biquad 5, N0 coefficient byte[23:16]
0x5A	DAC_BQ5_N0_BYT3[7:0]	0xFF	Programmable DAC biquad 5, N0 coefficient byte[15:8]
0x5B	DAC_BQ5_N0_BYT4[7:0]	0xFF	Programmable DAC biquad 5, N0 coefficient byte[7:0]
0x5C	DAC_BQ5_N1_BYT1[7:0]	0x00	Programmable DAC biquad 5, N1 coefficient byte[31:24]
0x5D	DAC_BQ5_N1_BYT2[7:0]	0x00	Programmable DAC biquad 5, N1 coefficient byte[23:16]
0x5E	DAC_BQ5_N1_BYT3[7:0]	0x00	Programmable DAC biquad 5, N1 coefficient byte[15:8]
0x5F	DAC_BQ5_N1_BYT4[7:0]	0x00	Programmable DAC biquad 5, N1 coefficient byte[7:0]
0x60	DAC_BQ5_N2_BYT1[7:0]	0x00	Programmable DAC biquad 5, N2 coefficient byte[31:24]
0x61	DAC_BQ5_N2_BYT2[7:0]	0x00	Programmable DAC biquad 5, N2 coefficient byte[23:16]
0x62	DAC_BQ5_N2_BYT3[7:0]	0x00	Programmable DAC biquad 5, N2 coefficient byte[15:8]
0x63	DAC_BQ5_N2_BYT4[7:0]	0x00	Programmable DAC biquad 5, N2 coefficient byte[7:0]
0x64	DAC_BQ5_D1_BYT1[7:0]	0x00	Programmable DAC biquad 5, D1 coefficient byte[31:24]
0x65	DAC_BQ5_D1_BYT2[7:0]	0x00	Programmable DAC biquad 5, D1 coefficient byte[23:16]
0x66	DAC_BQ5_D1_BYT3[7:0]	0x00	Programmable DAC biquad 5, D1 coefficient byte[15:8]
0x67	DAC_BQ5_D1_BYT4[7:0]	0x00	Programmable DAC biquad 5, D1 coefficient byte[7:0]
0x68	DAC_BQ5_D2_BYT1[7:0]	0x00	Programmable DAC biquad 5, D2 coefficient byte[31:24]
0x69	DAC_BQ5_D2_BYT2[7:0]	0x00	Programmable DAC biquad 5, D2 coefficient byte[23:16]
0x6A	DAC_BQ5_D2_BYT3[7:0]	0x00	Programmable DAC biquad 5, D2 coefficient byte[15:8]
0x6B	DAC_BQ5_D2_BYT4[7:0]	0x00	Programmable DAC biquad 5, D2 coefficient byte[7:0]
0x6C	DAC_BQ6_N0_BYT1[7:0]	0x7F	Programmable DAC biquad 6, N0 coefficient byte[31:24]
0x6D	DAC_BQ6_N0_BYT2[7:0]	0xFF	Programmable DAC biquad 6, N0 coefficient byte[23:16]
0x6E	DAC_BQ6_N0_BYT3[7:0]	0xFF	Programmable DAC biquad 6, N0 coefficient byte[15:8]
0x6F	DAC_BQ6_N0_BYT4[7:0]	0xFF	Programmable DAC biquad 6, N0 coefficient byte[7:0]

Table 8-214. Page 15 Programmable Coefficient Registers (continued)

0x70	DAC_BQ6_N1_BYT1[7:0]	0x00	Programmable DAC biquad 6, N1 coefficient byte[31:24]
0x71	DAC_BQ6_N1_BYT2[7:0]	0x00	Programmable DAC biquad 6, N1 coefficient byte[23:16]
0x72	DAC_BQ6_N1_BYT3[7:0]	0x00	Programmable DAC biquad 6, N1 coefficient byte[15:8]
0x73	DAC_BQ6_N1_BYT4[7:0]	0x00	Programmable DAC biquad 6, N1 coefficient byte[7:0]
0x74	DAC_BQ6_N2_BYT1[7:0]	0x00	Programmable DAC biquad 6, N2 coefficient byte[31:24]
0x75	DAC_BQ6_N2_BYT2[7:0]	0x00	Programmable DAC biquad 6, N2 coefficient byte[23:16]
0x76	DAC_BQ6_N2_BYT3[7:0]	0x00	Programmable DAC biquad 6, N2 coefficient byte[15:8]
0x77	DAC_BQ6_N2_BYT4[7:0]	0x00	Programmable DAC biquad 6, N2 coefficient byte[7:0]
0x78	DAC_BQ6_D1_BYT1[7:0]	0x00	Programmable DAC biquad 6, D1 coefficient byte[31:24]
0x79	DAC_BQ6_D1_BYT2[7:0]	0x00	Programmable DAC biquad 6, D1 coefficient byte[23:16]
0x7A	DAC_BQ6_D1_BYT3[7:0]	0x00	Programmable DAC biquad 6, D1 coefficient byte[15:8]
0x7B	DAC_BQ6_D1_BYT4[7:0]	0x00	Programmable DAC biquad 6, D1 coefficient byte[7:0]
0x7C	DAC_BQ6_D2_BYT1[7:0]	0x00	Programmable DAC biquad 6, D2 coefficient byte[31:24]
0x7D	DAC_BQ6_D2_BYT2[7:0]	0x00	Programmable DAC biquad 6, D2 coefficient byte[23:16]
0x7E	DAC_BQ6_D2_BYT3[7:0]	0x00	Programmable DAC biquad 6, D2 coefficient byte[15:8]
0x7F	DAC_BQ6_D2_BYT4[7:0]	0x00	Programmable DAC biquad 6, D2 coefficient byte[7:0]

8.2.6 Programmable Coefficient Registers: Page 16

This register page shown in [Table 8-215](#) consists of the programmable coefficients for the DAC biquad 7 to biquad 12 filters.

Table 8-215. Page 16 Programmable Coefficient Registers

ADDRESS	REGISTER	RESET	DESCRIPTION
0x00	PAGE[7:0]	0x00	Device Page Register
0x08	DAC_BQ7_N0_BYT1[7:0]	0x7F	Programmable DAC biquad 7, N0 coefficient byte[31:24]
0x09	DAC_BQ7_N0_BYT2[7:0]	0xFF	Programmable DAC biquad 7, N0 coefficient byte[23:16]
0x0A	DAC_BQ7_N0_BYT3[7:0]	0xFF	Programmable DAC biquad 7, N0 coefficient byte[15:8]
0x0B	DAC_BQ7_N0_BYT4[7:0]	0xFF	Programmable DAC biquad 7, N0 coefficient byte[7:0]
0x0C	DAC_BQ7_N1_BYT1[7:0]	0x00	Programmable DAC biquad 7, N1 coefficient byte[31:24]
0x0D	DAC_BQ7_N1_BYT2[7:0]	0x00	Programmable DAC biquad 7, N1 coefficient byte[23:16]
0x0E	DAC_BQ7_N1_BYT3[7:0]	0x00	Programmable DAC biquad 7, N1 coefficient byte[15:8]
0x0F	DAC_BQ7_N1_BYT4[7:0]	0x00	Programmable DAC biquad 7, N1 coefficient byte[7:0]
0x10	DAC_BQ7_N2_BYT1[7:0]	0x00	Programmable DAC biquad 7, N2 coefficient byte[31:24]
0x11	DAC_BQ7_N2_BYT2[7:0]	0x00	Programmable DAC biquad 7, N2 coefficient byte[23:16]
0x12	DAC_BQ7_N2_BYT3[7:0]	0x00	Programmable DAC biquad 7, N2 coefficient byte[15:8]
0x13	DAC_BQ7_N2_BYT4[7:0]	0x00	Programmable DAC biquad 7, N2 coefficient byte[7:0]
0x14	DAC_BQ7_D1_BYT1[7:0]	0x00	Programmable DAC biquad 7, D1 coefficient byte[31:24]
0x15	DAC_BQ7_D1_BYT2[7:0]	0x00	Programmable DAC biquad 7, D1 coefficient byte[23:16]
0x16	DAC_BQ7_D1_BYT3[7:0]	0x00	Programmable DAC biquad 7, D1 coefficient byte[15:8]
0x17	DAC_BQ7_D1_BYT4[7:0]	0x00	Programmable DAC biquad 7, D1 coefficient byte[7:0]
0x18	DAC_BQ7_D2_BYT1[7:0]	0x00	Programmable DAC biquad 7, D2 coefficient byte[31:24]
0x19	DAC_BQ7_D2_BYT2[7:0]	0x00	Programmable DAC biquad 7, D2 coefficient byte[23:16]
0x1A	DAC_BQ7_D2_BYT3[7:0]	0x00	Programmable DAC biquad 7, D2 coefficient byte[15:8]
0x1B	DAC_BQ7_D2_BYT4[7:0]	0x00	Programmable DAC biquad 7, D2 coefficient byte[7:0]
0x1C	DAC_BQ8_N0_BYT1[7:0]	0x7F	Programmable DAC biquad 8, N0 coefficient byte[31:24]
0x1D	DAC_BQ8_N0_BYT2[7:0]	0xFF	Programmable DAC biquad 8, N0 coefficient byte[23:16]
0x1E	DAC_BQ8_N0_BYT3[7:0]	0xFF	Programmable DAC biquad 8, N0 coefficient byte[15:8]

Table 8-215. Page 16 Programmable Coefficient Registers (continued)

0x1F	DAC_BQ8_N0_BYT4[7:0]	0xFF	Programmable DAC biquad 8, N0 coefficient byte[7:0]
0x20	DAC_BQ8_N1_BYT1[7:0]	0x00	Programmable DAC biquad 8, N1 coefficient byte[31:24]
0x21	DAC_BQ8_N1_BYT2[7:0]	0x00	Programmable DAC biquad 8, N1 coefficient byte[23:16]
0x22	DAC_BQ8_N1_BYT3[7:0]	0x00	Programmable DAC biquad 8, N1 coefficient byte[15:8]
0x23	DAC_BQ8_N1_BYT4[7:0]	0x00	Programmable DAC biquad 8, N1 coefficient byte[7:0]
0x24	DAC_BQ8_N2_BYT1[7:0]	0x00	Programmable DAC biquad 8, N2 coefficient byte[31:24]
0x25	DAC_BQ8_N2_BYT2[7:0]	0x00	Programmable DAC biquad 8, N2 coefficient byte[23:16]
0x26	DAC_BQ8_N2_BYT3[7:0]	0x00	Programmable DAC biquad 8, N2 coefficient byte[15:8]
0x27	DAC_BQ8_N2_BYT4[7:0]	0x00	Programmable DAC biquad 8, N2 coefficient byte[7:0]
0x28	DAC_BQ8_D1_BYT1[7:0]	0x00	Programmable DAC biquad 8, D1 coefficient byte[31:24]
0x29	DAC_BQ8_D1_BYT2[7:0]	0x00	Programmable DAC biquad 8, D1 coefficient byte[23:16]
0x2A	DAC_BQ8_D1_BYT3[7:0]	0x00	Programmable DAC biquad 8, D1 coefficient byte[15:8]
0x2B	DAC_BQ8_D1_BYT4[7:0]	0x00	Programmable DAC biquad 8, D1 coefficient byte[7:0]
0x2C	DAC_BQ8_D2_BYT1[7:0]	0x00	Programmable DAC biquad 8, D2 coefficient byte[31:24]
0x2D	DAC_BQ8_D2_BYT2[7:0]	0x00	Programmable DAC biquad 8, D2 coefficient byte[23:16]
0x2E	DAC_BQ8_D2_BYT3[7:0]	0x00	Programmable DAC biquad 8, D2 coefficient byte[15:8]
0x2F	DAC_BQ8_D2_BYT4[7:0]	0x00	Programmable DAC biquad 8, D2 coefficient byte[7:0]
0x30	DAC_BQ9_N0_BYT1[7:0]	0x7F	Programmable DAC biquad 9, N0 coefficient byte[31:24]
0x31	DAC_BQ9_N0_BYT2[7:0]	0xFF	Programmable DAC biquad 9, N0 coefficient byte[23:16]
0x32	DAC_BQ9_N0_BYT3[7:0]	0xFF	Programmable DAC biquad 9, N0 coefficient byte[15:8]
0x33	DAC_BQ9_N0_BYT4[7:0]	0xFF	Programmable DAC biquad 9, N0 coefficient byte[7:0]
0x34	DAC_BQ9_N1_BYT1[7:0]	0x00	Programmable DAC biquad 9, N1 coefficient byte[31:24]
0x35	DAC_BQ9_N1_BYT2[7:0]	0x00	Programmable DAC biquad 9, N1 coefficient byte[23:16]
0x36	DAC_BQ9_N1_BYT3[7:0]	0x00	Programmable DAC biquad 9, N1 coefficient byte[15:8]
0x37	DAC_BQ9_N1_BYT4[7:0]	0x00	Programmable DAC biquad 9, N1 coefficient byte[7:0]
0x38	DAC_BQ9_N2_BYT1[7:0]	0x00	Programmable DAC biquad 9, N2 coefficient byte[31:24]
0x39	DAC_BQ9_N2_BYT2[7:0]	0x00	Programmable DAC biquad 9, N2 coefficient byte[23:16]
0x3A	DAC_BQ9_N2_BYT3[7:0]	0x00	Programmable DAC biquad 9, N2 coefficient byte[15:8]
0x3B	DAC_BQ9_N2_BYT4[7:0]	0x00	Programmable DAC biquad 9, N2 coefficient byte[7:0]
0x3C	DAC_BQ9_D1_BYT1[7:0]	0x00	Programmable DAC biquad 9, D1 coefficient byte[31:24]
0x3D	DAC_BQ9_D1_BYT2[7:0]	0x00	Programmable DAC biquad 9, D1 coefficient byte[23:16]
0x3E	DAC_BQ9_D1_BYT3[7:0]	0x00	Programmable DAC biquad 9, D1 coefficient byte[15:8]
0x3F	DAC_BQ9_D1_BYT4[7:0]	0x00	Programmable DAC biquad 9, D1 coefficient byte[7:0]
0x40	DAC_BQ9_D2_BYT1[7:0]	0x00	Programmable DAC biquad 9, D2 coefficient byte[31:24]
0x41	DAC_BQ9_D2_BYT2[7:0]	0x00	Programmable DAC biquad 9, D2 coefficient byte[23:16]
0x42	DAC_BQ9_D2_BYT3[7:0]	0x00	Programmable DAC biquad 9, D2 coefficient byte[15:8]
0x43	DAC_BQ9_D2_BYT4[7:0]	0x00	Programmable DAC biquad 9, D2 coefficient byte[7:0]
0x44	DAC_BQ10_N0_BYT1[7:0]	0x7F	Programmable DAC biquad 10, N0 coefficient byte[31:24]
0x45	DAC_BQ10_N0_BYT2[7:0]	0xFF	Programmable DAC biquad 10, N0 coefficient byte[23:16]
0x46	DAC_BQ10_N0_BYT3[7:0]	0xFF	Programmable DAC biquad 10, N0 coefficient byte[15:8]
0x47	DAC_BQ10_N0_BYT4[7:0]	0xFF	Programmable DAC biquad 10, N0 coefficient byte[7:0]
0x48	DAC_BQ10_N1_BYT1[7:0]	0x00	Programmable DAC biquad 10, N1 coefficient byte[31:24]
0x49	DAC_BQ10_N1_BYT2[7:0]	0x00	Programmable DAC biquad 10, N1 coefficient byte[23:16]
0x4A	DAC_BQ10_N1_BYT3[7:0]	0x00	Programmable DAC biquad 10, N1 coefficient byte[15:8]
0x4B	DAC_BQ10_N1_BYT4[7:0]	0x00	Programmable DAC biquad 10, N1 coefficient byte[7:0]
0x4C	DAC_BQ10_N2_BYT1[7:0]	0x00	Programmable DAC biquad 10, N2 coefficient byte[31:24]

Table 8-215. Page 16 Programmable Coefficient Registers (continued)

0x4D	DAC_BQ10_N2_BYT2[7:0]	0x00	Programmable DAC biquad 10, N2 coefficient byte[23:16]
0x4E	DAC_BQ10_N2_BYT3[7:0]	0x00	Programmable DAC biquad 10, N2 coefficient byte[15:8]
0x4F	DAC_BQ10_N2_BYT4[7:0]	0x00	Programmable DAC biquad 10, N2 coefficient byte[7:0]
0x50	DAC_BQ10_D1_BYT1[7:0]	0x00	Programmable DAC biquad 10, D1 coefficient byte[31:24]
0x51	DAC_BQ10_D1_BYT2[7:0]	0x00	Programmable DAC biquad 10, D1 coefficient byte[23:16]
0x52	DAC_BQ10_D1_BYT3[7:0]	0x00	Programmable DAC biquad 10, D1 coefficient byte[15:8]
0x53	DAC_BQ10_D1_BYT4[7:0]	0x00	Programmable DAC biquad 10, D1 coefficient byte[7:0]
0x54	DAC_BQ10_D2_BYT1[7:0]	0x00	Programmable DAC biquad 10, D2 coefficient byte[31:24]
0x55	DAC_BQ10_D2_BYT2[7:0]	0x00	Programmable DAC biquad 10, D2 coefficient byte[23:16]
0x56	DAC_BQ10_D2_BYT3[7:0]	0x00	Programmable DAC biquad 10, D2 coefficient byte[15:8]
0x57	DAC_BQ10_D2_BYT4[7:0]	0x00	Programmable DAC biquad 10, D2 coefficient byte[7:0]
0x58	DAC_BQ11_N0_BYT1[7:0]	0x7F	Programmable DAC biquad 11, N0 coefficient byte[31:24]
0x59	DAC_BQ11_N0_BYT2[7:0]	0xFF	Programmable DAC biquad 11, N0 coefficient byte[23:16]
0x5A	DAC_BQ11_N0_BYT3[7:0]	0xFF	Programmable DAC biquad 11, N0 coefficient byte[15:8]
0x5B	DAC_BQ11_N0_BYT4[7:0]	0xFF	Programmable DAC biquad 11, N0 coefficient byte[7:0]
0x5C	DAC_BQ11_N1_BYT1[7:0]	0x00	Programmable DAC biquad 11, N1 coefficient byte[31:24]
0x5D	DAC_BQ11_N1_BYT2[7:0]	0x00	Programmable DAC biquad 11, N1 coefficient byte[23:16]
0x5E	DAC_BQ11_N1_BYT3[7:0]	0x00	Programmable DAC biquad 11, N1 coefficient byte[15:8]
0x5F	DAC_BQ11_N1_BYT4[7:0]	0x00	Programmable DAC biquad 11, N1 coefficient byte[7:0]
0x60	DAC_BQ11_N2_BYT1[7:0]	0x00	Programmable DAC biquad 11, N2 coefficient byte[31:24]
0x61	DAC_BQ11_N2_BYT2[7:0]	0x00	Programmable DAC biquad 11, N2 coefficient byte[23:16]
0x62	DAC_BQ11_N2_BYT3[7:0]	0x00	Programmable DAC biquad 11, N2 coefficient byte[15:8]
0x63	DAC_BQ11_N2_BYT4[7:0]	0x00	Programmable DAC biquad 11, N2 coefficient byte[7:0]
0x64	DAC_BQ11_D1_BYT1[7:0]	0x00	Programmable DAC biquad 11, D1 coefficient byte[31:24]
0x65	DAC_BQ11_D1_BYT2[7:0]	0x00	Programmable DAC biquad 11, D1 coefficient byte[23:16]
0x66	DAC_BQ11_D1_BYT3[7:0]	0x00	Programmable DAC biquad 11, D1 coefficient byte[15:8]
0x67	DAC_BQ11_D1_BYT4[7:0]	0x00	Programmable DAC biquad 11, D1 coefficient byte[7:0]
0x68	DAC_BQ11_D2_BYT1[7:0]	0x00	Programmable DAC biquad 11, D2 coefficient byte[31:24]
0x69	DAC_BQ11_D2_BYT2[7:0]	0x00	Programmable DAC biquad 11, D2 coefficient byte[23:16]
0x6A	DAC_BQ11_D2_BYT3[7:0]	0x00	Programmable DAC biquad 11, D2 coefficient byte[15:8]
0x6B	DAC_BQ11_D2_BYT4[7:0]	0x00	Programmable DAC biquad 11, D2 coefficient byte[7:0]
0x6C	DAC_BQ12_N0_BYT1[7:0]	0x7F	Programmable DAC biquad 12, N0 coefficient byte[31:24]
0x6D	DAC_BQ12_N0_BYT2[7:0]	0xFF	Programmable DAC biquad 12, N0 coefficient byte[23:16]
0x6E	DAC_BQ12_N0_BYT3[7:0]	0xFF	Programmable DAC biquad 12, N0 coefficient byte[15:8]
0x6F	DAC_BQ12_N0_BYT4[7:0]	0xFF	Programmable DAC biquad 12, N0 coefficient byte[7:0]
0x70	DAC_BQ12_N1_BYT1[7:0]	0x00	Programmable DAC biquad 12, N1 coefficient byte[31:24]
0x71	DAC_BQ12_N1_BYT2[7:0]	0x00	Programmable DAC biquad 12, N1 coefficient byte[23:16]
0x72	DAC_BQ12_N1_BYT3[7:0]	0x00	Programmable DAC biquad 12, N1 coefficient byte[15:8]
0x73	DAC_BQ12_N1_BYT4[7:0]	0x00	Programmable DAC biquad 12, N1 coefficient byte[7:0]
0x74	DAC_BQ12_N2_BYT1[7:0]	0x00	Programmable DAC biquad 12, N2 coefficient byte[31:24]
0x75	DAC_BQ12_N2_BYT2[7:0]	0x00	Programmable DAC biquad 12, N2 coefficient byte[23:16]
0x76	DAC_BQ12_N2_BYT3[7:0]	0x00	Programmable DAC biquad 12, N2 coefficient byte[15:8]
0x77	DAC_BQ12_N2_BYT4[7:0]	0x00	Programmable DAC biquad 12, N2 coefficient byte[7:0]
0x78	DAC_BQ12_D1_BYT1[7:0]	0x00	Programmable DAC biquad 12, D1 coefficient byte[31:24]
0x79	DAC_BQ12_D1_BYT2[7:0]	0x00	Programmable DAC biquad 12, D1 coefficient byte[23:16]
0x7A	DAC_BQ12_D1_BYT3[7:0]	0x00	Programmable DAC biquad 12, D1 coefficient byte[15:8]

Table 8-215. Page 16 Programmable Coefficient Registers (continued)

0x7B	DAC_BQ12_D1_BYT4[7:0]	0x00	Programmable DAC biquad 12, D1 coefficient byte[7:0]
0x7C	DAC_BQ12_D2_BYT1[7:0]	0x00	Programmable DAC biquad 12, D2 coefficient byte[31:24]
0x7D	DAC_BQ12_D2_BYT2[7:0]	0x00	Programmable DAC biquad 12, D2 coefficient byte[23:16]
0x7E	DAC_BQ12_D2_BYT3[7:0]	0x00	Programmable DAC biquad 12, D2 coefficient byte[15:8]
0x7F	DAC_BQ12_D2_BYT4[7:0]	0x00	Programmable DAC biquad 12, D2 coefficient byte[7:0]

8.2.7 Programmable Coefficient Registers: Page 17

This register page shown in [Table 8-216](#) consists of the programmable coefficients for the ASI DIN mixer for DAC channels 1 to 4, DAC Aux mixer, Loopback mixer, Signal-generator mixer and the DAC first-order IIR filter.

Table 8-216. Page 17 Programmable Coefficient Registers

ADDRESS	REGISTER	RESET	DESCRIPTION
0x00	PAGE[7:0]	0x00	Device Page Register
0x08	ASI_DIN_MIX_ASI_CH1_RDAC_MIX_BYT1[7:0]	0x00	ASI DIN MIXER, ASI CH1 to RDAC coefficient byte[15:8]
0x09	ASI_DIN_MIX_ASI_CH1_RDAC_MIX_BYT2[7:0]	0x00	ASI DIN MIXER, ASI CH1 to RDAC coefficient byte[7:0]
0x0A	ASI_DIN_MIX_ASI_CH1_LDAC_MIX_BYT1[7:0]	0x40	ASI DIN MIXER, ASI CH1 to LDAC coefficient byte[15:8]
0x0B	ASI_DIN_MIX_ASI_CH1_LDAC_MIX_BYT2[7:0]	0x00	ASI DIN MIXER, ASI CH1 to LDAC coefficient byte[7:0]
0x0C	ASI_DIN_MIX_ASI_CH1_RDAC_2_MIX_BYT1[7:0]	0x00	ASI DIN MIXER, ASI CH1 to RDAC2 coefficient byte[15:8]
0x0D	ASI_DIN_MIX_ASI_CH1_RDAC_2_MIX_BYT2[7:0]	0x00	ASI DIN MIXER, ASI CH1 to RDAC2 coefficient byte[7:0]
0x0E	ASI_DIN_MIX_ASI_CH1_LDAC_2_MIX_BYT1[7:0]	0x00	ASI DIN MIXER, ASI CH1 to LDAC2 coefficient byte[15:8]
0x0F	ASI_DIN_MIX_ASI_CH1_LDAC_2_MIX_BYT2[7:0]	0x00	ASI DIN MIXER, ASI CH1 to LDAC2 coefficient byte[7:0]
0x10	ASI_DIN_MIX_ASI_CH2_RDAC_MIX_BYT1[7:0]	0x40	ASI DIN MIXER, ASI CH2 to RDAC coefficient byte[15:8]
0x11	ASI_DIN_MIX_ASI_CH2_RDAC_MIX_BYT2[7:0]	0x00	ASI DIN MIXER, ASI CH2 to RDAC coefficient byte[7:0]
0x12	ASI_DIN_MIX_ASI_CH2_LDAC_MIX_BYT1[7:0]	0x00	ASI DIN MIXER, ASI CH2 to LDAC coefficient byte[15:8]
0x13	ASI_DIN_MIX_ASI_CH2_LDAC_MIX_BYT2[7:0]	0x00	ASI DIN MIXER, ASI CH2 to LDAC coefficient byte[7:0]
0x14	ASI_DIN_MIX_ASI_CH2_RDAC_2_MIX_BYT1[7:0]	0x00	ASI DIN MIXER, ASI CH2 to RDAC2 coefficient byte[15:8]
0x15	ASI_DIN_MIX_ASI_CH2_RDAC_2_MIX_BYT2[7:0]	0x00	ASI DIN MIXER, ASI CH2 to RDAC2 coefficient byte[7:0]
0x16	ASI_DIN_MIX_ASI_CH2_LDAC_2_MIX_BYT1[7:0]	0x00	ASI DIN MIXER, ASI CH2 to LDAC2 coefficient byte[15:8]
0x17	ASI_DIN_MIX_ASI_CH2_LDAC_2_MIX_BYT2[7:0]	0x00	ASI DIN MIXER, ASI CH2 to LDAC2 coefficient byte[7:0]
0x18	ASI_DIN_MIX_ASI_CH3_RDAC_MIX_BYT1[7:0]	0x00	ASI DIN MIXER, ASI CH3 to RDAC coefficient byte[15:8]
0x19	ASI_DIN_MIX_ASI_CH3_RDAC_MIX_BYT2[7:0]	0x00	ASI DIN MIXER, ASI CH3 to RDAC coefficient byte[7:0]
0x1A	ASI_DIN_MIX_ASI_CH3_LDAC_MIX_BYT1[7:0]	0x00	ASI DIN MIXER, ASI CH3 to LDAC coefficient byte[15:8]
0x1B	ASI_DIN_MIX_ASI_CH3_LDAC_MIX_BYT2[7:0]	0x00	ASI DIN MIXER, ASI CH3 to LDAC coefficient byte[7:0]

Table 8-216. Page 17 Programmable Coefficient Registers (continued)

0x1C	ASI_DIN_MIX_ASI_CH3_RDAC 2_MIX_BYT1[7:0]	0x00	ASI DIN MIXER, ASI CH3 to RDAC2 coefficient byte[15:8]
0x1D	ASI_DIN_MIX_ASI_CH3_RDAC 2_MIX_BYT2[7:0]	0x00	ASI DIN MIXER, ASI CH3 to RDAC2 coefficient byte[7:0]
0x1E	ASI_DIN_MIX_ASI_CH3_LDAC 2_MIX_BYT1[7:0]	0x40	ASI DIN MIXER, ASI CH3 to LDAC2 coefficient byte[15:8]
0x1F	ASI_DIN_MIX_ASI_CH3_LDAC 2_MIX_BYT2[7:0]	0x00	ASI DIN MIXER, ASI CH3 to LDAC2 coefficient byte[7:0]
0x20	ASI_DIN_MIX_ASI_CH4_RDAC _MIX_BYT1[7:0]	0x00	ASI DIN MIXER, ASI CH4 to RDAC coefficient byte[15:8]
0x21	ASI_DIN_MIX_ASI_CH4_RDAC _MIX_BYT2[7:0]	0x00	ASI DIN MIXER, ASI CH4 to RDAC coefficient byte[7:0]
0x22	ASI_DIN_MIX_ASI_CH4_LDAC _MIX_BYT1[7:0]	0x00	ASI DIN MIXER, ASI CH4 to LDAC coefficient byte[15:8]
0x23	ASI_DIN_MIX_ASI_CH4_LDAC _MIX_BYT2[7:0]	0x00	ASI DIN MIXER, ASI CH4 to LDAC coefficient byte[7:0]
0x24	ASI_DIN_MIX_ASI_CH4_RDAC 2_MIX_BYT1[7:0]	0x40	ASI DIN MIXER, ASI CH4 to RDAC2 coefficient byte[15:8]
0x25	ASI_DIN_MIX_ASI_CH4_RDAC 2_MIX_BYT2[7:0]	0x00	ASI DIN MIXER, ASI CH4 to RDAC2 coefficient byte[7:0]
0x26	ASI_DIN_MIX_ASI_CH4_LDAC 2_MIX_BYT1[7:0]	0x00	ASI DIN MIXER, ASI CH4 to LDAC2 coefficient byte[15:8]
0x27	ASI_DIN_MIX_ASI_CH4_LDAC 2_MIX_BYT2[7:0]	0x00	ASI DIN MIXER, ASI CH4 to LDAC2 coefficient byte[7:0]
0x28	ASI_DIN_MIX_ASI_CH5_RDAC _MIX_BYT1[7:0]	0x00	ASI DIN MIXER, ASI CH5 to RDAC coefficient byte[15:8]
0x29	ASI_DIN_MIX_ASI_CH5_RDAC _MIX_BYT2[7:0]	0x00	ASI DIN MIXER, ASI CH5 to RDAC coefficient byte[7:0]
0x2A	ASI_DIN_MIX_ASI_CH5_LDAC _MIX_BYT1[7:0]	0x00	ASI DIN MIXER, ASI CH5 to LDAC coefficient byte[15:8]
0x2B	ASI_DIN_MIX_ASI_CH5_LDAC _MIX_BYT2[7:0]	0x00	ASI DIN MIXER, ASI CH5 to LDAC coefficient byte[7:0]
0x2C	ASI_DIN_MIX_ASI_CH5_RDAC 2_MIX_BYT1[7:0]	0x00	ASI DIN MIXER, ASI CH5 to RDAC2 coefficient byte[15:8]
0x2D	ASI_DIN_MIX_ASI_CH5_RDAC 2_MIX_BYT2[7:0]	0x00	ASI DIN MIXER, ASI CH5 to RDAC2 coefficient byte[7:0]
0x2E	ASI_DIN_MIX_ASI_CH5_LDAC 2_MIX_BYT1[7:0]	0x00	ASI DIN MIXER, ASI CH5 to LDAC2 coefficient byte[15:8]
0x2F	ASI_DIN_MIX_ASI_CH5_LDAC 2_MIX_BYT2[7:0]	0x00	ASI DIN MIXER, ASI CH5 to LDAC2 coefficient byte[7:0]
0x30	ASI_DIN_MIX_ASI_CH6_RDAC _MIX_BYT1[7:0]	0x00	ASI DIN MIXER, ASI CH6 to RDAC coefficient byte[15:8]
0x31	ASI_DIN_MIX_ASI_CH6_RDAC _MIX_BYT2[7:0]	0x00	ASI DIN MIXER, ASI CH6 to RDAC coefficient byte[7:0]
0x32	ASI_DIN_MIX_ASI_CH6_LDAC _MIX_BYT1[7:0]	0x00	ASI DIN MIXER, ASI CH6 to LDAC coefficient byte[15:8]
0x33	ASI_DIN_MIX_ASI_CH6_LDAC _MIX_BYT2[7:0]	0x00	ASI DIN MIXER, ASI CH6 to LDAC coefficient byte[7:0]
0x34	ASI_DIN_MIX_ASI_CH6_RDAC 2_MIX_BYT1[7:0]	0x00	ASI DIN MIXER, ASI CH6 to RDAC2 coefficient byte[15:8]
0x35	ASI_DIN_MIX_ASI_CH6_RDAC 2_MIX_BYT2[7:0]	0x00	ASI DIN MIXER, ASI CH6 to RDAC2 coefficient byte[7:0]
0x36	ASI_DIN_MIX_ASI_CH6_LDAC 2_MIX_BYT1[7:0]	0x00	ASI DIN MIXER, ASI CH6 to LDAC2 coefficient byte[15:8]

Table 8-216. Page 17 Programmable Coefficient Registers (continued)

0x37	ASI_DIN_MIX_ASI_CH6_LDAC2_MIX_BYT2[7:0]	0x00	ASI DIN MIXER, ASI CH6 to LDAC2 coefficient byte[7:0]
0x38	ASI_DIN_MIX_ASI_CH7_RDAC_MIX_BYT1[7:0]	0x00	ASI DIN MIXER, ASI CH7 to RDAC coefficient byte[15:8]
0x39	ASI_DIN_MIX_ASI_CH7_RDAC_MIX_BYT2[7:0]	0x00	ASI DIN MIXER, ASI CH7 to RDAC coefficient byte[7:0]
0x3A	ASI_DIN_MIX_ASI_CH7_LDAC_MIX_BYT1[7:0]	0x00	ASI DIN MIXER, ASI CH7 to LDAC coefficient byte[15:8]
0x3B	ASI_DIN_MIX_ASI_CH7_LDAC_MIX_BYT2[7:0]	0x00	ASI DIN MIXER, ASI CH7 to LDAC coefficient byte[7:0]
0x3C	ASI_DIN_MIX_ASI_CH7_RDAC2_MIX_BYT1[7:0]	0x00	ASI DIN MIXER, ASI CH7 to RDAC2 coefficient byte[15:8]
0x3D	ASI_DIN_MIX_ASI_CH7_RDAC2_MIX_BYT2[7:0]	0x00	ASI DIN MIXER, ASI CH7 to RDAC2 coefficient byte[7:0]
0x3E	ASI_DIN_MIX_ASI_CH7_LDAC2_MIX_BYT1[7:0]	0x00	ASI DIN MIXER, ASI CH7 to LDAC2 coefficient byte[15:8]
0x3F	ASI_DIN_MIX_ASI_CH7_LDAC2_MIX_BYT2[7:0]	0x00	ASI DIN MIXER, ASI CH7 to LDAC2 coefficient byte[7:0]
0x40	ASI_DIN_MIX_ASI_CH8_RDAC_MIX_BYT1[7:0]	0x00	ASI DIN MIXER, ASI CH8 to RDAC coefficient byte[15:8]
0x41	ASI_DIN_MIX_ASI_CH8_RDAC_MIX_BYT2[7:0]	0x00	ASI DIN MIXER, ASI CH8 to RDAC coefficient byte[7:0]
0x42	ASI_DIN_MIX_ASI_CH8_LDAC_MIX_BYT1[7:0]	0x00	ASI DIN MIXER, ASI CH8 to LDAC coefficient byte[15:8]
0x43	ASI_DIN_MIX_ASI_CH8_LDAC_MIX_BYT2[7:0]	0x00	ASI DIN MIXER, ASI CH8 to LDAC coefficient byte[7:0]
0x44	ASI_DIN_MIX_ASI_CH8_RDAC2_MIX_BYT1[7:0]	0x00	ASI DIN MIXER, ASI CH8 to RDAC2 coefficient byte[15:8]
0x45	ASI_DIN_MIX_ASI_CH8_RDAC2_MIX_BYT2[7:0]	0x00	ASI DIN MIXER, ASI CH8 to RDAC2 coefficient byte[7:0]
0x46	ASI_DIN_MIX_ASI_CH8_LDAC2_MIX_BYT1[7:0]	0x00	ASI DIN MIXER, ASI CH8 to LDAC2 coefficient byte[15:8]
0x47	ASI_DIN_MIX_ASI_CH8_LDAC2_MIX_BYT2[7:0]	0x00	ASI DIN MIXER, ASI CH8 to LDAC2 coefficient byte[7:0]
0x48	ASI_DIN_MIX_ASI_AUX_CH1_RDAC_MIX_BYT1[7:0]	0x00	ASI DIN MIXER, ASI AUX_CH1 to RDAC coefficient byte[15:8]
0x49	ASI_DIN_MIX_ASI_AUX_CH1_RDAC_MIX_BYT2[7:0]	0x00	ASI DIN MIXER, ASI AUX_CH1 to RDAC coefficient byte[7:0]
0x4A	ASI_DIN_MIX_ASI_AUX_CH1_LDAC_MIX_BYT1[7:0]	0x40	ASI DIN MIXER, ASI AUX_CH1 to LDAC coefficient byte[15:8]
0x4B	ASI_DIN_MIX_ASI_AUX_CH1_LDAC_MIX_BYT2[7:0]	0x00	ASI DIN MIXER, ASI AUX_CH1 to LDAC coefficient byte[7:0]
0x4C	ASI_DIN_MIX_ASI_AUX_CH1_RDAC2_MIX_BYT1[7:0]	0x00	ASI DIN MIXER, ASI AUX_CH1 to RDAC2 coefficient byte[15:8]
0x4D	ASI_DIN_MIX_ASI_AUX_CH1_RDAC2_MIX_BYT2[7:0]	0x00	ASI DIN MIXER, ASI AUX_CH1 to RDAC2 coefficient byte[7:0]
0x4E	ASI_DIN_MIX_ASI_AUX_CH1_LDAC2_MIX_BYT1[7:0]	0x40	ASI DIN MIXER, ASI AUX_CH1 to LDAC2 coefficient byte[15:8]
0x4F	ASI_DIN_MIX_ASI_AUX_CH1_LDAC2_MIX_BYT2[7:0]	0x00	ASI DIN MIXER, ASI AUX_CH1 to LDAC2 coefficient byte[7:0]
0x50	ASI_DIN_MIX_ASI_AUX_CH2_RDAC_MIX_BYT1[7:0]	0x40	ASI DIN MIXER, ASI AUX_CH2 to RDAC coefficient byte[15:8]
0x51	ASI_DIN_MIX_ASI_AUX_CH2_RDAC_MIX_BYT2[7:0]	0x00	ASI DIN MIXER, ASI AUX_CH2 to RDAC coefficient byte[7:0]

Table 8-216. Page 17 Programmable Coefficient Registers (continued)

0x52	ASI_DIN_MIX_ASI_AUX_CH2_LDAC_MIX_BYT1[7:0]	0x00	ASI DIN MIXER, ASI AUX_CH2 to LDAC coefficient byte[15:8]
0x53	ASI_DIN_MIX_ASI_AUX_CH2_LDAC_MIX_BYT2[7:0]	0x00	ASI DIN MIXER, ASI AUX_CH2 to LDAC coefficient byte[7:0]
0x54	ASI_DIN_MIX_ASI_AUX_CH2_RDAC2_MIX_BYT1[7:0]	0x40	ASI DIN MIXER, ASI AUX_CH2 to RDAC2 coefficient byte[15:8]
0x55	ASI_DIN_MIX_ASI_AUX_CH2_RDAC2_MIX_BYT2[7:0]	0x00	ASI DIN MIXER, ASI AUX_CH2 to RDAC2 coefficient byte[7:0]
0x56	ASI_DIN_MIX_ASI_AUX_CH2_LDAC2_MIX_BYT1[7:0]	0x00	ASI DIN MIXER, ASI AUX_CH2 to LDAC2 coefficient byte[15:8]
0x57	ASI_DIN_MIX_ASI_AUX_CH2_LDAC2_MIX_BYT2[7:0]	0x00	ASI DIN MIXER, ASI AUX_CH2 to LDAC2 coefficient byte[7:0]
0x58	SC_DAC_MIX_ADCLB_CH1_RDAC_MIX_BYT1[7:0]	0x00	SC DAC MIXER, ADC Loopback CH1 to RDAC coefficient byte[15:8]
0x59	SC_DAC_MIX_ADCLB_CH1_RDAC_MIX_BYT2[7:0]	0x00	SC DAC MIXER, ADC Loopback CH1 to RDAC coefficient byte[7:0]
0x5A	SC_DAC_MIX_ADCLB_CH1_LDAC_MIX_BYT1[7:0]	0x00	SC DAC MIXER, ADC Loopback CH1 to LDAC coefficient byte[15:8]
0x5B	SC_DAC_MIX_ADCLB_CH1_LDAC_MIX_BYT2[7:0]	0x00	SC DAC MIXER, ADC Loopback CH1 to LDAC coefficient byte[7:0]
0x5C	SC_DAC_MIX_ADCLB_CH1_RDAC2_MIX_BYT1[7:0]	0x00	SC DAC MIXER, ADC Loopback CH1 to RDAC2 coefficient byte[15:8]
0x5D	SC_DAC_MIX_ADCLB_CH1_RDAC2_MIX_BYT2[7:0]	0x00	SC DAC MIXER, ADC Loopback CH1 to RDAC2 coefficient byte[7:0]
0x5E	SC_DAC_MIX_ADCLB_CH1_LDAC2_MIX_BYT1[7:0]	0x00	SC DAC MIXER, ADC Loopback CH1 to LDAC2 coefficient byte[15:8]
0x5F	SC_DAC_MIX_ADCLB_CH1_LDAC2_MIX_BYT2[7:0]	0x00	SC DAC MIXER, ADC Loopback CH1 to LDAC2 coefficient byte[7:0]
0x60	SC_DAC_MIX_ADCLB_CH2_RDAC_MIX_BYT1[7:0]	0x00	SC DAC MIXER, ADC Loopback CH2 to RDAC coefficient byte[15:8]
0x61	SC_DAC_MIX_ADCLB_CH2_RDAC_MIX_BYT2[7:0]	0x00	SC DAC MIXER, ADC Loopback CH2 to RDAC coefficient byte[7:0]
0x62	SC_DAC_MIX_ADCLB_CH2_LDAC_MIX_BYT1[7:0]	0x00	SC DAC MIXER, ADC Loopback CH2 to LDAC coefficient byte[15:8]
0x63	SC_DAC_MIX_ADCLB_CH2_LDAC_MIX_BYT2[7:0]	0x00	SC DAC MIXER, ADC Loopback CH2 to LDAC coefficient byte[7:0]
0x64	SC_DAC_MIX_ADCLB_CH2_RDAC2_MIX_BYT1[7:0]	0x00	SC DAC MIXER, ADC Loopback CH2 to RDAC2 coefficient byte[15:8]
0x65	SC_DAC_MIX_ADCLB_CH2_RDAC2_MIX_BYT2[7:0]	0x00	SC DAC MIXER, ADC Loopback CH2 to RDAC2 coefficient byte[7:0]
0x66	SC_DAC_MIX_ADCLB_CH2_LDAC2_MIX_BYT1[7:0]	0x00	SC DAC MIXER, ADC Loopback CH2 to LDAC2 coefficient byte[15:8]
0x67	SC_DAC_MIX_ADCLB_CH2_LDAC2_MIX_BYT2[7:0]	0x00	SC DAC MIXER, ADC Loopback CH2 to LDAC2 coefficient byte[7:0]
0x68	SC_DAC_MIX_SIGGEN_CH1_RDAC_MIX_BYT1[7:0]	0x00	SC DAC MIXER, Signal Generator CH1 to RDAC coefficient byte[15:8]
0x69	SC_DAC_MIX_SIGGEN_CH1_RDAC_MIX_BYT2[7:0]	0x00	SC DAC MIXER, Signal Generator CH1 to RDAC coefficient byte[7:0]
0x6A	SC_DAC_MIX_SIGGEN_CH1_LDAC_MIX_BYT1[7:0]	0x00	SC DAC MIXER, Signal Generator CH1 to LDAC coefficient byte[15:8]
0x6B	SC_DAC_MIX_SIGGEN_CH1_LDAC_MIX_BYT2[7:0]	0x00	SC DAC MIXER, Signal Generator CH1 to LDAC coefficient byte[7:0]
0x6C	SC_DAC_MIX_SIGGEN_CH1_RDAC2_MIX_BYT1[7:0]	0x00	SC DAC MIXER, Signal Generator CH1 to RDAC2 coefficient byte[15:8]

Table 8-216. Page 17 Programmable Coefficient Registers (continued)

0x6D	SC_DAC_MIX_SIGGEN_CH1_RDAC2_MIX_BYT2[7:0]	0x00	SC DAC MIXER, Signal Generator CH1 to RDAC2 coefficient byte[7:0]
0x6E	SC_DAC_MIX_SIGGEN_CH1_LDAC2_MIX_BYT1[7:0]	0x00	SC DAC MIXER, Signal Generator CH1 to LDAC2 coefficient byte[15:8]
0x6F	SC_DAC_MIX_SIGGEN_CH1_LDAC2_MIX_BYT2[7:0]	0x00	SC DAC MIXER, Signal Generator CH1 to LDAC2 coefficient byte[7:0]
0x70	SC_DAC_MIX_SIGGEN_CH2_RDAC_MIX_BYT1[7:0]	0x00	SC DAC MIXER, Signal Generator CH2 to RDAC coefficient byte[15:8]
0x71	SC_DAC_MIX_SIGGEN_CH2_RDAC_MIX_BYT2[7:0]	0x00	SC DAC MIXER, Signal Generator CH2 to RDAC coefficient byte[7:0]
0x72	SC_DAC_MIX_SIGGEN_CH2_LDAC_MIX_BYT1[7:0]	0x00	SC DAC MIXER, Signal Generator CH2 to LDAC coefficient byte[15:8]
0x73	SC_DAC_MIX_SIGGEN_CH2_LDAC_MIX_BYT2[7:0]	0x00	SC DAC MIXER, Signal Generator CH2 to LDAC coefficient byte[7:0]
0x74	SC_DAC_MIX_SIGGEN_CH2_RDAC2_MIX_BYT1[7:0]	0x00	SC DAC MIXER, Signal Generator CH2 to RDAC2 coefficient byte[15:8]
0x75	SC_DAC_MIX_SIGGEN_CH2_RDAC2_MIX_BYT2[7:0]	0x00	SC DAC MIXER, Signal Generator CH2 to RDAC2 coefficient byte[7:0]
0x76	SC_DAC_MIX_SIGGEN_CH2_LDAC2_MIX_BYT1[7:0]	0x00	SC DAC MIXER, Signal Generator CH2 to LDAC2 coefficient byte[15:8]
0x77	SC_DAC_MIX_SIGGEN_CH2_LDAC2_MIX_BYT2[7:0]	0x00	SC DAC MIXER, Signal Generator CH2 to LDAC2 coefficient byte[7:0]
0x78	DAC_IIR_N0_BYT1[7:0]	0x7F	Programmable DAC first-order IIR, N0 coefficient byte[31:24]
0x79	DAC_IIR_N0_BYT2[7:0]	0xFF	Programmable DAC first-order IIR, N0 coefficient byte[23:16]
0x7A	DAC_IIR_N0_BYT3[7:0]	0xFF	Programmable DAC first-order IIR, N0 coefficient byte[15:8]
0x7B	DAC_IIR_N0_BYT4[7:0]	0xFF	Programmable DAC first-order IIR, N0 coefficient byte[7:0]
0x7C	DAC_IIR_N1_BYT1[7:0]	0x00	Programmable DAC first-order IIR, N1 coefficient byte[31:24]
0x7D	DAC_IIR_N1_BYT2[7:0]	0x00	Programmable DAC first-order IIR, N1 coefficient byte[23:16]
0x7E	DAC_IIR_N1_BYT3[7:0]	0x00	Programmable DAC first-order IIR, N1 coefficient byte[15:8]
0x7F	DAC_IIR_N1_BYT4[7:0]	0x00	Programmable DAC first-order IIR, N1 coefficient byte[7:0]

8.2.8 Programmable Coefficient Registers: Page 18

This register page shown in [Table 8-217](#) consists of the programmable coefficients for the DAC first-order IIR filter, DAC digital volume control for channels 1 to 4 and DAC Beep generator.

Table 8-217. Page 18 Programmable Coefficient Registers

ADDRESS	REGISTER	RESET	DESCRIPTION
0x00	PAGE[7:0]	0x00	Device Page Register
0x08	DAC_IIR_D1_BYT1[7:0]	0x00	Programmable DAC first-order IIR, D1 coefficient byte[31:24]
0x09	DAC_IIR_D1_BYT2[7:0]	0x00	Programmable DAC first-order IIR, D1 coefficient byte[23:16]
0x0A	DAC_IIR_D1_BYT3[7:0]	0x00	Programmable DAC first-order IIR, D1 coefficient byte[15:8]
0x0B	DAC_IIR_D1_BYT4[7:0]	0x00	Programmable DAC first-order IIR, D1 coefficient byte[7:0]
0x0C	DAC_VOL_CH1_BYT1[7:0]	0x00	Digital volume control, DAC channel 1 coefficient byte[31:24]
0x0D	DAC_VOL_CH1_BYT2[7:0]	0x80	Digital volume control, DAC channel 1 coefficient byte[23:16]
0x0E	DAC_VOL_CH1_BYT3[7:0]	0x00	Digital volume control, DAC channel 1 coefficient byte[15:8]
0x0F	DAC_VOL_CH1_BYT4[7:0]	0x00	Digital volume control, DAC channel 1 coefficient byte[7:0]
0x10	DAC_VOL_CH2_BYT1[7:0]	0x00	Digital volume control, DAC channel 2 coefficient byte[31:24]
0x11	DAC_VOL_CH2_BYT2[7:0]	0x80	Digital volume control, DAC channel 2 coefficient byte[23:16]
0x12	DAC_VOL_CH2_BYT3[7:0]	0x00	Digital volume control, DAC channel 2 coefficient byte[15:8]
0x13	DAC_VOL_CH2_BYT4[7:0]	0x00	Digital volume control, DAC channel 2 coefficient byte[7:0]

Table 8-217. Page 18 Programmable Coefficient Registers (continued)

0x14	DAC_VOL_CH3_BYT1[7:0]	0x00	Digital volume control, DAC channel 3 coefficient byte[31:24]
0x15	DAC_VOL_CH3_BYT2[7:0]	0x80	Digital volume control, DAC channel 3 coefficient byte[23:16]
0x16	DAC_VOL_CH3_BYT3[7:0]	0x00	Digital volume control, DAC channel 3 coefficient byte[15:8]
0x17	DAC_VOL_CH3_BYT4[7:0]	0x00	Digital volume control, DAC channel 3 coefficient byte[7:0]
0x18	DAC_VOL_CH4_BYT1[7:0]	0x00	Digital volume control, DAC channel 4 coefficient byte[31:24]
0x19	DAC_VOL_CH4_BYT2[7:0]	0x80	Digital volume control, DAC channel 4 coefficient byte[23:16]
0x1A	DAC_VOL_CH4_BYT3[7:0]	0x00	Digital volume control, DAC channel 4 coefficient byte[15:8]
0x1B	DAC_VOL_CH4_BYT4[7:0]	0x00	Digital volume control, DAC channel 4 coefficient byte[7:0]
0x20	DAC_BEEP GEN_SINX_BYT1[7:0]	0x45	Programmable DAC BEEP GEN sin(x) coefficient byte[31:24]
0x21	DAC_BEEP GEN_SINX_BYT2[7:0]	0xF4	Programmable DAC BEEP GEN sin(x) coefficient byte[23:16]
0x22	DAC_BEEP GEN_SINX_BYT3[7:0]	0x61	Programmable DAC BEEP GEN sin(x) coefficient byte[15:8]
0x23	DAC_BEEP GEN_SINX_BYT4[7:0]	0xD0	Programmable DAC BEEP GEN sin(x) coefficient byte[7:0]
0x24	DAC_BEEP GEN_COSX_BYT1[7:0]	0x7F	Programmable DAC BEEP GEN cos(x) coefficient byte[31:24]
0x25	DAC_BEEP GEN_COSX_BYT2[7:0]	0xFE	Programmable DAC BEEP GEN cos(x) coefficient byte[23:16]
0x26	DAC_BEEP GEN_COSX_BYT3[7:0]	0xFD	Programmable DAC BEEP GEN cos(x) coefficient byte[15:8]
0x27	DAC_BEEP GEN_COSX_BYT4[7:0]	0x46	Programmable DAC BEEP GEN cos(x) coefficient byte[7:0]
0x28	DAC_BEEP GEN2_SINX_BYT1[7:0]	0x5D	Programmable DAC BEEP GEN2 sin(x) coefficient byte[31:24]
0x29	DAC_BEEP GEN2_SINX_BYT2[7:0]	0xA2	Programmable DAC BEEP GEN2 sin(x) coefficient byte[23:16]
0x2A	DAC_BEEP GEN2_SINX_BYT3[7:0]	0x74	Programmable DAC BEEP GEN2 sin(x) coefficient byte[15:8]
0x2B	DAC_BEEP GEN2_SINX_BYT4[7:0]	0xB4	Programmable DAC BEEP GEN2 sin(x) coefficient byte[7:0]
0x2C	DAC_BEEP GEN2_COSX_BYT1[7:0]	0x01	Programmable DAC BEEP GEN2 cos(x) coefficient byte[31:24]
0x2D	DAC_BEEP GEN2_COSX_BYT2[7:0]	0x01	Programmable DAC BEEP GEN2 cos(x) coefficient byte[23:16]
0x2E	DAC_BEEP GEN2_COSX_BYT3[7:0]	0x5B	Programmable DAC BEEP GEN2 cos(x) coefficient byte[15:8]
0x2F	DAC_BEEP GEN2_COSX_BYT4[7:0]	0x4B	Programmable DAC BEEP GEN2 cos(x) coefficient byte[7:0]

8.2.9 Programmable Coefficient Registers: Page 19

This register page shown in [Table 8-218](#) consists of the programmable coefficients for the ADC and DAC MSA for channels 1 to 4.

Table 8-218. Page 19 Programmable Coefficient Registers

ADDRESS	REGISTER	RESET	DESCRIPTION
0x00	PAGE[7:0]	0x00	Device Page Register
0x58	ADC_CH1_SF1_BYT1[7:0]	0x04	ADC CH1 MSA coefficient byte[31:24]
0x59	ADC_CH1_SF1_BYT2[7:0]	0x00	ADC CH1 MSA coefficient byte[23:16]
0x5A	ADC_CH1_SF1_BYT3[7:0]	0x00	ADC CH1 MSA coefficient byte[15:8]
0x5B	ADC_CH1_SF1_BYT4[7:0]	0x00	ADC CH1 MSA coefficient byte[7:0]

Table 8-218. Page 19 Programmable Coefficient Registers (continued)

0x5C	ADC_CH2_SF1_BYT1[7:0]	0x04	ADC CH2 MSA coefficient byte[31:24]
0x5D	ADC_CH2_SF1_BYT2[7:0]	0x00	ADC CH2 MSA coefficient byte[23:16]
0x5E	ADC_CH2_SF1_BYT3[7:0]	0x00	ADC CH2 MSA coefficient byte[15:8]
0x5F	ADC_CH2_SF1_BYT4[7:0]	0x00	ADC CH2 MSA coefficient byte[7:0]
0x60	ADC_CH3_SF1_BYT1[7:0]	0x04	ADC CH3 MSA coefficient byte[31:24]
0x61	ADC_CH3_SF1_BYT2[7:0]	0x00	ADC CH3 MSA coefficient byte[23:16]
0x62	ADC_CH3_SF1_BYT3[7:0]	0x00	ADC CH3 MSA coefficient byte[15:8]
0x63	ADC_CH3_SF1_BYT4[7:0]	0x00	ADC CH3 MSA coefficient byte[7:0]
0x64	ADC_CH4_SF1_BYT1[7:0]	0x04	ADC CH4 MSA coefficient byte[31:24]
0x65	ADC_CH4_SF1_BYT2[7:0]	0x00	ADC CH4 MSA coefficient byte[23:16]
0x66	ADC_CH4_SF1_BYT3[7:0]	0x00	ADC CH4 MSA coefficient byte[15:8]
0x67	ADC_CH4_SF1_BYT4[7:0]	0x00	ADC CH4 MSA coefficient byte[7:0]
0x68	LDAC_SF1_BYT1[7:0]	0x04	LDAC MSA coefficient byte[31:24]
0x69	LDAC_SF1_BYT2[7:0]	0x00	LDAC MSA coefficient byte[23:16]
0x6A	LDAC_SF1_BYT3[7:0]	0x00	LDAC MSA coefficient byte[15:8]
0x6B	LDAC_SF1_BYT4[7:0]	0x00	LDAC MSA coefficient byte[7:0]
0x6C	RDAC_SF1_BYT1[7:0]	0x04	RDAC MSA coefficient byte[31:24]
0x6D	RDAC_SF1_BYT2[7:0]	0x00	RDAC MSA coefficient byte[23:16]
0x6E	RDAC_SF1_BYT3[7:0]	0x00	RDAC MSA coefficient byte[15:8]
0x6F	RDAC_SF1_BYT4[7:0]	0x00	RDAC MSA coefficient byte[7:0]
0x70	LDAC2_SF1_BYT1[7:0]	0x04	LDAC2 MSA coefficient byte[31:24]
0x71	LDAC2_SF1_BYT2[7:0]	0x00	LDAC2 MSA coefficient byte[23:16]
0x72	LDAC2_SF1_BYT3[7:0]	0x00	LDAC2 MSA coefficient byte[15:8]
0x73	LDAC2_SF1_BYT4[7:0]	0x00	LDAC2 MSA coefficient byte[7:0]
0x74	RDAC2_SF1_BYT1[7:0]	0x04	RDAC2 MSA coefficient byte[31:24]
0x75	RDAC2_SF1_BYT2[7:0]	0x00	RDAC2 MSA coefficient byte[23:16]
0x76	RDAC2_SF1_BYT3[7:0]	0x00	RDAC2 MSA coefficient byte[15:8]
0x77	RDAC2_SF1_BYT4[7:0]	0x00	RDAC2 MSA coefficient byte[7:0]

8.2.10 Programmable Coefficient Registers: Page 25

This register page shown in [Table 8-219](#) consists of the programmable coefficients for the DAC Limiter.

Table 8-219. Page 25 Programmable Coefficient Registers

ADDRESS	REGISTER	RESET	DESCRIPTION
0x00	PAGE[7:0]	0x00	Device Page Register
0x60	LIMITER_ATTACK_COEFF_BYT1[7:0]	0x78	Distortion limiter Attack coefficient byte[31:24]
0x61	LIMITER_ATTACK_COEFF_BYT2[7:0]	0xD6	Distortion limiter Attack coefficient byte[23:16]
0x62	LIMITER_ATTACK_COEFF_BYT3[7:0]	0xFC	Distortion limiter Attack coefficient byte[15:8]
0x63	LIMITER_ATTACK_COEFF_BYT4[7:0]	0x9F	Distortion limiter Attack coefficient byte[7:0]
0x64	LIMITER_RELEASE_COEFF_BYT1[7:0]	0x40	Distortion limiter Release coefficient byte[31:24]
0x65	LIMITER_RELEASE_COEFF_BYT2[7:0]	0xBD	Distortion limiter Release coefficient byte[23:16]
0x66	LIMITER_RELEASE_COEFF_BYT3[7:0]	0xB7	Distortion limiter Release coefficient byte[15:8]

Table 8-219. Page 25 Programmable Coefficient Registers (continued)

0x67	LIMITER_RELEASE_COEFF_BYTE4[7:0]	0xC0	Distortion limiter Release coefficient byte[7:0]
0x68	LIMITER_ENV_DECAY_COEFF_BYTE1[7:0]	0x7F	Distortion limiter envelope decay coefficient byte[31:24]
0x69	LIMITER_ENV_DECAY_COEFF_BYTE2[7:0]	0xFC	Distortion limiter envelope decay coefficient byte[23:16]
0x6A	LIMITER_ENV_DECAY_COEFF_BYTE3[7:0]	0x3A	Distortion limiter envelope decay coefficient byte[15:8]
0x6B	LIMITER_ENV_DECAY_COEFF_BYTE4[7:0]	0x48	Distortion limiter envelope decay coefficient byte[7:0]
0x6C	LIMITER_THRESHOLD_MAX_BYTE1[7:0]	0x01	Distortion limiter Threshold Max coefficient byte[31:24]
0x6D	LIMITER_THRESHOLD_MAX_BYTE2[7:0]	0x69	Distortion limiter Threshold Max coefficient byte[23:16]
0x6E	LIMITER_THRESHOLD_MAX_BYTE3[7:0]	0x9C	Distortion limiter Threshold Max coefficient byte[15:8]
0x6F	LIMITER_THRESHOLD_MAX_BYTE4[7:0]	0x10	Distortion limiter Threshold Max coefficient byte[7:0]
0x70	LIMITER_THRESHOLD_MIN_BYTE1[7:0]	0x00	Distortion limiter Threshold Min coefficient byte[31:24]
0x71	LIMITER_THRESHOLD_MIN_BYTE2[7:0]	0x72	Distortion limiter Threshold Min coefficient byte[23:16]
0x72	LIMITER_THRESHOLD_MIN_BYTE3[7:0]	0x59	Distortion limiter Threshold Min coefficient byte[15:8]
0x73	LIMITER_THRESHOLD_MIN_BYTE4[7:0]	0xDB	Distortion limiter Threshold Min coefficient byte[7:0]
0x74	LIMITER_INFLECTION_POINT_BYTE1[7:0]	0x00	Distortion limiter Inflection Point coefficient byte[31:24]
0x75	LIMITER_INFLECTION_POINT_BYTE2[7:0]	0x00	Distortion limiter Inflection Point coefficient byte[23:16]
0x76	LIMITER_INFLECTION_POINT_BYTE3[7:0]	0x19	Distortion limiter Inflection Point coefficient byte[15:8]
0x77	LIMITER_INFLECTION_POINT_BYTE4[7:0]	0x9A	Distortion limiter Inflection Point coefficient byte[7:0]
0x78	LIMITER_SLOPE_BYTE1[7:0]	0x10	Distortion limiter Slope coefficient byte[31:24]
0x79	LIMITER_SLOPE_BYTE2[7:0]	0x00	Distortion limiter Slope coefficient byte[23:16]
0x7A	LIMITER_SLOPE_BYTE3[7:0]	0x00	Distortion limiter Slope coefficient byte[15:8]
0x7B	LIMITER_SLOPE_BYTE4[7:0]	0x00	Distortion limiter Slope coefficient byte[7:0]
0x7C	LIMITER_RESET_COUNTER_BYTE1[7:0]	0x00	Distortion limiter Hold Count coefficient byte[31:24]
0x7D	LIMITER_RESET_COUNTER_BYTE2[7:0]	0x00	Distortion limiter Hold Count coefficient byte[23:16]
0x7E	LIMITER_RESET_COUNTER_BYTE3[7:0]	0x09	Distortion limiter Hold Count coefficient byte[15:8]
0x7F	LIMITER_RESET_COUNTER_BYTE4[7:0]	0x60	Distortion limiter Hold Count coefficient byte[7:0]

8.2.11 Programmable Coefficient Registers: Page 26

This register page shown in [Section 8.2.11](#) consists of the programmable coefficients for the DAC brownout protection (BOP), thermal foldback (THF) protection and Limiter.

Table 8-220. Page 26 Programmable Coefficient Registers

ADDRESS	REGISTER	RESET	DESCRIPTION
0x00	PAGE[7:0]	0x00	Device Page Register

Table 8-220. Page 26 Programmable Coefficient Registers (continued)

0x14	BOP_ATTACK_COEFF_BYT1[7:0]	0x78	BOP Attack coefficient byte[31:24]
0x15	BOP_ATTACK_COEFF_BYT2[7:0]	0xD6	BOP Attack coefficient byte[23:16]
0x16	BOP_ATTACK_COEFF_BYTT3[7:0]	0xFC	BOP Attack coefficient byte[15:8]
0x17	BOP_ATTACK_COEFF_BYTT4[7:0]	0x9F	BOP Attack coefficient byte[7:0]
0x18	BOP_RELEASE_COEFF_BYT1[7:0]	0x40	BOP Release coefficient byte[31:24]
0x19	BOP_RELEASE_COEFF_BYT2[7:0]	0xBD	BOP Release coefficient byte[23:16]
0x1A	BOP_RELEASE_COEFF_BYTT3[7:0]	0xB7	BOP Release coefficient byte[15:8]
0x1B	BOP_RELEASE_COEFF_BYTT4[7:0]	0xC0	BOP Release coefficient byte[7:0]
0x1C	BOP_RESET_COUNTER_BYT1[7:0]	0x00	BOP Hold Count coefficient byte[31:24]
0x1D	BOP_RESET_COUNTER_BYT2[7:0]	0x00	BOP Hold Count coefficient byte[23:16]
0x1E	BOP_RESET_COUNTER_BYTT3[7:0]	0x09	BOP Hold Count coefficient byte[15:8]
0x1F	BOP_RESET_COUNTER_BYTT4[7:0]	0x60	BOP Hold Count coefficient byte[7:0]
0x20	BOP_VSUP_TH1_BYT1[7:0]	0x00	BOP Supply Threshold1 coefficient byte[31:24]
0x21	BOP_VSUP_TH1_BYT2[7:0]	0x00	BOP Supply Threshold1 coefficient byte[23:16]
0x22	BOP_VSUP_TH1_BYTT3[7:0]	0x19	BOP Supply Threshold1 coefficient byte[15:8]
0x23	BOP_VSUP_TH1_BYTT4[7:0]	0x9A	BOP Supply Threshold1 coefficient byte[7:0]
0x24	BOP_THRESHOLD1_BYT1[7:0]	0x2D	BOP Threshold1 Gain coefficient byte[31:24]
0x25	BOP_THRESHOLD1_BYT2[7:0]	0x4E	BOP Threshold1 Gain coefficient byte[23:16]
0x26	BOP_THRESHOLD1_BYTT3[7:0]	0xFB	BOP Threshold1 Gain coefficient byte[15:8]
0x27	BOP_THRESHOLD1_BYTT4[7:0]	0xD6	BOP Threshold1 Gain coefficient byte[7:0]
0x28	BOP_VSUP_TH2_BYT1[7:0]	0x00	BOP Supply Threshold2 coefficient byte[31:24]
0x29	BOP_VSUP_TH2_BYT2[7:0]	0x00	BOP Supply Threshold2 coefficient byte[23:16]
0x2A	BOP_VSUP_TH2_BYTT3[7:0]	0x16	BOP Supply Threshold2 coefficient byte[15:8]
0x2B	BOP_VSUP_TH2_BYTT4[7:0]	0x66	BOP Supply Threshold2 coefficient byte[7:0]
0x2C	BOP_THRESHOLD2_BYT1[7:0]	0x14	BOP Threshold2 Gain coefficient byte[31:24]
0x2D	BOP_THRESHOLD2_BYT2[7:0]	0x3D	BOP Threshold2 Gain coefficient byte[23:16]
0x2E	BOP_THRESHOLD2_BYTT3[7:0]	0x13	BOP Threshold2 Gain coefficient byte[15:8]
0x2F	BOP_THRESHOLD2_BYTT4[7:0]	0x62	BOP Threshold2 Gain coefficient byte[7:0]
0x30	THF_ATTACK_COEFF_BYT1[7:0]	0x78	THF Attack coefficient byte[31:24]
0x31	THF_ATTACK_COEFF_BYT2[7:0]	0xD6	THF Attack coefficient byte[23:16]

Table 8-220. Page 26 Programmable Coefficient Registers (continued)

0x32	THF_ATTACK_COEFF_BYTT3[7:0]	0xFC	THF Attack coefficient byte[15:8]
0x33	THF_ATTACK_COEFF_BYTT4[7:0]	0x9F	THF Attack coefficient byte[7:0]
0x34	THF_RELEASE_COEFF_BYT1[7:0]	0x40	THF Release coefficient byte[31:24]
0x35	THF_RELEASE_COEFF_BYT2[7:0]	0xBD	THF Release coefficient byte[23:16]
0x36	THF_RELEASE_COEFF_BYTT3[7:0]	0xB7	THF Release coefficient byte[15:8]
0x37	THF_RELEASE_COEFF_BYTT4[7:0]	0xC0	THF Release coefficient byte[7:0]
0x38	THF_RESET_COUNTER_BYT1[7:0]	0x00	THF Hold Count coefficient byte[31:24]
0x39	THF_RESET_COUNTER_BYT2[7:0]	0x00	THF Hold Count coefficient byte[23:16]
0x3A	THF_RESET_COUNTER_BYTT3[7:0]	0x09	THF Hold Count coefficient byte[15:8]
0x3B	THF_RESET_COUNTER_BYTT4[7:0]	0x60	THF Hold Count coefficient byte[7:0]
0x3C	THF_TEMP_THRESHOLD_BYT1[7:0]	0x00	THF Temperature Threshold coefficient byte[31:24]
0x3D	THF_TEMP_THRESHOLD_BYT2[7:0]	0x00	THF Temperature Threshold coefficient byte[23:16]
0x3E	THF_TEMP_THRESHOLD_BYTT3[7:0]	0x23	THF Temperature Threshold coefficient byte[15:8]
0x3F	THF_TEMP_THRESHOLD_BYTT4[7:0]	0x80	THF Temperature Threshold coefficient byte[7:0]
0x40	THF_MAX_ATTEN_BYT1[7:0]	0x2D	THF Max Attenuation coefficient byte[31:24]
0x41	THF_MAX_ATTEN_BYT2[7:0]	0x6A	THF Max Attenuation coefficient byte[23:16]
0x42	THF_MAX_ATTEN_BYTT3[7:0]	0x86	THF Max Attenuation coefficient byte[15:8]
0x43	THF_MAX_ATTEN_BYTT4[7:0]	0x6F	THF Max Attenuation coefficient byte[7:0]
0x44	THF_SLOPE_BYT1[7:0]	0xFE	THF Slope coefficient byte[31:24]
0x45	THF_SLOPE_BYT2[7:0]	0x66	THF Slope coefficient byte[23:16]
0x46	THF_SLOPE_BYTT3[7:0]	0x66	THF Slope coefficient byte[15:8]
0x47	THF_SLOPE_BYTT4[7:0]	0x66	THF Slope coefficient byte[7:0]
0x48	LIMITER_ATTACK_HYS_LEVEL_BYT1[7:0]	0x08	Distortion Limiter Attack Level Hysteresis coefficient byte[31:24]
0x49	LIMITER_ATTACK_HYS_LEVEL_BYT2[7:0]	0xF9	Distortion Limiter Attack Level Hysteresis coefficient byte[23:16]
0x4A	LIMITER_ATTACK_HYS_LEVEL_BYTT3[7:0]	0xE4	Distortion Limiter Attack Level Hysteresis coefficient byte[15:8]
0x4B	LIMITER_ATTACK_HYS_LEVEL_BYTT4[7:0]	0xD0	Distortion Limiter Attack Level Hysteresis coefficient byte[7:0]
0x4C	LIMITER_RELEASE_HYS_LEVEL_BYT1[7:0]	0x07	Distortion Limiter Release Level Hysteresis coefficient byte[31:24]
0x4D	LIMITER_RELEASE_HYS_LEVEL_BYT2[7:0]	0x21	Distortion Limiter Release Level Hysteresis coefficient byte[23:16]
0x4E	LIMITER_RELEASE_HYS_LEVEL_BYTT3[7:0]	0x48	Distortion Limiter Release Level Hysteresis coefficient byte[15:8]
0x4F	LIMITER_RELEASE_HYS_LEVEL_BYTT4[7:0]	0x2C	Distortion Limiter Release Level Hysteresis coefficient byte[7:0]

Table 8-220. Page 26 Programmable Coefficient Registers (continued)

0x50	BOP_LEVEL_HYS_SUP_BYT1[7:0]	0x00	BOP Level Hysteresis coefficient byte[31:24]
0x51	BOP_LEVEL_HYS_SUP_BYT2[7:0]	0x00	BOP Level Hysteresis coefficient byte[23:16]
0x52	BOP_LEVEL_HYS_SUP_BYTT3[7:0]	0x00	BOP Level Hysteresis coefficient byte[15:8]
0x53	BOP_LEVEL_HYS_SUP_BYTT4[7:0]	0x14	BOP Level Hysteresis coefficient byte[7:0]
0x54	BOP_LEVEL_HYS_GAIN_BYT1[7:0]	0x03	BOP gain Hysteresis coefficient byte[31:24]
0x55	BOP_LEVEL_HYS_GAIN_BYT2[7:0]	0xD7	BOP gain Hysteresis coefficient byte[23:16]
0x56	BOP_LEVEL_HYS_GAIN_BYTT3[7:0]	0x0A	BOP gain Hysteresis coefficient byte[15:8]
0x57	BOP_LEVEL_HYS_GAIN_BYTT4[7:0]	0x3E	BOP gain Hysteresis coefficient byte[7:0]
0x58	THF_GAIN_HYS_BYT1[7:0]	0x03	THF gain Hysteresis coefficient byte[31:24]
0x59	THF_GAIN_HYS_BYT2[7:0]	0xD7	THF gain Hysteresis coefficient byte[23:16]
0x5A	THF_GAIN_HYS_BYTT3[7:0]	0x0A	THF gain Hysteresis coefficient byte[15:8]
0x5B	THF_GAIN_HYS_BYTT4[7:0]	0x3D	THF gain Hysteresis coefficient byte[7:0]

8.2.12 Programmable Coefficient Registers: Page 27

This register page shown in [Table 8-221](#) consists of the programmable coefficients for the ADC AGC.

Table 8-221. Page 27 Programmable Coefficient Registers

ADDRESS	REGISTER	RESET	DESCRIPTION
0x00	PAGE[7:0]	0x00	Device Page Register
0x5C	AGC_NOISE_FLOOR_BYT1[7:0]	0xFF	AGC Noise Floor coefficient byte[31:24]
0x5D	AGC_NOISE_FLOOR_BYT2[7:0]	0xFE	AGC Noise Floor coefficient byte[23:16]
0x5E	AGC_NOISE_FLOOR_BYTT3[7:0]	0xB0	AGC Noise Floor coefficient byte[15:8]
0x5F	AGC_NOISE_FLOOR_BYTT4[7:0]	0x00	AGC Noise Floor coefficient byte[7:0]
0x60	AGC_TARGET_LEVEL_BYT1[7:0]	0xFF	AGC Target Level coefficient byte[31:24]
0x61	AGC_TARGET_LEVEL_BYT2[7:0]	0xFF	AGC Target Level coefficient byte[23:16]
0x62	AGC_TARGET_LEVEL_BYTT3[7:0]	0x78	AGC Target Level coefficient byte[15:8]
0x63	AGC_TARGET_LEVEL_BYTT4[7:0]	0x00	AGC Target Level coefficient byte[7:0]
0x64	AGC_NOISE_COUNT_MAX_BYT1[7:0]	0x00	AGC Noise Floor Hold Count coefficient byte[31:24]
0x65	AGC_NOISE_COUNT_MAX_BYT2[7:0]	0x00	AGC Noise Floor Hold Count coefficient byte[23:16]
0x66	AGC_NOISE_COUNT_MAX_BYTT3[7:0]	0x04	AGC Noise Floor Hold Count coefficient byte[15:8]
0x67	AGC_NOISE_COUNT_MAX_BYTT4[7:0]	0xB0	AGC Noise Floor Hold Count coefficient byte[7:0]
0x68	AGC_MAX_GAIN_BYT1[7:0]	0x00	AGC Maximum Gain coefficient byte[31:24]
0x69	AGC_MAX_GAIN_BYT2[7:0]	0x00	AGC Maximum Gain coefficient byte[23:16]

Table 8-221. Page 27 Programmable Coefficient Registers (continued)

0x6A	AGC_MAX_GAIN_BYTT3[7:0]	0x60	AGC Maximum Gain coefficient byte[15:8]
0x6B	AGC_MAX_GAIN_BYTT4[7:0]	0x00	AGC Maximum Gain coefficient byte[7:0]
0x6C	AGC_MIN_GAIN_BYT1[7:0]	0xFF	AGC Minimum Gain coefficient byte[31:24]
0x6D	AGC_MIN_GAIN_BYT2[7:0]	0xFF	AGC Minimum Gain coefficient byte[23:16]
0x6E	AGC_MIN_GAIN_BYTT3[7:0]	0x88	AGC Minimum Gain coefficient byte[15:8]
0x6F	AGC_MIN_GAIN_BYTT4[7:0]	0x00	AGC Minimum Gain coefficient byte[7:0]
0x70	AGC_NOISE_HYS_BYT1[7:0]	0x00	AGC Noise Gate Hysteresis coefficient byte[31:24]
0x71	AGC_NOISE_HYS_BYT2[7:0]	0x00	AGC Noise Gate Hysteresis coefficient byte[23:16]
0x72	AGC_NOISE_HYS_BYTT3[7:0]	0x18	AGC Noise Gate Hysteresis coefficient byte[15:8]
0x73	AGC_NOISE_HYS_BYTT4[7:0]	0x00	AGC Noise Gate Hysteresis coefficient byte[7:0]
0x74	AGC_ATTACK_HOLD_COUNT_BYT1[7:0]	0x00	AGC Attack Hold Count coefficient byte[31:24]
0x75	AGC_ATTACK_HOLD_COUNT_BYT2[7:0]	0x00	AGC Attack Hold Count coefficient byte[23:16]
0x76	AGC_ATTACK_HOLD_COUNT_BYTT3[7:0]	0x00	AGC Attack Hold Count coefficient byte[15:8]
0x77	AGC_ATTACK_HOLD_COUNT_BYTT4[7:0]	0x01	AGC Attack Hold Count coefficient byte[7:0]
0x78	AGC_RELEASE_HOLD_COUNT_BYT1[7:0]	0x00	AGC Release Hold Count coefficient byte[31:24]
0x79	AGC_RELEASE_HOLD_COUNT_BYT2[7:0]	0x00	AGC Release Hold Count coefficient byte[23:16]
0x7A	AGC_RELEASE_HOLD_COUNT_BYTT3[7:0]	0x04	AGC Release Hold Count coefficient byte[15:8]
0x7B	AGC_RELEASE_HOLD_COUNT_BYTT4[7:0]	0xB0	AGC Release Hold Count coefficient byte[7:0]
0x7C	AGC_RELEASE_HYST_BYT1[7:0]	0x00	AGC Release Hysteresis coefficient byte[31:24]
0x7D	AGC_RELEASE_HYST_BYT2[7:0]	0x00	AGC Release Hysteresis coefficient byte[23:16]
0x7E	AGC_RELEASE_HYST_BYTT3[7:0]	0x08	AGC Release Hysteresis coefficient byte[15:8]
0x7F	AGC_RELEASE_HYST_BYTT4[7:0]	0x00	AGC Release Hysteresis coefficient byte[7:0]

8.2.13 Programmable Coefficient Registers: Page 28

This register page shown in [Section 8.2.13](#) consists of the programmable coefficients for the ADC AGC and DAC DRC.

Table 8-222. Page 28 Programmable Coefficient Registers

ADDRESS	REGISTER	RESET	DESCRIPTION
0x00	PAGE[7:0]	0x00	Device Page Register
0x08	AGC_ATTACK_RATE_BYT1[7:0]	0x50	AGC Attack Rate coefficient byte[31:24]
0x09	AGC_ATTACK_RATE_BYT2[7:0]	0xFC	AGC Attack Rate coefficient byte[23:16]
0x0A	AGC_ATTACK_RATE_BYTT3[7:0]	0x64	AGC Attack Rate coefficient byte[15:8]
0x0B	AGC_ATTACK_RATE_BYTT4[7:0]	0x5C	AGC Attack Rate coefficient byte[7:0]
0x0C	AGC_RELEASE_RATE_BYT1[7:0]	0x7F	AGC Release Rate coefficient byte[31:24]

Table 8-222. Page 28 Programmable Coefficient Registers (continued)

0x0D	AGC_RELEASE_RATE_BYT2[7:0]	0xC4	AGC Release Rate coefficient byte[23:16]
0x0E	AGC_RELEASE_RATE_BYTT3[7:0]	0x0E	AGC Release Rate coefficient byte[15:8]
0x0F	AGC_RELEASE_RATE_BYTT4[7:0]	0x57	AGC Release Rate coefficient byte[7:0]
0x1C	DRC_MAX_GAIN_BYT1[7:0]	0x00	DRC Maximum Gain (dB) coefficient byte[31:24]
0x1D	DRC_MAX_GAIN_BYT2[7:0]	0x00	DRC Maximum Gain (dB) coefficient byte[23:16]
0x1E	DRC_MAX_GAIN_BYTT3[7:0]	0x60	DRC Maximum Gain (dB) coefficient byte[15:8]
0x1F	DRC_MAX_GAIN_BYTT4[7:0]	0x00	DRC Maximum Gain (dB) coefficient byte[7:0]
0x20	DRC_MIN_GAIN_BYT1[7:0]	0xFF	DRC Minimum Gain (dB) coefficient byte[31:24]
0x21	DRC_MIN_GAIN_BYT2[7:0]	0xFF	DRC Minimum Gain (dB) coefficient byte[23:16]
0x22	DRC_MIN_GAIN_BYTT3[7:0]	0x82	DRC Minimum Gain (dB) coefficient byte[15:8]
0x23	DRC_MIN_GAIN_BYTT4[7:0]	0x00	DRC Minimum Gain (dB) coefficient byte[7:0]
0x24	DRC_ATTACK_TC_BYT1[7:0]	0x67	DRC Attack Time Constant coefficient byte[31:24]
0x25	DRC_ATTACK_TC_BYT2[7:0]	0xED	DRC Attack Time Constant coefficient byte[23:16]
0x26	DRC_ATTACK_TC_BYTT3[7:0]	0x87	DRC Attack Time Constant coefficient byte[15:8]
0x27	DRC_ATTACK_TC_BYTT4[7:0]	0xBB	DRC Attack Time Constant coefficient byte[7:0]
0x28	DRC_RELEASE_TC_BYT1[7:0]	0x7E	DRC Release Time Constant coefficient byte[31:24]
0x29	DRC_RELEASE_TC_BYT2[7:0]	0xAC	DRC Release Time Constant coefficient byte[23:16]
0x2A	DRC_RELEASE_TC_BYTT3[7:0]	0x70	DRC Release Time Constant coefficient byte[15:8]
0x2B	DRC_RELEASE_TC_BYTT4[7:0]	0x34	DRC Release Time Constant coefficient byte[7:0]
0x2C	DRC_RELEASE_HOLD_COUNT_BYT1[7:0]	0x00	DRC Release Hold Count coefficient byte[31:24]
0x2D	DRC_RELEASE_HOLD_COUNT_BYT2[7:0]	0x00	DRC Release Hold Count coefficient byte[23:16]
0x2E	DRC_RELEASE_HOLD_COUNT_BYTT3[7:0]	0x04	DRC Release Hold Count coefficient byte[15:8]
0x2F	DRC_RELEASE_HOLD_COUNT_BYTT4[7:0]	0xB0	DRC Release Hold Count coefficient byte[7:0]
0x30	DRC_RELEASE_HYST_BYT1[7:0]	0x00	DRC Release Hysteresis coefficient byte[31:24]
0x31	DRC_RELEASE_HYST_BYT2[7:0]	0x00	DRC Release Hysteresis coefficient byte[23:16]
0x32	DRC_RELEASE_HYST_BYTT3[7:0]	0x0C	DRC Release Hysteresis coefficient byte[15:8]
0x33	DRC_RELEASE_HYST_BYTT4[7:0]	0x00	DRC Release Hysteresis coefficient byte[7:0]
0x34	DRC_INV_RATIO_BYT1[7:0]	0xF8	DRC Ratio coefficient byte[31:24]
0x35	DRC_INV_RATIO_BYT2[7:0]	0x00	DRC Ratio coefficient byte[23:16]
0x36	DRC_INV_RATIO_BYTT3[7:0]	0x00	DRC Ratio coefficient byte[15:8]
0x37	DRC_INV_RATIO_BYTT4[7:0]	0x00	DRC Ratio coefficient byte[7:0]
0x38	DRC_INFLECTION_PT_BYT1[7:0]	0xFF	DRC Inflection Point(dB) coefficient byte[31:24]
0x39	DRC_INFLECTION_PT_BYT2[7:0]	0xFF	DRC Inflection Point(dB) coefficient byte[23:16]
0x3A	DRC_INFLECTION_PT_BYTT3[7:0]	0xA0	DRC Inflection Point(dB) coefficient byte[15:8]

Table 8-222. Page 28 Programmable Coefficient Registers (continued)

0x3B	DRC_INFLECTION_PT_BYTT4[7:0]	0x00	DRC Inflection Point(dB) coefficient byte[7:0]
0x40	DAC_ADSR_NOTE_BYT1[7:0]	0x00	ADSR Enable/Disable coefficient byte[31:24]
0x41	DAC_ADSR_NOTE_BYT2[7:0]	0x00	ADSR Enable/Disable coefficient byte[23:16]
0x42	DAC_ADSR_NOTE_BYT3[7:0]	0x00	ADSR Enable/Disable coefficient byte[15:8]
0x43	DAC_ADSR_NOTE_BYT4[7:0]	0x00	ADSR Enable/Disable coefficient byte[7:0]
0x50	DAC_ADSR_RESTART_TIMER_BYT1[7:0]	0x00	ADSR Restart Count coefficient byte[31:24]
0x51	DAC_ADSR_RESTART_TIMER_BYT2[7:0]	0x00	ADSR Restart Count coefficient byte[23:16]
0x52	DAC_ADSR_RESTART_TIMER_BYT3[7:0]	0x25	ADSR Restart Count coefficient byte[15:8]
0x53	DAC_ADSR_RESTART_TIMER_BYT4[7:0]	0x80	ADSR Restart Count coefficient byte[7:0]
0x54	DAC_ADSR_SUSTAIN_TIMER_BYT1[7:0]	0x00	ADSR Sustain Count coefficient byte[31:24]
0x55	DAC_ADSR_SUSTAIN_TIMER_BYT2[7:0]	0x00	ADSR Sustain Count coefficient byte[23:16]
0x56	DAC_ADSR_SUSTAIN_TIMER_BYT3[7:0]	0x03	ADSR Sustain Count coefficient byte[15:8]
0x57	DAC_ADSR_SUSTAIN_TIMER_BYT4[7:0]	0xC0	ADSR Sustain Count coefficient byte[7:0]
0x58	DAC_ADSR_DELATTACK_BYT1[7:0]	0x00	ADSR Attack Slope coefficient byte[31:24]
0x59	DAC_ADSR_DELATTACK_BYT2[7:0]	0x44	ADSR Attack Slope coefficient byte[23:16]
0x5A	DAC_ADSR_DELATTACK_BYT3[7:0]	0x52	ADSR Attack Slope coefficient byte[15:8]
0x5B	DAC_ADSR_DELATTACK_BYT4[7:0]	0x3F	ADSR Attack Slope coefficient byte[7:0]
0x5C	DAC_ADSR_DELRELEASE_BYT1[7:0]	0xFF	ADSR Release Slope coefficient byte[31:24]
0x5D	DAC_ADSR_DELRELEASE_BYT2[7:0]	0xBB	ADSR Release Slope coefficient byte[23:16]
0x5E	DAC_ADSR_DELRELEASE_BYT3[7:0]	0xAD	ADSR Release Slope coefficient byte[15:8]
0x5F	DAC_ADSR_DELRELEASE_BYT4[7:0]	0xC1	ADSR Release Slope coefficient byte[7:0]
0x60	DAC_ADSR_DELDECAY_BYT1[7:0]	0x00	ADSR Decay Slope coefficient byte[31:24]
0x61	DAC_ADSR_DELDECAY_BYT2[7:0]	0x00	ADSR Decay Slope coefficient byte[23:16]
0x62	DAC_ADSR_DELDECAY_BYT3[7:0]	0x00	ADSR Decay Slope coefficient byte[15:8]
0x63	DAC_ADSR_DELDECAY_BYT4[7:0]	0x00	ADSR Decay Slope coefficient byte[7:0]
0x64	DAC_ADSR_SUSLVL_BYT1[7:0]	0x40	ADSR Sustain Level coefficient byte[31:24]
0x65	DAC_ADSR_SUSLVL_BYT2[7:0]	0x00	ADSR Sustain Level coefficient byte[23:16]
0x66	DAC_ADSR_SUSLVL_BYT3[7:0]	0x00	ADSR Sustain Level coefficient byte[15:8]

Table 8-222. Page 28 Programmable Coefficient Registers (continued)

0x67	DAC_ADSR_SUSLVL_BYT4[7:0]	0x00	ADSR Sustain Level coefficient byte[7:0]
------	---------------------------	------	--

9 Application and Implementation

Note

Information in the following applications sections is not part of the TI component specification, and TI does not warrant its accuracy or completeness. TI's customers are responsible for determining suitability of components for their purposes, as well as validating and testing their design implementation to confirm system functionality.

9.1 Application Information

The TAC5112 is a stereo, low-power audio codec that supports sample rates of up to 768kHz. The device supports up to a total of 4 microphones for simultaneous recording which can be selected from up to 2 analog microphones or 4 digital pulse density modulation (PDM) microphones. The device also supports up to 4 channel simultaneous playback which can be configured as a 2-channel differential or psuedo-differential outputs or up to 4-channel single-ended outputs with options for headphone and line-out drive capabilities.

Communication to the TAC5112 for configuration of the control registers is supported using an I²C or SPI interface. The device supports a highly flexible, audio serial interface (TDM, I²S, and LJ) to transmit audio data seamlessly in the system across devices.

9.2 Typical Application

9.2.1 Application

[Figure 9-1](#) shows a typical configuration of the TAC5112 for an application using two analog ECM microphones for simultaneous recording and a two-channel differential line-out for playback with an I²C control interface and a time-division multiplexing (TDM) audio data target interface. For low distortion, use input AC-coupling capacitors with a low-voltage coefficient.

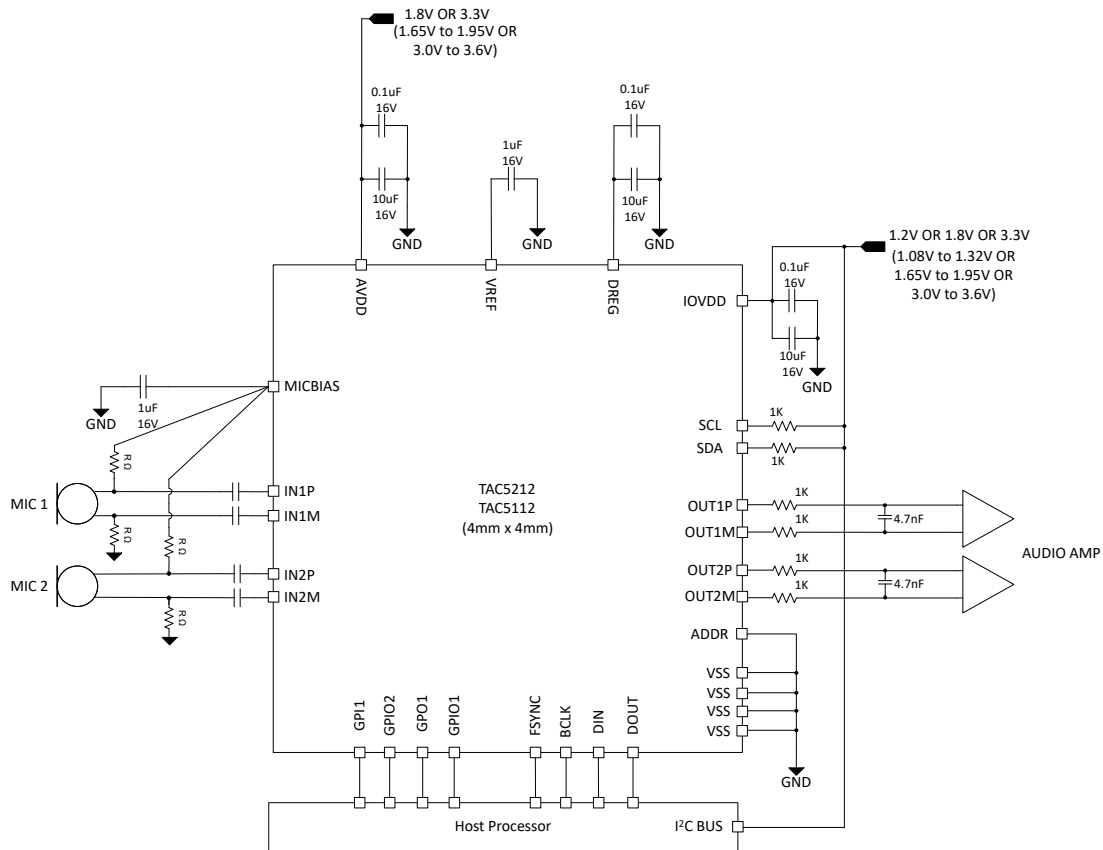

Figure 9-1. Stereo Microphone with Stereo Lineout Block Diagram

9.2.2 Design Requirements

Table 9-1 lists the design parameters for this application.

Table 9-1. Design Parameters

PARAMETER	VALUE
AVDD	1.8V or 3.3V
IOVDD	1.2V or 1.8V or 3.3V
AVDD supply current consumption	27.6mA, with AVDD = 3.3V (MICBIAS on, PLL on, stereo recording and playback, $f_s = 48\text{kHz}$)
IOVDD supply current consumption	0.3mA, with IOVDD = 3.3V
Maximum MICBIAS current	5mA
Load on OUT1M, OUT1P, OUT2M, OUT2P	>600 Ω

9.2.3 Detailed Design Procedure

This section describes the necessary steps to configure the TAC5112 for this specific application. The following steps provide a sequence of items that must be executed in the time between powering the device up and reading data from the device or transitioning from one mode to another mode of operation.

1. Apply power to the device:
 - a. Power up the IOVDD and AVDD power supplies
 - b. Wait for at least 2ms to allow the device to initialize the internal registers.
 - c. The device now goes into sleep mode (low-power mode < 10 μA)
2. Transition from sleep mode to active mode whenever required for the operation:
 - a. Wake up the device by writing to P0_R2 to disable sleep mode
 - b. Wait for at least 2ms to allow the device to complete the internal wake-up sequence

- c. Override the default configuration registers or programmable coefficients value as required (this step is optional)
- d. Enable all desired input channels by writing to P0_R118
- e. Enable all desired audio serial interface input/output channels by writing to P0_R40 to P0_R47 for DAC and P0_R30 to P0_R37 for ADC
- f. Power-up the ADC, DAC and MICBIAS by writing to P0_R120
- g. Apply FSYNC and BCLK with the desired output sample rates and the BCLK to FSYNC ratio

This specific step can be done at any point in the sequence after step a.

See the [Section 7.3.2](#) section for supported sample rates and the BCLK to FSYNC ratio.

- h. The device recording data is now sent to the host processor using the TDM audio serial data bus and playback data from TDM is now played on the lineout
3. Transition from active mode to sleep mode (again) as required in the system for low-power operation:
 - a. Enter sleep mode by writing to P0_R2 to enable sleep mode
 - b. Wait at least 10ms (when FSYNC = 48kHz) for the volume to ramp down and for all blocks to power down
 - c. Read P0_R122 to check the device shutdown and sleep mode status
 - d. If the device P0_R122_D[7:5] status bit is 3'b100 then stop FSYNC and BCLK in the system
 - e. The device now goes into sleep mode (low-power mode < 10µA) and retains all register values
 4. Transition from sleep mode to active mode (again) as required for the recording operation:
 - a. Wake up the device by writing to P0_R2 to disable sleep mode
 - b. Wait at least 2ms to allow the device to complete the internal wake-up sequence
 - c. Apply FSYNC and BCLK with the desired output sample rates and the BCLK to FSYNC ratio
 - d. The device recording data is now sent to the host processor using the TDM audio serial data bus and playback data from TDM is now played on the lineout
 5. Repeat the steps as required for different device configurations and modes of operation

9.2.4 Application Performance Plots

At $T_A = 25^\circ\text{C}$, $AVDD = 3.3\text{V}$, $IOVDD = 3.3\text{V}$, $f_{IN} = 1\text{kHz}$ sinusoidal signal, $f_S = 48\text{kHz}$, 32-bit audio data, $BCLK = 256 \times f_S$, TDM target mode, PLL on, channel gain = 0dB, linear phase decimation/interpolation filters, 5kΩ input impedance setting, AC-coupled differential input with $ADC_CHx_CM_TOL = 2'b00$, 1200Ω line-out load in differential configuration, MICBIAS programmed to VREF and other default configurations; measured filter free with an audio precision with a 20Hz to 20kHz un-weighted bandwidth, unless otherwise noted

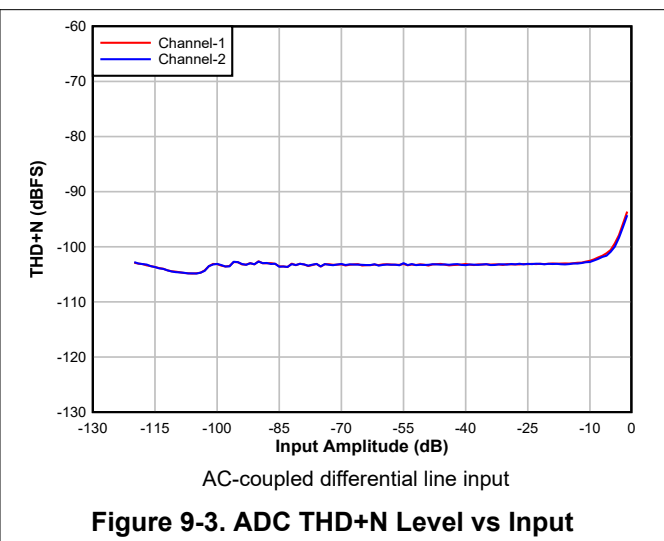
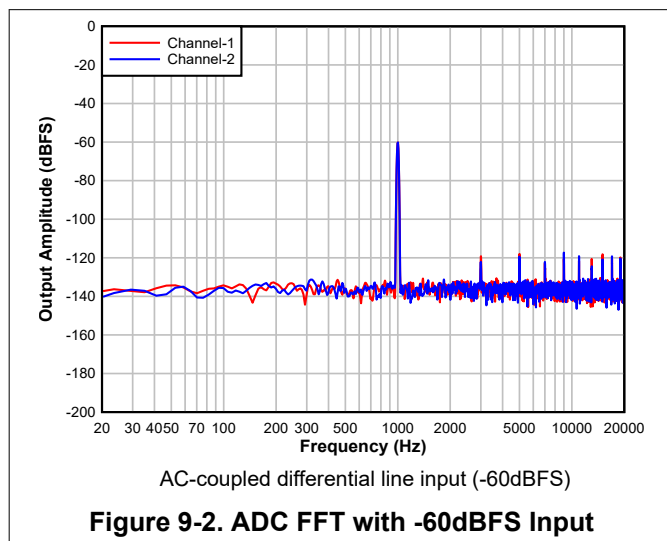

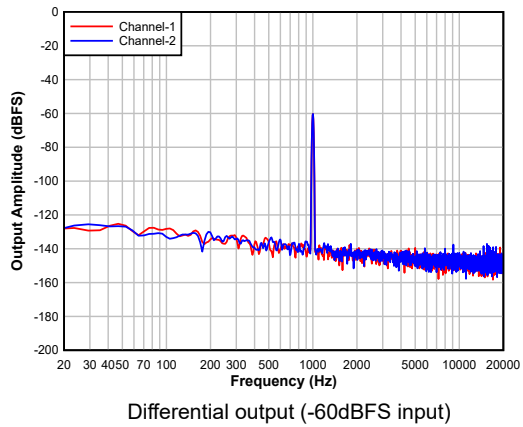

Figure 9-4. DAC FFT with -60dBFS Input

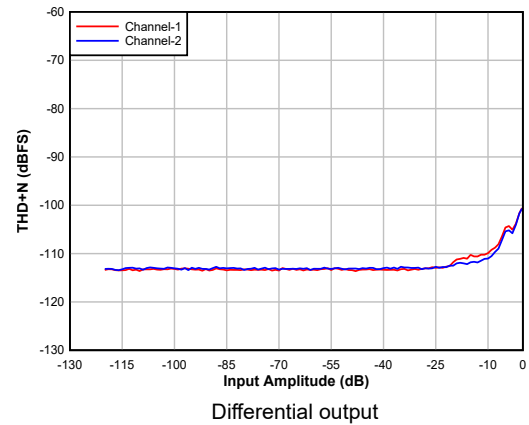

Figure 9-5. DAC THD+N Level vs Input

9.2.5 Example Device Register Configuration Script for EVM Setup

This section provides a typical EVM I²C register control script for various applications

Stereo differential AC-coupled analog recording and line output playback

```
# Key: w a0 XX YY ==> write to I2C address 0xa0, to register 0xxx, data 0xyy
# # ==> comment delimiter
#
# The following list gives an example sequence of items that must be executed in the time
# between powering the device up and reading data from the device. Note that there are
# other valid sequences depending on which features are used.
#
#
# Differential 2-channel ADC: INP1/INM1 - Ch1, INP2/INM2 - Ch2
# Differential 2-channel Line Out DAC: OUT1P/OUT1M - Ch1, OUT2P/OUT2M - Ch2
# FSYNC = 48 kHz (Output Data Sample Rate), BCLK = 12.288 MHz (BCLK/FSYNC = 256)
# AVDD = 3.3 V; IOVDD = 3.3 V
#####
#
#
# Page 0 Register Writes
w a0 00 00
w a0 01 01 #SW Reset
d 01
# Page 0 Register Writes
w a0 00 00
w a0 02 09 #Exit Sleep Mode with DREG and VREF Enabled
w a0 1a 30 #TDM protocol with 32-bit word length
w a0 4d 00 #VREF set to 2.75V for 2Vrms differential fullscale input
w a0 50 00 #ADC Channel 1 configured for AC-coupled differential input with 5kOhm input impedance
and audio bandwidth
w a0 55 00 #ADC Channel 2 configured for AC-coupled differential input with 5kOhm input impedance
and audio bandwidth
w a0 64 20 #DAC Channel 1 configured for differential output with 0.6*vref as common mode
w a0 65 20 #DAC OUT1P configured for line out driver and audio bandwidth
w a0 66 20 #DAC OUT1M configured for line out driver and audio bandwidth
w a0 6b 20 #DAC Channel 2 configured for differential output with 0.6*vref as common mode
w a0 6c 20 #DAC OUT2P configured for line out driver and audio bandwidth
w a0 6d 20 #DAC OUT2M configured for line out driver and audio bandwidth
w a0 76 cc #Input Channels 1, 2 enabled; Output Channels 1, 2 enabled
w a0 78 c0 #ADC, DAC Powered Up
# Apply FSYNC = 48 kHz and BCLK = 12.288 MHz and
# Start recording/playback data by host on ASI bus with TDM protocol 32-bits channel wordlength
```

Four-channel PDM microphone recording

```
# Key: w a0 XX YY ==> write to I2C address 0xa0, to register 0xxx, data 0xyy
# # ==> comment delimiter
#
```



```
# The following list gives an example sequence of items that must be executed in the time
# between powering the device up and reading data from the device. Note that there are
# other valid sequences depending on which features are used.
#
# GPIO1 - PDMCLK @ 3.072MHz
# PDM Ch1/2 on GPIO2
# PDM Ch3/4 on GPI1
# FSYNC = 48kHz (Output Data Sample Rate), BCLK = 12.288MHz (BCLK/FSYNC = 256)
# AVDD = 3.3V; IOVDD = 3.3V
#####
#
# Page 0 Register Writes
w a0 00 00
w a0 01 01 #SW Reset
d 01
# Page 0 Register Writes
w a0 00 00
w a0 02 09 #Exit Sleep Mode with DREG and VREF Enabled
w a0 0a 41 #Configure GPIO1 as PDMCLK, with active high/active low drive
w a0 35 00 #PDMCLK frequency = 3.072MHz
w a0 0b 10 #Configure GPIO2 as GPI input
w a0 0d 02 #Configure GPI1 as GPI input
w a0 13 cb #Configure Channel1 and Channel2 as PDM; PDM1/2 data in on GPIO2; PDM3/4 data in on GPI1
w a0 1a 30 #TDM protocol with 32-bit word length
w a0 1e 20 #Channel1 data on TDM slot 0
w a0 1f 21 #Channel2 data on TDM slot 1
w a0 20 22 #Channel3 data on TDM slot 2
w a0 21 23 #Channel4 data on TDM slot 3
w a0 76 f0 #Enable input channels 1-4
w a0 78 80 #Power Up ADC path
# Provide BCLK, FSYNC corresponding to 48kSPS, and record with 32-bit TDM bus
```

9.3 Power Supply Recommendations

The power-supply sequence between the IOVDD and AVDD rails can be applied in any order. However, only initiate the I²C or SPI transactions to initialize the device after all supplies are stable.

For the supply power-up requirement, t_1 , t_2 must be at least 2ms to allow the device to initialize the internal registers. See the [Section 7.4](#) section for details on how the device operates in various modes after the device power supplies are settled to the recommended operating voltage levels. For the supply power-down requirement, t_4 , t_5 and t_6 must be at least 10ms. This timing (as shown in [Figure 9-6](#)) allows the device to ramp down the volume on the record data, power down the analog and digital blocks, and put the device into shutdown mode. The device can also be immediately put into shutdown mode by ramping down power supplies, but doing so causes an abrupt shutdown.

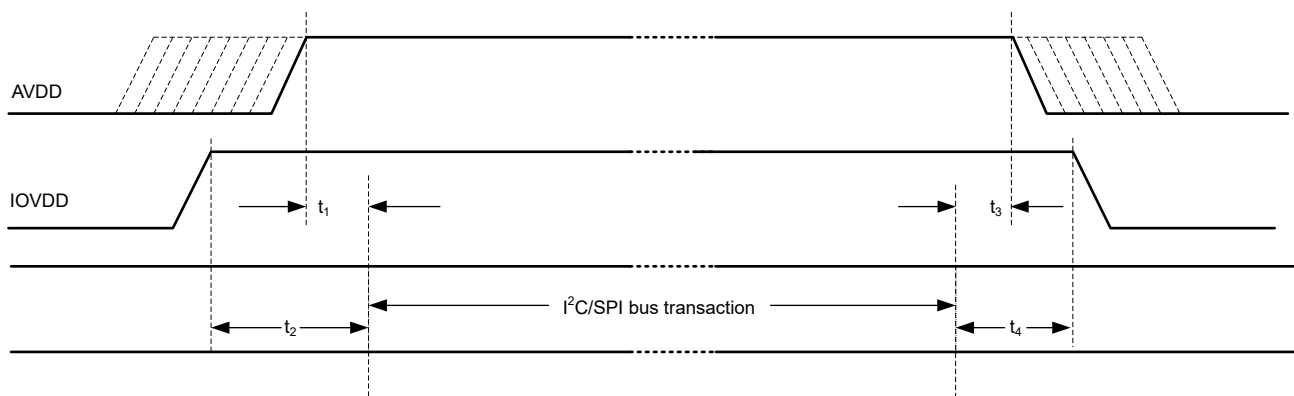

Figure 9-6. Power-Supply Sequencing Requirement Timing Diagram

Make sure that the supply ramp rate is slower than 0.1V/ μ s and that the wait time between a power-down and a power-up event is at least 100ms. For supply ramp rate slower than 0.1V/ms, host device must apply a software reset as first transaction before doing any device configuration. Make sure all digital input pins are at valid input levels and not toggling during supply sequencing.

The TAC5112 supports a single AVDD supply operation by integrating an on-chip digital regulator, DREG, and an integrated analog regulator. Ensure AVDD_MODE (P0_R2_D[2]) and IOVDD_IO_MODE (P0_R2_D[1]) registers are set correctly for AVDD 1.8V operation and for IOVDD 1.8V and 1.2V operation as described in [Section 9.3.1](#) and [Section 9.3.2](#) respectively.

9.3.1 AVDD_MODE for 1.8V Operation

After the supplies are stable, whenever using AVDD 1.8V operation, always set the AVDD_MODE (P0_R2_D[2]) setting to 1'b1 right after power-up to set the correct analog regulator (AREG) voltage. This setting is not needed when using AVDD 3.3V operation.

9.3.2 IOVDD_IO_MODE for 1.8V and 1.2V Operation

After the supplies are stable, the default register configuration of the device has a speed limitation on the maximum clock speed that can be supported for IOVDD = 1.8V or 1.2V at first power up of device with default configurations except for the first write operation. Whenever using IOVDD 1.8V and 1.2V operation, the first operation by user should always be to write the IOVDD_IO_MODE (P0_R2_D[1]) setting to 1'b1 after power-up or reset, and then there are no speed limitations in subsequent operation of device. This setting is not needed or applicable when using IOVDD 3.3V operation.

9.4 Layout

9.4.1 Layout Guidelines

Each system design and printed circuit board (PCB) layout is unique. The layout must be carefully reviewed in the context of a specific PCB design. However, the following guidelines can optimize the device performance:

- Connect the thermal pad to ground. Use a via pattern to connect the device thermal pad, which is the area directly under the device, to the ground planes. This connection helps dissipate heat from the device.
- Star connect all ground pins to the board ground plane. Use the same ground between VSS pins to avoid any potential voltage difference between them.
- The decoupling capacitors for the power supplies must be placed close to the device pins.
- Route the analog differential audio signals differentially on the PCB for better noise immunity. Avoid crossing digital and analog signals to prevent undesirable crosstalk.
- Avoid running high-frequency clock and control signals near INxx and OUTxx pins where possible.
- The device internal voltage references must be filtered using external capacitors. Place the filter capacitors near the VREF pin for good performance.
- Directly tap the MICBIAS pin to avoid common impedance when routing the biasing or supply traces for multiple microphones to avoid coupling across microphones.
- Provide a direct connection from the VREF and MICBIAS external capacitor ground terminal to VSS.
- Place the MICBIAS capacitor (with low equivalent series resistance) close to the device with minimal trace impedance.
- Use ground planes to provide the lowest impedance for power and signal current between the device and the decoupling capacitors. Treat the area directly under the device as a central ground area for the device, and all device grounds must be connected directly to that area.

9.4.2 Layout Example

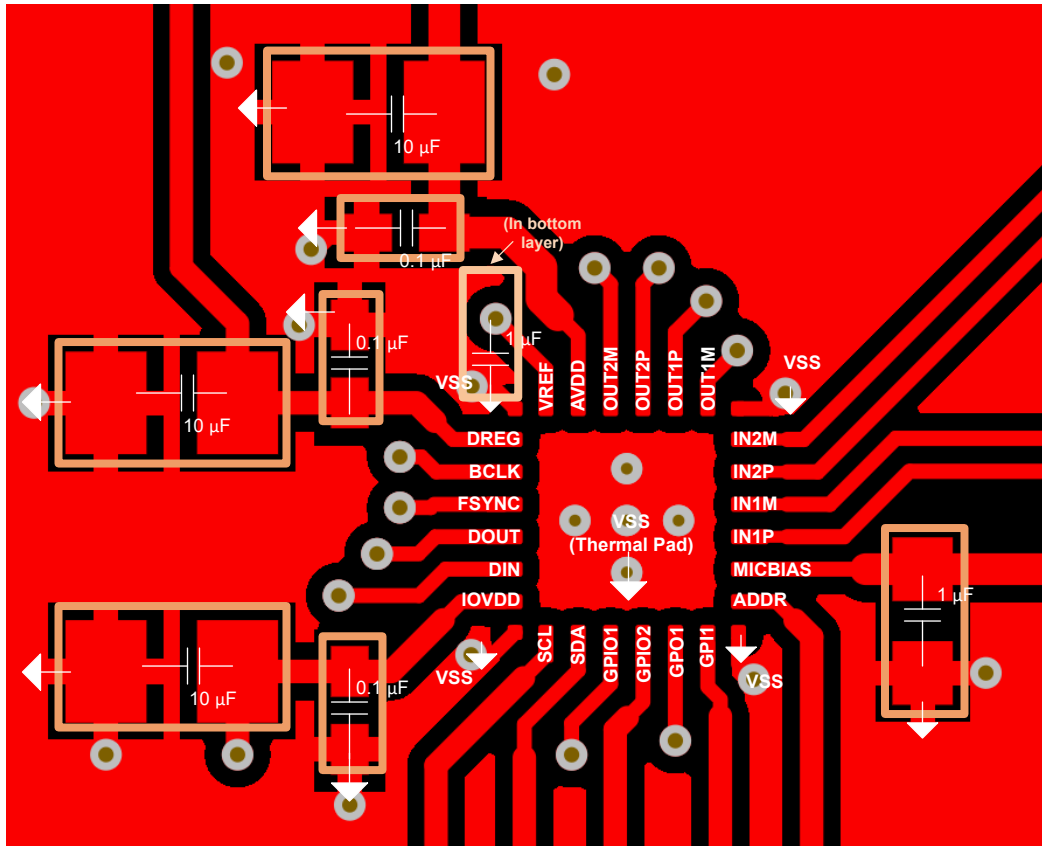

Figure 9-7. Example Layout

10 Device and Documentation Support

TI offers an extensive line of development tools. Tools and software to evaluate the performance of the device, generate code, and develop solutions are listed below.

10.1 Documentation Support

10.1.1 Related Documentation

For related documentation see the following:

- Texas Instruments, [TAX5x12EVM-K Evaluation Module User's Guide](#)
- Texas Instruments, [TAX5X1X Synchronous Sample Rate Conversion application report](#)
- Texas Instruments, [Clocking Configuration of Device and Flexible Clocking For TAX5x1x Family application report](#)
- Texas Instruments, [Clock Error Configuration, Detection, and Modes Supported in TAX5x1x Family application report](#)
- Texas Instruments, [Analog Input Configurations, Mixing and Muxing of TAX5x1x Devices application report](#)
- Texas Instruments, [TAC5x1x and TAC5x1x-Q1 Programmable Biquad Filters - Configuration and Applications application report](#)
- Texas Instruments, [How to use the Voice Activity Detection in the TAX511x and TAX521x application report](#)
- Texas Instruments, [Tone Generation and Application Modes of TAX5x1x Devices application report](#)
- Texas Instruments, [TAC5x1x Power Consumption Matrix Across Various Usage Scenarios application report](#)
- Texas Instruments, [Output Swings and Common-mode Settings in AC-coupled and DC-coupled DAC application report](#)
- Texas Instruments, [Microphone Interface with TAX5XXX Devices application report](#)
- Texas Instruments, [Headset Detection for TAX52xx Family application report](#)
- Texas Instruments, [Audio ADC, DAC, and CODEC for Professional Audio and Music Applications application report](#)

10.2 Receiving Notification of Documentation Updates

To receive notification of documentation updates, navigate to the device product folder on [ti.com](#). Click on *Notifications* to register and receive a weekly digest of any product information that has changed. For change details, review the revision history included in any revised document.

10.3 Support Resources

TI E2E™ [support forums](#) are an engineer's go-to source for fast, verified answers and design help — straight from the experts. Search existing answers or ask your own question to get the quick design help you need.

Linked content is provided "AS IS" by the respective contributors. They do not constitute TI specifications and do not necessarily reflect TI's views; see TI's [Terms of Use](#).

10.4 Trademarks

TI E2E™ is a trademark of Texas Instruments.

All trademarks are the property of their respective owners.

10.5 Electrostatic Discharge Caution



This integrated circuit can be damaged by ESD. Texas Instruments recommends that all integrated circuits be handled with appropriate precautions. Failure to observe proper handling and installation procedures can cause damage.

ESD damage can range from subtle performance degradation to complete device failure. Precision integrated circuits may be more susceptible to damage because very small parametric changes could cause the device not to meet its published specifications.

10.6 Glossary

[TI Glossary](#) This glossary lists and explains terms, acronyms, and definitions.

11 Revision History

NOTE: Page numbers for previous revisions may differ from page numbers in the current version.

Changes from Revision * (January 2024) to Revision A (January 2025)	Page
• Updated device status to production data.....	1

12 Mechanical, Packaging, and Orderable Information

The following pages include mechanical, packaging, and orderable information. This information is the most current data available for the designated devices. This data is subject to change without notice and revision of this document. For browser-based versions of this data sheet, refer to the left-hand navigation.

PACKAGING INFORMATION

Orderable part number	Status (1)	Material type (2)	Package Pins	Package qty Carrier	RoHS (3)	Lead finish/ Ball material (4)	MSL rating/ Peak reflow (5)	Op temp (°C)	Part marking (6)
TAC5112IRGER	Active	Production	VQFN (RGE) 24	3000 LARGE T&R	Yes	NIPDAU	Level-2-260C-1 YEAR	-40 to 125	TAC5112
TAC5112IRGER.A	Active	Production	VQFN (RGE) 24	3000 LARGE T&R	Yes	NIPDAU	Level-2-260C-1 YEAR	-40 to 125	TAC5112

(1) **Status:** For more details on status, see our [product life cycle](#).

(2) **Material type:** When designated, preproduction parts are prototypes/experimental devices, and are not yet approved or released for full production. Testing and final process, including without limitation quality assurance, reliability performance testing, and/or process qualification, may not yet be complete, and this item is subject to further changes or possible discontinuation. If available for ordering, purchases will be subject to an additional waiver at checkout, and are intended for early internal evaluation purposes only. These items are sold without warranties of any kind.

(3) **RoHS values:** Yes, No, RoHS Exempt. See the [TI RoHS Statement](#) for additional information and value definition.

(4) **Lead finish/Ball material:** Parts may have multiple material finish options. Finish options are separated by a vertical ruled line. Lead finish/Ball material values may wrap to two lines if the finish value exceeds the maximum column width.

(5) **MSL rating/Peak reflow:** The moisture sensitivity level ratings and peak solder (reflow) temperatures. In the event that a part has multiple moisture sensitivity ratings, only the lowest level per JEDEC standards is shown. Refer to the shipping label for the actual reflow temperature that will be used to mount the part to the printed circuit board.

(6) **Part marking:** There may be an additional marking, which relates to the logo, the lot trace code information, or the environmental category of the part.

Multiple part markings will be inside parentheses. Only one part marking contained in parentheses and separated by a "~" will appear on a part. If a line is indented then it is a continuation of the previous line and the two combined represent the entire part marking for that device.

Important Information and Disclaimer:The information provided on this page represents TI's knowledge and belief as of the date that it is provided. TI bases its knowledge and belief on information provided by third parties, and makes no representation or warranty as to the accuracy of such information. Efforts are underway to better integrate information from third parties. TI has taken and continues to take reasonable steps to provide representative and accurate information but may not have conducted destructive testing or chemical analysis on incoming materials and chemicals. TI and TI suppliers consider certain information to be proprietary, and thus CAS numbers and other limited information may not be available for release.

In no event shall TI's liability arising out of such information exceed the total purchase price of the TI part(s) at issue in this document sold by TI to Customer on an annual basis.

OTHER QUALIFIED VERSIONS OF TAC5112 :

- Automotive : [TAC5112-Q1](#)

NOTE: Qualified Version Definitions:

- Automotive - Q100 devices qualified for high-reliability automotive applications targeting zero defects

TAPE AND REEL INFORMATION

QUADRANT ASSIGNMENTS FOR PIN 1 ORIENTATION IN TAPE

*All dimensions are nominal

Device	Package Type	Package Drawing	Pins	SPQ	Reel Diameter (mm)	Reel Width W1 (mm)	A0 (mm)	B0 (mm)	K0 (mm)	P1 (mm)	W (mm)	Pin1 Quadrant
TAC5112IRGER	VQFN	RGE	24	3000	330.0	12.4	4.25	4.25	1.15	8.0	12.0	Q2

TAPE AND REEL BOX DIMENSIONS

*All dimensions are nominal

Device	Package Type	Package Drawing	Pins	SPQ	Length (mm)	Width (mm)	Height (mm)
TAC5112IRGER	VQFN	RGE	24	3000	367.0	367.0	35.0

RGE 24

GENERIC PACKAGE VIEW

VQFN - 1 mm max height

PLASTIC QUAD FLATPACK - NO LEAD



Images above are just a representation of the package family, actual package may vary.
Refer to the product data sheet for package details.

4204104/H

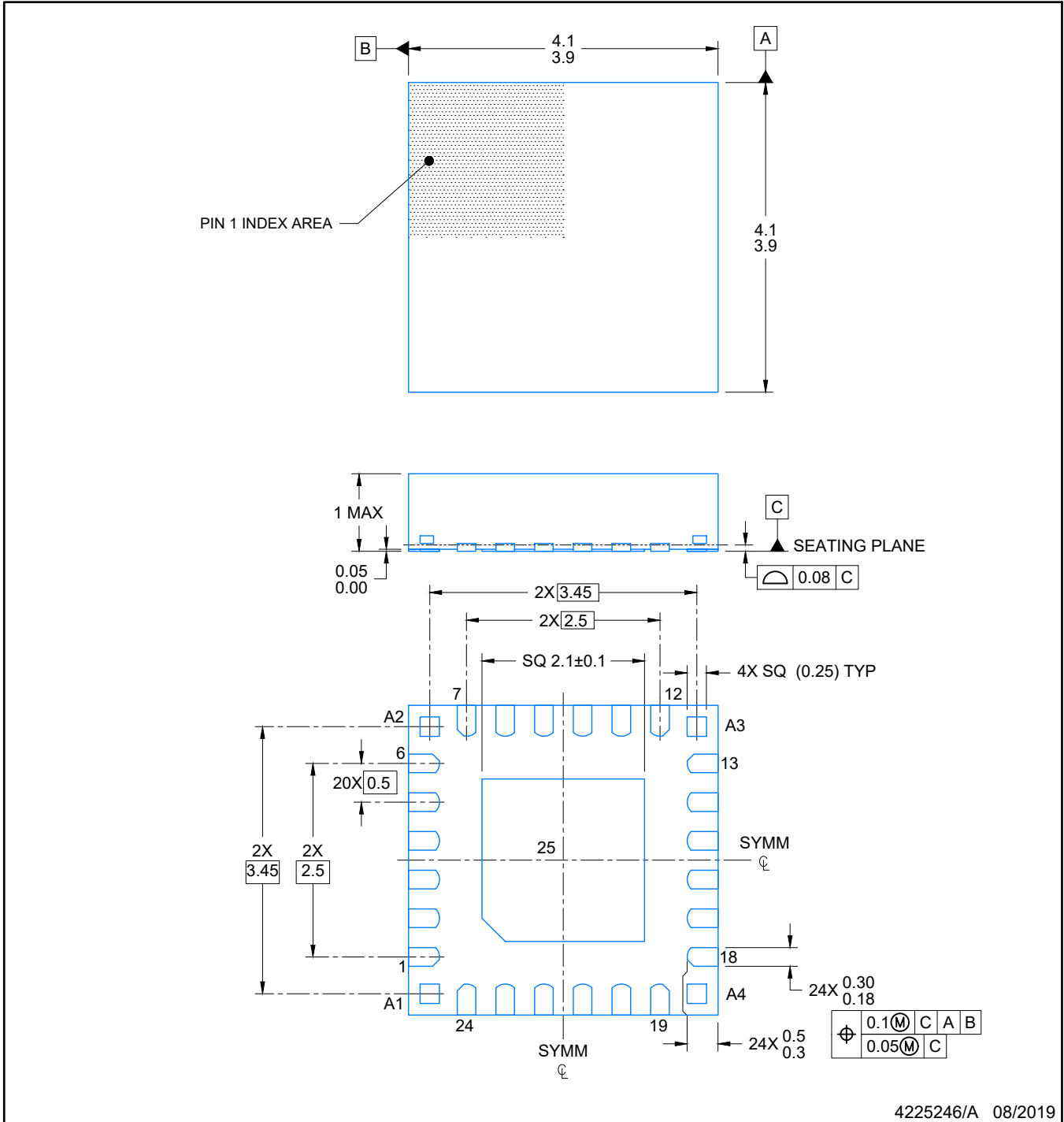

NOTES:

1. All linear dimensions are in millimeters. Any dimensions in parenthesis are for reference only. Dimensioning and tolerancing per ASME Y14.5M.
2. This drawing is subject to change without notice.
3. The package thermal pad must be soldered to the printed circuit board for optimal thermal and mechanical performance.

EXAMPLE BOARD LAYOUT

RGE0024R

VQFN - 1 mm max height

PLASTIC QUAD FLATPACK-NO LEAD

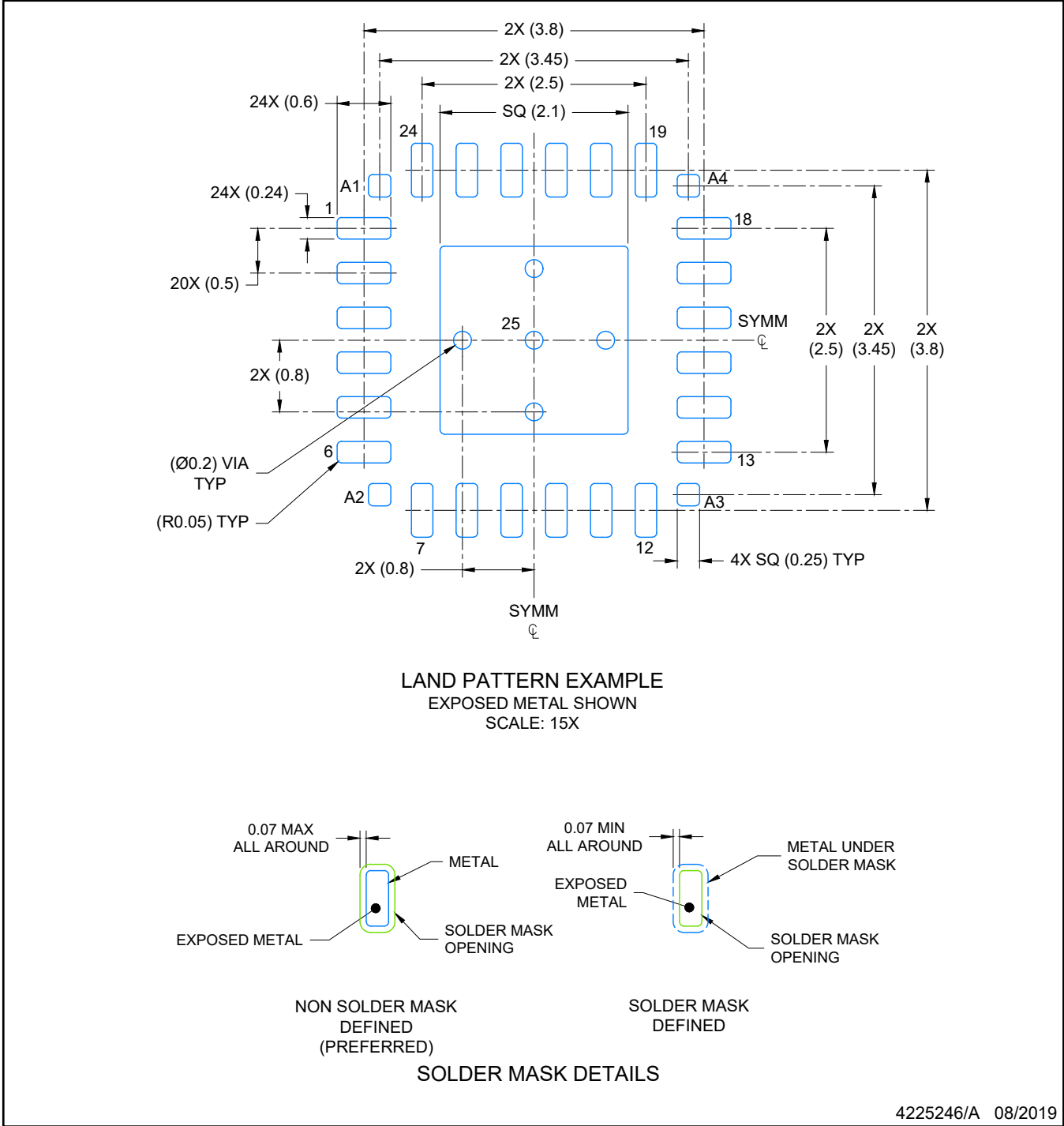

NOTES: (continued)

4. This package is designed to be soldered to a thermal pad on the board. For more information, see Texas Instruments literature number SLUA271 (www.ti.com/lit/sluea271).
5. Vias are optional depending on application, refer to device data sheet. If any vias are implemented, refer to their locations shown on this view. It is recommended that vias under paste be filled, plugged or tented.

EXAMPLE STENCIL DESIGN

VQFN - 1 mm max height

RGE0024R

PLASTIC QUAD FLATPACK-NO LEAD

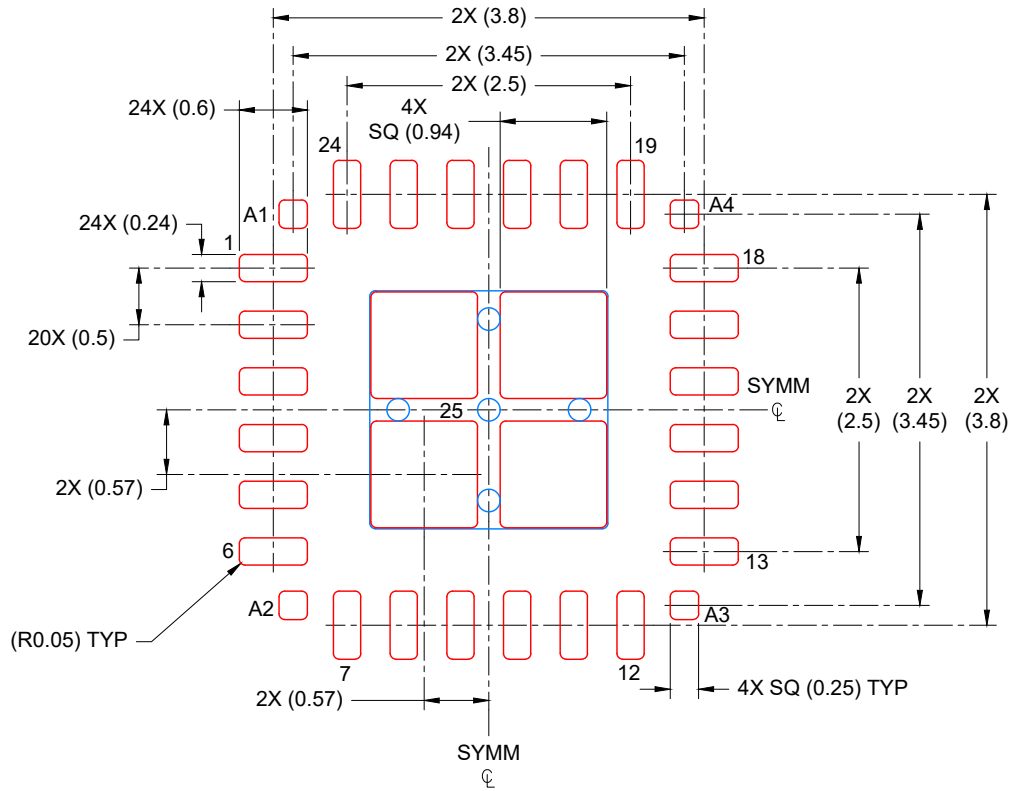

SOLDER PASTE EXAMPLE
 BASED ON 0.125 mm THICK STENCIL

EXPOSED PAD
 80% PRINTED COVERAGE BY AREA
 SCALE: 15X

4225246/A 08/2019

NOTES: (continued)

6. Laser cutting apertures with trapezoidal walls and rounded corners may offer better paste release. IPC-7525 may have alternate design recommendations.

IMPORTANT NOTICE AND DISCLAIMER

TI PROVIDES TECHNICAL AND RELIABILITY DATA (INCLUDING DATASHEETS), DESIGN RESOURCES (INCLUDING REFERENCE DESIGNS), APPLICATION OR OTHER DESIGN ADVICE, WEB TOOLS, SAFETY INFORMATION, AND OTHER RESOURCES "AS IS" AND WITH ALL FAULTS, AND DISCLAIMS ALL WARRANTIES, EXPRESS AND IMPLIED, INCLUDING WITHOUT LIMITATION ANY IMPLIED WARRANTIES OF MERCHANTABILITY, FITNESS FOR A PARTICULAR PURPOSE OR NON-INFRINGEMENT OF THIRD PARTY INTELLECTUAL PROPERTY RIGHTS.

These resources are intended for skilled developers designing with TI products. You are solely responsible for (1) selecting the appropriate TI products for your application, (2) designing, validating and testing your application, and (3) ensuring your application meets applicable standards, and any other safety, security, regulatory or other requirements.

These resources are subject to change without notice. TI grants you permission to use these resources only for development of an application that uses the TI products described in the resource. Other reproduction and display of these resources is prohibited. No license is granted to any other TI intellectual property right or to any third party intellectual property right. TI disclaims responsibility for, and you fully indemnify TI and its representatives against any claims, damages, costs, losses, and liabilities arising out of your use of these resources.

TI's products are provided subject to [TI's Terms of Sale](#), [TI's General Quality Guidelines](#), or other applicable terms available either on [ti.com](#) or provided in conjunction with such TI products. TI's provision of these resources does not expand or otherwise alter TI's applicable warranties or warranty disclaimers for TI products. Unless TI explicitly designates a product as custom or customer-specified, TI products are standard, catalog, general purpose devices.

TI objects to and rejects any additional or different terms you may propose.

Copyright © 2025, Texas Instruments Incorporated

Last updated 10/2025