

THVD1454 3-V to 5.5-V Half Duplex RS-485 Transceiver With Integrated 120 Ω Switchable Termination and Slew Rate Control

1 Features

- Meets or exceeds the requirements of the TIA/EIA-485A standard
- 3-V to 5.5-V Supply voltage
- Differential output exceeds 2.1 V for PROFIBUS compatibility with 5-V supply
- Half-duplex RS-422/RS-485
- Pin controlled on-chip 120 Ω termination resistor between the bus pins
- Maximum Data rate configurable
 - SLR = High: 500 kbps
 - SLR = Low or floating: 20 Mbps
- Bus I/O protection
 - ± 16 -kV HBM ESD
 - ± 8 -kV IEC 61000-4-2 Contact discharge
 - ± 15 -kV IEC 61000-4-2 Air gap discharge
 - ± 4 -kV IEC 61000-4-4 Fast transient burst
 - ± 16 -V bus fault protection (absolute max voltage on bus pins)
- Extended industrial temperature range: -40°C to 125°C
- Low power consumption
 - Shutdown supply current $< 5 \mu\text{A}$
 - Quiescent current during operation $< 3 \text{ mA}$
- Glitch-free power-up/power-down for hot plug-in capability
- Open, short, and idle bus failsafe
- 1/8 Unit load (Up to 256 bus nodes)
- Small, space-saving thermally efficient 10-pin VSON package (3 mm x 3 mm)

2 Applications

- [Factory automation & control](#)
- [Building automation](#)
- [Motor drives](#)
- [Power delivery](#)
- [Industrial transport](#)
- [HVAC systems](#)
- [Smart meters](#)

3 Description

The THVD1454 is a flexible half-duplex RS-485 transceiver for industrial applications. The device has features such as on-chip, 120- Ω termination resistor and driver output slew rate control. Both the features are pin controlled. This enables the device to be used at any node location (end nodes or middle nodes) in any network, slow or fast. End-equipment designers can now design a common printed circuit board (PCB), and configure the PCB using software for various application needs. This can save design and qualification time for the customers.

The bus pins are immune to high levels of IEC Contact Discharge ESD events, eliminating the need for additional system level protection components. The device operates from a single 3-V to 5.5-V supply. The wide common-mode voltage range and low input leakage on bus pins makes the device suitable for multi-point applications over long cable runs.

THVD1454 is available in space-saving thermally efficient 10-VSON package (3 mm x 3 mm). The device is characterized for ambient temperature from -40°C to 125°C .

Package Information

PART NUMBER	PACKAGE ⁽¹⁾	PACKAGE SIZE ⁽²⁾
THVD1454	VSON (10)	3 mm x 3 mm

- (1) For the complete part number, see the orderable addendum at the end of the data sheet.
- (2) The package size (length \times width) is a nominal value and includes pins, where applicable.

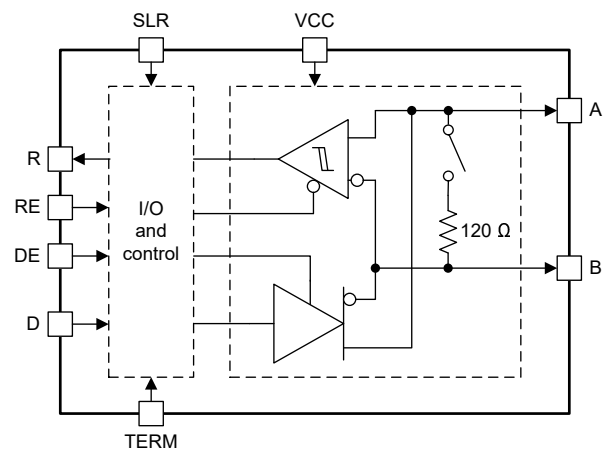

Simplified Application



Table of Contents

1 Features	1	8.1 Overview.....	14
2 Applications	1	8.2 Functional Block Diagrams.....	14
3 Description	1	8.3 Feature Description.....	14
4 Revision History	2	8.4 Device Functional Modes.....	14
5 Pin Configuration and Functions	3	9 Application Information Disclaimer	17
6 Specifications	4	9.1 Application Information.....	17
6.1 Absolute Maximum Ratings.....	4	9.2 Typical Application.....	17
6.2 ESD Ratings	4	9.3 Power Supply Recommendations.....	23
6.3 ESD Ratings [IEC].....	4	9.4 Layout.....	23
6.4 Recommended Operating Conditions.....	5	10 Device and Documentation Support	24
6.5 Thermal Information.....	5	10.1 Device Support.....	24
6.6 Power Dissipation.....	5	10.2 Receiving Notification of Documentation Updates.....	24
6.7 Electrical Characteristics.....	6	10.3 Support Resources.....	24
6.8 Switching Characteristics_500 kbps.....	8	10.4 Trademarks.....	24
6.9 Switching Characteristics_20 Mbps.....	9	10.5 Electrostatic Discharge Caution.....	24
6.10 Switching Characteristics_Termination resistor.....	9	10.6 Glossary.....	24
6.11 Typical Characteristics.....	10	11 Mechanical, Packaging, and Orderable Information	24
7 Parameter Measurement Information	12		
8 Detailed Description	14		

4 Revision History

NOTE: Page numbers for previous revisions may differ from page numbers in the current version.

Changes from Revision * (January 2023) to Revision A (July 2023)	Page
• Changed the data sheet status from Advanced Information to <i>Production</i> data.....	1

5 Pin Configuration and Functions

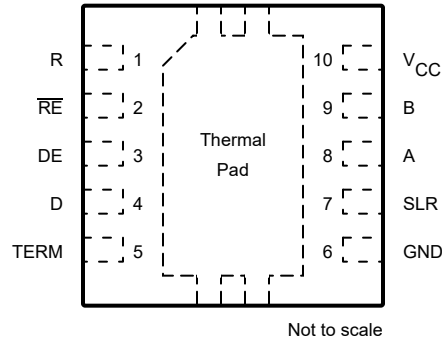

**Figure 5-1. VSON (DRC) Package, 10-Pins
(Top View)**

Table 5-1. Pin Functions

PIN		TYPE	DESCRIPTION
NAME	NO.		
R	1	Digital output	Logic output RS-485 data
\overline{RE}	2	Digital input	Receiver enable/disable. Internal pull-up. Receiver disabled by default
DE	3	Digital input	Driver enable/disable. Internal pull-down. Driver disabled by default
D	4	Digital input	Logic input RS485 data. Internal pull-up. Drives the bus high by default if driver is enabled
TERM	5	Digital input	120 Ω on-chip termination control for A/B pins. Internal pull-down. Termination across A/B is disabled by default
GND	6	GND	Ground
SLR	7	Digital input	Slew rate control. Internal pull-down, default 20 Mbps operation. Logic high SLR enables slow speed (500 kbps)
A	8	Bus input/output	RS-485 bus pin. This pin is non-inverting driver output or non-inverting receiver input
B	9	Bus input/output	RS-485 bus pin. This pin is inverting driver output or inverting receiver input
V _{CC}	10	Power	3 V to 5.5 V supply
Thermal Pad		--	Connect to GND for optimal thermal and electrical performance

6 Specifications

6.1 Absolute Maximum Ratings

over operating free-air temperature range (unless otherwise noted) ⁽¹⁾ ⁽²⁾

		MIN	MAX	UNIT
Supply voltage	V_{CC}	-0.5	7	V
Bus voltage	Voltage at any bus pin (A or B) with respect to GND	-16	16	V
Differential bus voltage	(A-B) or (B-A) with termination enabled	-6	6	V
Input voltage	Range at any logic pin (D, DE, SLR, TERM, or RE)	-0.3	5.7	V
Receiver output current	I_O	-24	24	mA
Storage temperature	T_{stg}	-65	150	°C

- (1) Operation outside the Absolute Maximum Ratings may cause permanent device damage. Absolute Maximum Ratings do not imply functional operation of the device at these or any other conditions beyond those listed under Recommended Operating Conditions. If used outside the Recommended Operating Conditions but within the Absolute Maximum Ratings, the device may not be fully functional, and this may affect device reliability, functionality, performance, and shorten the device lifetime.
- (2) All voltage values, except differential I/O bus voltages, are with respect to ground terminal.

6.2 ESD Ratings

				VALUE	UNIT
$V_{(ESD)}$	Electrostatic discharge	Human-body model (HBM), per ANSI/ESDA/ JEDEC JS-001 ⁽¹⁾	Bus terminals (A, B) and GND	±16,000	V
			All pins except bus terminals and GND	±4,000	V
		Charged-device model (CDM), per JEDEC specification JESD22-C101 ⁽²⁾	±1,500	V	

- (1) JEDEC document JEP155 states that 500-V HBM allows safe manufacturing with a standard ESD control process.
- (2) JEDEC document JEP157 states that 250-V CDM allows safe manufacturing with a standard ESD control process.

6.3 ESD Ratings [IEC]

				VALUE	UNIT
$V_{(ESD)}$	Electrostatic discharge, on chip termination ON or OFF	Contact discharge, per IEC 61000-4-2	Bus terminals and GND	±8,000	V
		Air-gap discharge, per IEC 61000-4-2	Bus terminals and GND	±15,000	
$V_{(EFT)}$	Electrical fast transient	Per IEC 61000-4-4	Bus terminals	±4,000	V

6.4 Recommended Operating Conditions

over operating free-air temperature range (unless otherwise noted)

		MIN	NOM	MAX	UNIT
V _{CC}	Supply voltage	3		5.5	V
V _I	Input voltage at any bus terminal (separately or common mode) ⁽¹⁾	-7		12	V
V _{IH}	High-level input voltage (D, DE, RE, TERM, SLR inputs)	2		5.5	V
V _{IL}	Low-level input voltage (D, DE, RE, TERM, SLR inputs)	0		0.8	V
I _O	Output current, driver	-60		60	mA
I _{OR}	Output current, receiver	-8		8	mA
R _L	Differential load resistance	54	60		Ω
1/t _{UI}	Signaling rate	SLR = V _{IO}		500	kbps
		SLR = GND or floating		20	Mbps
T _A ⁽²⁾	Operating ambient temperature	-40		125	°C
T _J ⁽²⁾	Junction temperature	-40		150	°C

- (1) The algebraic convention, in which the least positive (most negative) limit is designated as minimum is used in this data sheet.
 (2) Operation is specified for internal (junction) temperatures upto 150°C. Self-heating due to internal power dissipation should be considered for each application. Maximum junction temperature is internally limited by the thermal shut-down (TSD) circuit which disables the driver outputs when the junction temperature reaches typical 170°C.

6.5 Thermal Information

THERMAL METRIC ⁽¹⁾		THVD1454	UNIT
		DRC (VSON)	
		10 PINS	
R _{θJA}	Junction-to-ambient thermal resistance	48.6	°C/W
R _{θJC(top)}	Junction-to-case (top) thermal resistance	54	°C/W
R _{θJB}	Junction-to-board thermal resistance	21.9	°C/W
ψ _{JT}	Junction-to-top characterization parameter	1.1	°C/W
ψ _{JB}	Junction-to-board characterization parameter	21.9	°C/W
R _{θJC(bot)}	Junction-to-case (bottom) thermal resistance	6.7	°C/W

- (1) For more information about traditional and new thermalmetrics, see the [Semiconductor and IC Package Thermal Metrics](#) application report.

6.6 Power Dissipation

PARAMETER		TEST CONDITIONS			Typical	Max	UNIT
P _D	Driver and receiver enabled, V _{CC} = 5.5 V, T _A = 125 °C, D = square wave 50% duty	Unterminated, TERM = L	SLR = H	500 kbps	185	210	mW
			SLR = L	20Mbps	310	340	
		TERM = H, With 120 Ω load between A/B inputs	SLR = H	500 kbps	316	360	mW
			SLR = L	20Mbps	396	430	

6.7 Electrical Characteristics

over operating free-air temperature range (unless otherwise noted). All typical values are at 25°C and supply voltage of $V_{CC} = 5\text{ V}$, unless otherwise noted.

PARAMETER		TEST CONDITIONS		MIN	TYP	MAX	UNIT
Driver							
$ V_{OD} $	Driver differential output voltage magnitude	$R_L = 60\ \Omega, -7\text{ V} \leq V_{\text{test}} \leq 12\text{ V}$ (See Figure 7-1)		1.5	3.3		V
		$R_L = 60\ \Omega, -7\text{ V} \leq V_{\text{test}} \leq 12\text{ V}, 4.5\text{ V} \leq V_{CC} \leq 5.5\text{ V}$ (See Figure 7-1)		2.1	3.3		V
		$R_L = 100\ \Omega$ (See Figure 7-2)		2	4		V
		$R_L = 54\ \Omega, 4.5\text{ V} \leq V_{CC} \leq 5.5\text{ V}$ (See Figure 7-2)		2.1	3.3		V
		$R_L = 54\ \Omega$ (See Figure 7-2)		1.5	3.3		V
$\Delta V_{OD} $	Change in magnitude of differential output voltage	$R_L = 54\ \Omega$ or $100\ \Omega$ (See Figure 7-2)		-50		50	mV
V_{OC}	Common-mode output voltage	$R_L = 54\ \Omega$ or $100\ \Omega$ (See Figure 7-2)			$V_{CC}/2$	3	V
$\Delta V_{OC(SS)}$	Change in steady-state common-mode output voltage	$R_L = 54\ \Omega$ or $100\ \Omega$ (See Figure 7-2)		-50		50	mV
I_{OS}	Short-circuit output current	DE = V_{IO} , $-7\text{ V} \leq (V_A \text{ or } V_B) \leq 12\text{ V}$, or A shorted to B		-250		250	mA
Receiver							
I_I	Bus input current (termination disabled)	DE = 0 V, $V_{CC} = 0\text{ V}$ or 5.5 V		$V_I = 12\text{ V}$	85	110	μA
				$V_I = -7\text{ V}$	-100	-70	μA
I_{RXT}	Receiver bus input leakage current with termination enabled	DE = 0 V, $V_{CC} = 5.5\text{ V}$, TERM = V_{CC}		$V_I = -7$ to 12 V		-300	300 μA
V_{TH+}	Positive-going input threshold voltage ⁽¹⁾	Over common-mode range of -7 V to 12 V			-85	-45	mV
V_{TH-}	Negative-going input threshold voltage ⁽¹⁾			-200	-150	mV	
V_{HYS}	Input hysteresis			30	50	mV	
$C_{A,B}$	Input differential capacitance	Measured between A and B, $f = 1\text{ MHz}$			20		pF
V_{OH}	Output high voltage	$I_{OH} = -8\text{ mA}$		$V_{CC} - 0.4$	$V_{CC} - 0.2$		V
V_{OL}	Output low voltage	$I_{OL} = 8\text{ mA}$			0.2	0.4	V
I_{OZ}	Output high-impedance current, R pin	$V_O = 0\text{ V}$ or V_{CC} , $\overline{RE} = V_{CC}$		-2		2	μA
Logic							
I_{IN}	Input current (D, \overline{RE} , DE, SLR, TERM)	$3\text{ V} \leq V_{CC} \leq 5.5\text{ V}, 0\text{ V} \leq V_{IN} \leq V_{CC}$		-5		5	μA
Thermal Protection							
T_{SHDN}	Thermal shutdown threshold	Temperature rising		150	170		°C
T_{HYS}	Thermal shutdown hysteresis				15		°C
Supply							
UV_{VCC} (rising)	Rising under-voltage threshold on V_{CC}				2.5	2.7	V
UV_{VCC} (falling)	Falling under-voltage threshold on V_{CC}			2	2.1		V
$UV_{VCC(hys)}$	Hysteresis on under-voltage of V_{CC}				400		mV
I_{CC}	Supply current (quiescent), $V_{CC} = 4.5\text{ V}$ to 5.5 V , TERM = Floating or low, SLR = X	Driver and receiver enabled		$\overline{RE} = 0\text{ V}, DE = V_{CC}$, No load	1.5	3	mA
		Driver enabled, receiver disabled		$\overline{RE} = V_{CC}, DE = V_{CC}$, No load	1.3	2.5	mA
		Driver disabled, receiver enabled		$\overline{RE} = 0\text{ V}, DE = 0\text{ V}$, No load	0.8	1.2	mA
		Driver and receiver disabled		$\overline{RE} = V_{CC}, DE = 0\text{ V}$, D = open, No load	0.2	8	μA

6.7 Electrical Characteristics (continued)

over operating free-air temperature range (unless otherwise noted). All typical values are at 25°C and supply voltage of $V_{CC} = 5\text{ V}$, unless otherwise noted.

PARAMETER		TEST CONDITIONS	MIN	TYP	MAX	UNIT
I_{CC}	Supply current (quiescent), $V_{CC} = 3\text{ V to }3.6\text{ V}$, TERM = Floating or low, SLR = X	Driver and receiver enabled		1.4	2	mA
		Driver enabled, receiver disabled	$\overline{RE} = V_{CC}$, DE = V_{CC} , No load	1	1.5	mA
		Driver disabled, receiver enabled	$\overline{RE} = 0\text{ V}$, DE = 0 V , No load	0.7	1	mA
		Driver and receiver disabled	$\overline{RE} = V_{CC}$, DE = 0 V , D = open, No load	0.2	8	μA
I_{CCDT}	Supply current in driver termination mode	Driver enabled, receiver disabled with termination ON	$\overline{RE} = V_{CC}$, DE = V_{IO} , TERM = V_{CC}	39	48	mA
I_{CCRT}	Supply current in receiver termination mode	Receiver enabled and driver disabled, with termination ON	$\overline{RE} = \text{GND}$, DE = 0 V , TERM = V_{CC}	1	1.3	mA
I_{CCT}	Supply current in device disabled, termination enabled mode	Driver and Receiver disabled, termination ON	$\overline{RE} = V_{CC}$, DE = 0 V , TERM = V_{CC}	200	350	μA
On-Chip termination resistor						
R_{TERM}	120 Ω termination across receiver output A/B terminals	DE = GND, TERM = V_{CC} , $V_{AB} = 2\text{ V}$, $V_B = -7\text{ V}$, 0 V , 10 V See Figure 7-9	102	120	138	Ω

(1) V_{TH+} is specified to be at least V_{HYS} higher than V_{TH-} .

6.8 Switching Characteristics_500 kbps

500-kbps (with SLR = V_{CC}) over recommended operating conditions. All typical values are at 25°C and supply voltage of V_{CC} = 5 V, unless otherwise noted. ⁽¹⁾

PARAMETER		TEST CONDITIONS		MIN	TYP	MAX	UNIT
Driver							
t_r, t_f	Differential output rise/fall time	$R_L = 54 \Omega, C_L = 50 \text{ pF}$ See Figure 7-3	$V_{CC} = 3 \text{ to } 3.6 \text{ V}$, Typical at 3.3V	200	250	600	ns
			$V_{CC} = 4.5 \text{ to } 5.5 \text{ V}$, Typical at 5 V	220	270	600	ns
t_{PHL}, t_{PLH}	Propagation delay		$V_{CC} = 3 \text{ to } 3.6 \text{ V}$, Typical at 3.3V		260	500	ns
			$V_{CC} = 4.5 \text{ to } 5.5 \text{ V}$, Typical at 5 V		260	450	ns
$t_{SK(P)}$	Pulse skew, $ t_{PHL} - t_{PLH} $		$V_{CC} = 3 \text{ to } 3.6 \text{ V}$, Typical at 3.3V		2	15	ns
			$V_{CC} = 4.5 \text{ to } 5.5 \text{ V}$, Typical at 5 V		2	15	ns
t_{PHZ}, t_{PLZ}	Disable time	$\overline{RE} = X$			80	200	ns
t_{PZH}, t_{PZL}	Enable time	$\overline{RE} = 0 \text{ V}$	See Figure 7-4 and Figure 7-5		200	650	ns
		$\overline{RE} = V_{CC}$			6	11	μs
Receiver							
t_r, t_f	Output rise/fall time	$C_L = 15 \text{ pF}$	See Figure 7-6		5	20	ns
t_{PHL}, t_{PLH}	Propagation delay				620	1200	ns
$t_{SK(P)}$	Pulse skew, $ t_{PHL} - t_{PLH} $				10	40	ns
t_{PHZ}, t_{PLZ}	Disable time	$DE = X$			20	60	ns
$t_{PZH(1)}$	Enable time	$DE = V_{CC}$	See Figure 7-7		80	155	ns
$t_{PZL(1)}$	Enable time	$DE = V_{CC}$			650	1250	ns
$t_{PZH(2)}, t_{PZL(2)}$	Enable time	$DE = 0 \text{ V}$	See Figure 7-8		7	12	μs

(1) A, B are RX input, Y/Z are driver output terminals in Full duplex mode

6.9 Switching Characteristics_20 Mbps

20-Mbps (SLR = GND) over recommended operating conditions. All typical values are at 25°C and supply voltage of $V_{CC} = 5$ V. (1)

PARAMETER		TEST CONDITIONS		MIN	TYP	MAX	UNIT
Driver							
t_r, t_f	Differential output rise/fall time	$R_L = 54 \Omega, C_L = 50 \text{ pF}$ See Figure 7-3	$V_{CC} = 3 \text{ to } 3.6 \text{ V}$, Typical at 3.3 V	5	9	15	ns
			$V_{CC} = 4.5 \text{ to } 5.5 \text{ V}$, Typical at 5 V	4.5	8	15	ns
t_{PHL}, t_{PLH}	Propagation delay		$V_{CC} = 3 \text{ to } 3.6 \text{ V}$, Typical at 3.3 V	14	22	50	ns
			$V_{CC} = 4.5 \text{ to } 5.5 \text{ V}$, Typical at 5 V	9	20	40	ns
$t_{SK(P)}$	Pulse skew, $ t_{PHL} - t_{PLH} $		$V_{CC} = 3 \text{ to } 3.6 \text{ V}$, Typical at 3.3 V		1	3.5	ns
			$V_{CC} = 4.5 \text{ to } 5.5 \text{ V}$, Typical at 5 V		1	3.5	ns
t_{PHZ}, t_{PLZ}	Disable time	$\overline{RE} = X$			25	50	ns
t_{PZH}, t_{PZL}	Enable time	$\overline{RE} = 0 \text{ V}$	See Figure 7-4 and Figure 7-5		30	70	ns
		$\overline{RE} = V_{CC}$			6	11	μs
Receiver							
t_r, t_f	Output rise/fall time	$C_L = 15 \text{ pF}$	See Figure 7-6		5	10	ns
t_{PHL}, t_{PLH}	Propagation delay				30	72	ns
$t_{SK(P)}$	Pulse skew, $ t_{PHL} - t_{PLH} $					6	ns
t_{PHZ}, t_{PLZ}	Disable time	$DE = X$	See Figure 7-7		20	58	ns
$t_{PZH(1)}, t_{PZL(1)}$	Enable time	$DE = V_{CC}$			80	155	ns
$t_{PZH(2)}, t_{PZL(2)}$	Enable time	$DE = 0 \text{ V}$	See Figure 7-8		6	11	μs

(1) A, B are RX input, Y/Z are driver output terminals in Full duplex mode.

6.10 Switching Characteristics_Termination resistor

Parameters over recommended operating conditions. All typical values are at 25°C and supply voltage of $V_{CC} = 5$ V, unless otherwise noted.

PARAMETER		TEST CONDITIONS		MIN	TYP	MAX	UNIT
t_{TEN}	Termination resistor turn-on time	$\overline{RE} = V_{CC}, V_{AB} = 2 \text{ V}, V_B = 0 \text{ V}$; See Figure 7-9			1.5	12	μs
t_{TZ}	Termination resistor turn-off time	$\overline{RE} = V_{CC}, V_{AB} = 2 \text{ V}, V_B = 0 \text{ V}$; See Figure 7-9			4.6	7.2	μs

6.11 Typical Characteristics

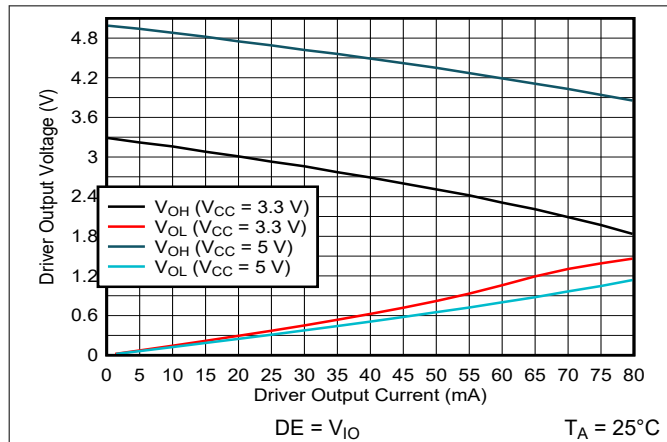

Figure 6-1. Driver Output voltage vs Driver Output Current

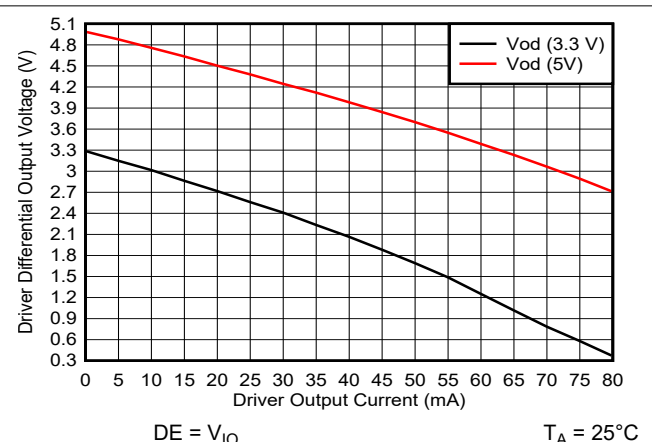

Figure 6-2. Driver Differential Output voltage vs Driver Output Current

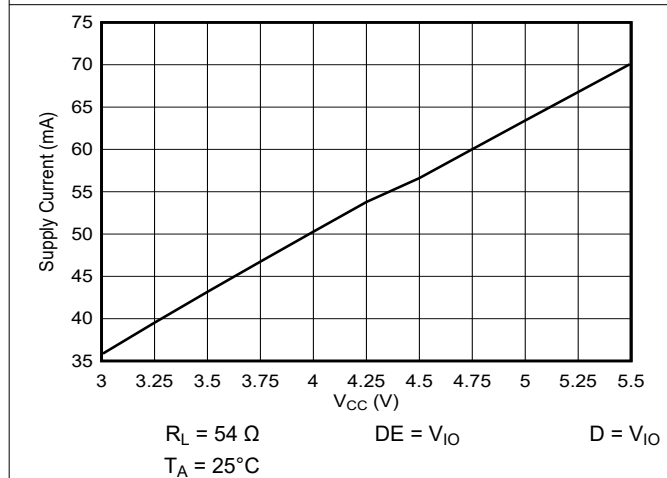

Figure 6-3. Supply Current vs Supply Voltage

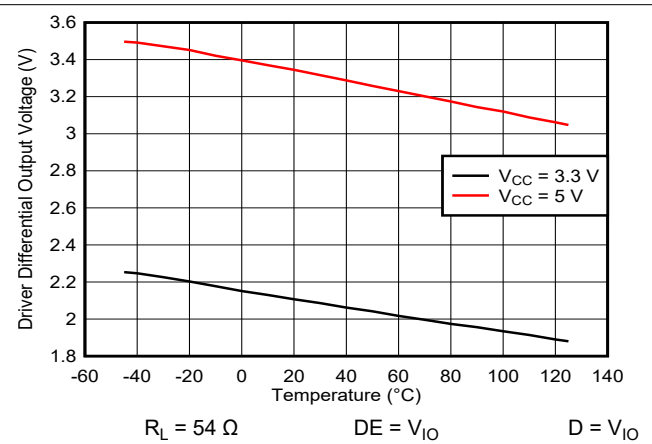

Figure 6-4. Driver Output Voltage vs Temperature

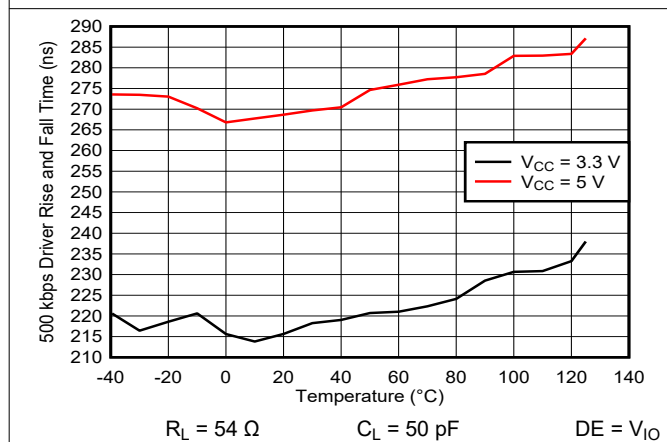

Figure 6-5. Driver Rise or Fall Time vs Temperature (500 kbps)

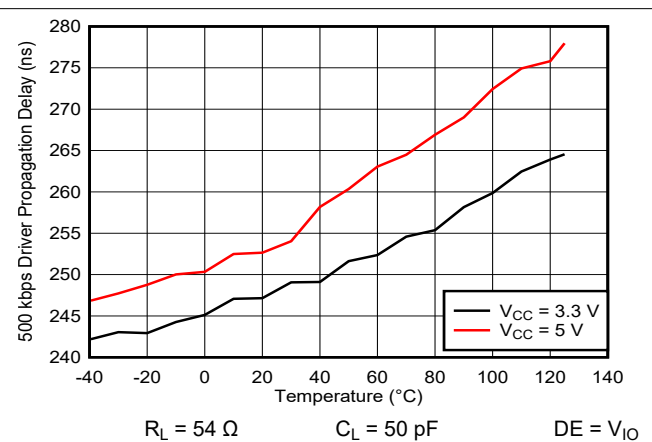

Figure 6-6. Driver Propagation Delay vs Temperature (500 kbps)

6.11 Typical Characteristics (continued)

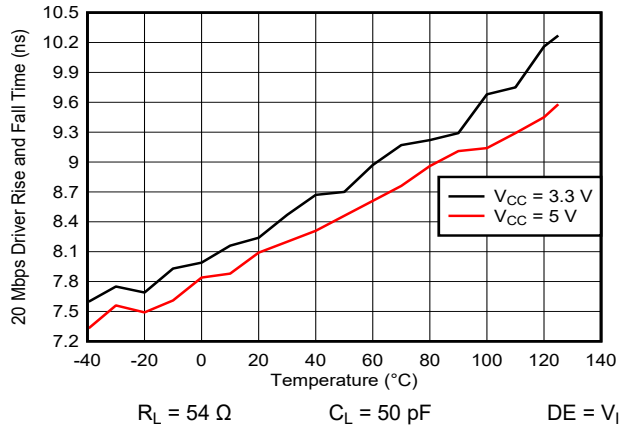

Figure 6-7. Driver Rise or Fall Time vs Temperature (20 Mbps)

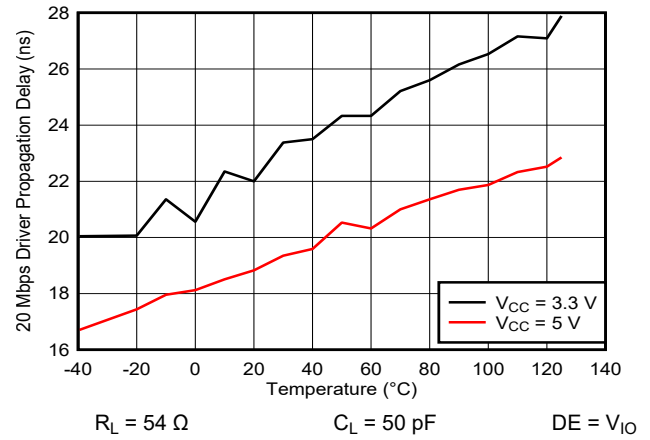

Figure 6-8. Driver Propagation Delay vs Temperature (20 Mbps)

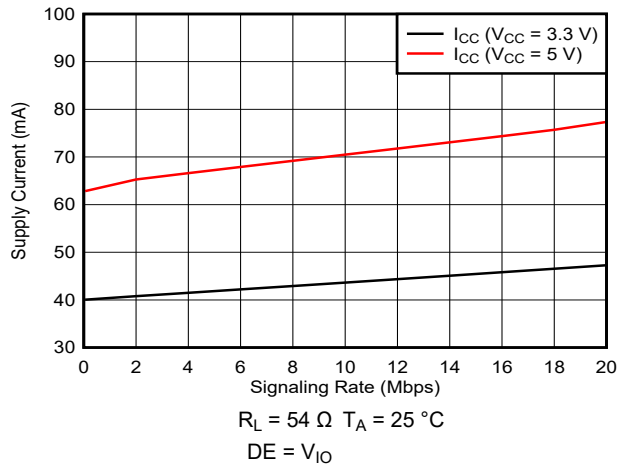

Figure 6-9. Supply Current vs Signal Rate (20 Mbps)

7 Parameter Measurement Information

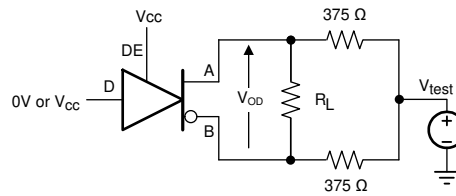

Figure 7-1. Measurement of Driver Differential Output Voltage With Common-Mode Load

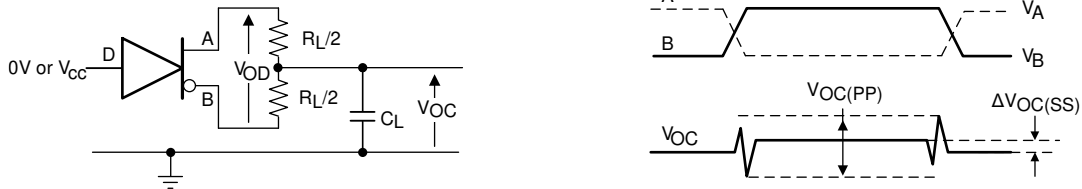

Figure 7-2. Measurement of Driver Differential and Common-Mode Output With RS-485 Load

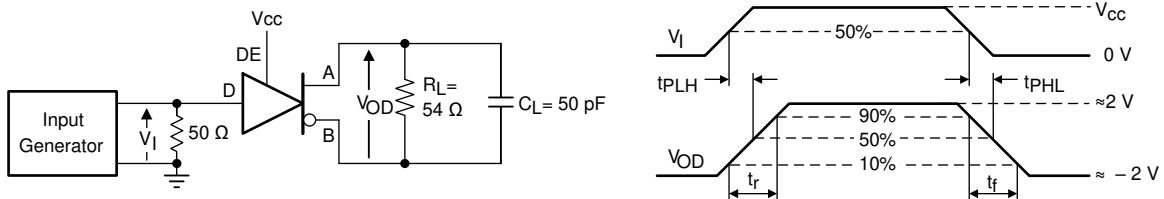

Figure 7-3. Measurement of Driver Differential Output Rise and Fall Times and Propagation Delays

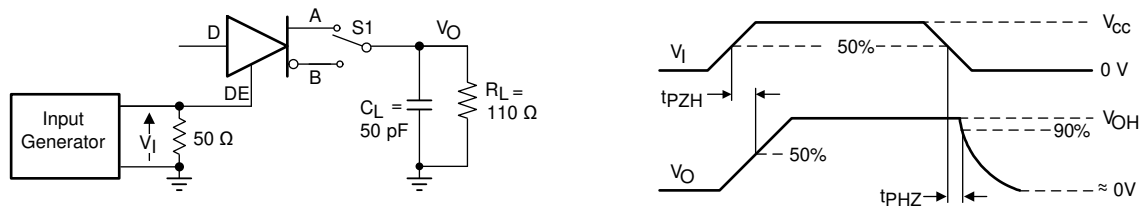

Figure 7-4. Measurement of Driver Enable and Disable Times With Active High Output and Pull-Down Load

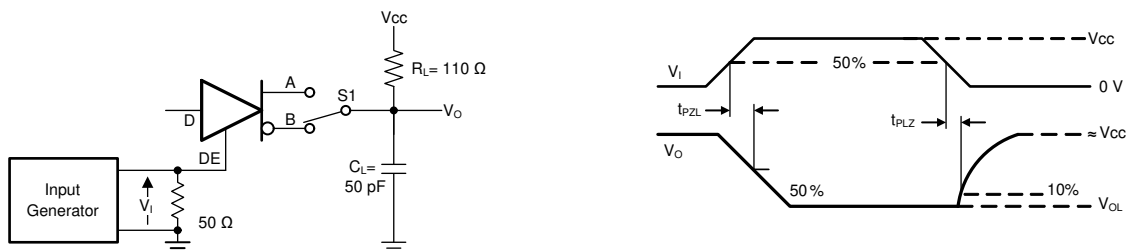

Figure 7-5. Measurement of Driver Enable and Disable Times With Active Low Output and Pull-up Load

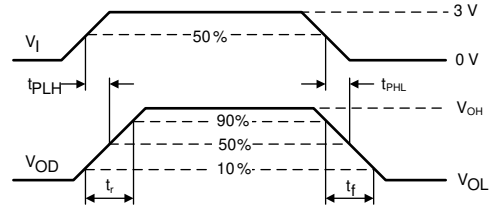
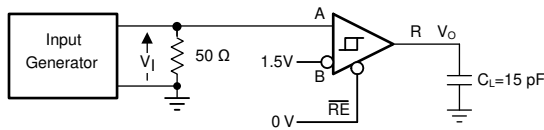

Figure 7-6. Measurement of Receiver Output Rise and Fall Times and Propagation Delays

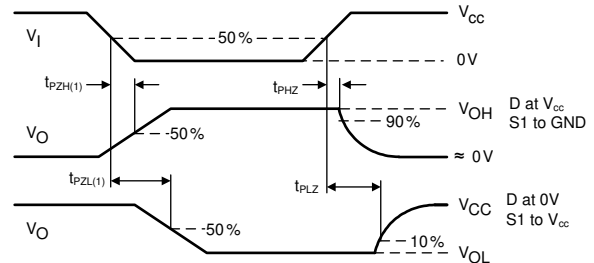
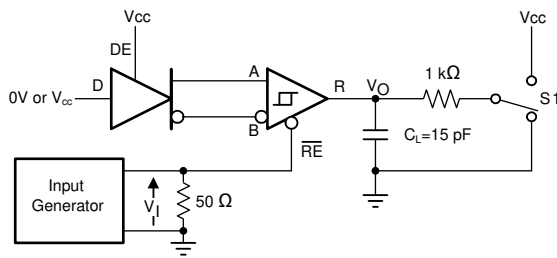

Figure 7-7. Measurement of Receiver Enable/Disable Times With Driver Enabled

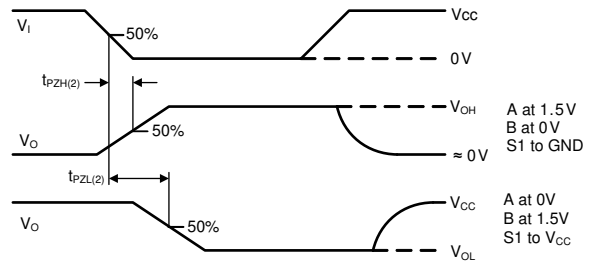
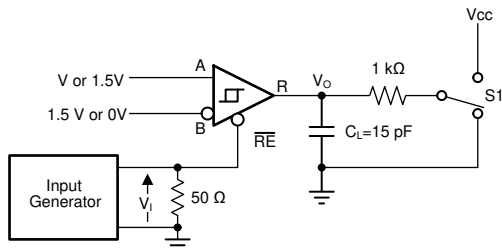

Figure 7-8. Measurement of Receiver Enable Times With Driver Disabled

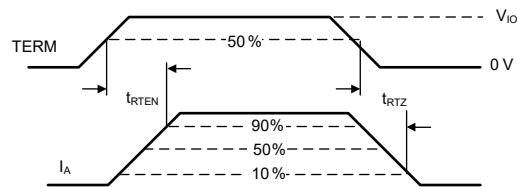
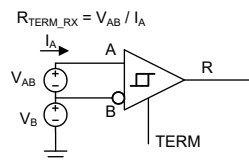

Figure 7-9. Measurement of enable and disable times of bus terminal termination resistor

8 Detailed Description

8.1 Overview

The THVD1454 is a flexible half duplex RS-485 transceiver. The device has slew rate control pin SLR which can be used to set the device in maximum 20 Mbps mode or slew rate limited 500 kbps mode. THVD1454 also has on-chip 120 Ω termination resistor across bus terminals A/B which is controlled using TERM pin.

8.2 Functional Block Diagrams

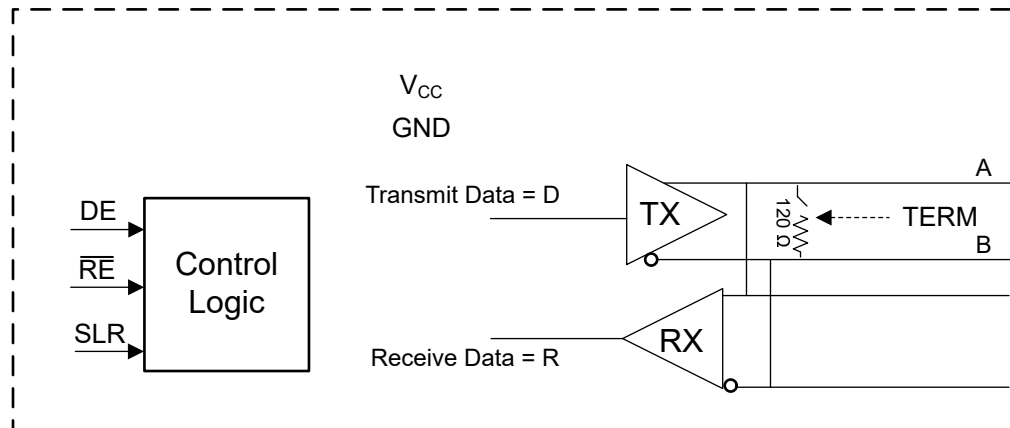

8.3 Feature Description

The THVD1454 operates from 3 V to 5.5 V bus supply. Internal ESD protection circuits on bus pins protect the transceiver against Electrostatic Discharges (ESD) according to IEC 61000-4-2 of up to ± 8 kV (Contact Discharge), ± 15 kV (Air Gap Discharge) and against electrical fast transients (EFT) according to IEC 61000-4-4 of up to ± 4 kV.

8.4 Device Functional Modes

When the driver enable pin, DE, is logic high, the differential outputs A and B follow the logic states at data input D. A logic high at D causes A to turn high and B to turn low. In this condition, the differential output voltage defined as $V_{OD} = V_A - V_B$ is positive. When D is low, the output states reverse, B turns high, A becomes low, and V_{OD} is negative.

When DE is low, both outputs turn high-impedance. In this condition, the logic state at D is irrelevant. The DE pin has an internal pull-down resistor to ground; thus, when left open, the driver is disabled (high-impedance) by default. The D pin has an internal pull-up resistor to V_{CC} , thus, when left open while the driver is enabled, output A turns high and B turns low.

Table 8-1. Driver Function Table

INPUT	ENABLE	OUTPUTS		FUNCTION
		A	B	
H	H	H	L	Actively drive bus high
L	H	L	H	Actively drive bus low
X	L	Z	Z	Driver disabled
X	OPEN	Z	Z	Driver disabled by default
OPEN	H	H	L	Actively drive bus high by default

When the receiver enable pin, \overline{RE} , is logic low, the receiver is enabled. When the differential input voltage defined as $V_{ID} = V_A - V_B$ is positive and higher than the positive input threshold, V_{TH+} , the receiver output, R, turns high. When V_{ID} is negative and lower than the negative input threshold, V_{TH-} , the receiver output, R, turns low. If V_{ID} is between V_{TH+} and V_{TH-} , the output is indeterminate.

When \overline{RE} is logic high or left open, the receiver output is high-impedance and the magnitude and polarity of V_{ID} are irrelevant. Internal biasing of the receiver inputs causes the output to go fail safe-high when the transceiver is disconnected from the bus (open-circuit), the bus lines are shorted (short-circuit), or the bus is not actively driven (idle bus).

Table 8-2. Receiver Function Table

DIFFERENTIAL INPUT	ENABLE	OUTPUT	FUNCTION
$V_{ID} = V_A - V_B$	\overline{RE}	R	
$V_{TH+} < V_{ID}$	L	H	Receive valid bus high
$V_{TH-} < V_{ID} < V_{TH+}$	L	?	Indeterminate bus state
$V_{ID} < V_{TH-}$	L	L	Receive valid bus low
X	H	Z	Receiver disabled
X	OPEN	Z	Receiver disabled by default
Open-circuit bus	L	H	Fail-safe high output
Short-circuit bus	L	H	Fail-safe high output
Idle (terminated) bus	L	H	Fail-safe high output

8.4.1 On-Chip Switchable Termination

THVD1454 has integrated termination resistor of nominal 120 Ω across A/B bus terminals. Termination resistor is enabled or disabled using the TERM pin described in [Table 8-3](#).

Table 8-3. On-chip termination function table

Signal state	Function	Comments
TERM = V_{CC}	120 Ω enabled between A and B	
TERM = GND or floating	120 Ω disabled between A and B	Termination is disabled by default

On-chip 120 Ω termination resistor variation with temperature and across common mode voltage is shown in [Figure 8-1](#) and [Figure 8-2](#).

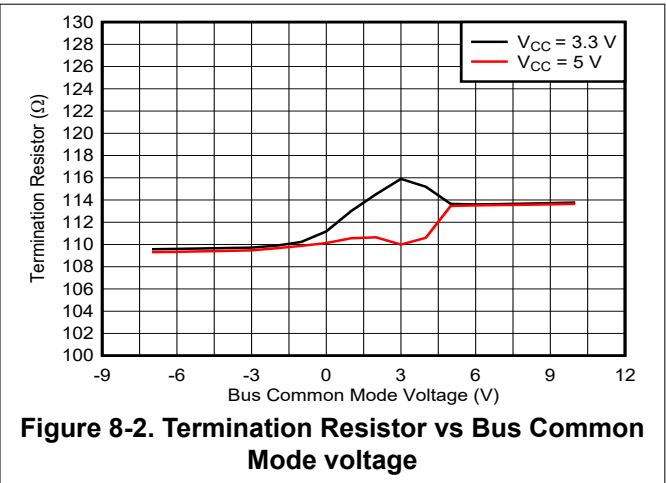
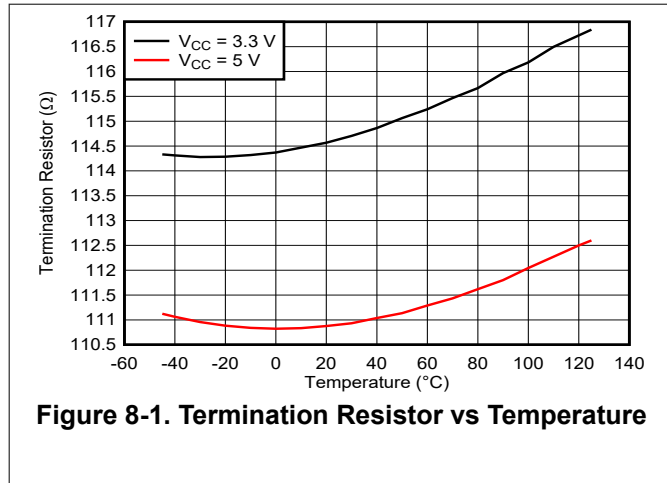

THVD1454 on-chip termination resistor has been designed so the termination block offers a resistive load to the bus, and does not alter the magnitude or phase of the bus signals from DC to 20Mbps signaling. See [Figure 8-3](#) and [Figure 8-4](#) with the bus voltage swept from -6 V to +6 V. Current into the bus changes linearly in both conditions of termination ON or OFF.

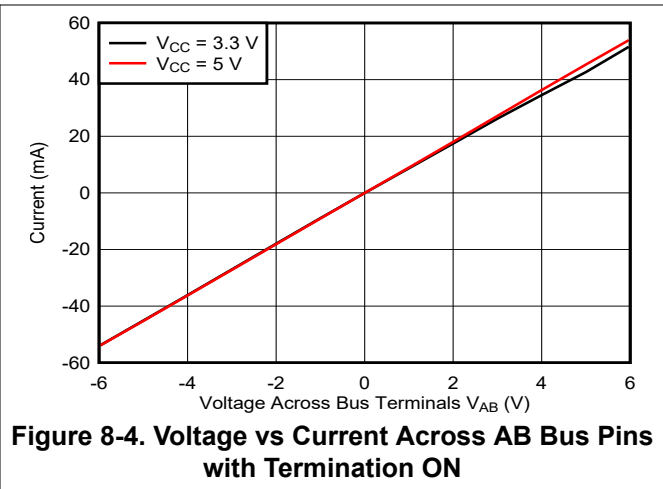
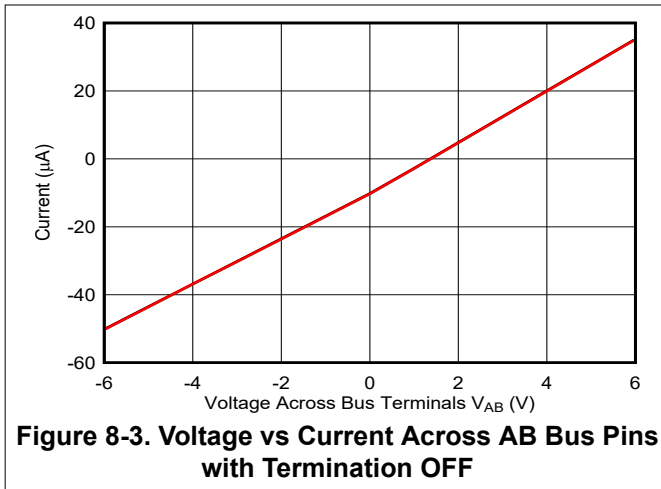

8.4.2 Operational Data rate

THVD1454 can be used in slow speed or fast speed RS-485 networks by configuring Slew rate control (SLR) pin. [Table 8-4](#) describes slew rate control function.

Table 8-4. Slew rate control function table

Signal state	Driver	Receiver	Comment
SLR = V _{CC}	Maximum speed of operation = 500kbps	Maximum speed of operation = 500kbps	Active high slew rate limiting applied on driver output and glitch filter in receiver path enabled
SLR = GND or floating	Maximum speed of operation = 20Mbps	Maximum speed of operation = 20Mbps	Slew rate limiting on driver output disabled and glitch filter in receiver path disabled

Receiver path in the slow speed mode (500kbps) provides additional noise filtering. To attenuate noise frequency noise pulses from the bus which can be wrongly interpreted as valid data, SLR = V_{CC} enables a low pass filter to filter out pulses with frequency higher than typical 800 kHz.

8.4.3 Protection Features

THVD1454 has in-built protection features such as supply undervoltage, bus short circuit and thermal shutdown.

Supply undervoltage protection is present on V_{CC} supply. This maintains the bus output and receiver logic output in known driven state when the supply is above the rising undervoltage threshold. [Table 8-5](#) describes the device behavior in various scenarios of supply levels.

Table 8-5. Supply Function Table

V _{CC}	Driver Output	Receiver Output	Termination across bus pins AB
> UV _{VCC(rising)}	Determined by DE and D inputs	Determined by \overline{RE} and A-B	Determined by TERM pin
< UV _{VCC(falling)}	High impedance	Undetermined	OFF

Bus terminals are protected against high voltage short circuit events up to ± 16 V. Additionally, bus short circuit current is limited to 250 mA. In events like bus contention when multiple drivers are driving the bus simultaneously, the current through the bus terminals is internally limited. If the power dissipation makes the junction temperature cross 150°C, thermal shutdown is activated which disables the driver and receiver and reduces the on-chip power dissipation. The device is enabled once the junction temperature falls by the thermal shutdown hysteresis as specified in electrical parameter section of the data sheet.

9 Application Information Disclaimer

Note

Information in the following applications sections is not part of the TI component specification, and TI does not warrant its accuracy or completeness. TI's customers are responsible for determining suitability of components for their purposes, as well as validating and testing their design implementation to confirm system functionality.

9.1 Application Information

The THVD1454 is a flexible RS-485 transceiver used for asynchronous data transmissions. The driver and receiver enable pins, slew rate control, and termination control pins allow the device to be applicable for various point-to-point, multipoint or multidrop network configurations.

9.2 Typical Application

An RS-485 bus consists of multiple transceivers connecting in parallel to a bus cable. To eliminate line reflections, each cable end is terminated with a termination resistor, R_T , whose value matches the characteristic impedance, Z_0 , of the cable. This method, known as parallel termination, allows for higher data rates over longer cable length. Figure 9-1 shows two end nodes terminated, while remaining nodes unterminated. THVD1454 can be designed in all node designs. TERM pin allows configuring the nodes for end nodes and middle nodes in the network.

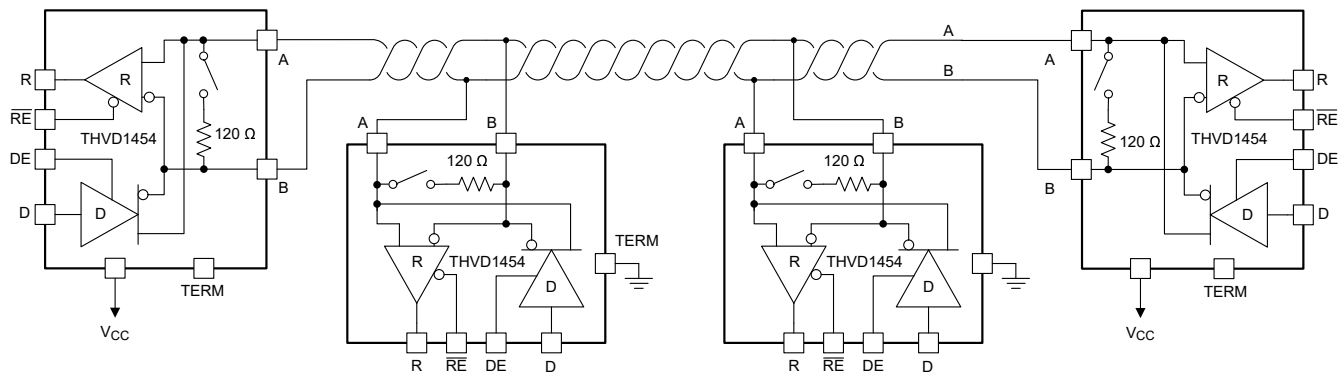

Figure 9-1. Typical Half Duplex RS-485 Network With all Nodes Using THVD1454

9.2.1 Design Requirements

RS-485 is a robust electrical standard suitable for long-distance networking that may be used in a wide range of applications with varying requirements, such as distance, data rate, and number of nodes.

9.2.1.1 Data Rate and Bus Length

There is an inverse relationship between data rate and cable length, which means the higher the data rate, the shorter the cable length; and conversely, the lower the data rate, the longer the cable length. While most RS-485 systems use data rates between 10 kbps and 100 kbps, some applications require data rates up to 300 kbps at distances of 4000 feet and longer. Longer distances are possible by allowing for small signal jitter of up to 5% or 10%.

9.2.1.2 Stub Length

When connecting a node to the bus, the distance between the transceiver inputs and the cable trunk, known as the stub, should be as short as possible. Stubs present a non-terminated piece of bus line which can introduce reflections as the length of the stub increases. As a general guideline, the electrical length, or round-trip delay, of a stub should be less than one-tenth of the rise time of the driver, thus giving a maximum physical stub length as shown in [Equation 1](#).

$$L_{(\text{STUB})} \leq 0.1 \times t_r \times v \times c \quad (1)$$

where:

- t_r is the 10/90 rise time of the driver
- c is the speed of light (3×10^8 m/s)
- v is the signal velocity of the cable or trace as a factor of c

THVD1454 can be used in both slow speed and high speed networks with SLR pin configurability. Slew rate limiting makes the driver output rise or fall time slower so that stub lengths can be increased.

9.2.1.3 Bus Loading

The RS-485 standard specifies that a compliant driver must be able to driver 32 unit loads (UL), where 1 unit load represents a load impedance of approximately 12 k Ω . Because the THVD1454 consists of 1/8 UL transceivers, connecting up to 256 transceivers to the bus is possible.

9.2.1.4 Receiver Failsafe

The differential receiver of the THVD1454 is *failsafe* to invalid bus states caused by the following:

- Open bus conditions, such as a disconnected connector
- Shorted bus conditions, such as cable damage shorting the twisted-pair together
- Idle bus conditions that occur when no driver on the bus is actively driving

In any of these cases, the differential receiver outputs a failsafe logic high state so that the output of the receiver is not indeterminate.

Receiver failsafe is accomplished by offsetting the receiver thresholds such that the *input indeterminate* range does not include zero volts differential. To comply with the RS-422 and RS-485 standards, the receiver output must output a high when the differential input V_{ID} is more positive than 200 mV, and must output a low when V_{ID} is more negative than -200 mV. The receiver parameters which determine the failsafe performance are V_{TH+} , V_{TH-} , and V_{HYS} (the separation between V_{TH+} and V_{TH-}). As shown in the [Table 8-2](#), differential signals more negative than -200 mV always causes a low receiver output, and differential signals more positive than 200 mV always causes a high receiver output.

When the differential input signal is close to zero, it is still above the V_{TH+} threshold, and the receiver output is high. Only when the differential input is more than V_{HYS} below V_{TH+} does the receiver output transition to a low state. Therefore, the noise immunity of the receiver inputs during a bus fault conditions includes the receiver hysteresis value, V_{HYS} , as well as the value of V_{TH+} .

9.2.1.5 Transient Protection

The bus pins of the THVD1454 transceiver family include on-chip ESD protection against ± 16 -kV HBM and ± 8 -kV IEC 61000-4-2 contact discharge. The International Electrotechnical Commission (IEC) ESD test is far more severe than the HBM ESD test. The 50% higher charge capacitance, $C_{(S)}$, and 78% lower discharge resistance, $R_{(D)}$, of the IEC model produce significantly higher discharge currents than the HBM model.

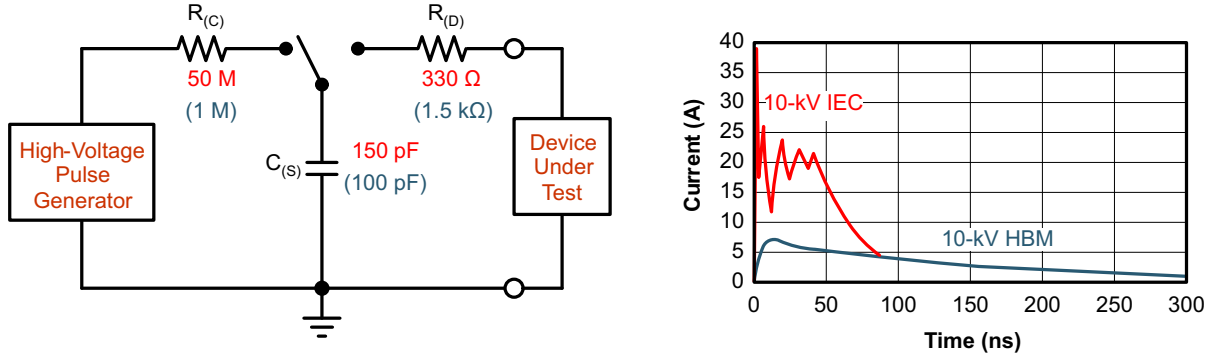

Figure 9-2. HBM and IEC ESD Models and Currents in Comparison (HBM Values in Parenthesis)

The on-chip implementation of IEC ESD protection significantly increases the robustness of equipment. Common discharge events occur because of human contact with connectors and cables. Designers may choose to implement protection against longer duration transients, typically referred to as surge transients.

EFTs are generally caused by relay-contact bounce or the interruption of inductive loads. Surge transients often result from lightning strikes (direct strike or an indirect strike which induce voltages and currents), or the switching of power systems, including load changes and short circuit switching. These transients are often encountered in industrial environments, such as factory automation and power-grid systems.

Figure 9-3 compares the pulse-power of the EFT and surge transients with the power caused by an IEC ESD transient. The left side of the diagram shows the relative pulse-power for a 0.5-kV surge transient and 4-kV EFT transient, both of which exceed the 10-kV ESD transient visible in the lower-left corner. 500-V surge transients are representative of events that may occur in factory environments in industrial and process automation.

The right side of the diagram shows the pulse-power of a 6-kV surge transient, relative to the same 0.5-kV surge transient. 6-kV surge transients may occur in power generation and power-grid systems.

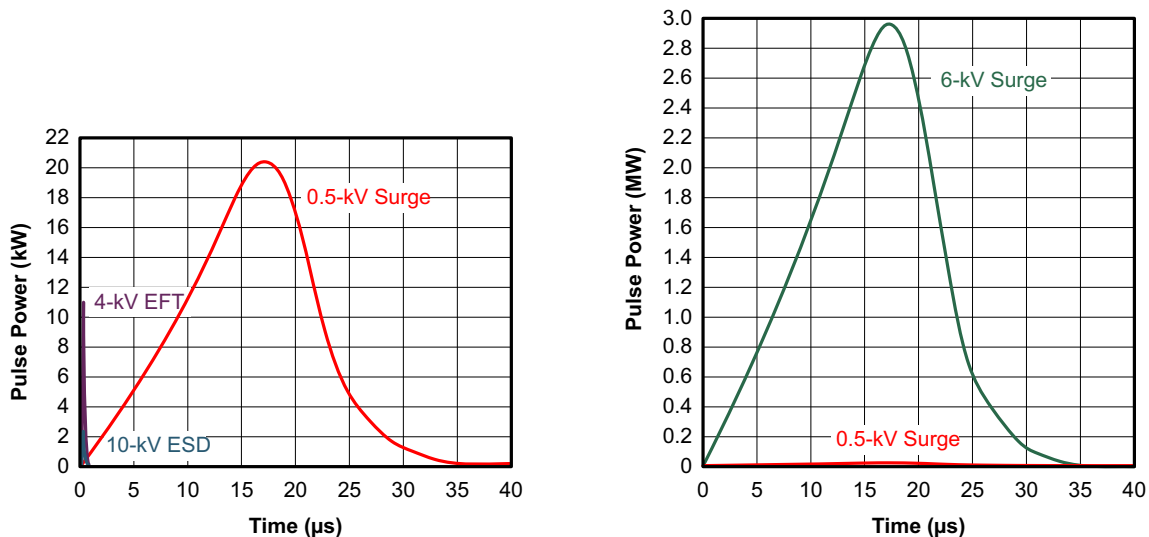

Figure 9-3. Power Comparison of ESD, EFT, and Surge Transients

For surge transients, high-energy content is characterized by long pulse duration and slow decaying pulse power. The electrical energy of a transient that is dumped into the internal protection cells of a transceiver is converted into thermal energy, which heats and destroys the protection cells, thus destroying the transceiver. Figure 9-4 shows the large differences in transient energies for single ESD, EFT, surge transients, and an EFT pulse train that is commonly applied during compliance testing.

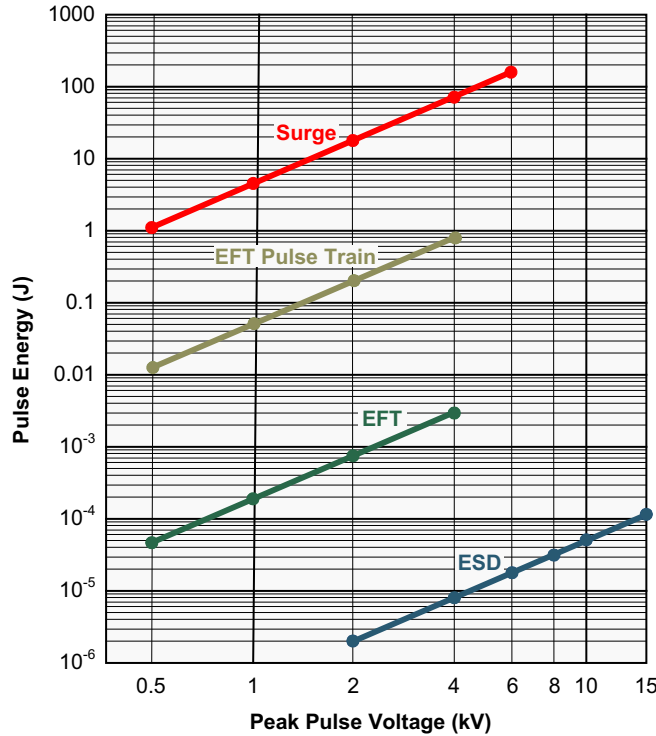

Figure 9-4. Comparison of Transient Energies

9.2.2 Detailed Design Procedure

To protect bus nodes against high-energy transients, the implementation of external transient protection devices is necessary. [Figure 9-5](#) suggests a protection circuit against 1 kV surge (IEC 61000-4-5) transients. [Table 9-1](#) shows the associated bill of materials.

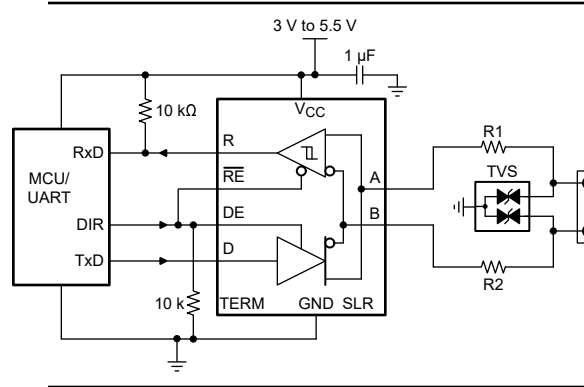

Figure 9-5. Transient Protection Against Surge Transients for THVD1454

Table 9-1. Bill of Materials

DEVICE	FUNCTION	ORDER NUMBER	MANUFACTURER ⁽¹⁾
XCVR	RS-485 transceiver	THVD1454	TI
R1	10-Ω, pulse-proof thick-film resistor	CRCW0603010RJNEAHP	Vishay
R2			
TVS	Bidirectional 400-W transient suppressor	CDSOT23-SM712	Bourns

(1) See the [Third Part Disclaimer](#).

9.2.3 Application Curves

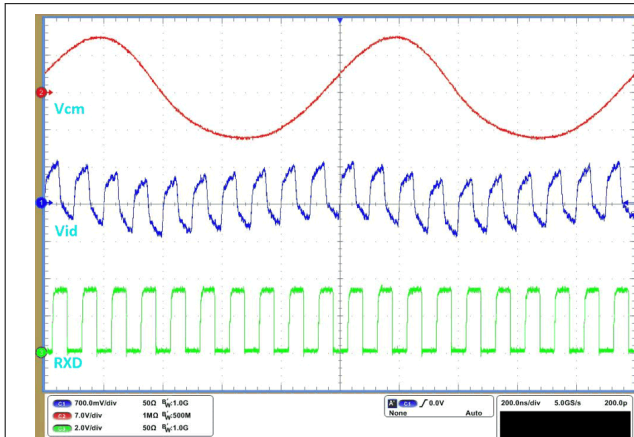

Figure 9-6. Receiver Waveforms at 20 Mbps, with Common Mode Moving at 1 Mhz

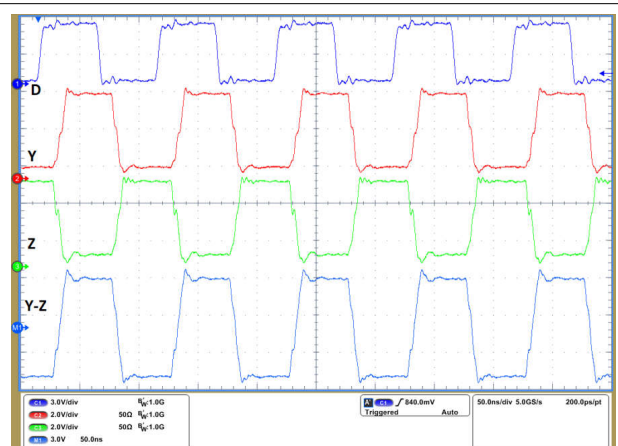

Figure 9-7. Driver Waveforms at 20 Mbps with Termination Enabled

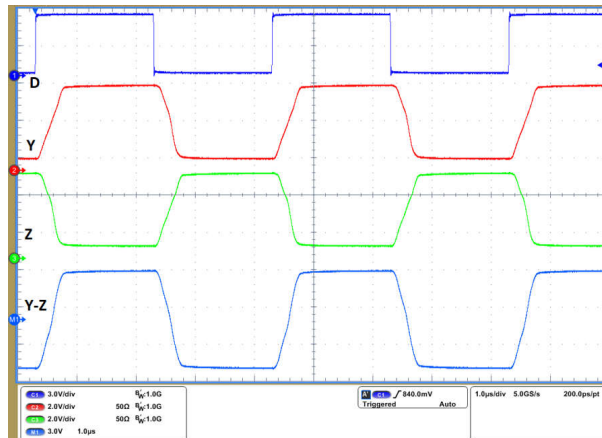

Figure 9-8. Driver Waveforms at 500 kbps with Termination Enabled

9.3 Power Supply Recommendations

For reliable operation at all data rates and supply voltages, V_{CC} supply should be decoupled with a 1 μF ceramic capacitor located as close to the supply pin as possible. This helps to reduce supply voltage ripple present on the outputs of switched-mode power supplies and also helps to compensate for the resistance and inductance of the PCB power planes.

9.4 Layout

9.4.1 Layout Guidelines

Robust and reliable bus node design often requires the use of external transient protection devices in order to protect against surge transients that may occur in industrial environments. Since these transients have a wide frequency bandwidth (from approximately 3 MHz to 300 MHz), high-frequency layout techniques should be applied during PCB design.

1. Place the protection circuitry close to the bus connector to prevent noise transients from propagating across the board.
2. Use V_{CC} and ground planes to provide low inductance. Note that high-frequency currents tend to follow the path of least impedance and not the path of least resistance.
3. Design the protection components into the direction of the signal path. Do not force the transient currents to divert from the signal path to reach the protection device.
4. Apply at least 1 μF decoupling capacitors as close as possible to the V_{CC} pin of the transceiver, UART and/or controller ICs on the board.
5. Use at least two vias for V_{CC} and ground connections of decoupling capacitors and protection devices to minimize effective via inductance.
6. Use 1-k Ω to 10-k Ω pull-up and pull-down resistors for logic lines to limit noise currents in these lines during transient events.
7. Insert pulse-proof resistors into the A and B bus lines if the TVS clamping voltage is higher than the specified maximum voltage of the transceiver bus pins. These resistors limit the residual clamping current into the transceiver and prevent it from latching up.
8. While pure TVS protection is sufficient for surge transients up to 1 kV, higher transients require metal-oxide varistors (MOVs) which reduce the transients to a few hundred volts of clamping voltage, and transient blocking units (TBUs) that limit transient current to less than 1 mA.

9.4.2 Layout Example

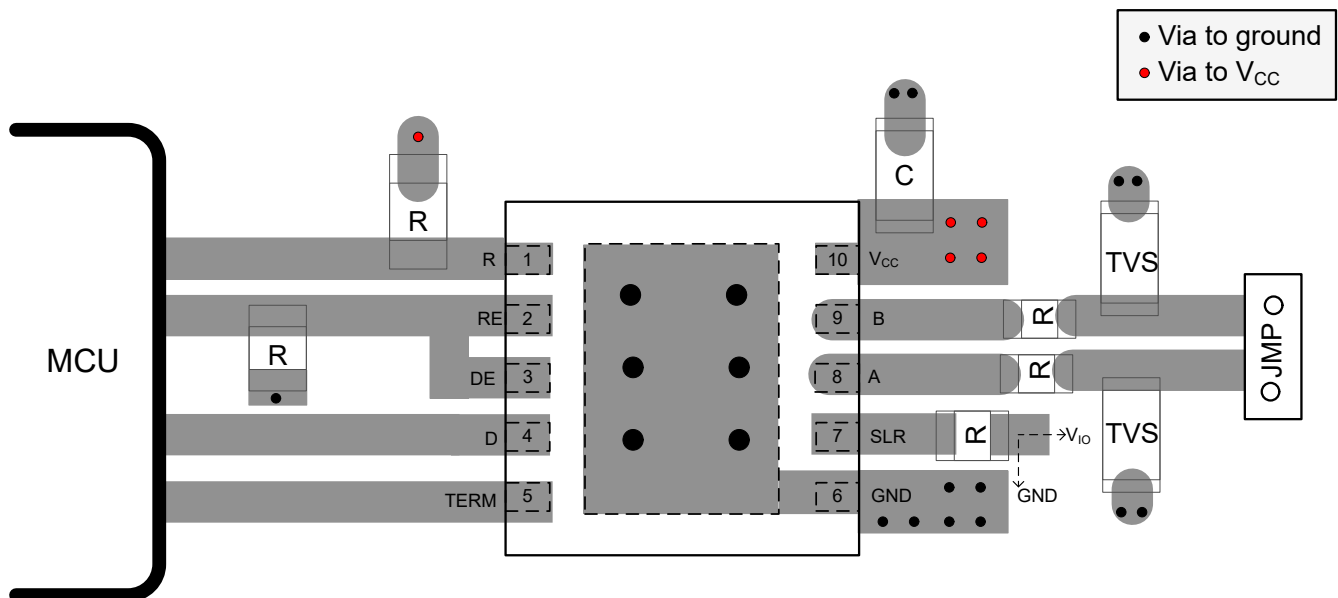

Figure 9-9. Layout Example for THVD1454 in VSON-10 Package

10 Device and Documentation Support

10.1 Device Support

10.1.1 Third-Party Products Disclaimer

TI'S PUBLICATION OF INFORMATION REGARDING THIRD-PARTY PRODUCTS OR SERVICES DOES NOT CONSTITUTE AN ENDORSEMENT REGARDING THE SUITABILITY OF SUCH PRODUCTS OR SERVICES OR A WARRANTY, REPRESENTATION OR ENDORSEMENT OF SUCH PRODUCTS OR SERVICES, EITHER ALONE OR IN COMBINATION WITH ANY TI PRODUCT OR SERVICE.

10.2 Receiving Notification of Documentation Updates

To receive notification of documentation updates, navigate to the device product folder on ti.com. Click on *Subscribe to updates* to register and receive a weekly digest of any product information that has changed. For change details, review the revision history included in any revised document.

10.3 Support Resources

[TI E2E™ support forums](#) are an engineer's go-to source for fast, verified answers and design help — straight from the experts. Search existing answers or ask your own question to get the quick design help you need.

Linked content is provided "AS IS" by the respective contributors. They do not constitute TI specifications and do not necessarily reflect TI's views; see TI's [Terms of Use](#).

10.4 Trademarks

TI E2E™ is a trademark of Texas Instruments.

All trademarks are the property of their respective owners.

10.5 Electrostatic Discharge Caution



This integrated circuit can be damaged by ESD. Texas Instruments recommends that all integrated circuits be handled with appropriate precautions. Failure to observe proper handling and installation procedures can cause damage.

ESD damage can range from subtle performance degradation to complete device failure. Precision integrated circuits may be more susceptible to damage because very small parametric changes could cause the device not to meet its published specifications.

10.6 Glossary

[TI Glossary](#) This glossary lists and explains terms, acronyms, and definitions.

11 Mechanical, Packaging, and Orderable Information

The following pages include mechanical, packaging, and orderable information. This information is the most current data available for the designated devices. This data is subject to change without notice and revision of this document. For browser-based versions of this data sheet, refer to the left-hand navigation.

PACKAGING INFORMATION

Orderable part number	Status (1)	Material type (2)	Package Pins	Package qty Carrier	RoHS (3)	Lead finish/ Ball material (4)	MSL rating/ Peak reflow (5)	Op temp (°C)	Part marking (6)
THVD1454DRCR	Active	Production	VSON (DRC) 10	5000 LARGE T&R	Yes	SN	Level-1-260C-UNLIM	-40 to 125	1454
THVD1454DRCR.A	Active	Production	VSON (DRC) 10	5000 LARGE T&R	Yes	SN	Level-1-260C-UNLIM	-40 to 125	1454

(1) **Status:** For more details on status, see our [product life cycle](#).

(2) **Material type:** When designated, preproduction parts are prototypes/experimental devices, and are not yet approved or released for full production. Testing and final process, including without limitation quality assurance, reliability performance testing, and/or process qualification, may not yet be complete, and this item is subject to further changes or possible discontinuation. If available for ordering, purchases will be subject to an additional waiver at checkout, and are intended for early internal evaluation purposes only. These items are sold without warranties of any kind.

(3) **RoHS values:** Yes, No, RoHS Exempt. See the [TI RoHS Statement](#) for additional information and value definition.

(4) **Lead finish/Ball material:** Parts may have multiple material finish options. Finish options are separated by a vertical ruled line. Lead finish/Ball material values may wrap to two lines if the finish value exceeds the maximum column width.

(5) **MSL rating/Peak reflow:** The moisture sensitivity level ratings and peak solder (reflow) temperatures. In the event that a part has multiple moisture sensitivity ratings, only the lowest level per JEDEC standards is shown. Refer to the shipping label for the actual reflow temperature that will be used to mount the part to the printed circuit board.

(6) **Part marking:** There may be an additional marking, which relates to the logo, the lot trace code information, or the environmental category of the part.

Multiple part markings will be inside parentheses. Only one part marking contained in parentheses and separated by a "~" will appear on a part. If a line is indented then it is a continuation of the previous line and the two combined represent the entire part marking for that device.

Important Information and Disclaimer: The information provided on this page represents TI's knowledge and belief as of the date that it is provided. TI bases its knowledge and belief on information provided by third parties, and makes no representation or warranty as to the accuracy of such information. Efforts are underway to better integrate information from third parties. TI has taken and continues to take reasonable steps to provide representative and accurate information but may not have conducted destructive testing or chemical analysis on incoming materials and chemicals. TI and TI suppliers consider certain information to be proprietary, and thus CAS numbers and other limited information may not be available for release.

In no event shall TI's liability arising out of such information exceed the total purchase price of the TI part(s) at issue in this document sold by TI to Customer on an annual basis.

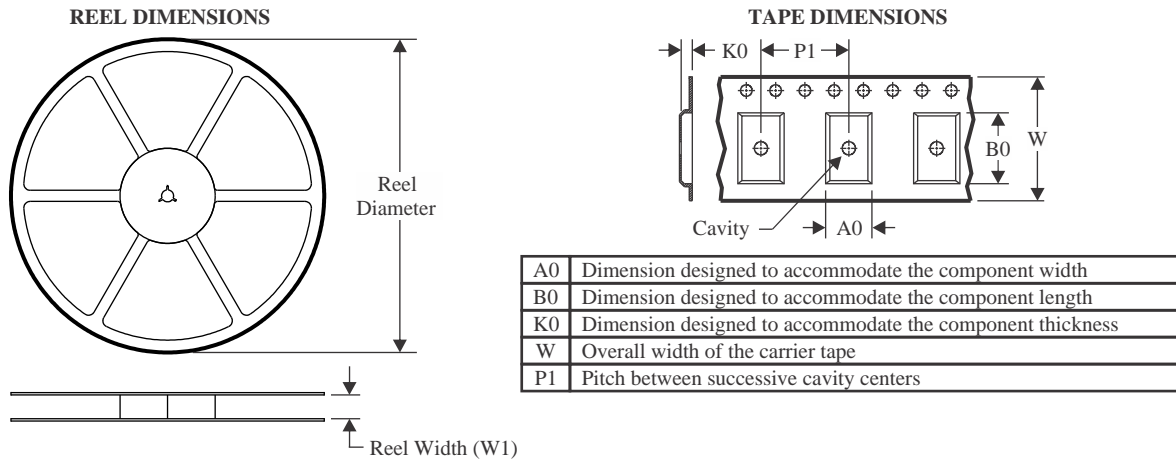
TAPE AND REEL INFORMATION

QUADRANT ASSIGNMENTS FOR PIN 1 ORIENTATION IN TAPE

*All dimensions are nominal

Device	Package Type	Package Drawing	Pins	SPQ	Reel Diameter (mm)	Reel Width W1 (mm)	A0 (mm)	B0 (mm)	K0 (mm)	P1 (mm)	W (mm)	Pin1 Quadrant
THVD1454DRCR	VSON	DRC	10	5000	330.0	12.4	3.3	3.3	1.1	8.0	12.0	Q2

TAPE AND REEL BOX DIMENSIONS

*All dimensions are nominal

Device	Package Type	Package Drawing	Pins	SPQ	Length (mm)	Width (mm)	Height (mm)
THVD1454DRCR	VSON	DRC	10	5000	367.0	367.0	35.0

GENERIC PACKAGE VIEW

DRC 10

VSON - 1 mm max height

3 x 3, 0.5 mm pitch

PLASTIC SMALL OUTLINE - NO LEAD

This image is a representation of the package family, actual package may vary.
Refer to the product data sheet for package details.

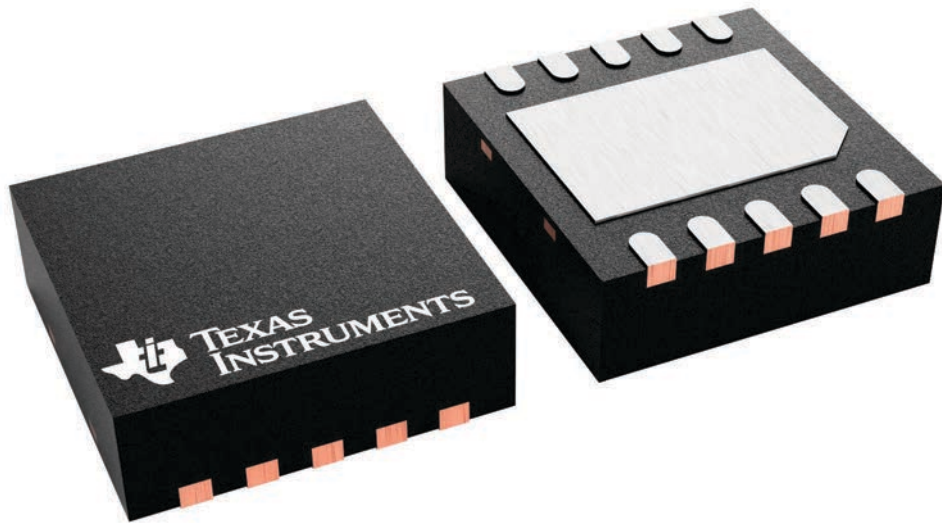

4226193/A

EXAMPLE STENCIL DESIGN

DRC0010V

VSON - 1 mm max height

PLASTIC SMALL OUTLINE - NO LEAD

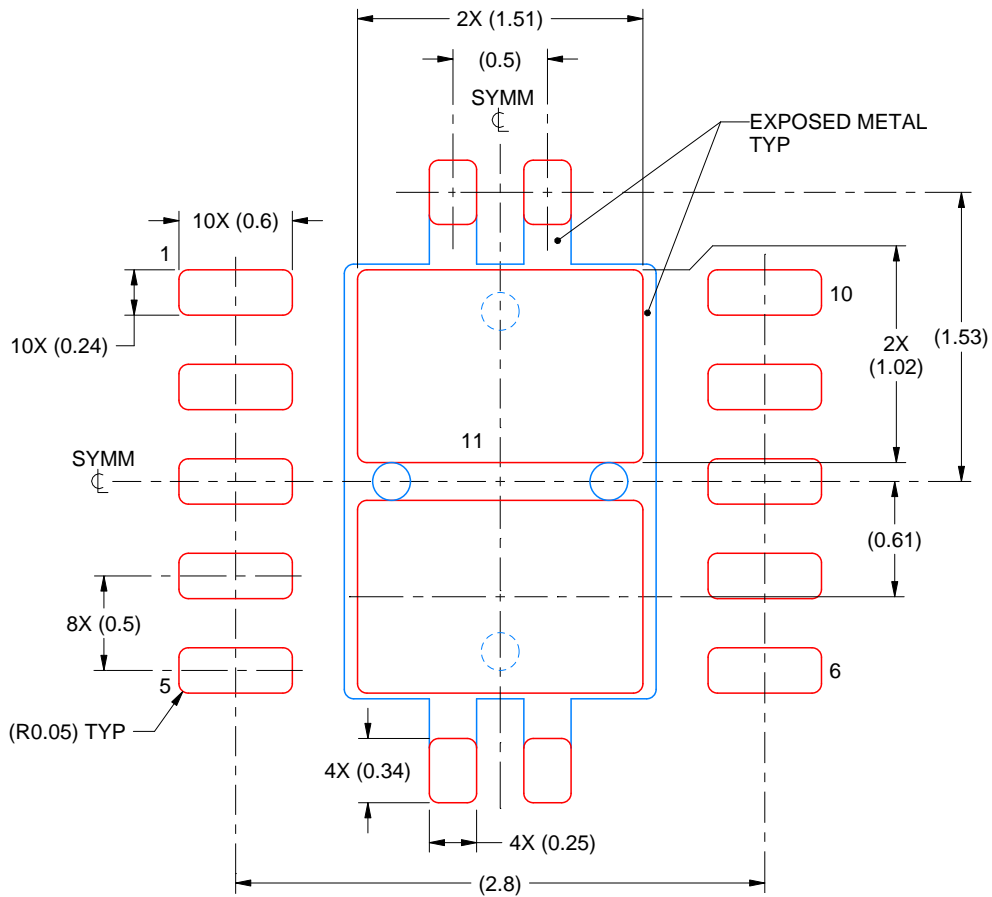

SOLDER PASTE EXAMPLE
BASED ON 0.125 mm THICK STENCIL

EXPOSED PAD 11:
80% PRINTED SOLDER COVERAGE BY AREA
SCALE:25X

4226575/A 02/2021

NOTES: (continued)

6. Laser cutting apertures with trapezoidal walls and rounded corners may offer better paste release. IPC-7525 may have alternate design recommendations.

IMPORTANT NOTICE AND DISCLAIMER

TI PROVIDES TECHNICAL AND RELIABILITY DATA (INCLUDING DATASHEETS), DESIGN RESOURCES (INCLUDING REFERENCE DESIGNS), APPLICATION OR OTHER DESIGN ADVICE, WEB TOOLS, SAFETY INFORMATION, AND OTHER RESOURCES "AS IS" AND WITH ALL FAULTS, AND DISCLAIMS ALL WARRANTIES, EXPRESS AND IMPLIED, INCLUDING WITHOUT LIMITATION ANY IMPLIED WARRANTIES OF MERCHANTABILITY, FITNESS FOR A PARTICULAR PURPOSE OR NON-INFRINGEMENT OF THIRD PARTY INTELLECTUAL PROPERTY RIGHTS.

These resources are intended for skilled developers designing with TI products. You are solely responsible for (1) selecting the appropriate TI products for your application, (2) designing, validating and testing your application, and (3) ensuring your application meets applicable standards, and any other safety, security, regulatory or other requirements.

These resources are subject to change without notice. TI grants you permission to use these resources only for development of an application that uses the TI products described in the resource. Other reproduction and display of these resources is prohibited. No license is granted to any other TI intellectual property right or to any third party intellectual property right. TI disclaims responsibility for, and you fully indemnify TI and its representatives against any claims, damages, costs, losses, and liabilities arising out of your use of these resources.

TI's products are provided subject to [TI's Terms of Sale](#), [TI's General Quality Guidelines](#), or other applicable terms available either on ti.com or provided in conjunction with such TI products. TI's provision of these resources does not expand or otherwise alter TI's applicable warranties or warranty disclaimers for TI products. Unless TI explicitly designates a product as custom or customer-specified, TI products are standard, catalog, general purpose devices.

TI objects to and rejects any additional or different terms you may propose.

Copyright © 2026, Texas Instruments Incorporated

Last updated 10/2025