

TLE207x-Q1, TLE207xA-Q1 EXCALIBUR LOW-NOISE HIGH-SPEED JFET-INPUT OPERATIONAL AMPLIFIERS

SGLS226B – DECEMBER 2003 – REVISED MAY 2008

- Qualified for Automotive Applications
- Direct Upgrades to TL05x, TL07x, and TL08x BiFET Operational Amplifiers
- Greater Than 2× Bandwidth (10 MHz) and 3× Slew Rate (45 V/μs) Than TL07x
- Ensured Maximum Noise Floor 17 nV/√Hz
- On-Chip Offset Voltage Trimming for Improved DC Performance
- Wider Supply Rails Increase Dynamic Signal Range to ±19 V

description/ordering information

The TLE207x series of JFET-input operational amplifiers more than double the bandwidth and triple the slew rate of the TL07x and TL08x families of BiFET operational amplifiers. Texas Instruments Excalibur process yields a typical noise floor of 11.6 nV/√Hz, 17-nV/√Hz ensured maximum, offering immediate improvement in noise-sensitive circuits designed using the TL07x. The TLE207x also has wider supply voltage rails, increasing the dynamic signal range for BiFET circuits to ±19 V. On-chip zener trimming of offset voltage yields precision grades for greater accuracy in dc-coupled applications. The TLE207x are pin-compatible with lower performance BiFET operational amplifiers for ease in improving performance in existing designs.

BiFET operational amplifiers offer the inherently higher input impedance of the JFET-input transistors, without sacrificing the output drive associated with bipolar amplifiers. This makes them better suited for interfacing with high-impedance sensors or very low-level ac signals. They also feature inherently better ac response than bipolar or CMOS devices having comparable power consumption.

The TLE207x family of BiFET amplifiers are Texas Instruments highest performance BiFETs, with tighter input offset voltage and ensured maximum noise specifications. Designers requiring less stringent specifications but seeking the improved ac characteristics of the TLE207x should consider the TLE208x operational amplifier family.

Because BiFET operational amplifiers are designed for use with dual power supplies, care must be taken to observe common-mode input voltage limits and output swing when operating from a single supply. DC biasing of the input signal is required and loads should be terminated to a virtual ground node at mid-supply. Texas Instruments TLE2426 integrated virtual ground generator is useful when operating BiFET amplifiers from single supplies.

ORDERING INFORMATION†

T _A	V _{IO} max AT 25°C	PACKAGE‡		ORDERABLE PART NUMBER	TOP-SIDE MARKING
-40°C to 125°C	2 mV	SOIC – D	Tape and reel	TLE2071AQDRQ1	2071AQ
	4 mV	SOIC – D	Tape and reel	TLE2071QDRQ1	2071Q1
	3.5 mV	SOIC – D	Tape and reel	TLE2072AQDRQ1	2072AQ
	6 mV	SOIC – D	Tape and reel	TLE2072QDRQ1	2072Q1
	4 mV	SOP – DW	Tape and reel	TLE2074AQDWRQ1§	TLE2074AQ1
	7 mV	SOP – DW	Tape and reel	TLE2074QDWRQ1§	TLE2074Q1

† For the most current package and ordering information, see the Package Option Addendum at the end of this document, or see the TI web site at <http://www.ti.com>.

‡ Package drawings, thermal data, and symbolization are available at <http://www.ti.com/packaging>.

§ Product Preview



Please be aware that an important notice concerning availability, standard warranty, and use in critical applications of Texas Instruments semiconductor products and disclaimers thereto appears at the end of this data sheet.

PRODUCTION DATA information is current as of publication date. Products conform to specifications per the terms of Texas Instruments standard warranty. Production processing does not necessarily include testing of all parameters.

 **TEXAS
INSTRUMENTS**

POST OFFICE BOX 655303 • DALLAS, TEXAS 75265

Copyright © 2008, Texas Instruments Incorporated

TLE207x-Q1, TLE207xA-Q1 EXCALIBUR LOW-NOISE HIGH-SPEED JFET-INPUT OPERATIONAL AMPLIFIERS

SGLS226B – DECEMBER 2003 – REVISED MAY 2008

description/ordering information (continued)

The TLE207x are fully specified at ± 15 V and ± 5 V. For operation in low-voltage and/or single-supply systems, Texas Instruments LinCMOS families of operational amplifiers (TLC- and TLV-prefix) are recommended. When moving from BiFET to CMOS amplifiers, particular attention should be paid to slew rate and bandwidth requirements and output loading.

**TLE2071 AND TLE2071A
D PACKAGE
(TOP VIEW)**

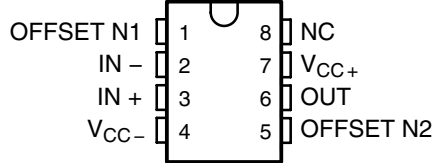

**TLE2072 AND TLE2072A
D PACKAGE
(TOP VIEW)**

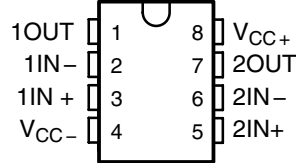

**TLE2074 AND TLE2074A
DW PACKAGE
(TOP VIEW)**

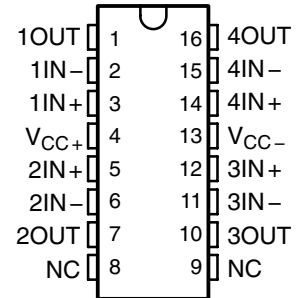

NC – No internal connection

symbol

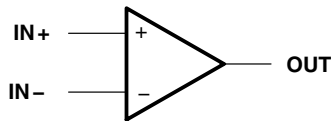

equivalent schematic

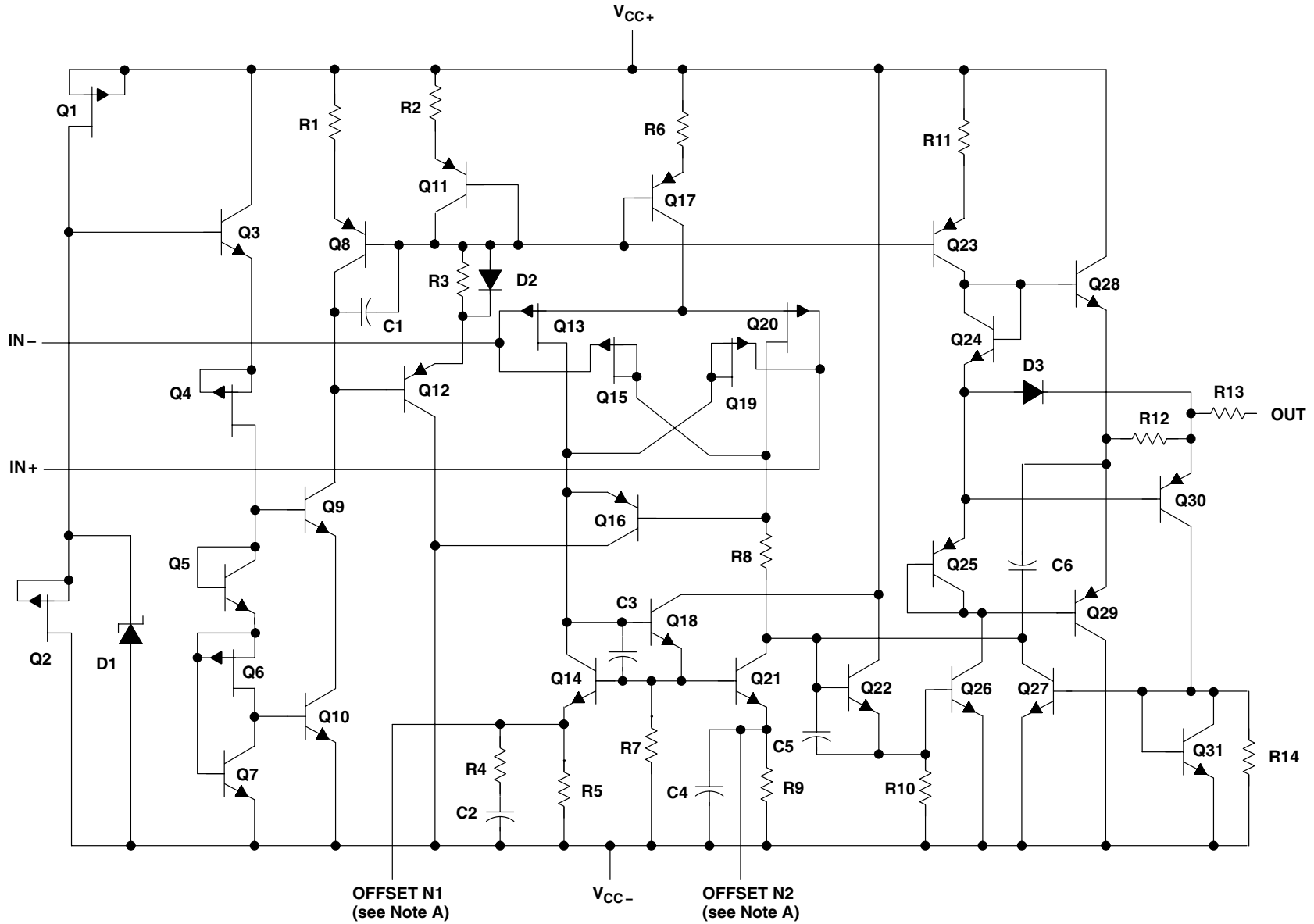

NOTES: A. OFFSET N1 AND OFFSET N2 are only available on the TLE2071x devices.

TLE207X-Q1, TLE207XA-Q1
EXCALIBUR LOW-NOISE HIGH-SPEED
JFET-INPUT OPERATIONAL AMPLIFIERS
SLOS181A – FEBRUARY 1997 – REVISED MARCH 2000 (sourced from)

equivalent schematic (continued)

ACTUAL DEVICE COMPONENT COUNT			
COMPONENT	TLE2071	TLE2072	TLE2074
Transistors	33	57	114
Resistors	25	37	74
Diodes	8	5	10
Capacitors	6	11	22

TLE207x-Q1, TLE207xA-Q1
EXCALIBUR LOW-NOISE HIGH-SPEED
JFET-INPUT OPERATIONAL AMPLIFIERS

SGLS226A – DECEMBER 2003 – REVISED AUGUST 2004

absolute maximum ratings over operating free-air temperature range (unless otherwise noted)†

Supply voltage, V_{CC+} (see Note 1)	19 V
Supply voltage, V_{CC-} (see Note 1)	–19 V
Differential input voltage range, V_{ID} (see Note 2)	V_{CC+} to V_{CC-}
Input voltage range, V_I (any input)	V_{CC+} to V_{CC-}
Input current, I_I (each input)	± 1 mA
Output current, I_O (each output)	± 80 mA
Total current into V_{CC+}	160 mA
Total current out of V_{CC-}	160 mA
Duration of short-circuit current at (or below) 25°C (see Note 3)	unlimited
Maximum Junction Temperature, T_J	150°C
Package thermal impedance, θ_{JA} (see Note 4): D package	126°C/W
DW package	75°C/W
Operating free-air temperature range, T_A : Q suffix	–40°C to 125°C
Storage temperature range	–65°C to 150°C
Lead temperature 1,6 mm (1/16 inch) from case for 3 seconds	300°C

† Stresses beyond those listed under “absolute maximum ratings” may cause permanent damage to the device. These are stress ratings only, and functional operation of the device at these or any other conditions beyond those indicated under “recommended operating conditions” is not implied. Exposure to absolute-maximum-rated conditions for extended periods may affect device reliability.

- NOTES:
1. All voltage values, except differential voltages, are with respect to the midpoint between V_{CC+} and V_{CC-} .
 2. Differential voltages are at the noninverting input with respect to the inverting input.
 3. The output may be shorted to either supply. Temperatures and/or supply voltages must be limited to ensure that the maximum dissipation rate is not exceeded.
 4. The package thermal impedance is calculated in accordance with JESD 51-7.

recommended operating conditions

		MIN	MAX	UNIT
Supply voltage, $V_{CC\pm}$		± 2.25	± 19	V
Common-mode input voltage, V_{IC}	$V_{CC\pm} = \pm 5$ V	–0.8	5	V
	$V_{CC\pm} = \pm 15$ V	–10.8	15	
Operating free-air temperature, T_A		–40	125	°C



TLE207x-Q1, TLE207xA-Q1 EXCALIBUR LOW-NOISE HIGH-SPEED JFET-INPUT OPERATIONAL AMPLIFIERS

SGLS226A – DECEMBER 2003 – REVISED AUGUST 2004

TLE2071-Q1 electrical characteristics at specified free-air temperature, $V_{CC\pm} = \pm 5\text{ V}$ (unless otherwise noted)

PARAMETER	TEST CONDITIONS	T_A^\dagger	TLE2071-Q1			TLE2071A-Q1			UNIT	
			MIN	TYP	MAX	MIN	TYP	MAX		
V_{IO} Input offset voltage	$V_{IC} = 0, V_O = 0,$ $R_S = 50\ \Omega,$	25°C	0.34	4		0.3	2	mV		
		Full range			9		7			
α_{VIO} Temperature coefficient of input offset voltage		Full range	3.2			3.2	20	$\mu\text{V}/^\circ\text{C}$		
I_{IO} Input offset current	$V_{IC} = 0, V_O = 0,$ See Figure 4	25°C	5	100		5	100	pA		
		Full range		20		20		nA		
I_{IB} Input bias current		25°C	15	175		15	175	pA		
		Full range		60		60		nA		
V_{ICR} Common-mode input voltage range	$R_S = 50\ \Omega$	25°C	5 to -1	5 to -1.9		5 to -1	5 to -1.9	V		
		Full range	5 to -0.8			5 to -0.8				
V_{OM+} Maximum positive peak output voltage swing	$I_O = -200\ \mu\text{A}$	25°C	3.8	4.1		3.8	4.1	V		
		Full range	3.6			3.6				
	$I_O = -2\ \text{mA}$	25°C	3.5	3.9		3.5	3.9			
		Full range	3.3			3.3				
	$I_O = -20\ \text{mA}$	25°C	1.5	2.3		1.5	2.3			
		Full range	1.4			1.4				
V_{OM-} Maximum negative peak output voltage swing	$I_O = 200\ \mu\text{A}$	25°C	-3.8	-4.2		-3.8	-4.2	V		
		Full range	-3.6			-3.6				
	$I_O = 2\ \text{mA}$	25°C	-3.5	-4.1		-3.5	-4.1			
		Full range	-3.3			-3.3				
	$I_O = 20\ \text{mA}$	25°C	-1.5	-2.4		-1.5	-2.4			
		Full range	-1.4			-1.4				
A_{VD} Large-signal differential voltage amplification	$V_O = \pm 2.3\ \text{V}$	$R_L = 600\ \Omega$	25°C	80	91		80	91	dB	
			Full range	78			78			
		$R_L = 2\ \text{k}\Omega$	25°C	90	100		90	100		
			Full range	88			88			
		$R_L = 10\ \text{k}\Omega$	25°C	95	106		95	106		
			Full range	93			93			
r_i Input resistance	$V_{IC} = 0$	25°C	10^{12}			10^{12}			Ω	
c_i Input capacitance	$V_{IC} = 0,$ See Figure 5	Common mode	25°C	11			11			pF
		Differential	25°C	2.5			2.5			
z_o Open-loop output impedance	$f = 1\ \text{MHz}$	25°C	80			80			Ω	
CMRR Common-mode rejection ratio	$V_{IC} = V_{ICRmin},$ $V_O = 0,$ $R_S = 50\ \Omega$	25°C	70	89		70	89	dB		
		Full range	68			68				
k_{SVR} Supply-voltage rejection ratio ($\Delta V_{CC\pm} / \Delta V_{IO}$)	$V_{CC\pm} = \pm 5\ \text{V to } \pm 15\ \text{V},$ $V_O = 0,$ $R_S = 50\ \Omega$	25°C	82	99		82	99	dB		
		Full range	80			80				

† Full range is -40°C to 125°C .



TLE207x-Q1, TLE207xA-Q1
EXCALIBUR LOW-NOISE HIGH-SPEED
JFET-INPUT OPERATIONAL AMPLIFIERS

SGLS226A – DECEMBER 2003 – REVISED AUGUST 2004

TLE2071-Q1 electrical characteristics at specified free-air temperature, $V_{CC\pm} = \pm 5\text{ V}$ (unless otherwise noted) (continued)

PARAMETER	TEST CONDITIONS	T_A^\dagger	TLE2071-Q1			TLE2071A-Q1			UNIT
			MIN	TYP	MAX	MIN	TYP	MAX	
I_{CC} Supply current	$V_O = 0$, No load	25°C	1.35	1.6	2.2	1.35	1.6	2.2	mA
		Full range	2.2			2.2			
I_{OS} Short-circuit output current	$V_O = 0$	$V_{ID} = 1\text{ V}$	-35			-35			mA
		$V_{ID} = -1\text{ V}$	45			45			

† Full range is -40°C to 125°C .

TLE2071-Q1 operating characteristics at specified free-air temperature, $V_{CC\pm} = \pm 5\text{ V}$

PARAMETER	TEST CONDITIONS	T_A^\dagger	TLE2071-Q1			TLE2071A-Q1			UNIT	
			MIN	TYP	MAX	MIN	TYP	MAX		
SR+ Positive slew rate	$V_{O(PP)} = \pm 2.3\text{ V}$, $A_{VD} = -1$, $R_L = 2\text{ k}\Omega$, $C_L = 100\text{ pF}$, See Figure 1	25°C	35			35			V/ μs	
		Full range	20			20				
SR- Negative slew rate		25°C	38			38			V/ μs	
		Full range	20			20				
t_s Settling time	$A_{VD} = -1$, 2-V step, $R_L = 1\text{ k}\Omega$, $C_L = 100\text{ pF}$	To 10 mV	0.25			0.25			μs	
		To 1 mV	0.4			0.4				
V_n Equivalent input noise voltage	$R_S = 20\ \Omega$, See Figure 3	f = 10 Hz	28	55		28	55	nV/ $\sqrt{\text{Hz}}$		
		f = 10 kHz	11.6	17		11.6	17			
$V_{N(PP)}$ Peak-to-peak equivalent input noise voltage		f = 10 Hz to 10 kHz	6			6			μV	
		f = 0.1 Hz to 10 Hz	0.6			0.6				
I_n Equivalent input noise current	$V_{IC} = 0$, f = 10 kHz	25°C	2.8			2.8			fA/ $\sqrt{\text{Hz}}$	
THD + N Total harmonic distortion plus noise	$V_{O(PP)} = 5\text{ V}$, f = 1 kHz, $R_S = 25\ \Omega$	$A_{VD} = 10$, $R_L = 2\text{ k}\Omega$,	25°C	0.013%			0.013%			
B_1 Unity-gain bandwidth	$V_I = 10\text{ mV}$, $C_L = 25\text{ pF}$,	$R_L = 2\text{ k}\Omega$, See Figure 2	25°C	9.4			9.4			MHz
B_{OM} Maximum output-swing bandwidth	$V_{O(PP)} = 4\text{ V}$, $R_L = 2\text{ k}\Omega$,	$A_{VD} = -1$, $C_L = 25\text{ pF}$	25°C	2.8			2.8			MHz
ϕ_m Phase margin at unity gain	$V_I = 10\text{ mV}$, $C_L = 25\text{ pF}$,	$R_L = 2\text{ k}\Omega$, See Figure 2	25°C	56			56			

† Full range is -40°C to 125°C .

TLE207x-Q1, TLE207xA-Q1 EXCALIBUR LOW-NOISE HIGH-SPEED JFET-INPUT OPERATIONAL AMPLIFIERS

SGLS226A – DECEMBER 2003 – REVISED AUGUST 2004

TLE2071-Q1 electrical characteristics at specified free-air temperature, $V_{CC\pm} = \pm 15$ V (unless otherwise noted)

PARAMETER	TEST CONDITIONS	T_A †	TLE2071-Q1			TLE2071A-Q1			UNIT
			MIN	TYP	MAX	MIN	TYP	MAX	
V_{IO} Input offset voltage	$V_{IC} = 0, V_O = 0, R_S = 50 \Omega$	25°C	0.49		4	0.47		2	mV
		Full range			9			7	
α_{VIO} Temperature coefficient of input offset voltage		Full range	3.2			3.2		20	$\mu V/^\circ C$
I_{IO} Input offset current	$V_{IC} = 0, V_O = 0, \text{See Figure 4}$	25°C	6	100		6	100		pA
		Full range			20			20	nA
I_{IB} Input bias current		25°C	20	175		20	175		pA
		Full range			60			60	nA
V_{ICR} Common-mode input voltage range	$R_S = 50 \Omega$	25°C	15 to -11	15 to -11.9		15 to -11	15 to -11.9		V
		Full range	15 to -10.9			15 to -10.9			
V_{OM+} Maximum positive peak output voltage swing	$I_O = -200 \mu A$	25°C	13.8	14.1		13.8	14.1		V
		Full range	13.6			13.6			
	$I_O = -2 \text{ mA}$	25°C	13.5	13.9		13.5	13.9		
		Full range	13.3			13.3			
	$I_O = -20 \text{ mA}$	25°C	11.5	12.3		11.5	12.3		
		Full range	11.4			11.4			
V_{OM-} Maximum negative peak output voltage swing	$I_O = 200 \mu A$	25°C	-13.8	-14.2		-13.8	-14.2		V
		Full range	-13.6			-13.6			
	$I_O = 2 \text{ mA}$	25°C	-13.5	-14		-13.5	-14		
		Full range	-13.3			-13.3			
	$I_O = 20 \text{ mA}$	25°C	-11.5	-12.4		-11.5	-12.4		
		Full range	-11.4			-11.4			
A_{VD} Large-signal differential voltage amplification	$V_O = \pm 10 \text{ V}$	$R_L = 600 \Omega$	25°C	80	96		80	96	dB
			Full range	78			78		
		$R_L = 2 \text{ k}\Omega$	25°C	90	109		90	109	
			Full range	88			88		
		$R_L = 10 \text{ k}\Omega$	25°C	95	118		95	118	
			Full range	93			93		
r_i Input resistance	$V_{IC} = 0$	25°C	10^{12}			10^{12}		Ω	
c_i Input capacitance	$V_{IC} = 0, \text{See Figure 5}$	Common mode	25°C	7.5			7.5		pF
		Differential	25°C	2.5			2.5		
z_o Open-loop output impedance	$f = 1 \text{ MHz}$	25°C	80			80		Ω	
CMRR Common-mode rejection ratio	$V_{IC} = V_{ICRmin}, V_O = 0, R_S = 50 \Omega$	25°C	80	98		80	98	dB	
		Full range	78			78			
k_{SVR} Supply-voltage rejection ratio ($\Delta V_{CC\pm}/\Delta V_{IO}$)	$V_{CC\pm} = \pm 5 \text{ V to } \pm 15 \text{ V}, V_O = 0, R_S = 50 \Omega$	25°C	82	99		82	99	dB	
		Full range	80			80			

† Full range is $-40^\circ C$ to $125^\circ C$.



TLE207x-Q1, TLE207xA-Q1
EXCALIBUR LOW-NOISE HIGH-SPEED
JFET-INPUT OPERATIONAL AMPLIFIERS

SGLS226A – DECEMBER 2003 – REVISED AUGUST 2004

TLE2071-Q1 electrical characteristics at specified free-air temperature, $V_{CC\pm} = \pm 15$ V (unless otherwise noted) (continued)

PARAMETER	TEST CONDITIONS	T_A †	TLE2071-Q1			TLE2071A-Q1			UNIT
			MIN	TYP	MAX	MIN	TYP	MAX	
I_{CC} Supply current	$V_O = 0$, No load	25°C	1.35	1.7	2.2	1.35	1.7	2.2	mA
		Full range	2.2			2.2			
I_{OS} Short-circuit output current	$V_O = 0$	25°C	$V_{ID} = 1$ V	-30	-45	-30	-45	mA	
			$V_{ID} = -1$ V	30	48	30	48		

† Full range is -40°C to 125°C .

TLE2071-Q1 operating characteristics at specified free-air temperature, $V_{CC\pm} = \pm 15$ V

PARAMETER	TEST CONDITIONS	T_A †	TLE2071-Q1			TLE2071A-Q1			UNIT
			MIN	TYP	MAX	MIN	TYP	MAX	
SR+ Positive slew rate	$V_{O(PP)} = 10$ V, $A_{VD} = -1$, $R_L = 2$ k Ω , See Figure 1	25°C	30	40		30	40	V/ μ s	
		Full range	22			22			
SR- Negative slew rate		25°C	30	45		30	45	V/ μ s	
		Full range	22			22			
t_s Settling time	$A_{VD} = -1$, 10-V step, $R_L = 1$ k Ω , $C_L = 100$ pF	25°C	To 10 mV	0.4		0.4		μ s	
			To 1 mV	1.5		1.5			
V_n Equivalent input noise voltage	$R_S = 20$ Ω , See Figure 3	25°C	f = 10 Hz	28	55	28	55	nV/ $\sqrt{\text{Hz}}$	
			f = 10 kHz	11.6	17	11.6	17		
$V_{N(PP)}$ Peak-to-peak equivalent input noise voltage		25°C	f = 10 Hz to 10 kHz	6		6		μ V	
			f = 0.1 Hz to 10 Hz	0.6		0.6			
I_n Equivalent input noise current	$V_{IC} = 0$, f = 10 kHz	25°C	2.8		2.8		fA/ $\sqrt{\text{Hz}}$		
THD + N Total harmonic distortion plus noise	$V_{O(PP)} = 20$ V, $A_{VD} = 10$, f = 1 kHz, $R_L = 2$ k Ω , $R_S = 25$ Ω	25°C	0.008%		0.008%				
B_1 Unity-gain bandwidth	$V_I = 10$ mV, $R_L = 2$ k Ω , $C_L = 25$ pF, See Figure 2	25°C	8	10	8	10	MHz		
B_{OM} Maximum output-swing bandwidth	$V_{O(PP)} = 20$ V, $A_{VD} = -1$, $R_L = 2$ k Ω , $C_L = 25$ pF	25°C	478	637	478	637	kHz		
ϕ_m Phase margin at unity gain	$V_I = 10$ mV, $R_L = 2$ k Ω , $C_L = 25$ pF, See Figure 2	25°C	57		57				

† Full range is -40°C to 125°C .

TLE207x-Q1, TLE207xA-Q1 EXCALIBUR LOW-NOISE HIGH-SPEED JFET-INPUT OPERATIONAL AMPLIFIERS

SGLS226A – DECEMBER 2003 – REVISED AUGUST 2004

TLE2072-Q1 electrical characteristics at specified free-air temperature, $V_{CC\pm} = \pm 5$ V (unless otherwise noted)

PARAMETER	TEST CONDITIONS	T_A †	TLE2072-Q1			TLE2072A-Q1			UNIT	
			MIN	TYP	MAX	MIN	TYP	MAX		
V_{IO} Input offset voltage	$V_{IC} = 0,$ $R_S = 50 \Omega,$ $V_O = 0,$	25°C	0.9	6		0.65	3.5	mV		
		Full range			10		8			
α_{VIO} Temperature coefficient of input offset voltage		Full range	2.3			2.3	20	$\mu V/^\circ C$		
I_{IO} Input offset current	$V_{IC} = 0,$ $V_O = 0,$ See Figure 4	25°C	5	100		5	100	pA		
		Full range			20		20	nA		
I_{IB} Input bias current		25°C	15	175		15	175	pA		
		Full range			60		60	nA		
V_{ICR} Common-mode input voltage range	$R_S = 50 \Omega$	25°C	5 to -1	5 to -1.9		5 to -1	5 to -1.9	V		
		Full range	5 to -0.8			5 to -0.8				
V_{OM+} Maximum positive peak output voltage swing	$I_O = -200 \mu A$	25°C	3.8	4.1		3.8	4.1	V		
		Full range	3.6			3.6				
	$I_O = -2$ mA	25°C	3.5	3.9		3.5	3.9			
		Full range	3.3			3.3				
$I_O = -20$ mA	25°C	1.5	2.3		1.5	2.3				
	Full range	1.4			1.4					
V_{OM-} Maximum negative peak output voltage swing	$I_O = 200 \mu A$	25°C	-3.8	-4.2		-3.8	-4.2	V		
		Full range	-3.6			-3.6				
	$I_O = 2$ mA	25°C	-3.5	-4.1		-3.5	-4.1			
		Full range	-3.3			-3.3				
$I_O = 20$ mA	25°C	-1.5	-2.4		-1.5	-2.4				
	Full range	-1.4			-1.4					
A_{VD} Large-signal differential voltage amplification	$V_O = \pm 2.3$ V	$R_L = 600 \Omega$	25°C	80	91		80	91	dB	
			Full range	78			78			
		$R_L = 2$ k Ω	25°C	90	100		90	100		
			Full range	88			88			
		$R_L = 10$ k Ω	25°C	95	106		95	106		
			Full range	93			93			
r_i Input resistance	$V_{IC} = 0$	25°C	10^{12}			10^{12}			Ω	
c_i Input capacitance	$V_{IC} = 0,$ See Figure 5	Common mode	25°C	11			11			pF
		Differential	25°C	2.5			2.5			
z_o Open-loop output impedance	$f = 1$ MHz	25°C	80			80			Ω	
CMRR Common-mode rejection ratio	$V_{IC} = V_{ICRmin},$ $V_O = 0,$ $R_S = 50 \Omega$	25°C	70	89		70	89	dB		
		Full range	68			68				

† Full range is $-40^\circ C$ to $125^\circ C$.



TLE207x-Q1, TLE207xA-Q1
EXCALIBUR LOW-NOISE HIGH-SPEED
JFET-INPUT OPERATIONAL AMPLIFIERS

SGLS226A – DECEMBER 2003 – REVISED AUGUST 2004

TLE2072-Q1 electrical characteristics at specified free-air temperature, $V_{CC\pm} = \pm 5$ V (unless otherwise noted) (continued)

PARAMETER	TEST CONDITIONS	T_A †	TLE2072-Q1			TLE2072A-Q1			UNIT
			MIN	TYP	MAX	MIN	TYP	MAX	
k_{SVR}	Supply-voltage rejection ratio ($\Delta V_{CC\pm} / \Delta V_{IO}$)	$V_{CC\pm} = \pm 5$ V to ± 15 V, $V_O = 0$, $R_S = 50 \Omega$	Full range			80			dB
I_{CC}	Supply current (both channels)	$V_O = 0$, No load	25°C			2.7 2.9 3.6			mA
			Full range			3.6			
a_x	Crosstalk attenuation	$V_{IC} = 0$, $R_L = 2$ k Ω	25°C			120			dB
I_{OS}	Short-circuit output current	$V_O = 0$	$V_{ID} = 1$ V			-35			mA
			$V_{ID} = -1$ V			45			

† Full range is -40°C to 125°C .

TLE2072-Q1 operating characteristics at specified free-air temperature, $V_{CC\pm} = \pm 5$ V

PARAMETER	TEST CONDITIONS	T_A †	TLE2072-Q1			TLE2072A-Q1			UNIT
			MIN	TYP	MAX	MIN	TYP	MAX	
$SR+$	Positive slew rate	$V_{O(PP)} = \pm 2.3$ V, $A_{VD} = -1$, $R_L = 2$ k Ω , $C_L = 100$ pF, See Figure 1	25°C			35			V/ μ s
			Full range			18			
$SR-$	Negative slew rate	$V_{O(PP)} = \pm 2.3$ V, $A_{VD} = -1$, $R_L = 2$ k Ω , $C_L = 100$ pF, See Figure 1	25°C			38			V/ μ s
			Full range			18			
t_s	Settling time	$A_{VD} = -1$, 2-V step, $R_L = 1$ k Ω , $C_L = 100$ pF	To 10 mV			0.25			μ s
			To 1 mV			0.4			
V_n	Equivalent input noise voltage	$R_S = 20 \Omega$, See Figure 3	f = 10 Hz			28 55			nV/ $\sqrt{\text{Hz}}$
			f = 10 kHz			11.6 17			
$V_{N(PP)}$	Peak-to-peak equivalent input noise voltage	$R_S = 20 \Omega$, See Figure 3	f = 10 Hz to 10 kHz			6			μ V
			f = 0.1 Hz to 10 Hz			0.6			
I_n	Equivalent input noise current	$V_{IC} = 0$, f = 10 kHz	25°C			2.8			fA/ $\sqrt{\text{Hz}}$
THD + N	Total harmonic distortion plus noise	$V_{O(PP)} = 5$ V, f = 1 kHz, $R_S = 25 \Omega$	25°C			0.013%			
B_1	Unity-gain bandwidth	$V_I = 10$ mV, $C_L = 25$ pF, $R_L = 2$ k Ω , See Figure 2	25°C			9.4			MHz
B_{OM}	Maximum output-swing bandwidth	$V_{O(PP)} = 4$ V, $R_L = 2$ k Ω , $A_{VD} = -1$, $C_L = 25$ pF	25°C			2.8			MHz
ϕ_m	Phase margin at unity gain	$V_I = 10$ mV, $R_L = 2$ k Ω , $C_L = 25$ pF, See Figure 2	25°C			56			

† Full range is -40°C to 125°C .



TLE207x-Q1, TLE207xA-Q1 EXCALIBUR LOW-NOISE HIGH-SPEED JFET-INPUT OPERATIONAL AMPLIFIERS

SGLS226A – DECEMBER 2003 – REVISED AUGUST 2004

TLE2072-Q1 electrical characteristics at specified free-air temperature, $V_{CC\pm} = \pm 15$ V (unless otherwise noted)

PARAMETER	TEST CONDITIONS	T _A †	TLE2072-Q1			TLE2072A-Q1			UNIT
			MIN	TYP	MAX	MIN	TYP	MAX	
V _{IO}	Input offset voltage	V _{IC} = 0, V _O = 0, R _S = 50 Ω	25°C	1.1	6	0.7	3.5	mV	
			Full range	10			8		
α _{VIO}	Temperature coefficient of input offset voltage		Full range	2.4		2.4 20		μV/°C	
I _{IO}	Input offset current	V _{IC} = 0, V _O = 0, See Figure 4	25°C	6	100	6	100	pA	
			Full range	20			20		
I _{IB}	Input bias current		25°C	20	175	20	175	pA	
			Full range	60			60		
V _{ICR}	Common-mode input voltage range	R _S = 50 Ω	25°C	15 to -11	15 to -11.9	15 to -11	15 to -11.9	V	
			Full range	15 to -10.8		15 to -10.8			
V _{OM+}	Maximum positive peak output voltage swing	I _O = -200 μA	25°C	13.8	14.1	13.8	14.1	V	
			Full range	13.6			13.6		
			25°C	13.5	13.9	13.5	13.9		
			Full range	13.3			13.3		
V _{OM-}	Maximum negative peak output voltage swing	I _O = -20 mA	25°C	11.5	12.3	11.5	12.3	V	
			Full range	11.4			11.4		
			25°C	-13.8	-14.2	-13.8	-14.2		
			Full range	-13.6			-13.6		
V _{OM-}	Maximum negative peak output voltage swing	I _O = 2 mA	25°C	-13.5	-14	-13.5	-14	V	
			Full range	-13.3			-13.3		
			25°C	-11.5	-12.4	-11.5	-12.4		
			Full range	-11.4			-11.4		
A _{VD}	Large-signal differential voltage amplification	V _O = ± 10 V	R _L = 600 Ω	25°C	80	96	80	96	dB
				Full range	78			78	
			R _L = 2 kΩ	25°C	90	109	90	109	
				Full range	89			89	
			R _L = 10 kΩ	25°C	95	118	95	118	
				Full range	93			93	
r _i	Input resistance	V _{IC} = 0	25°C	10 ¹²		10 ¹²		Ω	
c _i	Input capacitance	V _{IC} = 0, See Figure 5	Common mode	25°C	7.5		7.5		pF
			Differential	25°C	2.5		2.5		
z _o	Open-loop output impedance	f = 1 MHz	25°C	80		80		Ω	
CMRR	Common-mode rejection ratio	V _{IC} = V _{ICRmin} , V _O = 0, R _S = 50 Ω	25°C	80	98	80	98	dB	
			Full range	78			78		
k _{SVR}	Supply-voltage rejection ratio (ΔV _{CC±} /ΔV _{IO})	V _{CC±} = ± 5 V to ± 15 V, V _O = 0, R _S = 50 Ω	25°C	82	99	82	99	dB	
			Full range	80			80		

† Full range is -40°C to 125°C.



TLE207x-Q1, TLE207xA-Q1
EXCALIBUR LOW-NOISE HIGH-SPEED
JFET-INPUT OPERATIONAL AMPLIFIERS

SGLS226A – DECEMBER 2003 – REVISED AUGUST 2004

TLE2072-Q1 electrical characteristics at specified free-air temperature, $V_{CC\pm} = \pm 15$ V (unless otherwise noted) (continued)

PARAMETER	TEST CONDITIONS	T_A †	TLE2072-Q1			TLE2072A-Q1			UNIT	
			MIN	TYP	MAX	MIN	TYP	MAX		
I_{CC}	Supply current (both channels)	$V_O = 0$, No load	25°C	2.7	3.1	3.6	2.7	3.1	3.6	mA
			Full range	3.6			3.6			
a_x	Crosstalk attenuation	$V_{IC} = 0$, $R_L = 2$ k Ω	25°C	120			120			dB
I_{OS}	Short-circuit output current	$V_O = 0$	25°C	$V_{ID} = 1$ V	-30	-45	-30	-45	mA	
				$V_{ID} = -1$ V	30	48	30	48		

† Full range is -40°C to 125°C.

TLE2072-Q1 operating characteristics at specified free-air temperature, $V_{CC\pm} = \pm 15$ V

PARAMETER	TEST CONDITIONS	T_A †	TLE2072-Q1			TLE2072A-Q1			UNIT	
			MIN	TYP	MAX	MIN	TYP	MAX		
SR+	Positive slew rate	$V_{O(PP)} = 10$ V, $R_L = 2$ k Ω , $C_L = 100$ pF, See Figure 1	25°C	28	40	28	40	V/ μ s		
			Full range	20			20			
SR-	Negative slew rate	$V_{O(PP)} = 10$ V, $R_L = 2$ k Ω , $C_L = 100$ pF, See Figure 1	25°C	30	45	30	45	V/ μ s		
			Full range	20			20			
t_s	Settling time	$A_{VD} = -1$, 10-V step, $R_L = 1$ k Ω , $C_L = 100$ pF	To 10 mV	0.4			0.4			μ s
			To 1 mV	1.5			1.5			
V_n	Equivalent input noise voltage	$R_S = 20$ Ω , See Figure 3	f = 10 Hz	28	55	28	55	nV/ \sqrt{Hz}		
			f = 10 kHz	11.6	17	11.6	17			
$V_{N(PP)}$	Peak-to-peak equivalent input noise voltage	$R_S = 20$ Ω , See Figure 3	f = 10 Hz to 10 kHz	6			6			μ V
			f = 0.1 Hz to 10 Hz	0.6			0.6			
I_n	Equivalent input noise current	$V_{IC} = 0$, f = 10 kHz	25°C	2.8			2.8			fA/ \sqrt{Hz}
THD + N	Total harmonic distortion plus noise	$V_{O(PP)} = 20$ V, f = 1 kHz, $R_S = 25$ Ω , $A_{VD} = 10$, $R_L = 2$ k Ω	25°C	0.008%			0.008%			
B_1	Unity-gain bandwidth	$V_I = 10$ mV, $R_L = 2$ k Ω , $C_L = 25$ pF, See Figure 2	25°C	8	10	8	10	MHz		
B_{OM}	Maximum output-swing bandwidth	$V_{O(PP)} = 20$ V, $R_L = 2$ k Ω , $A_{VD} = -1$, $C_L = 25$ pF	25°C	478	637	478	637	kHz		
ϕ_m	Phase margin at unity gain	$V_I = 10$ mV, $R_L = 2$ k Ω , $C_L = 25$ pF, See Figure 2	25°C	57			57			

† Full range is -40°C to 125°C.

TLE207x-Q1, TLE207xA-Q1
EXCALIBUR LOW-NOISE HIGH-SPEED
JFET-INPUT OPERATIONAL AMPLIFIERS

SGLS226A – DECEMBER 2003 – REVISED AUGUST 2004

TLE2074-Q1 electrical characteristics at specified free-air temperature, $V_{CC\pm} = \pm 5$ V (unless otherwise noted)

PARAMETER	TEST CONDITIONS	T_A †	TLE2074-Q1			TLE2074A-Q1			UNIT
			MIN	TYP	MAX	MIN	TYP	MAX	
V_{IO} Input offset voltage	$V_{IC} = 0, V_O = 0, R_S = 50\Omega$	25°C	-1.6	7		-0.5	4	mV	
		Full range			11		9		
α_{VIO} Temperature coefficient of input offset voltage		Full range	10.1			10.1 30			$\mu\text{V}/^\circ\text{C}$
I_{IO} Input offset current	$V_{IC} = 0, V_O = 0, \text{See Figure 4}$	25°C	15 100			15 100			pA
		Full range				20			nA
I_{IB} Input bias current		25°C	20 175			20 175			pA
		Full range				60			nA
V_{ICR} Common-mode input voltage range	$R_S = 50\Omega$	25°C	5 to -1	5 to -1.9		5 to -1	5 to -1.9	V	
		Full range	5 to -0.8			5 to -0.8			
V_{OM+} Maximum positive peak output voltage swing	$I_O = -200\mu\text{A}$	25°C	3.8	4.1		3.8	4.1	V	
		Full range	3.6			3.6			
	$I_O = -2\text{mA}$	25°C	3.5	3.9		3.5	3.9		
		Full range	3.3			3.3			
	$I_O = -20\text{mA}$	25°C	1.5	2.3		1.5	2.3		
		Full range	1.4			1.4			
V_{OM-} Maximum negative peak output voltage swing	$I_O = 200\mu\text{A}$	25°C	-3.8	-4.2		-3.8	-4.2	V	
		Full range	-3.6			-3.6			
	$I_O = 2\text{mA}$	25°C	-3.5	-4.1		-3.5	-4.1		
		Full range	-3.3			-3.3			
	$I_O = 20\text{mA}$	25°C	-1.5	-2.4		-1.5	-2.4		
		Full range	-1.4			-1.4			
A_{VD} Large-signal differential voltage amplification	$V_O = \pm 2.3\text{V}$	$R_L = 600\Omega$	25°C	80	91		80	91	dB
			Full range	78			78		
		$R_L = 2\text{k}\Omega$	25°C	90	100		90	100	
			Full range	88			88		
		$R_L = 10\text{k}\Omega$	25°C	95	106		95	106	
			Full range	93			93		
r_i Input resistance	$V_{IC} = 0$	25°C	10^{12}			10^{12}			Ω
c_i Input capacitance	Common mode	25°C	11			11			pF
	Differential	25°C	2.5			2.5			
z_o Open-loop output impedance	$f = 1\text{MHz}$	25°C	80			80			Ω
CMRR Common-mode rejection ratio	$V_{IC} = V_{ICRmin}, V_O = 0, R_S = 50\Omega$	25°C	70	89		70	89	dB	
		Full range	68			68			
k_{SVR} Supply-voltage rejection ratio ($\Delta V_{CC\pm} / \Delta V_{IO}$)	$V_{CC\pm} = \pm 5\text{V to } \pm 15\text{V}, V_O = 0, R_S = 50\Omega$	25°C	82	99		82	99	dB	
		Full range	80			80			

† Full range is -40°C to 125°C.



TLE207x-Q1, TLE207xA-Q1
EXCALIBUR LOW-NOISE HIGH-SPEED
JFET-INPUT OPERATIONAL AMPLIFIERS

SGLS226A – DECEMBER 2003 – REVISED AUGUST 2004

TLE2074-Q1 electrical characteristics at specified free-air temperature, $V_{CC\pm} = \pm 5\text{ V}$ (unless otherwise noted) (continued)

PARAMETER	TEST CONDITIONS	T_A^\dagger	TLE2074-Q1			TLE2074A-Q1			UNIT
			MIN	TYP	MAX	MIN	TYP	MAX	
I_{CC} Supply current (four amplifiers)	$V_O = 0$, No load	25°C	5.2	6.3	7.5	5.2	6.3	7.5	mA
		Full range	7.5			7.5			
Crosstalk attenuation	$V_{IC} = 0$, $R_L = 2\text{ k}\Omega$	25°C	120			120			dB
I_{OS} Short-circuit output current	$V_O = 0$	25°C	$V_{ID} = 1\text{ V}$			-35			mA
			$V_{ID} = -1\text{ V}$			45			

† Full range is -40°C to 125°C .

TLE2074-Q1 operating characteristics at specified free-air temperature, $V_{CC\pm} = \pm 5\text{ V}$

PARAMETER	TEST CONDITIONS	T_A^\dagger	TLE2074-Q1			TLE2074A-Q1			UNIT	
			MIN	TYP	MAX	MIN	TYP	MAX		
SR+ Positive slew rate	$V_{O(PP)} = \pm 2.3\text{ V}$, $A_{VD} = -1$, $C_L = 100\text{ pF}$, $R_L = 2\text{ k}\Omega$, See Figure 1	25°C	35			35			V/ μs	
		Full range	18			18				
SR- Negative slew rate		25°C	38			38			V/ μs	
		Full range	18			18				
t_s Settling time	$A_{VD} = -1$, 2-V step, $R_L = 1\text{ k}\Omega$, $C_L = 100\text{ pF}$	25°C	To 10 mV			0.25			μs	
			To 1 mV			0.4				
V_n Equivalent input noise voltage	$R_S = 20\ \Omega$, See Figure 3	25°C	f = 10 Hz		28		55		nV/ $\sqrt{\text{Hz}}$	
			f = 10 kHz		11.6		17			
$V_{N(PP)}$ Peak-to-peak equivalent input noise voltage		f = 10 Hz to 10 kHz	25°C	6			6			μV
				f = 0.1 Hz to 10 Hz			0.6			
I_n Equivalent input noise current	$V_{IC} = 0$, f = 10 kHz	25°C	2.8			2.8			fA/ $\sqrt{\text{Hz}}$	
THD + N Total harmonic distortion plus noise	$V_{O(PP)} = 5\text{ V}$, f = 1 kHz, $R_S = 25\ \Omega$	$A_{VD} = 10$, $R_L = 2\text{ k}\Omega$	25°C	0.013%			0.013%			
B_1 Unity-gain bandwidth	$V_I = 10\text{ mV}$, $C_L = 25\text{ pF}$	$R_L = 2\text{ k}\Omega$, See Figure 2	25°C	9.4			9.4			MHz
B_{OM} Maximum output-swing bandwidth	$V_{O(PP)} = 4\text{ V}$, $R_L = 2\text{ k}\Omega$	$A_{VD} = -1$, $C_L = 25\text{ pF}$	25°C	2.8			2.8			MHz
f_m Phase margin at unity gain	$V_I = 10\text{ mV}$, $C_L = 25\text{ pF}$	$R_L = 2\text{ k}\Omega$, See Figure 2	25°C	56			56			

† Full range is -40°C to 125°C .



TLE207x-Q1, TLE207xA-Q1
EXCALIBUR LOW-NOISE HIGH-SPEED
JFET-INPUT OPERATIONAL AMPLIFIERS

SGLS226A – DECEMBER 2003 – REVISED AUGUST 2004

TLE2074-Q1 electrical characteristics at specified free-air temperature, $V_{CC\pm} = \pm 15\text{ V}$ (unless otherwise noted)

PARAMETER	TEST CONDITIONS	T_A^\dagger	TLE2074-Q1			TLE2074A-Q1			UNIT
			MIN	TYP	MAX	MIN	TYP	MAX	
V_{IO} Input offset voltage	$V_{IC} = 0, V_O = 0, R_S = 50\ \Omega$	25°C	-1.6	7		-0.5	4	mV	
		Full range			11		9		
α_{VIO} Temperature coefficient of input offset voltage		Full range	10.1			10.1 30		$\mu\text{V}/^\circ\text{C}$	
I_{IO} Input offset current	$V_{IC} = 0, V_O = 0, \text{See Figure 4}$	25°C	15	100		15	100	pA	
		Full range		20		20		nA	
I_{IB} Input bias current		25°C	25	175		25	175	pA	
		Full range		60		60		nA	
V_{ICR} Common-mode input voltage range	$R_S = 50\ \Omega$	25°C	15 to -11	15 to -11.9		15 to -11	15 to -11.9	V	
		Full range	15 to -10.8			15 to -10.8			
V_{OM+} Maximum positive peak output voltage swing	$I_O = -200\ \mu\text{A}$	25°C	13.8	14.1		13.8	14.1	V	
		Full range	13.6			13.6			
	$I_O = -2\ \text{mA}$	25°C	13.5	13.9		13.5	13.9		
		Full range	13.3			13.3			
	$I_O = -20\ \text{mA}$	25°C	11.5	12.3		11.5	12.3		
		Full range	11.4			11.4			
V_{OM-} Maximum negative peak output voltage swing	$I_O = 200\ \mu\text{A}$	25°C	-13.8	-14.2		-13.8	-14.2	V	
		Full range	-13.6			-13.6			
	$I_O = 2\ \text{mA}$	25°C	-13.5	-14		-13.5	-14		
		Full range	-13.3			-13.3			
	$I_O = 20\ \text{mA}$	25°C	-11.5	-12.4		-11.5	-12.4		
		Full range	-11.4			-11.4			
A_{VD} Large-signal differential voltage amplification	$V_O = \pm 10\ \text{V}$	$R_L = 600\ \Omega$	25°C	80	96		80	96	dB
			Full range	78			78		
		$R_L = 2\ \text{k}\Omega$	25°C	90	109		90	109	
			Full range	88			88		
		$R_L = 10\ \text{k}\Omega$	25°C	95	118		95	118	
			Full range	93			93		
r_i Input resistance	$V_{IC} = 0$	25°C	10^{12}			10^{12}		Ω	
C_i Input capacitance	Common mode	$V_{IC} = 0, \text{See Figure 5}$	25°C	7.5		7.5		pF	
	Differential		25°C	2.5		2.5			
z_o Open-loop output impedance	$f = 1\ \text{MHz}$	25°C	80			80		Ω	
CMRR Common-mode rejection ratio	$V_{IC} = V_{ICRmin}, V_O = 0, R_S = 50\ \Omega$	25°C	80	98		80	98	dB	
		Full range	78			78			
k_{SVR} Supply-voltage rejection ratio ($\Delta V_{CC\pm} / \Delta V_{IO}$)	$V_{CC\pm} = \pm 5\ \text{V to } \pm 15\ \text{V}, V_O = 0, R_S = 50\ \Omega$	25°C	82	99		82	99	dB	
		Full range	80			80			

† Full range is -40°C to 125°C .



TLE207x-Q1, TLE207xA-Q1
EXCALIBUR LOW-NOISE HIGH-SPEED
JFET-INPUT OPERATIONAL AMPLIFIERS

SGLS226A – DECEMBER 2003 – REVISED AUGUST 2004

TLE2074-Q1 electrical characteristics at specified free-air temperature, $V_{CC\pm} = \pm 15$ V (unless otherwise noted) (continued)

PARAMETER	TEST CONDITIONS	T_A^\dagger	TLE2074-Q1			TLE2074A-Q1			UNIT	
			MIN	TYP	MAX	MIN	TYP	MAX		
I_{CC}	Supply current (four amplifiers)	$V_O = 0$, No load	25°C	5.2	6.5	7.5	5.2	6.5	7.5	mA
			Full range	7.5			7.5			
	Crosstalk attenuation	$V_{IC} = 0$, $R_L = 2$ k Ω	25°C	120			120			dB
I_{OS}	Short-circuit output current	$V_O = 0$	25°C	$V_{ID} = 1$ V	-30	-45	-30	-45	mA	
				$V_{ID} = -1$ V	30	48	30	48		

† Full range is -40°C to 125°C .

TLE2074-Q1 operating characteristics at specified free-air temperature, $V_{CC\pm} = \pm 15$ V

PARAMETER	TEST CONDITIONS	T_A^\dagger	TLE2074-Q1			TLE2074A-Q1			UNIT
			MIN	TYP	MAX	MIN	TYP	MAX	
SR+	Positive slew rate	$V_{O(PP)} = 10$ V, $R_L = 2$ k Ω , See Figure 1	25°C	25	40		25	40	V/ μ s
				Full range	17			17	
SR-	Negative slew rate	$V_{O(PP)} = 10$ V, $R_L = 2$ k Ω , See Figure 1	25°C	30	45		30	45	V/ μ s
				Full range	20			20	
t_s	Settling time	$A_{VD} = -1$, 10-V step, $R_L = 1$ k Ω , $C_L = 100$ pF	25°C	To 10 mV	0.4		0.4		μ s
				To 1 mV	1.5		1.5		
V_n	Equivalent input noise voltage	$R_S = 20$ Ω , See Figure 3	25°C	f = 10 Hz	28	55	28	55	nV/ $\sqrt{\text{Hz}}$
				f = 10 kHz	11.6	17	11.6	17	
$V_{N(PP)}$	Peak-to-peak equivalent input noise voltage	$R_S = 20$ Ω , See Figure 3	25°C	f = 10 Hz to 10 kHz	6		6		μ V
				f = 0.1 Hz to 10 Hz	0.6		0.6		
I_n	Equivalent input noise current	$V_{IC} = 0$, f = 10 kHz	25°C	2.8		2.8		fA/ $\sqrt{\text{Hz}}$	
THD + N	Total harmonic distortion plus noise	$V_{O(PP)} = 20$ V, f = 1 kHz, $R_S = 25$ Ω	25°C	0.008%		0.008%			
B_1	Unity-gain bandwidth	$V_I = 10$ mV, $C_L = 25$ pF, $R_L = 2$ k Ω , See Figure 2	25°C	8	10	8	10	MHz	
B_{OM}	Maximum output-swing bandwidth	$V_{O(PP)} = 20$ V, $R_L = 2$ k Ω , $A_{VD} = -1$, $C_L = 25$ pF	25°C	478	637	478	637	kHz	
ϕ_m	Phase margin at unity gain	$V_I = 10$ mV, $C_L = 25$ pF, $R_L = 2$ k Ω , See Figure 2	25°C	57		57			

† Full range is -40°C to 125°C .



TLE207x-Q1, TLE207xA-Q1 EXCALIBUR LOW-NOISE HIGH-SPEED JFET-INPUT OPERATIONAL AMPLIFIERS

SGLS226A – DECEMBER 2003 – REVISED AUGUST 2004

PARAMETER MEASUREMENT INFORMATION

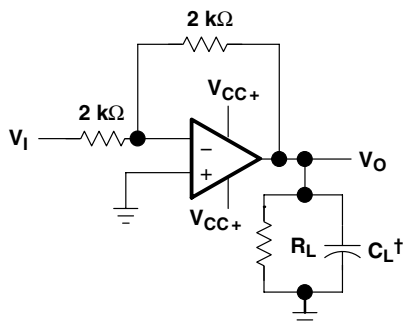

† Includes fixture capacitance

Figure 1. Slew-Rate Test Circuit

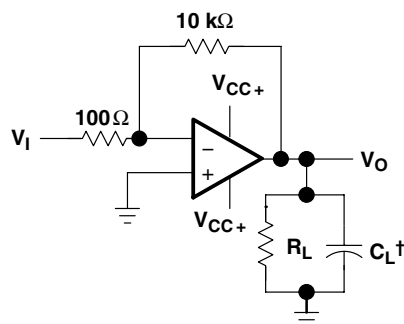

† Includes fixture capacitance

Figure 2. Unity-Gain Bandwidth and Phase-Margin Test Circuit

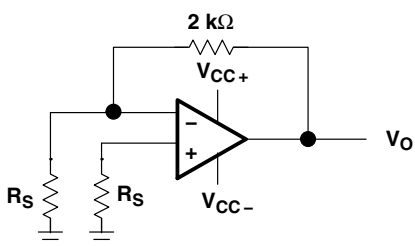

Figure 3. Noise-Voltage Test Circuit

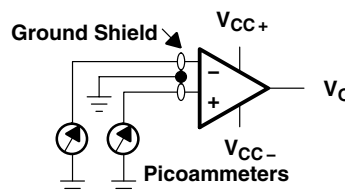

Figure 4. Input-Bias and Offset-Current Test Circuit

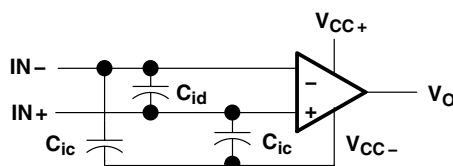

Figure 5. Internal Input Capacitance

typical values

Typical values presented in this data sheet represent the median (50% point) of device parametric performance.

input bias and offset current

At the picoampere bias current level typical of the TLE207x and TLE207xA, accurate measurement of the bias current becomes difficult. Not only does this measurement require a picoammeter but test socket leakages can easily exceed the actual device bias currents. To accurately measure these small currents, Texas Instruments uses a two-step process. The socket leakage is measured using picoammeters with bias voltages applied but with no device in the socket. The device is then inserted in the socket and a second test is performed that measures both the socket leakage and the device input bias current. The two measurements are then subtracted algebraically to determine the bias current of the device.

TYPICAL CHARACTERISTICS

Table of Graphs

		FIGURE	
V_{IO}	Input offset voltage	Distribution	6, 7, 8
α_{VIO}	Temperature coefficient of input offset voltage	Distribution	9, 10, 11
I_{IO}	Input offset current	vs Free-air temperature	12, 13
I_{IB}	Input bias current	vs Free-air temperature vs Total supply voltage	12, 13 14
V_{ICR}	Common-mode input voltage range	vs Free-air temperature	15
V_O	Output voltage	vs Differential input voltage	16, 17
V_{OM+}	Maximum positive peak output voltage	vs Output current	18
V_{OM-}	Maximum negative peak output voltage	vs Output current	19
V_{OM}	Maximum peak output voltage	vs Free-air temperature vs Supply voltage	20, 21 22
$V_{O(PP)}$	Maximum peak-to-peak output voltage	vs Frequency	23
V_O	Output voltage	vs Settling time	24
A_{VD}	Large-signal differential voltage amplification	vs Load resistance vs Free-air temperature	25 26, 27
A_{VD}	Small-signal differential voltage amplification	vs Frequency	28, 29
CMRR	Common-mode rejection ratio	vs Frequency vs Free-air temperature	30 31
k_{SVR}	Supply-voltage rejection ratio	vs Frequency vs Free-air temperature	32 33
I_{CC}	Supply current	vs Supply voltage vs Free-air temperature vs Differential input voltage	34, 35, 36 37, 38, 39 40 – 45
I_{OS}	Short-circuit output current	vs Supply voltage vs Elapsed time vs Free-air temperature	46 47 48
SR	Slew rate	vs Free-air temperature vs Load resistance vs Differential input voltage	49, 50 51 52
V_n	Equivalent Input noise voltage (spectral density)	vs Frequency	53
V_n	Input referred noise voltage	vs Noise bandwidth Over a 10-second time interval	54 55
	Third-octave spectral noise density	vs Frequency bands	56
THD + N	Total harmonic distortion plus noise	vs Frequency	57, 58
B_1	Unity-gain bandwidth	vs Load capacitance	59
	Gain-bandwidth product	vs Free-air temperature vs Supply voltage	60 61
	Gain margin	vs Load capacitance	62
ϕ_m	Phase margin	vs Free-air temperature vs Supply voltage vs Load capacitance	63 64 65
	Phase shift	vs Frequency	28, 29
	Noninverting large-signal pulse response	vs Time	66
	Small-signal pulse response	vs Time	67
Z_o	Closed-loop output impedance	vs Frequency	68
	Crosstalk attenuation	vs Frequency	69

TLE207x-Q1, TLE207xA-Q1
EXCALIBUR LOW-NOISE HIGH-SPEED
JFET-INPUT OPERATIONAL AMPLIFIERS

SGLS226A – DECEMBER 2003 – REVISED AUGUST 2004

TYPICAL CHARACTERISTICS

**DISTRIBUTION OF TLE2071
INPUT OFFSET VOLTAGE**

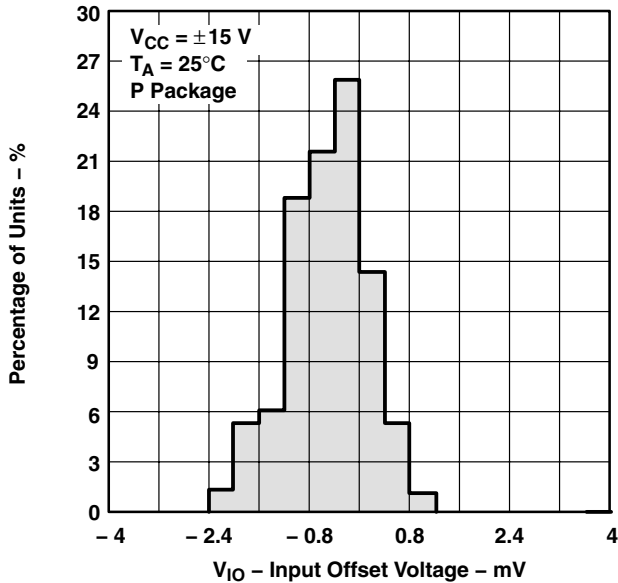

Figure 6

**DISTRIBUTION OF TLE2072
INPUT OFFSET VOLTAGE**

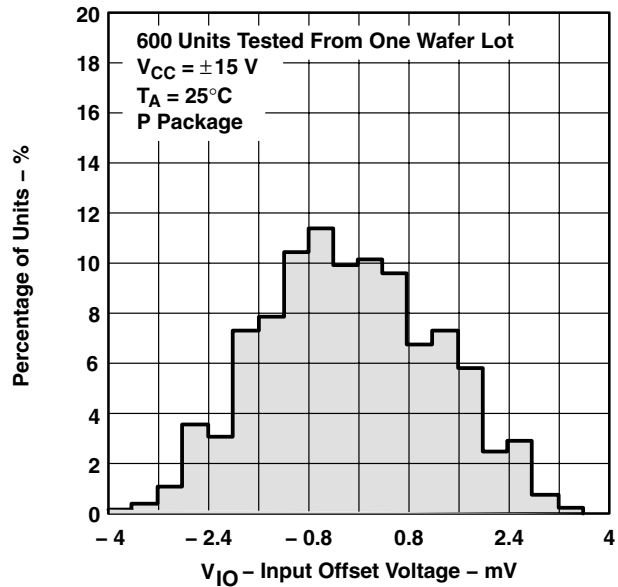

Figure 7

**DISTRIBUTION OF TLE2074
INPUT OFFSET VOLTAGE**

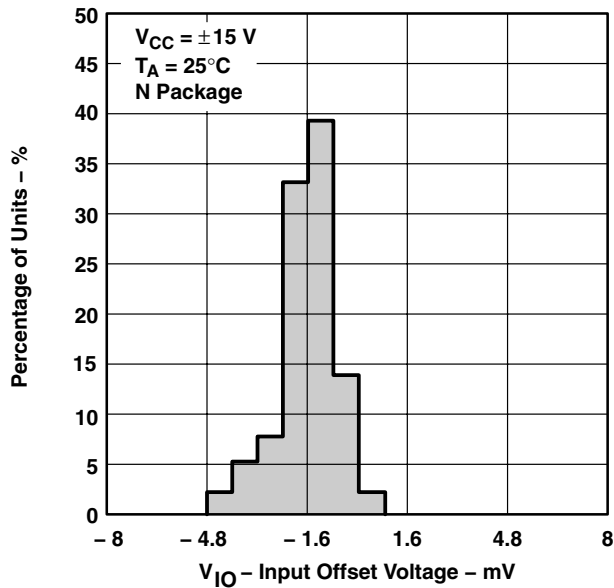

Figure 8

**DISTRIBUTION OF TLE2071 INPUT OFFSET
VOLTAGE TEMPERATURE COEFFICIENT**

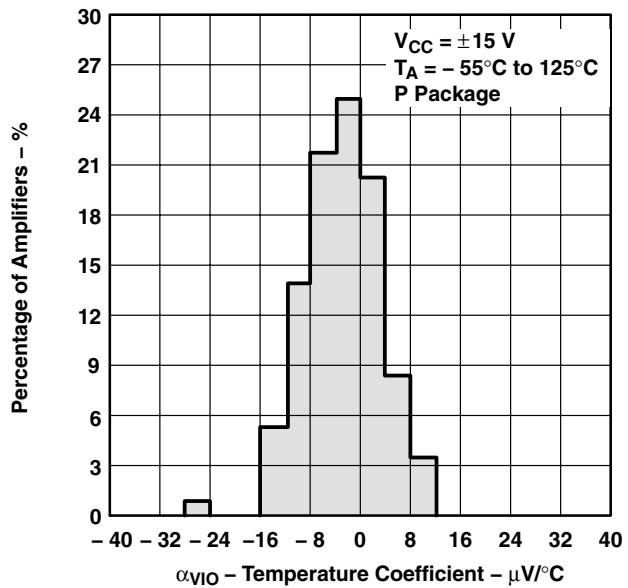

Figure 9

TYPICAL CHARACTERISTICS

**DISTRIBUTION OF TLE2072 INPUT OFFSET
 VOLTAGE TEMPERATURE COEFFICIENT**

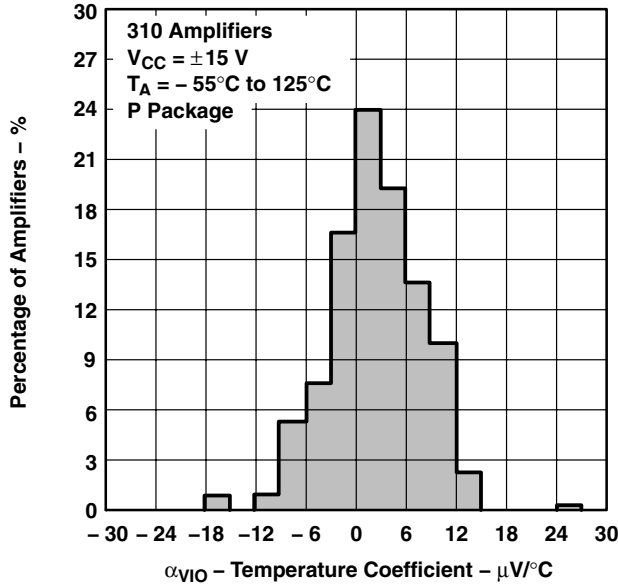

Figure 10

**DISTRIBUTION OF TLE2074 INPUT OFFSET
 VOLTAGE TEMPERATURE COEFFICIENT**

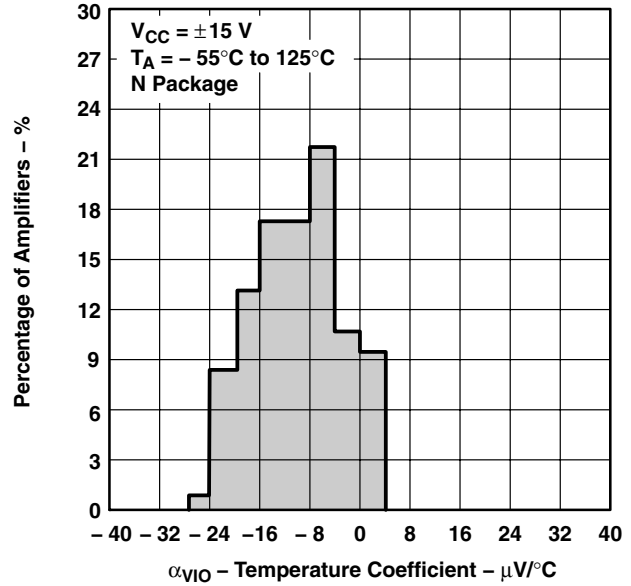

Figure 11

**INPUT BIAS CURRENT AND
 INPUT OFFSET CURRENT†
 vs
 FREE-AIR TEMPERATURE**

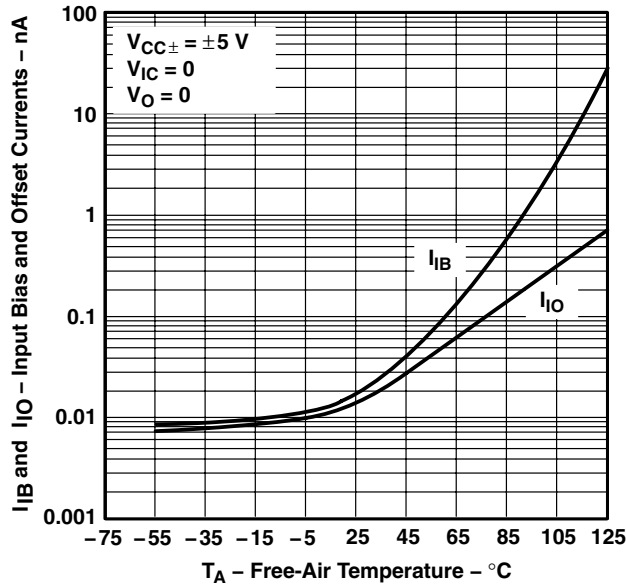

Figure 12

**INPUT BIAS CURRENT AND
 INPUT OFFSET CURRENT†
 vs
 FREE-AIR TEMPERATURE**

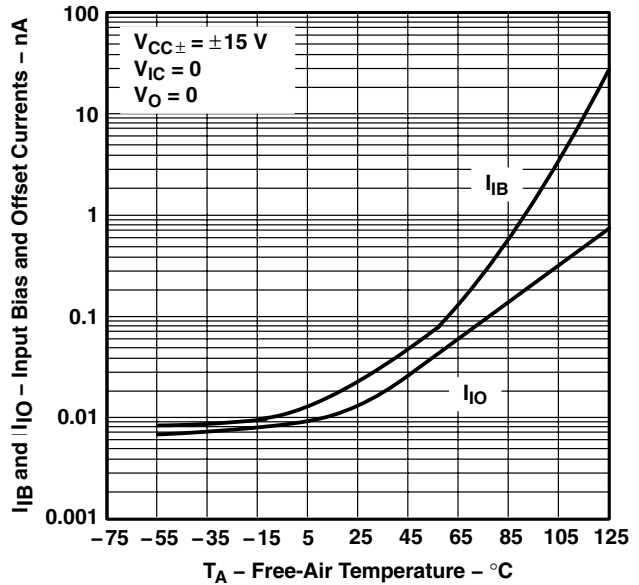

Figure 13

† Data at high and low temperatures are applicable only within the rated operating free-air temperature ranges of the various devices.

TLE207x-Q1, TLE207xA-Q1 EXCALIBUR LOW-NOISE HIGH-SPEED JFET-INPUT OPERATIONAL AMPLIFIERS

SGLS226A – DECEMBER 2003 – REVISED AUGUST 2004

TYPICAL CHARACTERISTICS

**INPUT BIAS CURRENT
vs
TOTAL SUPPLY VOLTAGE**

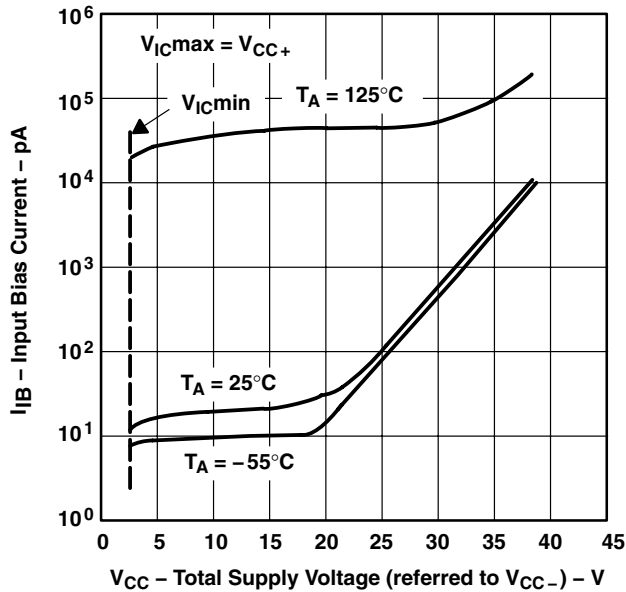

Figure 14

**COMMON-MODE INPUT VOLTAGE RANGE†
vs
FREE-AIR TEMPERATURE**

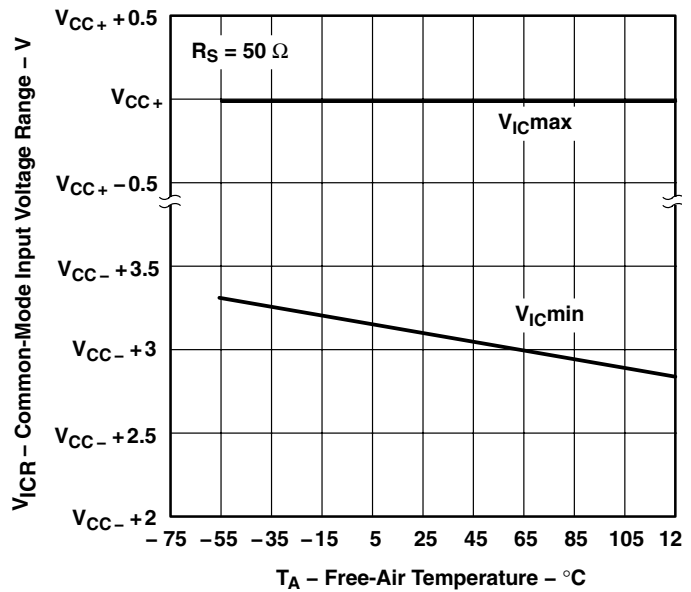

Figure 15

**OUTPUT VOLTAGE
vs
DIFFERENTIAL INPUT VOLTAGE**

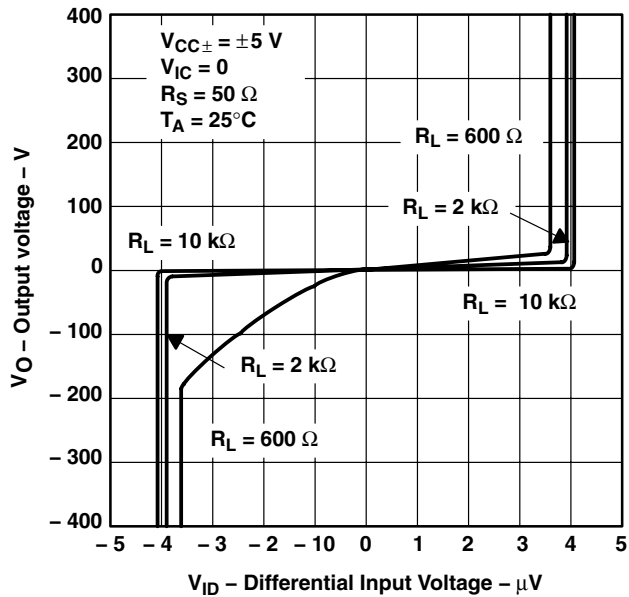

Figure 16

**OUTPUT VOLTAGE
vs
DIFFERENTIAL INPUT VOLTAGE**

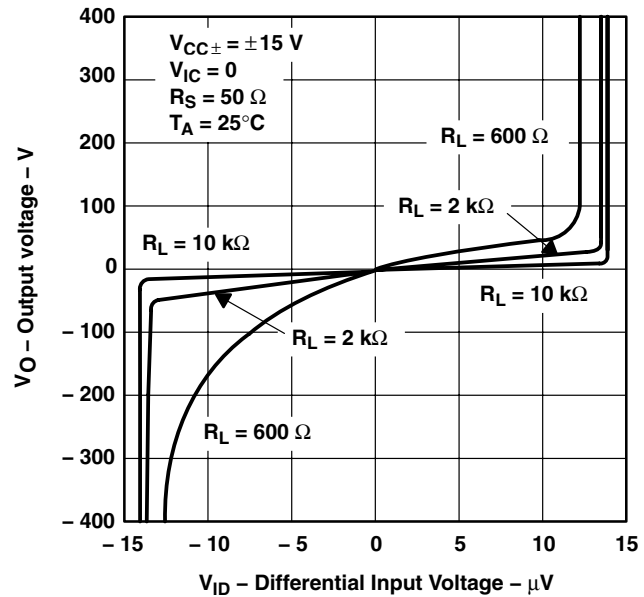

Figure 17

† Data at high and low temperatures are applicable only within the rated operating free-air temperature ranges of the various devices.

TYPICAL CHARACTERISTICS

**MAXIMUM POSITIVE PEAK OUTPUT VOLTAGE†
 vs
 OUTPUT CURRENT**

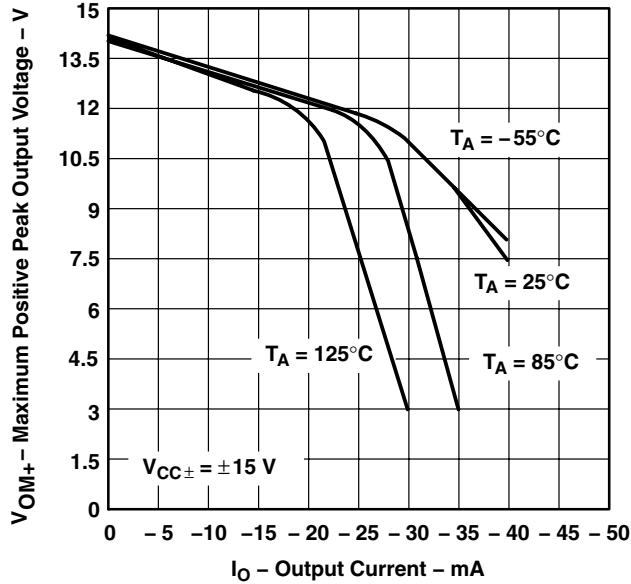

Figure 18

**MAXIMUM NEGATIVE PEAK OUTPUT VOLTAGE†
 vs
 OUTPUT CURRENT**

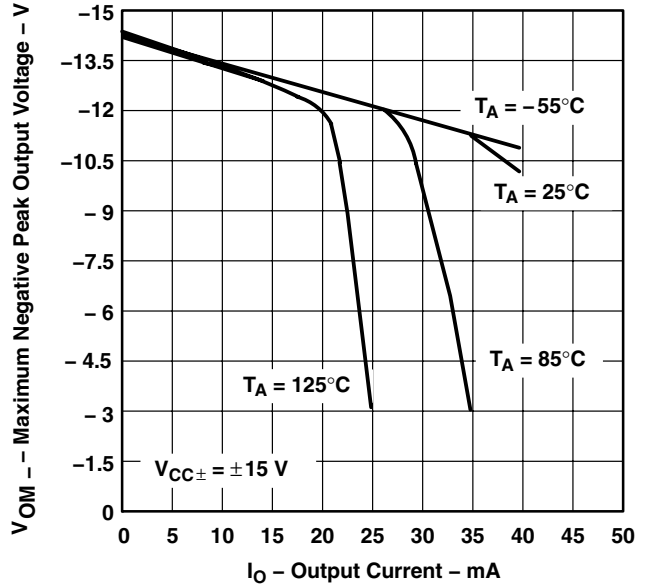

Figure 19

**MAXIMUM PEAK OUTPUT VOLTAGE†
 vs
 FREE-AIR TEMPERATURE**

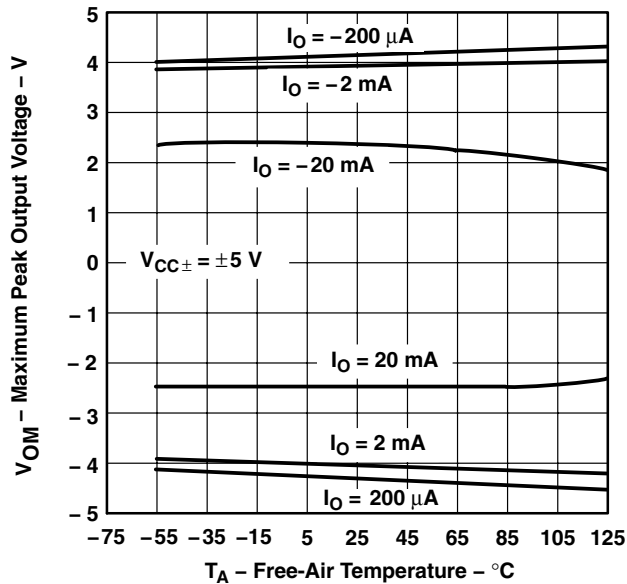

Figure 20

**MAXIMUM PEAK OUTPUT VOLTAGE†
 vs
 FREE-AIR TEMPERATURE**

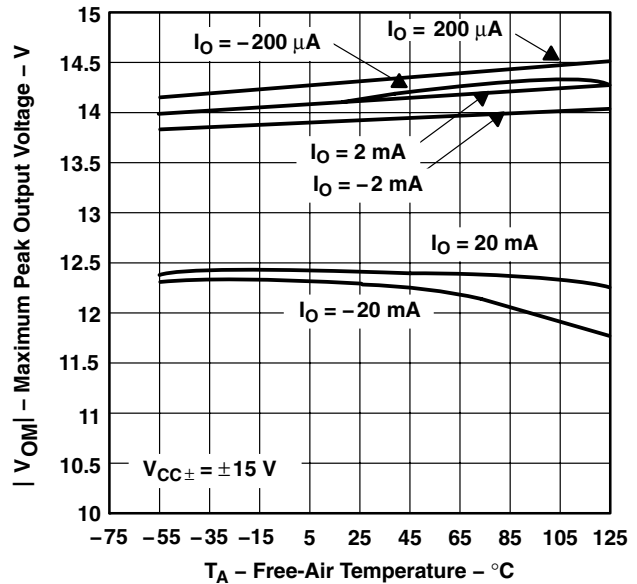

Figure 21

† Data at high and low temperatures are applicable only within the rated operating free-air temperature ranges of the various devices.

TLE207x-Q1, TLE207xA-Q1 EXCALIBUR LOW-NOISE HIGH-SPEED JFET-INPUT OPERATIONAL AMPLIFIERS

SGLS226A – DECEMBER 2003 – REVISED AUGUST 2004

TYPICAL CHARACTERISTICS

**MAXIMUM PEAK OUTPUT VOLTAGE
vs
SUPPLY VOLTAGE**

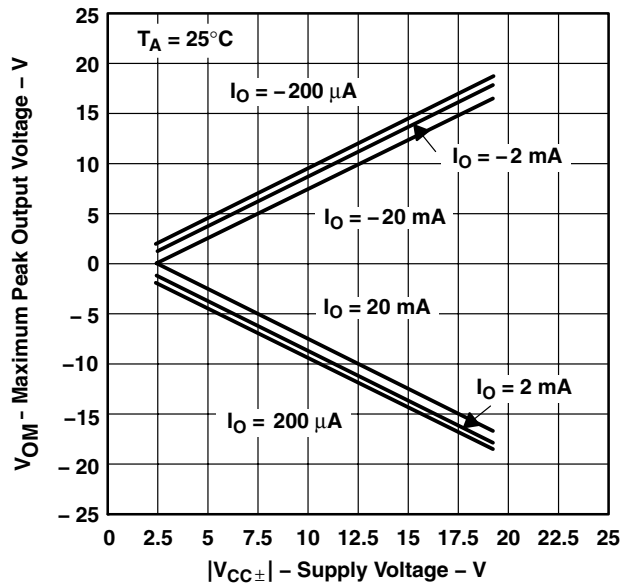

Figure 22

**MAXIMUM PEAK-TO-PEAK OUTPUT VOLTAGE†
vs
FREQUENCY**

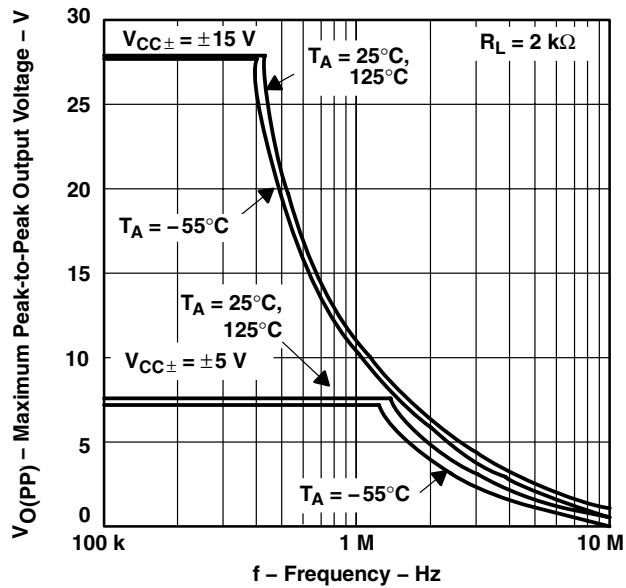

Figure 23

**OUTPUT VOLTAGE
vs
SETTLING TIME**

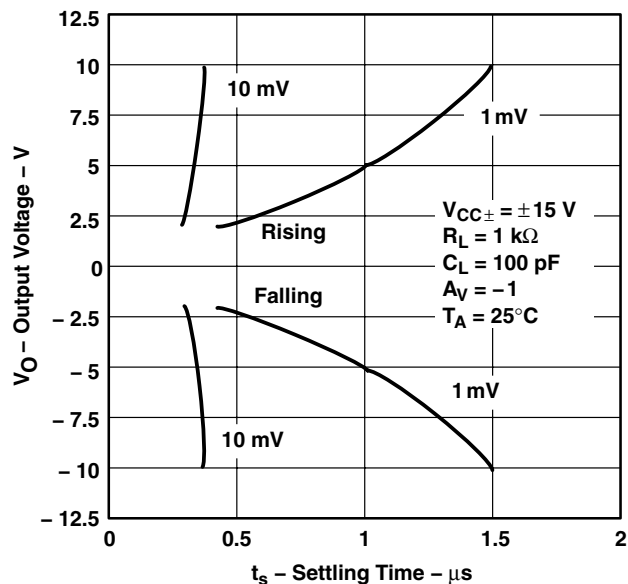

Figure 24

**LARGE-SIGNAL DIFFERENTIAL
VOLTAGE AMPLIFICATION
vs
LOAD RESISTANCE**

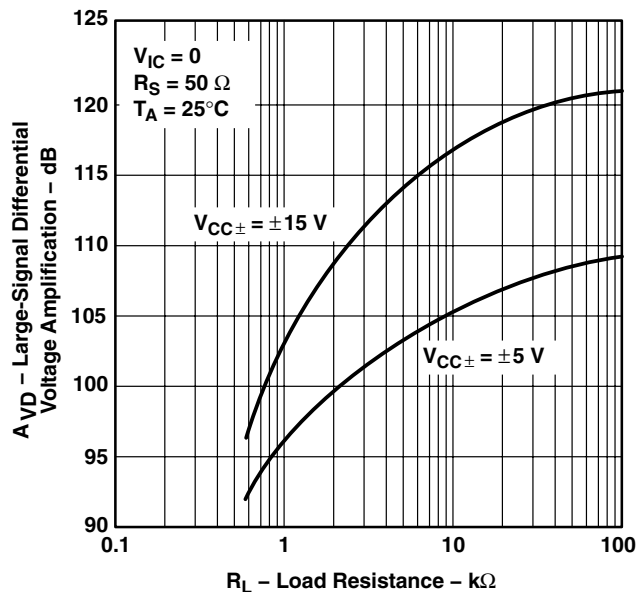

Figure 25

† Data at high and low temperatures are applicable only within the rated operating free-air temperature ranges of the various devices.

TYPICAL CHARACTERISTICS

**LARGE-SIGNAL DIFFERENTIAL
 VOLTAGE AMPLIFICATION†
 vs
 FREE-AIR TEMPERATURE**

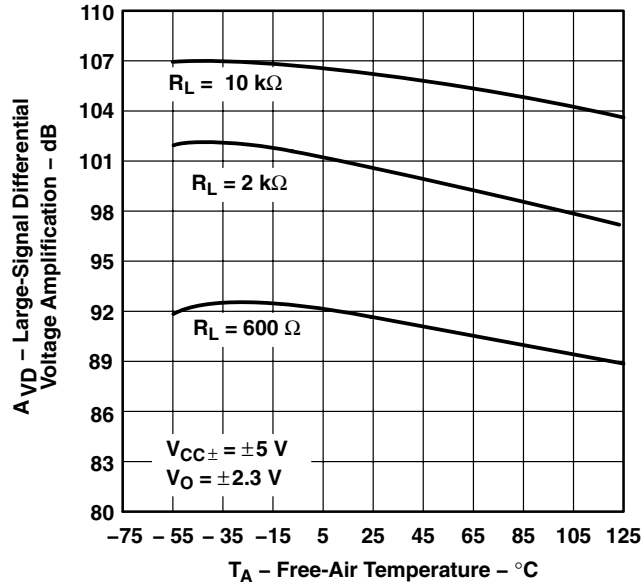

Figure 26

**LARGE-SIGNAL DIFFERENTIAL
 VOLTAGE AMPLIFICATION†
 vs
 FREE-AIR TEMPERATURE**

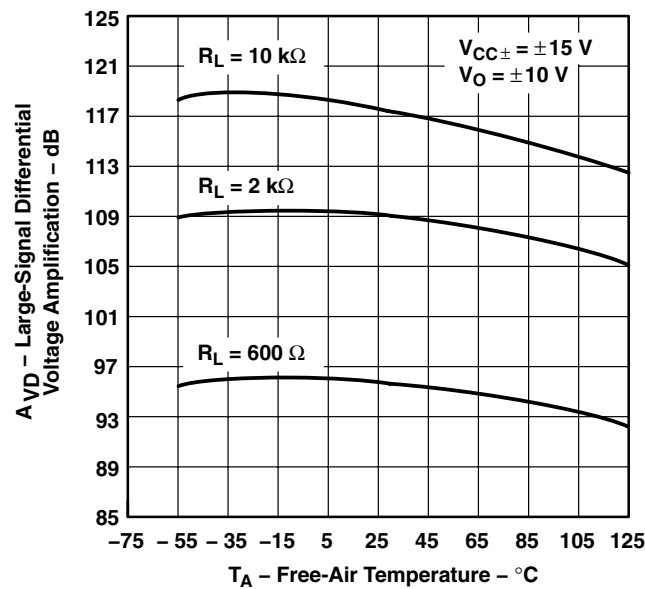

Figure 27

† Data at high and low temperatures are applicable only within the rated operating free-air temperature ranges of the various devices.

TLE207x-Q1, TLE207xA-Q1
EXCALIBUR LOW-NOISE HIGH-SPEED
JFET-INPUT OPERATIONAL AMPLIFIERS

SGLS226A – DECEMBER 2003 – REVISED AUGUST 2004

TYPICAL CHARACTERISTICS

SMALL-SIGNAL DIFFERENTIAL VOLTAGE AMPLIFICATION AND PHASE SHIFT

vs
FREQUENCY

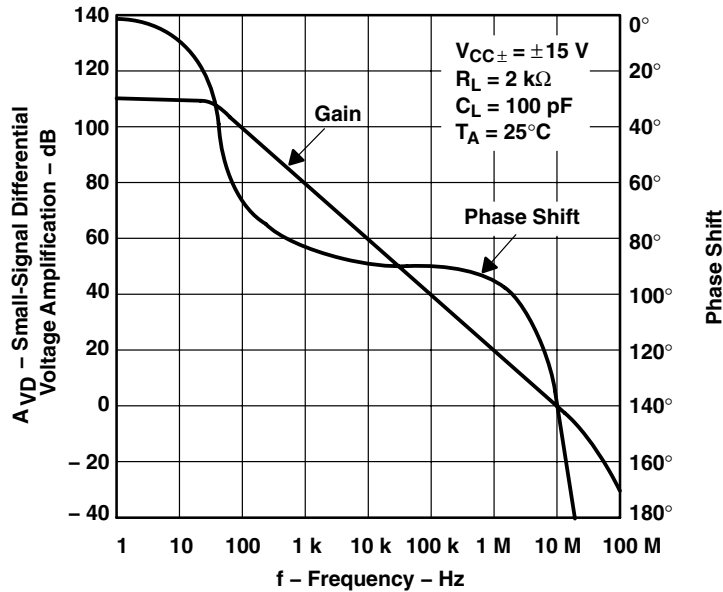

Figure 28

SMALL-SIGNAL DIFFERENTIAL VOLTAGE AMPLIFICATION AND PHASE SHIFT

vs
FREQUENCY

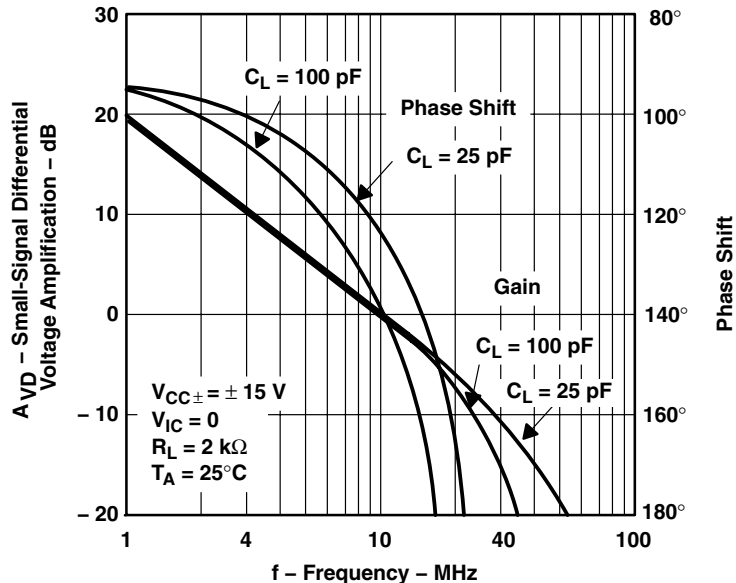

Figure 29



TYPICAL CHARACTERISTICS

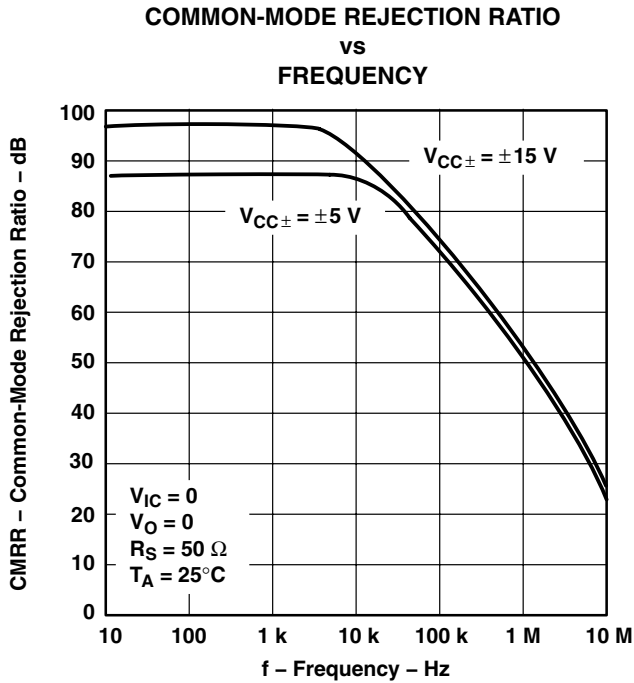

Figure 30

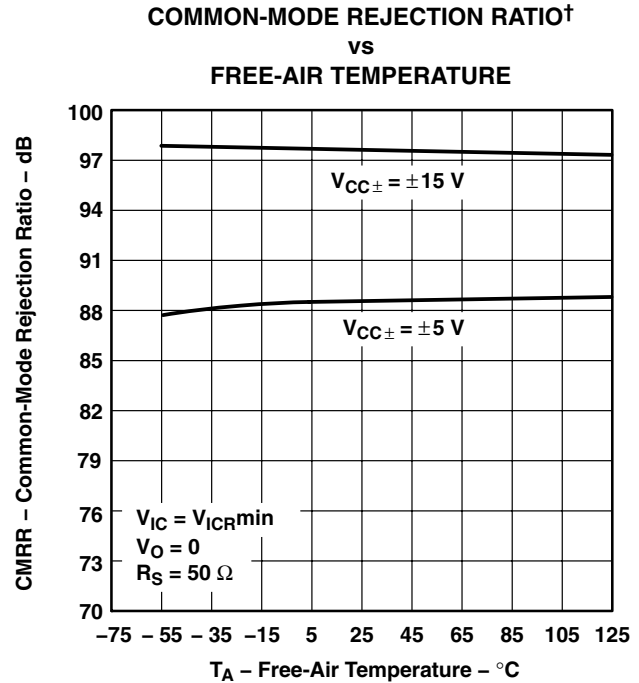

Figure 31

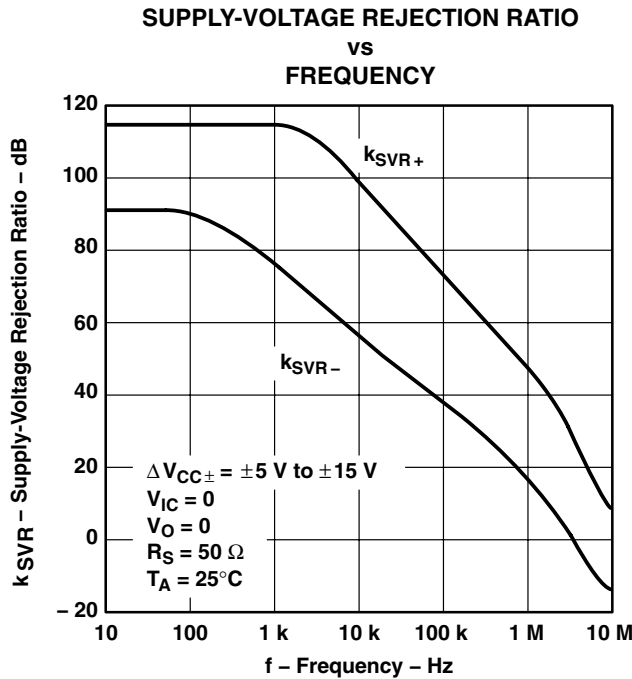

Figure 32

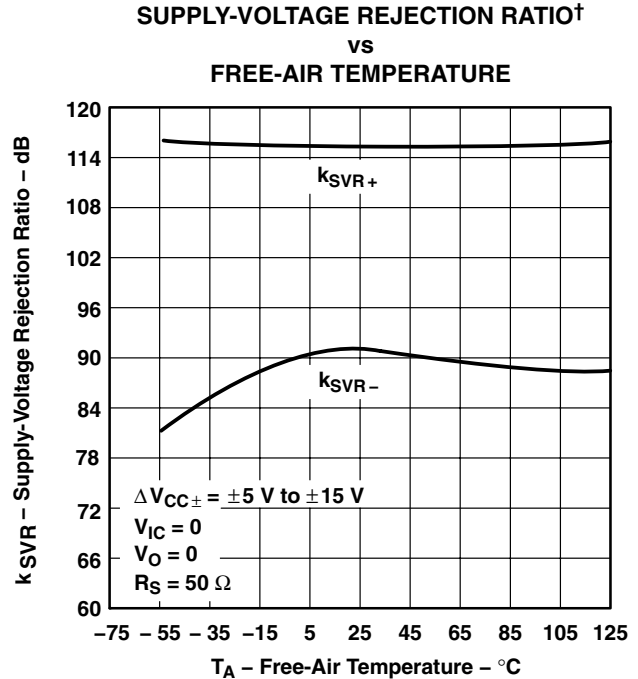

Figure 33

† Data at high and low temperatures are applicable only within the rated operating free-air temperature ranges of the various devices.

TLE207x-Q1, TLE207xA-Q1 EXCALIBUR LOW-NOISE HIGH-SPEED JFET-INPUT OPERATIONAL AMPLIFIERS

SGLS226A – DECEMBER 2003 – REVISED AUGUST 2004

TYPICAL CHARACTERISTICS

**TLE2071
SUPPLY CURRENT
vs
SUPPLY VOLTAGE**

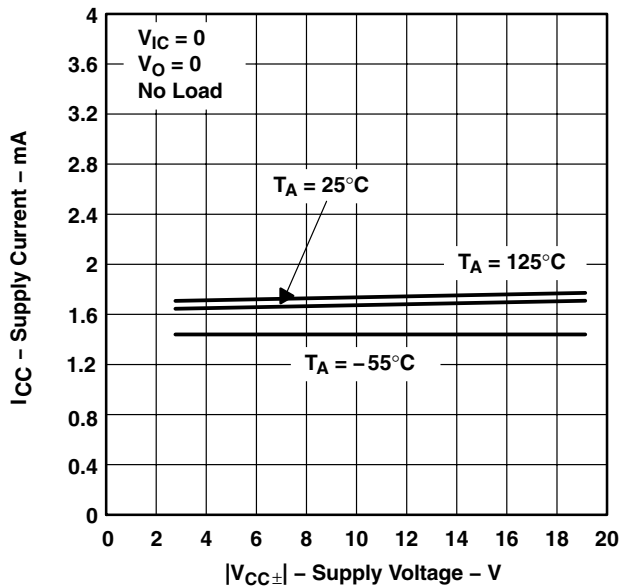

Figure 34

**TLE2072
SUPPLY CURRENT
vs
SUPPLY VOLTAGE**

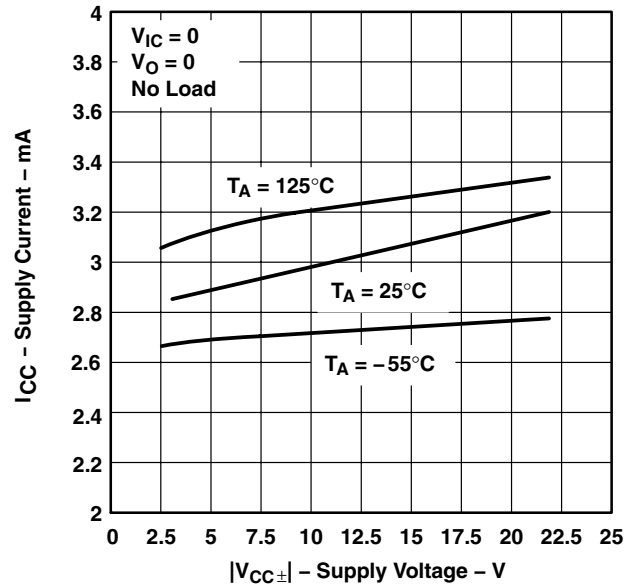

Figure 35

**TLE2074
SUPPLY CURRENT
vs
SUPPLY VOLTAGE**

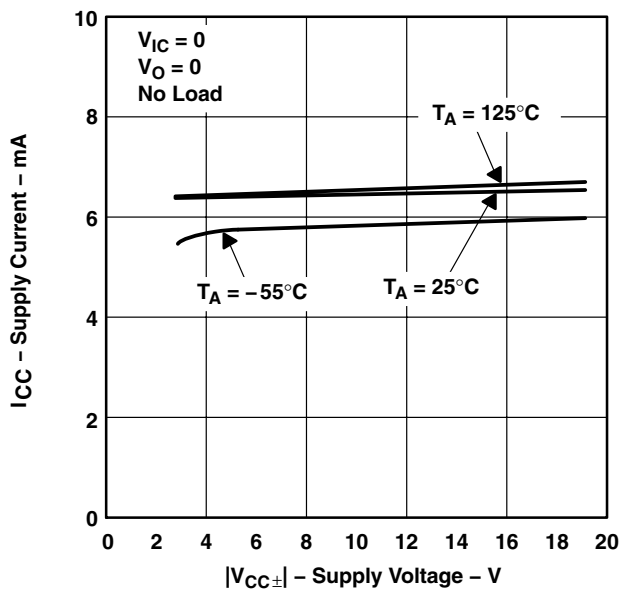

Figure 36

**TLE2071
SUPPLY CURRENT†
vs
FREE-AIR TEMPERATURE**

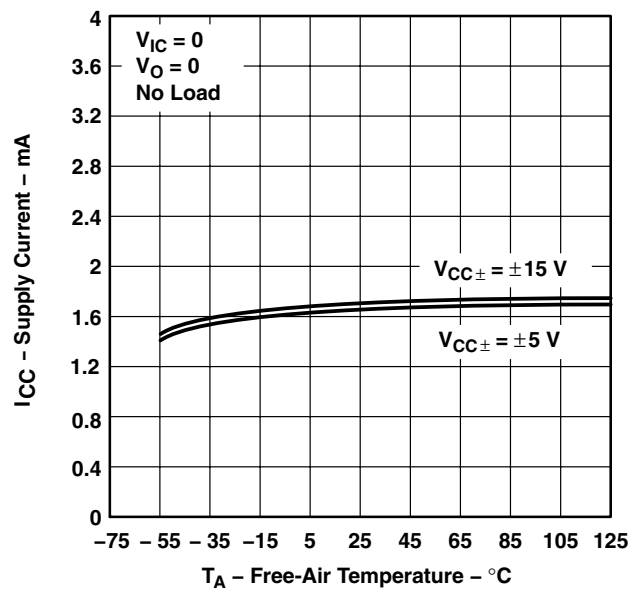

Figure 37

† Data at high and low temperatures are applicable only within the rated operating free-air temperature ranges of the various devices.

TYPICAL CHARACTERISTICS

**TLE2072
 SUPPLY CURRENT†
 vs
 FREE-AIR TEMPERATURE**

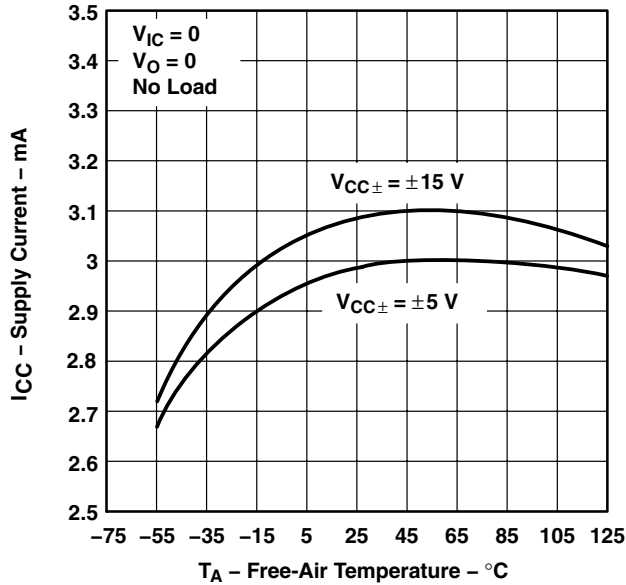

Figure 38

**TLE2074
 SUPPLY CURRENT†
 vs
 FREE-AIR TEMPERATURE**

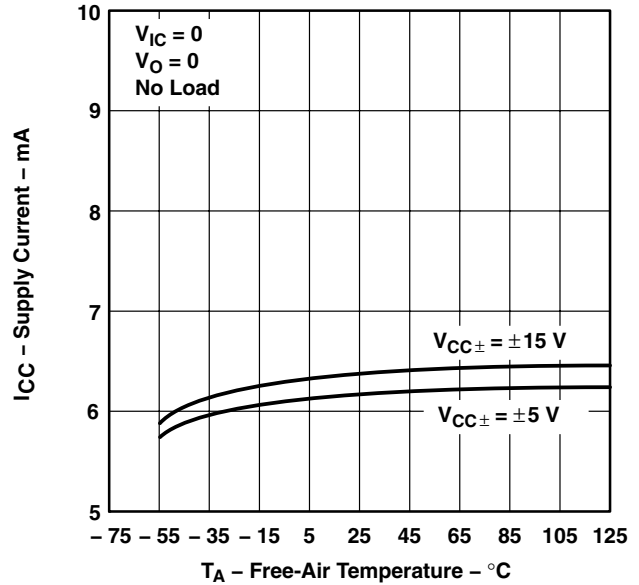

Figure 39

**TLE2071
 SUPPLY CURRENT
 vs
 DIFFERENTIAL INPUT VOLTAGE**

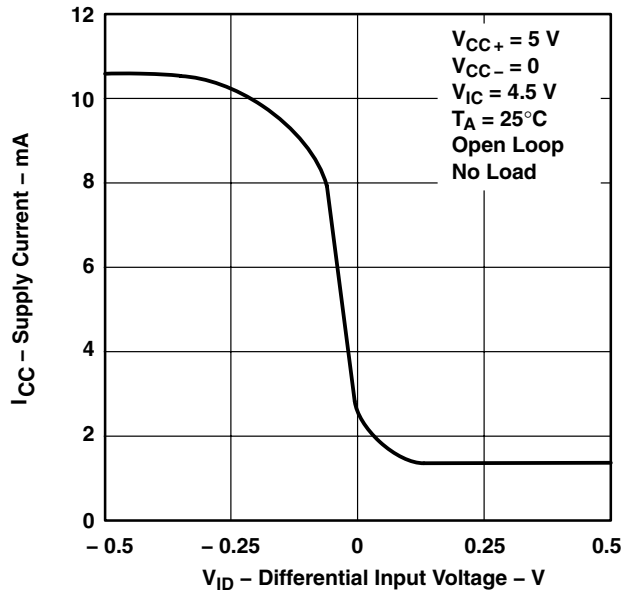

Figure 40

**TLE2072
 SUPPLY CURRENT
 vs
 DIFFERENTIAL INPUT VOLTAGE**

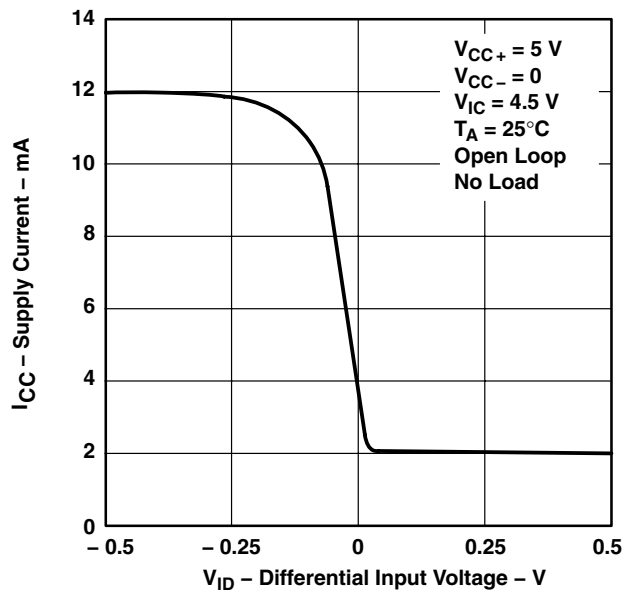

Figure 41

† Data at high and low temperatures are applicable only within the rated operating free-air temperature ranges of the various devices.

TLE207x-Q1, TLE207xA-Q1
EXCALIBUR LOW-NOISE HIGH-SPEED
JFET-INPUT OPERATIONAL AMPLIFIERS

SGLS226A – DECEMBER 2003 – REVISED AUGUST 2004

TYPICAL CHARACTERISTICS

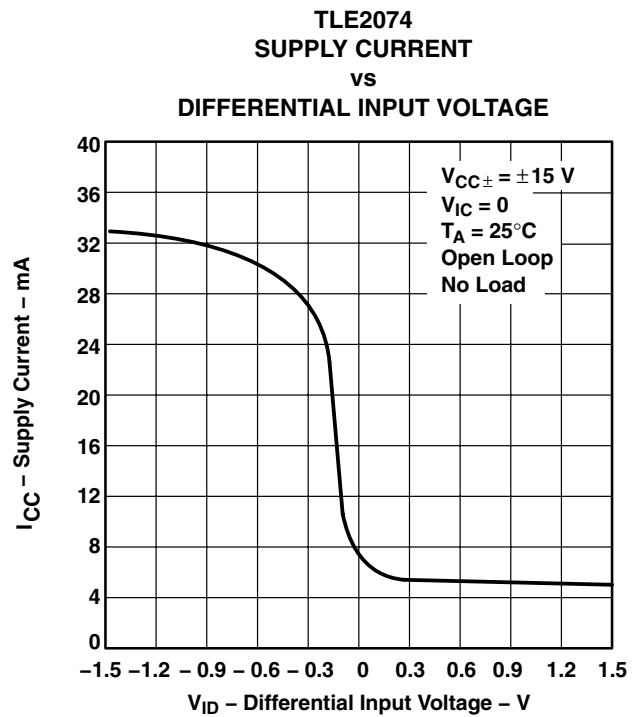
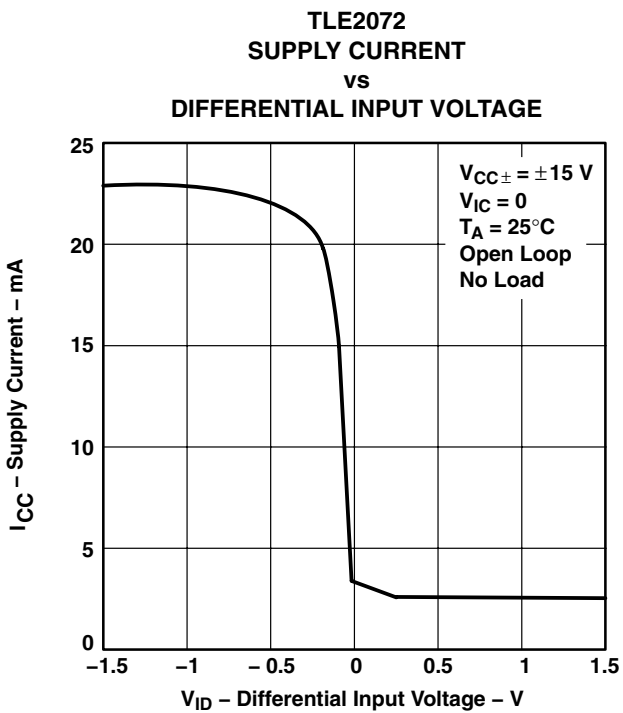
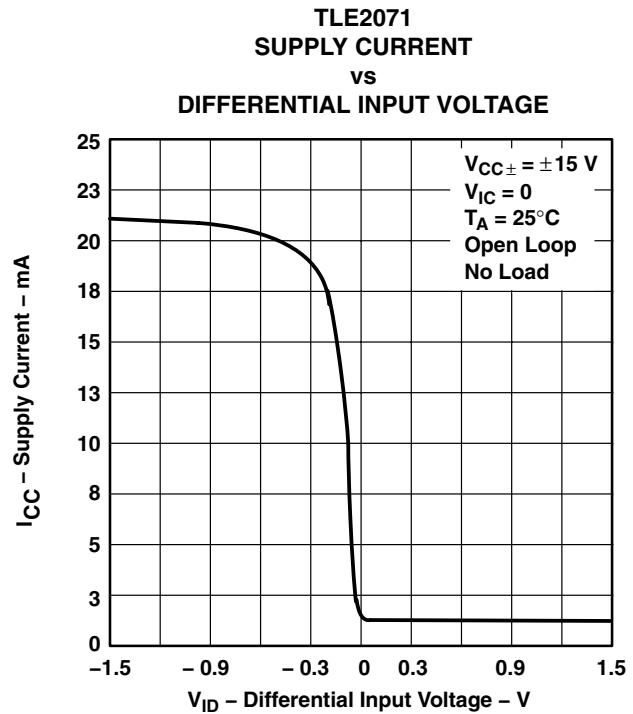
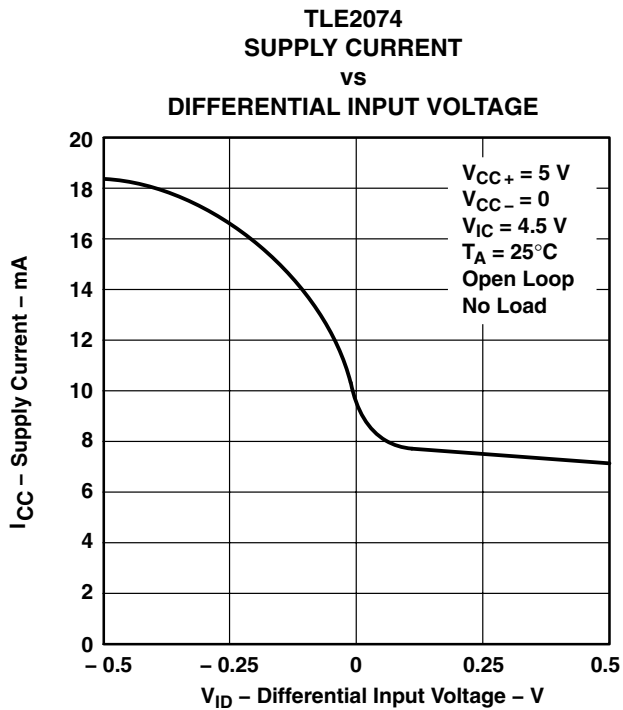

TYPICAL CHARACTERISTICS

**SHORT-CIRCUIT OUTPUT CURRENT
 vs
 SUPPLY VOLTAGE**

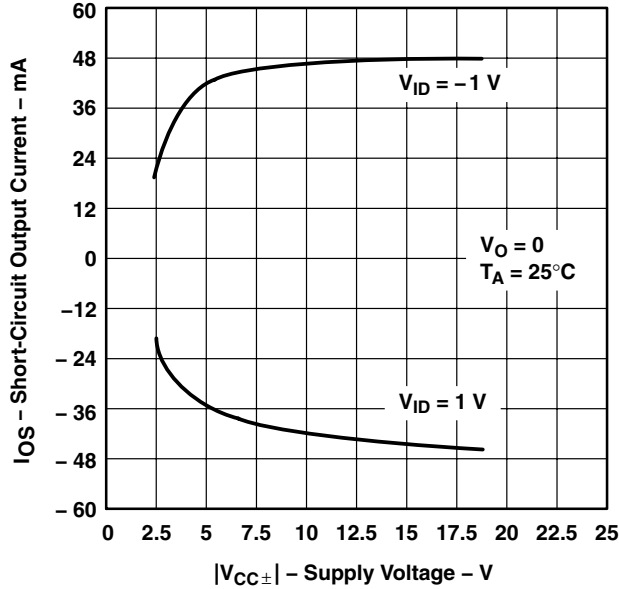

Figure 46

**SHORT-CIRCUIT OUTPUT CURRENT
 vs
 ELAPSED TIME**

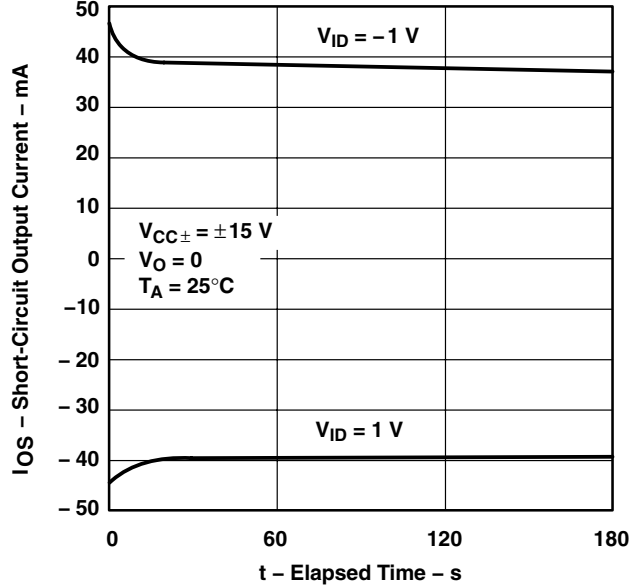

Figure 47

**SHORT-CIRCUIT OUTPUT CURRENT†
 vs
 FREE-AIR TEMPERATURE**

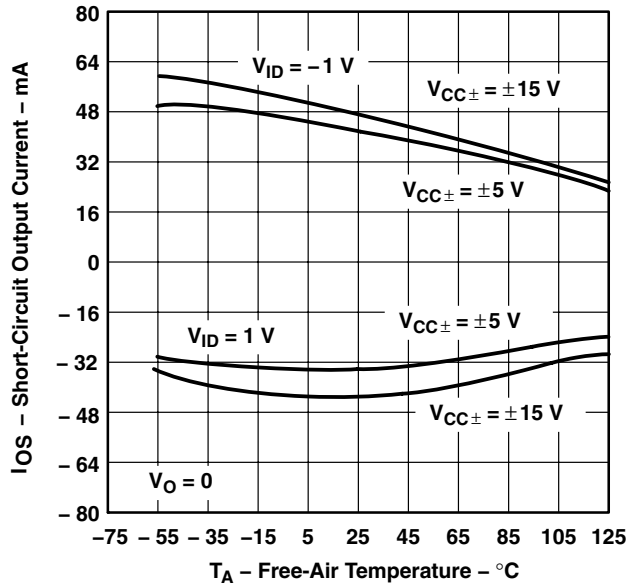

Figure 48

**SLEW RATE†
 vs
 FREE-AIR TEMPERATURE**

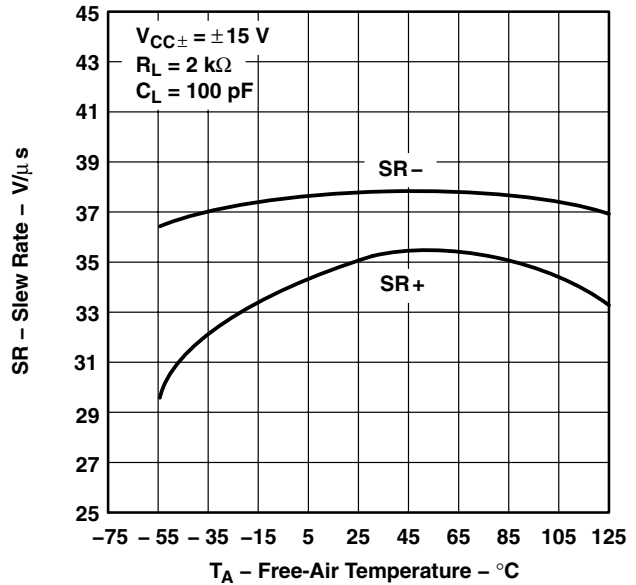

Figure 49

† Data at high and low temperatures are applicable only within the rated operating free-air temperature ranges of the various devices.

TLE207x-Q1, TLE207xA-Q1
EXCALIBUR LOW-NOISE HIGH-SPEED
JFET-INPUT OPERATIONAL AMPLIFIERS

SGLS226A – DECEMBER 2003 – REVISED AUGUST 2004

TYPICAL CHARACTERISTICS

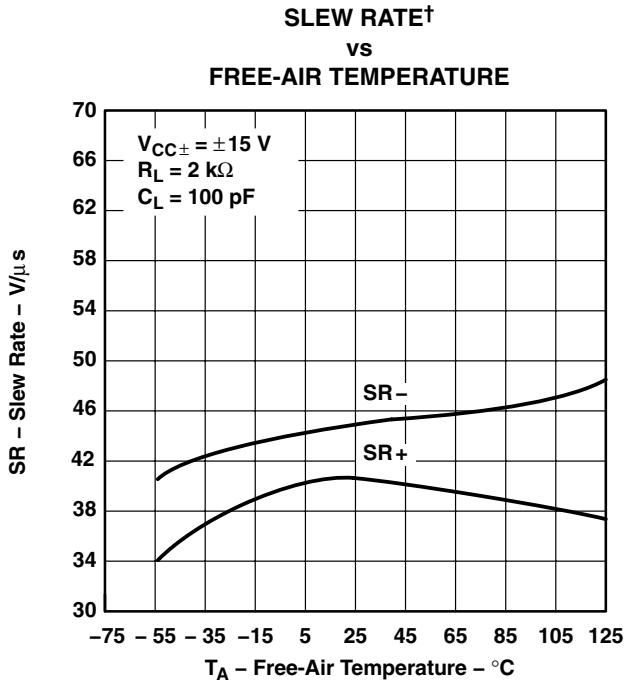

Figure 50

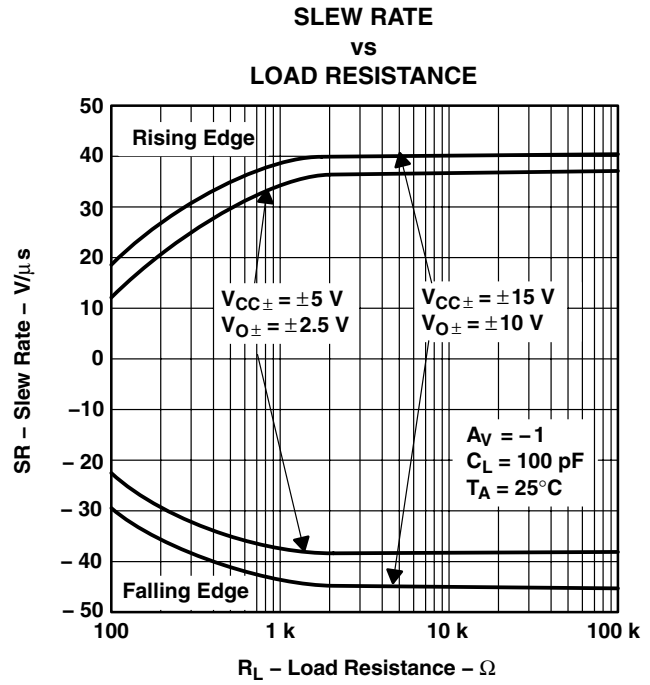

Figure 51

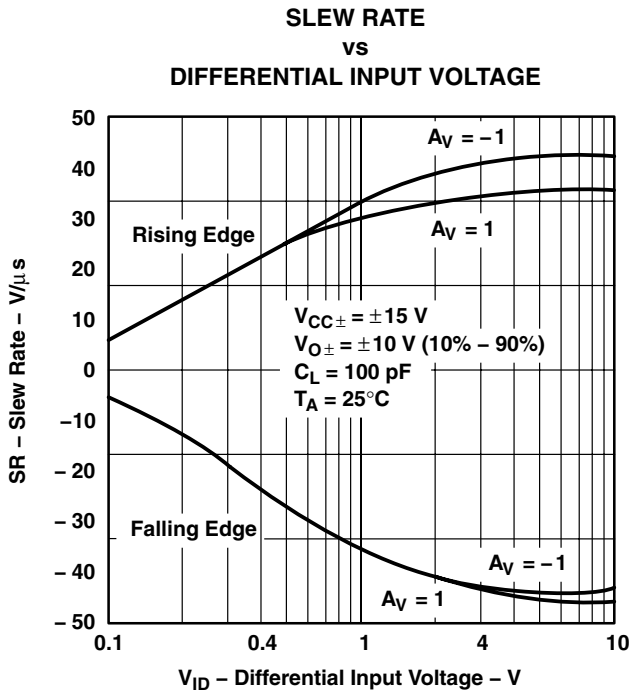

Figure 52

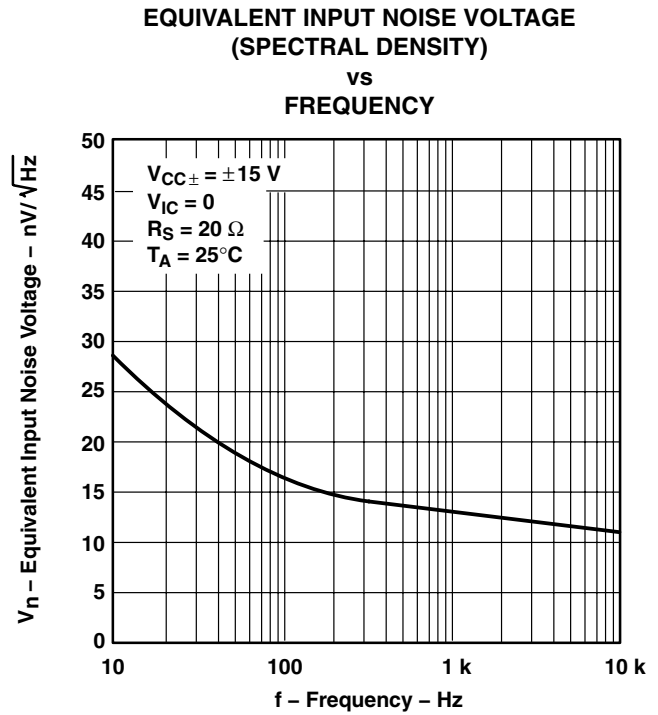

Figure 53

† Data at high and low temperatures are applicable only within the rated operating free-air temperature ranges of the various devices.

TYPICAL CHARACTERISTICS

**INPUT-REFERRED NOISE VOLTAGE
 vs
 NOISE BANDWIDTH**

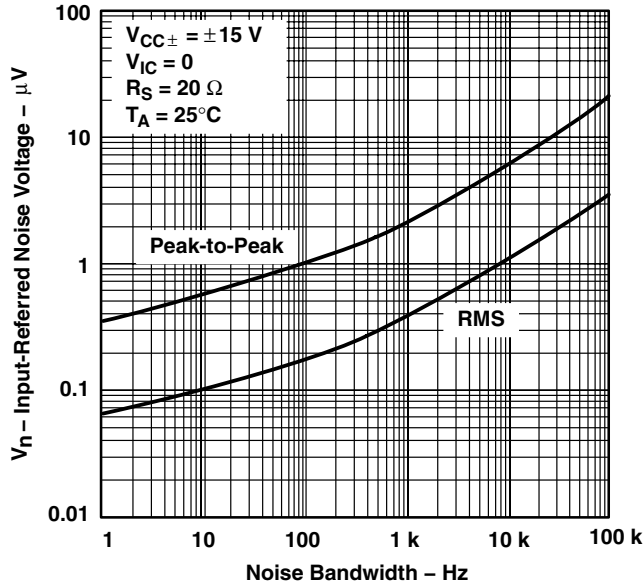

Figure 54

**INPUT-REFERRED NOISE VOLTAGE
 OVER A 10-SECOND TIME INTERVAL**

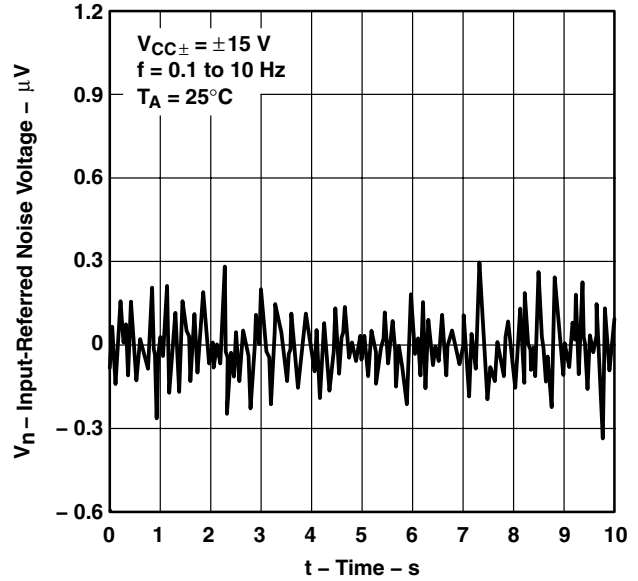

Figure 55

**THIRD-OCTAVE SPECTRAL NOISE DENSITY
 vs
 FREQUENCY BANDS**

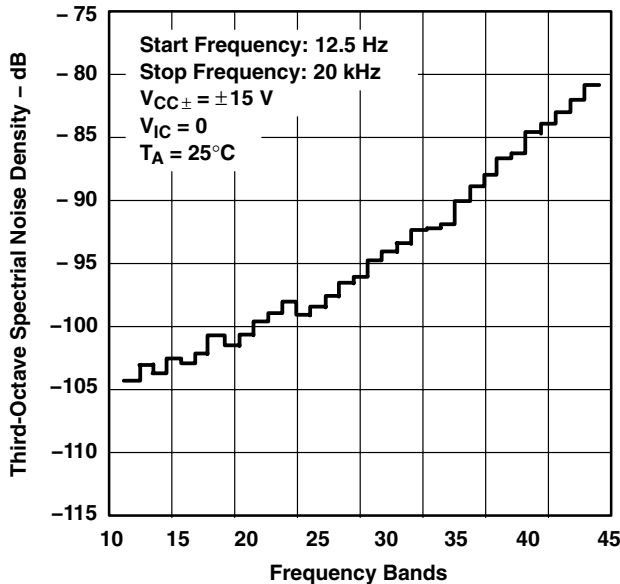

Figure 56

**TOTAL HARMONIC DISTORTION PLUS NOISE
 vs
 FREQUENCY**

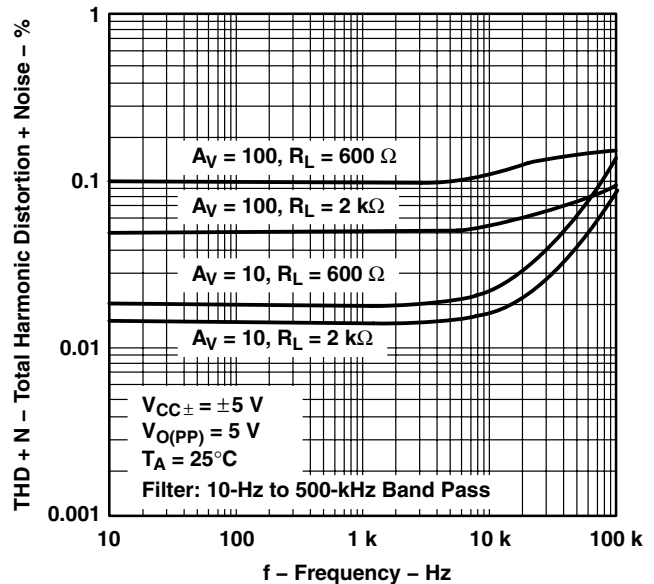

Figure 57

TLE207x-Q1, TLE207xA-Q1 EXCALIBUR LOW-NOISE HIGH-SPEED JFET-INPUT OPERATIONAL AMPLIFIERS

SGLS226A – DECEMBER 2003 – REVISED AUGUST 2004

TYPICAL CHARACTERISTICS

**TOTAL HARMONIC DISTORTION PLUS NOISE
vs
FREQUENCY**

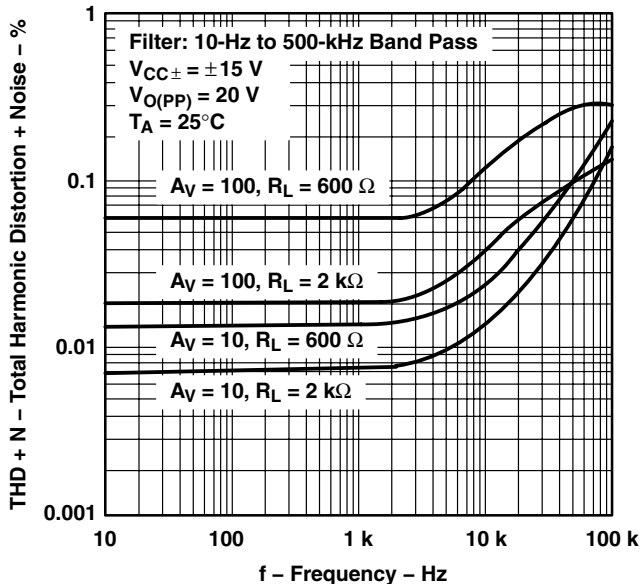

Figure 58

**UNITY-GAIN BANDWIDTH
vs
LOAD CAPACITANCE**

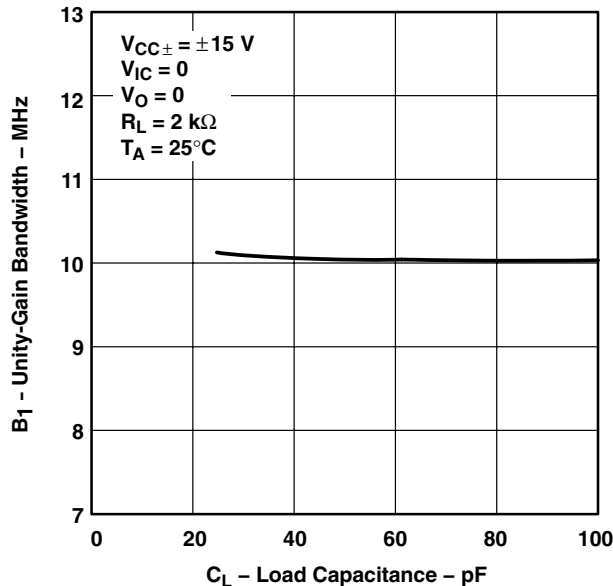

Figure 59

**GAIN-BANDWIDTH PRODUCT†
vs
FREE-AIR TEMPERATURE**

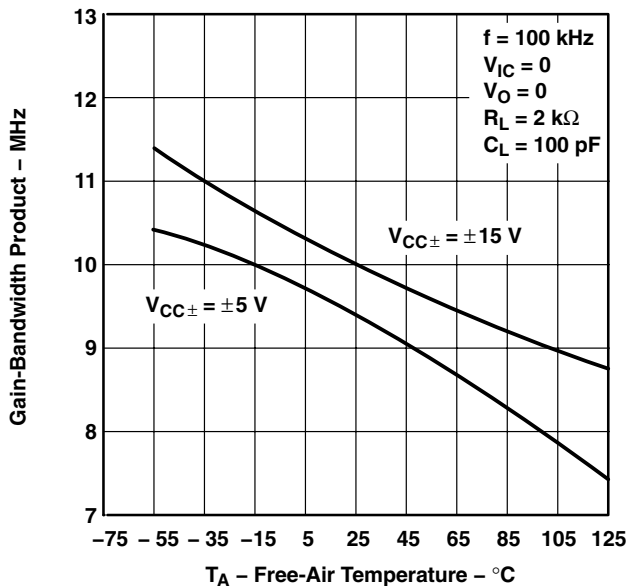

Figure 60

**GAIN-BANDWIDTH PRODUCT
vs
SUPPLY VOLTAGE**

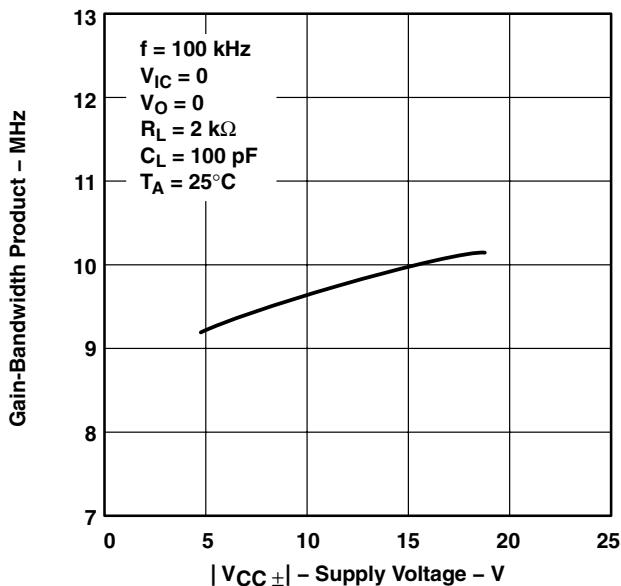

Figure 61

† Data at high and low temperatures are applicable only within the rated operating free-air temperature ranges of the various devices.

TYPICAL CHARACTERISTICS

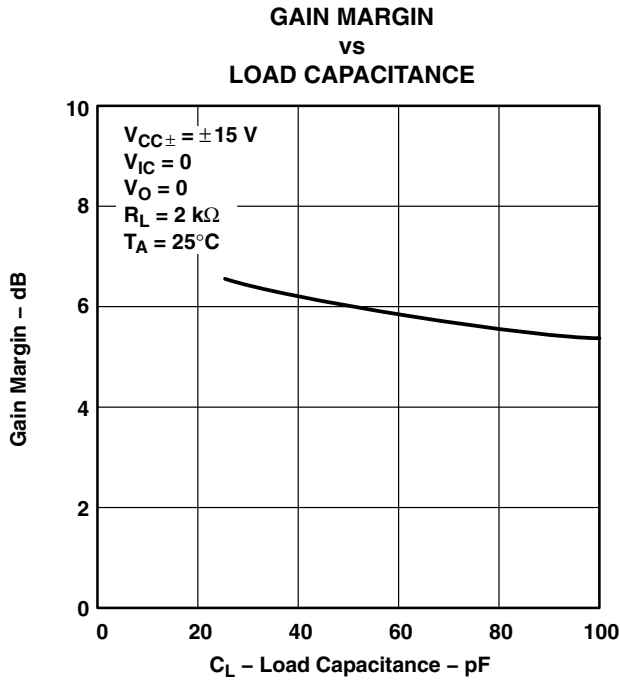

Figure 62

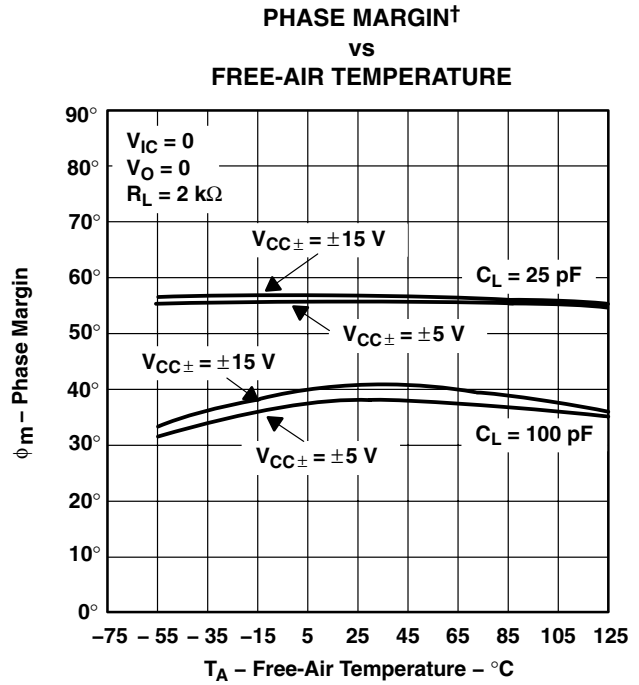

Figure 63

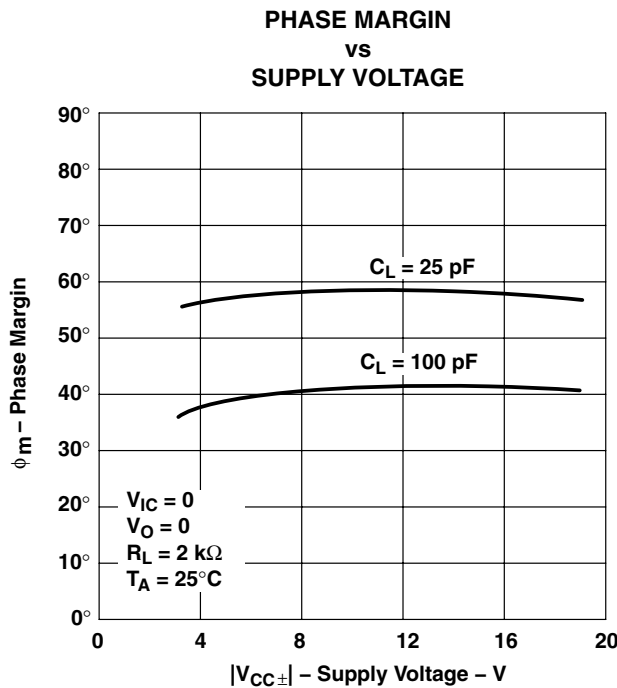

Figure 64

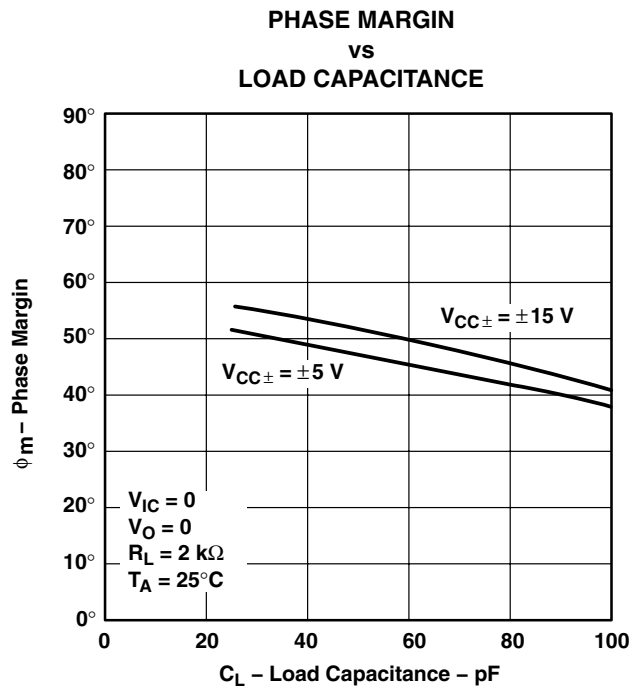

Figure 65

† Data at high and low temperatures are applicable only within the rated operating free-air temperature ranges of the various devices.

TLE207x-Q1, TLE207xA-Q1 EXCALIBUR LOW-NOISE HIGH-SPEED JFET-INPUT OPERATIONAL AMPLIFIERS

SGLS226A – DECEMBER 2003 – REVISED AUGUST 2004

TYPICAL CHARACTERISTICS

**NONINVERTING LARGE-SIGNAL
PULSE RESPONSE†**

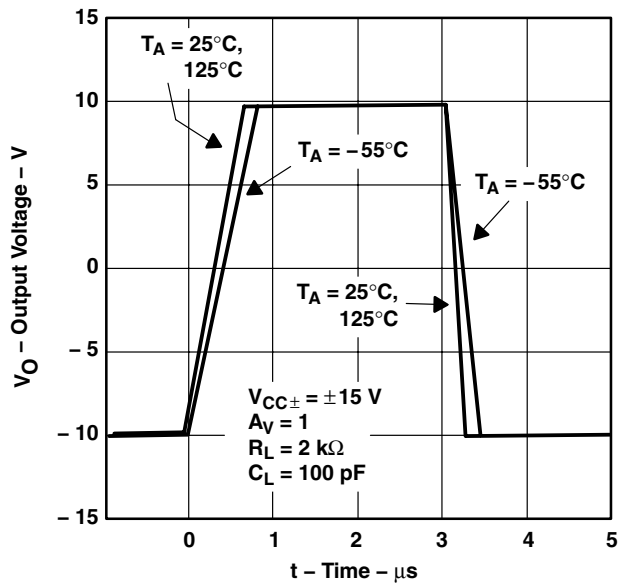

Figure 66

SMALL-SIGNAL PULSE RESPONSE

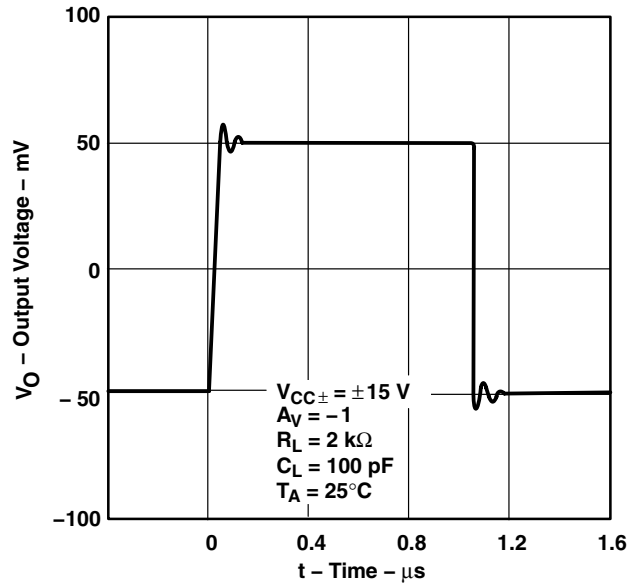

Figure 67

**CLOSED-LOOP OUTPUT IMPEDANCE
vs
FREQUENCY**

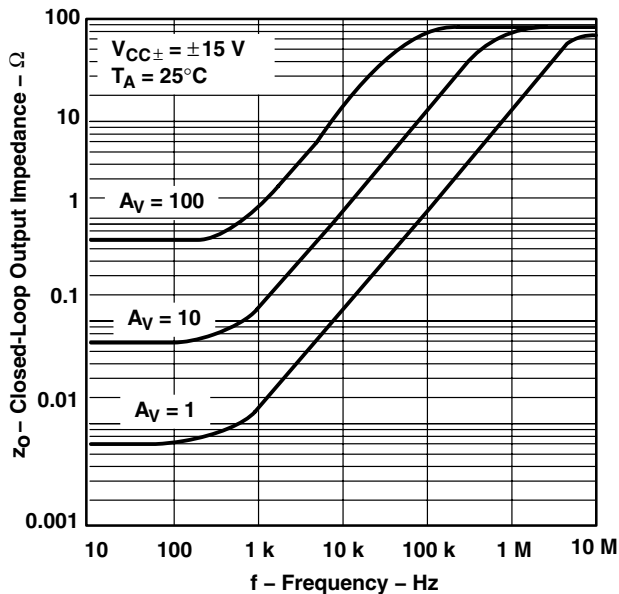

Figure 68

**TLE2072 AND TLE2074
CROSSTALK ATTENUATION
vs
FREQUENCY**

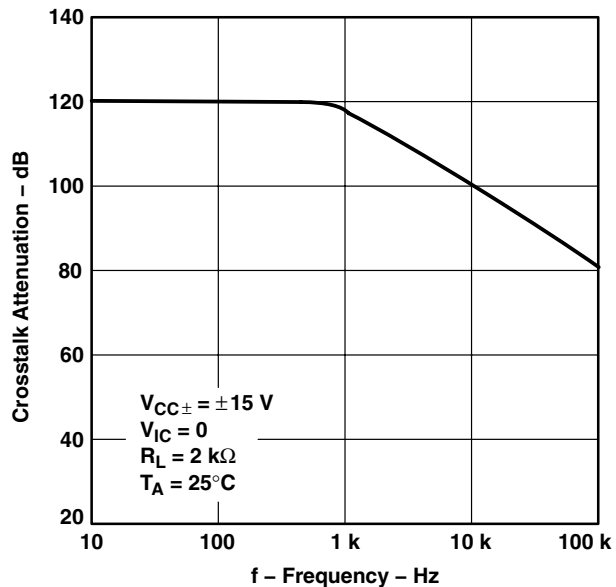

Figure 69

† Data at high and low temperatures are applicable only within the rated operating free-air temperature ranges of the various devices.

APPLICATION INFORMATION

input characteristics

The TLE207x, TLE207xA, and TLE207xB are specified with a minimum and a maximum input voltage that if exceeded at either input could cause the device to malfunction. Because of the extremely high input impedance and resulting low bias current requirements, the TLE207x, TLE207xA, and TLE207xB are well suited for low-level signal processing; however, leakage currents on printed-circuit boards and sockets can easily exceed bias current requirements and cause degradation in system performance. It is good practice to include guard rings around inputs (see Figure 70). These guards should be driven from a low-impedance source at the same voltage level as the common-mode input.

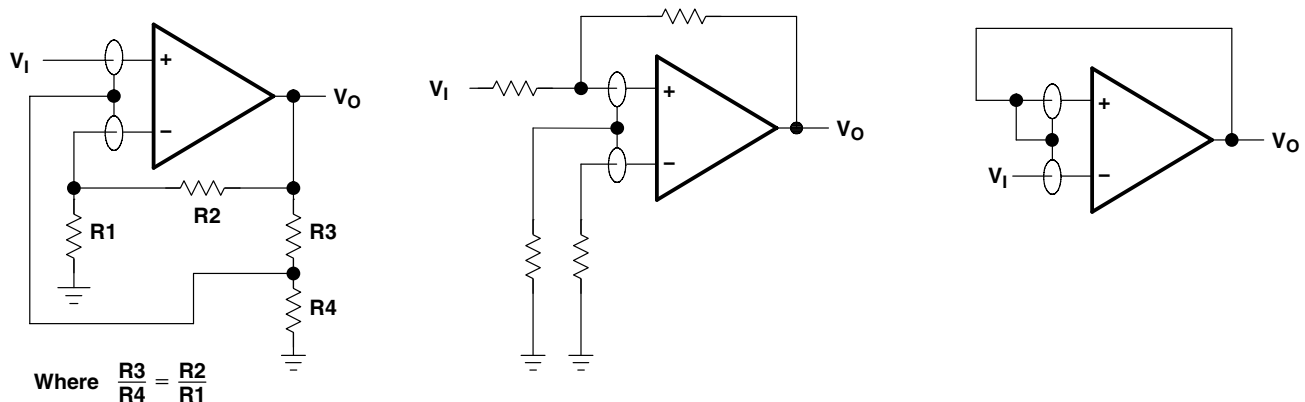

Figure 70. Use of Guard Rings

TLE2071 input offset voltage nulling

The TLE2071 series offers external null pins that can be used to further reduce the input offset voltage. The circuit of Figure 71 can be connected as shown if the feature is desired. When external nulling is not needed, the null pins may be left unconnected.

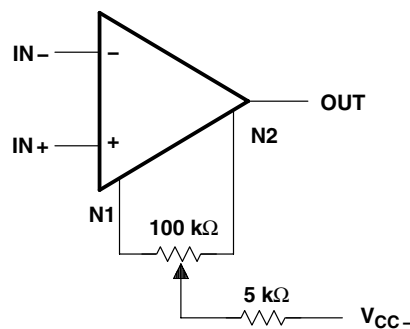

Figure 71. Input Offset Voltage Nulling

TLE207x-Q1, TLE207xA-Q1 EXCALIBUR LOW-NOISE HIGH-SPEED JFET-INPUT OPERATIONAL AMPLIFIERS

SGLS226A – DECEMBER 2003 – REVISED AUGUST 2004

APPLICATION INFORMATION

macromodel information

Macromodel information provided was derived using *PSpice™ Parts™* model generation software. The Boyle macromodel (see Note 4) and subcircuit Figure 72 were generated using the TLE207x typical electrical and operating characteristics at $T_A = 25^\circ\text{C}$. Using this information, output simulations of the following key parameters can be generated to a tolerance of 20% (in most cases):

- Maximum positive output voltage swing
- Maximum negative output voltage swing
- Slew rate
- Quiescent power dissipation
- Input bias current
- Open-loop voltage amplification
- Unity-gain frequency
- Common-mode rejection ratio
- Phase margin
- DC output resistance
- AC output resistance
- Short-circuit output current limit

NOTE 4: G.R. Boyle, B.M. Cohn, D. O. Pederson, and J. E. Solomon, "Macromodeling of Integrated Circuit Operational Amplifiers", *IEEE Journal of Solid-State Circuits*, SC-9, 353 (1974).

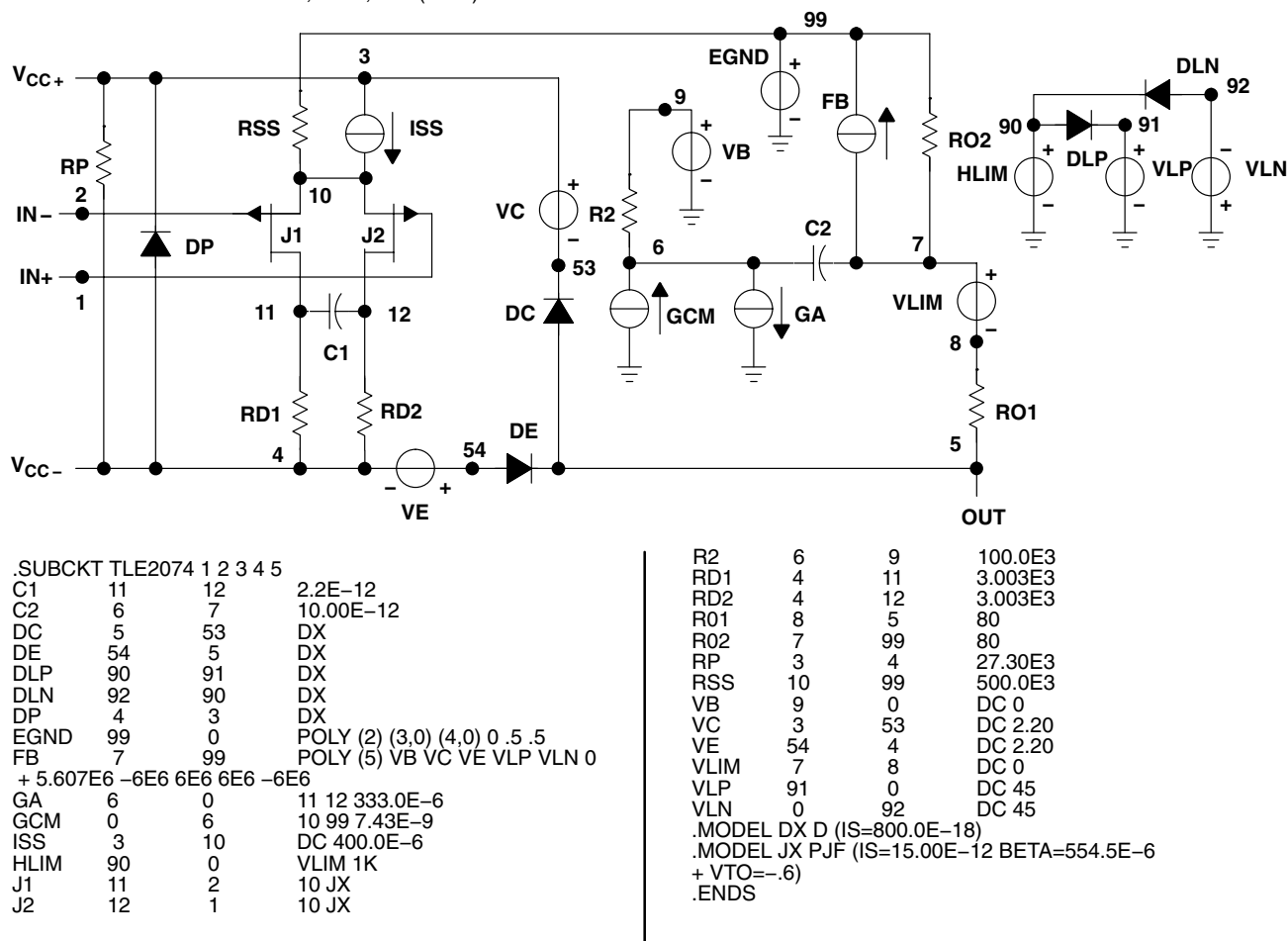

Figure 72. Boyle Macromodel and Subcircuit

PSpice and *Parts* are trademarks of MicroSim Corporation.



POST OFFICE BOX 655303 • DALLAS, TEXAS 75265

PACKAGING INFORMATION

Orderable part number	Status (1)	Material type (2)	Package Pins	Package qty Carrier	RoHS (3)	Lead finish/ Ball material (4)	MSL rating/ Peak reflow (5)	Op temp (°C)	Part marking (6)
TLE2071AQDRG4Q1	Active	Production	SOIC (D) 8	2500 LARGE T&R	Yes	NIPDAU	Level-1-260C-UNLIM	-40 to 125	2071AQ
TLE2071AQDRG4Q1.A	Active	Production	SOIC (D) 8	2500 LARGE T&R	Yes	NIPDAU	Level-1-260C-UNLIM	-40 to 125	2071AQ
TLE2071AQDRQ1	Active	Production	SOIC (D) 8	2500 LARGE T&R	Yes	NIPDAU	Level-1-260C-UNLIM	-40 to 125	2071AQ
TLE2071AQDRQ1.A	Active	Production	SOIC (D) 8	2500 LARGE T&R	Yes	NIPDAU	Level-1-260C-UNLIM	-40 to 125	2071AQ
TLE2072AQDRG4Q1	Active	Production	SOIC (D) 8	2500 LARGE T&R	Yes	NIPDAU	Level-1-260C-UNLIM	-40 to 125	2072AQ
TLE2072AQDRG4Q1.A	Active	Production	SOIC (D) 8	2500 LARGE T&R	Yes	NIPDAU	Level-1-260C-UNLIM	-40 to 125	2072AQ

(1) **Status:** For more details on status, see our [product life cycle](#).

(2) **Material type:** When designated, preproduction parts are prototypes/experimental devices, and are not yet approved or released for full production. Testing and final process, including without limitation quality assurance, reliability performance testing, and/or process qualification, may not yet be complete, and this item is subject to further changes or possible discontinuation. If available for ordering, purchases will be subject to an additional waiver at checkout, and are intended for early internal evaluation purposes only. These items are sold without warranties of any kind.

(3) **RoHS values:** Yes, No, RoHS Exempt. See the [TI RoHS Statement](#) for additional information and value definition.

(4) **Lead finish/Ball material:** Parts may have multiple material finish options. Finish options are separated by a vertical ruled line. Lead finish/Ball material values may wrap to two lines if the finish value exceeds the maximum column width.

(5) **MSL rating/Peak reflow:** The moisture sensitivity level ratings and peak solder (reflow) temperatures. In the event that a part has multiple moisture sensitivity ratings, only the lowest level per JEDEC standards is shown. Refer to the shipping label for the actual reflow temperature that will be used to mount the part to the printed circuit board.

(6) **Part marking:** There may be an additional marking, which relates to the logo, the lot trace code information, or the environmental category of the part.

Multiple part markings will be inside parentheses. Only one part marking contained in parentheses and separated by a "~" will appear on a part. If a line is indented then it is a continuation of the previous line and the two combined represent the entire part marking for that device.

Important Information and Disclaimer:The information provided on this page represents TI's knowledge and belief as of the date that it is provided. TI bases its knowledge and belief on information provided by third parties, and makes no representation or warranty as to the accuracy of such information. Efforts are underway to better integrate information from third parties. TI has taken and continues to take reasonable steps to provide representative and accurate information but may not have conducted destructive testing or chemical analysis on incoming materials and chemicals. TI and TI suppliers consider certain information to be proprietary, and thus CAS numbers and other limited information may not be available for release.

In no event shall TI's liability arising out of such information exceed the total purchase price of the TI part(s) at issue in this document sold by TI to Customer on an annual basis.

OTHER QUALIFIED VERSIONS OF TLE2071A-Q1, TLE2072A-Q1 :

- Catalog : [TLE2071A](#), [TLE2072A](#)
- Military : [TLE2071AM](#), [TLE2072AM](#)

NOTE: Qualified Version Definitions:

- Catalog - TI's standard catalog product
- Military - QML certified for Military and Defense Applications

TAPE AND REEL INFORMATION

QUADRANT ASSIGNMENTS FOR PIN 1 ORIENTATION IN TAPE

*All dimensions are nominal

Device	Package Type	Package Drawing	Pins	SPQ	Reel Diameter (mm)	Reel Width W1 (mm)	A0 (mm)	B0 (mm)	K0 (mm)	P1 (mm)	W (mm)	Pin1 Quadrant
TLE2072AQDRG4Q1	SOIC	D	8	2500	330.0	12.4	6.4	5.2	2.1	8.0	12.0	Q1

TAPE AND REEL BOX DIMENSIONS

*All dimensions are nominal

Device	Package Type	Package Drawing	Pins	SPQ	Length (mm)	Width (mm)	Height (mm)
TLE2072AQDRG4Q1	SOIC	D	8	2500	353.0	353.0	32.0

EXAMPLE BOARD LAYOUT

D0008A

SOIC - 1.75 mm max height

SMALL OUTLINE INTEGRATED CIRCUIT



LAND PATTERN EXAMPLE
EXPOSED METAL SHOWN
SCALE:8X



SOLDER MASK DETAILS

4214825/C 02/2019

NOTES: (continued)

6. Publication IPC-7351 may have alternate designs.

7. Solder mask tolerances between and around signal pads can vary based on board fabrication site.

EXAMPLE STENCIL DESIGN

D0008A

SOIC - 1.75 mm max height

SMALL OUTLINE INTEGRATED CIRCUIT



SOLDER PASTE EXAMPLE
BASED ON .005 INCH [0.125 MM] THICK STENCIL
SCALE:8X

4214825/C 02/2019

NOTES: (continued)

8. Laser cutting apertures with trapezoidal walls and rounded corners may offer better paste release. IPC-7525 may have alternate design recommendations.
9. Board assembly site may have different recommendations for stencil design.

IMPORTANT NOTICE AND DISCLAIMER

TI PROVIDES TECHNICAL AND RELIABILITY DATA (INCLUDING DATASHEETS), DESIGN RESOURCES (INCLUDING REFERENCE DESIGNS), APPLICATION OR OTHER DESIGN ADVICE, WEB TOOLS, SAFETY INFORMATION, AND OTHER RESOURCES "AS IS" AND WITH ALL FAULTS, AND DISCLAIMS ALL WARRANTIES, EXPRESS AND IMPLIED, INCLUDING WITHOUT LIMITATION ANY IMPLIED WARRANTIES OF MERCHANTABILITY, FITNESS FOR A PARTICULAR PURPOSE OR NON-INFRINGEMENT OF THIRD PARTY INTELLECTUAL PROPERTY RIGHTS.

These resources are intended for skilled developers designing with TI products. You are solely responsible for (1) selecting the appropriate TI products for your application, (2) designing, validating and testing your application, and (3) ensuring your application meets applicable standards, and any other safety, security, regulatory or other requirements.

These resources are subject to change without notice. TI grants you permission to use these resources only for development of an application that uses the TI products described in the resource. Other reproduction and display of these resources is prohibited. No license is granted to any other TI intellectual property right or to any third party intellectual property right. TI disclaims responsibility for, and you fully indemnify TI and its representatives against any claims, damages, costs, losses, and liabilities arising out of your use of these resources.

TI's products are provided subject to [TI's Terms of Sale](#), [TI's General Quality Guidelines](#), or other applicable terms available either on [ti.com](#) or provided in conjunction with such TI products. TI's provision of these resources does not expand or otherwise alter TI's applicable warranties or warranty disclaimers for TI products. Unless TI explicitly designates a product as custom or customer-specified, TI products are standard, catalog, general purpose devices.

TI objects to and rejects any additional or different terms you may propose.

Copyright © 2025, Texas Instruments Incorporated

Last updated 10/2025