

# TPS3840-Q1 Automotive Nano I<sub>Q</sub> Voltage Supervisor With $\overline{\text{MR}}$ and Programmable Delay

## 1 Features

- Qualified for automotive applications
- AEC-Q100 qualified with the following results:
  - Device temperature grade 1:  $-40^{\circ}\text{C}$  to  $+125^{\circ}\text{C}$  ambient operating temperature
  - Device HBM ESD classification level 2
  - Device CDM ESD classification level C7B
- Wide operating voltage : 1.5 V to 10 V
  - Use external resistors to extend  $V_{\text{in}}$  range
- Nano supply current : 350 nA (Typ), 700 nA (Max)
- Fixed threshold voltage ( $V_{\text{IT-}}$ )
  - Threshold from 1.6 V to 4.9 V in 0.1-V steps
  - High accuracy: 1% (Typ), 1.5% (Max)
  - Built-in hysteresis ( $V_{\text{IT+}}$ )
    - $1.6\text{ V} < V_{\text{IT-}} \leq 3.0\text{ V} = 100\text{ mV}$  (typical)
    - $3.1\text{ V} \leq V_{\text{IT-}} < 4.9\text{ V} = 200\text{ mV}$  (typical)
- Fast start-up delay ( $t_{\text{STRT}}$ ): 350  $\mu\text{s}$  (Max)
- Programmable capacitor-based reset time delay:
  - $t_{\text{D}}$ : 50  $\mu\text{s}$  (no capacitor) to 6.2 s (10- $\mu\text{F}$ )
- Active-low manual reset ( $\overline{\text{MR}}$ )
- Three output topologies:
  - TPS3840DL-Q1: open-drain, active-low ( $\overline{\text{RESET}}$ )
  - TPS3840PL-Q1: push-pull, active-low ( $\overline{\text{RESET}}$ )
  - TPS3840PH-Q1: push-pull, active-high (RESET)
- Package: 5-pin SOT-23 (DBV)

## 2 Applications

- [Automotive head unit and cluster](#)
- [Automotive display, integrated cockpit and driver monitoring](#)
- [Telematics control unit and emergency call](#)

## 3 Description

The TPS3840-Q1 family of voltage supervisors or reset ICs can operate at high voltage levels while maintaining very low quiescent current across the whole  $V_{\text{DD}}$  and temperature range. TPS3840-Q1 offers best combination of low power consumption, high accuracy and low propagation delay ( $t_{\text{p\_HL}} = 30\ \mu\text{s}$  typical).

Reset output signal is asserted when the voltage at VDD drops below the negative voltage threshold ( $V_{\text{IT-}}$ ) or when manual reset is pulled to a low logic ( $V_{\overline{\text{MR\_L}}}$ ). Reset signal is cleared when  $V_{\text{DD}}$  rise above  $V_{\text{IT-}}$  plus hysteresis ( $V_{\text{IT+}}$ ) and manual reset ( $\overline{\text{MR}}$ ) is floating or above  $V_{\overline{\text{MR\_H}}}$  and the reset time delay ( $t_{\text{D}}$ ) expires. Reset time delay can be programmed by connecting a capacitor between CT pin and ground. For a fast reset CT pin can be left floating.

Additional features: Low power-on reset voltage ( $V_{\text{POR}}$ ), built-in glitch immunity protection for  $\overline{\text{MR}}$  and VDD, built-in hysteresis, low open-drain output leakage current ( $I_{\text{LKG(OD)}}$ ). TPS3840-Q1 is a perfect voltage monitoring solution for automotive applications and battery-powered / low power applications.

### Device Information<sup>(1)</sup>

PART NUMBER	PACKAGE	BODY SIZE (NOM)
TPS3840-Q1	SOT-23 (5) (DBV)	2.90 mm x 1.60 mm

(1) For package details, see the mechanical drawing addendum at the end of the data sheet.

### Typical Application Circuit

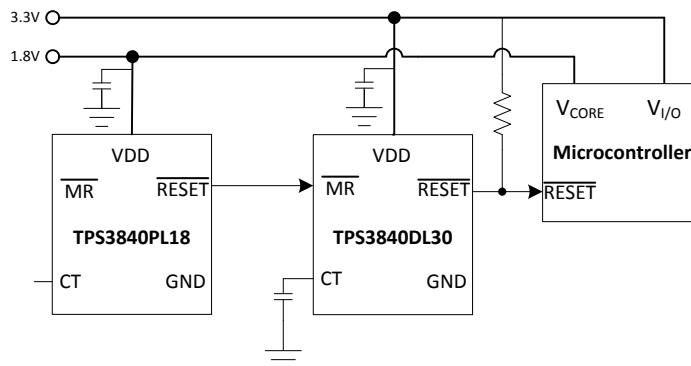

## Table of Contents

<b>1 Features</b> .....	<b>1</b>	8.3 Feature Description.....	<b>16</b>
<b>2 Applications</b> .....	<b>1</b>	8.4 Device Functional Modes.....	<b>19</b>
<b>3 Description</b> .....	<b>1</b>	<b>9 Application and Implementation</b> .....	<b>20</b>
<b>4 Revision History</b> .....	<b>2</b>	9.1 Application Information.....	<b>20</b>
<b>5 Device Comparison</b> .....	<b>3</b>	9.2 Typical Application .....	<b>20</b>
<b>6 Pin Configuration and Functions</b> .....	<b>4</b>	<b>10 Power Supply Recommendations</b> .....	<b>25</b>
<b>7 Specifications</b> .....	<b>5</b>	<b>11 Layout</b> .....	<b>25</b>
7.1 Absolute Maximum Ratings .....	<b>5</b>	11.1 Layout Guidelines .....	<b>25</b>
7.2 ESD Ratings .....	<b>5</b>	11.2 Layout Example .....	<b>25</b>
7.3 Recommended Operating Conditions.....	<b>5</b>	<b>12 Device and Documentation Support</b> .....	<b>26</b>
7.4 Thermal Information .....	<b>5</b>	12.1 Device Nomenclature.....	<b>26</b>
7.5 Electrical Characteristics.....	<b>6</b>	12.2 Receiving Notification of Documentation Updates	<b>27</b>
7.6 Timing Requirements .....	<b>7</b>	12.3 Community Resources.....	<b>27</b>
7.7 Typical Characteristics .....	<b>9</b>	12.4 Trademarks .....	<b>27</b>
<b>8 Detailed Description</b> .....	<b>16</b>	12.5 Electrostatic Discharge Caution.....	<b>27</b>
8.1 Overview .....	<b>16</b>	12.6 Glossary .....	<b>27</b>
8.2 Functional Block Diagram .....	<b>16</b>	<b>13 Mechanical, Packaging, and Orderable Information</b> .....	<b>27</b>

## 4 Revision History

NOTE: Page numbers for previous revisions may differ from page numbers in the current version.

<b>Changes from Revision A (September 2019) to Revision B</b>	<b>Page</b>
• Changed equation 5 and 6 .....	<b>17</b>
• Added section describing further details on capacitor. ....	<b>18</b>
• Deleted non-relevant application design. ....	<b>22</b>

<b>Changes from Original (April 2019) to Revision A</b>	<b>Page</b>
• Advance Information to Production Data Release .....	<b>1</b>

## 5 Device Comparison

Figure 1 shows the device nomenclature to determine the device variant. Other voltages from Table 3 at the end of datasheet can be sampled upon request, please contact TI sales representative for details.

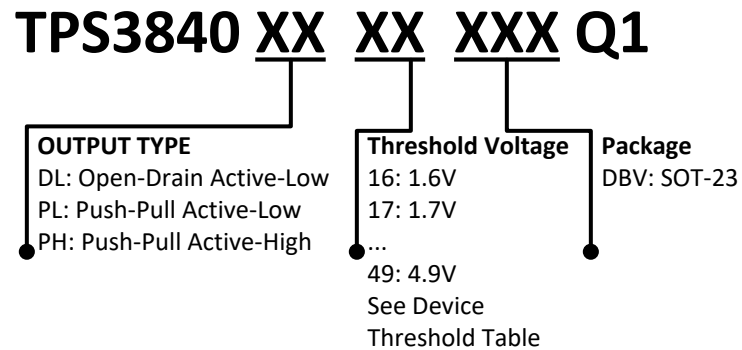

**Figure 1. Device Nomenclature**

## 6 Pin Configuration and Functions

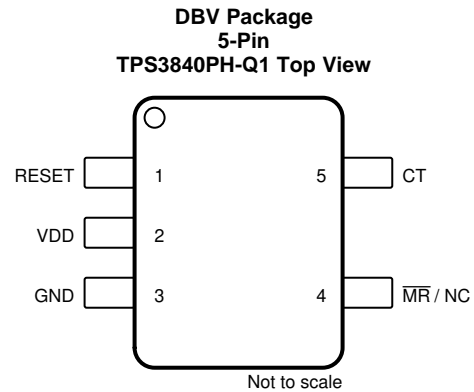

### Pin Functions

NAME	PIN		I/O	DESCRIPTION
	TPS3840PL-Q1, TPS3840DL-Q1	TPS3840PH-Q1		
RESET	N/A	1	O	<b>Active-High Output Reset Signal:</b> This pin is driven high when either the $\overline{\text{MR}}$ pin is driven to a logic low or VDD voltage falls below the negative voltage threshold ( $V_{\text{IT-}}$ ). RESET remains high (asserted) for the delay time period ( $t_{\text{D}}$ ) after both $\overline{\text{MR}}$ is floating or above $V_{\overline{\text{MR-L}}}$ and VDD voltage rise above $V_{\text{IT+}}$ .
$\overline{\text{RESET}}$	1	N/A	O	<b>Active-Low Output Reset Signal:</b> This pin is driven logic low when either the $\overline{\text{MR}}$ pin is driven to a logic low or VDD voltage falls below the negative voltage threshold ( $V_{\text{IT-}}$ ). $\overline{\text{RESET}}$ remains low (asserted) for the delay time period ( $t_{\text{D}}$ ) after both $\overline{\text{MR}}$ is floating or above $V_{\overline{\text{MR-L}}}$ and VDD voltage rise above $V_{\text{IT+}}$ .
VDD	2	2	I	<b>Input Supply Voltage.</b> TPS3840-Q1 monitors VDD voltage
GND	3	3	–	<b>Ground</b>
$\overline{\text{MR}}$ / NC	4	4	I	<b>Manual Reset.</b> Pull this pin to a logic low ( $V_{\overline{\text{MR-L}}}$ ) to assert a reset signal in the output pin. After the $\overline{\text{MR}}$ pin is left floating or pull to $V_{\overline{\text{MR-H}}}$ the output goes to the nominal state after the reset delay time( $t_{\text{D}}$ ) expires. <b><math>\overline{\text{MR}}</math> can be left floating when not in use. NC stands for "No Connection" or floating.</b>
CT	5	5	-	<b>Capacitor Time Delay Pin.</b> The CT pin offers a user-programmable delay time. Connect an external capacitor on this pin to adjust time delay. When not in use leave pin floating for the smallest fixed time delay.

## 7 Specifications

### 7.1 Absolute Maximum Ratings

over operating free-air temperature range, unless otherwise noted<sup>(1)</sup>

		MIN	MAX	UNIT
Voltage	V <sub>DD</sub>	-0.3	12	V
	$\overline{\text{RESET}}$ (TPS3840PL)	-0.3	V <sub>DD</sub> + 0.3	
	RESET (TPS3840PH)	-0.3	V <sub>DD</sub> + 0.3	
	$\overline{\text{RESET}}$ (TPS3840DL)	-0.3	12	
	$\overline{\text{MR}}$ <sup>(2)</sup>	-0.3	12	
	CT	-0.3	5.5	
Current	$\overline{\text{RESET}}$ pin and RESET pin		±70	mA
Temperature <sup>(3)</sup>	Operating junction temperature, T <sub>J</sub>	-40	150	°C
	Storage, T <sub>stg</sub>	-65	150	

- (1) Stresses beyond those listed under *Absolute Maximum Rating* may cause permanent damage to the device. These are stress ratings only, which do not imply functional operation of the device at these or any other conditions beyond those indicated under *Recommended Operating Condition*. Exposure to absolute-maximum-rated conditions for extended periods may affect device reliability.
- (2) If the logic signal driving MR is less than V<sub>DD</sub>, then additional current flows into V<sub>DD</sub> and out of MR. V<sub>MR</sub> should not be higher than V<sub>DD</sub>.
- (3) As a result of the low dissipated power in this device, it is assumed that T<sub>J</sub> = T<sub>A</sub>.

### 7.2 ESD Ratings

			VALUE	UNIT
V <sub>(ESD)</sub>	Electrostatic discharge	Human body model (HBM), per ANSI/ESDA/JEDEC JS-001 <sup>(1)</sup>	± 2000	V
		Charged device model (CDM), per JEDEC specification JESD22-C101 <sup>(2)</sup>	± 750	

- (1) JEDEC document JEP155 states that 500-V HBM allows safe manufacturing with a standard ESD control process.
- (2) JEDEC document JEP157 states that 250-V CDM allows safe manufacturing with a standard ESD control process.

### 7.3 Recommended Operating Conditions

over operating free-air temperature range (unless otherwise noted)

		MIN	NOM	MAX	UNIT
V <sub>DD</sub>	Input supply voltage	1.5		10	V
V $\overline{\text{RESET}}$ , V <sub>RESET</sub>	$\overline{\text{RESET}}$ pin and RESET pin voltage	0		10	V
I $\overline{\text{RESET}}$ , I <sub>RESET</sub>	$\overline{\text{RESET}}$ pin and RESET pin current	0		±5	mA
T <sub>J</sub>	Junction temperature (free air temperature)	-40		125	°C
V <sub>MR</sub> <sup>(1)</sup>	Manual reset pin voltage	0		V <sub>DD</sub>	V

- (1) If the logic signal driving MR is less than V<sub>DD</sub>, then additional current flows into V<sub>DD</sub> and out of MR. V<sub>MR</sub> should not be higher than V<sub>DD</sub>.

### 7.4 Thermal Information

THERMAL METRIC <sup>(1)</sup>		TPS3840	UNIT
		DBV (SOT23-5)	
		5 PINS	
R <sub>θJA</sub>	Junction-to-ambient thermal resistance	187.5	°C/W
R <sub>θJC(top)</sub>	Junction-to-case (top) thermal resistance	109.2	°C/W
R <sub>θJB</sub>	Junction-to-board thermal resistance	92.8	°C/W
ψ <sub>JT</sub>	Junction-to-top characterization parameter	35.4	°C/W
ψ <sub>JB</sub>	Junction-to-board characterization parameter	92.5	°C/W
R <sub>θJC(bot)</sub>	Junction-to-case (bottom) thermal resistance	N/A	°C/W

- (1) For more information about traditional and new thermal metrics, see the [Semiconductor and IC Package Thermal Metrics](#) application report.

## 7.5 Electrical Characteristics

At  $1.5\text{ V} \leq V_{DD} \leq 10\text{ V}$ ,  $\overline{\text{MR}} = \text{Open}$ ,  $\overline{\text{RESET}}$  pull-up resistor ( $R_{\text{pull-up}}$ ) = 100 k $\Omega$  to VDD, output reset load ( $C_{\text{LOAD}}$ ) = 10 pF and over the operating free-air temperature range – 40°C to 125°C, unless otherwise noted. Typical values are at  $T_J = 25^\circ\text{C}$ .

PARAMETER		TEST CONDITIONS	MIN	TYP	MAX	UNIT
<b>COMMON PARAMETERS</b>						
$V_{DD}$	Input supply voltage		1.5		10	V
$V_{IT-}$	Negative-going input threshold accuracy <sup>(1)</sup>	-40°C to 125°C	-1.5	1	1.5	%
$V_{HYS}$	Hysteresis on $V_{IT-}$ pin	$V_{IT-} = 3.1\text{ V to }4.9\text{ V}$	175	200	225	mV
$V_{HYS}$	Hysteresis on $V_{IT-}$ pin	$V_{IT-} = 1.6\text{ V to }3.0\text{ V}$	75	100	125	mV
$I_{DD}$	Supply current into VDD pin	$V_{DD} = 1.5\text{ V} < V_{DD} < 10\text{ V}$ $V_{DD} > V_{IT+}$ <sup>(2)</sup> $T_A = -40^\circ\text{C to }125^\circ\text{C}$		300	700	nA
$V_{\overline{\text{MR}}_L}$	Manual reset logic low input <sup>(3)</sup>				600	mV
$V_{\overline{\text{MR}}_H}$	Manual reset logic high input <sup>(3)</sup>		$0.7V_{DD}$			V
$R_{\overline{\text{MR}}}$	Manual reset internal pull-up resistance			100		k $\Omega$
$R_{CT}$	CT pin internal resistance		350	500	650	k $\Omega$
<b>TPS3840PL (Push-Pull Active-Low)</b>						
$V_{POR}$	Power on Reset Voltage <sup>(4)</sup>	$V_{OL(max)} = 200\text{ mV}$ $I_{OUT(Sink)} = 200\text{ nA}$			300	mV
$V_{OL}$	Low level output voltage	$1.5\text{ V} < V_{DD} < 5\text{ V}$ $V_{DD} < V_{IT-}$ $I_{OUT(Sink)} = 2\text{ mA}$			200	mV
$V_{OH}$	High level output voltage	$1.5\text{ V} < V_{DD} < 5\text{ V}$ $V_{DD} > V_{IT+}$ <sup>(2)</sup> $I_{OUT(Source)} = 2\text{ mA}$	$0.8V_{DD}$			V
		$5\text{ V} < V_{DD} < 10\text{ V}$ $V_{DD} > V_{IT+}$ <sup>(2)</sup> $I_{OUT(Source)} = 5\text{ mA}$	$0.8V_{DD}$			V
<b>TPS3840PH (Push-Pull Active-High)</b>						
$V_{POR}$	Power on Reset Voltage <sup>(4)</sup>	$V_{OH}, I_{OUT(Source)} = 500\text{ nA}$			950	mV
$V_{OL}$	Low level output voltage	$1.5\text{ V} < V_{DD} < 5\text{ V}$ $V_{DD} > V_{IT+}$ <sup>(2)</sup> $I_{OUT(Sink)} = 2\text{ mA}$			200	mV
		$1.5\text{ V} < V_{DD} < 5\text{ V}$ $V_{DD} > V_{IT+}$ <sup>(2)</sup> $I_{OUT(Sink)} = 5\text{ mA}$			200	mV
$V_{OH}$	High level output voltage	$1.5\text{ V} < V_{DD} < 5\text{ V}, V_{DD} < V_{IT-},$ $I_{OUT(Source)} = 2\text{ mA}$	$0.8V_{DD}$			V
<b>TPS3840DL (Open-Drain)</b>						
$V_{POR}$	Power on Reset Voltage <sup>(4)</sup>	$V_{OL(max)} = 0.2\text{ V}$ $I_{OUT(Sink)} = 5.6\text{ uA}$			950	mV
$V_{OL}$	Low level output voltage	$1.5\text{ V} < V_{DD} < 5\text{ V}$ $V_{DD} < V_{IT-}$ $I_{OUT(Sink)} = 2\text{ mA}$			200	mV
$I_{lkg(OD)}$	Open-Drain output leakage current	$\overline{\text{RESET}}$ pin in High Impedance, $V_{DD} = V_{\text{RESET}} = 5.5\text{ V}$ $V_{IT+} < V_{DD}$			90	nA

(1)  $V_{IT-}$  threshold voltage range from 1.6 V to 4.9 V in 100 mV steps, for released versions see Device Voltage Thresholds table.

(2)  $V_{IT+} = V_{HYS} + V_{IT-}$ .

(3) If the logic signal driving  $\overline{\text{MR}}$  is less than VDD, then additional current flows into VDD and out of  $\overline{\text{MR}}$ .

(4)  $V_{POR}$  is the minimum  $V_{DD}$  voltage level for a controlled output state.  $V_{DD}$  slew rate  $\leq 100\text{ mV}/\mu\text{s}$ .

## 7.6 Timing Requirements

At  $1.5\text{ V} \leq V_{DD} \leq 10\text{ V}$ ,  $CT = \overline{MR} = \text{Open}$ ,  $\overline{RESET}$  pull-up resistor ( $R_{pull-up}$ ) = 100 k $\Omega$  to VDD, output reset load ( $C_{LOAD}$ ) = 10 pF and over the operating free-air temperature range – 40°C to 125°C, VDD slew rate < 100mV / us, unless otherwise noted. Typical values are at  $T_J = 25^\circ\text{C}$ .

PARAMETER		TEST CONDITIONS	MIN	TYP	MAX	UNIT
$t_{STRT}$	Startup Delay <sup>(1)</sup>	CT pin open	100	220	350	$\mu\text{s}$
$t_{P\_HL}$	Propagation detect delay for VDD falling below $V_{IT-}$	$V_{DD} = V_{IT+}$ to $(V_{IT-}) - 10\%$ <sup>(2)</sup>		15	30	$\mu\text{s}$
$t_D$	Reset time delay <sup>(3)</sup>	CT pin = open			50	$\mu\text{s}$
		CT pin = 10 nF		6.2		ms
		CT pin = 1 $\mu\text{F}$		619		ms
$t_{GL\_VIT-}$	Glitch immunity $V_{IT-}$	5% $V_{IT-}$ overdrive <sup>(4)</sup>		10		$\mu\text{s}$
$t_{MR\_PW}$	$\overline{MR}$ pin pulse duration to initiate reset			300		ns
$t_{MR\_RES}$	Propagation delay from $\overline{MR}$ low to reset	$V_{DD} = 4.5\text{ V}$ , $\overline{MR} < V_{MR\_L}$		700		ns
$t_{MR\_ID}$	Delay from release $\overline{MR}$ to deassert reset	$V_{DD} = 4.5\text{ V}$ , $\overline{MR} = V_{MR\_L}$ to $V_{MR\_H}$		$t_D$		ms

- (1) When VDD starts from less than the specified minimum  $V_{DD}$  and then exceeds  $V_{IT+}$ , reset is release after the startup delay ( $t_{STRT}$ ), a capacitor at CT pin will add  $t_D$  delay to  $t_{STRT}$  time
- (2)  $t_{P\_HL}$  measured from threshold trip point ( $V_{IT-}$ ) to  $V_{OL}$  for active low variants and  $V_{OH}$  for active high variants.
- (3) The MIN and MAX reset time delay with external capacitor depends on  $R_{CT}$  and is calculated using Equation 5 and Equation 6 in Section 8.3.2
- (4) Overdrive % =  $[(V_{DD} / V_{IT-}) - 1] \times 100\%$

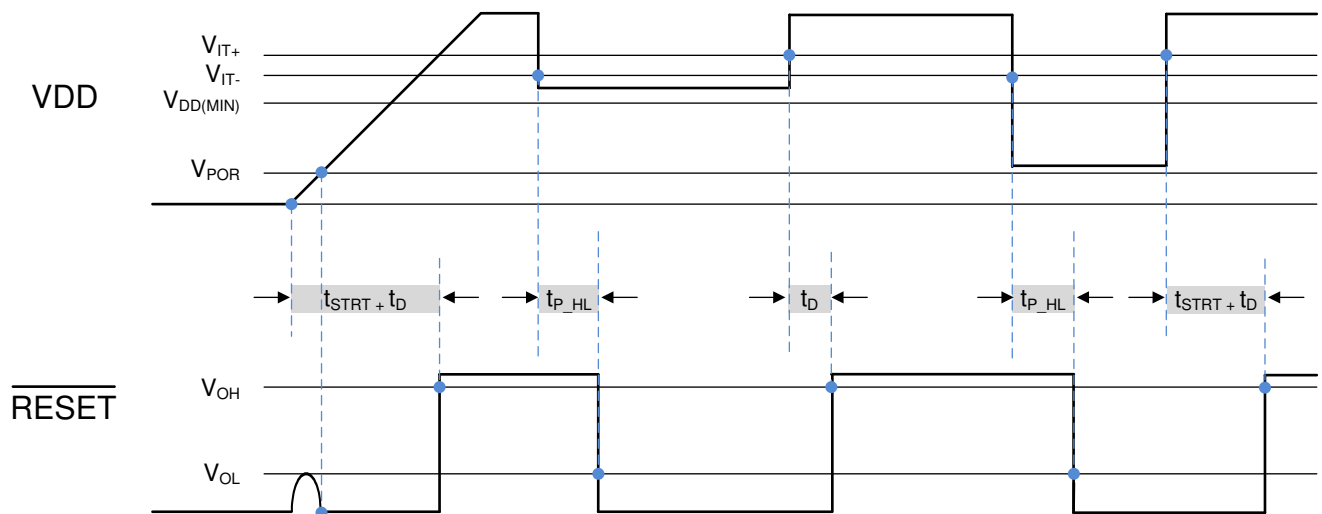

- (1)  $t_D$  (no cap) is included in  $t_{STRT}$  time delay. If  $t_D$  delay is programmed by an external capacitor connected to CT pin then  $t_D$  programmed time will be added to the startup time, VDD slew rate = 100 mV /  $\mu\text{s}$ .
- (2) Open-Drain timing diagram assumes pull-up resistor is connected to  $\overline{RESET}$

Figure 4. Timing Diagram TPS3840DL-Q1 (Open-Drain Active-Low)



- (3)  $t_{D (no\ cap)}$  is included in  $t_{STRT}$  time delay. If  $t_D$  delay is programmed by an external capacitor connected to CT pin, then  $t_D$  programmed time will be added to the startup time. VDD slew rate = 100 mV /  $\mu$ s.

**Figure 5. Timing Diagram TPS3840PL-Q1 (Push-Pull Active-Low)**



- (4)  $t_{D (no\ cap)}$  is included in  $t_{STRT}$  time delay. If  $t_D$  delay is programmed by an external capacitor connected to CT pin, then  $t_D$  programmed time will be added to the total startup time. VDD slew rate = 100 mV /  $\mu$ s.

**Figure 6. Timing Diagram TPS3840PH-Q1 (Push-Pull Active-High)**

### 7.7 Typical Characteristics

Typical characteristics show the typical performance of the TPS3840-Q1 device. Test conditions are  $T_J = 25^\circ\text{C}$ ,  $V_{DD} = 3.3\text{ V}$ ,  $R_{\text{pull-up}} = 100\text{ k}\Omega$ ,  $C_{\text{Load}} = 50\text{ pF}$ , unless otherwise noted.

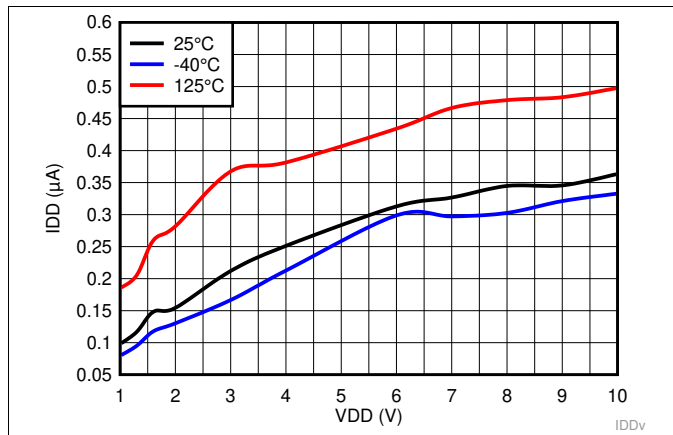

Figure 7. Supply Current vs Supply Voltage for TPS3840DL49-Q1

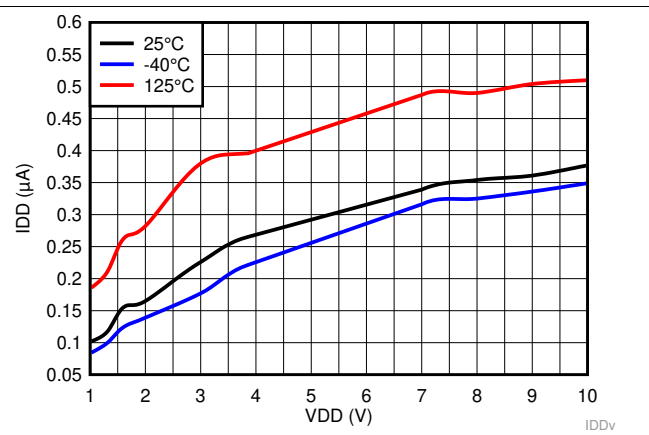

Figure 8. Supply Current vs Supply Voltage for TPS3840PL49-Q1

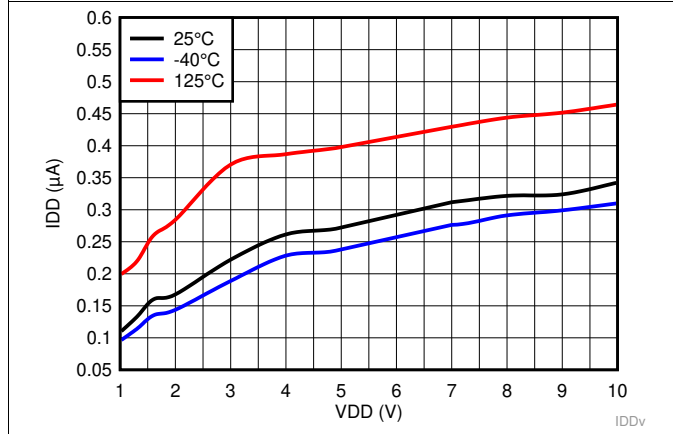

Figure 9. Supply Current vs Supply Voltage for TPS3840PH49-Q1

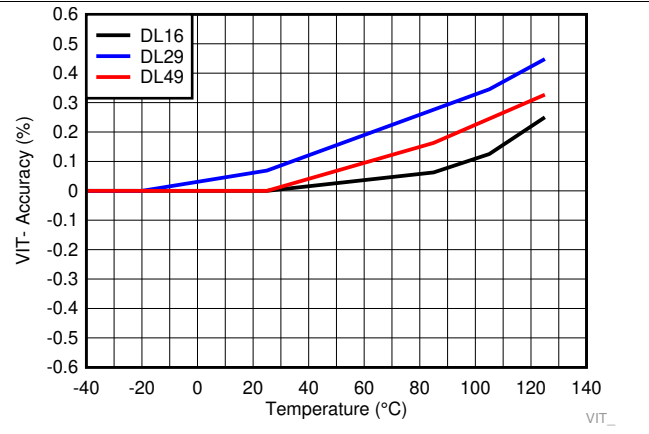

Figure 10. Negative-going Input Threshold Accuracy over Temperature for TPS3840DL-Q1

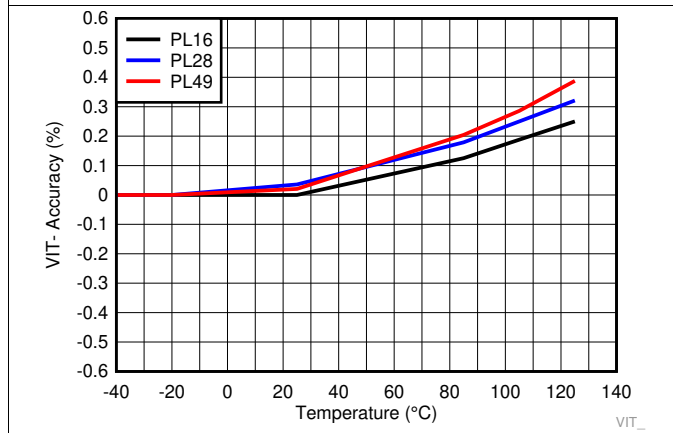

Figure 11. Negative-going Input Threshold Accuracy over Temperature for TPS3840PL-Q1

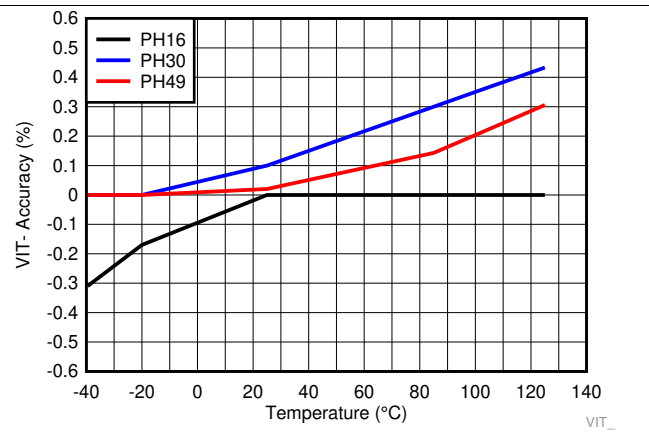

Figure 12. Negative-going Input Threshold Accuracy over Temperature for TPS3840PH-Q1

### Typical Characteristics (continued)

Typical characteristics show the typical performance of the TPS3840-Q1 device. Test conditions are  $T_J = 25^\circ\text{C}$ ,  $V_{DD} = 3.3\text{ V}$ ,  $R_{\text{pull-up}} = 100\text{ k}\Omega$ ,  $C_{\text{Load}} = 50\text{ pF}$ , unless otherwise noted.

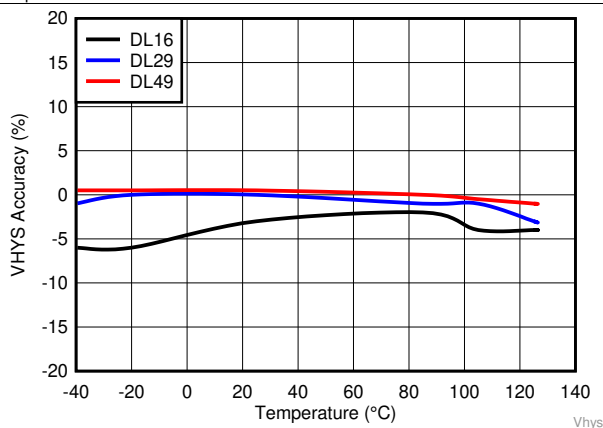

Figure 13. Input Threshold  $V_{IT}$ . Hysteresis Accuracy for TPS3840DL-Q1

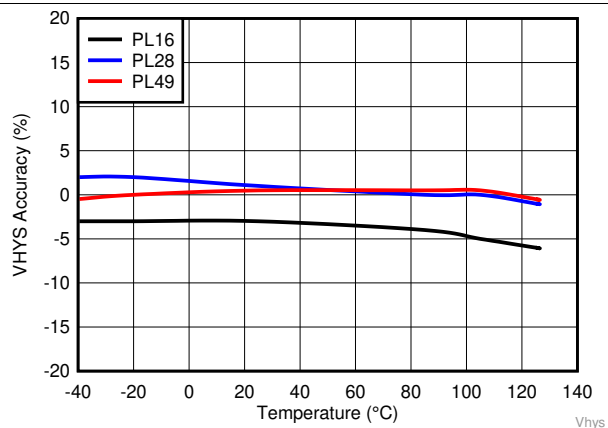

Figure 14. Input Threshold  $V_{IT}$ . Hysteresis Accuracy for TPS3840PL-Q1

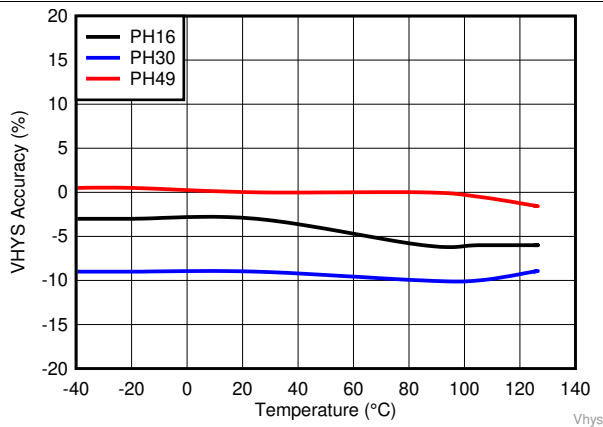

Figure 15. Input Threshold  $V_{IT}$ . Hysteresis Accuracy for TPS3840PH-Q1

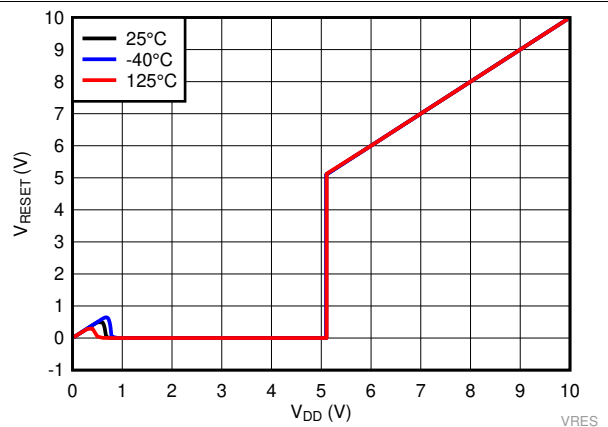

Figure 16. Output Voltage vs Input Voltage for TPS3840DL49-Q1

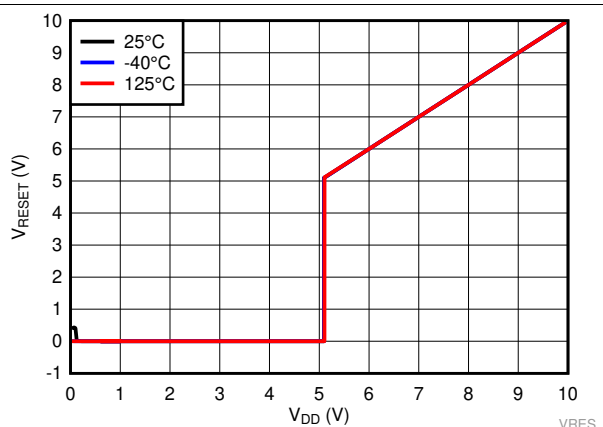

Figure 17. Output Voltage vs Input Voltage for TPS3840PL49-Q1

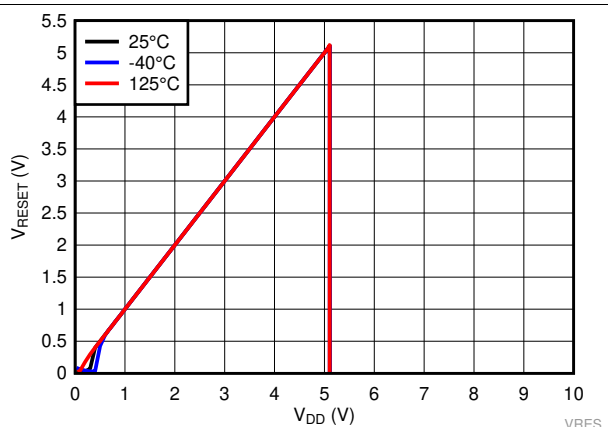

Figure 18. Output Voltage vs Input Voltage for TPS3840PH49-Q1

### Typical Characteristics (continued)

Typical characteristics show the typical performance of the TPS3840-Q1 device. Test conditions are  $T_J = 25^\circ\text{C}$ ,  $V_{DD} = 3.3\text{ V}$ ,  $R_{\text{pull-up}} = 100\text{ k}\Omega$ ,  $C_{\text{Load}} = 50\text{ pF}$ , unless otherwise noted.

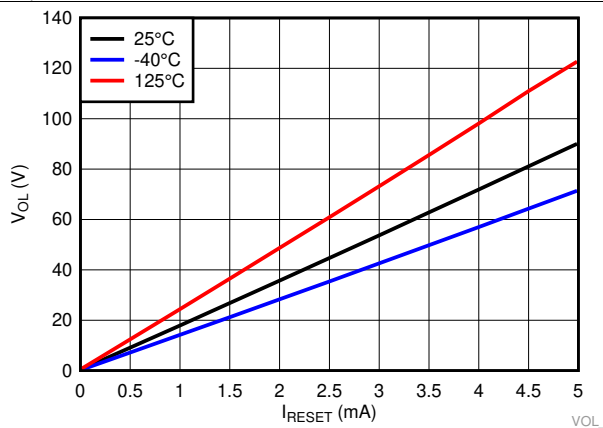

Figure 19. Low Level Output Voltage vs  $I_{\text{RESET}}$  for TPS3840DL49-Q1

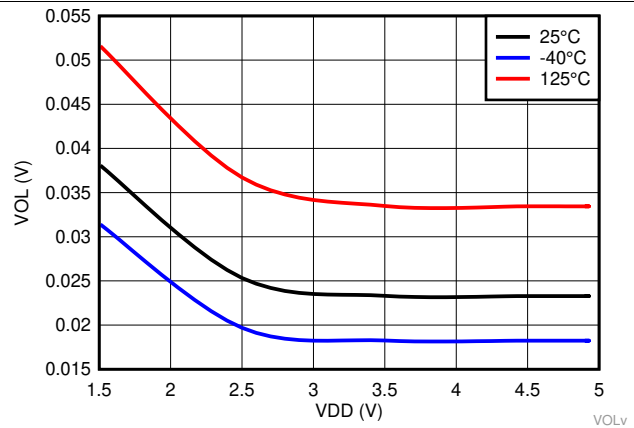

Figure 20. Low Level Output Voltage vs  $V_{DD}$  for TPS3840DL49-Q1

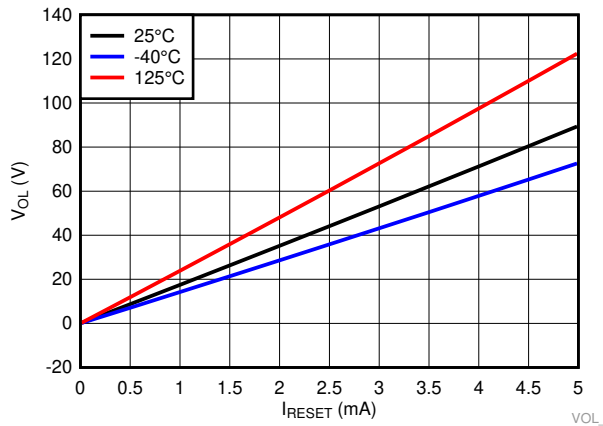

Figure 21. Low Level Output Voltage vs  $I_{\text{RESET}}$  for TPS3840PL49-Q1

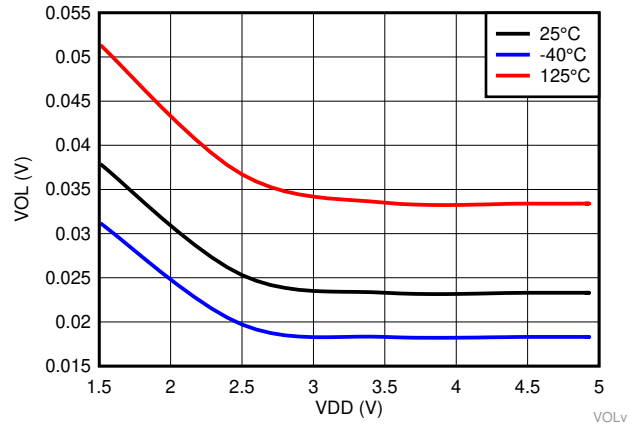

Figure 22. Low Level Output Voltage vs  $V_{DD}$  for TPS3840PL49-Q1

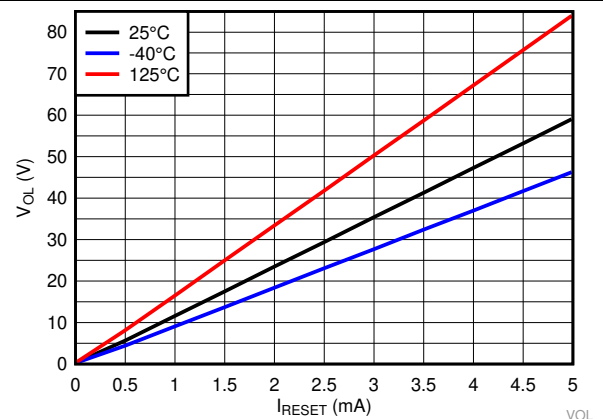

Figure 23. Low Level Output Voltage vs  $I_{\text{RESET}}$  for TPS3840PH49-Q1

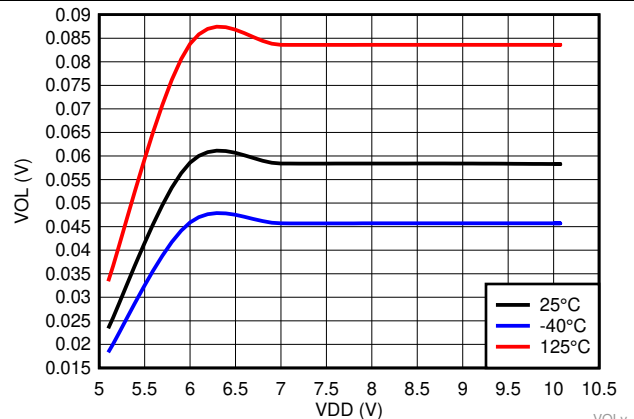

Figure 24. Low Level Output Voltage vs  $V_{DD}$  for TPS3840PH49-Q1

### Typical Characteristics (continued)

Typical characteristics show the typical performance of the TPS3840-Q1 device. Test conditions are  $T_J = 25^\circ\text{C}$ ,  $V_{DD} = 3.3\text{ V}$ ,  $R_{\text{pull-up}} = 100\text{ k}\Omega$ ,  $C_{\text{Load}} = 50\text{ pF}$ , unless otherwise noted.



Figure 25. High Level Output Voltage vs  $I_{\text{RESET}}$  for TPS3840PL49-Q1



Figure 26. High Level Output Voltage over Temperature for TPS3840PL49-Q1



Figure 27. High Level Output Voltage vs  $I_{\text{RESET}}$  for TPS3840PH49-Q1



Figure 28. High Level Output Voltage Over Temperature for TPS3840PH49-Q1



Figure 29. Manual Reset Logic Low Voltage Threshold Over Temperature for TPS3840DL-Q1



Figure 30. Manual Reset Logic Low Voltage Threshold Over Temperature for TPS3840PL-Q1

### Typical Characteristics (continued)

Typical characteristics show the typical performance of the TPS3840-Q1 device. Test conditions are  $T_J = 25^\circ\text{C}$ ,  $V_{DD} = 3.3\text{ V}$ ,  $R_{\text{pull-up}} = 100\text{ k}\Omega$ ,  $C_{\text{Load}} = 50\text{ pF}$ , unless otherwise noted.

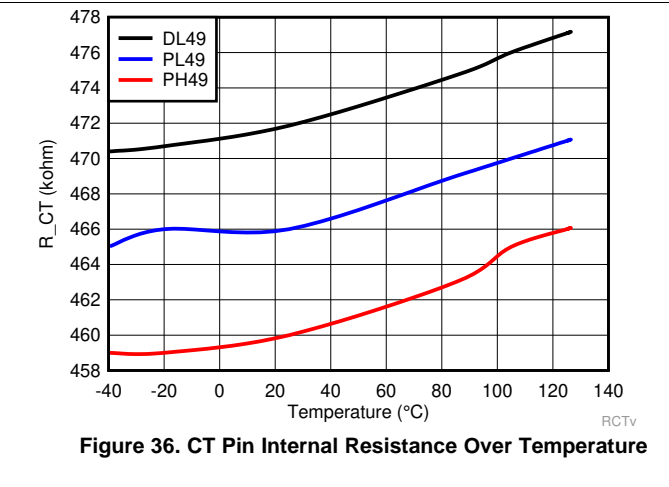
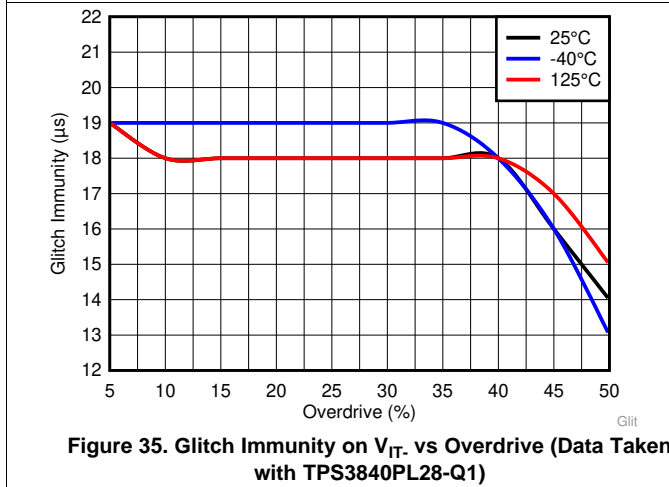
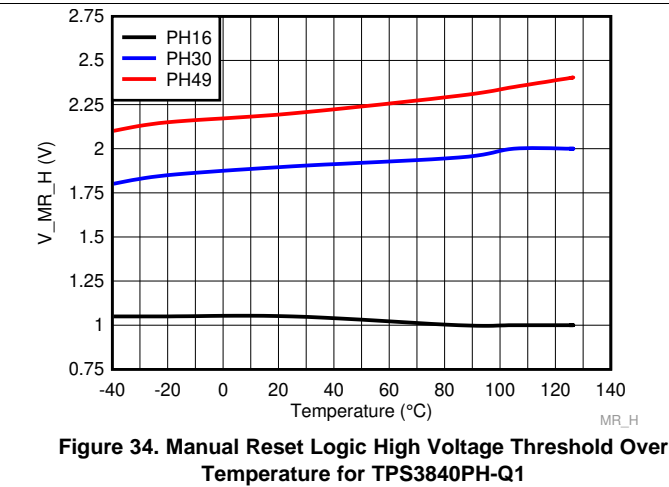
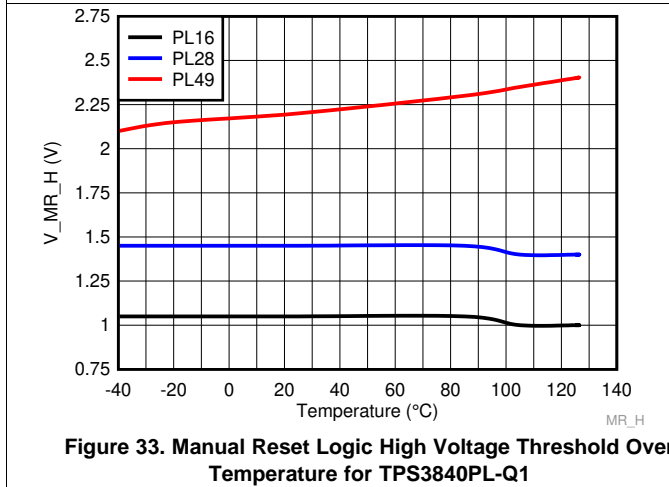
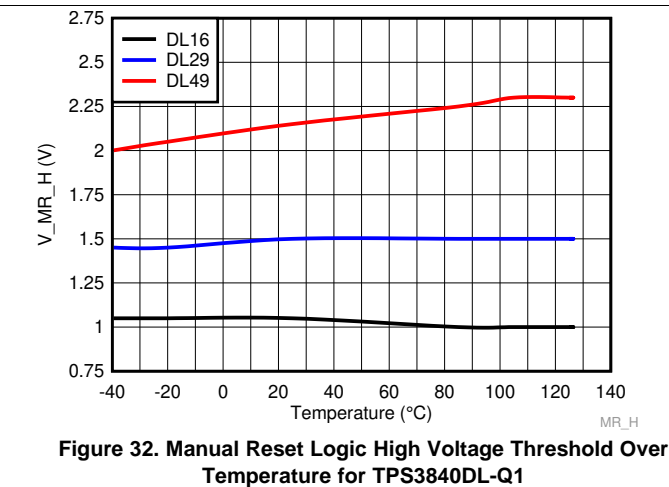
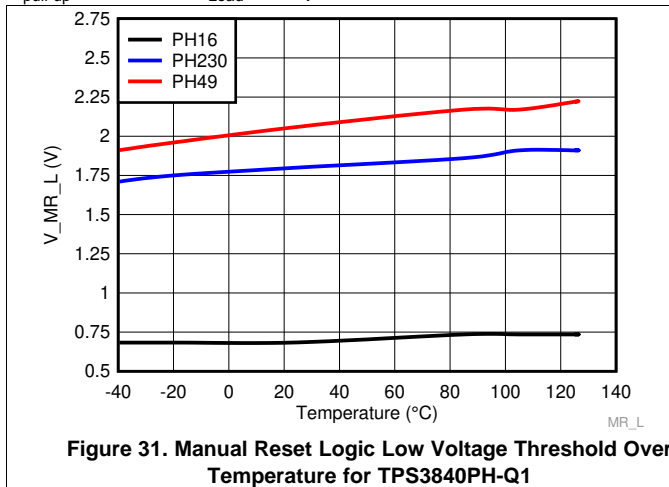

### Typical Characteristics (continued)

Typical characteristics show the typical performance of the TPS3840-Q1 device. Test conditions are  $T_J = 25^\circ\text{C}$ ,  $V_{DD} = 3.3\text{ V}$ ,  $R_{\text{pull-up}} = 100\text{ k}\Omega$ ,  $C_{\text{Load}} = 50\text{ pF}$ , unless otherwise noted.

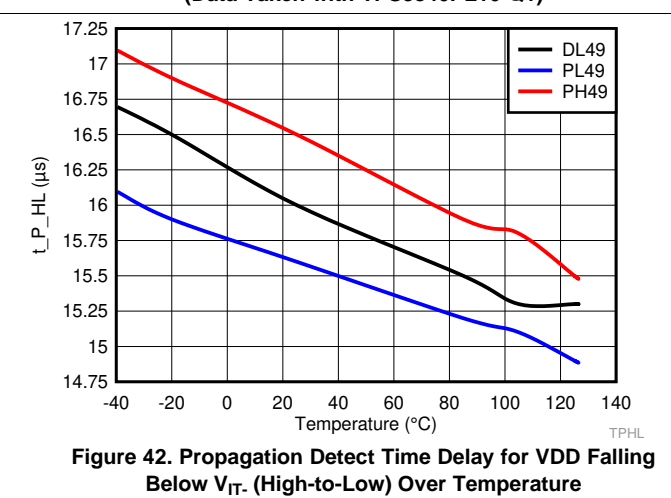
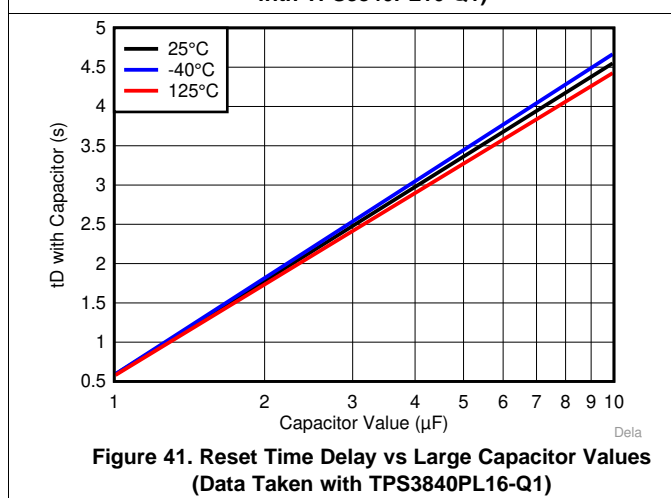
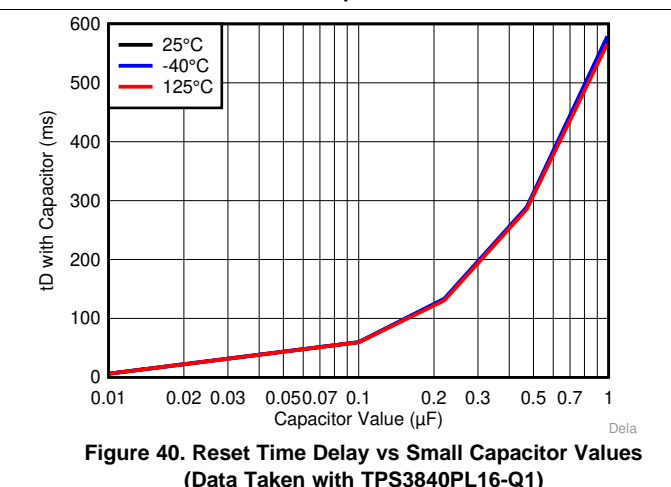
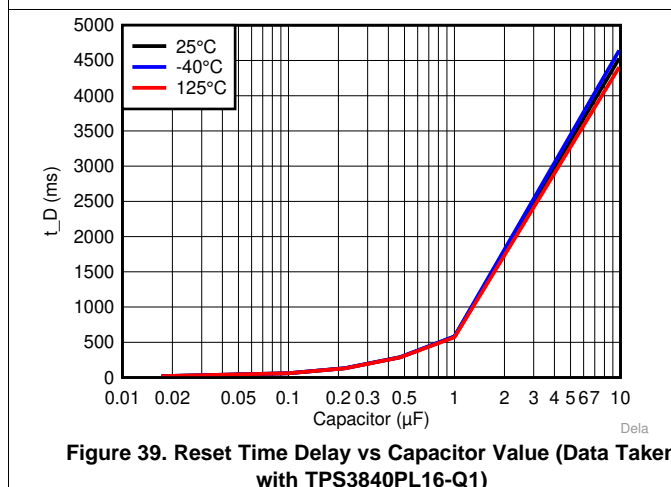
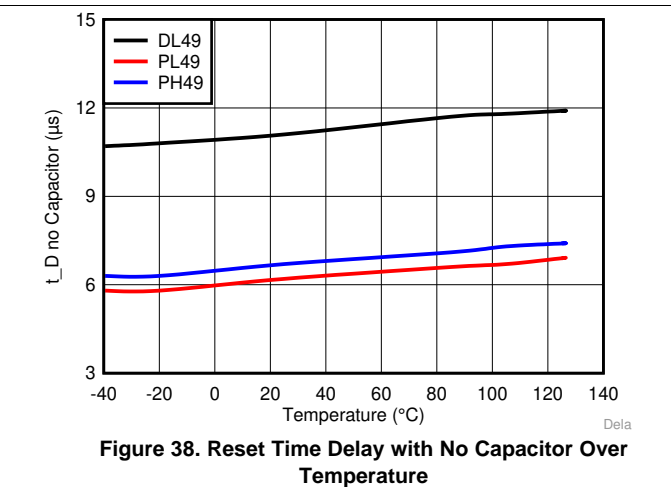
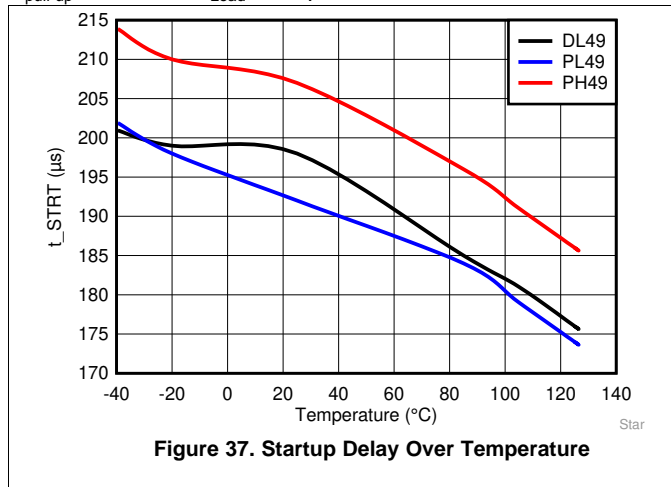

### Typical Characteristics (continued)

Typical characteristics show the typical performance of the TPS3840-Q1 device. Test conditions are  $T_J = 25^\circ\text{C}$ ,  $V_{DD} = 3.3\text{ V}$ ,  $R_{\text{pull-up}} = 100\text{ k}\Omega$ ,  $C_{\text{Load}} = 50\text{ pF}$ , unless otherwise noted.

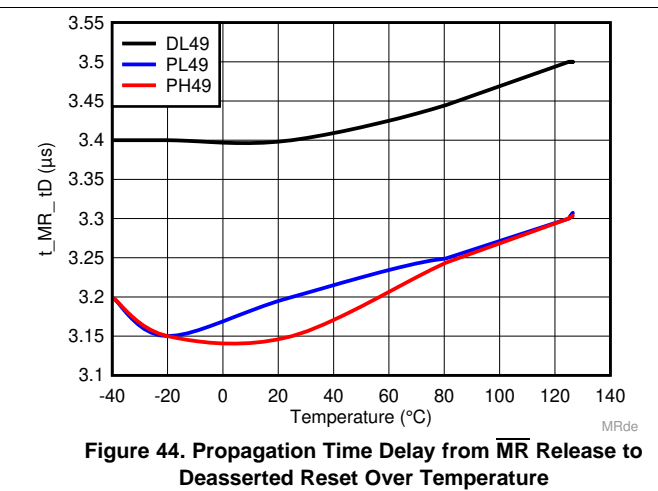
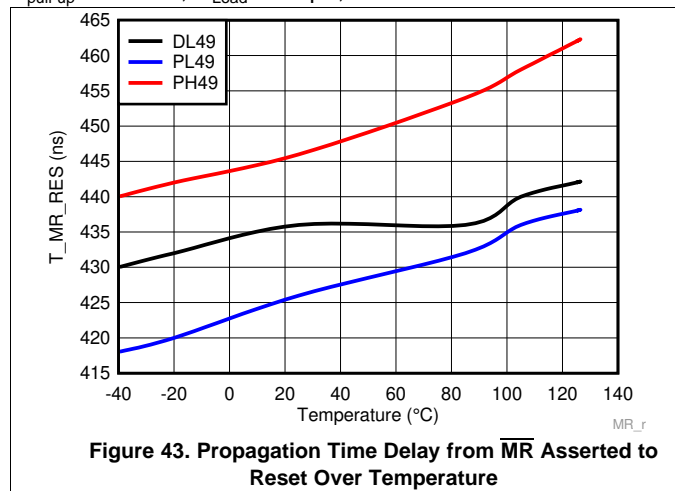

## 8 Detailed Description

### 8.1 Overview

The TPS3840-Q1 is a family of wide VDD and nano-quiescent current voltage detectors with fixed threshold voltage. TPS3840-Q1 features include programmable reset time delay using external capacitor, active-low manual reset, 1% typical monitor threshold accuracy with hysteresis and glitch immunity.

Fixed negative threshold voltages ( $V_{IT-}$ ) can be factory set from 1.6 V to 4.9 V (see [Table 3](#) for available options). TPS3840-Q1 is available in SOT-23 5 pin industry standard package.

### 8.2 Functional Block Diagram

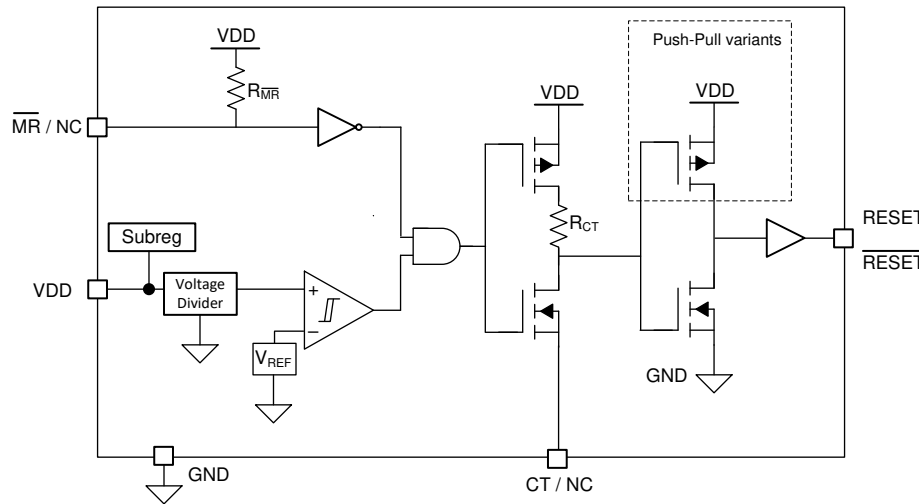

Copyright © 2019, Texas Instruments Incorporated

### 8.3 Feature Description

#### 8.3.1 Input Voltage (VDD)

VDD pin is monitored by the internal comparator to indicate when VDD falls below the fixed threshold voltage. VDD also functions as the supply for the internal bandgap, internal regulator, state machine, buffers and other control logic blocks. Good design practice involve placing a 0.1 uF to 1 uF bypass capacitor at VDD input for noisy applications to ensure enough charge is available for the device to power up correctly.

## Feature Description (continued)

### 8.3.1.1 VDD Hysteresis

The internal comparator has built-in hysteresis to avoid erroneous output reset release. If the voltage at the VDD pin falls below  $V_{IT-}$ , the output reset is asserted. When the voltage at the VDD pin goes above  $V_{IT-}$  plus hysteresis ( $V_{HYS}$ ) the output reset is deasserted after  $t_D$  delay.



Figure 45. Hysteresis Diagram

### 8.3.1.2 VDD Transient Immunity

The TPS3840-Q1 is immune to quick voltage transients or excursion on VDD. Sensitivity to transients depends on both pulse duration and overdrive. Overdrive is defined by how much VDD deviates from the specified threshold. Threshold overdrive is calculated as a percent of the threshold in question, as shown in Equation 1.

$$\text{Overdrive} = | (V_{DD} / V_{IT-} - 1) \times 100\% | \quad (1)$$



Figure 46. Overdrive vs Pulse Duration

### 8.3.2 User-Programmable Reset Time Delay

The reset time delay can be set to a minimum value of 50  $\mu\text{s}$  by leaving the CT pin floating, or a maximum value of approximately 6.2 seconds by connecting 10  $\mu\text{F}$  delay capacitor. The reset time delay ( $t_D$ ) can be programmed by connecting a capacitor no larger than 10  $\mu\text{F}$  between CT pin and GND.

The relationship between external capacitor ( $C_{CT\_EXT}$ ) in F at CT pin and the time delay ( $t_D$ ) in seconds is given by Equation 2.

$$t_D = -\ln(0.29) \times R_{CT} \times C_{CT\_EXT} + t_D(\text{no cap}) \quad (2)$$

Equation 2 is simplified to Equation 3 by plugging  $R_{CT}$  and  $t_{D(\text{no cap})}$  given in [Electrical Characteristics](#) section:

$$t_D = 618937 \times C_{CT\_EXT} + 50 \mu\text{s} \quad (3)$$

Equation 4 solves for external capacitor value ( $C_{CT\_EXT}$ ) in units of F where  $t_D$  is in units of seconds

$$C_{CT\_EXT} = (t_D - 50 \mu\text{s}) \div 618937 \quad (4)$$

The reset delay varies according to three variables: the external capacitor variance ( $C_{CT}$ ), CT pin internal resistance ( $R_{CT}$ ) provided in the [Electrical Characteristics](#) table, and a constant. The minimum and maximum variance due to the constant is shown in [Equation 5](#) and [Equation 6](#).

$$s t_D(\text{minimum}) = -\ln(0.36) \times R_{CT(\text{min})} \times C_{CT(\text{min})} + t_D(\text{no cap, min}) \quad (5)$$

$$t_D(\text{maximum}) = -\ln(0.26) \times R_{CT(\text{max})} \times C_{CT(\text{max})} + t_D(\text{no cap, max}) \quad (6)$$

## Feature Description (continued)

The recommended maximum delay capacitor for the TPS3840 is limited to 10  $\mu\text{F}$  as this ensures there is enough time for the capacitor to fully discharge when the reset condition occurs. When a voltage fault occurs, the previously charged up capacitor discharges, and if the monitored voltage returns from the fault condition before the delay capacitor discharges completely, the delay capacitor will begin charging from a voltage above zero and the reset delay will be shorter than expected. Larger delay capacitors can be used so long as the capacitor has enough time to fully discharge during the duration of the voltage fault.

### 8.3.3 Manual Reset ( $\overline{\text{MR}}$ ) Input

The manual reset ( $\overline{\text{MR}}$ ) input allows a processor GPIO or other logic circuits to initiate a reset. A logic low on  $\overline{\text{MR}}$  with pulse duration longer than  $t_{\overline{\text{MR\_RES}}}$  will causes reset output to assert. After  $\overline{\text{MR}}$  returns to a logic high ( $V_{\overline{\text{MR\_H}}}$ ) and VDD is above  $V_{\text{IT+}}$ , reset is deasserted after the user programmed reset time delay ( $t_{\text{D}}$ ) expires.

If  $\overline{\text{MR}}$  is not controlled externally, then  $\overline{\text{MR}}$  can be left disconnected. If the logic signal controlling  $\overline{\text{MR}}$  is less than VDD, then additional current flows from VDD into  $\overline{\text{MR}}$  internally. For minimum current consumption, drive  $\overline{\text{MR}}$  to either VDD or GND.  $V_{\overline{\text{MR}}}$  must not be higher than VDD voltage.

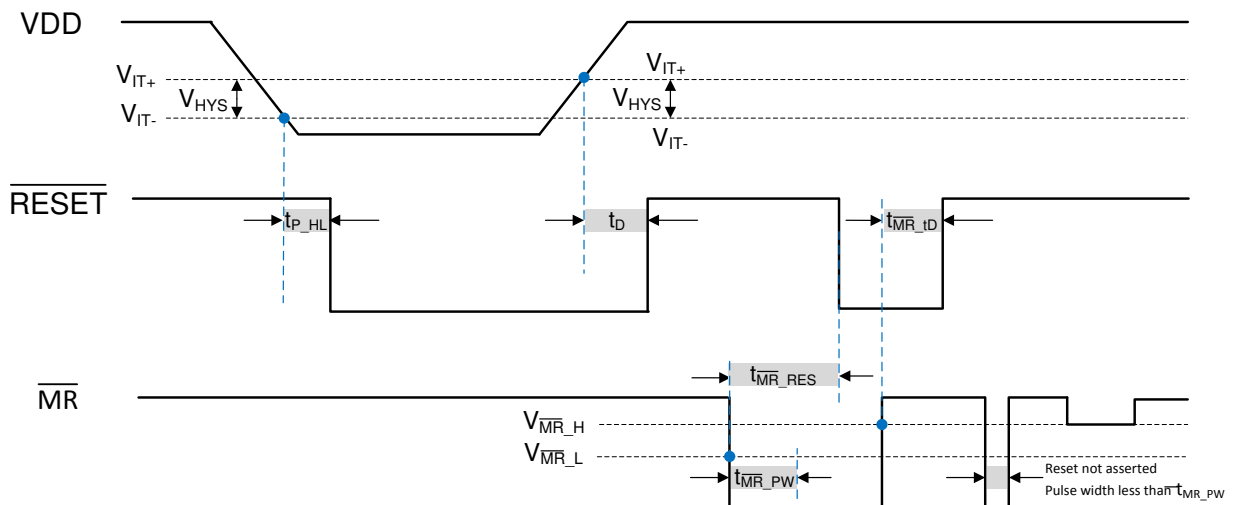

Figure 47. Timing Diagram  $\overline{\text{MR}}$  and  $\overline{\text{RESET}}$  (TPS3840DL-Q1)

### 8.3.4 Output Logic

#### 8.3.4.1 $\overline{\text{RESET}}$ Output, Active-Low

$\overline{\text{RESET}}$  (Active-Low) applies to TPS3840DL-Q1 (Open-Drain) and TPS3840PL-Q1 (Push-Pull) hence the "L" in the device name.  $\overline{\text{RESET}}$  remains high (deasserted) as long as VDD is above the negative threshold ( $V_{\text{IT-}}$ ) and the  $\overline{\text{MR}}$  pin is floating or above  $V_{\overline{\text{MR\_H}}}$ . If VDD falls below the negative threshold ( $V_{\text{IT-}}$ ) or if  $\overline{\text{MR}}$  is driven low, then  $\overline{\text{RESET}}$  is asserted.

When  $\overline{\text{MR}}$  is again logic high or floating and VDD rise above  $V_{\text{IT+}}$ , the delay circuit will hold  $\overline{\text{RESET}}$  low for the specified reset time delay ( $t_{\text{D}}$ ). When the reset time delay has elapsed, the  $\overline{\text{RESET}}$  pin goes back to logic high voltage ( $V_{\text{OH}}$ ).

The TPS3840DL-Q1 (Open-Drain) version, denoted with "D" in the device name, requires a pull-up resistor to hold  $\overline{\text{RESET}}$  pin high. Connect the pull-up resistor to the desired pull-up voltage source and  $\overline{\text{RESET}}$  can be pulled up to any voltage up to 10 V independent of the VDD voltage. To ensure proper voltage levels, give some consideration when choosing the pull-up resistor values. The pull-up resistor value determines the actual  $V_{\text{OL}}$ , the output capacitive loading, and the output leakage current ( $I_{\text{LKG(OD)}}$ ).

The Push-Pull variants (TPS3840PL and TPS3840PH), denoted with "P" in the device name, does not require a pull-up resistor.

## Feature Description (continued)

### 8.3.4.2 RESET Output, Active-High

RESET (active-high), denoted with no bar above the pin label, applies only to TPS3840PH-Q1 push-pull active-high version.  $\overline{\text{RESET}}$  remains low (deasserted) as long as VDD is above the threshold ( $V_{\text{IT-}}$ ) and the manual reset signal (MR) is logic high or floating. If VDD falls below the negative threshold ( $V_{\text{IT-}}$ ) or if MR is driven low, then RESET is asserted driving the RESET pin to high voltage ( $V_{\text{OH}}$ ).

When  $\overline{\text{MR}}$  is again logic high and VDD is above  $V_{\text{IT+}}$ , the delay circuit will hold RESET high for the specified reset time delay ( $t_{\text{D}}$ ). When the reset time delay has elapsed, the RESET pin goes back to low voltage ( $V_{\text{OL}}$ ).

## 8.4 Device Functional Modes

Table 1 summarizes the various functional modes of the device. Logic high is represented by "H" and logic low is represented by "L".

**Table 1. Truth Table**

VDD	$\overline{\text{MR}}$	RESET	$\overline{\text{RESET}}$
$V_{\text{DD}} < V_{\text{POR}}$	Ignored	Undefined	Undefined
$V_{\text{POR}} < V_{\text{DD}} < V_{\text{IT-}}$ <sup>(1)</sup>	Ignored	H	L
$V_{\text{DD}} \geq V_{\text{IT-}}$	L	H	L
$V_{\text{DD}} \geq V_{\text{IT-}}$	H	L	H
$V_{\text{DD}} \geq V_{\text{IT-}}$	Floating	L	H

(1) When  $V_{\text{DD}}$  falls below  $V_{\text{DD(MIN)}}$ , undervoltage-lockout (UVLO) takes effect and output reset is held asserted until  $V_{\text{DD}}$  falls below  $V_{\text{POR}}$ .

### 8.4.1 Normal Operation ( $V_{\text{DD}} > V_{\text{DD(min)}}$ )

When VDD is greater than  $V_{\text{DD(min)}}$ , the reset signal is determined by the voltage on the VDD pin with respect to the trip point ( $V_{\text{IT-}}$ ) and the logic state of  $\overline{\text{MR}}$ .

- $\overline{\text{MR}}$  high: the reset signal corresponds to VDD with respect to the threshold voltage.
- $\overline{\text{MR}}$  low: in this mode, the reset is asserted regardless of the threshold voltage.

### 8.4.2 VDD Between VPOR and $V_{\text{DD(min)}}$

When the voltage on VDD is less than the  $V_{\text{DD(min)}}$  voltage, and greater than the power-on-reset voltage ( $V_{\text{POR}}$ ), the reset signal is asserted.

### 8.4.3 Below Power-On-Reset ( $V_{\text{DD}} < V_{\text{POR}}$ )

When the voltage on VDD is lower than  $V_{\text{POR}}$ , the device does not have enough bias voltage to internally pull the asserted output low or high and reset voltage level is undefined.

## 9 Application and Implementation

### NOTE

Information in the following applications sections is not part of the TI component specification, and TI does not warrant its accuracy or completeness. TI's customers are responsible for determining suitability of components for their purposes. Customers should validate and test their design implementation to confirm system functionality.

### 9.1 Application Information

The following sections describe in detail how to properly use this device, depending on the requirements of the final application.

### 9.2 Typical Application

#### 9.2.1 Design 1: Dual Rail Monitoring with Power-Up Sequencing

A typical application for the TPS3840-Q1 is voltage rail monitoring and power-up sequencing as shown in Figure 48. The TPS3840-Q1 can be used to monitor any rail above 1.6 V. In this design application, two TPS3840-Q1 devices monitor two separate voltage rails and sequences the rails upon power-up. The TPS3840PL30-Q1 is used to monitor the 3.3-V main power rail and the TPS3840DL16-Q1 is used to monitor the 1.8-V rail provided by the LDO for other system peripherals. The RESET output of the TPS3840PL30-Q1 is connected to the ENABLE input of the LDO. A reset event is initiated on either voltage supervisor when the VDD voltage is less than  $V_{IT}$ , or when MR is driven low by an external source.

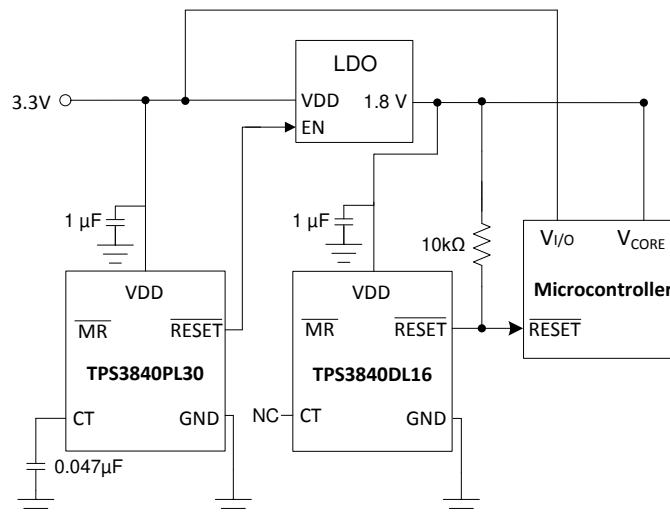

**Figure 48. TPS3840-Q1 Voltage Rail Monitor and Power-Up Sequencer Design Block Diagram**

#### 9.2.1.1 Design Requirements

This design requires voltage supervision on two separate rails: 3.3-V and 1.8-V rails. The voltage rail needs to sequence upon power up with the 3.3-V rail coming up first followed by the 1.8-V rail at least 25 ms after.

PARAMETER	DESIGN REQUIREMENT	DESIGN RESULT
Two Rail Voltage Supervision	Monitor 3.3-V and 1.8-V rails	Two TPS3840-Q1 devices provide voltage monitoring with 1% accuracy with device options available in 0.1 V variations
Voltage Rail Sequencing	Power up the 3.3-V rail first followed by 1.8-V rail 25 ms after	The CT capacitor on TPS38240PL28 is set to 0.047 µF for a reset time delay of 29 ms typical
Output logic voltage	3.3-V Open-Drain	3.3-V Open-Drain
Maximum device current consumption	1 µA	Each TPS3840-Q1 requires 350 nA typical

### 9.2.1.2 Detailed Design Procedure

The primary constraint for this application is choosing the correct device to monitor the supply voltage of the microprocessor. The TPS3840-Q1 can monitor any voltage between 1.6 V and 10 V and is available in 0.1 V increments. Depending on how far away from the nominal voltage rail the user wants the voltage supervisor to trigger determines the correct voltage supervisor variant to choose. In this example, the first TPS3840-Q1 triggers when the 3.3-V rail falls to 3.0 V. The second TPS3840-Q1 triggers a reset when the 1.8-V rail falls to 1.6 V. The secondary constraint for this application is the reset time delay that must be at least 25 ms to allow the microprocessor, and all other devices using the 3.3-V rail, enough time to startup correctly before the 1.8-V rail is enabled via the LDO. Because a minimum time is required, the user must account for capacitor tolerance. For applications with ambient temperatures ranging from  $-40^{\circ}\text{C}$  to  $+125^{\circ}\text{C}$ ,  $C_{CT}$  can be calculated using  $R_{CT}$  and solving for  $C_{CT}$  in Equation 2. Solving Equation 2 for 25 ms gives a minimum capacitor value of  $0.04\ \mu\text{F}$  which is rounded up to a standard value  $0.047\ \mu\text{F}$  to account for capacitor tolerance.

A  $1\text{-}\mu\text{F}$  decoupling capacitor is connected to the VDD pin as a good analog design practice. The pull-up resistor is only required for the Open-Drain device variants and is calculated to maintain the  $\overline{\text{RESET}}$  current within the  $\pm 5\ \text{mA}$  limit found in the *Recommended Operating Conditions*:  $R_{\text{Pull-up}} = V_{\text{Pull-up}} \div 5\ \text{mA}$ . For this design, a standard  $10\text{-k}\Omega$  pull-up resistor is selected to minimize current draw when  $\overline{\text{RESET}}$  is asserted. Keep in mind the lower the pull-up resistor, the higher  $V_{\text{OL}}$ . The  $\overline{\text{MR}}$  pin can be connected to an external signal if desired or left floating if not used due to the internal pull-up resistor to VDD.

### 9.2.1.3 Application Curves

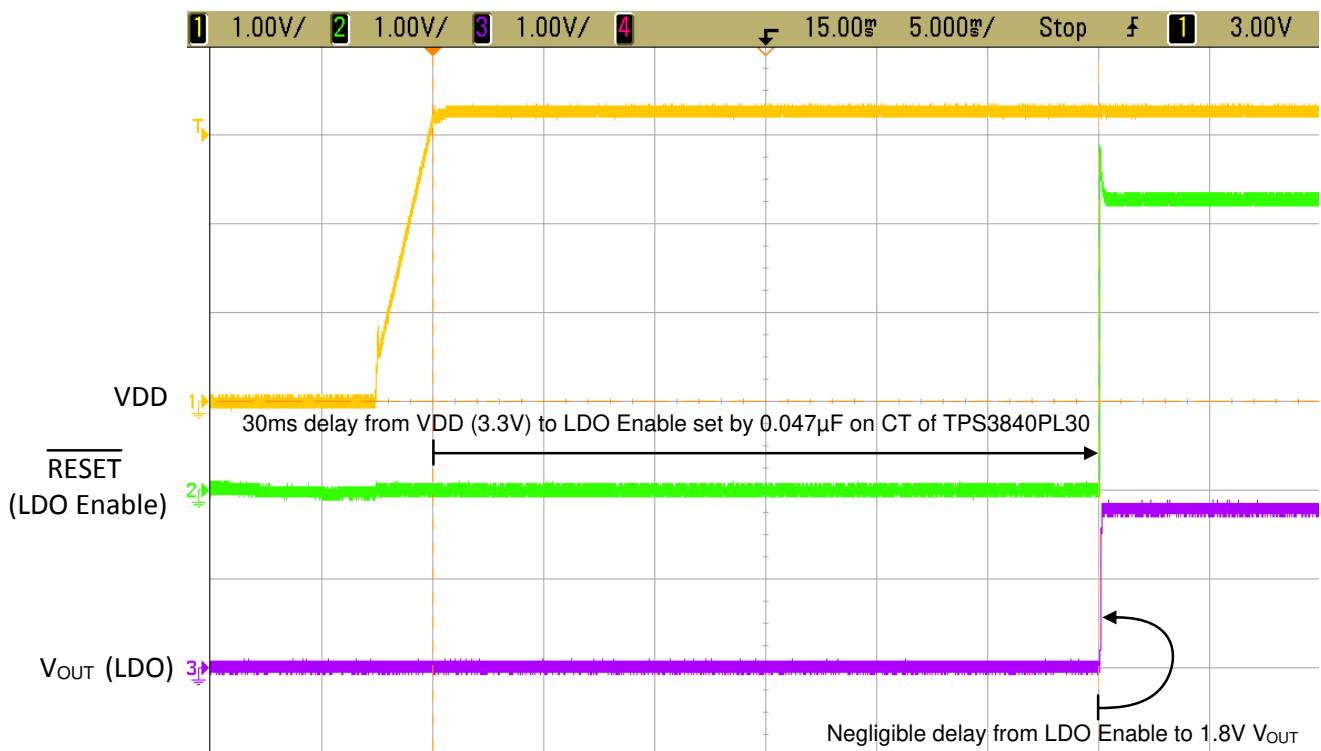
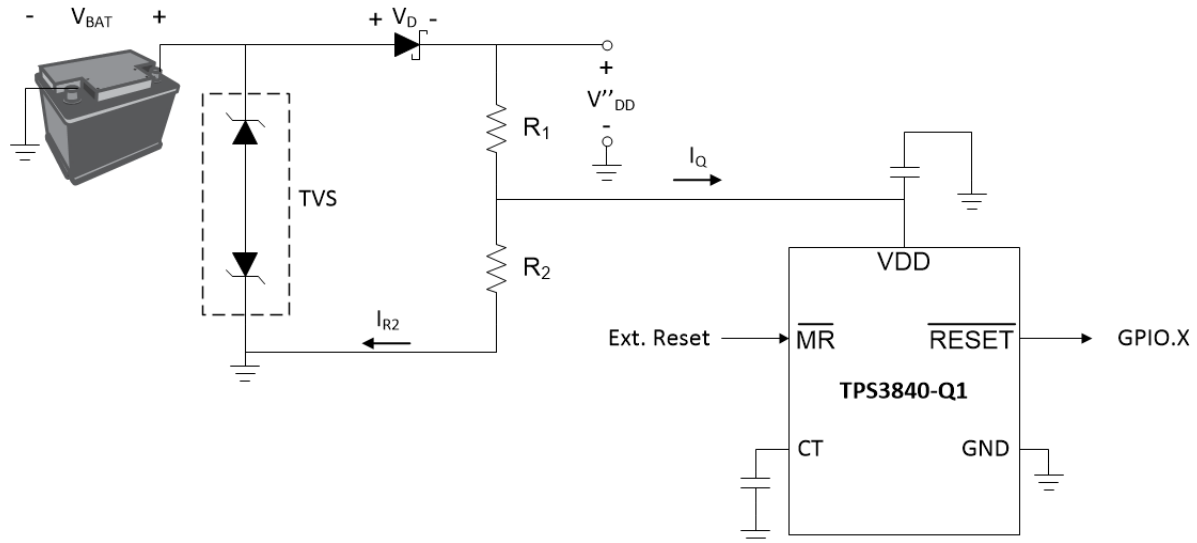

Figure 49. Startup Sequence Highlighting the Delay Between 3.3V and 1.8V Rails

## 9.2.2 Design 2: Automotive Off-Battery Monitoring

The initial power stage in automotive applications starts with the 12 V battery. Variation of the battery voltage is common between 9 V and 16 V. Furthermore, if cold-cranking and load dump conditions are considered, voltage transients can occur as low as 3 V and as high as 42V. In this design example, we are highlighting the ability for low power, direct off-battery voltage supervision. [Figure 50](#) illustrates an example of how the TPS3840-Q1 is monitoring the battery voltage while being powered by it as well. For more information, read this [application report](#) on how to achieve nano-amp  $I_Q$  voltage supervision in automotive, wide-vin applications.



**Figure 50. Fast Start Undervoltage Supervisor with Level-Shifted Input**

### 9.2.2.1 Design Requirements

This design requires voltage supervision on a 12-V power supply voltage rail with possibility of the 12-V rail rising up as high as 42 V. The undervoltage fault occurs when the power supply voltage drops below 7.7 V.

PARAMETER	DESIGN REQUIREMENT	DESIGN RESULT
Power Rail Voltage Supervision	Monitor 12-V power supply for undervoltage condition, trigger a undervoltage fault at 7.7 V.	TPS3840-Q1 provides voltage monitoring with 1% accuracy with device options available in 0.1 V variations. Resistor dividers are calculated based on device variant and desired threshold voltage.
Maximum Input Power	Operate with power supply input up to 42 V.	The TPS3840-Q1 limits VDD to 10 V but can monitor voltages higher than the maximum VDD voltage with the use of an external resistor divider.
Output logic voltage	Open-Drain Output Topology	Due to large variance in battery voltage, an open-drain output is recommended to provide the correct reset signal.
Maximum system current consumption	35 uA when power supply is at 12 V typical	TPS3840-Q1 requires 350 nA (typical) and the external resistor divider will also consume current. There is a tradeoff between current consumption and voltage monitor accuracy but generally set the resistor divider to consume 100 times current into VDD.
Voltage Monitor Accuracy	Typical voltage monitor accuracy of 2.5%.	The TPS3840-Q1 has 1% typical voltage monitor accuracy. By decreasing the ratio of resistor values, the resistor divider will consume more current but the accuracy will increase. The resistor tolerance also needs to be accounted for.
Delay when returning from fault condition	RESET delay of at least 200 ms when returning from a undervoltage fault.	$C_{CT} = 0.33 \mu\text{F}$ sets 204 ms delay

### 9.2.2.2 Detailed Design Procedure

The primary constraint for this application is monitoring a 12-V rail while preventing the VDD pin on TPS3840-Q1 from exceeding the recommended maximum of 10 V. This is accomplished by sizing the resistor divider so that when the 12-V rail drops to 7.7 V, the VDD pin for TPS3840-Q1 will be at 1.6 V which is the  $V_{IT-}$  threshold for triggering a undervoltage condition for TPS3840DL16-Q1 as shown in Equation 7. Reasonably sized resistors were selected for the voltage divider. While selecting lower resistor values may increase current, this allows for additional accuracy from the resistor divider.

$$V_{\text{rail\_trigger}} = V_{IT-} \times (R_2 \div (R_1 + R_2)) \quad (7)$$

where  $V_{\text{rail\_trigger}}$  is the trigger voltage of the rail being monitored,  $V_{IT-}$  is the falling threshold on the VDD pin of TPS3840, and  $R_1$  and  $R_2$  are the top and bottom resistors of the external resistor divider.  $V_{IT-}$  is fixed per device variant and is 1.6 V for TPS3840DL16-Q1. Substituting in the values from Figure 50, the undervoltage trigger threshold for the rail is set to 7.7 V. Given that  $R_1 = 100 \text{ k}\Omega$ ,  $R_2 = 26.2 \text{ k}\Omega$ .

Because the undervoltage trigger of 10 V on the rail corresponds to 1.6 V undervoltage threshold trigger of the TPS3840-Q1 device, there is room for the rail to rise up while maintaining less than 10 V on the VDD pin of the TPS3840-Q1. Equation 8 shows the maximum rail voltage that still meets the 10 V maximum at the VDD pin for TPS3840-Q1.

$$V_{\text{rail\_max}} = 10 \text{ V} \times (26.2 \text{ k}\Omega \div (100 \text{ k}\Omega + 26.2 \text{ k}\Omega)) = 48.168 \text{ V} \quad (8)$$

This means the monitored voltage rail can go as high as 48.168 V and not violate the recommended maximum for the VDD pin on TPS3840-Q1. This is useful when monitoring a voltage rail that has a wide range that may go much higher than the nominal rail voltage such as in this case. Notice that the resistor values chosen are less than 100k $\Omega$  to preserve the accuracy set by the internal resistor divider. Good design practice recommends using a 0.1- $\mu\text{F}$  capacitor on the VDD pin and this capacitance may need to increase when using an external resistor divider.

### 9.2.2.3 Application Curves: TPS3840EVM

These application curves are taken with the *TPS3840EVM* using the TPS3840-Q1. Please see the *TPS3840EVM User Guide* for more information. The scope of the test below was to ensure that normal operation was maintained under typical cold crank and load dump conditions. This was verified by observing the input changing to its minimum and maximum value and the output remained both defined and accurate.



Figure 51. TPS3840-Q1 Warm-Start Test Pulse



Figure 52. TPS3840-Q1 Cold-Start Test Pulse



Figure 53. TPS3840-Q1 Cold Crank Test Pulse

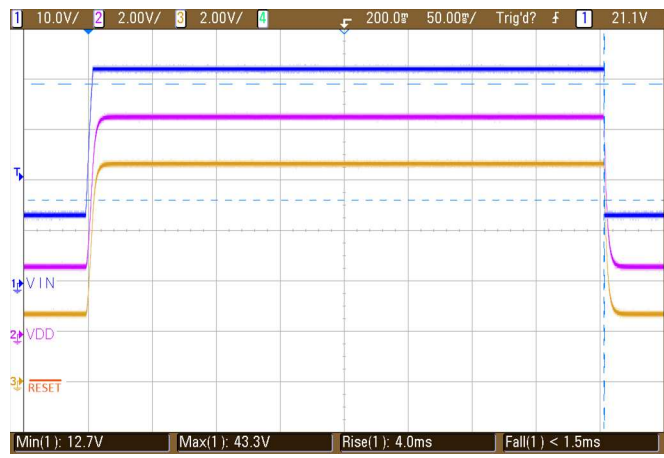

Figure 54. TPS3840-Q1 Load Dump Test Pulse

## 10 Power Supply Recommendations

These devices are designed to operate from an input supply with a voltage range between 1.5 V and 10 V. TI recommends an input supply capacitor between the VDD pin and GND pin. This device has a 12-V absolute maximum rating on the VDD pin. If the voltage supply providing power to VDD is susceptible to any large voltage transient that can exceed 12 V, additional precautions must be taken.

## 11 Layout

### 11.1 Layout Guidelines

Make sure that the connection to the VDD pin is low impedance. Good analog design practice recommends placing a minimum 0.1- $\mu$ F ceramic capacitor as near as possible to the VDD pin. If a capacitor is not connected to the CT pin, then minimize parasitic capacitance on this pin so the rest time delay is not adversely affected.

- Make sure that the connection to the VDD pin is low impedance. Good analog design practice is to place a >0.1- $\mu$ F ceramic capacitor as near as possible to the VDD pin.
- If a  $C_{CT}$  capacitor is used, place these components as close as possible to the CT pin. If the CT pin is left unconnected, make sure to minimize the amount of parasitic capacitance on the pin to <5 pF.
- Place the pull-up resistors on  $\overline{\text{RESET}}$  pin as close to the pin as possible.

### 11.2 Layout Example

The layout example in shows how the TPS3840-Q1 is laid out on a printed circuit board (PCB) with a user-defined delay.



Figure 55. TPS3840-Q1 Recommended Layout

## 12 Device and Documentation Support

### 12.1 Device Nomenclature

Table 2 shows how to decode the function of the device based on its part number.

**Table 2. Device Naming Convention**

DESCRIPTION	NOMENCLATURE	VALUE
Engineering Prototype pre-release sample	P	Engineering Prototype Sample
Part number	TPS3840	TPS3840-Q1
Variant code (Output Topology)	DL	Open-Drain, Active-Low
	PH	Push-Pull, Active-High
	PL	Push-Pull, Active-Low
Detect Voltage Option	## (two characters)	Example: 16 stands for 1.6 V threshold
Package	DBV	SOT23-5
Reel	R	Large Reel
Automotive Suffix	Q1	Indicate that device is compliant with AEC-Q100 standard

Table 3 shows the possible variants of the TPS3840-Q1. Contact Texas Instruments for details and availability of other options shown; minimum order quantities apply.

**Table 3. Device Threshold**

PRODUCT			VOLTAGE THRESHOLD (V <sub>IT</sub> )	HYSTERESIS (V <sub>HYST</sub> )
OPEN-DRAIN, ACTIVE-LOW	PUSH-PULL, ACTIVE-LOW	PUSH-PULL, ACTIVE-HIGH	Typ (V)	Typ (V)
TPS3840DL16-Q1	TPS3840PL16-Q1	TPS3840PH16-Q1	1.6	0.100
TPS3840DL17-Q1	TPS3840PL17-Q1	TPS3840PH17-Q1	1.7	0.100
TPS3840DL18-Q1	TPS3840PL18-Q1	TPS3840PH18-Q1	1.8	0.100
TPS3840DL19-Q1	TPS3840PL19-Q1	TPS3840PH19-Q1	1.9	0.100
TPS3840DL20-Q1	TPS3840PL20-Q1	TPS3840PH20-Q1	2.0	0.100
TPS3840DL21-Q1	TPS3840PL21-Q1	TPS3840PH21-Q1	2.1	0.100
TPS3840DL22-Q1	TPS3840PL22-Q1	TPS3840PH22-Q1	2.2	0.100
TPS3840DL23-Q1	TPS3840PL23-Q1	TPS3840PH23-Q1	2.3	0.100
TPS3840DL24-Q1	TPS3840PL24-Q1	TPS3840PH24-Q1	2.4	0.100
TPS3840DL25-Q1	TPS3840PL25-Q1	TPS3840PH25-Q1	2.5	0.100
TPS3840DL26-Q1	TPS3840PL26-Q1	TPS3840PH26-Q1	2.6	0.100
TPS3840DL27-Q1	TPS3840PL27-Q1	TPS3840PH27-Q1	2.7	0.100
TPS3840DL28-Q1	TPS3840PL28-Q1	TPS3840PH28-Q1	2.8	0.100
TPS3840DL29-Q1	TPS3840PL29-Q1	TPS3840PH29-Q1	2.9	0.100
TPS3840DL30-Q1	TPS3840PL30-Q1	TPS3840PH30-Q1	3.0	0.100
TPS3840DL31-Q1	TPS3840PL31-Q1	TPS3840PH31-Q1	3.1	0.200
TPS3840DL32-Q1	TPS3840PL32-Q1	TPS3840PH32-Q1	3.2	0.200
TPS3840DL33-Q1	TPS3840PL33-Q1	TPS3840PH33-Q1	3.3	0.200
TPS3840DL34-Q1	TPS3840PL34-Q1	TPS3840PH34-Q1	3.4	0.200
TPS3840DL35-Q1	TPS3840PL35-Q1	TPS3840PH35-Q1	3.5	0.200
TPS3840DL36-Q1	TPS3840PL36-Q1	TPS3840PH36-Q1	3.6	0.200
TPS3840DL37-Q1	TPS3840PL37-Q1	TPS3840PH37-Q1	3.7	0.200
TPS3840DL38-Q1	TPS3840PL38-Q1	TPS3840PH38-Q1	3.8	0.200
TPS3840DL39-Q1	TPS3840PL39-Q1	TPS3840PH39-Q1	3.9	0.200
TPS3840DL40-Q1	TPS3840PL40-Q1	TPS3840PH40-Q1	4.0	0.200

**Table 3. Device Threshold (continued)**

PRODUCT			VOLTAGE THRESHOLD (V <sub>IT-</sub> )	HYSTERESIS (V <sub>HYST</sub> )
OPEN-DRAIN, ACTIVE-LOW	PUSH-PULL, ACTIVE-LOW	PUSH-PULL, ACTIVE-HIGH	Typ (V)	Typ (V)
TPS3840DL41-Q1	TPS3840PL41-Q1	TPS3840PH41-Q1	4.1	0.200
TPS3840DL42-Q1	TPS3840PL42-Q1	TPS3840PH42-Q1	4.2	0.200
TPS3840DL43-Q1	TPS3840PL43-Q1	TPS3840PH43-Q1	4.3	0.200
TPS3840DL44-Q1	TPS3840PL44-Q1	TPS3840PH44-Q1	4.4	0.200
TPS3840DL45-Q1	TPS3840PL45-Q1	TPS3840PH45-Q1	4.5	0.200
TPS3840DL46-Q1	TPS3840PL46-Q1	TPS3840PH46-Q1	4.6	0.200
TPS3840DL47-Q1	TPS3840PL47-Q1	TPS3840PH47-Q1	4.7	0.200
TPS3840DL48-Q1	TPS3840PL48-Q1	TPS3840PH48-Q1	4.8	0.200
TPS3840DL49-Q1	TPS3840PL49-Q1	TPS3840PH49-Q1	4.9	0.200

## 12.2 Receiving Notification of Documentation Updates

To receive notification of documentation updates, navigate to the device product folder on ti.com. In the upper right corner, click on *Alert me* to register and receive a weekly digest of any product information that has changed. For change details, review the revision history included in any revised document.

## 12.3 Community Resources

[TI E2E™ support forums](#) are an engineer's go-to source for fast, verified answers and design help — straight from the experts. Search existing answers or ask your own question to get the quick design help you need.

Linked content is provided "AS IS" by the respective contributors. They do not constitute TI specifications and do not necessarily reflect TI's views; see TI's [Terms of Use](#).

## 12.4 Trademarks

E2E is a trademark of Texas Instruments.

All other trademarks are the property of their respective owners.

## 12.5 Electrostatic Discharge Caution



This integrated circuit can be damaged by ESD. Texas Instruments recommends that all integrated circuits be handled with appropriate precautions. Failure to observe proper handling and installation procedures can cause damage.

ESD damage can range from subtle performance degradation to complete device failure. Precision integrated circuits may be more susceptible to damage because very small parametric changes could cause the device not to meet its published specifications.

## 12.6 Glossary

[SLYZ022](#) — *TI Glossary*.

This glossary lists and explains terms, acronyms, and definitions.

## 13 Mechanical, Packaging, and Orderable Information

The following pages include mechanical, packaging, and orderable information. This information is the most current data available for the designated devices. This data is subject to change without notice and revision of this document. For browser-based versions of this data sheet, refer to the left-hand navigation.

**PACKAGING INFORMATION**

Orderable part number	Status (1)	Material type (2)	Package   Pins	Package qty   Carrier	RoHS (3)	Lead finish/ Ball material (4)	MSL rating/ Peak reflow (5)	Op temp (°C)	Part marking (6)
<a href="#">TPS3840DL16DBVRQ1</a>	Active	Production	SOT-23 (DBV)   5	3000   LARGE T&R	Yes	NIPDAU   SN	Level-1-260C-UNLIM	-40 to 125	DQ16
TPS3840DL16DBVRQ1.A	Active	Production	SOT-23 (DBV)   5	3000   LARGE T&R	Yes	SN	Level-1-260C-UNLIM	-40 to 125	DQ16
TPS3840DL16DBVRQ1.B	Active	Production	SOT-23 (DBV)   5	3000   LARGE T&R	-	Call TI	Call TI	-40 to 125	
<a href="#">TPS3840DL18DBVRQ1</a>	Active	Production	SOT-23 (DBV)   5	3000   LARGE T&R	Yes	NIPDAU   SN	Level-1-260C-UNLIM	-40 to 125	DQ18
TPS3840DL18DBVRQ1.A	Active	Production	SOT-23 (DBV)   5	3000   LARGE T&R	Yes	NIPDAU	Level-1-260C-UNLIM	-40 to 125	DQ18
TPS3840DL18DBVRQ1.B	Active	Production	SOT-23 (DBV)   5	3000   LARGE T&R	-	Call TI	Call TI	-40 to 125	
<a href="#">TPS3840DL20DBVRQ1</a>	Active	Production	SOT-23 (DBV)   5	3000   LARGE T&R	Yes	NIPDAU   SN	Level-1-260C-UNLIM	-40 to 125	DQ20
TPS3840DL20DBVRQ1.A	Active	Production	SOT-23 (DBV)   5	3000   LARGE T&R	Yes	NIPDAU	Level-1-260C-UNLIM	-40 to 125	DQ20
TPS3840DL20DBVRQ1.B	Active	Production	SOT-23 (DBV)   5	3000   LARGE T&R	-	Call TI	Call TI	-40 to 125	
<a href="#">TPS3840DL25DBVRQ1</a>	Active	Production	SOT-23 (DBV)   5	3000   LARGE T&R	Yes	NIPDAU	Level-1-260C-UNLIM	-40 to 125	DQ25
TPS3840DL25DBVRQ1.A	Active	Production	SOT-23 (DBV)   5	3000   LARGE T&R	Yes	NIPDAU	Level-1-260C-UNLIM	-40 to 125	DQ25
<a href="#">TPS3840DL28DBVRQ1</a>	Active	Production	SOT-23 (DBV)   5	3000   LARGE T&R	Yes	NIPDAU   SN	Level-1-260C-UNLIM	-40 to 125	DQ28
TPS3840DL28DBVRQ1.A	Active	Production	SOT-23 (DBV)   5	3000   LARGE T&R	Yes	NIPDAU	Level-1-260C-UNLIM	-40 to 125	DQ28
TPS3840DL28DBVRQ1.B	Active	Production	SOT-23 (DBV)   5	3000   LARGE T&R	-	Call TI	Call TI	-40 to 125	
<a href="#">TPS3840DL29DBVRQ1</a>	Active	Production	SOT-23 (DBV)   5	3000   LARGE T&R	Yes	NIPDAU   SN	Level-1-260C-UNLIM	-40 to 125	DQ29
TPS3840DL29DBVRQ1.A	Active	Production	SOT-23 (DBV)   5	3000   LARGE T&R	Yes	NIPDAU	Level-1-260C-UNLIM	-40 to 125	DQ29
TPS3840DL29DBVRQ1.B	Active	Production	SOT-23 (DBV)   5	3000   LARGE T&R	-	Call TI	Call TI	-40 to 125	
<a href="#">TPS3840DL30DBVRQ1</a>	Active	Production	SOT-23 (DBV)   5	3000   LARGE T&R	Yes	NIPDAU   SN	Level-1-260C-UNLIM	-40 to 125	DQ30
TPS3840DL30DBVRQ1.A	Active	Production	SOT-23 (DBV)   5	3000   LARGE T&R	Yes	SN	Level-1-260C-UNLIM	-40 to 125	DQ30
TPS3840DL30DBVRQ1.B	Active	Production	SOT-23 (DBV)   5	3000   LARGE T&R	-	Call TI	Call TI	-40 to 125	
<a href="#">TPS3840DL31DBVRQ1</a>	Active	Production	SOT-23 (DBV)   5	3000   LARGE T&R	Yes	NIPDAU   SN	Level-1-260C-UNLIM	-40 to 125	DQ31
TPS3840DL31DBVRQ1.A	Active	Production	SOT-23 (DBV)   5	3000   LARGE T&R	Yes	SN	Level-1-260C-UNLIM	-40 to 125	DQ31
TPS3840DL31DBVRQ1.B	Active	Production	SOT-23 (DBV)   5	3000   LARGE T&R	-	Call TI	Call TI	-40 to 125	
<a href="#">TPS3840DL32DBVRQ1</a>	Active	Production	SOT-23 (DBV)   5	3000   LARGE T&R	Yes	NIPDAU   SN	Level-1-260C-UNLIM	-40 to 125	DQ32
TPS3840DL32DBVRQ1.A	Active	Production	SOT-23 (DBV)   5	3000   LARGE T&R	Yes	SN	Level-1-260C-UNLIM	-40 to 125	DQ32
TPS3840DL32DBVRQ1.B	Active	Production	SOT-23 (DBV)   5	3000   LARGE T&R	-	Call TI	Call TI	-40 to 125	
<a href="#">TPS3840DL37DBVRQ1</a>	Active	Production	SOT-23 (DBV)   5	3000   LARGE T&R	Yes	NIPDAU	Level-1-260C-UNLIM	-40 to 125	DQ37
TPS3840DL37DBVRQ1.A	Active	Production	SOT-23 (DBV)   5	3000   LARGE T&R	Yes	NIPDAU	Level-1-260C-UNLIM	-40 to 125	DQ37
<a href="#">TPS3840DL40DBVRQ1</a>	Active	Production	SOT-23 (DBV)   5	3000   LARGE T&R	Yes	NIPDAU   SN	Level-1-260C-UNLIM	-40 to 125	DQ40

Orderable part number	Status (1)	Material type (2)	Package   Pins	Package qty   Carrier	RoHS (3)	Lead finish/ Ball material (4)	MSL rating/ Peak reflow (5)	Op temp (°C)	Part marking (6)
TPS3840DL40DBVRQ1.A	Active	Production	SOT-23 (DBV)   5	3000   LARGE T&R	Yes	NIPDAU	Level-1-260C-UNLIM	-40 to 125	DQ40
TPS3840DL40DBVRQ1.B	Active	Production	SOT-23 (DBV)   5	3000   LARGE T&R	-	Call TI	Call TI	-40 to 125	
<a href="#">TPS3840DL41DBVRQ1</a>	Active	Production	SOT-23 (DBV)   5	3000   LARGE T&R	Yes	NIPDAU   SN	Level-1-260C-UNLIM	-40 to 125	DQ41
TPS3840DL41DBVRQ1.A	Active	Production	SOT-23 (DBV)   5	3000   LARGE T&R	Yes	NIPDAU	Level-1-260C-UNLIM	-40 to 125	DQ41
TPS3840DL41DBVRQ1.B	Active	Production	SOT-23 (DBV)   5	3000   LARGE T&R	-	Call TI	Call TI	-40 to 125	
<a href="#">TPS3840DL42DBVRQ1</a>	Active	Production	SOT-23 (DBV)   5	3000   LARGE T&R	Yes	NIPDAU	Level-1-260C-UNLIM	-40 to 125	DQ42
TPS3840DL42DBVRQ1.A	Active	Production	SOT-23 (DBV)   5	3000   LARGE T&R	Yes	NIPDAU	Level-1-260C-UNLIM	-40 to 125	DQ42
<a href="#">TPS3840DL44DBVRQ1</a>	Active	Production	SOT-23 (DBV)   5	3000   LARGE T&R	Yes	NIPDAU   SN	Level-1-260C-UNLIM	-40 to 125	DQ44
TPS3840DL44DBVRQ1.A	Active	Production	SOT-23 (DBV)   5	3000   LARGE T&R	Yes	SN	Level-1-260C-UNLIM	-40 to 125	DQ44
<a href="#">TPS3840DL45DBVRQ1</a>	Active	Production	SOT-23 (DBV)   5	3000   LARGE T&R	Yes	NIPDAU   SN	Level-1-260C-UNLIM	-40 to 125	DQ45
TPS3840DL45DBVRQ1.A	Active	Production	SOT-23 (DBV)   5	3000   LARGE T&R	Yes	NIPDAU	Level-1-260C-UNLIM	-40 to 125	DQ45
TPS3840DL45DBVRQ1.B	Active	Production	SOT-23 (DBV)   5	3000   LARGE T&R	-	Call TI	Call TI	-40 to 125	
<a href="#">TPS3840DL46DBVRQ1</a>	Active	Production	SOT-23 (DBV)   5	3000   LARGE T&R	Yes	NIPDAU   SN	Level-1-260C-UNLIM	-40 to 125	DQ46
TPS3840DL46DBVRQ1.A	Active	Production	SOT-23 (DBV)   5	3000   LARGE T&R	Yes	NIPDAU	Level-1-260C-UNLIM	-40 to 125	DQ46
TPS3840DL46DBVRQ1.B	Active	Production	SOT-23 (DBV)   5	3000   LARGE T&R	-	Call TI	Call TI	-40 to 125	
<a href="#">TPS3840DL47DBVRQ1</a>	Active	Production	SOT-23 (DBV)   5	3000   LARGE T&R	Yes	NIPDAU   SN	Level-1-260C-UNLIM	-40 to 125	DQ47
TPS3840DL47DBVRQ1.A	Active	Production	SOT-23 (DBV)   5	3000   LARGE T&R	Yes	NIPDAU	Level-1-260C-UNLIM	-40 to 125	DQ47
TPS3840DL47DBVRQ1.B	Active	Production	SOT-23 (DBV)   5	3000   LARGE T&R	-	Call TI	Call TI	-40 to 125	
<a href="#">TPS3840PH27DBVRQ1</a>	Active	Production	SOT-23 (DBV)   5	3000   LARGE T&R	Yes	NIPDAU   SN	Level-1-260C-UNLIM	-40 to 125	QH27
TPS3840PH27DBVRQ1.A	Active	Production	SOT-23 (DBV)   5	3000   LARGE T&R	Yes	NIPDAU	Level-1-260C-UNLIM	-40 to 125	QH27
TPS3840PH27DBVRQ1.B	Active	Production	SOT-23 (DBV)   5	3000   LARGE T&R	-	Call TI	Call TI	-40 to 125	
<a href="#">TPS3840PH30DBVRQ1</a>	Active	Production	SOT-23 (DBV)   5	3000   LARGE T&R	Yes	NIPDAU   SN	Level-1-260C-UNLIM	-40 to 125	QH30
TPS3840PH30DBVRQ1.A	Active	Production	SOT-23 (DBV)   5	3000   LARGE T&R	Yes	NIPDAU	Level-1-260C-UNLIM	-40 to 125	QH30
TPS3840PH30DBVRQ1.B	Active	Production	SOT-23 (DBV)   5	3000   LARGE T&R	-	Call TI	Call TI	-40 to 125	
<a href="#">TPS3840PL16DBVRQ1</a>	Active	Production	SOT-23 (DBV)   5	3000   LARGE T&R	Yes	NIPDAU   SN	Level-1-260C-UNLIM	-40 to 125	QL16
TPS3840PL16DBVRQ1.A	Active	Production	SOT-23 (DBV)   5	3000   LARGE T&R	Yes	NIPDAU	Level-1-260C-UNLIM	-40 to 125	QL16
<a href="#">TPS3840PL25DBVRQ1</a>	Active	Production	SOT-23 (DBV)   5	3000   LARGE T&R	Yes	NIPDAU	Level-1-260C-UNLIM	-40 to 125	QL25
TPS3840PL25DBVRQ1.A	Active	Production	SOT-23 (DBV)   5	3000   LARGE T&R	Yes	NIPDAU	Level-1-260C-UNLIM	-40 to 125	QL25
<a href="#">TPS3840PL28DBVRQ1</a>	Active	Production	SOT-23 (DBV)   5	3000   LARGE T&R	Yes	NIPDAU   SN	Level-1-260C-UNLIM	-40 to 125	QL28
TPS3840PL28DBVRQ1.A	Active	Production	SOT-23 (DBV)   5	3000   LARGE T&R	Yes	NIPDAU	Level-1-260C-UNLIM	-40 to 125	QL28
TPS3840PL28DBVRQ1.B	Active	Production	SOT-23 (DBV)   5	3000   LARGE T&R	-	Call TI	Call TI	-40 to 125	

Orderable part number	Status (1)	Material type (2)	Package   Pins	Package qty   Carrier	RoHS (3)	Lead finish/ Ball material (4)	MSL rating/ Peak reflow (5)	Op temp (°C)	Part marking (6)
<a href="#">TPS3840PL29DBVRQ1</a>	Active	Production	SOT-23 (DBV)   5	3000   LARGE T&R	Yes	NIPDAU   SN	Level-1-260C-UNLIM	-40 to 125	QL29
TPS3840PL29DBVRQ1.A	Active	Production	SOT-23 (DBV)   5	3000   LARGE T&R	Yes	NIPDAU	Level-1-260C-UNLIM	-40 to 125	QL29
TPS3840PL29DBVRQ1.B	Active	Production	SOT-23 (DBV)   5	3000   LARGE T&R	-	Call TI	Call TI	-40 to 125	
<a href="#">TPS3840PL30DBVRQ1</a>	Active	Production	SOT-23 (DBV)   5	3000   LARGE T&R	Yes	NIPDAU   SN	Level-1-260C-UNLIM	-40 to 125	QL30
TPS3840PL30DBVRQ1.A	Active	Production	SOT-23 (DBV)   5	3000   LARGE T&R	Yes	NIPDAU	Level-1-260C-UNLIM	-40 to 125	QL30
TPS3840PL30DBVRQ1.B	Active	Production	SOT-23 (DBV)   5	3000   LARGE T&R	-	Call TI	Call TI	-40 to 125	
<a href="#">TPS3840PL31DBVRQ1</a>	Active	Production	SOT-23 (DBV)   5	3000   LARGE T&R	Yes	NIPDAU   SN	Level-1-260C-UNLIM	-40 to 125	QL31
TPS3840PL31DBVRQ1.A	Active	Production	SOT-23 (DBV)   5	3000   LARGE T&R	Yes	NIPDAU	Level-1-260C-UNLIM	-40 to 125	QL31
TPS3840PL31DBVRQ1.B	Active	Production	SOT-23 (DBV)   5	3000   LARGE T&R	-	Call TI	Call TI	-40 to 125	
<a href="#">TPS3840PL40DBVRQ1</a>	Active	Production	SOT-23 (DBV)   5	3000   LARGE T&R	Yes	NIPDAU   SN	Level-1-260C-UNLIM	-40 to 125	QL40
TPS3840PL40DBVRQ1.A	Active	Production	SOT-23 (DBV)   5	3000   LARGE T&R	Yes	NIPDAU	Level-1-260C-UNLIM	-40 to 125	QL40
TPS3840PL40DBVRQ1.B	Active	Production	SOT-23 (DBV)   5	3000   LARGE T&R	-	Call TI	Call TI	-40 to 125	
<a href="#">TPS3840PL43DBVRQ1</a>	Active	Production	SOT-23 (DBV)   5	3000   LARGE T&R	Yes	NIPDAU   SN	Level-1-260C-UNLIM	-40 to 125	QL43
TPS3840PL43DBVRQ1.A	Active	Production	SOT-23 (DBV)   5	3000   LARGE T&R	Yes	NIPDAU	Level-1-260C-UNLIM	-40 to 125	QL43

(1) **Status:** For more details on status, see our [product life cycle](#).

(2) **Material type:** When designated, preproduction parts are prototypes/experimental devices, and are not yet approved or released for full production. Testing and final process, including without limitation quality assurance, reliability performance testing, and/or process qualification, may not yet be complete, and this item is subject to further changes or possible discontinuation. If available for ordering, purchases will be subject to an additional waiver at checkout, and are intended for early internal evaluation purposes only. These items are sold without warranties of any kind.

(3) **RoHS values:** Yes, No, RoHS Exempt. See the [TI RoHS Statement](#) for additional information and value definition.

(4) **Lead finish/Ball material:** Parts may have multiple material finish options. Finish options are separated by a vertical ruled line. Lead finish/Ball material values may wrap to two lines if the finish value exceeds the maximum column width.

(5) **MSL rating/Peak reflow:** The moisture sensitivity level ratings and peak solder (reflow) temperatures. In the event that a part has multiple moisture sensitivity ratings, only the lowest level per JEDEC standards is shown. Refer to the shipping label for the actual reflow temperature that will be used to mount the part to the printed circuit board.

(6) **Part marking:** There may be an additional marking, which relates to the logo, the lot trace code information, or the environmental category of the part.

Multiple part markings will be inside parentheses. Only one part marking contained in parentheses and separated by a "-" will appear on a part. If a line is indented then it is a continuation of the previous line and the two combined represent the entire part marking for that device.

**Important Information and Disclaimer:**The information provided on this page represents TI's knowledge and belief as of the date that it is provided. TI bases its knowledge and belief on information provided by third parties, and makes no representation or warranty as to the accuracy of such information. Efforts are underway to better integrate information from third parties. TI has taken and continues to take reasonable steps to provide representative and accurate information but may not have conducted destructive testing or chemical analysis on incoming materials and chemicals. TI and TI suppliers consider certain information to be proprietary, and thus CAS numbers and other limited information may not be available for release.

In no event shall TI's liability arising out of such information exceed the total purchase price of the TI part(s) at issue in this document sold by TI to Customer on an annual basis.

**OTHER QUALIFIED VERSIONS OF TPS3840-Q1 :**

- Catalog : [TPS3840](#)

NOTE: Qualified Version Definitions:

- Catalog - TI's standard catalog product

## TAPE AND REEL INFORMATION



### QUADRANT ASSIGNMENTS FOR PIN 1 ORIENTATION IN TAPE



\*All dimensions are nominal

Device	Package Type	Package Drawing	Pins	SPQ	Reel Diameter (mm)	Reel Width W1 (mm)	A0 (mm)	B0 (mm)	K0 (mm)	P1 (mm)	W (mm)	Pin1 Quadrant
TPS3840DL16DBVRQ1	SOT-23	DBV	5	3000	180.0	8.4	3.2	3.2	1.4	4.0	8.0	Q3
TPS3840DL18DBVRQ1	SOT-23	DBV	5	3000	180.0	8.4	3.2	3.2	1.4	4.0	8.0	Q3
TPS3840DL20DBVRQ1	SOT-23	DBV	5	3000	180.0	8.4	3.2	3.2	1.4	4.0	8.0	Q3
TPS3840DL25DBVRQ1	SOT-23	DBV	5	3000	180.0	8.4	3.2	3.2	1.4	4.0	8.0	Q3
TPS3840DL28DBVRQ1	SOT-23	DBV	5	3000	180.0	8.4	3.2	3.2	1.4	4.0	8.0	Q3
TPS3840DL29DBVRQ1	SOT-23	DBV	5	3000	180.0	8.4	3.2	3.2	1.4	4.0	8.0	Q3
TPS3840DL30DBVRQ1	SOT-23	DBV	5	3000	180.0	8.4	3.2	3.2	1.4	4.0	8.0	Q3
TPS3840DL31DBVRQ1	SOT-23	DBV	5	3000	180.0	8.4	3.2	3.2	1.4	4.0	8.0	Q3
TPS3840DL32DBVRQ1	SOT-23	DBV	5	3000	180.0	8.4	3.2	3.2	1.4	4.0	8.0	Q3
TPS3840DL37DBVRQ1	SOT-23	DBV	5	3000	180.0	8.4	3.2	3.2	1.4	4.0	8.0	Q3
TPS3840DL40DBVRQ1	SOT-23	DBV	5	3000	180.0	8.4	3.2	3.2	1.4	4.0	8.0	Q3
TPS3840DL41DBVRQ1	SOT-23	DBV	5	3000	180.0	8.4	3.2	3.2	1.4	4.0	8.0	Q3
TPS3840DL42DBVRQ1	SOT-23	DBV	5	3000	180.0	8.4	3.2	3.2	1.4	4.0	8.0	Q3
TPS3840DL44DBVRQ1	SOT-23	DBV	5	3000	180.0	8.4	3.2	3.2	1.4	4.0	8.0	Q3
TPS3840DL45DBVRQ1	SOT-23	DBV	5	3000	180.0	8.4	3.2	3.2	1.4	4.0	8.0	Q3
TPS3840DL46DBVRQ1	SOT-23	DBV	5	3000	180.0	8.4	3.2	3.2	1.4	4.0	8.0	Q3

Device	Package Type	Package Drawing	Pins	SPQ	Reel Diameter (mm)	Reel Width W1 (mm)	A0 (mm)	B0 (mm)	K0 (mm)	P1 (mm)	W (mm)	Pin1 Quadrant
TPS3840DL47DBVRQ1	SOT-23	DBV	5	3000	180.0	8.4	3.2	3.2	1.4	4.0	8.0	Q3
TPS3840PH27DBVRQ1	SOT-23	DBV	5	3000	180.0	8.4	3.2	3.2	1.4	4.0	8.0	Q3
TPS3840PH30DBVRQ1	SOT-23	DBV	5	3000	180.0	8.4	3.2	3.2	1.4	4.0	8.0	Q3
TPS3840PL16DBVRQ1	SOT-23	DBV	5	3000	180.0	8.4	3.2	3.2	1.4	4.0	8.0	Q3
TPS3840PL25DBVRQ1	SOT-23	DBV	5	3000	180.0	8.4	3.2	3.2	1.4	4.0	8.0	Q3
TPS3840PL28DBVRQ1	SOT-23	DBV	5	3000	180.0	8.4	3.2	3.2	1.4	4.0	8.0	Q3
TPS3840PL29DBVRQ1	SOT-23	DBV	5	3000	180.0	8.4	3.2	3.2	1.4	4.0	8.0	Q3
TPS3840PL30DBVRQ1	SOT-23	DBV	5	3000	180.0	8.4	3.2	3.2	1.4	4.0	8.0	Q3
TPS3840PL31DBVRQ1	SOT-23	DBV	5	3000	180.0	8.4	3.2	3.2	1.4	4.0	8.0	Q3
TPS3840PL40DBVRQ1	SOT-23	DBV	5	3000	180.0	8.4	3.2	3.2	1.4	4.0	8.0	Q3
TPS3840PL43DBVRQ1	SOT-23	DBV	5	3000	180.0	8.4	3.2	3.2	1.4	4.0	8.0	Q3

## TAPE AND REEL BOX DIMENSIONS



\*All dimensions are nominal

Device	Package Type	Package Drawing	Pins	SPQ	Length (mm)	Width (mm)	Height (mm)
TPS3840DL16DBVRQ1	SOT-23	DBV	5	3000	210.0	185.0	35.0
TPS3840DL18DBVRQ1	SOT-23	DBV	5	3000	210.0	185.0	35.0
TPS3840DL20DBVRQ1	SOT-23	DBV	5	3000	210.0	185.0	35.0
TPS3840DL25DBVRQ1	SOT-23	DBV	5	3000	210.0	185.0	35.0
TPS3840DL28DBVRQ1	SOT-23	DBV	5	3000	210.0	185.0	35.0
TPS3840DL29DBVRQ1	SOT-23	DBV	5	3000	210.0	185.0	35.0
TPS3840DL30DBVRQ1	SOT-23	DBV	5	3000	210.0	185.0	35.0
TPS3840DL31DBVRQ1	SOT-23	DBV	5	3000	210.0	185.0	35.0
TPS3840DL32DBVRQ1	SOT-23	DBV	5	3000	210.0	185.0	35.0
TPS3840DL37DBVRQ1	SOT-23	DBV	5	3000	210.0	185.0	35.0
TPS3840DL40DBVRQ1	SOT-23	DBV	5	3000	210.0	185.0	35.0
TPS3840DL41DBVRQ1	SOT-23	DBV	5	3000	210.0	185.0	35.0
TPS3840DL42DBVRQ1	SOT-23	DBV	5	3000	210.0	185.0	35.0
TPS3840DL44DBVRQ1	SOT-23	DBV	5	3000	210.0	185.0	35.0
TPS3840DL45DBVRQ1	SOT-23	DBV	5	3000	210.0	185.0	35.0
TPS3840DL46DBVRQ1	SOT-23	DBV	5	3000	210.0	185.0	35.0
TPS3840DL47DBVRQ1	SOT-23	DBV	5	3000	210.0	185.0	35.0
TPS3840PH27DBVRQ1	SOT-23	DBV	5	3000	210.0	185.0	35.0

Device	Package Type	Package Drawing	Pins	SPQ	Length (mm)	Width (mm)	Height (mm)
TPS3840PH30DBVRQ1	SOT-23	DBV	5	3000	210.0	185.0	35.0
TPS3840PL16DBVRQ1	SOT-23	DBV	5	3000	210.0	185.0	35.0
TPS3840PL25DBVRQ1	SOT-23	DBV	5	3000	210.0	185.0	35.0
TPS3840PL28DBVRQ1	SOT-23	DBV	5	3000	210.0	185.0	35.0
TPS3840PL29DBVRQ1	SOT-23	DBV	5	3000	210.0	185.0	35.0
TPS3840PL30DBVRQ1	SOT-23	DBV	5	3000	210.0	185.0	35.0
TPS3840PL31DBVRQ1	SOT-23	DBV	5	3000	210.0	185.0	35.0
TPS3840PL40DBVRQ1	SOT-23	DBV	5	3000	210.0	185.0	35.0
TPS3840PL43DBVRQ1	SOT-23	DBV	5	3000	210.0	185.0	35.0

# DBV0005A



# PACKAGE OUTLINE

SOT-23 - 1.45 mm max height

SMALL OUTLINE TRANSISTOR



4214839/K 08/2024

**NOTES:**

1. All linear dimensions are in millimeters. Any dimensions in parenthesis are for reference only. Dimensioning and tolerancing per ASME Y14.5M.
2. This drawing is subject to change without notice.
3. Reference JEDEC MO-178.
4. Body dimensions do not include mold flash, protrusions, or gate burrs. Mold flash, protrusions, or gate burrs shall not exceed 0.25 mm per side.
5. Support pin may differ or may not be present.

# EXAMPLE BOARD LAYOUT

DBV0005A

SOT-23 - 1.45 mm max height

SMALL OUTLINE TRANSISTOR



LAND PATTERN EXAMPLE  
EXPOSED METAL SHOWN  
SCALE:15X



SOLDER MASK DETAILS

4214839/K 08/2024

NOTES: (continued)

- 6. Publication IPC-7351 may have alternate designs.
- 7. Solder mask tolerances between and around signal pads can vary based on board fabrication site.

# EXAMPLE STENCIL DESIGN

DBV0005A

SOT-23 - 1.45 mm max height

SMALL OUTLINE TRANSISTOR



SOLDER PASTE EXAMPLE  
BASED ON 0.125 mm THICK STENCIL  
SCALE:15X

4214839/K 08/2024

NOTES: (continued)

8. Laser cutting apertures with trapezoidal walls and rounded corners may offer better paste release. IPC-7525 may have alternate design recommendations.
9. Board assembly site may have different recommendations for stencil design.

## IMPORTANT NOTICE AND DISCLAIMER

TI PROVIDES TECHNICAL AND RELIABILITY DATA (INCLUDING DATASHEETS), DESIGN RESOURCES (INCLUDING REFERENCE DESIGNS), APPLICATION OR OTHER DESIGN ADVICE, WEB TOOLS, SAFETY INFORMATION, AND OTHER RESOURCES "AS IS" AND WITH ALL FAULTS, AND DISCLAIMS ALL WARRANTIES, EXPRESS AND IMPLIED, INCLUDING WITHOUT LIMITATION ANY IMPLIED WARRANTIES OF MERCHANTABILITY, FITNESS FOR A PARTICULAR PURPOSE OR NON-INFRINGEMENT OF THIRD PARTY INTELLECTUAL PROPERTY RIGHTS.

These resources are intended for skilled developers designing with TI products. You are solely responsible for (1) selecting the appropriate TI products for your application, (2) designing, validating and testing your application, and (3) ensuring your application meets applicable standards, and any other safety, security, regulatory or other requirements.

These resources are subject to change without notice. TI grants you permission to use these resources only for development of an application that uses the TI products described in the resource. Other reproduction and display of these resources is prohibited. No license is granted to any other TI intellectual property right or to any third party intellectual property right. TI disclaims responsibility for, and you fully indemnify TI and its representatives against any claims, damages, costs, losses, and liabilities arising out of your use of these resources.

TI's products are provided subject to [TI's Terms of Sale](#), [TI's General Quality Guidelines](#), or other applicable terms available either on [ti.com](http://ti.com) or provided in conjunction with such TI products. TI's provision of these resources does not expand or otherwise alter TI's applicable warranties or warranty disclaimers for TI products. Unless TI explicitly designates a product as custom or customer-specified, TI products are standard, catalog, general purpose devices.

TI objects to and rejects any additional or different terms you may propose.

Copyright © 2026, Texas Instruments Incorporated

Last updated 10/2025