

TPS7H401x-SP and TPS7H401x-SEP 4.5V to 14V Input, 3A and 6A, Radiation Hardened Synchronous Buck Converter

1 Features

- Total ionizing dose (TID) characterized
 - Radiation hardness assurance (RHA) availability of up to 100krad(Si)
- Single-Event Effects (SEE) characterized
 - Single-event latchup (SEL), single-event burnout (SEB), and single-event gate rupture (SEGR) immune up to linear energy transfer (LET) = 75MeV-cm²/mg
 - Single-event functional interrupt (SEFI) and single-event transient (SET) characterized up to LET = 75MeV-cm²/mg
- Input voltage range from 4.5V to 14V
- 6A (TPS7H4012) or 3A (TPS7H4013) maximum output current
- High efficiency (typical values for VIN = 12V, VOUT = 3.3V, f_{sw} = 500kHz)
 - 88% at 1A
 - 92% at 3A
 - 91% at 6A
- Integrated 33mΩ (HS) and 27mΩ (LS) MOSFETs (typ at 12V)
- Flexible switching frequency options:
 - 100kHz to 1MHz, accurate (±15% or better), adjustable internal oscillator
 - 100kHz to 1MHz external sync capability
- 0.6V ± 0.83% voltage reference over line, temperature, and radiation
- Supports start-up into prebiased outputs
- Adjustable slope compensation and soft-start
- Adjustable input enable and power-good output for power sequencing
- Power-good output monitor for undervoltage and overvoltage
- Supports inverting buck-boost topology
- Plastic packages outgas tested per ASTM E595
- Available in military (–55°C to 125°C) temperature range

2 Applications

- Space satellite point of load supply
- [Satellite electrical power systems \(EPS\)](#)
- [Communications payload](#)
- [Radar imaging payload](#)
- Radiation hardened power supplies

3 Description

The TPS7H401x devices are 14V synchronous buck converters optimized for use in a space environment. The TPS7H4012 is a 6A device and the TPS7H4013 is a 3A device. The peak current mode converter obtains high efficiency with good transient performance and reduced component count.

The wide voltage range of the TPS7H401x enables it to be used as a point of load regulator to convert directly from a 12V or 5V rail. The output voltage start-up ramp is controlled by the SS_TR pin. Power sequencing is possible with the EN and PWRGD pins.

Additionally, various features are included such as an optimized current limit for each device, a flexible switching frequency, and configurable compensation.

Device Information

PART NUMBER ⁽¹⁾	GRADE	PACKAGE ⁽²⁾
5962R2122105VZC ⁽³⁾	QMLV-RHA	20-pin ceramic 7.84mm × 12.93mm Mass = TBD
5962R2122106VZC ⁽³⁾		
TPS7H4012HLC/EM ⁽³⁾	Engineering sample	
TPS7H4013HLC/EM ⁽³⁾		
5962R2122103PYE	QMLP-RHA	44-pin plastic 6.10mm × 14.00mm Mass = 218mg
5962R2122104PYE		
TPS7H4012MDDWTSEP	SEP	
TPS7H4013MDDWTSEP		

- (1) For additional information view the [Device Options Table](#).
- (2) Dimension and mass values are nominal.
- (3) Product preview.

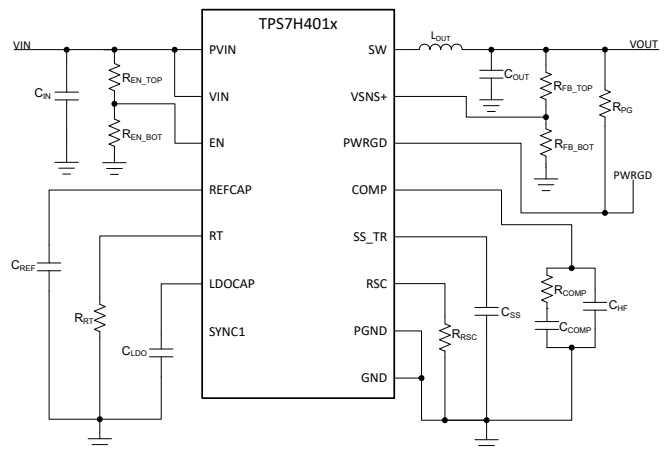

Simplified Schematic



Table of Contents

1 Features	1	9.3 Feature Description.....	25
2 Applications	1	9.4 Device Functional Modes.....	40
3 Description	1	10 Application and Implementation	41
4 Device Comparison Table	3	10.1 Application Information.....	41
5 Device Options Table	3	10.2 Typical Application.....	41
6 Pin Configuration and Functions	4	10.3 Power Supply Recommendations.....	49
7 Specifications	6	10.4 Layout.....	49
7.1 Absolute Maximum Ratings.....	6	11 Device and Documentation Support	51
7.2 ESD Ratings.....	6	11.1 Documentation Support.....	51
7.3 Recommended Operating Conditions.....	7	11.2 Receiving Notification of Documentation Updates..	51
7.4 Thermal Information.....	7	11.3 Support Resources.....	51
7.5 Electrical Characteristics.....	8	11.4 Trademarks.....	51
7.6 Quality Conformance Inspection.....	12	11.5 Electrostatic Discharge Caution.....	51
7.7 Typical Characteristics.....	13	11.6 Glossary.....	51
8 Parameter Measurement Information	23	12 Revision History	52
9 Detailed Description	24	13 Mechanical, Packaging, and Orderable Information	53
9.1 Overview.....	24		
9.2 Functional Block Diagram.....	24		

4 Device Comparison Table

MAXIMUM OUTPUT CURRENT	DEVICE	RADIATION	DIFFERENTIAL REMOTE SENSE	FLEXIBLE SYNCHRONIZATION	SELECTABLE CURRENT LIMIT	FAULT INPUT PIN
12A	TPS7H4011-SP	Rad-hard	Yes	Yes	Yes	Yes
	TPS7H4011-SEP	Rad-tolerant				
6A	TPS7H4012-SP	Rad-hard	No	No	No	No
	TPS7H4012-SEP	Rad-tolerant				
3A	TPS7H4013-SP	Rad-hard	No	No	No	No
	TPS7H4013-SEP	Rad-tolerant				

5 Device Options Table

GENERIC PART NUMBER	RADIATION RATING ⁽¹⁾	GRADE ⁽²⁾	PACKAGE	ORDERABLE PART NUMBER
TPS7H4012-SP	TID of 100krad(Si) RLAT, DSEE free to 75MeV-cm ² /mg	QMLV-RHA	20-pin CFP HLC	5962R2122105VZC ⁽⁴⁾
		QMLP-RHA	44-pin HTSSOP DDW	5962R2122103PYE
	None	Engineering model ⁽³⁾	20-pin CFP HLC	TPS7H4012HLC/EM ⁽⁴⁾
TPS7H4012-SEP	TID of 50krad(Si) RLAT, DSEE free to 43MeV-cm ² /mg	Space Enhanced Plastic	44-pin HTSSOP DDW	TPS7H4012MDDWTSEP
TPS7H4013-SP	TID of 100krad(Si) RLAT, DSEE free to 75MeV-cm ² /mg	QMLV-RHA	20-pin CFP HLC	5962R2122106VZC ⁽⁴⁾
		QMLP-RHA	44-pin HTSSOP DDW	5962R2122104PYE
	None	Engineering model ⁽³⁾	20-pin CFP HLC	TPS7H4013HLC/EM ⁽⁴⁾
TPS7H4013-SEP	TID of 50krad(Si) RLAT, DSEE free to 43MeV-cm ² /mg	Space Enhanced Plastic	44-pin HTSSOP DDW	TPS7H4013MDDWTSEP
SN0020HLC	N/A	Mechanical "dummy" package (no die)	20-pin CFP HLC	SN0020HLC ⁽⁴⁾

- (1) TID is total ionizing dose and DSEE is destructive single event effects. Additional information is available in the associated TID reports and SEE reports for each product.
- (2) For additional information about the part grade, view [part ratings](#).
- (3) These units are intended for engineering evaluation only. They are processed to a non-compliant flow (such as no burn-in and only 25°C testing). These units are not suitable for qualification, production, radiation testing, or flight use. Parts are not warranted as to performance over temperature or operating life.
- (4) Product preview.

6 Pin Configuration and Functions

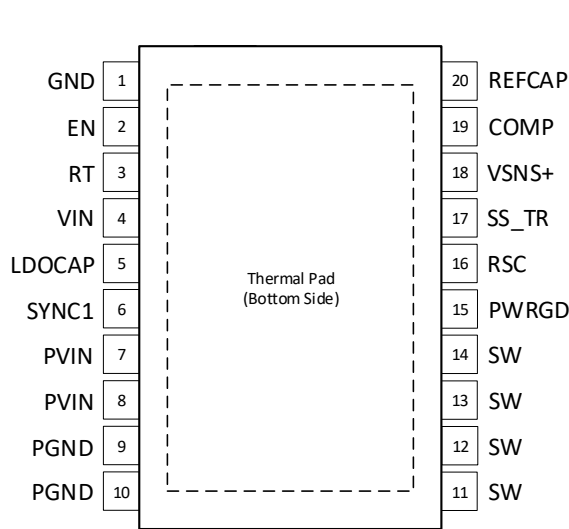

Figure 6-1. HLC Package, 20-Pin CFP (Top View)

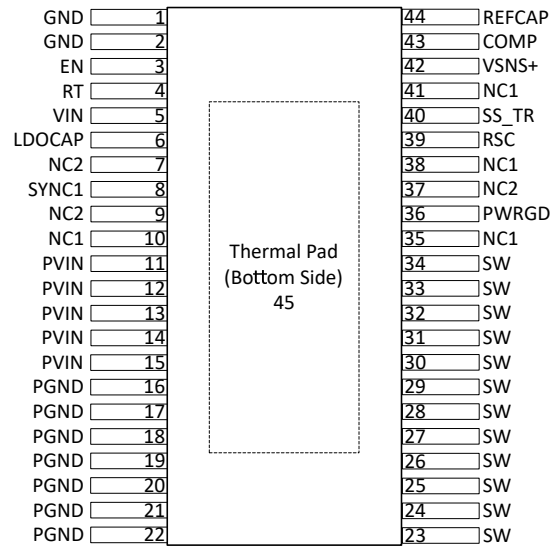

Figure 6-2. DDW Package, 44-Pin HTSSOP (Top View)

Table 6-1. Pin Functions

PIN		HTSSOP (44)	I/O ⁽¹⁾	DESCRIPTION
NAME	CFP (20)			
GND	1	1, 2	—	Ground. Return for control circuitry.
EN	2	3	I	Enable. Driving this pin to logic high enables the device; driving the pin to logic low disables the device. A resistor divider from VIN to GND can be used to set the device turn-on level.
RT	3	4	I/O	A resistor connected between RT and GND sets the switching frequency of the converter. The switching frequency range is 100kHz to 1MHz. If the device is configured to use an external clock, this pin can be left floating or a resistor can be used to provide a backup frequency if the external clock is lost.
VIN	4	5	I	Input voltage. Power for the control circuitry of the switching regulator. VIN must be the same voltage as PVIN and is therefore recommended to externally connect VIN to PVIN.
LDOCAP	5	6	O	Linear regulator output capacitor pin. A 1µF capacitor must be placed on this pin for the internal linear regulator. The output voltage, AVDD, is nominally 5V. Do not load this pin with any additional external circuitry.
SYNC1	6	8	I	Synchronization pin 1. This pin is used as an input for an external clock. SYNC1 sets the switching frequency 180° out of phase with SYNC1. If an external clock is not used, TI recommends to connect SYNC1 to GND to prevent noise coupling into the pin.
PVIN	7–8	11–15	I	Power stage input voltage. Power for the output stage of the switching regulator.
PGND	9–10	16–22	—	Power stage ground. Return for low-side power MOSFET. Connect to GND on the PCB.
SW	11–14	23–34	O	Switching node pins. Switch node output. A Schottky diode can be connected from SW to PGND for potential improvement in internal device noise and efficiency.
PWRGD	15	36	O	Power Good pin. This is an open-drain pin. Use a pull-up resistor to pull this pin up to VOUT (assuming VOUT is under 7V) or the desired logic level. PWRGD is asserted when the output voltage is within 5% (typ) of the programmed value. PWRGD is deasserted when the output voltages is outside 8% (typ) of the programmed value or when there is a fault condition (such as thermal shutdown).
RSC	16	39	I/O	Slope compensation pin. A resistor from RSC to GND sets the desired slope compensation.

Table 6-1. Pin Functions (continued)

PIN			I/O ⁽¹⁾	DESCRIPTION
NAME	CFP (20)	HTSSOP (44)		
SS_TR	17	40	I/O	Soft-start and tracking. An external capacitor connected between this pin and VSNS- slows down the rise time of the internal reference. SS_TR can also be used for tracking and sequencing.
VSNS+	18	42	I	Positive voltage sense. This is the feedback pin that is set to a nominal 0.6V by selecting the appropriate resistor divider network.
COMP	19	43	I/O	Compensation pin. This is the operational transconductance (OTA) error amplifier output and input to the switch current comparator. Connect frequency compensation to this pin.
REFCAP	20	44	O	Reference capacitor pin. A 470nF external capacitor is required for the internal bandgap reference. The voltage, V _{BG} , is nominally 1.2V. Do not connect external circuitry to this pin.
NC1	N/A	10, 35, 38, 41	—	No connect 1. These pins are not internally connected. TI recommends to connect these pins to GND to prevent charge buildup; however, these pins can also be left open or tied to any voltage between GND and VIN.
NC2	N/A	7, 9, 37	—	No connect 2. These pins are internally connected. Do not externally connect these pins (the pins must be left electrically floating). These pins are internally pulled to a voltage between GND and LDOCAP.
THERMAL PAD	21	45	—	Thermal pad internally connected to GND. Connect to a large ground plane for thermal dissipation. While TI recommends to electrically connect to GND or PGND; the pad can be left electrically disconnected if desired.
Metal lid	Lid	N/A	—	Internally connected to GND.

(1) I = Input, O = Output, I/O = Input or Output, — = Other

7 Specifications

7.1 Absolute Maximum Ratings

over operating temperature (unless otherwise noted)⁽¹⁾

		MIN	MAX	UNIT
Input voltage	VIN, PVIN	-0.3	16	V
	EN, PWRGD, SYNC1	-0.3	7.5	
	VSNS+	-0.3	3.6	
Output voltage	SW	-1	16	V
	SW, 80ns transient	-3	20	
	LDOCAP	-0.3	7.5	
	RSC, COMP, RT, SS_TR	-0.3	3.6	
	REFCAP	-0.3	1.9	
Vdiff	(GND to exposed thermal pad)	-0.2	0.2	V
Source current	SW	Current limit		A
	PVIN	Current limit		
	PGND	Current limit		
	RT	-100	100	μA
Sink current	SW	Current limit		A
	PGND	Current limit		
	COMP	-200	200	μA
	PWRGD	-0.1	5	mA
Operating junction temperature		-55	150	°C
Storage temperature, T _{stg}		-65	150	°C

- (1) Operation outside the Absolute Maximum Ratings may cause permanent device damage. Absolute Maximum Ratings do not imply functional operation of the device at these or any other conditions beyond those listed under Recommended Operating Conditions. If used outside the Recommended Operating Conditions but within the Absolute Maximum Ratings, the device may not be fully functional, and this may affect device reliability, functionality, performance, and shorten the device lifetime.

7.2 ESD Ratings

			VALUE	UNIT
V _(ESD)	Electrostatic discharge	Human-body model (HBM), per ANSI/ESDA/JEDEC JS-001, all pins ⁽¹⁾	±1000	V
		Charged device model (CDM), per ANSI/ESDA/JEDEC JS-002, all pins ⁽²⁾	±500	

- (1) JEDEC document JEP155 states that 500V HBM allows safe manufacturing with a standard ESD control process.
 (2) JEDEC document JEP157 states that 250V CDM allows safe manufacturing with a standard ESD control process.

7.3 Recommended Operating Conditions

over operating temperature range (unless otherwise noted)

		MIN	NOM	MAX	UNIT
Input voltage	VIN, PVIN ⁽¹⁾	4.5		14	V
	EN, PWRGD	0		7	
	SYNC1 ⁽²⁾	0		5.3	
		0		VIN	
	VSNS+	0	0.6	1	
Output voltage	SW	0		14	V
	RSC, COMP, RT	0		3.3	
	SS_TR	0	0.6	1	
Output current	SW _(avg) , TPS7H4012	0		6	A
	SW _(avg) , TPS7H4013	0		3	A
	RT	-100		100	μA
Input current	COMP	-200		200	μA
	PWRGD	0		2	mA
Operating junction temperature	T _J	-55		125	°C

(1) VIN must be equal to PVIN and startup at the same time. Normally this is achieved by tying them to the same voltage rail.

(2) The SYNC1 maximum input voltage must be set to the lower of VIN and 5.3V.

7.4 Thermal Information

THERMAL METRIC ⁽¹⁾		TPS7H4012-SP TPS7H4013-SP	TPS7H4012-SP, -SEP TPS7H4013-SP, -SEP	UNIT
		CFP HLC	DDW (HTSSOP)	
		20 PINS	44 PINS	
R _{θJA}	Junction-to-ambient thermal resistance	22.3	21.1	°C/W
R _{θJC(top)}	Junction-to-case (top) thermal resistance	4.0	8.8	°C/W
R _{θJC(bot)}	Junction-to-case (bottom) thermal resistance	0.31	0.6	°C/W
R _{θJB}	Junction-to-board thermal resistance	5.8	4.4	°C/W
Ψ _{JT}	Junction-to-top characterization parameter	0.9	0.1	°C/W
Ψ _{JB}	Junction-to-board characterization parameter	5.8	4.4	°C/W

(1) For more information about the traditional and new thermal metrics, see the Semiconductor and IC Package Thermal Metrics application report ([SPRA953](#)).

7.5 Electrical Characteristics

Over $4.5V \leq V_{IN} \leq 14V$, $PV_{IN} = V_{IN}$, open loop configuration, $I_{OUT} = 0A$, over operating temperature range ($T_A = -55^\circ C$ to $125^\circ C$), unless otherwise noted; includes RLAT at $T_A = 25^\circ C$ if sub-group number is present for QML RHA and SEP devices⁽¹⁾

PARAMETER		TEST CONDITIONS		SUB-GROUP ⁽²⁾	MIN	TYP	MAX	UNIT	
POWER SUPPLIES AND CURRENTS									
V_{UVLOR_PVIN}	PVIN internal UVLO rising threshold			1, 2, 3	3.2	3.4	3.6	V	
$V_{UVLOHYST_PVIN}$	PVIN internal UVLO hysteresis			1, 2, 3	425	450	500	mV	
V_{UVLOR_VIN}	VIN internal UVLO rising threshold			1, 2, 3	3.4	3.6	3.8	V	
$V_{UVLOHYST_VIN}$	VIN internal UVLO hysteresis			1, 2, 3	140	155	170	mV	
I_{SHDN_VIN}	VIN shutdown supply current	$V_{EN} = 0V$	VIN = 4.5V	1, 2, 3		2	2.9	mA	
			VIN = 14V	1, 2, 3		2	3		
I_{SHDN_PVIN}	PVIN shutdown supply current	$V_{EN} = 0V$	PVIN = 4.5V	1, 2, 3		2.6	3.5	mA	
			PVIN = 14V	1, 2, 3		3.5	4.7		
I_{Q_VIN}	VIN operating quiescent current (non switching)	$V_{EN} = 7V, VSNS+ = 1V$		1, 2, 3		2.6	5	mA	
ENABLE									
$V_{EN(rising)}$	Enable rising threshold (turn-on)			1, 2, 3	0.555	0.61	0.655	V	
$V_{EN(falling)}$	Enable falling threshold (turn-off)			1, 2, 3	0.455	0.51	0.554		
$t_{EN(delay)}$	Enable propagation delay	EN high to SW high, SS pin open		1, 2, 3		52	100	μs	
$I_{EN(LKG)}$	Enable input leakage current	$V_{EN} = 7V$		1, 2, 3		2	100	nA	
VOLTAGE REFERENCE AND SENSE									
V_{REF}	Internal voltage reference (including error amplifier V_{IO})	see ⁽³⁾	$T_A = -55^\circ C$	3	0.594	0.598	0.603	V	
			$T_A = 25^\circ C$	1	0.596	0.6	0.603		
			$T_A = 125^\circ C$	2	0.597	0.6	0.604		
$V_{REF(internal)}$	Internal voltage reference (without error amplifier included)	$V_{REF(internal)} = V_{SS_TR}$		1, 2, 3	0.593	0.6	0.606	V	
V_{BG}	Bandgap voltage (voltage at the REFCAP pin)	$C_{REFCAP} = 470nF$		1, 2, 3	1.184	1.2	1.222	V	
$I_{VSNS+(LKG)}$	VSNS+ input leakage current	$VSNS+ = 0.6V$		1, 2, 3		10	30	nA	
ERROR AMPLIFIER									
V_{IO}	Error amplifier input offset voltage	$VSNS+ = 0.6V$		1, 2, 3	-2.9		2.9	mV	
g_{mEA}	Error amplifier transconductance	$-10\mu A < I_{COMP} < 10\mu A,$ $V_{COMP} = 1V$	$T_A = -55^\circ C$	11	1400	2050	2700	μS	
			$T_A = 25^\circ C$	9	1200	1650	2100		
			$T_A = 125^\circ C$	10	1000	1250	1500		
EA_{DC}	Error amplifier DC gain	$VSNS+ = 0.6V$				11500		V/V	
EA_{ISRC}	Error amplifier source	$V_{COMP} = 1V, 100mV$ input overdrive		1, 2, 3	90	125	200	μA	
EA_{ISNK}	Error amplifier sink				90	125	200		
EA_{Ro}	Error amplifier output resistance					7		$M\Omega$	
EA_{BW}	Error amplifier bandwidth					9		MHz	
g_{mps}	Power stage transconductance	$V_{COMP} = 0.7V$	TPS7H4012, HTSSOP	1, 2, 3	8	11.2	14.5	S	
			TPS7H4012, CFP				11		
			TPS7H4013, HTSSOP	1, 2, 3	3.5	6.2	9.2		
			TPS7H4013, CFP				7.2		
OVERCURRENT PROTECTION									
I_{OC_HS1}	High-side switch current limit threshold ⁽⁴⁾	$R_{SHORT} = 100m\Omega$	TPS7H4012, HTSSOP	1, 2, 3		9.7	12.2	A	
			TPS7H4012, CFP				9.5		
			TPS7H4013, HTSSOP	1, 2, 3			5.6		7.7
			TPS7H4013, CFP				5.5		

7.5 Electrical Characteristics (continued)

Over $4.5V \leq V_{IN} \leq 14V$, $PV_{IN} = V_{IN}$, open loop configuration, $I_{OUT} = 0A$, over operating temperature range ($T_A = -55^\circ C$ to $125^\circ C$), unless otherwise noted; includes RLAT at $T_A = 25^\circ C$ if sub-group number is present for QML RHA and SEP devices⁽¹⁾

PARAMETER		TEST CONDITIONS		SUB-GROUP ⁽²⁾	MIN	TYP	MAX	UNIT
I _{OC_HS2}	High-side switch current limit threshold 2	V _{IN} = 12V, R _{SHORT} ≈ 4mΩ	TPS7H4012, HTSSOP	1, 2, 3		11.8		A
			TPS7H4012, CFP			11.5		
			TPS7H4013, HTSSOP	1, 2, 3		6.8		
			TPS7H4013, CFP			6.6		
I _{OC_LS(sink)}	Low-side switch sinking overcurrent threshold	T _A = -55°C T _A = 25°C T _A = 125°C		3		2		A
				1		1.9		
				2		1.7		
COMP _{SHDN}	COMP shutdown voltage			1, 2, 3	1.7	1.9	2.1	V
t _{COMP(delay)}	COMP shutdown delay					30		μs
SOFT START AND TRACKING								
t _{SS}	Soft start time	V _{SS_TR} from 10% to 90%, V _{OUT(set)} = 3.3V	C _{SS} = 5.6nF	9, 10, 11		1.5		ms
			C _{SS} = 22nF	9, 10, 11	4.7	5.8	7.3	
			C _{SS} = 100nF	9, 10, 11		24.7		
R _{SS(discharge)}	Soft start discharge pull-down resistor			1, 2, 3	200	442	700	Ω
SS _{startup}	Maximum voltage on SS before startup ⁽⁵⁾					20		mV
SLOPE COMPENSATION								
SC	Slope compensation, TPS74012	f _{SW} = 100kHz, V _{IN} = 12V	R _{SC} = 499kΩ			-0.8		A/μs
			R _{SC} = 1.5MΩ			-0.3		
			R _{SC} = 100kΩ			-4.2		
			R _{SC} = 499kΩ			-1.4		
			R _{SC} = 1.5MΩ			-1		
			R _{SC} = 100kΩ			-5.5		
		f _{SW} = 500kHz, V _{IN} = 12V	R _{SC} = 499kΩ			-2.4		
			R _{SC} = 1.5MΩ			-2.3		
			R _{SC} = 100kΩ			-0.5		
SC	Slope compensation, TPS74013	f _{SW} = 100kHz, V _{IN} = 12V	R _{SC} = 499kΩ			-0.2		A/μs
			R _{SC} = 1.5MΩ			-0.2		
			R _{SC} = 100kΩ			-2.8		
			R _{SC} = 499kΩ			-1.2		
			R _{SC} = 1.5MΩ			-0.8		
			R _{SC} = 100kΩ			-4		
		f _{SW} = 500kHz, V _{IN} = 12V	R _{SC} = 499kΩ			-2		
			R _{SC} = 1.5MΩ			-1.5		
			R _{SC} = 100kΩ			-1.5		
MINIMUM ON TIME AND DEAD TIME								
t _{on(min)}	Minimum on time	50% to 50% of V _{IN} , I _{sw} = 2A	V _{IN} = 4.5V	9, 10, 11		210	235	ns
			V _{IN} = 5V	9, 10, 11		213	250	
			V _{IN} = 12V	9, 10, 11		199	250	
			V _{IN} = 14V	9, 10, 11		199	250	
t _{off(min)}	Minimum off time	I _{sw} = 2A				306		ns
t _{dead}	Dead time					70		ns

7.5 Electrical Characteristics (continued)

Over $4.5V \leq V_{IN} \leq 14V$, $P_{VIN} = V_{IN}$, open loop configuration, $I_{OUT} = 0A$, over operating temperature range ($T_A = -55^\circ C$ to $125^\circ C$), unless otherwise noted; includes RLAT at $T_A = 25^\circ C$ if sub-group number is present for QML RHA and SEP devices⁽¹⁾

PARAMETER		TEST CONDITIONS		SUB-GROUP ⁽²⁾	MIN	TYP	MAX	UNIT		
SWITCHING FREQUENCY AND SYNCHRONIZATION										
f_{SW}	RT programmed switching frequency	$R_{RT} = 511k\Omega$		4, 5, 6	90	100	120	kHz		
		$R_{RT} = 90.9k\Omega$		4, 5, 6	450	500	550			
		$R_{RT} = 40.2k\Omega$	$V_{IN} = 4.5V$		4, 5, 6	850	1000		1150	
			$5 \leq V_{IN} \leq 14$		4, 5, 6	870	1000		1170	
t_{SYNC_D}	SYNC1 to SW delay	SYNC1 input, see Figure 8-2		$V_{IN} = 4.5V$	9, 10, 11	150	256	390	ns	
				$5V \leq V_{IN} \leq 14V$		9, 10, 11	160	240		310
				$V_{IN} = 12V, I_{OUT} = 3A$				246		
$V_{SYNC1(IH)}$	SYNC1 input high threshold			1, 2, 3			1.7	V		
$V_{SYNC1(IL)}$	SYNC1 input low threshold			1, 2, 3	0.7					
f_{SYNC}	SYNC1 input frequency range			4, 5, 6	100		1000	kHz		
D_{SYNC}	SYNC1 input duty cycle range	External clock duty cycle		4, 5, 6	40%		60%			
$t_{CLK_E_I}$	External clock to internal clock detection time	RT populated		9, 10, 11		2	5	$(1/f_{sw})$ s		
$t_{CLK_I_E}$	Internal clock to external clock detection time	RT populated		9, 10, 11		1	2	$(1/f_{sw})$ s		
POWER GOOD AND THERMAL SHUTDOWN										
$PWRGD_{LOW_F\%}$	PWRGD falling threshold (fault), low	Threshold for PWRGD (V_{SNS+} as percent of V_{REF})	VSNS+ falling	1, 2, 3	89%	92%	95%			
$PWRGD_{LOW_R\%}$	PWRGD rising threshold (good), low		VSNS+ rising	1, 2, 3	92%	95%	98%			
$PWRGD_{HIGH_R\%}$	PWRGD rising threshold (fault), high		VSNS+ rising	1, 2, 3	105%	108%	112%			
$PWRGD_{HIGH_F\%}$	PWRGD falling threshold (good), high		VSNS+ falling	1, 2, 3	102%	105%	109%			
$I_{PWRGD(LKG)}$	Output high leakage	$V_{SNS+} = V_{REF}, V_{PWRGD} = 7V$		1, 2, 3		50	500	nA		
$V_{PWRGD(OL)}$	Power good output low	$I_{PWRGD(SINK)} = 0mA$ to 2mA		1, 2, 3		250	300	mV		
$V_{IN_MIN_PWRGD}$	Minimum V_{IN} for valid PWRGD output	Measured when $V_{PWRGD} \leq 0.5V$ at 100 μA		1, 2, 3		1	2	V		
$T_{SD(enter)}$	Thermal shutdown enter temperature					175		$^\circ C$		
$T_{SD(exit)}$	Thermal shutdown exit temperature					140				
$T_{SD(HYS)}$	Thermal shutdown hysteresis					35				
MOSFET										
$R_{DS_ON_HS}$	High-side switch resistance at $I_{HS} = 6A$, TPS7H4012, HTSSOP	$P_{VIN} = 4.5V$	$T_A = -55^\circ C$	3		29	42	m Ω		
			$T_A = 25^\circ C$	1		37	48			
			$T_A = 125^\circ C$	2		47	63			
		$5V \leq P_{VIN} \leq 14V$	$T_A = -55^\circ C$	3		26	38			
			$T_A = 25^\circ C$	1		33	46			
			$T_A = 125^\circ C$	2		41	56			
$R_{DS_ON_LS}$	Low-side switch resistance at $I_{LS} = 6A$, TPS7H4012, HTSSOP	$P_{VIN} = 4.5V$	$T_A = -55^\circ C$	3		20	31	m Ω		
			$T_A = 25^\circ C$	1		28	39			
			$T_A = 125^\circ C$	2		41	50			
		$5V \leq P_{VIN} \leq 14V$	$T_A = -55^\circ C$	3		20	29			
			$T_A = 25^\circ C$	1		27	37			
			$T_A = 125^\circ C$	2		39	48			

7.5 Electrical Characteristics (continued)

Over $4.5V \leq V_{IN} \leq 14V$, $PV_{IN} = V_{IN}$, open loop configuration, $I_{OUT} = 0A$, over operating temperature range ($T_A = -55^\circ C$ to $125^\circ C$), unless otherwise noted; includes RLAT at $T_A = 25^\circ C$ if sub-group number is present for QML RHA and SEP devices⁽¹⁾

PARAMETER		TEST CONDITIONS		SUB-GROUP ⁽²⁾	MIN	TYP	MAX	UNIT
R _{DS_ON_HS}	High-side switch resistance at $I_{HS} = 6A$, TPS7H4012, CFP ⁽⁶⁾	PVIN = 4.5V	$T_A = -55^\circ C$	3		43	58	mΩ
			$T_A = 25^\circ C$	1		55	66	
			$T_A = 125^\circ C$	2		69	84	
		5V ≤ PVIN ≤ 14V	$T_A = -55^\circ C$	3		41	55	
			$T_A = 25^\circ C$	1		53	65	
			$T_A = 125^\circ C$	2		67	78	
R _{DS_ON_LS}	Low-side switch resistance at $I_{LS} = 6A$, TPS7H4012, CFP ⁽⁶⁾	PVIN = 4.5V	$T_A = -55^\circ C$	3		30	45	mΩ
			$T_A = 25^\circ C$	1		40	56	
			$T_A = 125^\circ C$	2		56	66	
		5V ≤ PVIN ≤ 14V	$T_A = -55^\circ C$	3		28	40	
			$T_A = 25^\circ C$	1		38	50	
			$T_A = 125^\circ C$	2		53	61	
R _{DS_ON_HS}	High-side switch resistance at $I_{HS} = 3A$, TPS7H4013, HTSSOP	PVIN = 4.5V	$T_A = -55^\circ C$	3		28	41	mΩ
			$T_A = 25^\circ C$	1		36	47	
			$T_A = 125^\circ C$	2		46	62	
		5V ≤ PVIN ≤ 14V	$T_A = -55^\circ C$	3		26	38	
			$T_A = 25^\circ C$	1		33	46	
			$T_A = 125^\circ C$	2		41	56	
R _{DS_ON_LS}	Low-side switch resistance at $I_{LS} = 3A$, TPS7H4013, HTSSOP	PVIN = 4.5V	$T_A = -55^\circ C$	3		20	31	mΩ
			$T_A = 25^\circ C$	1		28	39	
			$T_A = 125^\circ C$	2		41	50	
		5V ≤ PVIN ≤ 14V	$T_A = -55^\circ C$	3		20	29	
			$T_A = 25^\circ C$	1		27	37	
			$T_A = 125^\circ C$	2		39	48	
R _{DS_ON_HS}	High-side switch resistance at $I_{HS} = 3A$, TPS7H4013, CFP ⁽⁶⁾	PVIN = 4.5V	$T_A = -55^\circ C$	3		42	57	mΩ
			$T_A = 25^\circ C$	1		54	65	
			$T_A = 125^\circ C$	2		68	83	
		5V ≤ PVIN ≤ 14V	$T_A = -55^\circ C$	3		40	54	
			$T_A = 25^\circ C$	1		52	64	
			$T_A = 125^\circ C$	2		66	77	
R _{DS_ON_LS}	Low-side switch resistance at $I_{LS} = 3A$, TPS7H4013, CFP ⁽⁶⁾	PVIN = 4.5V	$T_A = -55^\circ C$	3		29	44	mΩ
			$T_A = 25^\circ C$	1		39	55	
			$T_A = 125^\circ C$	2		55	65	
		5V ≤ PVIN ≤ 14V	$T_A = -55^\circ C$	3		27	39	
			$T_A = 25^\circ C$	1		37	49	
			$T_A = 125^\circ C$	2		52	60	

- (1) See the 5962R21221 SMD for additional information on the QML RHA devices and see the VID for additional information on the SEP devices.
- (2) Subgroups are applicable for QML parts. For subgroup definitions, see the [Quality Conformance Inspection table](#).
- (3) Use this V_{REF} value to set the output voltage. Measured in a non-switching configuration as shown in [Figure 8-1](#)
- (4) See [Section 9.3.8.1.1](#) for additional information.
- (5) The device will not begin startup until the voltage on SS discharges below $SS_{startup}$ in order to ensure proper soft start functionality.
- (6) Measured at pins with lead length ≈ 3mm.

7.6 Quality Conformance Inspection

MIL-STD-883, Method 5005 - Group A

SUBGROUP	DESCRIPTION	TEMP (°C)
1	Static tests at	25
2	Static tests at	125
3	Static tests at	-55
4	Dynamic tests at	25
5	Dynamic tests at	125
6	Dynamic tests at	-55
7	Functional tests at	25
8A	Functional tests at	125
8B	Functional tests at	-55
9	Switching tests at	25
10	Switching tests at	125
11	Switching tests at	-55

7.7 Typical Characteristics

TPS7H4012 44-pin HTSSOP (DDW) package, $V_{IN} = P_{VIN}$, $V_{IN} = 12V$, $C_{SS} = 22nF$, Kemet MPXV1D2213L series inductor and SS10P4M3/87A Schottky diode for efficiency tests, $T_A = 25^\circ C$, unless otherwise noted.

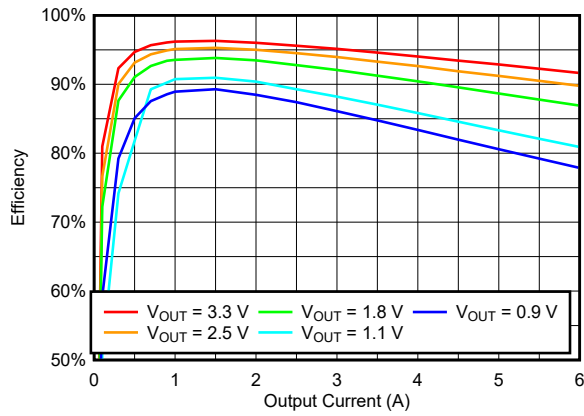

$L_{OUT} = 15\mu H$

Figure 7-1. Efficiency vs Load Across VOUT at $V_{IN} = 5V$, 100kHz

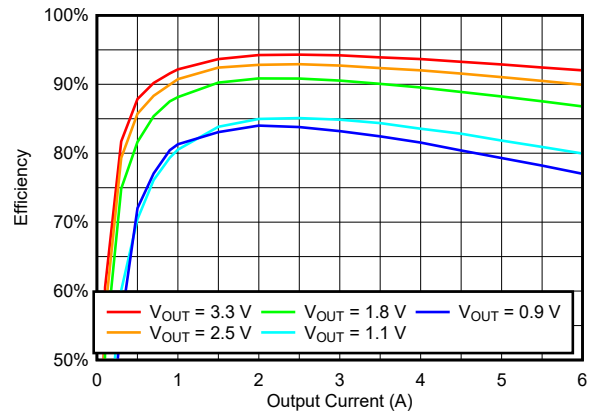

A. $L_{OUT} = 15\mu H$

Figure 7-2. Efficiency vs Load Across VOUT at $V_{IN} = 12V$, 100kHz

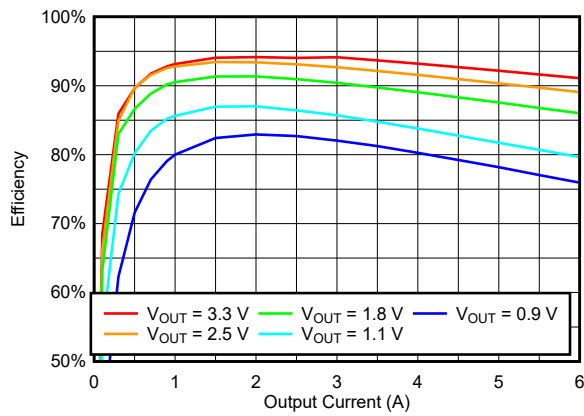

$L_{OUT} = 2.2\mu H$

Figure 7-3. Efficiency vs Load Across VOUT at $V_{IN} = 5V$, 500kHz

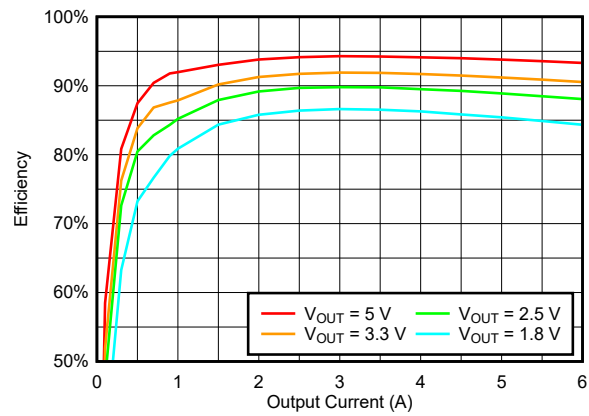

$L_{OUT} = 2.2\mu H$

Figure 7-4. Efficiency vs Load Across VOUT at $V_{IN} = 12V$, 500kHz

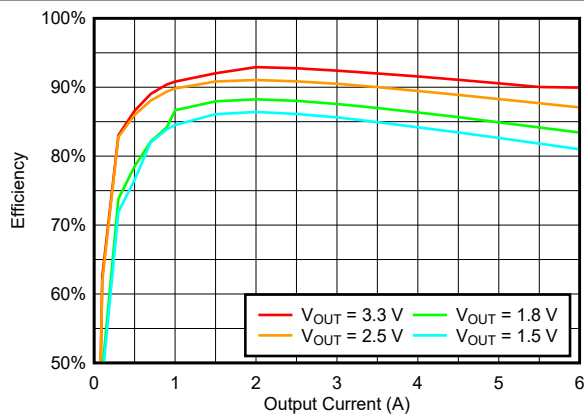

$L_{OUT} = 1\mu H$

Figure 7-5. Efficiency vs Load Across VOUT at $V_{IN} = 5V$, 1MHz

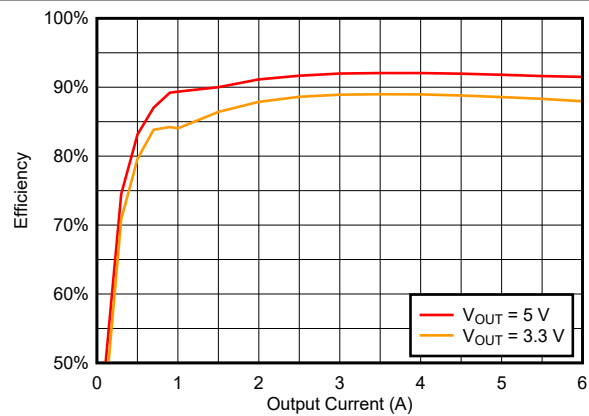

$L_{OUT} = 1\mu H$

Figure 7-6. Efficiency vs Load Across VOUT at $V_{IN} = 12V$, 1MHz

7.7 Typical Characteristics (continued)

TPS7H4012 44-pin HTSSOP (DDW) package, $V_{IN} = PV_{IN}$, $V_{IN} = 12V$, $C_{SS} = 22nF$, Kemet MPXV1D2213L series inductor and SS10P4M3/87A Schottky diode for efficiency tests, $T_A = 25^\circ C$, unless otherwise noted.

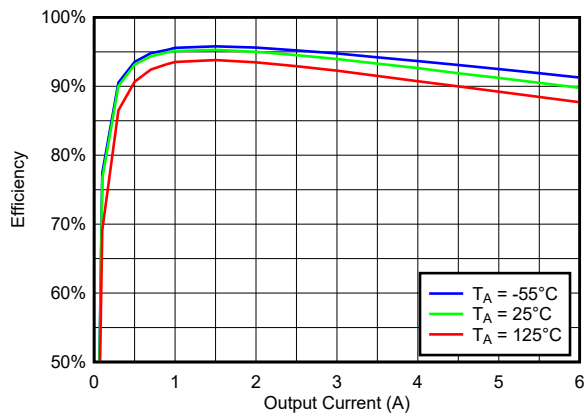

$L_{OUT} = 15\mu H$

Figure 7-7. Efficiency vs Load Across Temperature at 100kHz, $V_{IN} = 5V$, $V_{OUT} = 2.5V$

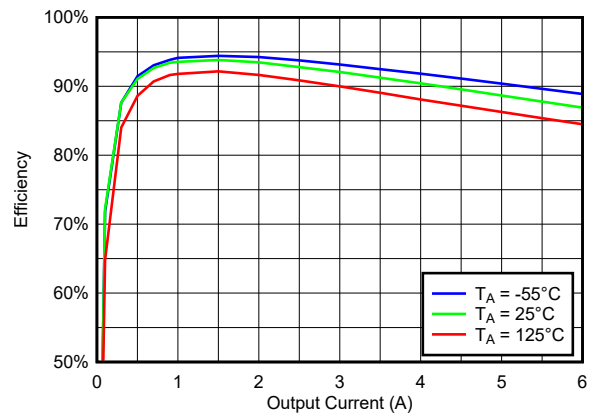

$L_{OUT} = 15\mu H$

Figure 7-8. Efficiency vs Load Across Temperature at 100kHz, $V_{IN} = 5V$, $V_{OUT} = 1.8V$

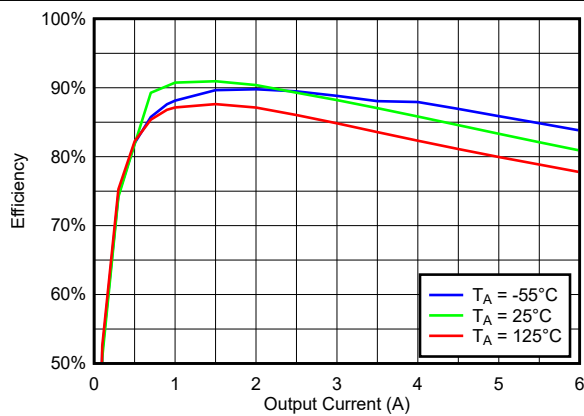

$L_{OUT} = 15\mu H$

Figure 7-9. Efficiency vs Load Across Temperature at 100kHz, $V_{IN} = 5V$, $V_{OUT} = 1.1V$

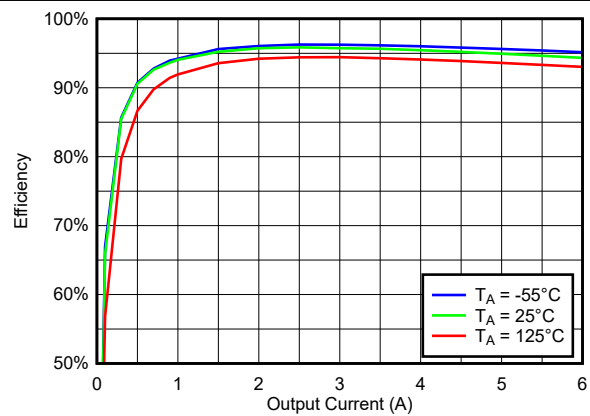

$L_{OUT} = 15\mu H$

Figure 7-10. Efficiency vs Load Across Temperature at 100kHz, $V_{IN} = 12V$, $V_{OUT} = 5V$

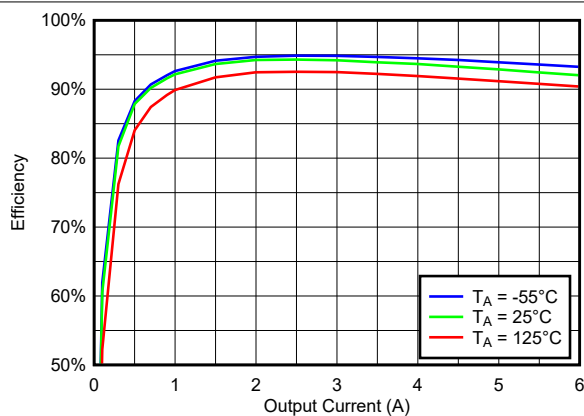

$L_{OUT} = 15\mu H$

Figure 7-11. Efficiency vs Load Across Temperature at 100kHz, $V_{IN} = 12V$, $V_{OUT} = 3.3V$

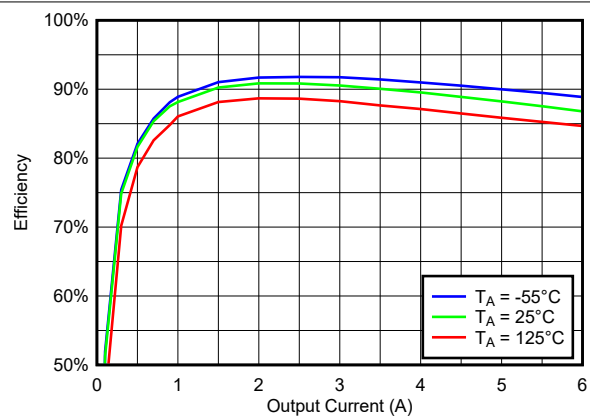

$L_{OUT} = 15\mu H$

Figure 7-12. Efficiency vs Load Across Temperature at 100kHz, $V_{IN} = 12V$, $V_{OUT} = 1.8V$

7.7 Typical Characteristics (continued)

TPS7H4012 44-pin HTSSOP (DDW) package, VIN = PVIN, VIN = 12V, CSS = 22nF, Kemet MPXV1D2213L series inductor and SS10P4M3/87A Schottky diode for efficiency tests, TA = 25°C, unless otherwise noted.

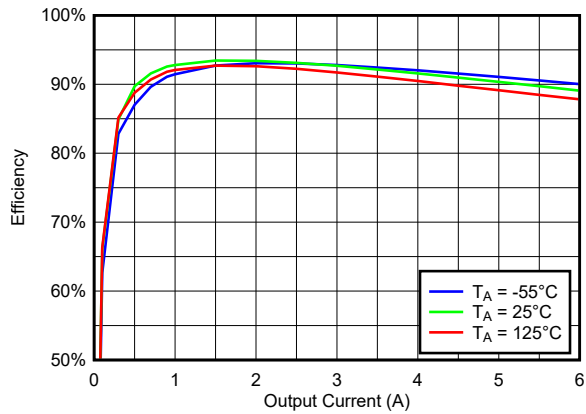

Figure 7-13. Efficiency vs Load Across Temperature at 500kHz, VIN = 5V, VOUT = 2.5V

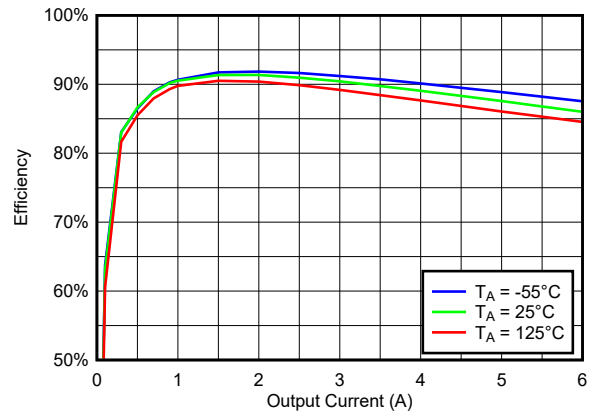

Figure 7-14. Efficiency vs Load Across Temperature at 500kHz, VIN = 5V, VOUT = 1.8V

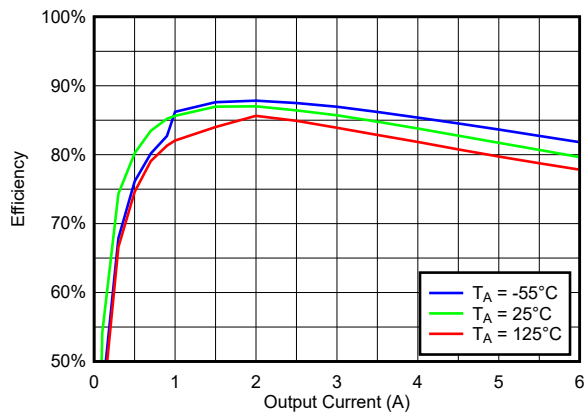

Figure 7-15. Efficiency vs Load Across Temperature at 500kHz, VIN = 5V, VOUT = 1.1V

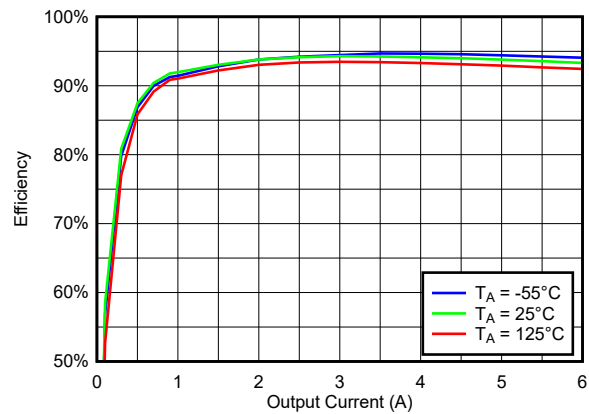

Figure 7-16. Efficiency vs Load Across Temperature at 500kHz, VIN = 12V, VOUT = 5V

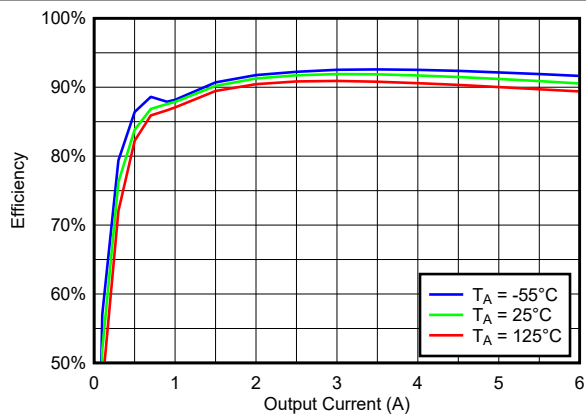

Figure 7-17. Efficiency vs Load Across Temperature at 500kHz, VIN = 12V, VOUT = 3.3V

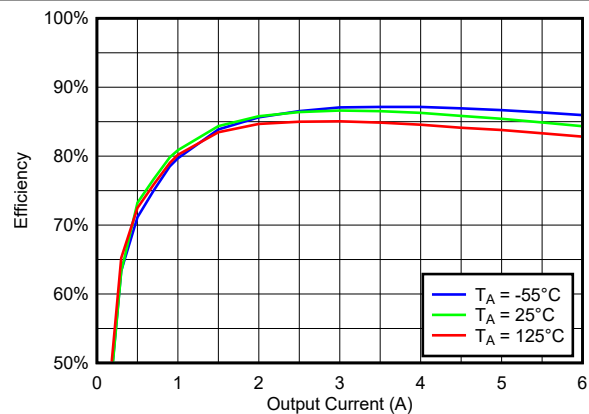
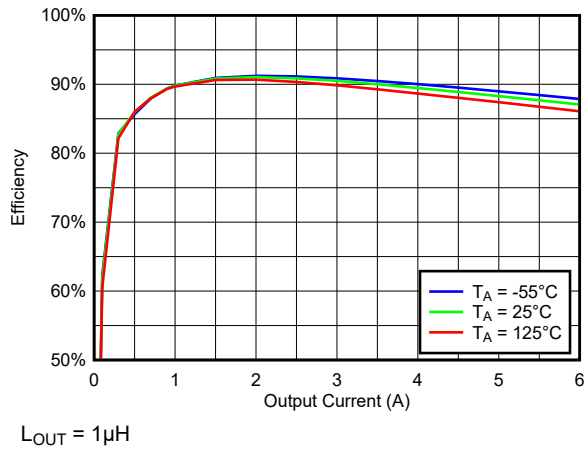

Figure 7-18. Efficiency vs Load Across Temperature at 500kHz, VIN = 12V, VOUT = 1.8V

7.7 Typical Characteristics (continued)

TPS7H4012 44-pin HTSSOP (DDW) package, $V_{IN} = PV_{IN}$, $V_{IN} = 12V$, $C_{SS} = 22nF$, Kemet MPXV1D2213L series inductor and SS10P4M3/87A Schottky diode for efficiency tests, $T_A = 25^\circ C$, unless otherwise noted.



$L_{OUT} = 1\mu H$

Figure 7-19. Efficiency vs Load Across Temperature at 1MHz, $V_{IN} = 5V$, $V_{OUT} = 2.5V$

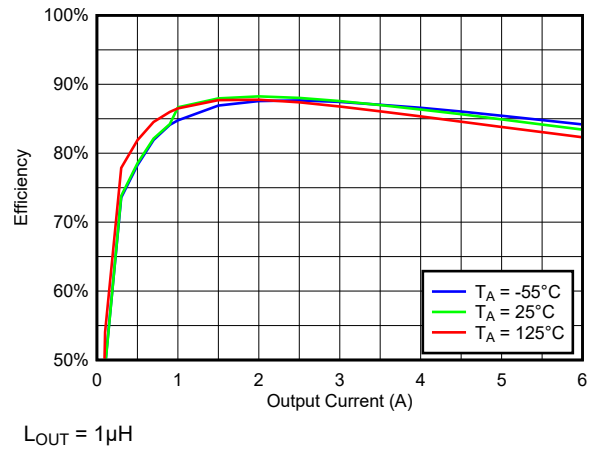

$L_{OUT} = 1\mu H$

Figure 7-20. Efficiency vs Load Across Temperature at 1MHz, $V_{IN} = 5V$, $V_{OUT} = 1.8V$

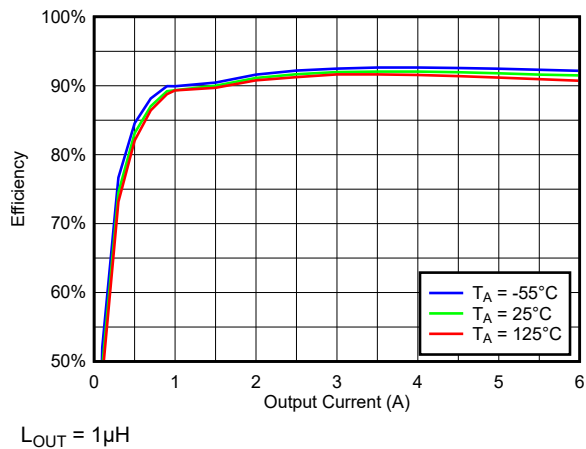

$L_{OUT} = 1\mu H$

Figure 7-21. Efficiency vs Load Across Temperature at 1MHz, $V_{IN} = 12V$, $V_{OUT} = 5V$

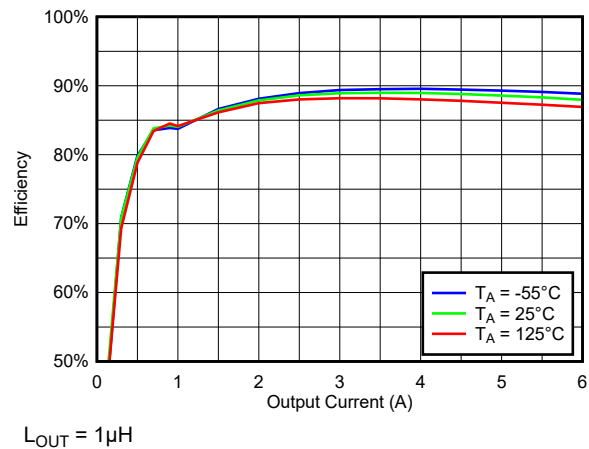

$L_{OUT} = 1\mu H$

Figure 7-22. Efficiency vs Load Across Temperature at 1MHz, $V_{IN} = 12V$, $V_{OUT} = 3.3V$

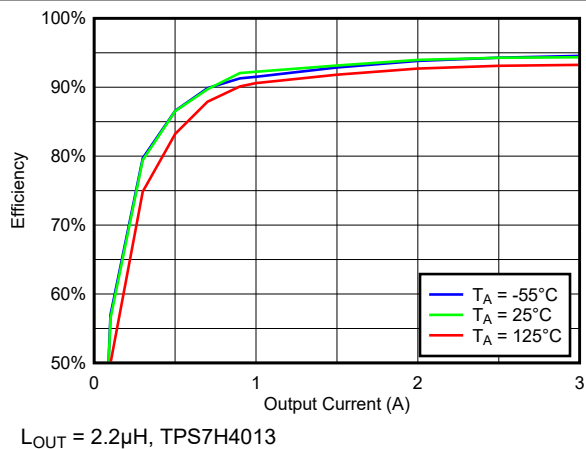

$L_{OUT} = 2.2\mu H$, TPS7H4013

Figure 7-23. Efficiency vs Load Across Temperature at 500kHz, $V_{IN} = 12V$, $V_{OUT} = 5V$ for TPS7H4013

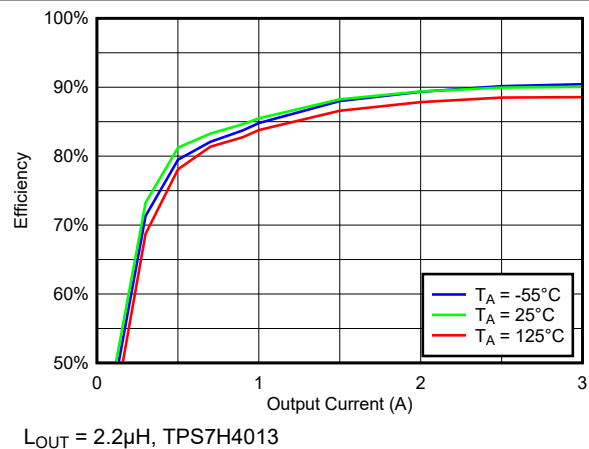

$L_{OUT} = 2.2\mu H$, TPS7H4013

Figure 7-24. Efficiency vs Load Across Temperature at 500kHz, $V_{IN} = 12V$, $V_{OUT} = 2.5V$ for TPS7H4013

7.7 Typical Characteristics (continued)

TPS7H4012 44-pin HTSSOP (DDW) package, $V_{IN} = PV_{IN}$, $V_{IN} = 12V$, $C_{SS} = 22nF$, Kemet MPXV1D2213L series inductor and SS10P4M3/87A Schottky diode for efficiency tests, $T_A = 25^\circ C$, unless otherwise noted.

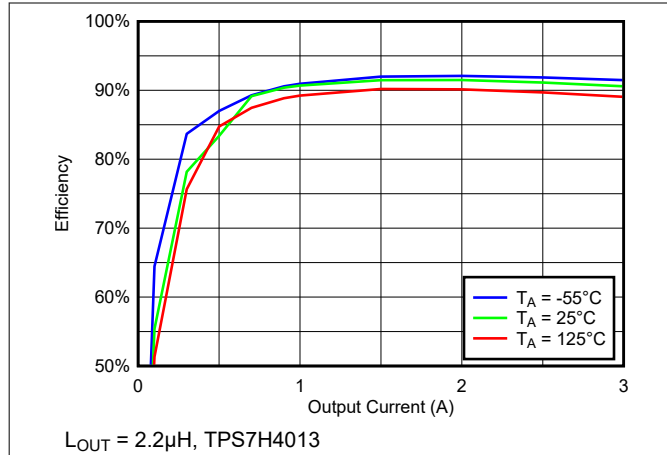

Figure 7-25. Efficiency vs Load Across Temperature at 500kHz, $V_{IN} = 5V$, $V_{OUT} = 1.8V$ for TPS7H4013

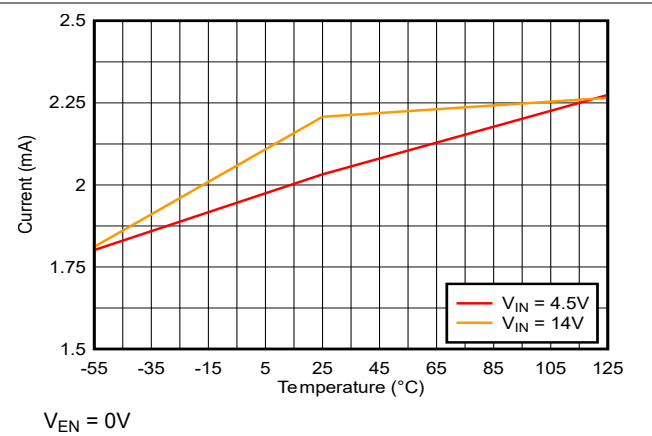

Figure 7-26. V_{IN} Shutdown Current vs Temperature

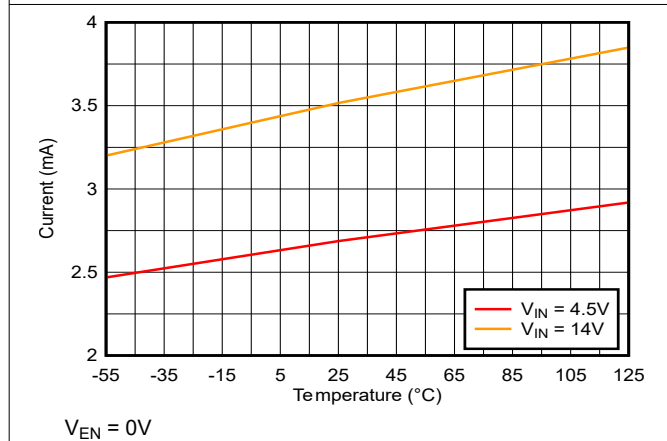

Figure 7-27. PV_{IN} Shutdown Current vs Temperature

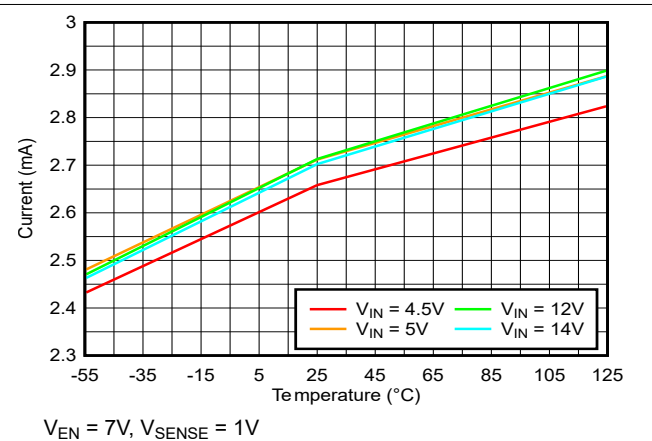

Figure 7-28. V_{IN} Quiescent Current (Non-switching) vs Temperature

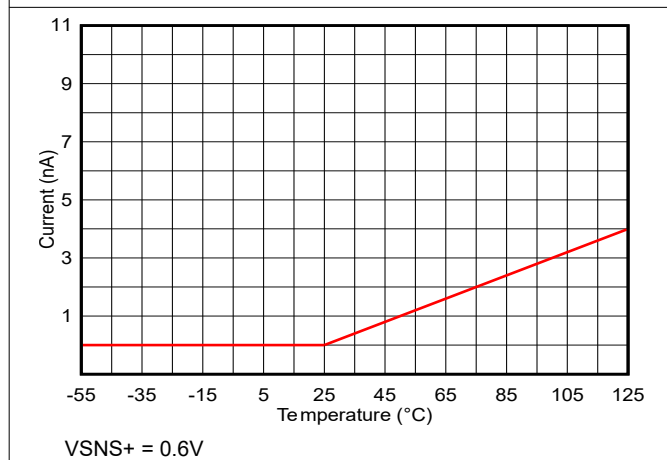

Figure 7-29. V_{SNS+} Leakage Current vs Temperature

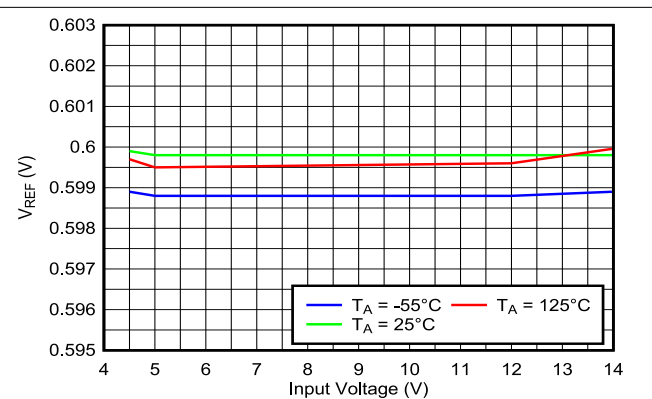
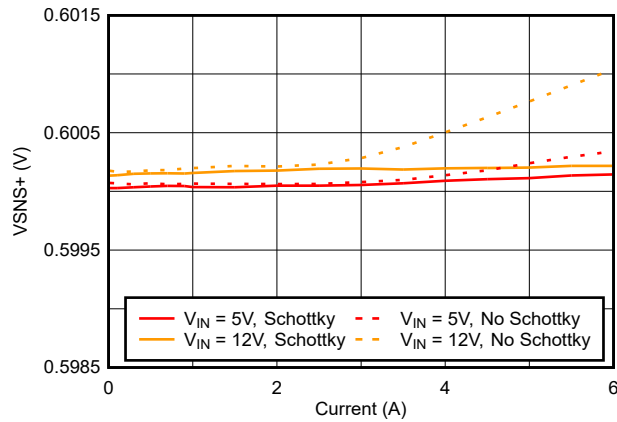

Figure 7-30. V_{REF} vs Input Voltage

7.7 Typical Characteristics (continued)

TPS7H4012 44-pin HTSSOP (DDW) package, $V_{IN} = PV_{IN}$, $V_{IN} = 12V$, $C_{SS} = 22nF$, Kemet MPXV1D2213L series inductor and SS10P4M3/87A Schottky diode for efficiency tests, $T_A = 25^\circ C$, unless otherwise noted.



$V_{OUT} = 1.8V$, $L_{OUT} = 2.2\mu H$, SS10P4M3/87A part number for Schottky tests

Figure 7-31. VSNS+ vs Output Current at 500kHz

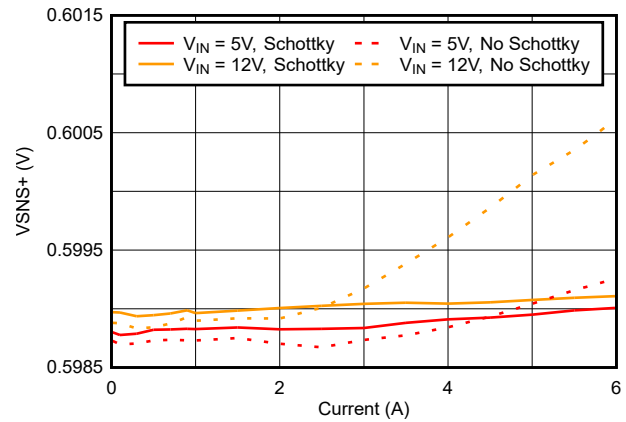

$V_{OUT} = 1.8V$ (for 5V input), $3.3V$ (for 12V input), $L_{OUT} = 1\mu H$, SS10P4M3/87A part number for Schottky tests

Figure 7-32. VSNS+ vs Output Current at 1MHz

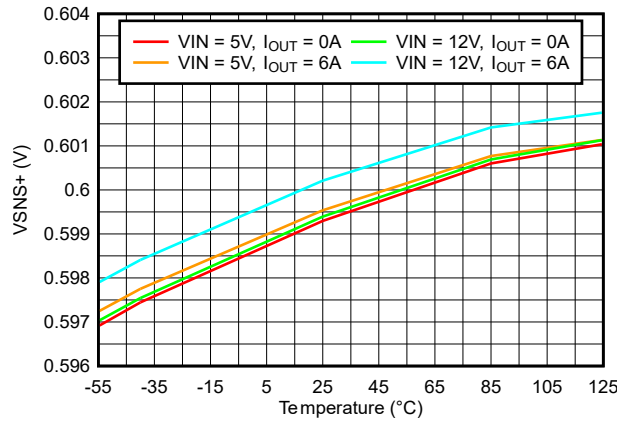

$L_{OUT} = 2.2\mu H$, $V_{OUT} = 3.3V$, No Schottky

Figure 7-33. VSNS+ vs Temperature at 500kHz

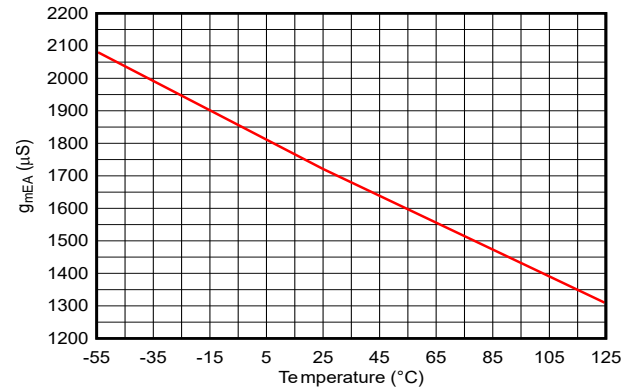

$V_{COMP} = 1V$

Figure 7-34. Error Amplifier Transconductance (g_{mEA}) vs Temperature

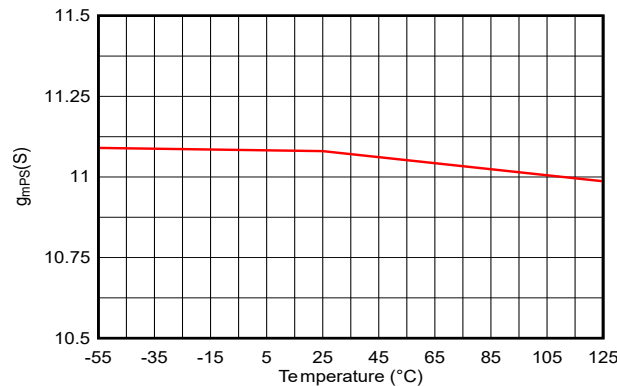

$V_{COMP} = 0.7V$

Figure 7-35. Power Stage Transconductance (g_{mPS}) vs Temperature for TPS7H4012

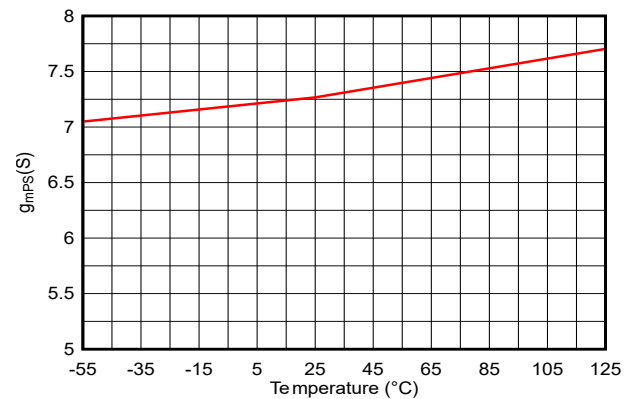

$V_{COMP} = 0.75V$

Figure 7-36. Power Stage Transconductance (g_{mPS}) vs Temperature for TPS7H4013

7.7 Typical Characteristics (continued)

TPS7H4012 44-pin HTSSOP (DDW) package, $V_{IN} = P_{VIN}$, $V_{IN} = 12V$, $C_{SS} = 22nF$, Kemet MPXV1D2213L series inductor and SS10P4M3/87A Schottky diode for efficiency tests, $T_A = 25^\circ C$, unless otherwise noted.

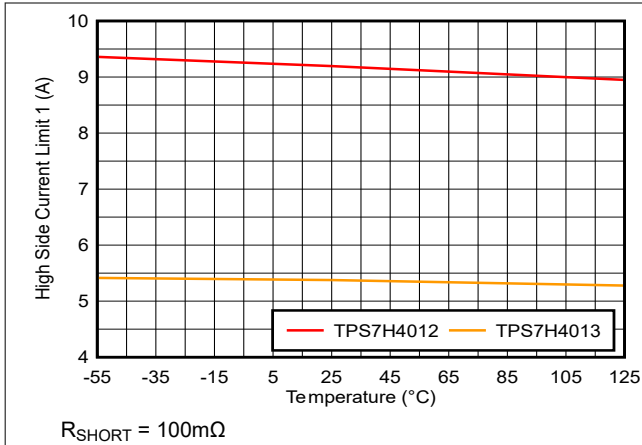

Figure 7-37. High-Side Current Limit Threshold 1 (I_{OC_HS1}) vs Temperature

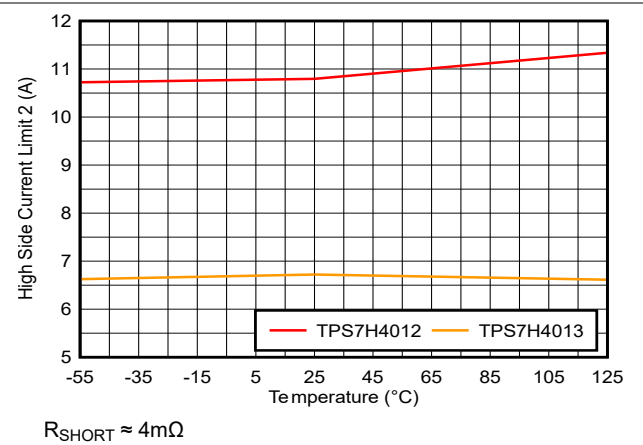

Figure 7-38. High-Side Current Limit Threshold 2 (I_{OC_HS2}) vs Temperature

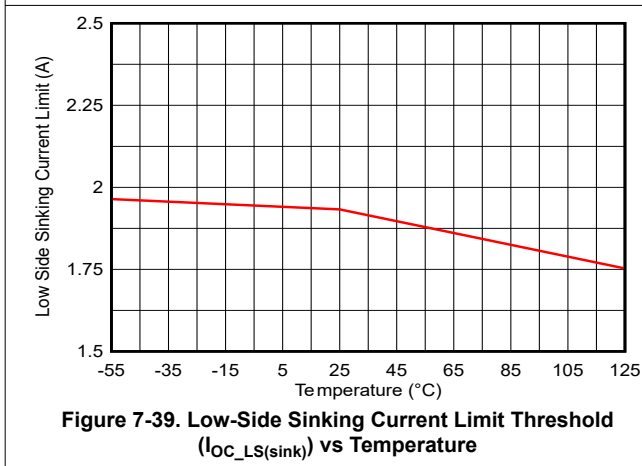

Figure 7-39. Low-Side Sinking Current Limit Threshold ($I_{OC_LS(sink)}$) vs Temperature

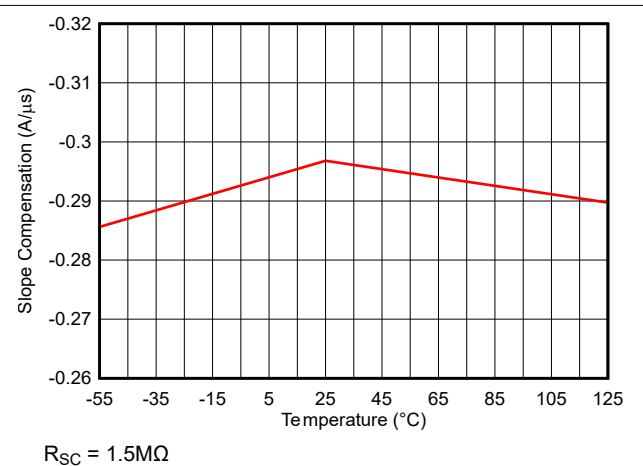

Figure 7-40. Slope Compensation vs Temperature at 100kHz

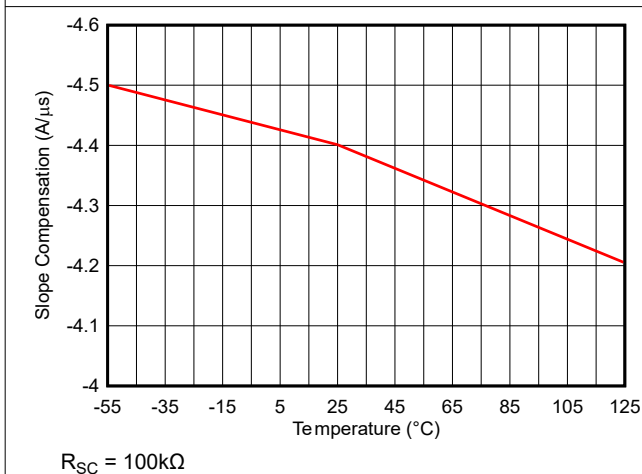

Figure 7-41. Slope Compensation vs Temperature at 500kHz

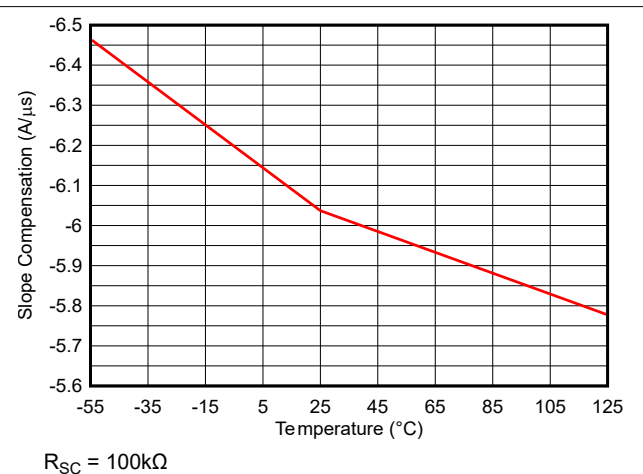
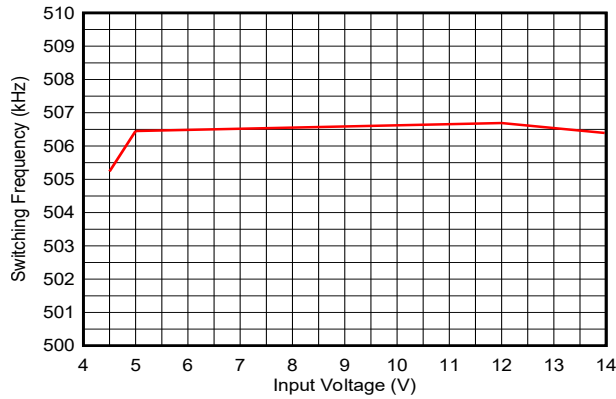

Figure 7-42. Slope Compensation vs Temperature at 1MHz

7.7 Typical Characteristics (continued)

TPS7H4012 44-pin HTSSOP (DDW) package, VIN = PVIN, VIN = 12V, CSS = 22nF, Kemet MPXV1D2213L series inductor and SS10P4M3/87A Schottky diode for efficiency tests, TA = 25°C, unless otherwise noted.



R_{RT} = 511kΩ

Figure 7-43. Switching Frequency vs Input Voltage

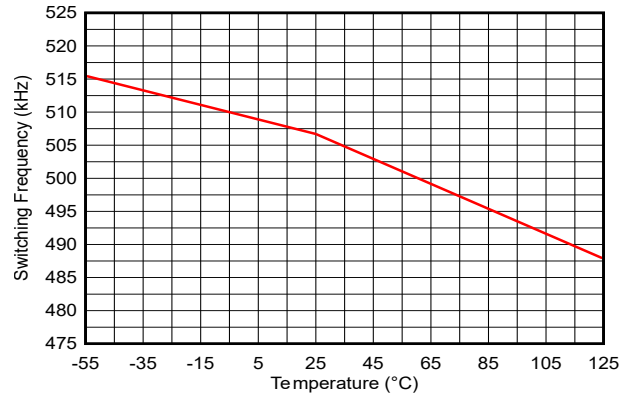

R_{RT} = 511kΩ

Figure 7-44. Switching Frequency vs Temperature

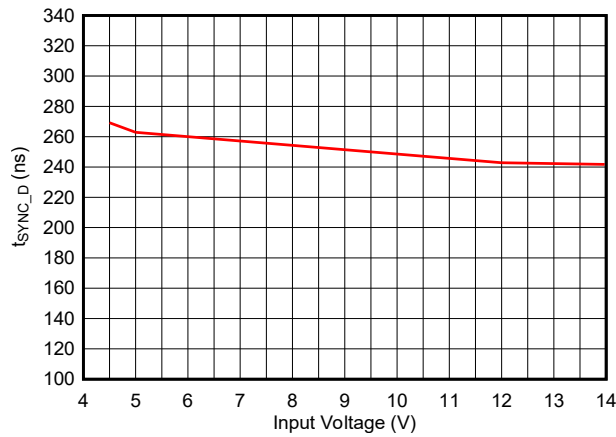

Figure 7-45. SYNC1 to SW Delay vs Input Voltage

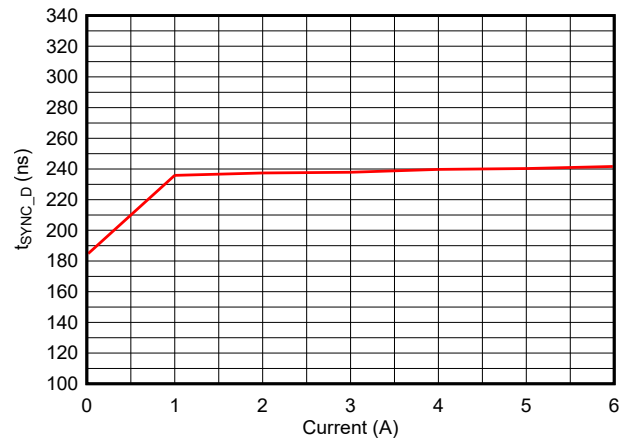
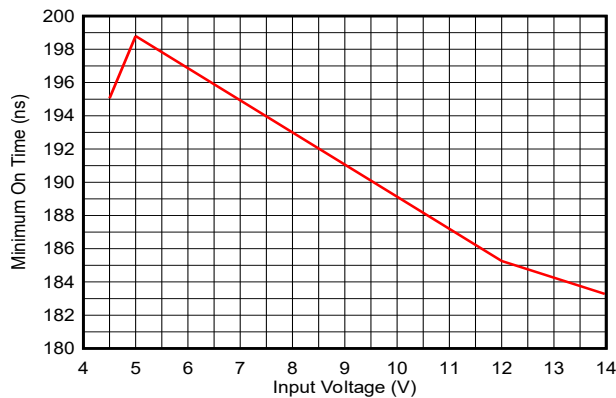
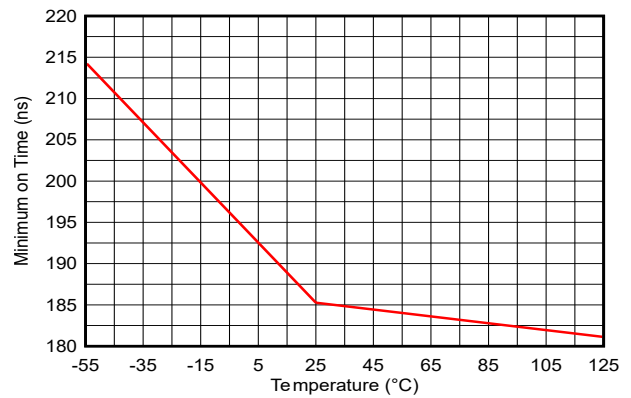

Figure 7-46. SYNC1 to SW Delay vs Output Current



50% to 50% of VIN, I_{SW} = 2A

Figure 7-47. Minimum On Time vs Input Voltage



50% to 50% of VIN, I_{SW} = 2A

Figure 7-48. Minimum On Time vs Temperature

7.7 Typical Characteristics (continued)

TPS7H4012 44-pin HTSSOP (DDW) package, $V_{IN} = P_{VIN}$, $V_{IN} = 12V$, $C_{SS} = 22nF$, Kemet MPXV1D2213L series inductor and SS10P4M3/87A Schottky diode for efficiency tests, $T_A = 25^\circ C$, unless otherwise noted.

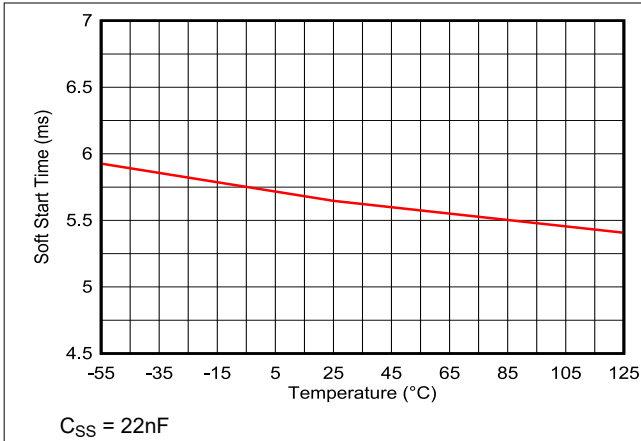

Figure 7-49. Soft Start Time vs Temperature

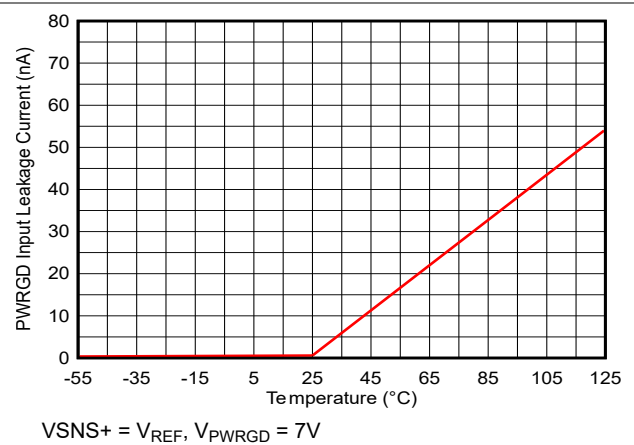

Figure 7-50. Power Good Leakage vs Temperature

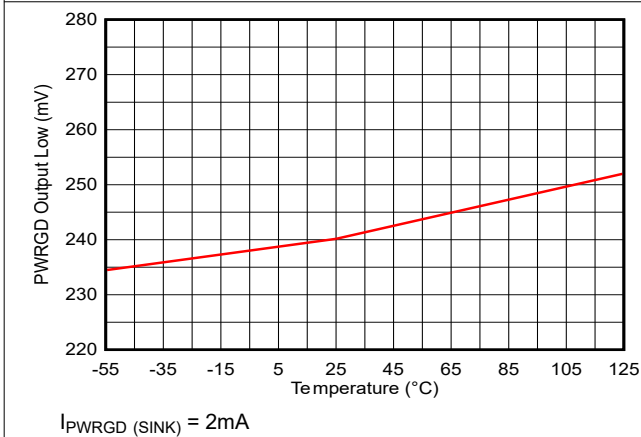

Figure 7-51. Power Good Output Low vs Temperature

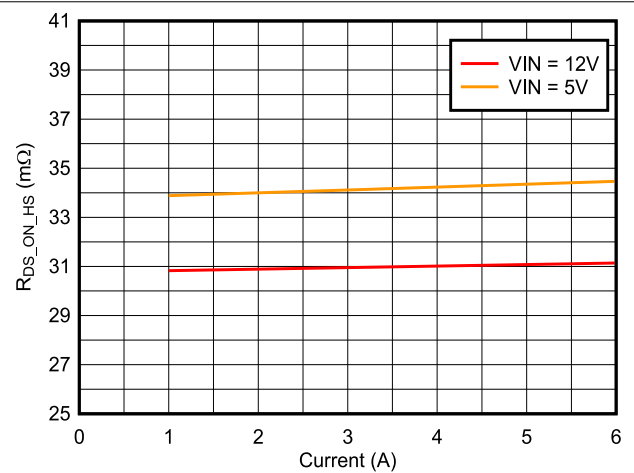

Figure 7-52. High Side FET Resistance vs Current

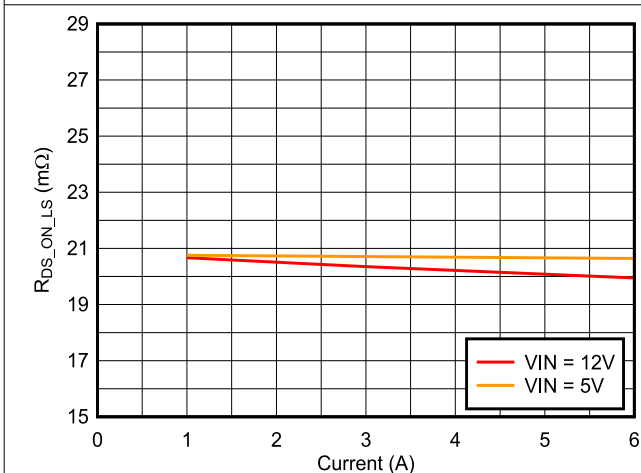

Figure 7-53. Low Side FET Resistance vs Current

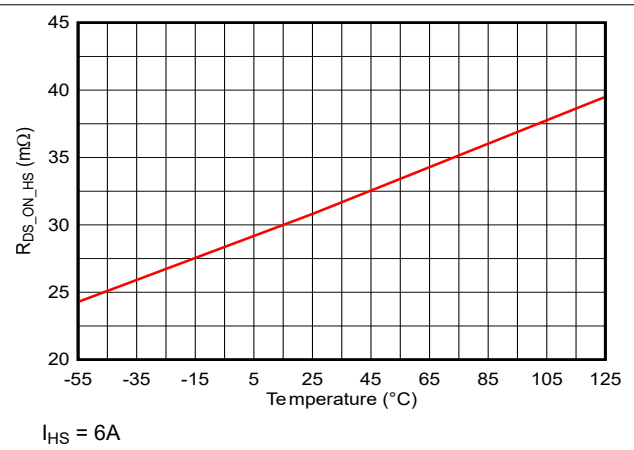
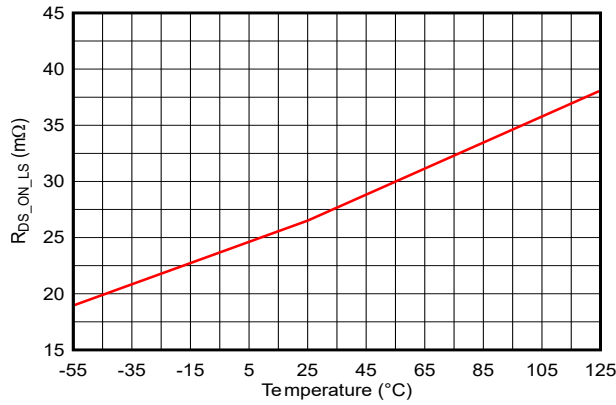

Figure 7-54. High Side FET Resistance vs Temperature

7.7 Typical Characteristics (continued)

TPS7H4012 44-pin HTSSOP (DDW) package, VIN = PVIN, VIN = 12V, C_{SS} = 22nF, Kemet MPXV1D2213L series inductor and SS10P4M3/87A Schottky diode for efficiency tests, T_A = 25°C, unless otherwise noted.



I_{LS} = 6A

Figure 7-55. Low Side FET Resistance vs Temperature

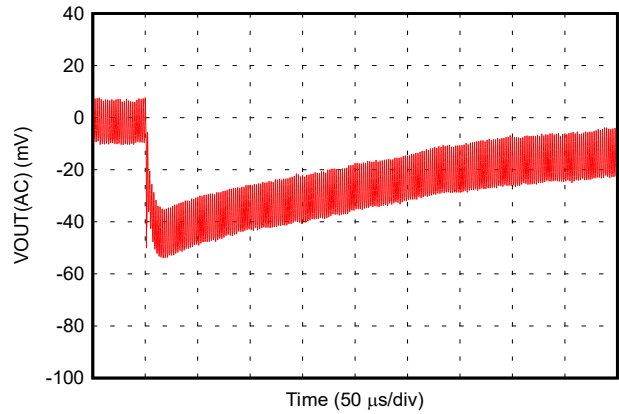

VOUT = 3.3V, f_{SW} = 500kHz, C_{OUT} = 693.1μF

Figure 7-56. Rising Load Step: 0A to 5.5A at 203A/μs

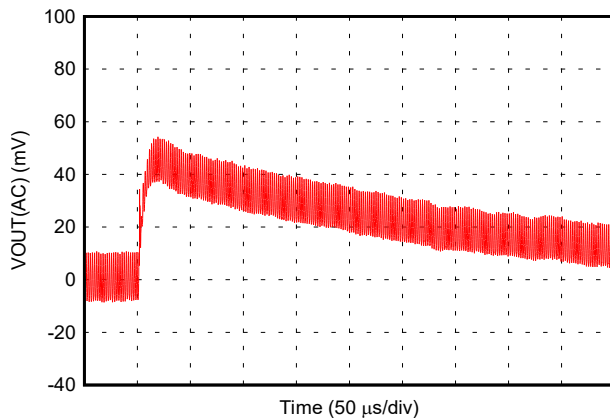

VOUT = 3.3V, f_{SW} = 500kHz, C_{OUT} = 693.1μF

Figure 7-57. Falling Load Step: 5.5A to 0A at 226A/μs

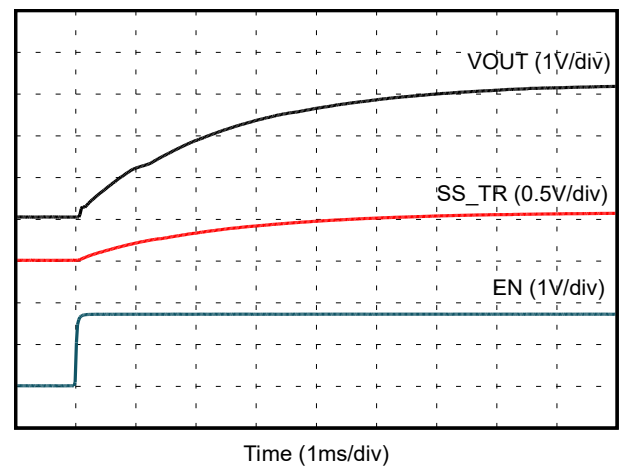

VOUT_(set) = 3.3V

Figure 7-58. Startup

8 Parameter Measurement Information

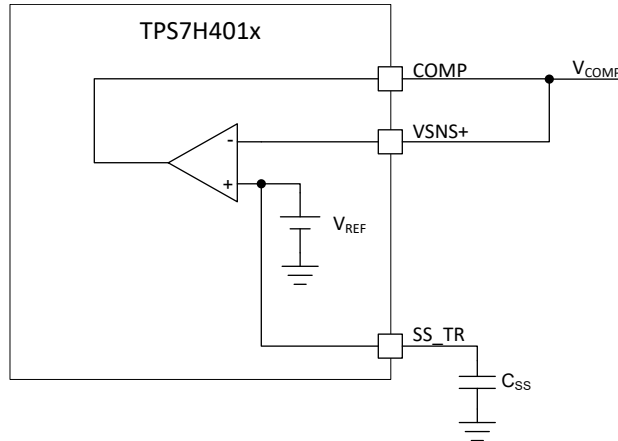

- A. $V_{REF} = V_{COMP}$. This accurate reference voltage value includes the error amplifier offset, V_{IO} . Use this value to set the output voltage.

Figure 8-1. Reference Voltage Measurement

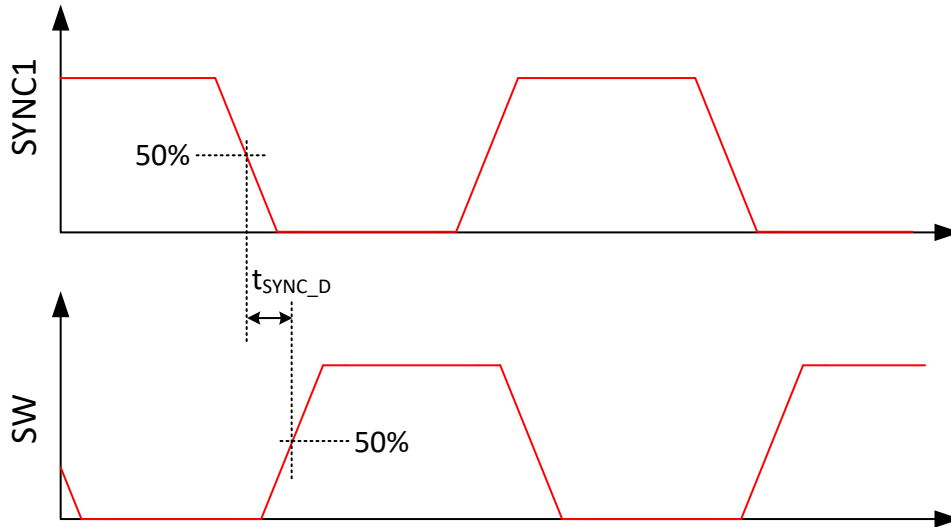

Figure 8-2. SYNC1 to SW Delay: Inverted Sync

9 Detailed Description

9.1 Overview

The TPS7H4012 and TPS7H4013 are 14V, 6A and 3A synchronous step-down (buck) converter with two integrated MOSFETs; a PMOS for the high side and an NMOS for the low side. To improve performance during line and load transients, the device implements a constant frequency, peak current mode control, which also simplifies external frequency compensation. The wide switching frequency range, 100kHz to 1MHz, allows for efficiency and size optimization when selecting the output filter components. The integrated MOSFETs allow for high-efficiency power supply designs with continuous output currents up to 6A. The MOSFETs have been sized to optimize efficiency for lower duty cycle applications.

9.2 Functional Block Diagram

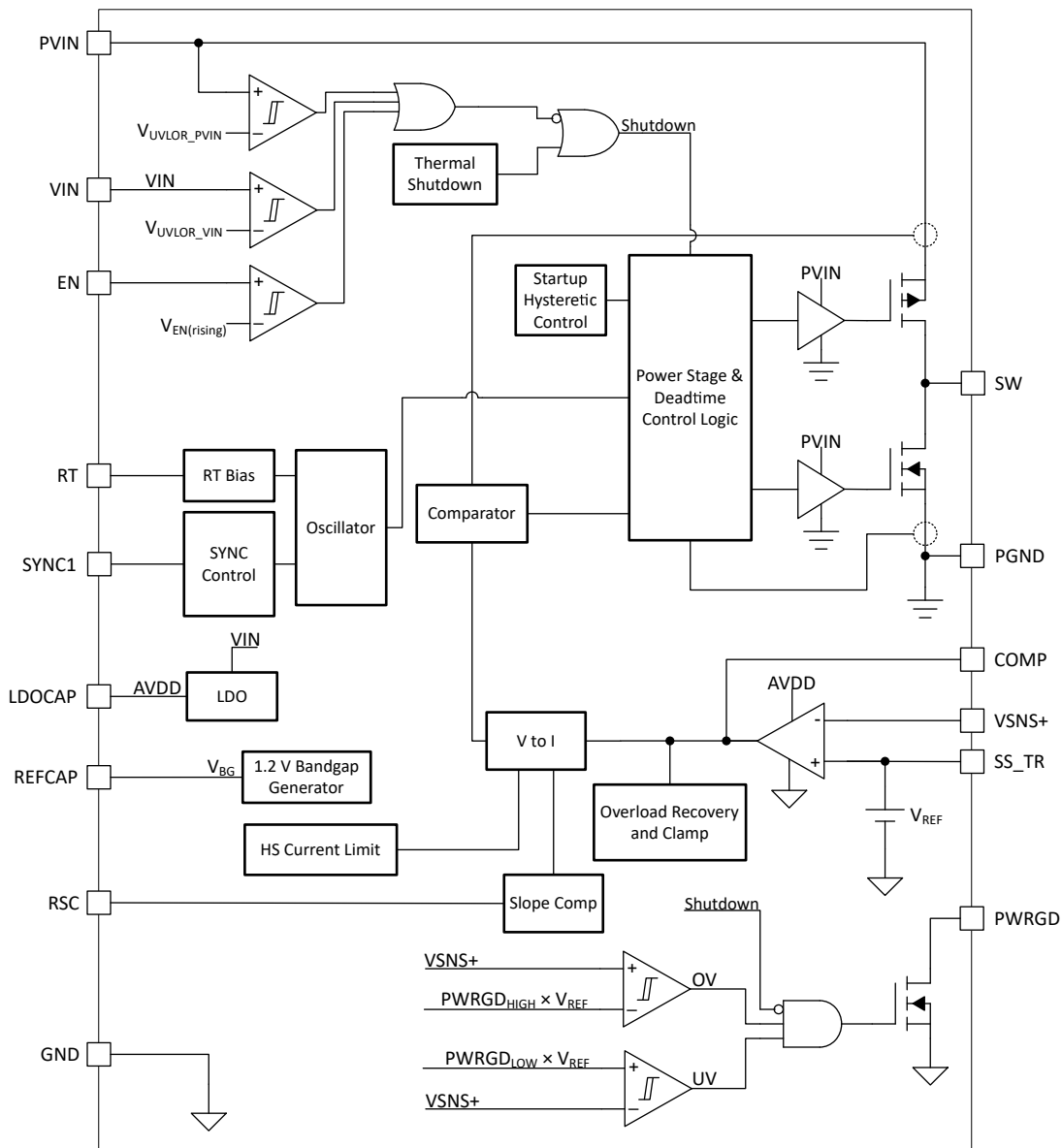

9.3 Feature Description

9.3.1 VIN and Power VIN Pins (VIN and PVIN)

The VIN pin provides power to internal control circuitry. The PVIN pins and PVIN pad provide the input voltage to the internal high side FET. Both pins have an input voltage range of 4.5V to 14V. The pins must be the same nominal voltage and they must power up and power down at the same time. Generally this is achieved by providing them from the same voltage source.

Both VIN and PVIN have individual UVLO (undervoltage lockout) rising thresholds, V_{UVLOR_VIN} and V_{UVLOR_PVIN} respectively. This is to ensure the device internal circuitry remains in a known off condition until a minimum voltage is reached. Additionally, VIN and PVIN have individual UVLO falling thresholds, V_{UVLOF_VIN} and V_{UVLOF_PVIN} respectively. If the voltage falls and these values are reached, the device will turn-off.

As described in [Section 9.3.4](#), a voltage divider connected to the EN pin can be utilized to configure the effective device UVLO.

9.3.2 Voltage Reference

The device generates an internal nominal 1.2V bandgap reference voltage, V_{BG} . This is the voltage present on the REFCAP pin during steady state operation. A 470nF capacitor to ground is required at the REFCAP pin for proper electrical operation as well as to ensure robust SET performance of the device. This bandgap voltage is used to derive the nominal 0.6V reference voltage for the error amplifier, $V_{REF(internal)}$.

The reference voltage that is fed into the error amplifier is utilized to set the output voltage. However, error amplifiers have intrinsic offset, V_{IO} , which contribute to the overall accuracy error. Therefore, the voltage that is actually used to set the output voltage is $V_{REF(internal)} + V_{IO}$. This combined value is defined as V_{REF} and is designed to be the accurate value to set the output voltage. V_{REF} is specified across line, temperature, and TID in the [Electrical Characteristics](#). Because V_{REF} is measured in an open loop configuration, the effects of switching frequency and load on V_{REF} are not included in the specification. See typical graphs [Figure 7-31](#) and [Figure 7-32](#) which show the minimal affect of current and switching frequency on the output sense voltage. See [Section 10.2.2.8](#) for more details on calculating the output voltage accuracy.

9.3.3 Voltage Sensing and Setting VOUT

The TPS7H401x features a VSNS+ pin for remote sensing. During steady state operation, VSNS+ will be equal to the reference voltage, V_{REF} (0.6V typical). By appropriately setting the resistor divider for VSNS+, the output voltage value across the load, V_{LOAD} , can be set using as shown in Figure 9-1. By connecting VSNS+ to the load, $R_{parasitic1}$ is accounted for and remote sensing is achieved. Note a good ground connection is recommended to avoid offset due to differences in ground between the load and the TPS7H401x.

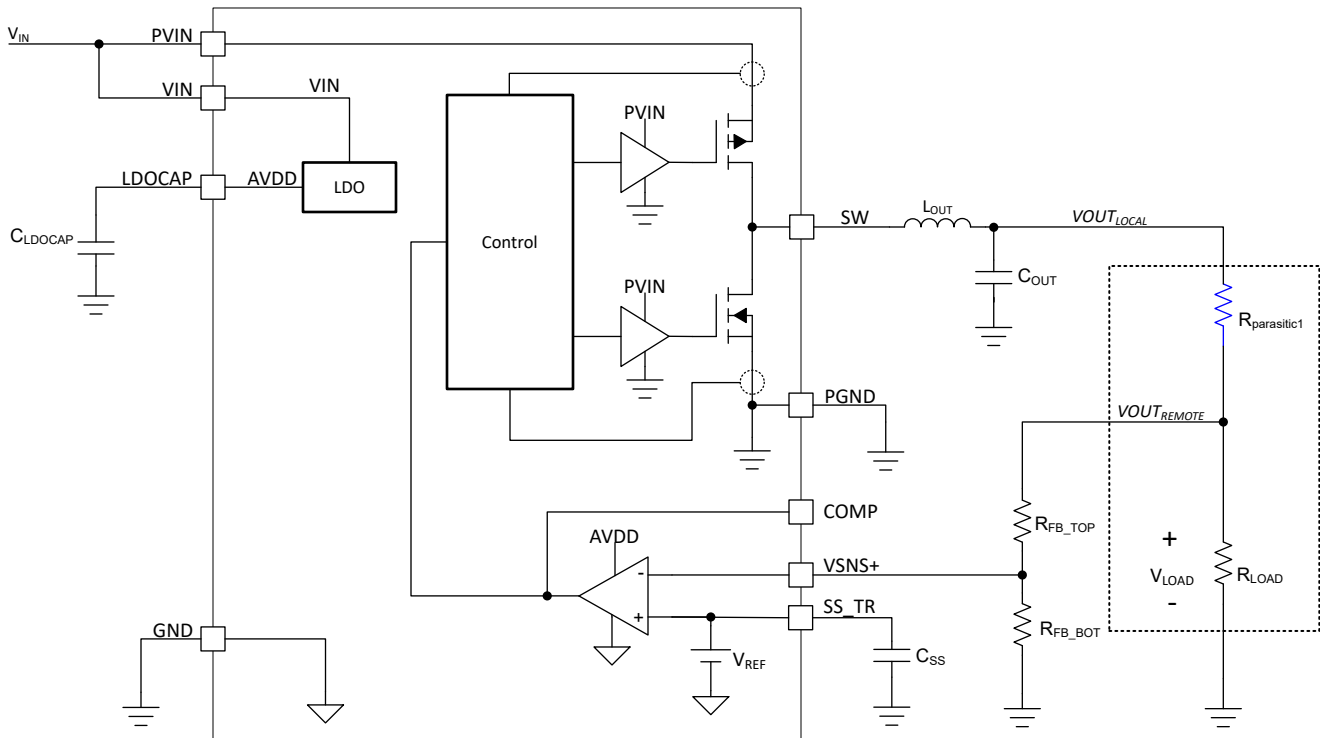

Figure 9-1. Voltage Sense Diagram

TI recommends 1% tolerance or better resistors. Start with a 10k Ω for R_{FB_TOP} and use Equation 1 to calculate R_{FB_BOT} . To improve efficiency at light loads, consider using larger value resistors. If the values are too high, the regulator is more susceptible to noise and voltage errors.

$$R_{FB_BOT} = \frac{V_{REF}}{V_{OUT(set)} - V_{REF}} \times R_{FB_TOP} \quad (1)$$

where

- $V_{REF} = 0.6V$ (typ)
- $V_{OUT(set)}$ = voltage set point; this is the voltage regulated across the load

9.3.3.1 Minimum Output Voltage

Like all current-mode control buck converters, there is a minimum configurable output voltage. First, the output voltage can never be lower than the internal voltage reference of 0.6V (typ). Additionally, the minimum on time, $t_{on(min)}$, will limit the minimum output voltage. $t_{on(min)}$ is specified as 250ns (max). See the [Electrical Characteristics](#) for more information. The minimum output voltage is approximated by Equation 2.

$$V_{OUT(min)} \approx V_{IN} \times t_{ON(min)} \times f_{SW} \quad (2)$$

In this equation:

- $V_{OUT(min)}$ is the minimum possible output voltage
- V_{IN} is the input voltage for the application
- $t_{on(min)}$ is the minimum on-time; use the maximum $t_{on(min)}$ value for the worst case calculation
- f_{SW} is the switching frequency; use the maximum possible f_{SW} for the worst case calculation

Table 9-1 shows calculated minimum output voltages for selected values of f_{SW} and V_{IN} assuming $t_{on(min)} = 250\text{ns}$.

Table 9-1. Calculated Minimum Output Voltages

f_{SW}	V_{IN}	$V_{OUT(min)}$
100kHz	5V	0.6V ⁽¹⁾
	12V	0.6V ⁽¹⁾
	14V	0.6V ⁽¹⁾
500kHz	5V	0.625V
	12V	1.5V
	14V	1.75V
1MHz	5V	1.25V
	12V	3V
	14V	3.5V

(1) The calculated value is lower, but the minimum is limited to V_{REF} itself which is typically 0.6V.

9.3.3.2 Maximum Output Voltage

The TPS7H401x has a maximum output voltage due to the minimum off time, $t_{off(min)}$. This minimum off time is not due to an internal charge pump like some buck regulators. Instead, the minimum off time is to maintain switching noise and internal circuitry behavior does not cause excessive duty cycle jitter. The maximum output voltage is approximated by Equation 2.

$$V_{OUT(max)} \approx V_{IN} \times (1 - t_{OFF(min)} \times f_{SW}) \quad (3)$$

In this equation:

- $V_{OUT(max)}$ is the maximum possible output voltage
- V_{IN} is the input voltage for the application
- $t_{off(min)}$ is the minimum off-time
- f_{SW} is the switching frequency

Table 9-2 shows calculated maximum output voltages for selected values of f_{SW} and V_{IN} assuming $t_{off(min)} = 306\text{ns}$.

Table 9-2. Calculated Maximum Output Voltages

f _{sw}	V _{IN}	V _{OUT} (max)
100kHz	5V	4.85V
	12V	11.63V
	14V	13.57V
500kHz	5V	4.24V
	12V	10.16V
	14V	11.86V
1MHz	5V	3.47V
	12V	8.33V
	14V	9.72V

9.3.4 Enable

When the enable pin is low, the device will enter shutdown mode and not regulate the output voltage. Normally, an external resistor divider from V_{IN} to GND is used to feed EN. The resistors can be appropriately sized to turn on the device when a desired preset input voltage is reached as shown in Equation 4. This can be used to create an adjustable UVLO to compliment the default internal UVLO voltage on the V_{IN} and P_{VIN} pins.

$$R_{EN_BOT} = \frac{V_{EN(rising)}}{V_{IN(rising)} - V_{EN(rising)}} \times R_{EN_TOP} \quad (4)$$

where

- V_{IN(rising)} = the V_{IN} value that will cause EN to go high
- V_{EN(rising)} = 0.61V (typ)
- R_{EN_TOP} = feedback resistor from V_{IN} to EN
- R_{EN_BOT} = feedback resistor from EN to GND

The EN pin has 100mV (typ) of hysteresis. Therefore, Equation 5 can be used to calculate the V_{IN(falling)} voltage.

$$V_{IN(falling)} = V_{EN(falling)} \times \frac{R_{EN_TOP} + R_{EN_BOT}}{R_{EN_BOT}} \quad (5)$$

where

- V_{IN(falling)} = the V_{IN} value that will cause EN to go low and turn-off the TPS7H401x
- V_{EN(falling)} = 0.51V (typ)

Alternatively, the EN pin may be driven directly from a microcontroller or FPGA. The low voltage threshold of the enable pin aids in support of 1.1, 1.8, 2.5, and 3.3V logic levels.

9.3.5 Power Good (PWRGD)

The PWRGD pin is an open-drain output that is asserted when the output voltage reaches an appropriate range. The PWRGD pin may be pulled-up through a resistor to V_{OUT} or to another voltage level within the device recommended operating conditions. Select the resistor size to keep the maximum current sunk by PWRGD to under the recommended operating condition current maximum of 2mA. Generally a pull up resistor of 10kΩ is sufficient. Using a larger value resistor will minimize power dissipation but may allow switching noise to couple into the PWRGD signal due to the weaker pull-up.

PWRGD will be asserted or deasserted when V_{OUT} is within a certain percentage of its programmed value. This is accomplished by comparing the voltage on V_{SNS+} to V_{REF}. For example, when V_{SNS+} reaches PWRGD_{LOW_R%} (typically 95%) of its final value, PWRGD is asserted. When V_{SNS+} falls below PWRGD_{LOW_F%} (typically 92%), PWRGD is deasserted. See Figure 9-2 for these waveforms.

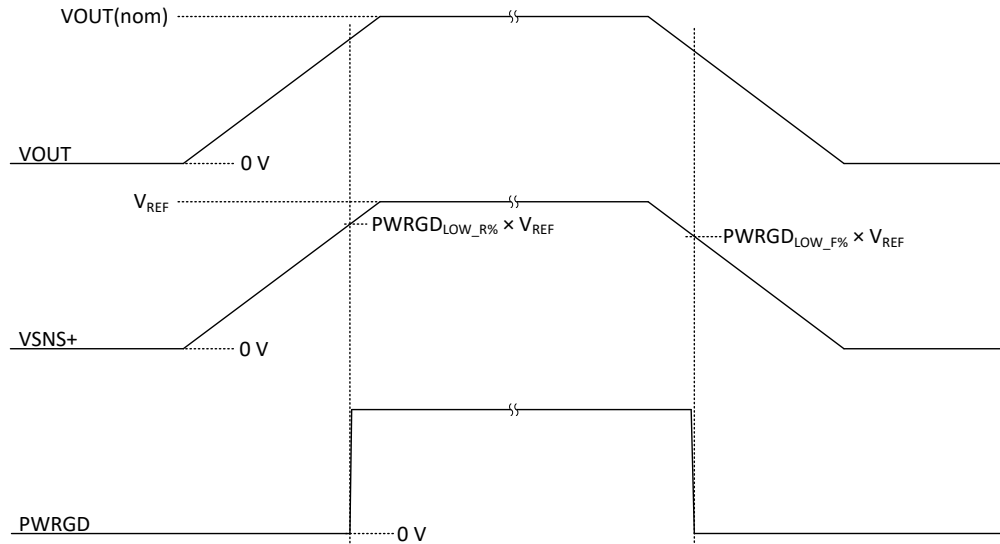

Figure 9-2. Power Good Low Thresholds

Power good also has a threshold if an overvoltage event occurs on VOUT. For example, when VSNS+ reaches $PWRGD_{HIGH_R\%}$ (typically 108%) of its final value, PWRGD is deasserted. When VSNS+ falls below $PWRGD_{HIGH_F\%}$ (typically 105%), PWRGD is asserted. See [Figure 9-3](#) for these waveforms.

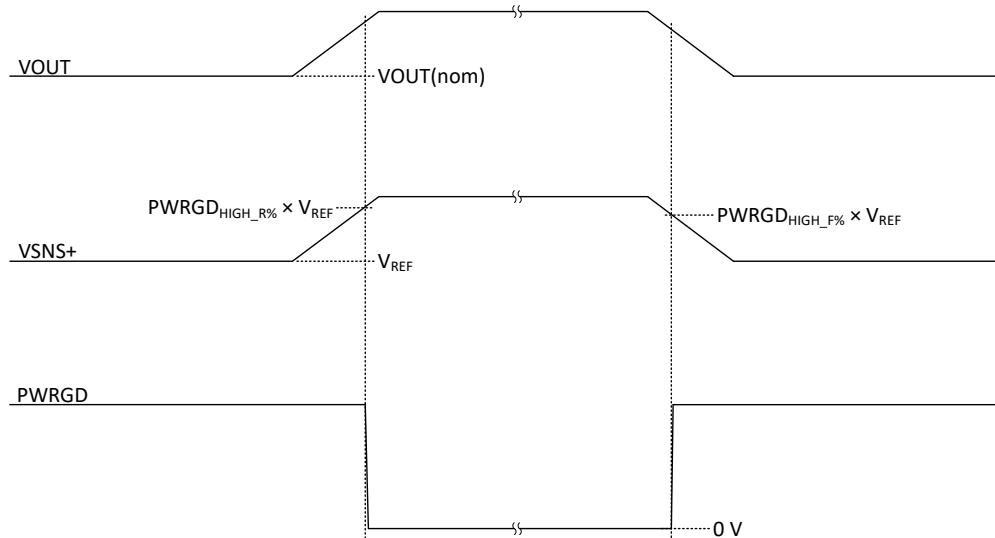

Figure 9-3. Power Good High Thresholds

The PWRGD is in a defined state when the VIN input voltage is greater than 2V but has reduced current sinking capability. The PWRGD achieves full current sinking capability by the time VIN reaches 4.5V. See VIN_{MIN_PWRGD} in the [Electrical Characteristics](#).

In addition to the description of PWRGD above, PWRGD is deasserted during other conditions that cause regulation to stop such as:

- VIN or PVIN are in UVLO
- The device is in thermal shutdown
- The device EN pin is deasserted
- the COMP pin reaches the $COMP_{SHDN}$ threshold (1.9V typical)

9.3.6 Adjustable Switching Frequency and Synchronization

There are multiple clocking mode options to enable use of both the programmable internal clock and an externally synchronized clock. This allows flexibility to synchronize devices to a system clock. The modes are listed in [Table 9-3](#).

Table 9-3. Clock Modes

MODE	RT	SYNC1 INPUT
Internal clock	Resistor from RT to GND	None
External clock: default f_{SW}	Resistor from RT to GND	Input f_{SW} 180° out of phase
External clock: no default f_{SW}	Float	Input f_{SW} 180° out of phase

9.3.6.1 Internal Clock Mode

The TPS7H401x is configured for internal clock mode if the RT pin is populated and no external clock is input on SYNC1. In internal clock mode (also sometimes called internal oscillator mode), a resistor is connected between the RT pin and GND to configure the switching frequency, f_{SW} , of the device. The nominal switching frequency is adjustable from 100kHz to 1MHz depending on the RT resistor value, which can be calculated using [Equation 6](#). [Figure 9-4](#) shows the relationship curve between the RT resistor value and the configurable switching frequency range.

$$RT = 86,090 \times f_{SW}^{-1.104} \quad (6)$$

where

- RT in kΩ
- f_{SW} in kHz

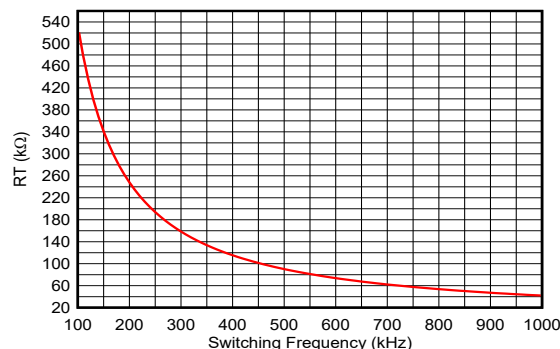

Figure 9-4. Nominal RT vs Switching Frequency

9.3.6.2 External Clock Mode

The TPS7H401x is configured for external clock mode if a clock signal is input on SYN1. In this mode, a clock is input on SYNC1 and the TPS7H401x switching will switch 180° out of phase with SYNC1.

In external clock mode, RT may be left floating as it is not required to program the switching frequency with a resistor from RT to GND. However, a resistor from RT to GND must be configured (as shown in [Section 9.3.6.1](#)) if it is desired to have a fallback default switching frequency if the input clock is not available (such as before the clock is provided to the TPS7H401x device or during a clock fault). If RT is populated in this mode and no external clock signal is detected for $t_{CLK_E_I}$ (typically 2 clock cycles), the TPS7H401x will transition to the internal clock. This is shown in [Figure 9-5](#). If the external clock is again provided, it will switch back to the external clock in $t_{CLK_I_E}$ (typically 1 clock cycle). This is shown in [Figure 9-6](#). When this configuration is utilized, program the internal clock frequency to the same nominal value as the external clock frequency.

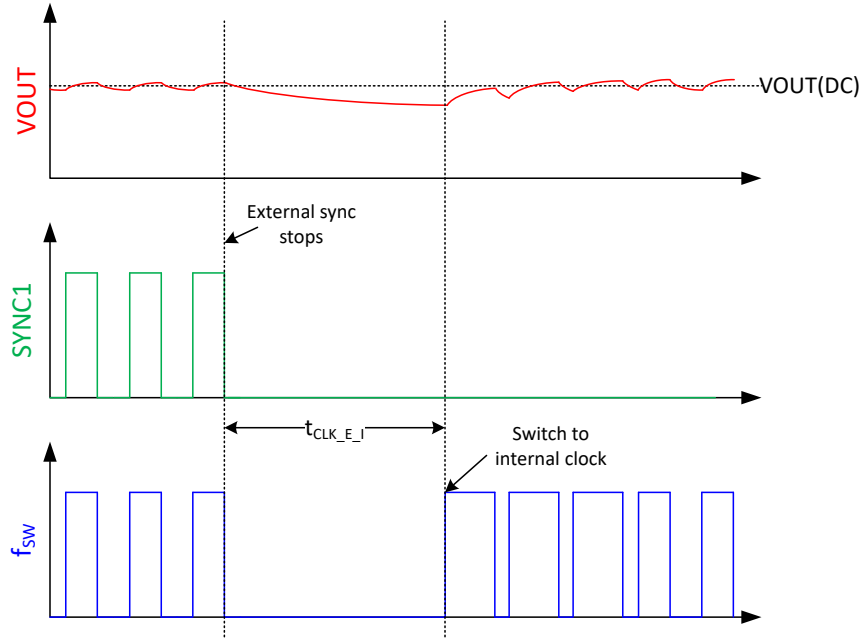

Figure 9-5. External to Internal Clock Transition

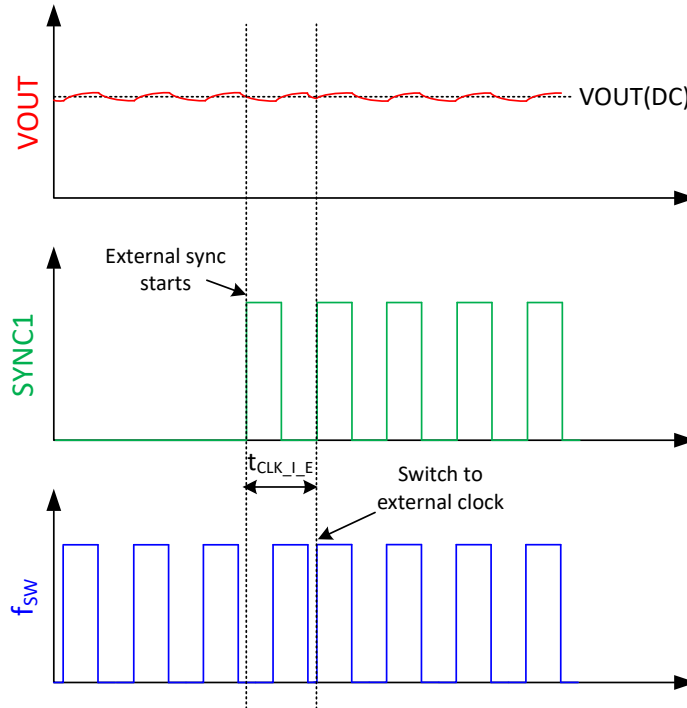

Figure 9-6. Internal to External Clock Transition

The external clock may be provided by an oscillator, FPGA, or other suitable device. Alternatively, the external clock may be provided by a [TPS7H4011](#) device that is configured in internal oscillator mode.

9.3.7 Turn-On Behavior

The device will enter into a pulse-skipping mode (hysteretic mode) during startup in the event that VSNS+ is greater than the voltage at the SS_TR pin. During this period, the high-side switch will remain off and the low-side switch will remain on until VSNS+ again falls below the voltage at SS_TR. This is because a lower output voltage is needed than that supported by the minimum on time.

Thus, instantaneous output pulses can be higher or lower than the desired voltage. This behavior is evident when operating at high frequency with high bandwidth or with high VIN to VOUT ratios. When the minimum on-pulse is greater than the minimum controllable on-time, the pulse-skipping behavior is generally not observed at startup.

9.3.7.1 Soft-Start (SS_TR)

A capacitor at the SS_TR pin is utilized to slow the rise of the internal reference voltage, $V_{REF(internal)}$. By slowing the rise of the reference voltage during startup, the output voltage slew rate is controlled. This is useful to prevent excessive inrush current.

Measured soft start time for the SS_TR voltage to rise from 10% to 90% of the value are detailed in the [Electrical Characteristics](#). Generally a 22nF or larger ceramic C_{SS} capacitor is recommended; however, values down to 5.6nF are shown if a faster startup is desired. Additionally, [Equation 7](#) can be used to approximate startup equations for arbitrary capacitor values.

$$t_{SS} = 0.25 \times C_{SS} \quad (7)$$

Where:

- t_{SS} in ms
- C_{SS} in nF

Note that the SS_TR pin follows that of an RC charging circuit curve. Therefore, the output voltage follows a similar curve.

When any of the following scenarios occur, the SS_TR pin is discharged through the internal $R_{SS(discharge)}$ pull-down resistor (typically 442 Ω):

- the input UVLO is triggered,
- the EN pin is pulled below $V_{EN(falling)}$ (0.51V typical)
- the COMP pin reaches the $COMP_{SHDN}$ threshold (1.9V typical)
- a thermal shutdown event occurs

When the SS_TR pin is discharged, the device cannot restart again until the device has discharged to below $SS_{startup}$ (typically 20mV) to maintain proper soft-start behavior.

9.3.7.2 Safe Start-Up Into Prebiased Outputs

The device prevents the low-side MOSFET from continuously discharging a prebiased output.

9.3.7.3 Tracking and Sequencing

Many of the common power-supply sequencing methods can be implemented using the SS_TR, EN, and PWRGD pins.

The sequential method is shown in [Figure 9-7](#) using two TPS7H401x devices. The PWRGD pin of the first device is coupled to the EN pin of the second device, which enables the second power supply after the primary supply reaches regulation. If a further delay is desired between sequencing the first and second device, an optional C_{PWRGD} capacitor can be included on PWRGD as well. This causes an RC delay based on the value of the power good pull-up resistor and capacitor utilized.

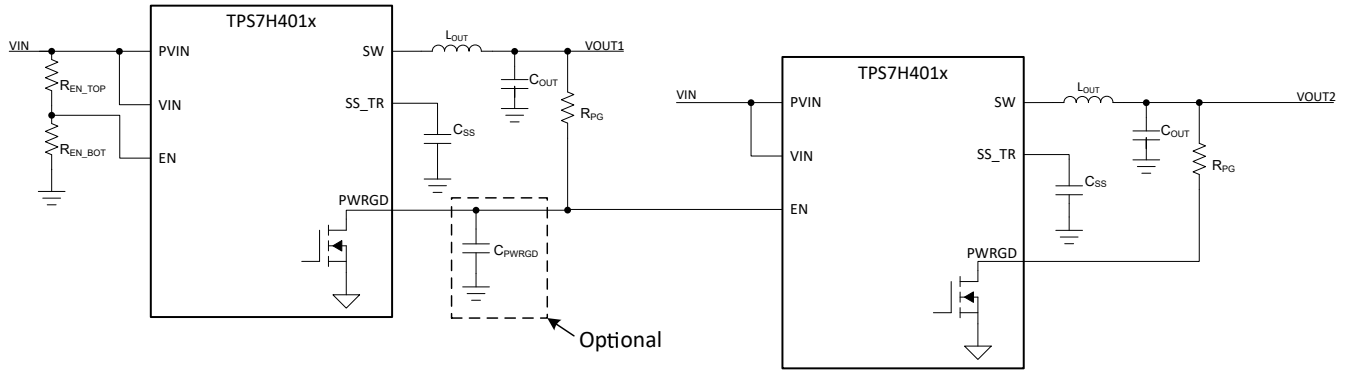

Figure 9-7. Sequential Start-Up Sequence

Figure 9-8 shows the method implementing ratiometric sequencing by connecting the SS_TR pins of two devices together. The regulator outputs ramp up and reach regulation at the same time. Note that in this configuration, the SS_TR voltage tends toward the average of the two parts since SS_TR is the internal voltage reference of the device. This causes some additional voltage error on the outputs of each device. This is because the precise V_{REF} utilized for the control loop takes into account the offset of each individual devices error amplifier only when operating with the SS_TR.

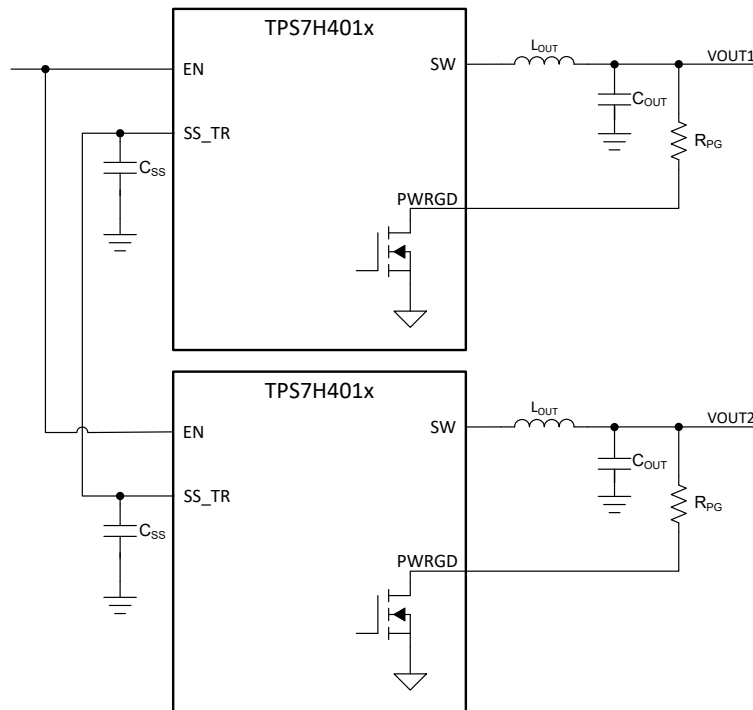

Figure 9-8. Ratiometric Start-Up Sequence

9.3.8 Protection Modes

The following protection modes are detailed in the following sections:

- Overcurrent Protection: [Section 9.3.8.1](#)
 - High-Side 1 Overcurrent Protection (HS1): [Section 9.3.8.1.1](#)
 - High-Side 2 Overcurrent Protection (HS2): [Section 9.3.8.1.2](#)
 - COMP Shutdown: [Section 9.3.8.1.3](#)
 - Low-Side Overcurrent Sinking Protection: [Section 9.3.8.1.4](#)
- Output Overvoltage Protection (OVP): [Section 9.3.8.2](#)
- Thermal Shutdown: [Section 9.3.8.3](#)

9.3.8.1 Overcurrent Protection

The TPS7H401x device employs multiple overcurrent protection mechanisms. The device is primarily protected from overcurrent conditions with cycle-by-cycle current limiting for the high-side MOSFET. This current limit is termed high side 1 overcurrent protection (HS1), and its value is selectable between four distinct current limits by utilizing the ILIM pin. Additional secondary protection is provided through high side 2 overcurrent protection (HS2). Finally, tertiary protection is provided through COMP shutdown. In addition to the various high-side current limit protections, a low-side sinking overcurrent protection mechanism is also provided by the TPS7H401x. These current protection mechanisms are detailed in the subsequent sections

9.3.8.1.1 High-Side 1 Overcurrent Protection (HS1)

The device implements current mode control, which uses the COMP pin voltage to control the turn-off of the high-side MOSFET and the turn-on of the low-side MOSFET on a cycle-by-cycle basis. Each cycle the switch current and the current reference generated by the COMP pin voltage are compared. When the peak switch current intersects the programmed high side current, I_{OC_HS1} , the high-side switch is commanded off (although the high side is on for at least the minimum on time, t_{ON}).

HS1 is implemented utilizing the COMP voltage. As the device approaches I_{OC_HS1} , COMP increases which causes the g_{mps} of the device to approach zero. Therefore, at high enough values of COMP, the output current is essentially clamped to the selected value. This functionality is shown in the simplified waveforms of [Figure 9-9](#).

Note that the I_{OC_HS1} threshold specification is measured in an open loop configuration due to testability limitations while actual short circuit events are dynamic and in closed loop. In most cases, the resulting current limit value is 1similar, but in some short circuit conditions, the values can exceed the specified thresholds. This is particularly true at low values of INPUT VOLTAGE (such as under 5V), higher switching frequencies, and colder temperatures

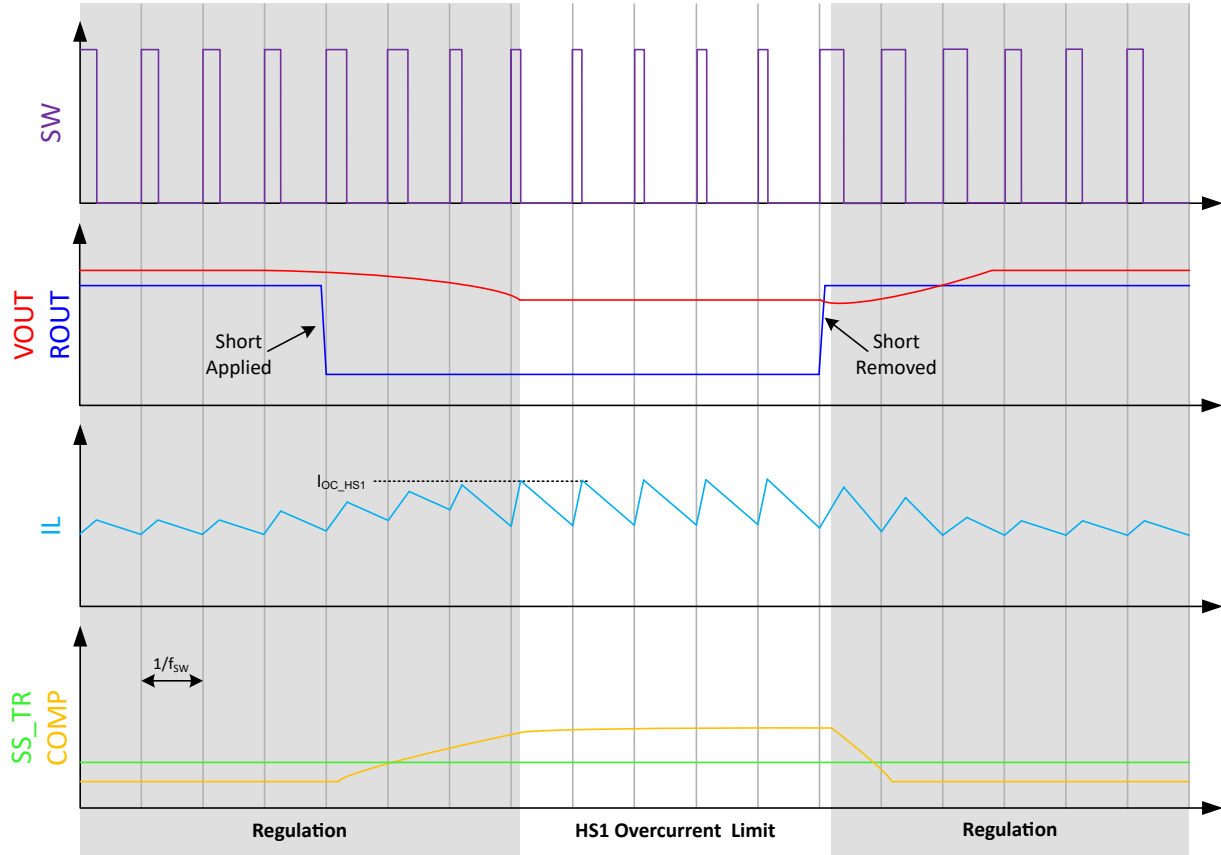

Figure 9-9. High-Side 1 Overcurrent Protection

The high side 1 overcurrent protection (HS1) threshold value is typically 9.7A for the TPS7H4012 and 5.6A for the TPS7H4013. By limiting the current to a specific value, an inductor can be appropriately sized to handle the maximum current. The recommended DC maximum output current is 6A for the TPS7H4012 and 3A for the TPS7H4013.

9.3.8.1.2 High-Side 2 Overcurrent Protection (HS2)

Sometimes, the HS1 current limit is not sufficient to protect the device. For example, a short circuit can be so aggressive that even if the high side is only on for the minimum on time, t_{ON} , the current continues to rise. To mitigate this risk, the TPS7H401x implements a secondary overcurrent protection in the form of high-side overcurrent protection 2 (HS2).

The HS2 current limit is reached when the current through the high side MOSFET meets or exceeds I_{OC_HS2} . To prevent sustained current increase, the next four high-side cycles are skipped while the low side MOSFET remains on to discharge the inductor. The simplified waveforms of this operation are shown in Figure 9-10.

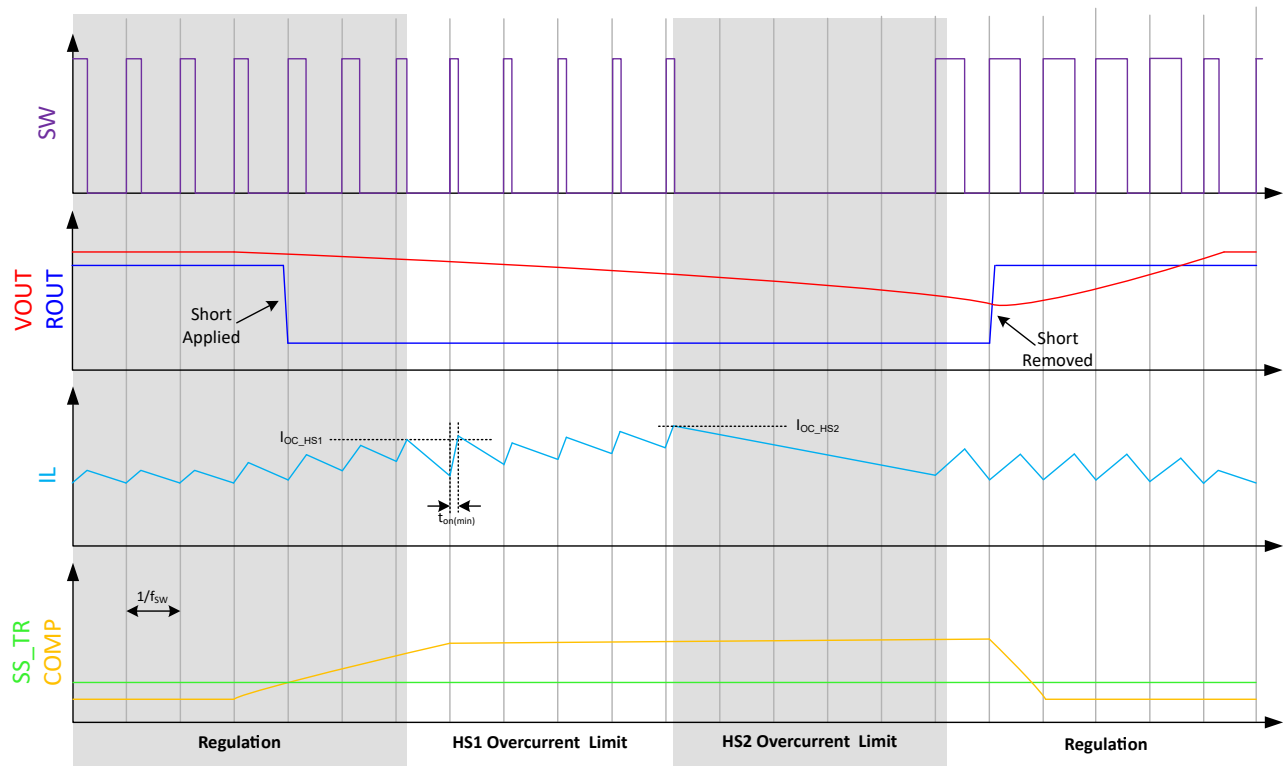

Figure 9-10. High-Side 2 Overcurrent Protection

The high side 2 overcurrent protection (HS2) threshold value is typically 11.8A for the TPS7H4012 and 6.8A for the TPS7H4013.

Similar to the I_{OC_HS1} current limit, the I_{OC_HS2} limit threshold is measured in an open loop configuration due to testability limitations while actual short circuit events are dynamic and in closed loop

9.3.8.1.3 COMP Shutdown

Since the voltage on the COMP pin is proportional to the device output current, by clamping the COMP voltage, another method is achieved to protect the device from overcurrent events. Specifically, if COMP rises above $COMP_{SHDN}$ (typically 1.9V), the part will shutdown after a small delay time, $t_{COMP(delay)}$.

This feature is a complement to the HS1 and HS2 current limits. Since the slew rate of COMP is limited by the overall loop bandwidth and by the drive strength of the error amplifier, the time it takes COMP to reach $COMP_{SHDN}$ during a fault depends on the loop compensation and specific type of fault. During most faults, HS1 will be reached before COMP reaches $COMP_{SHDN}$. HS2 will often be reached before COMP reaches $COMP_{SHDN}$; however depending on the fault type, COMP may reach $COMP_{SHDN}$ and disable the part before HS2 is reached. Consequently, $COMP_{SHDN}$ can be thought of as a type of fail-safe.

After COMP reaches $COMP_{SHDN}$ and $t_{COMP(delay)}$ passes, the device stops switching and begins discharging the SS_TR pin through a pull-down resistance, $R_{SS(discharge)}$ (typically 442Ω). The part will not attempt a restart until SS_TR has discharged to $SS_{startup}$ (typically 20mV). This provides a cool down period for the TPS7H401x. Note that this discharge time is directly dependent upon the value of the soft start capacitor, C_{SS} . An example of the COMP shutdown functionality is shown in the simplified waveforms of Figure 9-9.

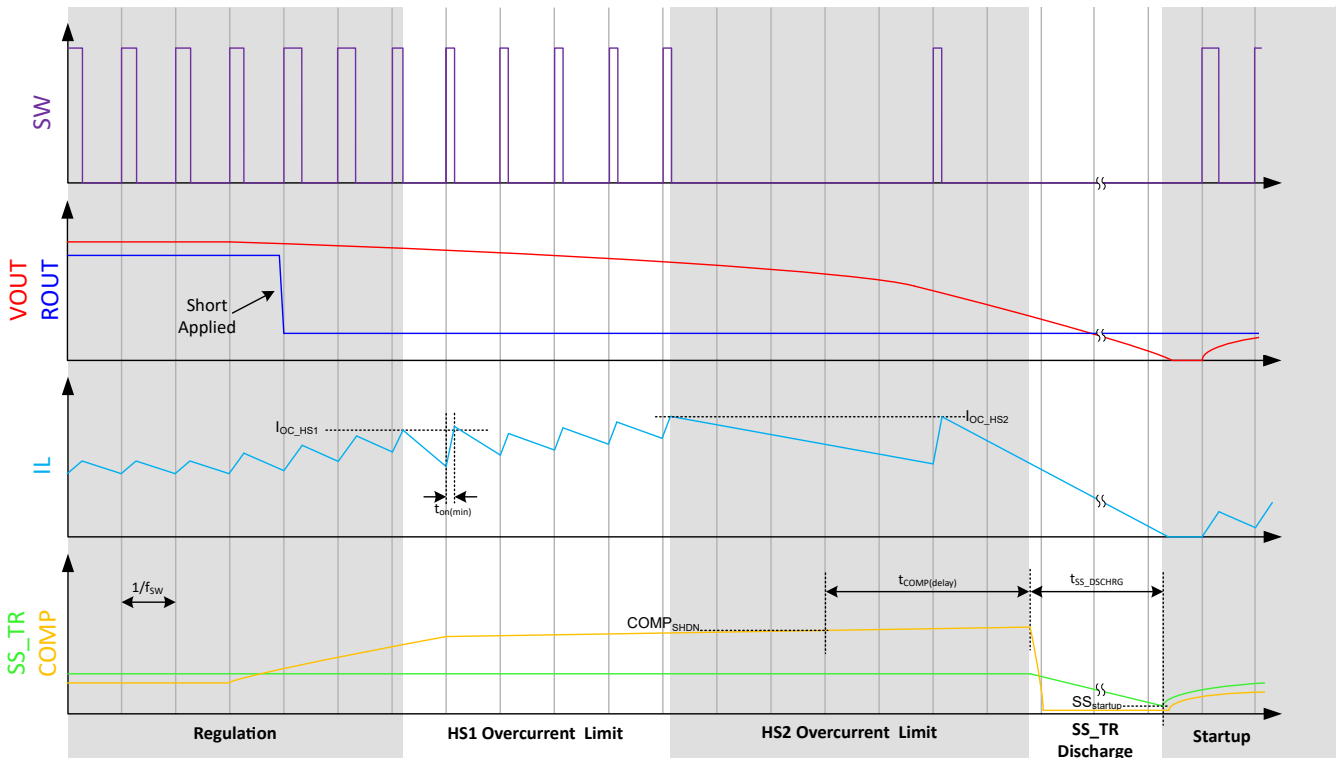

Figure 9-11. COMP Shutdown Protection

Additionally, COMP may reach $COMP_{SHDN}$ if an aggressive load step is applied to the output load and a high loop bandwidth is utilized. This is because in this situation, COMP can slew higher faster than the load can respond. This can be avoided through a compensation network that is appropriately designed for the worse case load step.

9.3.8.1.4 Low-Side Overcurrent Sinking Protection

It is possible for the low-side MOSFET to sink current from the load (such as during light load operation). In certain situations (such as a high current load being suddenly removed or VOUT being raised above the set point), the low-side sink current can become excessive. Therefore, low-side overcurrent sinking protection is provided.

If the low-side sinking current limit is exceeded, the low-side MOSFET is turned off immediately for the rest of that clock cycle. In this scenario, both MOSFETs are off until the start of the next cycle. When the low-side MOSFET turns off, the switch node voltage increases and forward biases the high-side MOSFET parallel body diode (the high-side MOSFET is still off at this stage).

9.3.8.2 Output Overvoltage Protection (OVP)

The device incorporates an output overvoltage protection (OVP) circuit to minimize output voltage overshoot. The OVP circuit engages when $VSNS+ \geq PWRGD_{HIGH_R\%} \times V_{REF}$. Typically, this means the OVP circuitry engages when VOUT rises above 108% of the nominal value. When OVP is active, the high-side FET stays off and the low-side FET stays on to quickly discharge VOUT.

An example that can cause an overvoltage condition is when the power supply output is overloaded for a sustained period of time. Therefore, the error amplifier compares the actual output voltage to the reference voltage. If the VSNS+ pin voltage is lower than the reference voltage for a considerable time, the output of the error amplifier demands maximum output current. After the condition is removed, the regulator output rises and the error amplifier output transitions to the steady-state voltage. In some applications with small output capacitance, the power supply output voltage can respond faster than the error amplifier. This leads to the possibility of an output overshoot. The OVP feature minimizes this overshoot.

If the VSNS+ pin voltage is greater than the OVP threshold, the high-side MOSFET is turned off, preventing current from flowing to the output and minimizing output overshoot. When the VSNS+ voltage drops lower than the OVP threshold, the high-side MOSFET is allowed to turn on at the next clock cycle.

9.3.8.3 Thermal Shutdown

The internal thermal shutdown circuitry forces the device to stop switching if the junction temperature exceeds 170°C (typical). The device re-initiates the power-up sequence when the junction temperature drops below 135°C (typical). The thermal shutdown protection aims to keep the device as cool as possible during over temperature conditions.

9.3.9 Error Amplifier and Loop Response

Figure 9-12 shows a simplified model for the device control loop. The device control loop can be utilized to aid in determining the frequency response and transient response of the buck regulator system. The simplified model is composed of an operational transconductance error amplifier (OTA), the power stage, external feedback, and external compensation. The effects of slope compensation are not shown in this model. More information on the error amplifier and power stage are shown in the subsequent sections (Section 9.3.9.1 and Section 9.3.9.2 respectively).

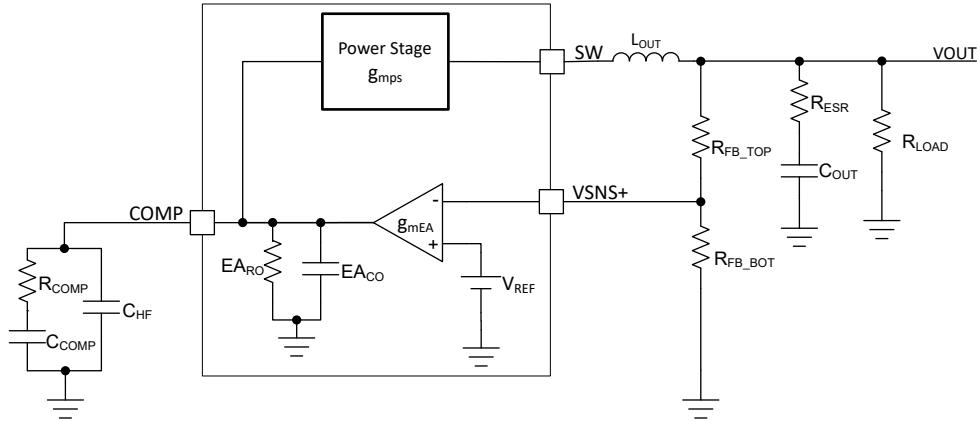

Figure 9-12. Simplified Small Signal Model For Loop Response

9.3.9.1 Error Amplifier

The TPS7H401x device utilizes a transconductance error amplifier. The error amplifier compares the VSNS+ voltage to the internal V_{REF} voltage reference.

The transconductance of the error amplifier is typically 1,650 μ S (μ A/V). The frequency compensation network is connected between the COMP pin and GND. The error amplifier DC gain is typically 11,500V/V. The error amplifier output resistance is 7M Ω (typ).

9.3.9.2 Power Stage Transconductance

To optimize the overall device behavior at different current levels, the TPS7H4012 and TPS7H4013 have different a power stage transconductance, g_{mPS} . The TPS7H4012 has a typical g_{mPS} of 11.2S (measured at $V_{COMP} = 0.7V$) and the TPS7H4013 has a lower typical g_{mPS} of 6.2S (measured at $V_{COMP} = 0.75V$).

9.3.9.3 Slope Compensation

The desired slope compensation, SC, can be configured with a resistor from the RSC pin to GND. The TPS7H401x device adds a compensating ramp to the switch current signal for all duty cycles. Various values of RSC and the resulting slope compensation are shown in the [Electrical Characteristics](#). Equation 8 is provided to approximate the value of RSC needed to achieve a desired slope compensation.

$$R_{SC} = 0.208 \times g_{mps} \times SC^{-1.5} \times f_{SW} \quad (8)$$

where

- R_{SC} is the suggested value of resistance in k Ω to achieve the desired slope compensation
- g_{mps} is the power stage gain in S
- SC is the positive desired value of slope compensation in A/ μ s (note that the [Electrical Characteristics](#) gives this value as a negative unit)
- f_{SW} is the switching frequency in kHz

For additional guidance on selecting slope compensation values, see [Section 10.2.2.9](#) in the application section.

9.3.9.4 Frequency Compensation

External frequency compensation is required for the TPS7H401x. There are several industry techniques used to compensate DC-DC regulators. For the TPS7H401x, type 2A compensation is most often recommended though other approaches are acceptable. See [Section 10.2.2.10](#) in the application section for a specific example.

9.4 Device Functional Modes

The device uses fixed frequency, peak current mode control. As a synchronous buck converter, the device normally operates in continuous current mode under all load conditions. The output voltage is divided down through external resistors and VSNS+ is compared to an internal voltage reference by an error amplifier, which drives the COMP pin. An internal oscillator initiates the turn on of the high-side power switch. The error amplifier output is converted into a current reference, which is compared to the high-side power switch current. When the power switch current reaches the current reference generated by the COMP voltage level, the high-side power switch is turned off and the low-side power switch is turned on.

10 Application and Implementation

Note

Information in the following applications sections is not part of the TI component specification, and TI does not warrant its accuracy or completeness. TI's customers are responsible for determining suitability of components for their purposes, as well as validating and testing their design implementation to confirm system functionality.

10.1 Application Information

The TPS7H4012 is a radiation hardened synchronous buck converter. The device is utilized to convert a higher DC input voltage to a lower DC output voltage at a maximum of 6A. The device can be used over an input voltage range of 4.5V to 14V.

10.2 Typical Application

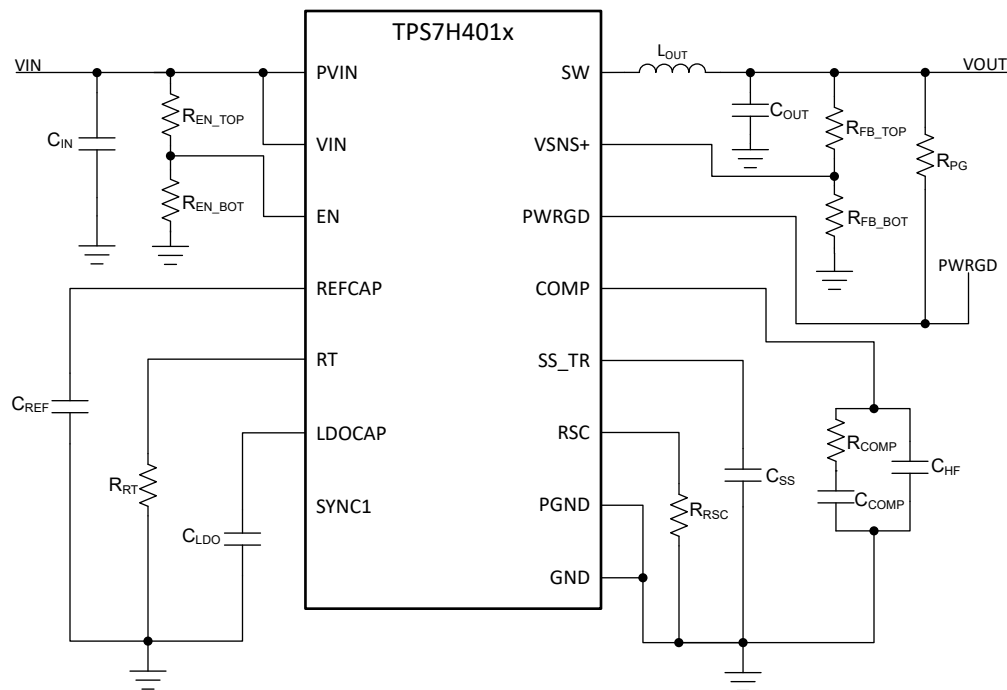

Figure 10-1. Typical Application Schematic

10.2.1 Design Requirements

Table 10-1. Design Parameters

DESIGN PARAMETER	DESIGN VALUE
Input voltage	12V ± 5%
Output voltage	3.3V ± 1.5%
Maximum output current	6A
Transient response 5A load step	ΔVOUT = 2.5%
Output voltage ripple	20mVpp
Start input voltage (rising VIN)	10V
Switching frequency	500kHz

10.2.2 Detailed Design Procedure

10.2.2.1 Operating Frequency

The first step is to decide on a switching frequency for the regulator. There is a trade off between higher and lower switching frequencies. Higher switching frequencies can produce a smaller design size by allowing lower valued inductors and smaller output capacitors compared to a power supply that switches at a lower frequency. However, the higher switching frequency causes extra switching losses, which hurt the converter's efficiency and thermal performance. In this design, a switching frequency of 500kHz is selected. Using [Equation 6](#), an RT resistor of 90.9kΩ is selected.

10.2.2.2 Output Inductor Selection

To calculate the value of the output inductor, use [Equation 10](#). K_L is a coefficient that represents the amount of inductor ripple current relative to the maximum output current, I_{OUT} , as shown in [Equation 9](#). Since the output capacitors must have a ripple current rating greater than or equal to the inductor ripple current, choosing a high inductor ripple current impacts output capacitors selection. In general, the inductor ripple value is at the discretion of the designer depending on specific system needs. Typical values for K_L range from 10% to 50%. For low output currents, the value of K_L is increased to reduce the value of the output inductor.

$$K_L = \frac{I_{ripple}}{I_{OUT}} \quad (9)$$

$$L = \frac{VIN_{(max)} - VOUT}{I_{OUT} \times K_L} \times \frac{VOUT}{VIN_{(max)} \times f_{SW}} \quad (10)$$

For this design example, use $K_L = 35\%$ and $VIN_{(max)} = 12.6V$ (12V + 5%). The calculated inductor value is 2.32μH and the closest available inductor of 2.2μH is selected. The resulting ripple current can be calculated using [Equation 11](#). The resulting ripple current is found to be 2.2A for this design.

$$\Delta I_L = \frac{VIN_{(max)} - VOUT}{L} \times \frac{VOUT}{VIN_{(max)} \times f_{SW}} \quad (11)$$

For the output filter inductor, not exceeding the RMS current and saturation current ratings is important. The RMS current can be found from [Equation 12](#) and peak inductor current can be found from [Equation 13](#).

$$I_{L(rms)} = \sqrt{I_{OUT}^2 + \frac{1}{12} \times \left(\frac{VOUT \times (VIN_{(max)} - VOUT)}{VIN_{(max)} \times L \times f_{SW}} \right)^2} \quad (12)$$

$$I_{L(peak)} = I_{OUT} + \frac{I_{L(ripple)}}{2} \quad (13)$$

For this design, the RMS inductor current is 6A, and the peak inductor current is 7.11A. To satisfy this requirement, a Würth 74439346022 inductor is selected. This inductor has a saturation current rating of 19.5A and an RMS current rating of 10.6A.

The current flowing through the inductor is the inductor ripple current plus the output current. During power up, faults, or transient load conditions, the inductor current can increase above the previously calculated peak inductor current level. In transient conditions, the inductor current can increase up to the switch current limit of the device. For this reason, the most conservative approach is to specify an inductor with a saturation current rating equal to or greater than the maximum switch current limit, rather than the peak inductor current.

TI recommends to maintain the typical current limit value is at least 25% higher than the peak inductor current to make sure there is sufficient margin before the current limit is engaged. The typical current limit of 9.7A meets these requirements.

10.2.2.3 Output Capacitor Selection

There are several considerations in determining the value of the output capacitor. The selection of the output capacitor is driven by both the desired output voltage ripple, and the allowable voltage deviation due to a large, abrupt change in load current (load step). For space applications, the value of capacitance also has to account for the mitigation of single event effects (SEE). The output capacitance needs to be selected based on the more stringent of these three criteria. When selecting the capacitors, take care to select capacitors with a sufficient voltage rating, temperature rating, and consideration of any effective capacitance changes due to DC bias effects. Noting that the value of the output capacitor directly influences the modulator pole of the converter frequency response, as described in [Section 10.2.2.10](#) is also important.

The first criteria to consider is the desired response to a load step. This generally occurs when the regulator is temporarily not able to supply sufficient output current during a large, fast increase in the current needs of the load. This can occur during a transition from no load to full load, or when powering an FPGA with large current swings. The output capacitor must be sized to supply the extra current to the load until the control loop responds to the load change. [Equation 14](#) shows the minimum output capacitance, from the electrical point of view, necessary to accomplish this.

$$C_{OUT} \geq \frac{2 \times \Delta I_{OUT}}{f_{SW} \times \Delta V_{OUT}} \quad (14)$$

Where ΔI_{OUT} is the change in output current, f_{SW} is the regulator switching frequency, and ΔV_{OUT} is the allowable change in the output voltage. For this example, the transient load response is specified as a 2.5% change in V_{OUT} for a load step of 5A. This results in a minimum capacitance of 242 μ F. This value does not take the ESR of the output capacitor into account in the output voltage change. For ceramic capacitors, the ESR is usually small enough to ignore in this calculation. However, for space applications and large capacitance values, tantalum capacitors are typically used, which have a certain ESR value to take into consideration.

The next criteria is to calculate the required capacitance to meet the output voltage ripple requirements using [Equation 15](#) where $V_{OUT_{ripple(desired)}}$ is the maximum allowable output voltage ripple, and ΔI_L is the inductor ripple current. In this case, the maximum desired output voltage ripple is 20mV, and the inductor ripple current is 2.2A. Under these conditions, a minimum capacitance value of 28 μ F is calculated.

$$C_{OUT} \geq \frac{\Delta I_L}{8 \times f_{SW} \times V_{OUT_{ripple(desired)}}} \quad (15)$$

Finally, the ESR of the capacitor must be considered when meeting the output voltage ripple requirements using [Equation 16](#). An ESR value of 9m Ω or less is required has been determined.

$$ESR \leq \frac{V_{OUT_{ripple(desired)}}}{\Delta I_L} \quad (16)$$

Additional capacitance deratings for aging, temperature, and DC bias are factored in, which increases the minimum required output capacitance value. Additionally, capacitors generally have limits to the amount of

ripple current the capacitors can handle without failing or producing excess heat. The selected bank of output capacitors must handle the ripple current calculated in [Equation 11](#).

For this specific design, taking into consideration all of the above requirements, 2x330µF T530 Tantalum capacitors are selected with a resulting combined ESR of 2.45mΩ at the 500kHz switching frequency. Additionally, a 22µF, 10µF, 1µF, and 100nF ceramic capacitors are added in parallel for high frequency filtering. This results in a total capacitance of 693.1µF.

[Equation 17](#) can be used as an approximation to calculate the resulting output voltage ripple when considering both the capacitance and ESR. For this design, the resulting output ripple estimation is 6.2mV.

$$V_{OUT_{ripple}} \approx \frac{\Delta I_L}{8 \times f_{SW} \times C_{OUT}} + ESR \times \Delta I_L \quad (17)$$

10.2.2.4 Input Capacitor Selection

The input supply to the TPS7H4012 must be well regulated with sufficient capacitor bypassing for proper electrical performance. While a minimum ceramic capacitor of at least 4.7µF effective capacitance near the PVIN and VIN inputs is required, additional bulk capacitance is generally required to handle the high input currents. Similar to the output capacitor selection, when selecting the input capacitors, care should be taken to select capacitors with a sufficient voltage rating, temperature rating, and consideration of any effective capacitance changes due to DC bias effects. The capacitor must also have a ripple current rating greater than the maximum input current ripple as calculated using [Equation 18](#). For this design, $I_{CIN_{rms}}$ is calculated to be 2.7A.

$$I_{CIN_{rms}} = I_{OUT} \times \sqrt{\frac{V_{OUT} \times (V_{IN(min)} - V_{OUT})}{V_{IN(min)}^2}} \quad (18)$$

The minimum input capacitance can then be calculated by using [Equation 19](#) and selecting a maximum desired input ripple voltage, $\Delta V_{IN_{desired}}$. For this design, a 20mV input voltage ripple maximum is used, resulting in a minimum input capacitance of 150µF.

$$C_{IN} \geq \frac{I_{OUT} \times 0.25}{\Delta V_{IN_{desired}} \times f_{SW}} \quad (19)$$

Note, however, that [Equation 19](#) does not include the effects of ESR on the input ripple voltage. Therefore, additional capacitance is utilized. Specifically, 5x100µF Tantalum capacitors are used along with 2x22µF, 2x10µF, 2x4.7µF, and 1x0.1µF ceramic capacitors are selected for a total input capacitance of 573.5µF.

10.2.2.5 Soft-Start Capacitor Selection

The soft-start capacitor C_{SS} , determines the amount of time it takes for the output voltage to reach its nominal programmed value during power up. This is useful if a load requires a controlled voltage slew rate. This is also used if the output capacitance is large (as is typical with space grade buck converters), which would require a large amount of current to quickly charge the capacitor to the output voltage level. The large currents necessary to charge the capacitor may make the TPS7H401x reach the current limit, draw excessive current from the input power supply, or cause the input voltage rail to sag. Limiting the output voltage slew rate solves these problems. The soft-start capacitor value can be calculated using [Equation 7](#).

A reasonable soft start time for many space grade buck regulators is 5.8ms, which results in a C_{SS} capacitor of 22nF.

10.2.2.6 Rising VIN Set Point (Configurable UVLO)

An external resistor divider from VIN to GND is used to enable the TPS7H4012 when a desired preset input voltage is reached. In effect, this acts as an adjustable UVLO. First, 10V is selected as the desired turn-on voltage ($V_{IN(rising)}$). Next, R_{EN_TOP} of 54.2kΩ is selected as a reasonable tradeoff between a large enough resistor to minimize power dissipation, but low enough to prevent excessive noise coupling to a high impedance node. [Equation 4](#) is then used to calculate an R_{EN_BOT} of 3.52kΩ.

Since the enable pin has hysteresis, the resulting turn-off voltage can be calculated using [Equation 5](#). It is found that the $V_{IN(\text{falling})}$ is 8.36V. This means that once the regulator starts switching after rising above 10V ($V_{IN(\text{rising})}$), it will continue switching until falling below 8.36V.

10.2.2.7 Output Voltage Feedback Resistor Selection

The resistor divider network R_{FB_TOP} and R_{FB_BOT} is used to set the output voltage. For this design, 10k Ω was selected for R_{TOP} . Additionally, a 50 Ω resistor was placed in series with R_{FB_TOP} to aid in measuring the control loop. Using the combined value of 10.05k Ω and [Equation 1](#), R_{BOTTOM} is calculated as 2.233k Ω . The nearest standard 0.1% resistor of 2.23k Ω was selected.

10.2.2.8 Output Voltage Accuracy

To determine the output voltage DC accuracy, the following sources of error are considered:

- V_{REF} within the [Electrical Characteristics](#) table is the predominant source of error. This encompasses the error due to the reference voltage and error amplifier offset. The across temperature minimum of 0.594V, maximum of 0.604V, and typical of 0.6V results in an accuracy of -1.00% and $+0.67\%$. If this error is instead centered around an average reference voltage of 0.599V, the accuracy is calculated as $\pm 0.83\%$.
- The V_{REF} specification is not measured in a switching, closed-loop configuration. [Figure 7-31](#) can be used to see the effects of output current (load regulation) and switching. It is seen that across the complete 6A load, there is only a small deviation of approximately 800 μ V. This corresponds to $+0.13\%$ error.
- The external error due to the resistor tolerance of the R_{FB_TOP} and R_{FB_BOT} resistors need to be added. Since it is assumed the error is uncorrelated, it is decided to add the errors as a sum of squares. For the selected 0.1% tolerance R_{FB_TOP} and R_{FB_BOT} resistors, the total error is $R(\text{error}) = \sqrt{(0.1\% + 0.1\%)} = \pm 0.14\%$.

[Equation 20](#) is used to calculate the system error for output voltage accuracy.

$$\text{System}_{(\text{error})} = V_{REF(\text{error})} + R_{FB(\text{error})} + V_{LOAD(\text{error})} \quad (20)$$

The negative system error calculation is $\text{System}_{(\text{error})} = -1.00\% - 0.14\% = -1.14\%$ and the positive system error is $\text{System}_{(\text{error})} = 0.67\% + 0.14\% + 0.13\% = 0.94\%$. Therefore, the total system error is calculated to be $-1.14\% / +0.94\%$. If the total system error is centered, this comes to $\pm 1.04\%$. These each meet the 1.5% target.

Lifetime drift data could similarly be added. Group C data may be used to aid in this calculation. For this example, it is assumed the lifetime drift is minimal compared to the other sources of error and it is therefore not added.

10.2.2.9 Slope Compensation Requirements

While one may choose different values of slope compensation for different applications, a commonly suggested ideal value for slope compensation is defined as the output voltage divided by the inductor size as shown in [Equation 21](#).

$$SC_{\text{suggested}} = \frac{di}{dt} = \frac{\Delta I_L}{\Delta t_{OFF}} = \frac{V_{OUT}}{L} \quad (21)$$

For this design, the suggested value is 1.5A/ μ s. Using [Equation 8](#), the suggested value of R_{SC} is calculated to be 634k Ω . However, in this specific application example, it was decided to have more slope compensation than suggested which provided additional margin and suitability of testing different configurations. Therefore, a value of 200k Ω is used which results in 3.2A/ μ s.

10.2.2.10 Compensation Component Selection

The control loop of the TPS7H4012 is described in [Section 9.3.9](#). The component selection for compensating this device is as shown below. Other industry standard approaches for compensating a peak current mode control buck regulator are also acceptable.

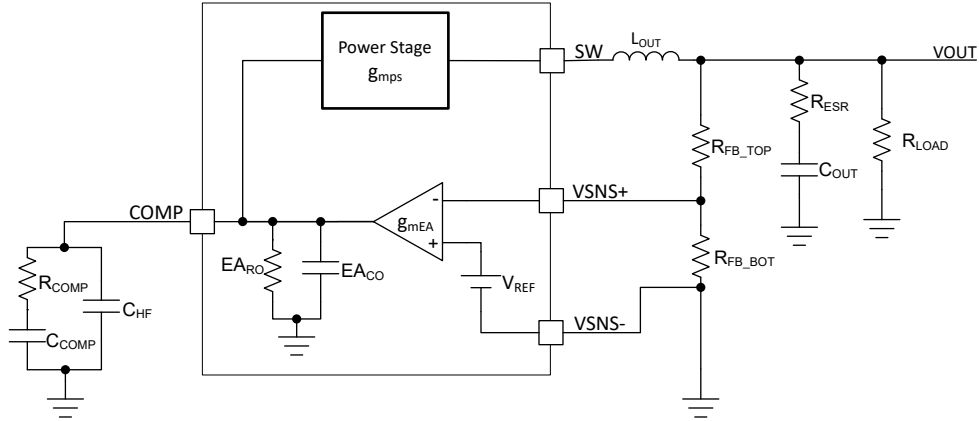

Figure 10-2. Type II Compensation With Simplified Loop

1. Determine the desired crossover frequency, $f_{CO(desired)}$. A good starting rule of thumb is to set the crossover frequency to one-tenth of the switching frequency. This generally provides a good transient response and maintain that the modulator poles do not degrade the phase margin. For this design, a more conservative crossover frequency target of 33kHz is selected.
2. Determine the required gain from the compensated error amplifier using [Equation 22](#):

$$A_{VM} = \frac{2\pi \times f_{CO(desired)} \times C_{OUT}}{g_{mps}} \quad (22)$$

Where g_{mps} is the power stage transconductance for the selected current limit. For this design with $f_{CO(desired)} = 33\text{kHz}$, $C_{OUT} = 693.1\mu\text{F}$, $g_{mps} = 11.2\text{S}$, a value for A_{VM} of 12.8V/V is obtained.

3. R_{COMP} can be determined by [Equation 23](#):

$$R_{COMP} = \frac{A_{VM}}{g_{mEA}} \times \frac{V_{OUT}}{V_{REF}} \quad (23)$$

where g_{mEA} is the transconductance of the error amplifier (1650 μS typ) and V_{REF} is the reference voltage (0.6V typ). A value of 42.77k Ω is calculated and a nearby standard resistor of 42.7k Ω was selected.

4. Calculate the power stage dominate pole determined by [Equation 24](#):

$$f_{P,PS} = \frac{I_{OUT}}{2\pi \times C_{OUT} \times V_{OUT}} \quad (24)$$

For this design, the dominate pole is calculated to be at 0.42kHz.

5. Place a compensation zero at the dominant pole by selecting C_{COMP} as determined by [Equation 25](#):

$$C_{COMP} = \frac{1}{2\pi \times f_{P,PS} \times R_{COMP}} \quad (25)$$

For this design, C_{COMP} is calculated to be 8.93nF and a nearby standard capacitor value of 8.2nF was selected.

6. Calculate the ESR zero from the output capacitor bank by [Equation 24](#):

$$f_{1,ESR} = \frac{1}{2\pi \times ESR \times C_{OUT}} \quad (26)$$

For this design, the ESR zero is calculated to be at 93.73kHz.

7. C_{HF} is used to cancel the zero from the equivalent series resistance (ESR) of the output capacitor C_{OUT} . It is calculated using [Equation 27](#):

$$C_{HF} = \frac{1}{R_{COMP} \times 2\pi \times f_{Z,ESR}} \quad (27)$$

Note that if the ESR zero is higher than half the switching frequency, use half the switching frequency instead of the ESR zero in [Equation 27](#). For this design, C_{HF} is calculated to be 39.77pF and a nearby standard capacitor value of 22pF is selected.

Note

The components selected using these equations are often only starting values in a design. Optimizations can be made after lab testing to further improve the frequency response and maintain a closer match to the desired crossover frequency.

Note

For device models, see the [TPS7H4012-SEP Design tools & simulation](#), [TPS7H4012-SP Design tools & simulation](#), [TPS7H4013-SEP Design tools & simulation](#), and [TPS7H4013-SP Design tools & simulation](#) web pages.

10.2.2.11 Schottky Diode

A Schottky diode may be connected from SW to PGND. This provides a low impedance path for the inductor current during dead time. A Schottky diode can help mitigate reference voltage drift, especially when operating at higher currents and higher switching frequencies. A Schottky diode can also help improve efficiency. Select a diode with low or no reverse recovery time for optimal efficiency and performance. True Schottky diodes have no reverse recovery time.

While a Schottky diode is good design practice, it is not required for the TPS7H4012 and TPS7H4013. However, it is recommended to ensure any resulting voltage reference variation is acceptable for a given application. See also [Figure 7-31](#) and [Figure 7-32](#).

10.2.3 Application Curve

Typical plots are shown for the following conditions:

- $V_{IN} = P_{VIN} = 12V$
- $V_{OUT} = 3.3V$
- $I_{OUT} = 6A$
- Switching frequency = 500kHz

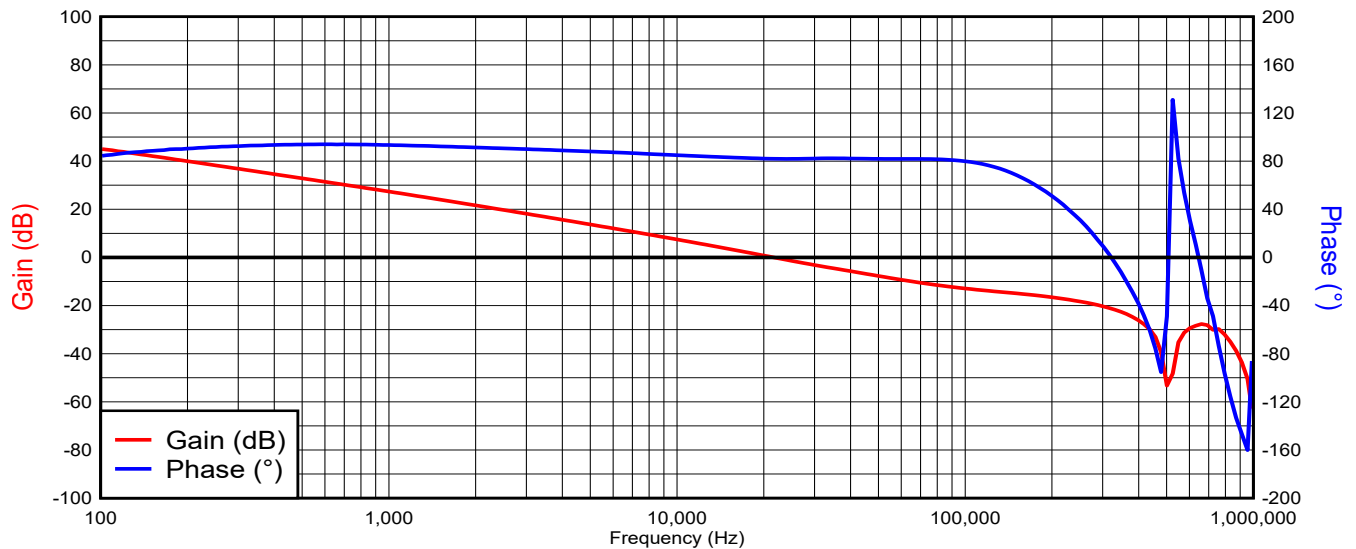

Figure 10-3. Bode Plot

10.2.4 Inverting Buck-Boost

The TPS7H401x can be configured as an inverting buck-boost to create a negative output voltage as shown in Figure 10-4.

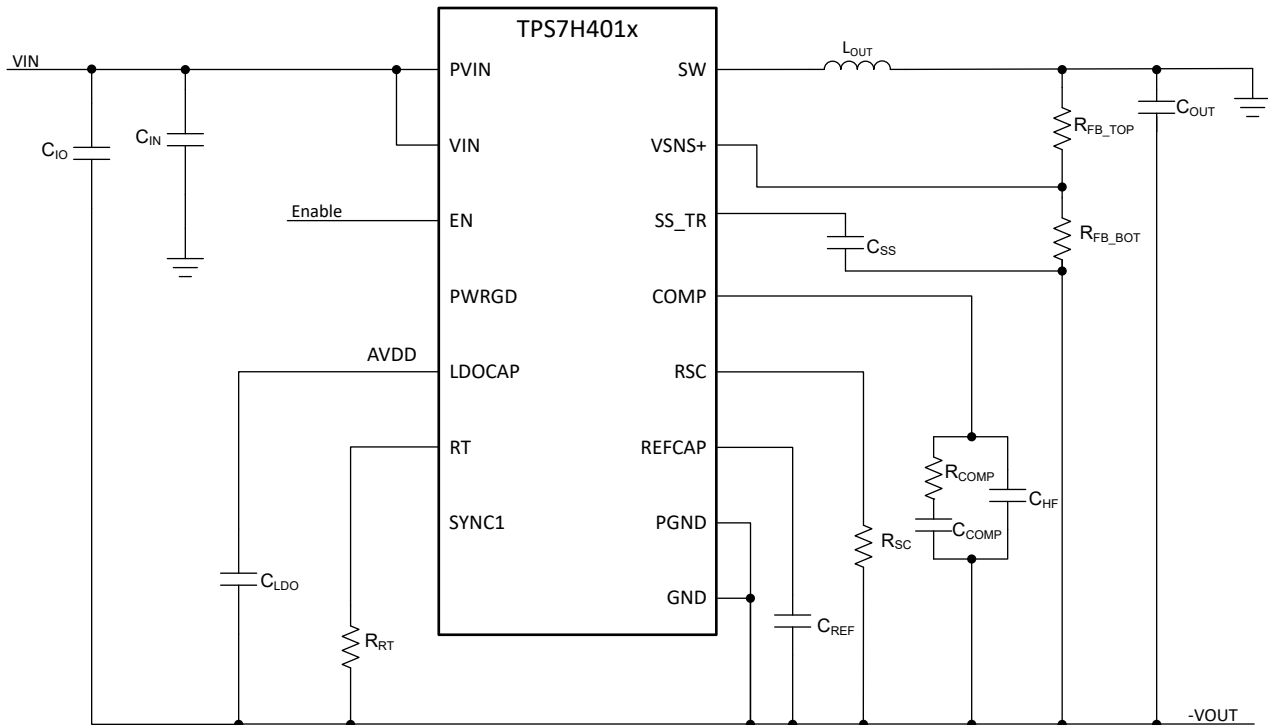

Figure 10-4. Simplified Schematic of Inverting Buck-Boost

Additional considerations for designing an inverting buck-boost are described in the application note, [Working With Inverting Buck-Boost Converters](#). While many details and equations are provided within the application note, a few considerations for the TPS7H401x are as follows:

- Maintain that the recommended maximum input voltage of 14V is followed. This means $V_{IN} + |V_{OUT}| \leq 14V$. For example, an inverting buck-boost configured from 5V to $-5V$ is acceptable (10V differential) but 12V to $-12V$ is not acceptable (24V differential).
- Be sure the current limit supports the application. The average inductor current for an inverting buck-boost is greater than the load current. This can result in higher peak currents than expected when compared to a buck converter. Additionally, this means that the average inductor current must be kept lower than the TPS7H4012 recommended maximum of 6A and TPS7H4013 maximum of 3A.
- C_{IO} in Figure 10-4 is the standard input capacitor that is utilized in a buck converter. C_{IN} is an input capacitor with respect to system ground which provides a low impedance path at the regulator input.
- Be sure that device logic input pins such as EN never exceed the recommended maximum rating of 7V. For example, if EN is driven to 5V from an external source and the inverting buck-boost is configured for a $-5V$ output, this applies 10V to EN (with respect to the device GND pin) which exceeds the rating. Take care with selecting the input voltage signals to avoid this condition. Alternatively, logic shift the signals so the signals are referenced with respect to $-V_{OUT}$ (which is the device GND pin).

10.3 Power Supply Recommendations

The TPS7H401x is designed to operate from an input voltage supply range between 4.5V and 14V. This supply voltage must be well regulated. Power supplies must be well bypassed for proper electrical performance. This includes a minimum of one 4.7 μ F (after derating) ceramic capacitor, type X7R or better from PVIN to GND, and from VIN to GND. PVIN and VIN must be the same voltage, and it is recommended to externally connect PVIN and VIN. Additional local ceramic bypass capacitance may be required in systems with small input ripple specifications, as well as additional bulk capacitance if the TPS7H401x device is located more than a few inches away from its input power supply. Bypass capacitors should be placed as close as possible to the input pins, and have a low impedance path to GND.

Larger values of bypass capacitance at the output will improve the response to radiation induced transients.

10.4 Layout

10.4.1 Layout Guidelines

- Layout is a critical portion of good power supply design. See [Layout Example](#) for a PCB layout example.
- TI recommends including a large topside area filled with ground. This top layer ground area is connected to the internal ground layers using vias at the input bypass capacitor, the output filter capacitor, and directly under the TPS7H401x device to provide a thermal path from the exposed thermal pad to ground. The topside ground area together with the internal ground plane must provide adequate heat dissipating area.
- TI recommends that the thermal pad under the TPS7H401x is tied to GND on internal ground layers utilizing vias. The thermal pad does not need to directly connect to ground on the top layer to provide noise isolation between the thermal pad ground and the topside PGND, which can be noisy.
- There are several signal paths that conduct fast changing currents or voltages that can interact with stray inductance or parasitic capacitance to generate noise or degrade the power supply's performance. To help eliminate these problems, the PVIN pin can be bypassed to ground with a low ESR ceramic bypass capacitor with an X7R dielectric.
- Care is taken to minimize the loop area formed by the bypass capacitor connections, the PVIN pins, and the ground connections.
- The VIN pin must also be bypassed to ground using a low ESR ceramic capacitor with an X7R dielectric. Make sure to connect this capacitor to the quieter analog ground trace (if utilized) rather than the power ground trace of the PVIN bypass capacitor.
- Since the SW connection is the switching node, the output inductor is located close to the SW pins and the PCB conductor area minimized to prevent excessive capacitive coupling.
- The output filter capacitor ground uses the same power ground as the PVIN input bypass capacitor. Try to minimize this conductor length while maintaining adequate width.
- Keeping the feedback trace away from inductor EMI and other noise sources is critical. Run the feedback trace as far from the inductor, switch (SW) node, and noisy power traces as possible. Avoid routing this trace directly under the output inductor if possible. If not possible, maintain that the trace is routed on another layer with a ground layer separating the trace and inductor.
- Keep the resistive divider used to generate the VSNS+ voltage as close to the device pin as possible to reduce noise pickup.
- The RT and COMP pins are sensitive to noise, so components around these pins are located as close as possible to the IC and routed with minimal trace lengths.
- Make all of the power (high current) traces as short, direct, and thick as possible.
- Obtaining acceptable performance with alternate PCB layouts is possible.

10.4.2 Layout Example

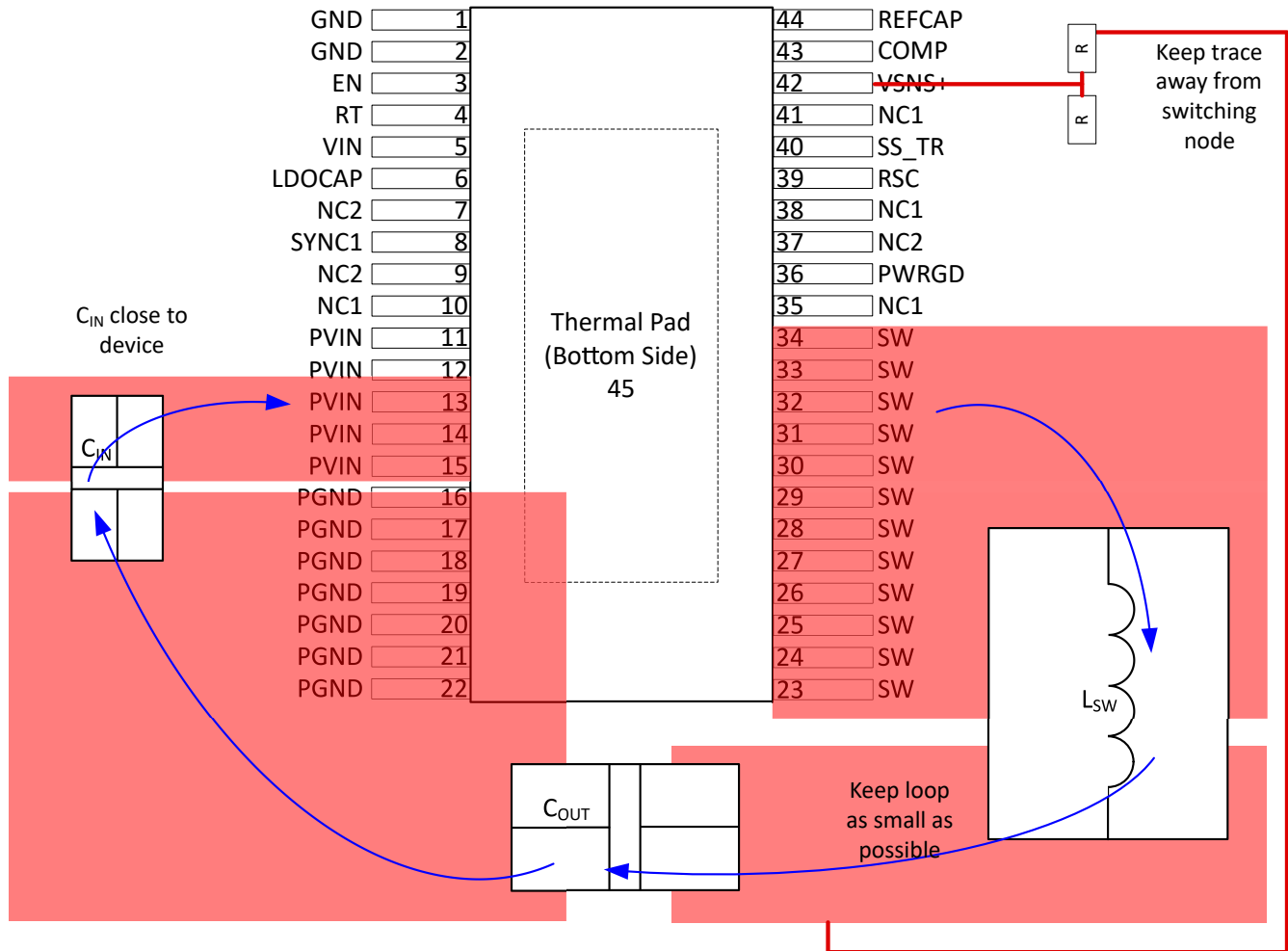

Figure 10-5. Simplified Layout Example

11 Device and Documentation Support

TI offers an extensive line of development tools. Tools and software to evaluate the performance of the device, generate code, and develop solutions are listed below.

11.1 Documentation Support

11.1.1 Third-Party Products Disclaimer

TI'S PUBLICATION OF INFORMATION REGARDING THIRD-PARTY PRODUCTS OR SERVICES DOES NOT CONSTITUTE AN ENDORSEMENT REGARDING THE SUITABILITY OF SUCH PRODUCTS OR SERVICES OR A WARRANTY, REPRESENTATION OR ENDORSEMENT OF SUCH PRODUCTS OR SERVICES, EITHER ALONE OR IN COMBINATION WITH ANY TI PRODUCT OR SERVICE.

11.1.2 Related Documentation

- [TPS7H4012-SP total ionizing dose \(TID\) radiation report](#)
- [TPS7H4013-SP total ionizing dose \(TID\) radiation report](#)
- [TPS7H4012-SEP total ionizing dose \(TID\) radiation report](#)
- [TPS7H4013-SEP total ionizing dose \(TID\) radiation report](#)
- [TPS7H4012-SP and TPS7H4013-SP single event effects \(SEE\) radiation report](#)
- [TPS7H4012-SEP and TPS7H4013-SEP single event effects \(SEE\) radiation report](#)
- [TPS7H4012-SP and TPS7H4012-SEP neutron displacement damage \(NDD\) radiation report](#)
- [TPS7H4013-SP and TPS7H4013-SEP neutron displacement damage \(NDD\) radiation report](#)
- [TPS7H4012EVM evaluation module user's guide \(plastic package\)](#)
- [TPS7H4013EVM evaluation module user's guide \(plastic package\)](#)
- [Standard Microcircuit Drawing, 5962R21221](#)
- [Vendor Item Drawing, V62/25640](#)

11.2 Receiving Notification of Documentation Updates

To receive notification of documentation updates, navigate to the device product folder on [ti.com](#). Click on *Notifications* to register and receive a weekly digest of any product information that has changed. For change details, review the revision history included in any revised document.

11.3 Support Resources

TI E2E™ [support forums](#) are an engineer's go-to source for fast, verified answers and design help — straight from the experts. Search existing answers or ask your own question to get the quick design help you need.

Linked content is provided "AS IS" by the respective contributors. They do not constitute TI specifications and do not necessarily reflect TI's views; see TI's [Terms of Use](#).

11.4 Trademarks

TI E2E™ is a trademark of Texas Instruments.

All trademarks are the property of their respective owners.

11.5 Electrostatic Discharge Caution



This integrated circuit can be damaged by ESD. Texas Instruments recommends that all integrated circuits be handled with appropriate precautions. Failure to observe proper handling and installation procedures can cause damage.

ESD damage can range from subtle performance degradation to complete device failure. Precision integrated circuits may be more susceptible to damage because very small parametric changes could cause the device not to meet its published specifications.

11.6 Glossary

[TI Glossary](#) This glossary lists and explains terms, acronyms, and definitions.

12 Revision History

NOTE: Page numbers for previous revisions may differ from page numbers in the current version.

Changes from Revision A (November 2025) to Revision B (April 2026)	Page
• Changed TPS7H4012-SP and TPS7H4013-SP from <i>Product Preview</i> to <i>Production Data</i>	1
• Added missing <i>Product Preview</i> marking to the SN0020HLC "dummy" package	3
• Added FET resistance vs. current typical characteristic graphs.....	13

Changes from Revision * (May 2025) to Revision A (November 2025)	Page
• Changed TPS7H4012-SEP and TPS7H4013-SEP from <i>Advanced Information</i> to <i>Production Data</i>	1
• Changed low-side switch sinking overcurrent threshold to a typical value.....	8
• Changed slope compensation typical values.....	8
• Changed specification for SYNC1 to SW delay.....	8
• Changed specification for PWRGD thresholds.....	8
• Added additional typical characteristic graphs.....	13
• Updated the I_{CINrms} equation in the Application section.....	44
• Updated the values used in the application section for output voltage accuracy calculation.....	45

13 Mechanical, Packaging, and Orderable Information

The following pages include mechanical, packaging, and orderable information. This information is the most current data available for the designated devices. This data is subject to change without notice and revision of this document. For browser-based versions of this data sheet, refer to the left-hand navigation.

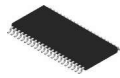

PACKAGE OUTLINE

DDW0044G

PowerPAD™ TSSOP - 1.2 mm max height

PLASTIC SMALL OUTLINE

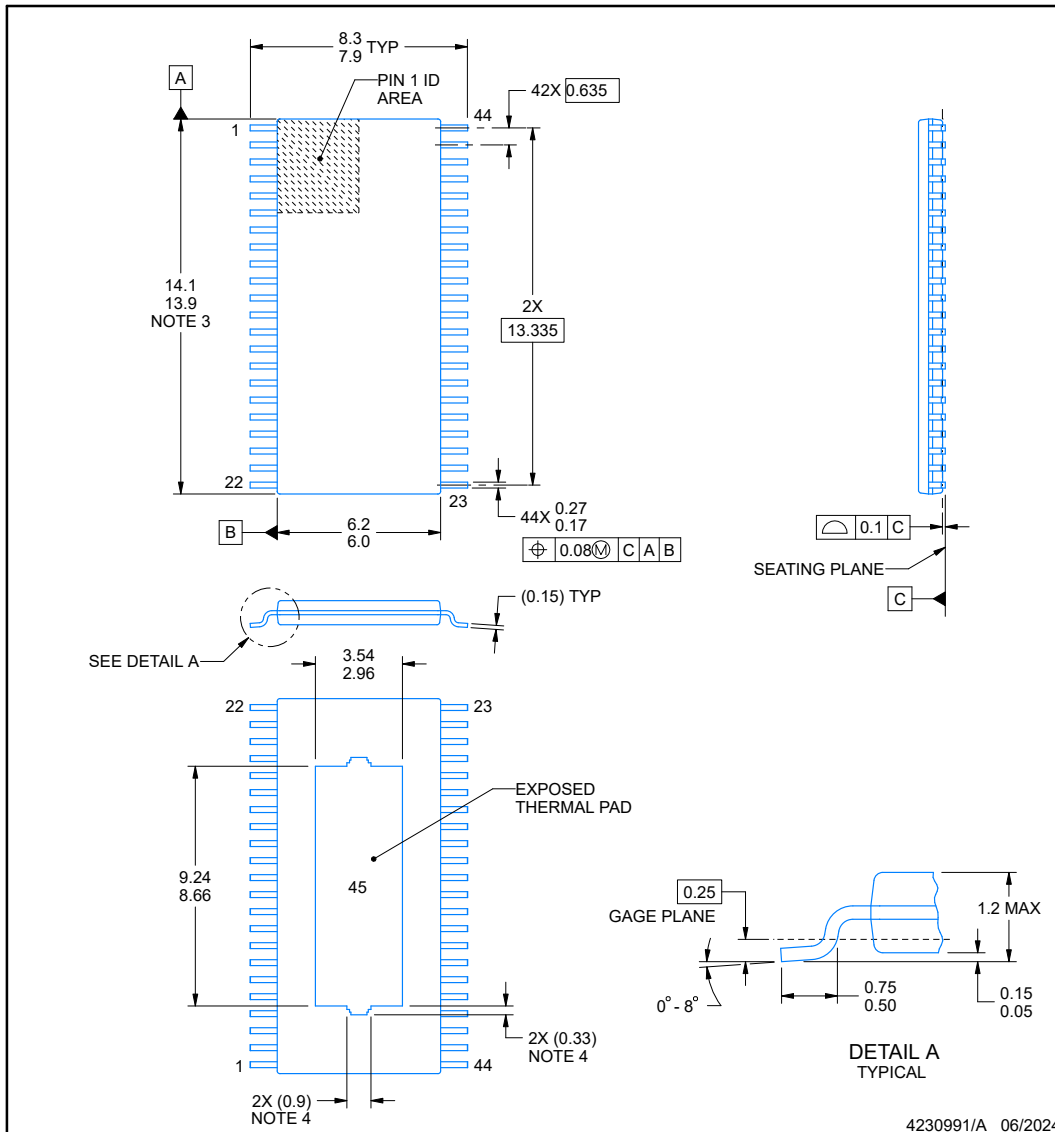

4230991/A 06/2024

NOTES:

PowerPAD is a trademark of Texas Instruments.

1. All linear dimensions are in millimeters. Any dimensions in parenthesis are for reference only. Dimensioning and tolerancing per ASME Y14.5M.
2. This drawing is subject to change without notice.
3. This dimension does not include mold flash, protrusions, or gate burrs. Mold flash, protrusions, or gate burrs shall not exceed 0.15 mm per side.
4. Features may differ or may not be present.

EXAMPLE BOARD LAYOUT

DDW0044G

PowerPAD™ TSSOP - 1.2 mm max height

PLASTIC SMALL OUTLINE

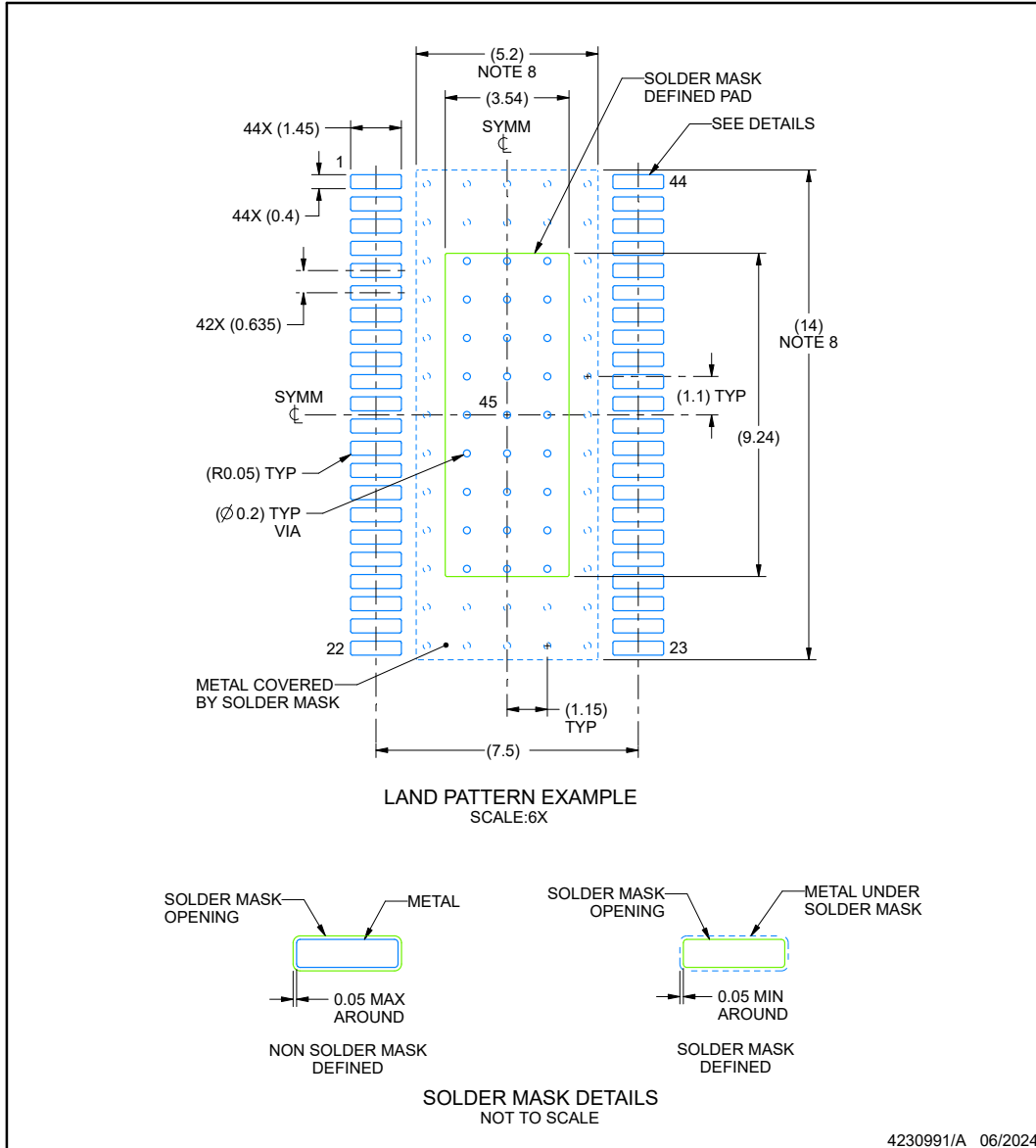

NOTES: (continued)

5. Publication IPC-7351 may have alternate designs.
6. Solder mask tolerances between and around signal pads can vary based on board fabrication site.
7. This package is designed to be soldered to a thermal pad on the board. For more information, see Texas Instruments literature numbers SLMA002 (www.ti.com/lit/slma002) and SLMA004 (www.ti.com/lit/slma004).
8. Size of metal pad may vary due to creepage requirement.

EXAMPLE STENCIL DESIGN

DDW0044G

PowerPAD™ TSSOP - 1.2 mm max height

PLASTIC SMALL OUTLINE

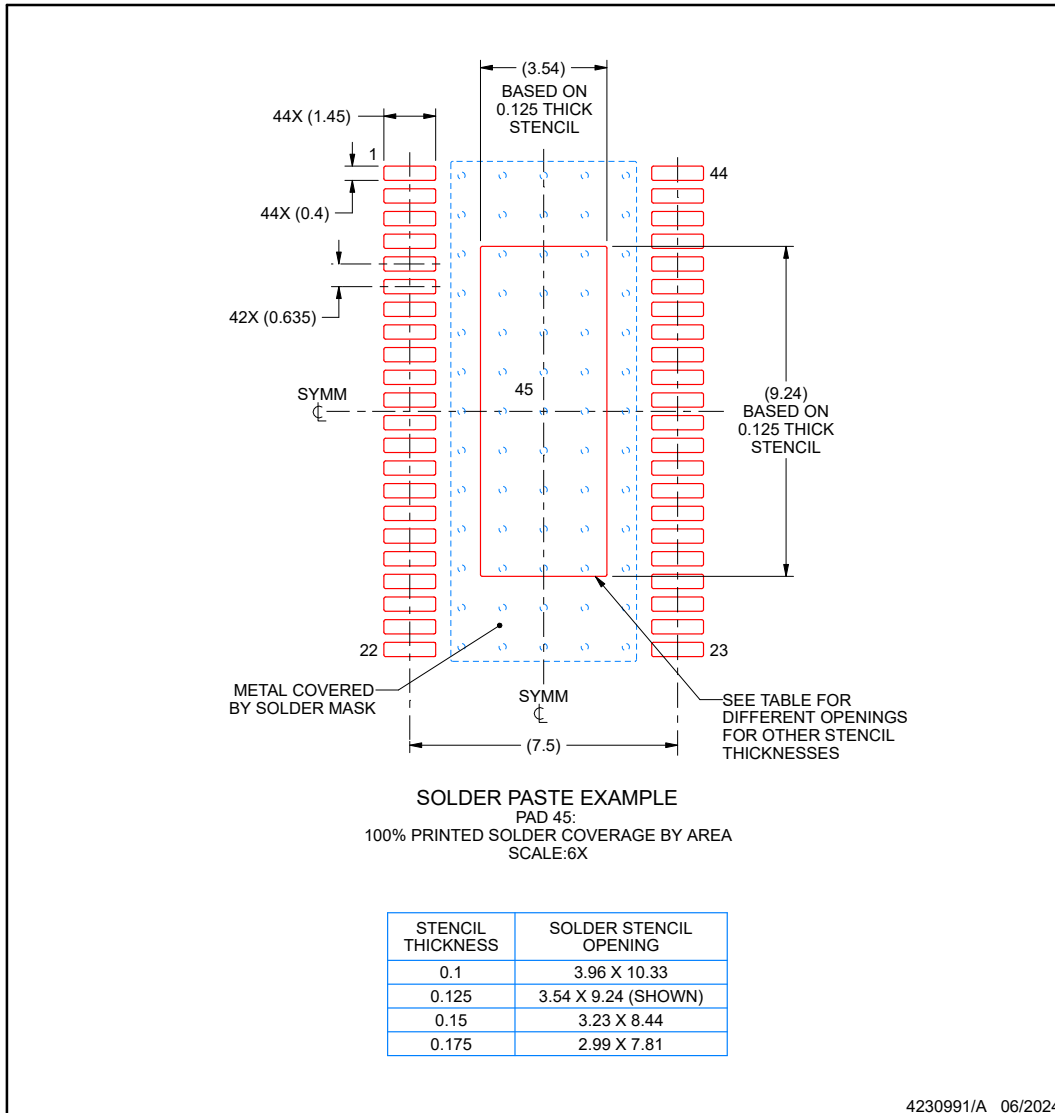

NOTES: (continued)

9. Laser cutting apertures with trapezoidal walls and rounded corners may offer better paste release. IPC-7525 may have alternate design recommendations.
10. Board assembly site may have different recommendations for stencil design.

PACKAGING INFORMATION

Orderable part number	Status (1)	Material type (2)	Package Pins	Package qty Carrier	RoHS (3)	Lead finish/ Ball material (4)	MSL rating/ Peak reflow (5)	Op temp (°C)	Part marking (6)
5962R2122103PYE	Active	Production	HTSSOP (DDW) 44	250 SMALL T&R	Yes	NIPDAU	Level-3-260C-168 HR	-55 to 125	R2122103PYE
5962R2122104PYE	Active	Production	HTSSOP (DDW) 44	250 SMALL T&R	Yes	NIPDAU	Level-3-260C-168 HR	-55 to 125	R2122104PYE
PTPS7H4012MDDWSEP	Active	Preproduction	HTSSOP (DDW) 44	250 SMALL T&R	-	Call TI	Call TI	-55 to 125	
PTPS7H4013MDDWSEP	Active	Preproduction	HTSSOP (DDW) 44	250 SMALL T&R	-	Call TI	Call TI	-55 to 125	
TPS7H4012MDDWTSEP	Active	Production	HTSSOP (DDW) 44	250 SMALL T&R	Yes	NIPDAU	Level-3-260C-168 HR	-55 to 125	TPS7H4012SEP
TPS7H4013MDDWTSEP	Active	Production	HTSSOP (DDW) 44	250 SMALL T&R	Yes	NIPDAU	Level-3-260C-168 HR	-55 to 125	TPS7H4013SEP
V62/25640-02XE	Active	Production	HTSSOP (DDW) 44	250 SMALL T&R	-	NIPDAU	Level-3-260C-168 HR	-55 to 125	TPS7H4012SEP
V62/25640-03XE	Active	Production	HTSSOP (DDW) 44	250 SMALL T&R	-	NIPDAU	Level-3-260C-168 HR	-55 to 125	TPS7H4013SEP

(1) **Status:** For more details on status, see our [product life cycle](#).

(2) **Material type:** When designated, preproduction parts are prototypes/experimental devices, and are not yet approved or released for full production. Testing and final process, including without limitation quality assurance, reliability performance testing, and/or process qualification, may not yet be complete, and this item is subject to further changes or possible discontinuation. If available for ordering, purchases will be subject to an additional waiver at checkout, and are intended for early internal evaluation purposes only. These items are sold without warranties of any kind.

(3) **RoHS values:** Yes, No, RoHS Exempt. See the [TI RoHS Statement](#) for additional information and value definition.

(4) **Lead finish/Ball material:** Parts may have multiple material finish options. Finish options are separated by a vertical ruled line. Lead finish/Ball material values may wrap to two lines if the finish value exceeds the maximum column width.

(5) **MSL rating/Peak reflow:** The moisture sensitivity level ratings and peak solder (reflow) temperatures. In the event that a part has multiple moisture sensitivity ratings, only the lowest level per JEDEC standards is shown. Refer to the shipping label for the actual reflow temperature that will be used to mount the part to the printed circuit board.

(6) **Part marking:** There may be an additional marking, which relates to the logo, the lot trace code information, or the environmental category of the part.

Multiple part markings will be inside parentheses. Only one part marking contained in parentheses and separated by a "-" will appear on a part. If a line is indented then it is a continuation of the previous line and the two combined represent the entire part marking for that device.

Important Information and Disclaimer: The information provided on this page represents TI's knowledge and belief as of the date that it is provided. TI bases its knowledge and belief on information provided by third parties, and makes no representation or warranty as to the accuracy of such information. Efforts are underway to better integrate information from third parties. TI has taken and continues to take reasonable steps to provide representative and accurate information but may not have conducted destructive testing or chemical analysis on incoming materials and chemicals. TI and TI suppliers consider certain information to be proprietary, and thus CAS numbers and other limited information may not be available for release.

In no event shall TI's liability arising out of such information exceed the total purchase price of the TI part(s) at issue in this document sold by TI to Customer on an annual basis.

OTHER QUALIFIED VERSIONS OF TPS7H4012-SEP, TPS7H4012-SP, TPS7H4013-SEP, TPS7H4013-SP :

● Catalog : [TPS7H4012-SEP](#), [TPS7H4013-SEP](#)

● Space : [TPS7H4012-SP](#), [TPS7H4013-SP](#)

NOTE: Qualified Version Definitions:

- Catalog - TI's standard catalog product
- Space - Radiation tolerant, ceramic packaging and qualified for use in Space-based application

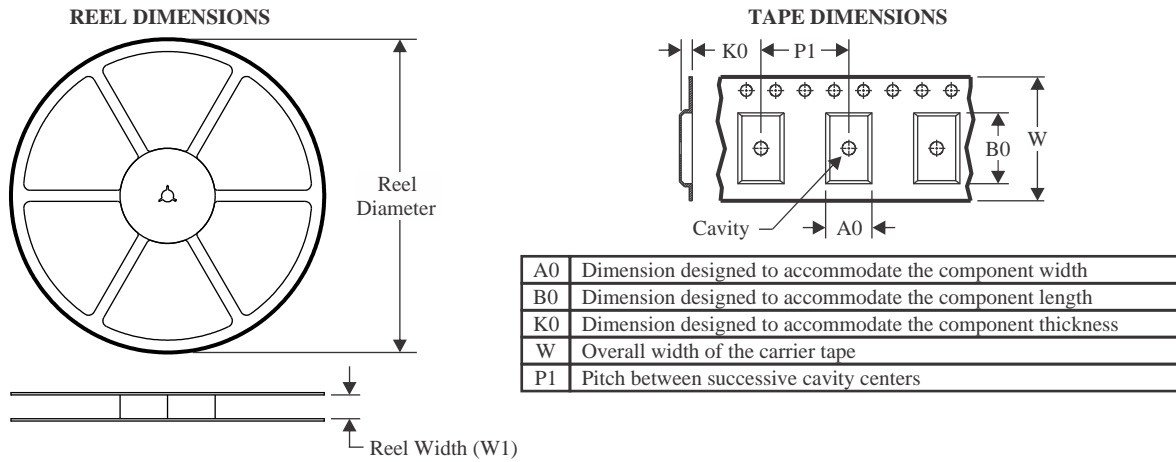
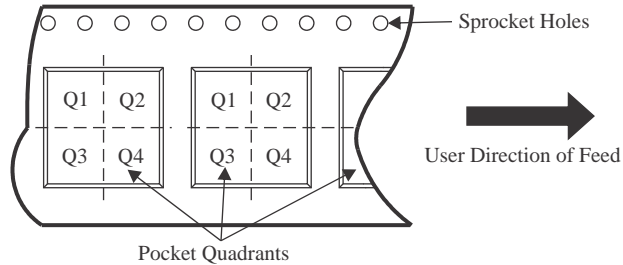
TAPE AND REEL INFORMATION

QUADRANT ASSIGNMENTS FOR PIN 1 ORIENTATION IN TAPE

*All dimensions are nominal

Device	Package Type	Package Drawing	Pins	SPQ	Reel Diameter (mm)	Reel Width W1 (mm)	A0 (mm)	B0 (mm)	K0 (mm)	P1 (mm)	W (mm)	Pin1 Quadrant
5962R2122104PYE	HTSSOP	DDW	44	250	178.0	24.4	8.6	14.5	1.8	12.0	24.0	Q1
TPS7H4013MDDWTSEP	HTSSOP	DDW	44	250	178.0	24.4	8.6	14.5	1.8	12.0	24.0	Q1

TAPE AND REEL BOX DIMENSIONS

*All dimensions are nominal

Device	Package Type	Package Drawing	Pins	SPQ	Length (mm)	Width (mm)	Height (mm)
5962R2122104PYE	HTSSOP	DDW	44	250	223.0	191.0	55.0
TPS7H4013MDDWTSEP	HTSSOP	DDW	44	250	223.0	191.0	55.0

IMPORTANT NOTICE AND DISCLAIMER

TI PROVIDES TECHNICAL AND RELIABILITY DATA (INCLUDING DATASHEETS), DESIGN RESOURCES (INCLUDING REFERENCE DESIGNS), APPLICATION OR OTHER DESIGN ADVICE, WEB TOOLS, SAFETY INFORMATION, AND OTHER RESOURCES "AS IS" AND WITH ALL FAULTS, AND DISCLAIMS ALL WARRANTIES, EXPRESS AND IMPLIED, INCLUDING WITHOUT LIMITATION ANY IMPLIED WARRANTIES OF MERCHANTABILITY, FITNESS FOR A PARTICULAR PURPOSE OR NON-INFRINGEMENT OF THIRD PARTY INTELLECTUAL PROPERTY RIGHTS.

These resources are intended for skilled developers designing with TI products. You are solely responsible for (1) selecting the appropriate TI products for your application, (2) designing, validating and testing your application, and (3) ensuring your application meets applicable standards, and any other safety, security, regulatory or other requirements.

These resources are subject to change without notice. TI grants you permission to use these resources only for development of an application that uses the TI products described in the resource. Other reproduction and display of these resources is prohibited. No license is granted to any other TI intellectual property right or to any third party intellectual property right. TI disclaims responsibility for, and you fully indemnify TI and its representatives against any claims, damages, costs, losses, and liabilities arising out of your use of these resources.

TI's products are provided subject to [TI's Terms of Sale](#), [TI's General Quality Guidelines](#), or other applicable terms available either on ti.com or provided in conjunction with such TI products. TI's provision of these resources does not expand or otherwise alter TI's applicable warranties or warranty disclaimers for TI products. Unless TI explicitly designates a product as custom or customer-specified, TI products are standard, catalog, general purpose devices.

TI objects to and rejects any additional or different terms you may propose.

Copyright © 2026, Texas Instruments Incorporated

Last updated 10/2025