

TRF0213-SEP Radiation Tolerant, Near-DC to > 14GHz, Single-Ended-to-Differential RF Amplifier

1 Features

- Vendor item drawing number: VID V62/25656
- Radiation:
 - Total ionizing dose (TID)
 - Radiation hardness assurance (RHA) up to 30krad (Si) TID
 - Enhanced low dose rate sensitivity (ELDRS) free process
 - High dose rate radiation lot acceptance testing (HDR RLAT) up to 30krad (Si) TID
 - Single event effects (SEE)
 - Single event latch-up (SEL) immune to linear energy transfer (LET) of 43MeV-cm²/mg
 - Single event transient (SET) characterized to LET of 43MeV-cm²/mg
- Space-enhanced plastic (Space EP, SEP)
 - Lead-free construction
 - Extended temperature range: –55°C to +125°C
- Single-ended input, differential output
- Excellent performance driving RF ADCs
- Fixed 14dB gain
- Bandwidth (3dB): >14GHz
- Gain flatness (1dB): 12GHz
- OIP3: 31dBm (4GHz), 31dBm (10GHz)
- OP1dB: 13.4dBm (4GHz), 15.4dBm (10GHz)
- NF: 8.9dB (4GHz), 10.6dB (10GHz)
- Gain and phase imbalance: ±0.3dB and ±3°
- Power-down feature
- 5V single-supply operation
- Active current: 174mA

2 Applications

- RF sampling or GSPS ADC driver
- [Aerospace and defense](#)
- [Phased array radar](#)
- [Communications payload](#)

- [Radar imaging payload](#)
- [Radiation tolerant applications](#)

3 Description

The TRF0213-SEP is a very high performance, radio frequency (RF) amplifier optimized for RF applications. This device is excellent for ac-coupled applications that require a single-ended to differential conversion when driving an RF sampling analog-to-digital converter (ADC) such as the high performance AFE7950-SEP or [ADC12DJ5200-SEP](#). The device combines the functionality of a wide-band gain block and a wide-band passive balun. The on-chip matching components simplify printed circuit board (PCB) implementation and provide the highest performance over the usable bandwidth. The device is fabricated in Texas Instruments' advanced complementary BiCMOS process and is available in a space-saving, WQFN-FCRLF package.

The TRF0213-SEP operates on a single-rail supply and consumes about 174mA of active current. A power-down feature is also available for power savings.

Device Information

PART NUMBER ⁽¹⁾	GRADE ⁽²⁾	BODY SIZE ⁽³⁾
TRF0213RPVTNSPG4	Space EP	2mm × 2mm Mass = 7.558mg
TRF0213RPVT/EM	Engineering samples ⁽⁴⁾	

- (1) For more information, see [Section 10](#).
- (2) For additional information about the part grade, view [part ratings](#).
- (3) The body size (length × width) is a nominal value and includes pins. Mass is a nominal value.
- (4) These units are intended for engineering evaluation only. These samples are processed to a non-compliant flow. These units are not for qualification, production, radiation testing, or flight use. Parts are not warranted for performance over the full MIL specified temperature range, or operating life.

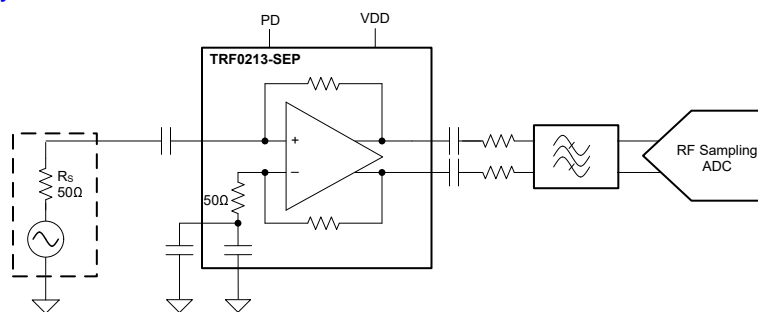

TRF0213-SEP Driving an RF Sampling ADC



Table of Contents

1 Features	1	7 Application and Implementation	18
2 Applications	1	7.1 Application Information.....	18
3 Description	1	7.2 Typical Applications.....	20
4 Pin Configuration and Functions	3	7.3 Power Supply Recommendations.....	22
5 Specifications	4	7.4 Layout.....	22
5.1 Absolute Maximum Ratings.....	4	8 Device and Documentation Support	23
5.2 ESD Ratings.....	4	8.1 Support Resources.....	23
5.3 Recommended Operating Conditions.....	4	8.2 Device Support.....	23
5.4 Thermal Information.....	4	8.3 Documentation Support.....	23
5.5 Electrical Characteristics.....	5	8.4 Receiving Notification of Documentation Updates....	23
5.6 Typical Characteristics.....	7	8.5 Trademarks.....	23
6 Detailed Description	16	8.6 Electrostatic Discharge Caution.....	23
6.1 Overview.....	16	8.7 Glossary.....	23
6.2 Functional Block Diagram.....	16	9 Revision History	23
6.3 Feature Description.....	17	10 Mechanical, Packaging, and Orderable Information	23
6.4 Device Functional Modes.....	17		

4 Pin Configuration and Functions

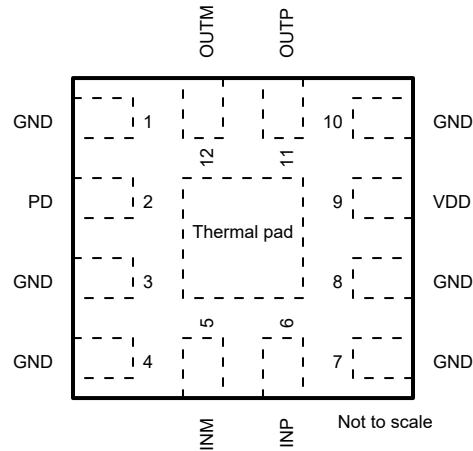

**Figure 4-1. RPV Package,
12-Pin WQFN-FCRLF
(Top View)**

Table 4-1. Pin Functions

PIN		TYPE	DESCRIPTION
NAME	NO.		
GND	1, 3, 4, 7, 8, 10	Ground	Ground
INM	5	Input	External ac coupling capacitor on negative input. Typical value 100nF.
INP	6	Input	Single ended input
OUTM	12	Output	Differential signal output, negative
OUTP	11	Output	Differential signal output, positive
PD	2	Input	Power-down signal. Supports 1.8V and 3.3V Logic. 0 = Chip enabled 1 = Power down
VDD	9	Power	5V supply
Thermal pad	TPAD	—	Thermal pad. Connect to ground on board.

5 Specifications

5.1 Absolute Maximum Ratings

over operating free-air temperature range (unless otherwise noted)⁽¹⁾

		MIN	MAX	UNIT
V _{DD}	Supply voltage	-0.3	5.5	V
P _{INP}	INP input pin power		20 ⁽²⁾	dBm
V _{INM}	INM input pin voltage	-0.3	3.3 ⁽³⁾	V
V _{PD}	Power-down pin voltage	-0.3	3.45 ⁽³⁾	V
T _J	Junction temperature		150	°C
T _{stg}	Storage temperature	-65	150	°C

- (1) Operation outside the *Absolute Maximum Ratings* may cause permanent device damage. *Absolute Maximum Ratings* do not imply functional operation of the device at these or any other conditions beyond those listed under *Recommended Operating Conditions*. If used outside the *Recommended Operating Conditions* but within the *Absolute Maximum Ratings*, the device may not be fully functional, and this may affect device reliability, functionality, performance, and shorten the device lifetime.
- (2) When V_{DD} = 0V, maximum value is 0dBm.
- (3) When V_{DD} = 0V, maximum value is 0.3V.

5.2 ESD Ratings

			VALUE	UNIT
V _(ESD)	Electrostatic discharge	Human body model (HBM), per ANSI/ESDA/JEDEC JS-001, all pins ⁽¹⁾	±1000	V
		Charged device model (CDM), per ANSI/ESDA/JEDEC JS-002, all pins ⁽²⁾	±250	

- (1) JEDEC document JEP155 states that 500V HBM allows safe manufacturing with a standard ESD control process.
- (2) JEDEC document JEP157 states that 250V CDM allows safe manufacturing with a standard ESD control process.

5.3 Recommended Operating Conditions

over operating free-air temperature range (unless otherwise noted)

		MIN	NOM	MAX	UNIT
V _{DD}	Supply voltage	4.75	5	5.25	V
T _A	Ambient free-air temperature	-55	25		°C
T _J	Junction temperature			125	°C

5.4 Thermal Information

THERMAL METRIC ⁽¹⁾		TRF0213-SEP		UNIT
		RPV (WQFN-FCRLF)		
		12 PINS		
R _{θJA}	Junction-to-ambient thermal resistance	66.7		°C/W
R _{θJC(top)}	Junction-to-case (top) thermal resistance	35.3		°C/W
R _{θJB}	Junction-to-board thermal resistance	31.1		°C/W
Ψ _{JT}	Junction-to-top characterization parameter	0.6		°C/W
Ψ _{JB}	Junction-to-board characterization parameter	31.1		°C/W
R _{θJC(bot)}	Junction-to-case (bottom) thermal resistance	10.7		°C/W

- (1) For more information about traditional and new thermal metrics, see the [Semiconductor and IC Package Thermal Metrics](#) application report.

5.5 Electrical Characteristics

at $T_A = 25^\circ\text{C}$, $V_{DD} = 5\text{V}$, 100nF ac-coupling capacitors at input and output, 50Ω single-ended input, and 100Ω differential output (unless otherwise noted)

PARAMETER		TEST CONDITIONS		MIN	TYP	MAX	UNIT
AC PERFORMANCE							
Sds21	Power gain	f = 0.5GHz			13.9		dB
		f = 2GHz			14.1		
		f = 4GHz			13.8		
		f = 8GHz			13.2		
		f = 10GHz			13.7		
		f = 12GHz			14.4		
Sss11	Input return loss	f = 10MHz to 12GHz			-12		dB
Ssd12	Reverse isolation	f = 10GHz			-34		dB
Imb _{GAIN}	Gain imbalance	f = 10MHz to 12GHz			±0.3		dB
Imb _{PHASE}	Phase imbalance	f = 10MHz to 12GHz			±3		degrees
CMRR	Common-mode rejection ratio ⁽¹⁾	f = 10GHz			-42		dB
HD2	Second-order harmonic distortion	$P_O = 3\text{dBm}$	f = 0.5GHz		-63		dBc
			f = 2GHz		-57		
			f = 4GHz		-53		
			f = 6GHz		-48		
HD3	Third-order harmonic distortion	$P_O = 3\text{dBm}$	f = 0.5GHz		-77		dBc
			f = 2GHz		-65		
			f = 4GHz		-55		
IMD2	Second-order intermodulation distortion	$P_O = -5\text{dBm}$ per tone, 10MHz spacing	f = 0.5GHz		-71		dBc
			f = 2GHz		-63		
			f = 4GHz		-58		
			f = 8GHz		-60		
			f = 10GHz		-74		
IMD3	Third-order intermodulation distortion	$P_O = -5\text{dBm}$ per tone, 10MHz spacing	f = 0.5GHz		-90		dBc
			f = 2GHz		-79		
			f = 4GHz		-72		
			f = 8GHz		-70		
			f = 10GHz		-72		
			f = 12GHz		-66		
OP1dB	Output 1dB compression point	f = 0.5GHz			13.4		dBm
		f = 2GHz			13.4		
		f = 4GHz			13.4		
		f = 8GHz			14.4		
		f = 10GHz			15.4		
		f = 12GHz			13.8		
OIP2	Output second-order intercept point	$P_O = -5\text{dBm}$ per tone, 10MHz spacing	f = 0.5GHz		66		dBm
			f = 2GHz		58		
			f = 4GHz		53		
			f = 8GHz		55		
			f = 10GHz		69		
		f = 12GHz			71		

at $T_A = 25^\circ\text{C}$, $V_{DD} = 5\text{V}$, 100nF ac-coupling capacitors at input and output, 50 Ω single-ended input, and 100 Ω differential output (unless otherwise noted)

PARAMETER		TEST CONDITIONS	MIN	TYP	MAX	UNIT
OIP3	Output third-order intercept point	$P_O = -5\text{dBm}$ per tone, 10MHz spacing	$f = 0.5\text{GHz}$	40		dBm
			$f = 2\text{GHz}$	34.5		
			$f = 4\text{GHz}$	31		
			$f = 8\text{GHz}$	30		
			$f = 10\text{GHz}$	31		
			$f = 12\text{GHz}$	28		
NF	Noise figure	$f = 0.5\text{GHz}$		7.9		dB
		$f = 2\text{GHz}$		7.9		
		$f = 4\text{GHz}$		8.9		
		$f = 8\text{GHz}$		10		
		$f = 10\text{GHz}$		10.6		
		$f = 12\text{GHz}$		10.8		
PN	Additive (residual) phase noise	$f = 1\text{GHz}$, $P_O = 10\text{dBm}$, 100Hz offset		-142		dBc/Hz
		$f = 1\text{GHz}$, $P_O = 10\text{dBm}$, 1kHz offset		-152		
		$f = 1\text{GHz}$, $P_O = 10\text{dBm}$, 10kHz offset		-157		
IMPEDANCE						
Z_{O-DIFF}	Differential output impedance	$f = \text{dc}$ (internal to the device)		12		Ω
R_{INM}	Internal INM resistance			50		Ω
C_{INM}	Internal INM capacitance			12		pF
TRANSIENT						
t_{REC}	Overdrive recovery time	Using a 0.9V _P input pulse of 2ns duration		1.5		ns
POWER SUPPLY						
I_{QA}	Active current	Current on V_{DD} pin, PD = 0		174		mA
I_{QPD}	Power-down quiescent current	Current on V_{DD} pin, PD = 1		11		mA
ENABLE						
V_{PDHIGH}	PD pin logic high		1.45			V
V_{PDLow}	PD pin logic low				0.8	V
I_{PDBIAS}	PD bias current (current on PD pin)	PD = high (1.8V logic)		40	100	μA
		PD = high (3.3V logic)		200	250	
C_{PD}	PD pin capacitance			2		pF
t_{ON}	Turn-on time	50% V_{PD} (1.8V logic) to 90% RF		100		ns
t_{OFF}	Turn-off time	50% V_{PD} (1.8V logic) to 10% RF		200		ns

(1) Calculated using the formula $(S_{21} - S_{31}) / (S_{21} + S_{31})$. Port-1: INP, Port-2: OUTP, Port-3: OUTM.

5.6 Typical Characteristics

at $T_A = 25^\circ\text{C}$, temperature curves specify ambient temperature, $V_{DD} = 5\text{V}$, 100nF ac-coupling capacitors at input and output, 50Ω single-ended input, and 100Ω differential output (unless otherwise noted)

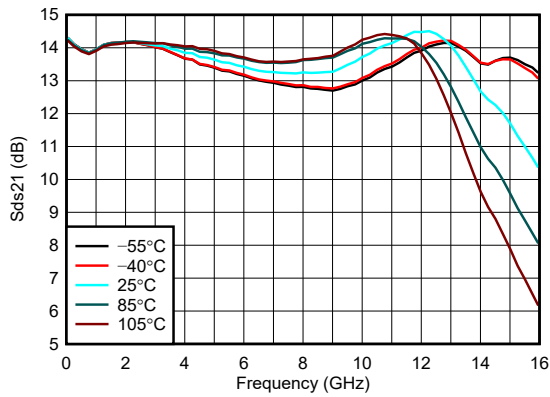

$P_{IN} = -20\text{dBm}$ with 50Ω source at all excited ports, nonexcited ports are terminated with 50Ω

Figure 5-1. Power Gain Across Temperature

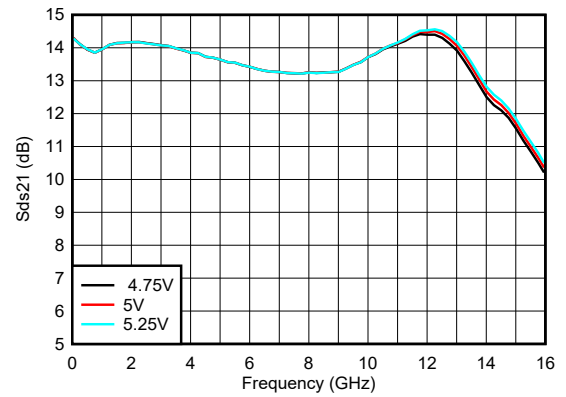

$P_{IN} = -20\text{dBm}$ with 50Ω source at all excited ports, nonexcited ports are terminated with 50Ω

Figure 5-2. Power Gain Across V_{DD}

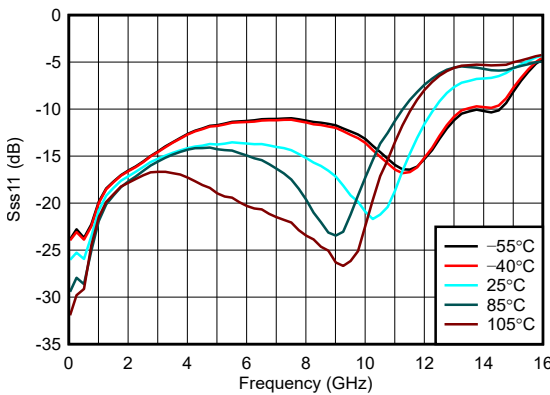

$P_{IN} = -20\text{dBm}$ with 50Ω source at all excited ports, nonexcited ports are terminated with 50Ω

Figure 5-3. Input Return Loss Across Temperature

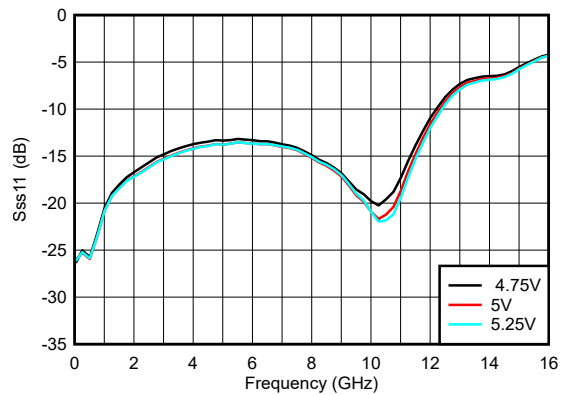

$P_{IN} = -20\text{dBm}$ with 50Ω source at all excited ports, nonexcited ports are terminated with 50Ω

Figure 5-4. Input Return Loss Across V_{DD}

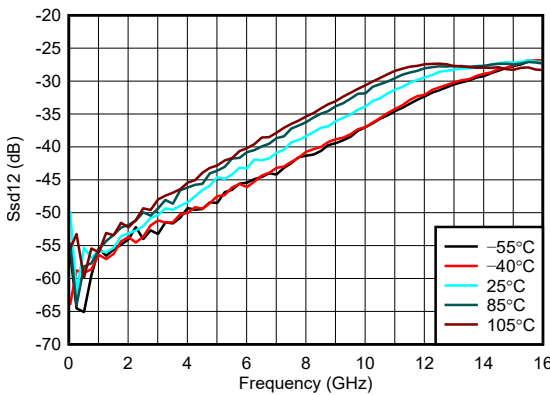

$P_{IN} = -20\text{dBm}$ with 50Ω source at all excited ports, nonexcited ports are terminated with 50Ω

Figure 5-5. Reverse Isolation Across Temperature



$P_{IN} = -20\text{dBm}$ with 50Ω source at all excited ports, nonexcited ports are terminated with 50Ω

Figure 5-6. Reverse Isolation Across V_{DD}

5.6 Typical Characteristics (continued)

at $T_A = 25^\circ\text{C}$, temperature curves specify ambient temperature, $V_{DD} = 5\text{V}$, 100nF ac-coupling capacitors at input and output, 50Ω single-ended input, and 100Ω differential output (unless otherwise noted)

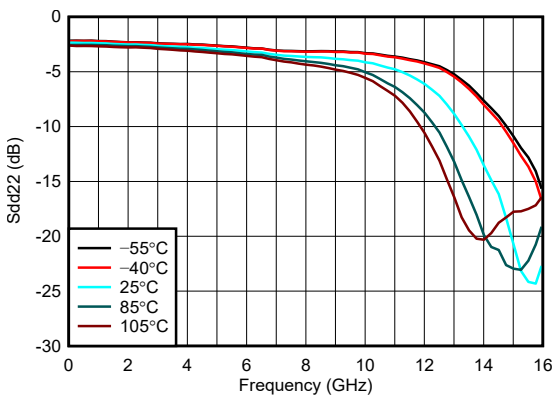

$P_{IN} = -20\text{dBm}$ with 50Ω source at all excited ports, nonexcited ports are terminated with 50Ω

Figure 5-7. Output Return Loss Across Temperature

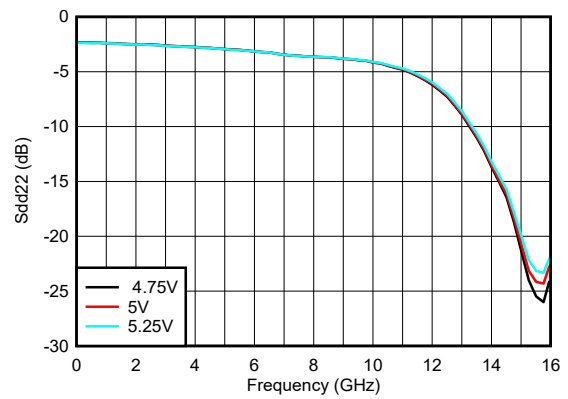

$P_{IN} = -20\text{dBm}$ with 50Ω source at all excited ports, nonexcited ports are terminated with 50Ω

Figure 5-8. Output Return Loss Across V_{DD}

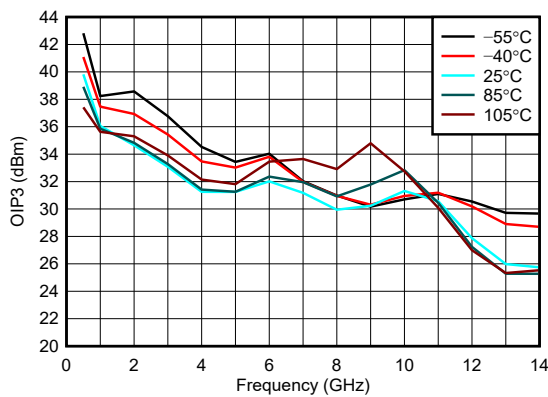

$P_O / \text{tone} = -5\text{dBm}$, 10MHz tone spacing

Figure 5-9. OIP3 Across Temperature

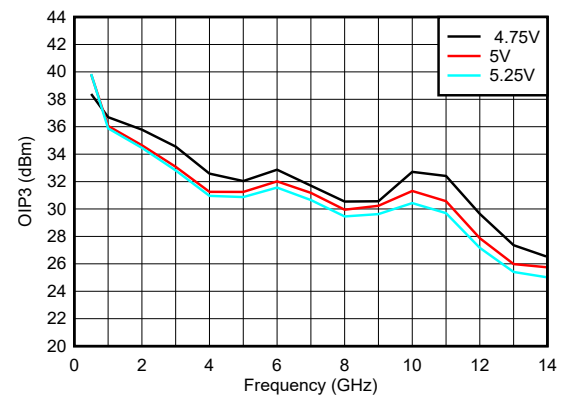

$P_O / \text{tone} = -5\text{dBm}$, 10MHz tone spacing

Figure 5-10. OIP3 Across V_{DD}

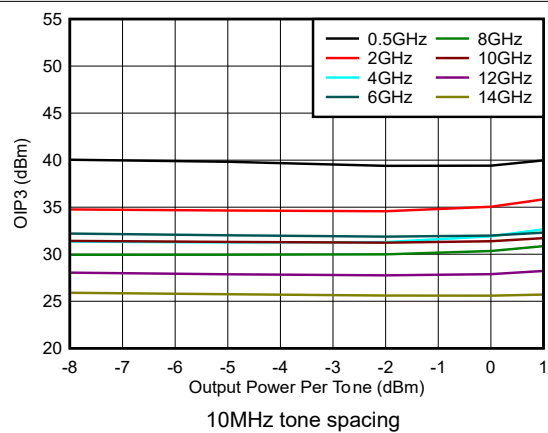

10MHz tone spacing

Figure 5-11. OIP3 Across Output Power

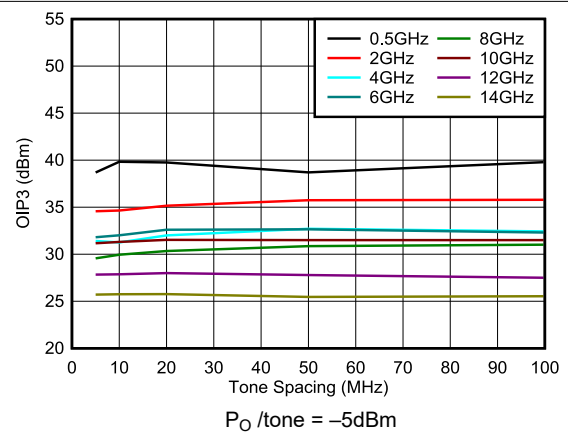

$P_O / \text{tone} = -5\text{dBm}$

Figure 5-12. OIP3 Across Tone Spacing

5.6 Typical Characteristics (continued)

at $T_A = 25^\circ\text{C}$, temperature curves specify ambient temperature, $V_{DD} = 5\text{V}$, 100nF ac-coupling capacitors at input and output, 50 Ω single-ended input, and 100 Ω differential output (unless otherwise noted)

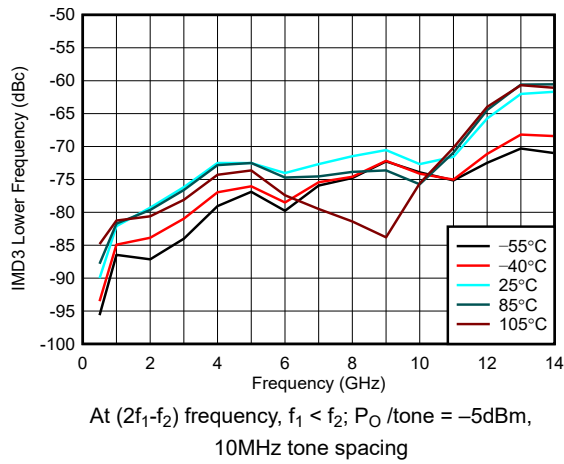

Figure 5-13. IMD3 Lower Across Temperature

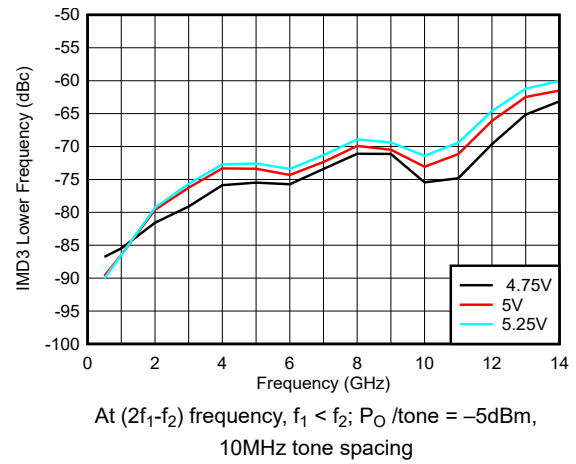

Figure 5-14. IMD3 Lower Across V_{DD}

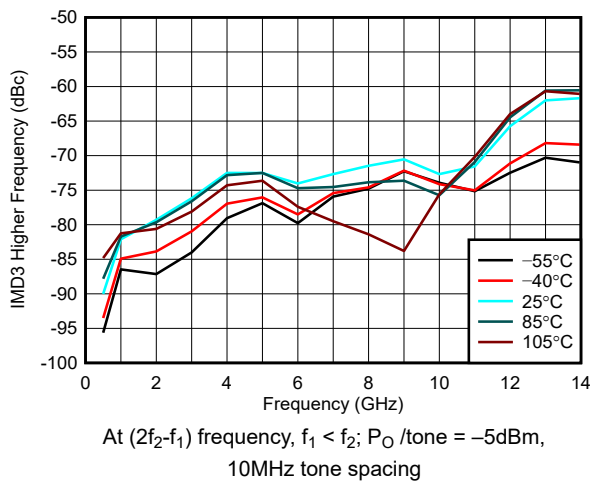

Figure 5-15. IMD3 Higher Across Temperature

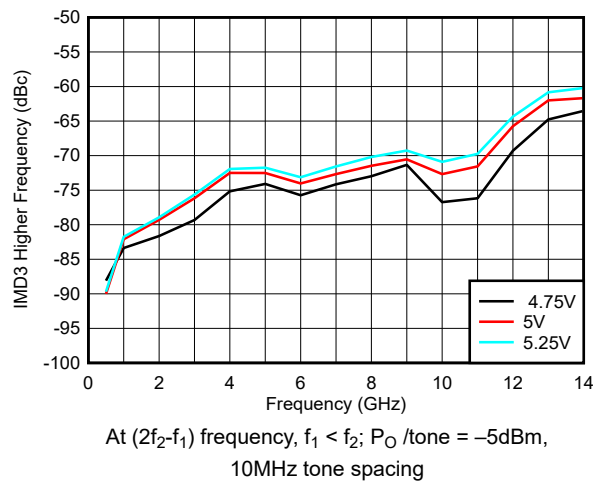

Figure 5-16. IMD3 Higher Across V_{DD}

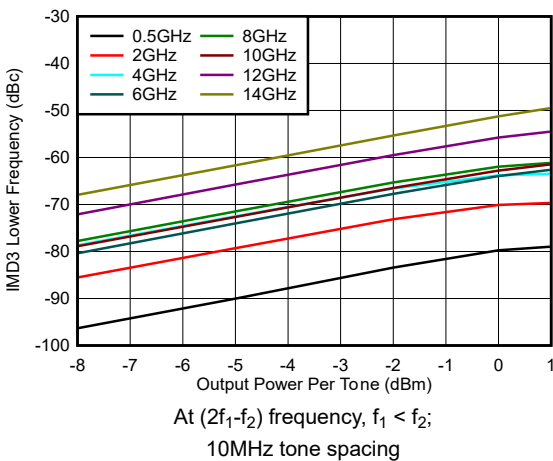

Figure 5-17. IMD3 Lower Across Output Power

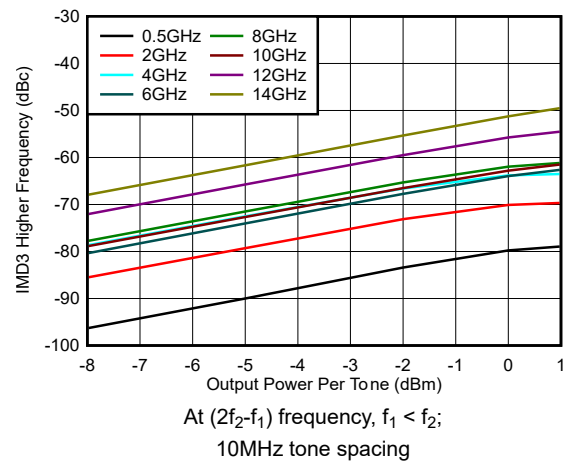

Figure 5-18. IMD3 Higher Across Output Power

5.6 Typical Characteristics (continued)

at $T_A = 25^\circ\text{C}$, temperature curves specify ambient temperature, $V_{DD} = 5\text{V}$, 100nF ac-coupling capacitors at input and output, 50Ω single-ended input, and 100Ω differential output (unless otherwise noted)

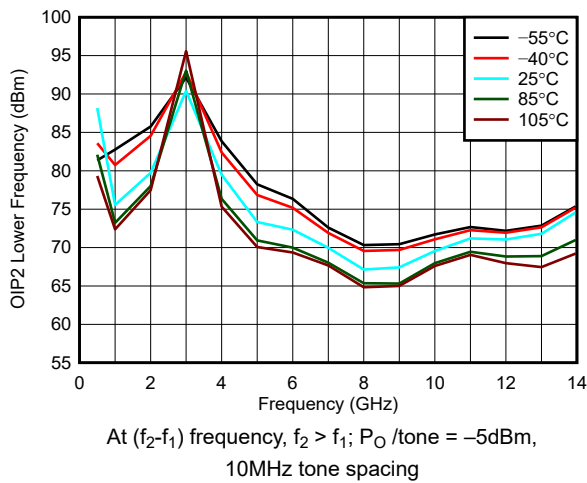

Figure 5-19. OIP2 Lower Across Temperature

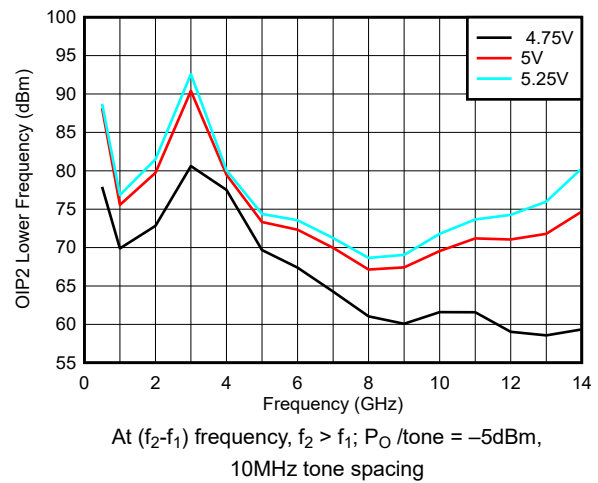

Figure 5-20. OIP2 Lower Across V_{DD}

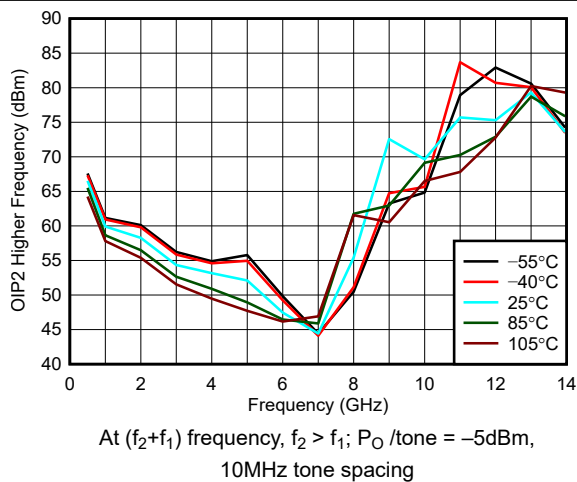

Figure 5-21. OIP2 Higher Across Temperature

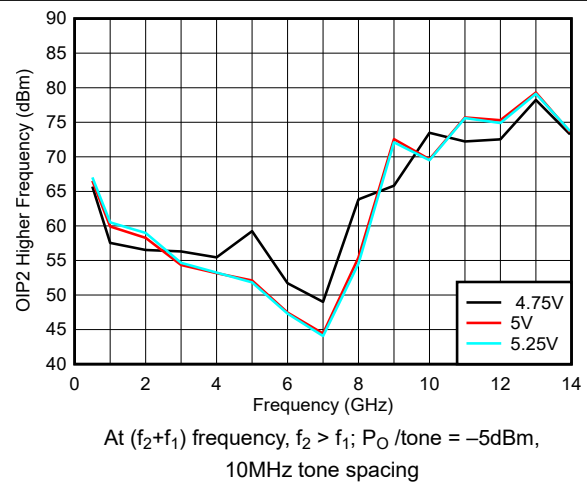

Figure 5-22. OIP2 Higher Across V_{DD}

5.6 Typical Characteristics (continued)

at $T_A = 25^\circ\text{C}$, temperature curves specify ambient temperature, $V_{DD} = 5\text{V}$, 100nF ac-coupling capacitors at input and output, 50Ω single-ended input, and 100Ω differential output (unless otherwise noted)

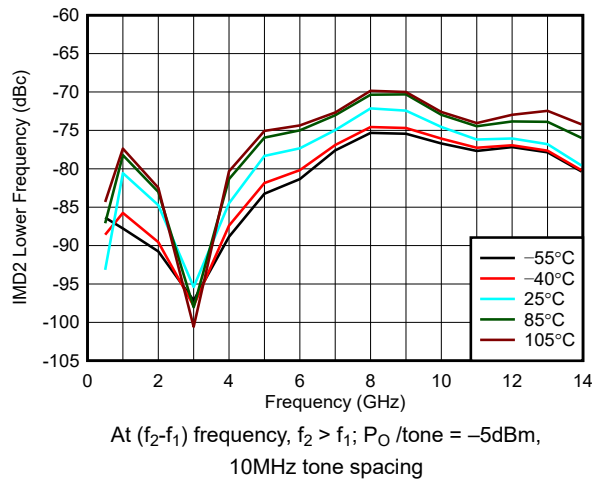

Figure 5-23. IMD2 Lower Across Temperature

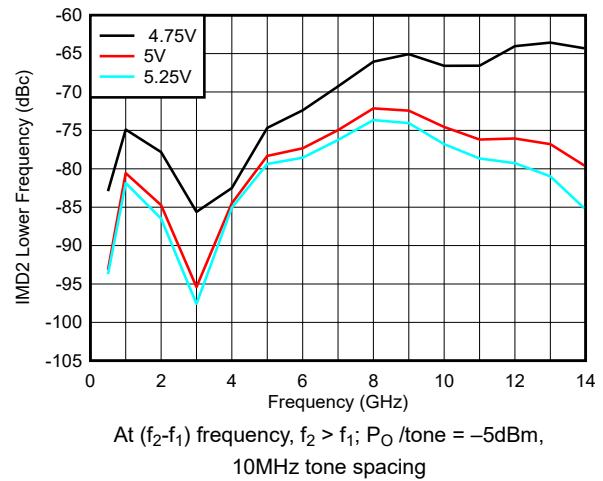

Figure 5-24. IMD2 Lower Across V_{DD}

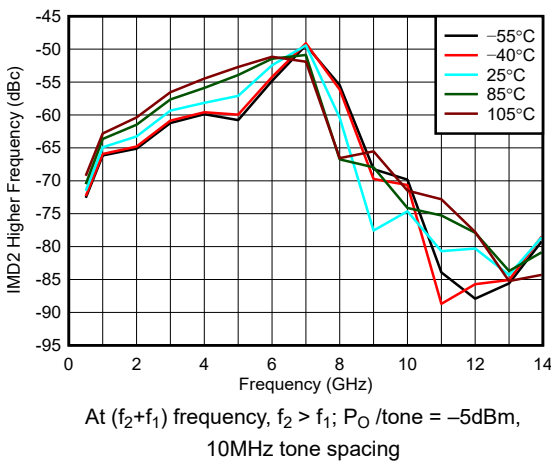

Figure 5-25. IMD2 Higher Across Temperature

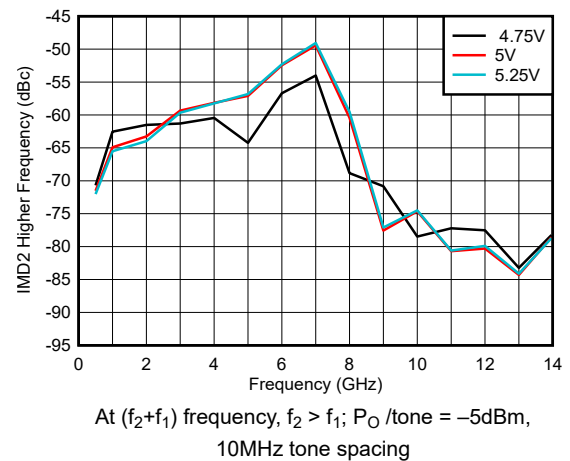

Figure 5-26. IMD2 Higher Across V_{DD}

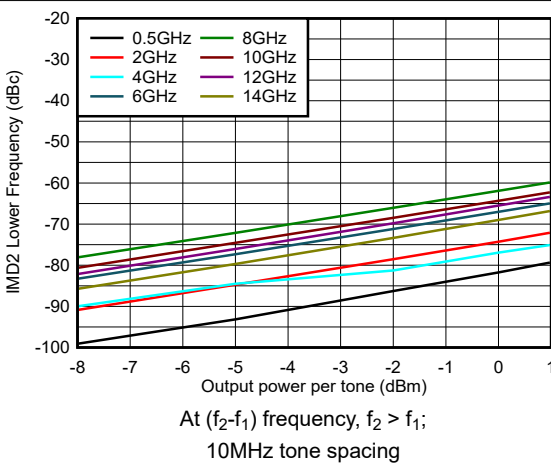

Figure 5-27. IMD2 Lower Across Output Power

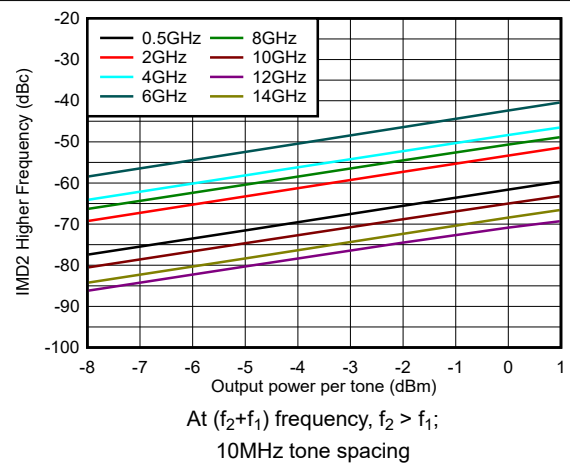

Figure 5-28. IMD2 Higher Across Output Power

5.6 Typical Characteristics (continued)

at $T_A = 25^\circ\text{C}$, temperature curves specify ambient temperature, $V_{DD} = 5\text{V}$, 100nF ac-coupling capacitors at input and output, 50 Ω single-ended input, and 100 Ω differential output (unless otherwise noted)

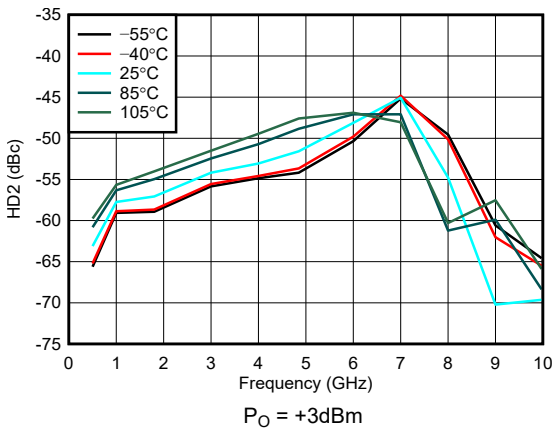

Figure 5-29. HD2 Across Temperature

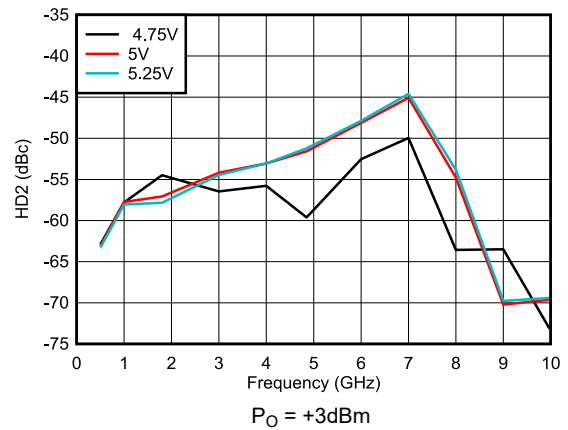

Figure 5-30. HD2 Across V_{DD}

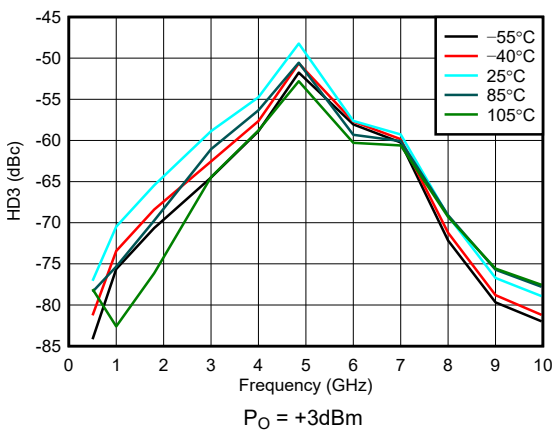

Figure 5-31. HD3 Across Temperature

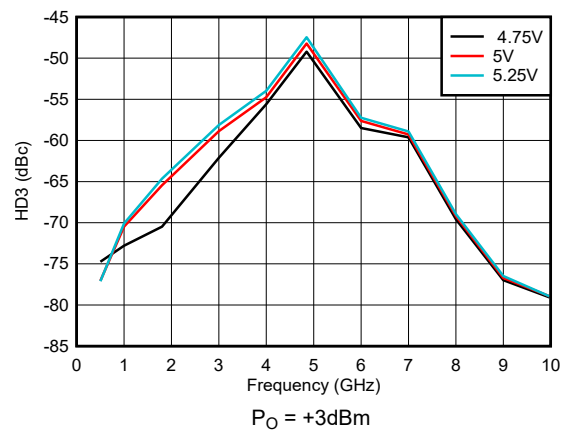

Figure 5-32. HD3 Across V_{DD}

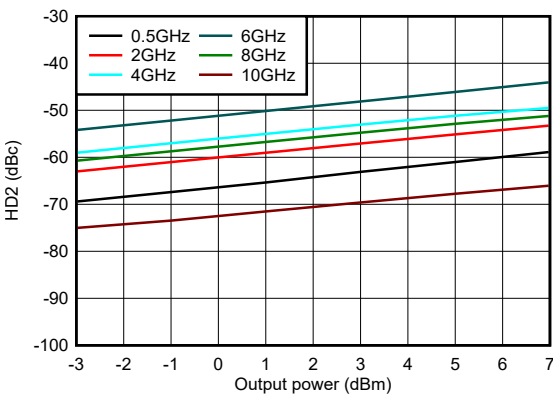

Figure 5-33. HD2 Across Output Power

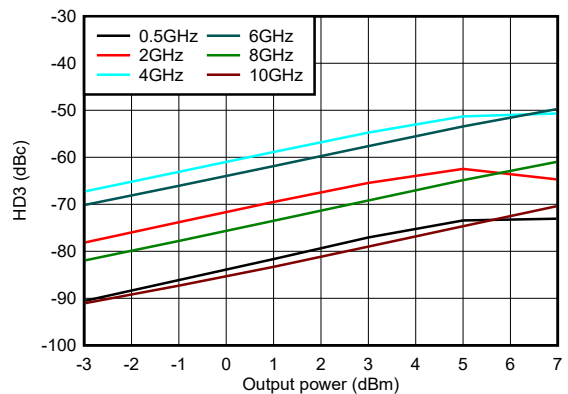

Figure 5-34. HD3 Across Output Power

5.6 Typical Characteristics (continued)

at $T_A = 25^\circ\text{C}$, temperature curves specify ambient temperature, $V_{DD} = 5\text{V}$, 100nF ac-coupling capacitors at input and output, 50Ω single-ended input, and 100Ω differential output (unless otherwise noted)

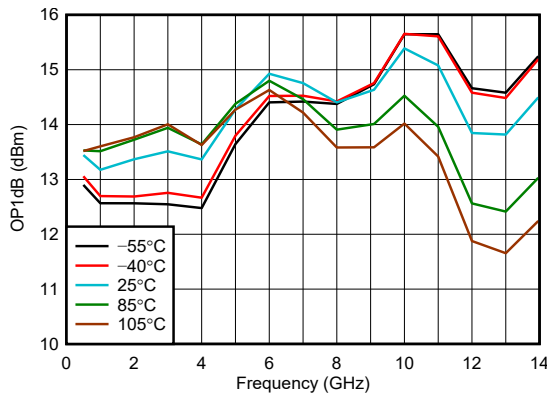

Figure 5-35. Output P1dB Across Temperature

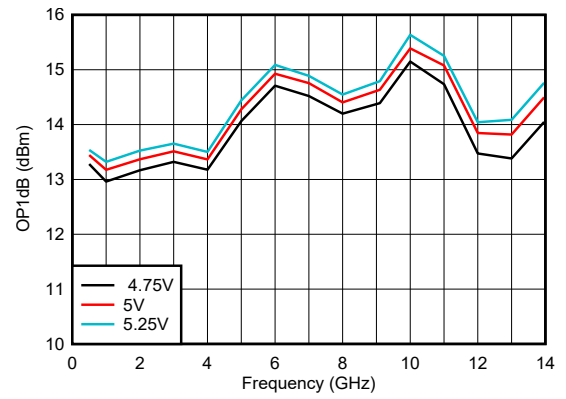

Figure 5-36. Output P1dB Across V_{DD}

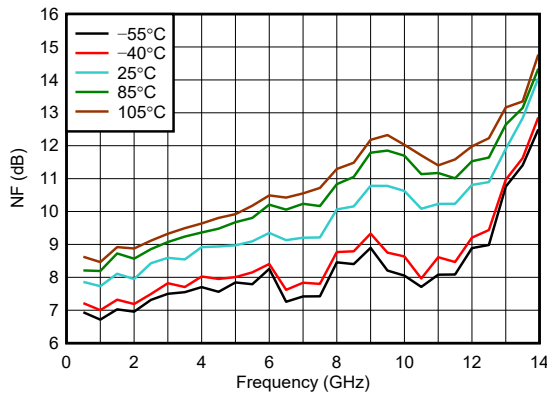

Figure 5-37. NF Across Temperature

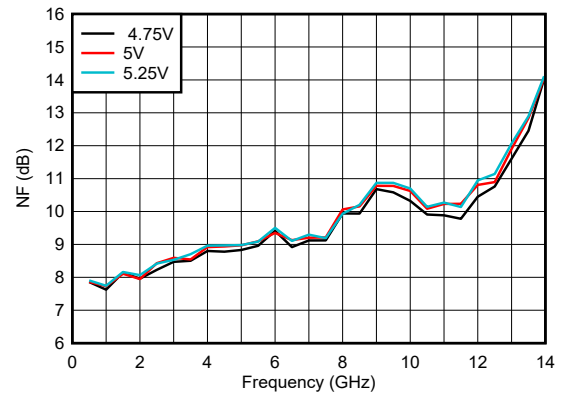

Figure 5-38. NF Across V_{DD}

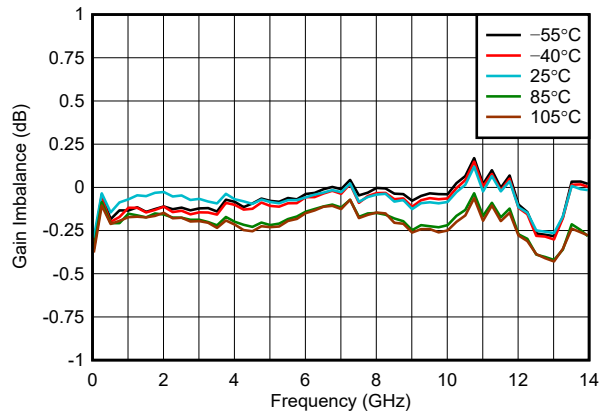

Figure 5-39. Gain Imbalance Across Temperature

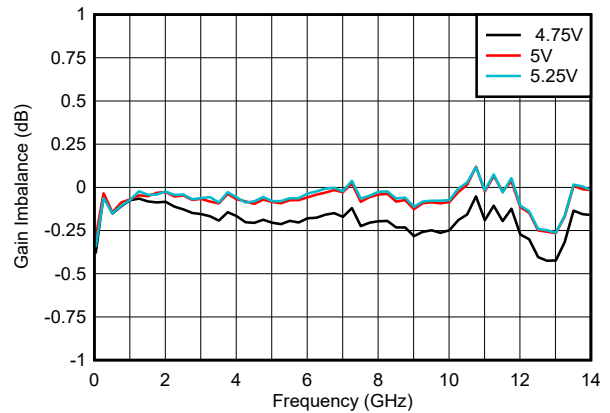

Figure 5-40. Gain Imbalance Across V_{DD}

5.6 Typical Characteristics (continued)

at $T_A = 25^\circ\text{C}$, temperature curves specify ambient temperature, $V_{DD} = 5\text{V}$, 100nF ac-coupling capacitors at input and output, 50Ω single-ended input, and 100Ω differential output (unless otherwise noted)

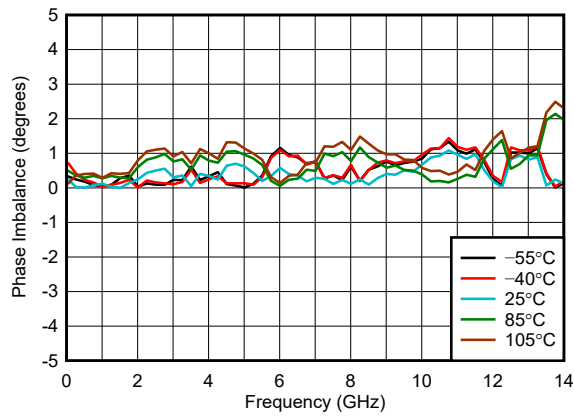

Figure 5-41. Phase Imbalance Across Temperature

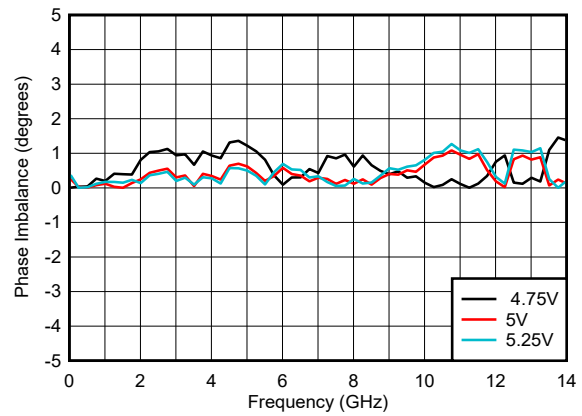

Figure 5-42. Phase Imbalance Across V_{DD}

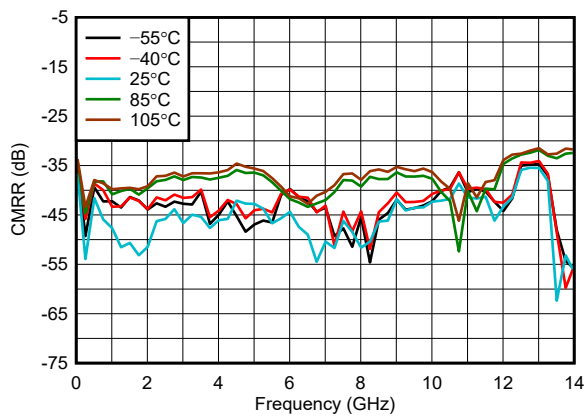

Figure 5-43. CMRR Across Temperature

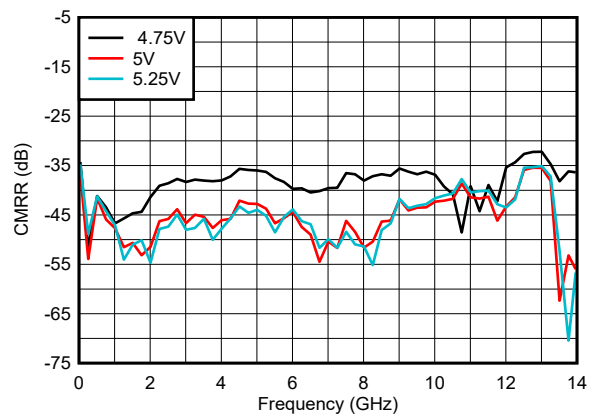

Figure 5-44. CMRR Across V_{DD}

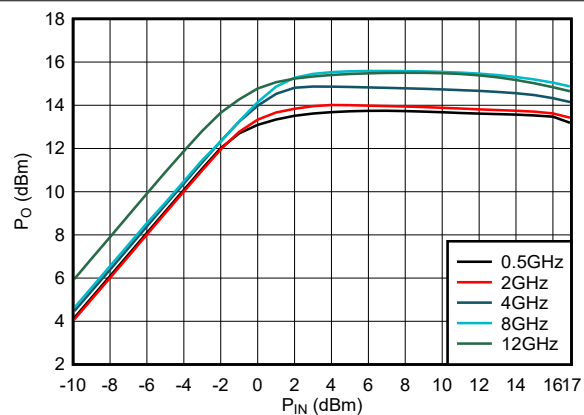
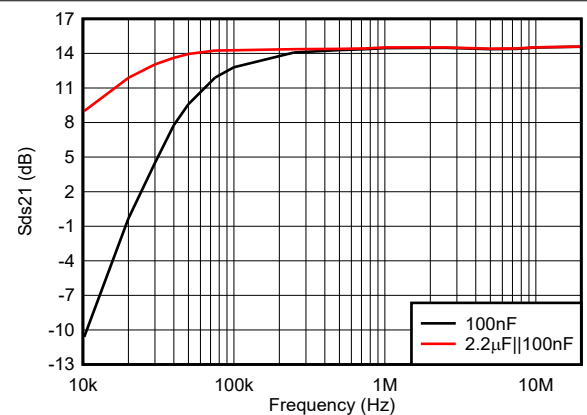

Figure 5-45. Output Power Across Input Power



Low frequency cut-off as a function of ac-coupling cap

Figure 5-46. Low Frequency Gain Response

5.6 Typical Characteristics (continued)

at $T_A = 25^\circ\text{C}$, temperature curves specify ambient temperature, $V_{DD} = 5\text{V}$, 100nF ac-coupling capacitors at input and output, 50 Ω single-ended input, and 100 Ω differential output (unless otherwise noted)

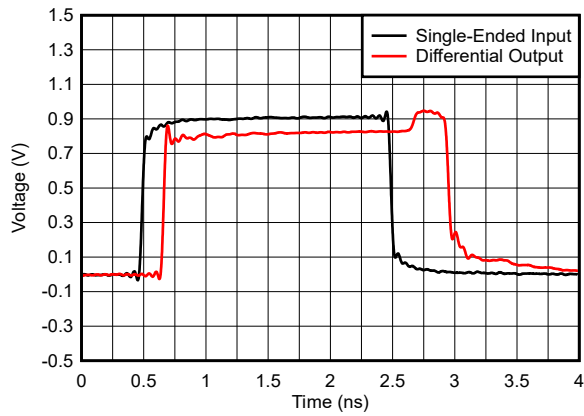

Figure 5-47. Overdrive Recovery Response

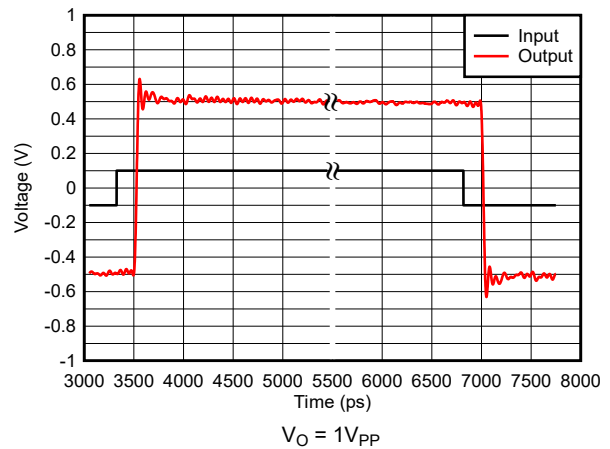

Figure 5-48. Step Response

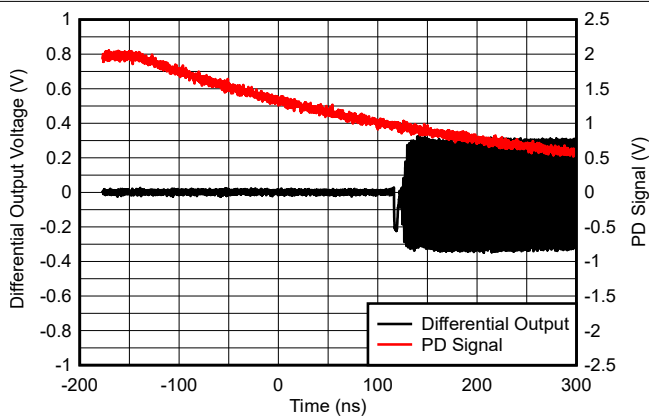

Figure 5-49. Turn-on time

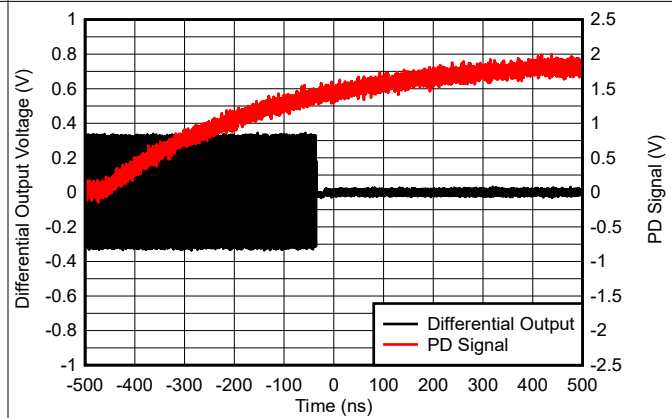

Figure 5-50. Turn-off time

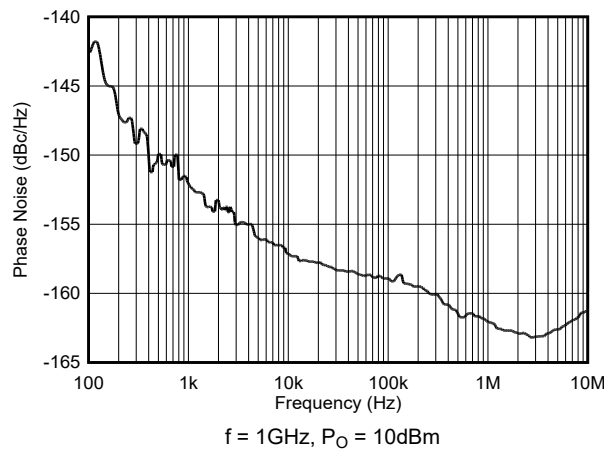

Figure 5-51. Additive (Residual) Phase Noise

6 Detailed Description

6.1 Overview

The TRF0213-SEP is a very high-performance, single-ended-to-differential RF amplifier optimized for radio frequency (RF) and intermediate frequency (IF) applications with signal bandwidths up to 14GHz. The low frequency response is limited only by the ac-coupling capacitor on the PCB. The device has flat pass-band response up to 12GHz making this device an excellent choice for wideband applications, from HF to X band. The device is designed for ac-coupled applications that require a single-ended-to-differential conversion when driving an RF sampling analog-to-digital converter (ADC). The device has a two-stage architecture and provides approximately 14dB of gain when the single-ended input is driven by a 50Ω source.

This device does not require any pullup or pulldown components on the PCB, and thereby simplifies layout and provides the highest performance over the entire bandwidth.

The TRF0213-SEP inputs and outputs are primarily designed to be ac coupled using external ac coupling capacitors. The device is powered with a single 5V supply. A power-down feature is also available.

6.2 Functional Block Diagram

The following figure shows the functional block diagram of TRF0213-SEP. The device essentially has two stages with a voltage-feedback configuration.

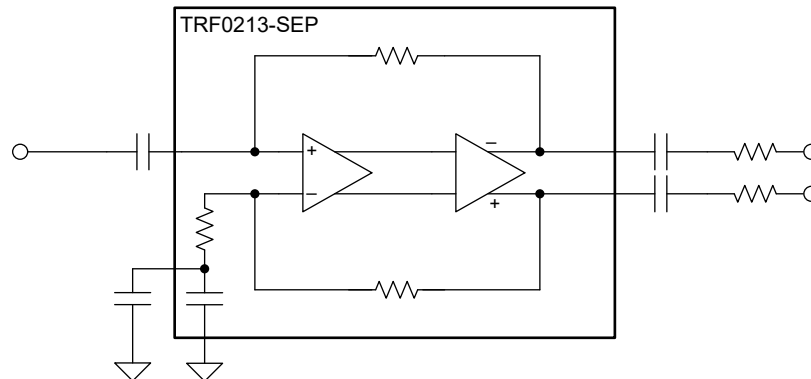

6.3 Feature Description

6.3.1 Single-Ended to Differential Amplifier

The TRF0213-SEP incorporates a voltage-feedback fully differential amplifier (FDA), with on-chip INM termination resistor and feedback resistors. The on-chip resistors reduce the effect of parasitics, and provide flat pass-band response over 12GHz of bandwidth. The input and output bias voltages are set internally simplifying applications by placing ac-coupling capacitors on the RF input and output pins.

The TRF0213-SEP operates as a single-ended to differential amplifier with a fixed gain of 14dB.

The amplifier has non-linearity cancellation circuits that provide excellent linearity performance over a wide range of frequencies.

The input return loss is better than 10dB over wide bandwidth eliminating the requirement for input matching network. The output of the amplifier has a low dc impedance. Therefore, if required, a series resistor or attenuator pad can be added at the output to provide output impedance.

The TRF0213-SEP operates on a single 5V supply. Single-supply operation simplifies the board design.

6.3.2 Single Supply Operation

The TRF0213-SEP operates on a single 5V supply. The input and output bias voltages are set internally. Therefore, ac-couple the signal path on the board at all RF input and output pins. Single-supply operation simplifies the board design.

6.4 Device Functional Modes

The TRF0213-SEP has two functional modes: active and power-down. These functional modes are controlled by the PD pin as described in the next section.

6.4.1 Power-Down Mode

The device features a power-down option. The PD pin is used to power down the amplifier. This pin supports both 1.8V and 3.3V digital logic, and is referenced to ground. A logic 1 turns the device off and places the device into a low-quiescent-current state.

When disabled, the signal path is still present through the internal circuits. Input signals applied to a disabled device still appear at the outputs at some lower level through this path, as is the case for any disabled feedback amplifier.

7 Application and Implementation

Note

Information in the following applications sections is not part of the TI component specification, and TI does not warrant its accuracy or completeness. TI's customers are responsible for determining suitability of components for their purposes, as well as validating and testing their design implementation to confirm system functionality.

7.1 Application Information

7.1.1 Driving a High-Speed ADC

A common application for the TRF0213-SEP is driving a high-speed ADC that has a differential input (such as the ADC12DJ5200-SEP or AFE7950-SEP). Conventionally, passive baluns are used to drive giga-samples-per-second (GSPS) ADCs as a result of the low availability of high-bandwidth, linear amplifiers. The TRF0213-SEP is a single-ended to differential (S2D) RF amplifier that has excellent bandwidth flatness, gain, and phase imbalance comparable to or exceeding costly, passive RF baluns.

Figure 7-1 shows a typical interface circuit for ADC12DJ5200-SEP. Depending on the ADC and system requirements, this circuit can be simplified or made more complex.

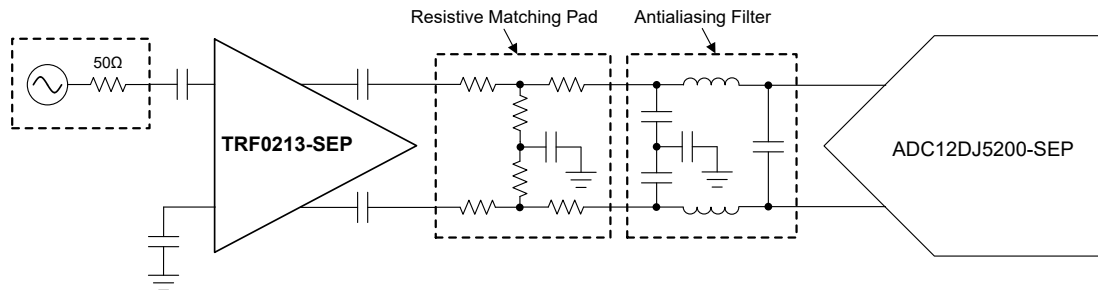
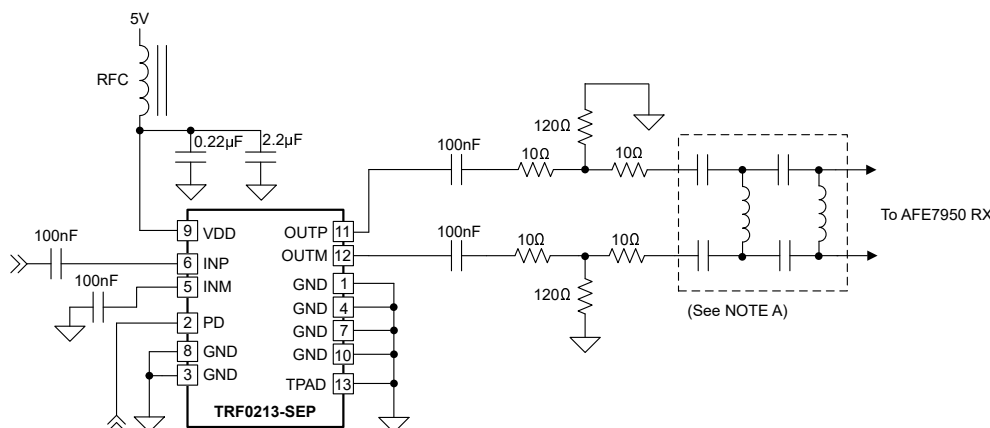

Figure 7-1. Interfacing With the ADC12DJ5200RF

Figure 7-1 shows two sections of the circuit between the driver amp and the ADC: namely, the matching pad (or attenuator pad) and the antialiasing filter. Use small-form-factor, RF-quality, passive components for these circuits. The output swing of the TRF0213-SEP is designed to drive these ADCs to full-scale, while at the same time not overdrive the ADC. This functionality avoids the need for any voltage limiting device at the ADC.

Figure 7-2 shows a typical interface circuit for the AFE7950-SEP, where the TRF0213-SEP is the S2D amplifier.



A. AFE matching network: component type (L or C) and values depend on the channel (A, B, C, D, FB1, FB2) and frequency band.

Figure 7-2. Interfacing With the AFE7950 RX

7.1.2 Calculating Output Voltage Swing

This section gives a quick reference of the output voltage swings for different input power levels. In this example, the output is terminated with a 100Ω differential load and a power gain of 14dB is assumed.

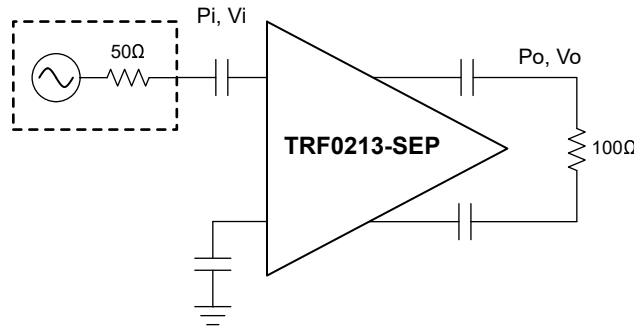

Figure 7-3. Power and Voltage Levels

$$\text{Voltage gain} = 20 \times \log(V_O / V_I) \tag{1}$$

$$\text{Power gain} = 10 \times \log(P_O / P_I) = 10 \times \log((V_O^2 / 100) / (V_I^2 / 50)) = 20 \times \log(V_O / V_I) - 3\text{dB} \tag{2}$$

Table 7-1. Output Voltage Swings for Different Input Power Levels

SINGLE-ENDED INPUT		DIFFERENTIAL OUTPUT (TRF0213-SEP)	
P_I (dBm ₅₀)	V_I (V _{PP})	P_O (dBm ₁₀₀)	V_O (V _{PP})
-18	0.080	-4	0.564
-13	0.142	1	1.004
-8	0.252	6	1.785
-7	0.283	7	2.002

7.1.3 Thermal Considerations

The TRF0213-SEP is available in a 2mm × 2mm, WQFN-FCRLF package that has excellent thermal properties. Connect the thermal pad underneath the chip to a ground plane. Short the ground plane to the other ground pins of the chip, if possible, to allow heat propagation to the top layer of PCB. Use a thermal via that connects the thermal pad plane on the top layer of the PCB to the inner layer ground planes to allow heat propagation to the inner layers.

7.2 Typical Applications

An example of the TRF0213-SEP acting as an S2D amplifier for the AFE7950-SEP is explained in this section.

7.2.1 TRF0213-SEP in Receive Chain

This section describes an RF receiver chain in which the TRF0213-SEP operates as a single-ended-to-differential (S2D) amplifier and drives a receive channel of AFE7950-SEP.

Figure 7-4 shows a generic schematic of a design in which TRF0213-SEP drives an AFE7950-SEP receive channel. The exact values of the components depend on the frequency band for which the AFE7950-SEP front-end is matched.

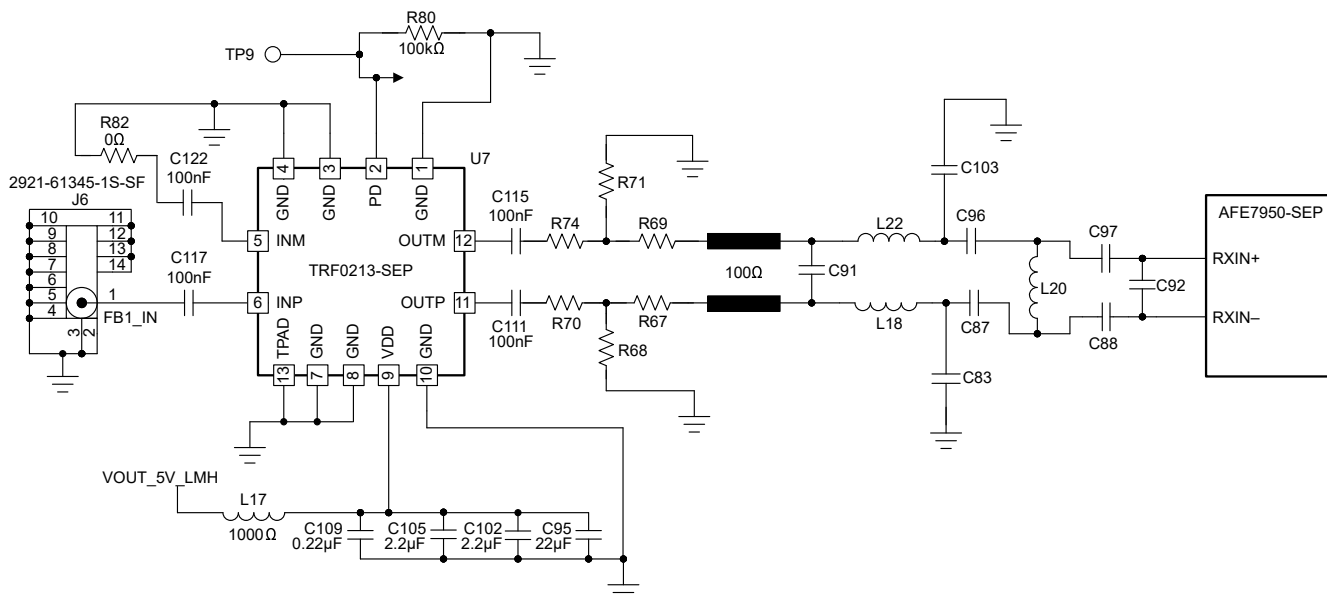

Figure 7-4. TRF0213-SEP in a Receive Chain With the AFE7950-SEP

7.2.1.1 Design Requirements

The AFE7950-SEP RXC channel is required to be matched to 9.6GHz.

7.2.1.2 Detailed Design Procedure

The TRF0213-SEP is configured as an S2D amplifier. The section close to TRF0213-SEP output is an attenuator pad that is meant for robust matching. The section close to the AFE7950-SEP is the matching network for the AFE7950-SEP ADC input that is channel dependent. The matching components are chosen based on the AFE7950-SEP return-loss data and some final optimization because the manufactured board parameters can influence the exact component values needed.

Table 7-2 shows the bill of materials (BOM) values of the design for RXC channel that is matched to center frequency of 9.6GHz.

Table 7-2. Component Values of RX Chain With Center Frequency = 9.6GHz

SECTION	DESIGNATOR	TYPE	VALUE	INSTALL OR DO NOT INSTALL
DC block cap	C117	Capacitor	100nF	Install
DC block cap	C115	Capacitor	100nF	Install
DC block cap	C111	Capacitor	100nF	Install
DC block cap	C122	Capacitor	100nF	Install
INM term	R82	Resistor	0Ω	Install
Attenuator	R74	Resistor	10Ω	Install
Attenuator	R70	Resistor	10Ω	Install
Attenuator	R69	Resistor	10Ω	Install
Attenuator	R67	Resistor	10Ω	Install
Attenuator	R71	Resistor	120Ω	Install
Attenuator	R68	Resistor	120Ω	Install
Matching	C91	—	—	Do not install
Matching	C103	—	—	Do not install
Matching	C83	—	—	Do not install
Matching	L22	Inductor	0.1nH	Install
Matching	L18	Inductor	0.1nH	Install
Matching	C96	Inductor	0.1nH	Install
Matching	C87	Inductor	0.1nH	Install
Matching	L20	Inductor	0.6nH	Install
Matching	C97	Capacitor	0.3pF	Install
Matching	C88	Capacitor	0.3pF	Install
Matching	C92	—	—	Do not install

7.2.1.3 Application Curve

Figure 7-5 shows the in-band output response for the design in the previous section. The response is measured by AFE7950 on RXC channel with an input power of -35dBm at the input of TRF0213-SEP.

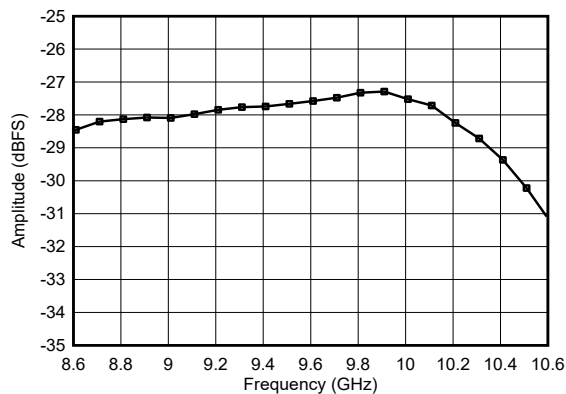

Figure 7-5. In-Band Output Response

7.3 Power Supply Recommendations

The TRF0213-SEP requires a single 5V supply. Supply decoupling is critical to high-frequency performance. Typically two or three capacitors are used for supply decoupling. For the lowest-value capacitor, use a small, form-factor component that is placed closest to the V_{DD} pin of the device. Use a bulk decoupling capacitor of a larger value and size that can be placed next to the small capacitor. See also [Section 7.4](#).

7.4 Layout

7.4.1 Layout Guidelines

TRF0213-SEP is a wide-band, voltage-feedback amplifier with approximately 14dB of gain. When designing with a wide-band RF amplifier with relatively high gain, take precautions with board layout to maintain stability and optimized performance. Use a multilayer board to maintain signal and power integrity and thermal performance. [Figure 7-6](#) shows an example of a good layout. This figure shows only the top layer.

Route the RF input and output lines as grounded coplanar waveguide (GCPW) lines. For the second layer, use a continuous ground layer without any ground-cuts near the amplifier area. Match the output differential lines in length to minimize phase imbalance. Use small-footprint passive components wherever possible. Also take care of the input side layout. Use a 50Ω line for the INP routing, and maintain that the termination on INM pin has low parasitics by placing the ac-coupling capacitor very close to the device. Maintain that the ground planes on the top and internal layers are well stitched with vias.

Place thermal vias under the device that connect the top thermal pad with ground planes in the inner layers of the PCB. For improved heat dissipation, connect the thermal pad to the top-layer ground plane through the ground pins (see also [Section 7.4.2](#)).

7.4.2 Layout Example

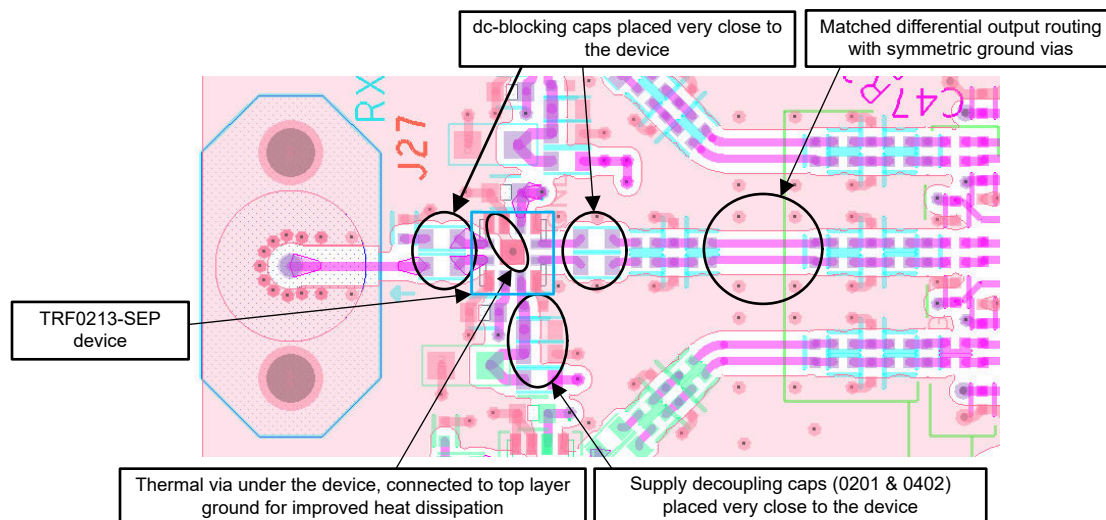

Figure 7-6. Layout Example – Placement and Top Layer Layout

The TRF0213-SEP device can be evaluated using the TRF0213-SEP EVM board. Additional information about the evaluation board construction and test setup is given in the *TRF0213-SEP EVM* user's guide.

8 Device and Documentation Support

8.1 Support Resources

TI E2E™ support forums are an engineer's go-to source for fast, verified answers and design help — straight from the experts. Search existing answers or ask your own question to get the quick design help you need.

Linked content is provided "AS IS" by the respective contributors. They do not constitute TI specifications and do not necessarily reflect TI's views; see TI's [Terms of Use](#).

8.2 Device Support

8.2.1 Third-Party Products Disclaimer

TI'S PUBLICATION OF INFORMATION REGARDING THIRD-PARTY PRODUCTS OR SERVICES DOES NOT CONSTITUTE AN ENDORSEMENT REGARDING THE SUITABILITY OF SUCH PRODUCTS OR SERVICES OR A WARRANTY, REPRESENTATION OR ENDORSEMENT OF SUCH PRODUCTS OR SERVICES, EITHER ALONE OR IN COMBINATION WITH ANY TI PRODUCT OR SERVICE.

8.3 Documentation Support

8.3.1 Related Documentation

For related documentation, see the following:

- Texas Instruments, *TRF0213-SEP EVM* user's guide
- Texas Instruments, [TRF0213-SEP Total Ionizing Dose \(TID\) Report](#)
- Texas Instruments, [TRF0213-SEP Single-Event Effects Test Report](#)

8.4 Receiving Notification of Documentation Updates

To receive notification of documentation updates, navigate to the device product folder on [ti.com](#). Click on *Notifications* to register and receive a weekly digest of any product information that has changed. For change details, review the revision history included in any revised document.

8.5 Trademarks

TI E2E™ is a trademark of Texas Instruments.

All trademarks are the property of their respective owners.

8.6 Electrostatic Discharge Caution



This integrated circuit can be damaged by ESD. Texas Instruments recommends that all integrated circuits be handled with appropriate precautions. Failure to observe proper handling and installation procedures can cause damage.

ESD damage can range from subtle performance degradation to complete device failure. Precision integrated circuits may be more susceptible to damage because very small parametric changes could cause the device not to meet its published specifications.

8.7 Glossary

[TI Glossary](#) This glossary lists and explains terms, acronyms, and definitions.

9 Revision History

NOTE: Page numbers for previous revisions may differ from page numbers in the current version.

DATE	REVISION	NOTES
December 2025	*	Initial Release

10 Mechanical, Packaging, and Orderable Information

The following pages include mechanical, packaging, and orderable information. This information is the most current data available for the designated devices. This data is subject to change without notice and revision of this document. For browser-based versions of this data sheet, refer to the left-hand navigation.

PACKAGING INFORMATION

Orderable part number	Status (1)	Material type (2)	Package Pins	Package qty Carrier	RoHS (3)	Lead finish/ Ball material (4)	MSL rating/ Peak reflow (5)	Op temp (°C)	Part marking (6)
TRF0213RPVT/EM	Active	Production	WQFN-HR (RPV) 12	250 LARGE T&R	Yes	NIPDAU	Level-2-260C-1 YEAR	25 to 125	E213
TRF0213RPVTNSPG4	Active	Production	WQFN-HR (RPV) 12	250 LARGE T&R	Yes	NIPDAU	Level-2-260C-1 YEAR	-55 to 125	0213
V62/25656	Active	Production	WQFN-HR (RPV) 12	250 LARGE T&R	Yes	NIPDAU	Level-2-260C-1 YEAR	-55 to 125	0213

(1) **Status:** For more details on status, see our [product life cycle](#).

(2) **Material type:** When designated, preproduction parts are prototypes/experimental devices, and are not yet approved or released for full production. Testing and final process, including without limitation quality assurance, reliability performance testing, and/or process qualification, may not yet be complete, and this item is subject to further changes or possible discontinuation. If available for ordering, purchases will be subject to an additional waiver at checkout, and are intended for early internal evaluation purposes only. These items are sold without warranties of any kind.

(3) **RoHS values:** Yes, No, RoHS Exempt. See the [TI RoHS Statement](#) for additional information and value definition.

(4) **Lead finish/Ball material:** Parts may have multiple material finish options. Finish options are separated by a vertical ruled line. Lead finish/Ball material values may wrap to two lines if the finish value exceeds the maximum column width.

(5) **MSL rating/Peak reflow:** The moisture sensitivity level ratings and peak solder (reflow) temperatures. In the event that a part has multiple moisture sensitivity ratings, only the lowest level per JEDEC standards is shown. Refer to the shipping label for the actual reflow temperature that will be used to mount the part to the printed circuit board.

(6) **Part marking:** There may be an additional marking, which relates to the logo, the lot trace code information, or the environmental category of the part.

Multiple part markings will be inside parentheses. Only one part marking contained in parentheses and separated by a "-" will appear on a part. If a line is indented then it is a continuation of the previous line and the two combined represent the entire part marking for that device.

Important Information and Disclaimer: The information provided on this page represents TI's knowledge and belief as of the date that it is provided. TI bases its knowledge and belief on information provided by third parties, and makes no representation or warranty as to the accuracy of such information. Efforts are underway to better integrate information from third parties. TI has taken and continues to take reasonable steps to provide representative and accurate information but may not have conducted destructive testing or chemical analysis on incoming materials and chemicals. TI and TI suppliers consider certain information to be proprietary, and thus CAS numbers and other limited information may not be available for release.

In no event shall TI's liability arising out of such information exceed the total purchase price of the TI part(s) at issue in this document sold by TI to Customer on an annual basis.

TAPE AND REEL INFORMATION

QUADRANT ASSIGNMENTS FOR PIN 1 ORIENTATION IN TAPE



*All dimensions are nominal

Device	Package Type	Package Drawing	Pins	SPQ	Reel Diameter (mm)	Reel Width W1 (mm)	A0 (mm)	B0 (mm)	K0 (mm)	P1 (mm)	W (mm)	Pin1 Quadrant
TRF0213RPVT/EM	WQFN-HR	RPV	12	250	180.0	8.4	2.3	2.3	1.15	4.0	8.0	Q2
TRF0213RPVTNSPG4	WQFN-HR	RPV	12	250	180.0	8.4	2.3	2.3	1.15	4.0	8.0	Q2

TAPE AND REEL BOX DIMENSIONS

*All dimensions are nominal

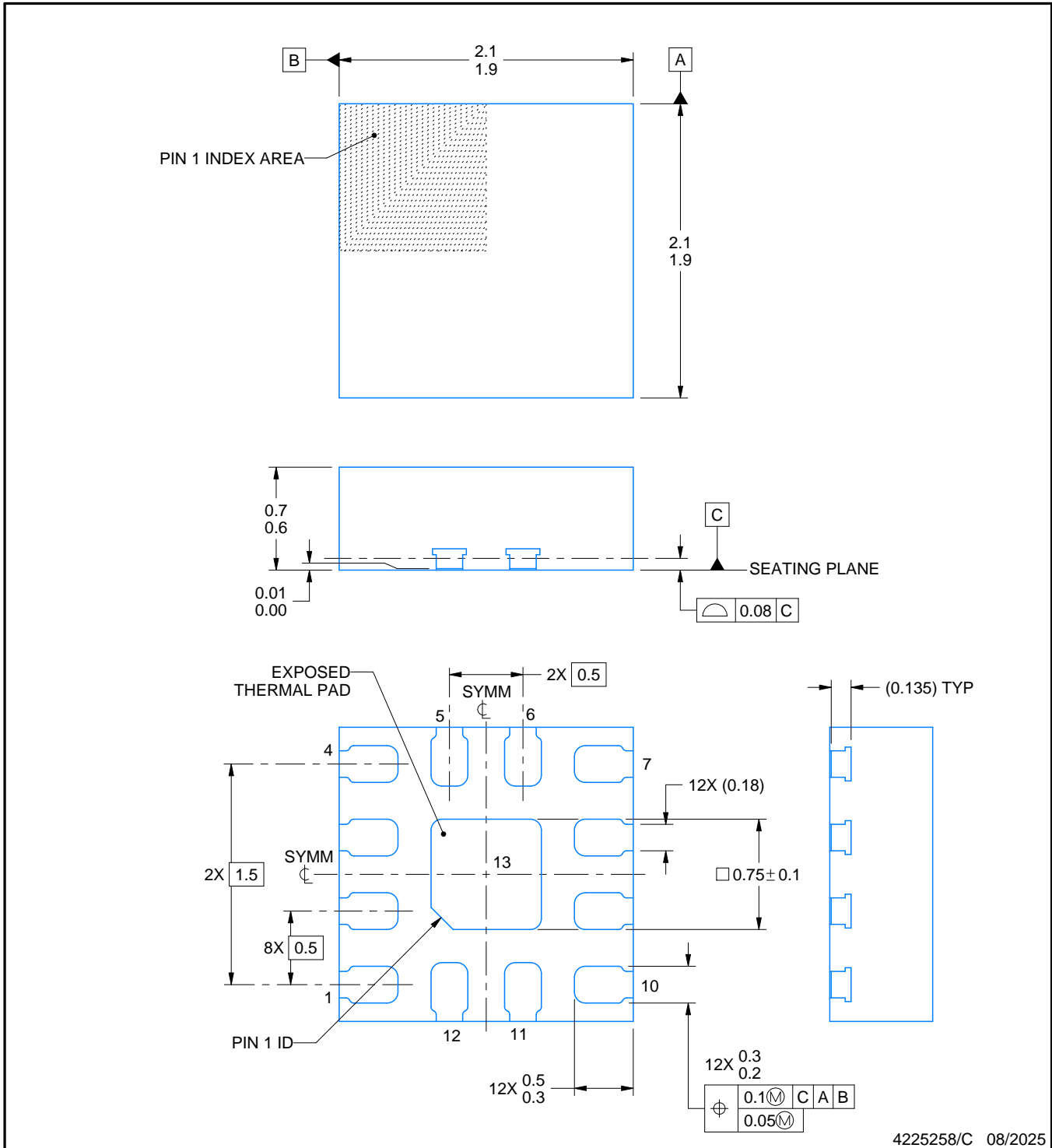
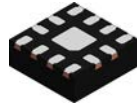
Device	Package Type	Package Drawing	Pins	SPQ	Length (mm)	Width (mm)	Height (mm)
TRF0213RPVT/EM	WQFN-HR	RPV	12	250	210.0	185.0	35.0
TRF0213RPVTNSPG4	WQFN-HR	RPV	12	250	210.0	185.0	35.0



4225258/C 08/2025

NOTES:

1. All linear dimensions are in millimeters. Any dimensions in parenthesis are for reference only. Dimensioning and tolerancing per ASME Y14.5M.
2. This drawing is subject to change without notice.
3. The package thermal pad must be soldered to the printed circuit board for thermal and mechanical performance.

EXAMPLE BOARD LAYOUT

RPV0012A

WQFN-FCRLF - 0.7 mm max height

PLASTIC QUAD FLATPACK - NO LEAD

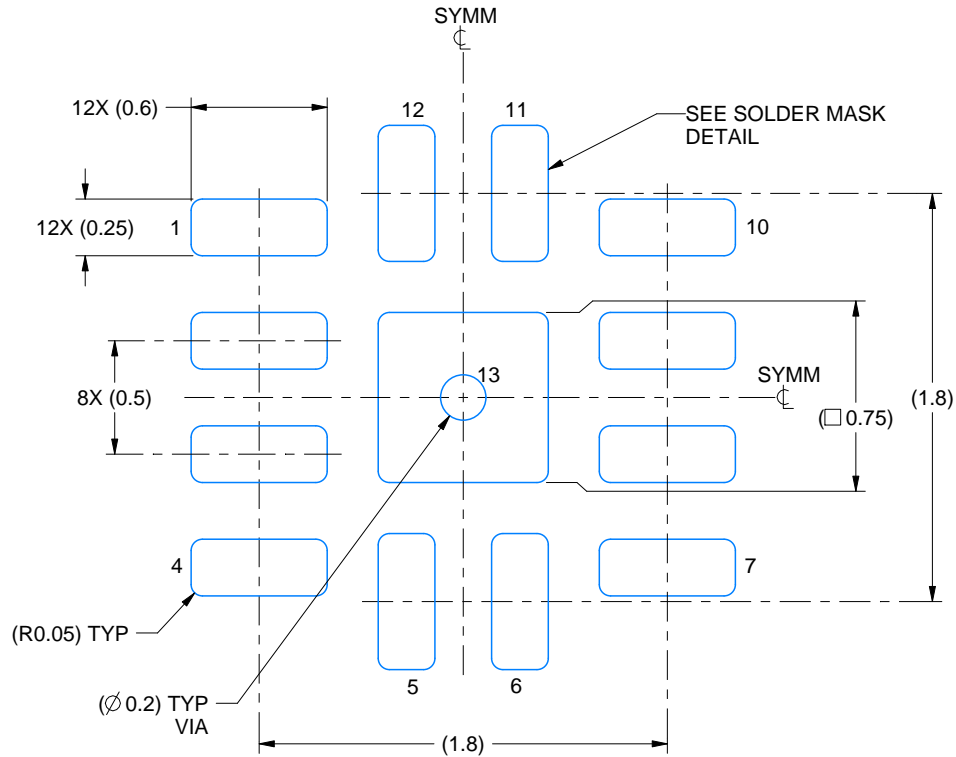

LAND PATTERN EXAMPLE
EXPOSED METAL SHOWN
SCALE: 30X

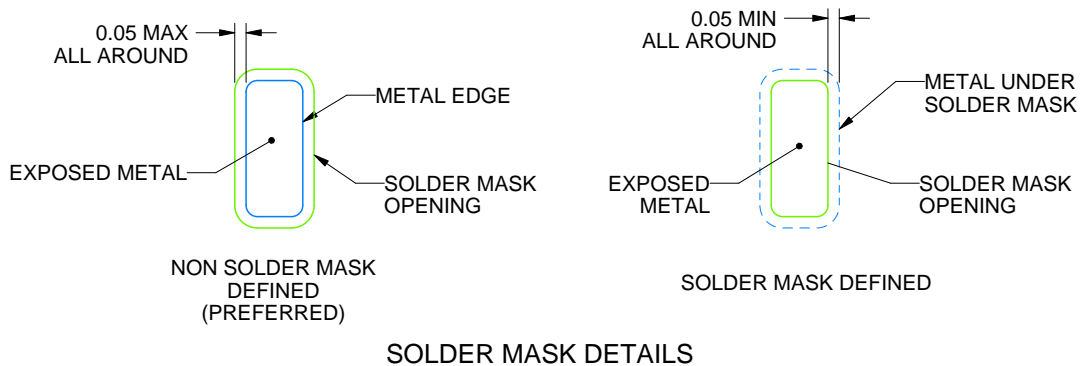

SOLDER MASK DETAILS

4225258/C 08/2025

NOTES: (continued)

- This package is designed to be soldered to a thermal pad on the board. For more information, see Texas Instruments literature number SLUA271 (www.ti.com/lit/slua271).
- Vias are optional depending on application, refer to device data sheet. If any vias are implemented, refer to their locations shown on this view. It is recommended that vias under paste be filled, plugged or tented.

EXAMPLE STENCIL DESIGN

RPV0012A

WQFN-FCRLF - 0.7 mm max height

PLASTIC QUAD FLATPACK - NO LEAD

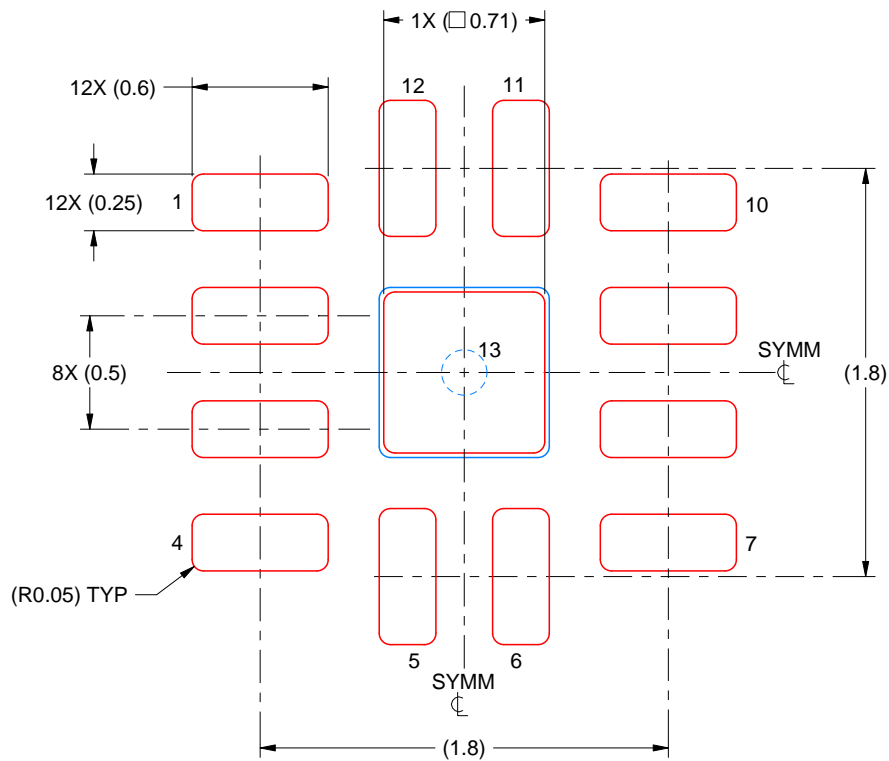

SOLDER PASTE EXAMPLE
BASED ON 0.125 MM THICK STENCIL
SCALE: 30X

EXPOSED PAD 13
90% PRINTED SOLDER COVERAGE BY AREA UNDER PACKAGE

4225258/C 08/2025

NOTES: (continued)

6. Laser cutting apertures with trapezoidal walls and rounded corners may offer better paste release. IPC-7525 may have alternate design recommendations.

IMPORTANT NOTICE AND DISCLAIMER

TI PROVIDES TECHNICAL AND RELIABILITY DATA (INCLUDING DATASHEETS), DESIGN RESOURCES (INCLUDING REFERENCE DESIGNS), APPLICATION OR OTHER DESIGN ADVICE, WEB TOOLS, SAFETY INFORMATION, AND OTHER RESOURCES "AS IS" AND WITH ALL FAULTS, AND DISCLAIMS ALL WARRANTIES, EXPRESS AND IMPLIED, INCLUDING WITHOUT LIMITATION ANY IMPLIED WARRANTIES OF MERCHANTABILITY, FITNESS FOR A PARTICULAR PURPOSE OR NON-INFRINGEMENT OF THIRD PARTY INTELLECTUAL PROPERTY RIGHTS.

These resources are intended for skilled developers designing with TI products. You are solely responsible for (1) selecting the appropriate TI products for your application, (2) designing, validating and testing your application, and (3) ensuring your application meets applicable standards, and any other safety, security, regulatory or other requirements.

These resources are subject to change without notice. TI grants you permission to use these resources only for development of an application that uses the TI products described in the resource. Other reproduction and display of these resources is prohibited. No license is granted to any other TI intellectual property right or to any third party intellectual property right. TI disclaims responsibility for, and you fully indemnify TI and its representatives against any claims, damages, costs, losses, and liabilities arising out of your use of these resources.

TI's products are provided subject to [TI's Terms of Sale](#), [TI's General Quality Guidelines](#), or other applicable terms available either on ti.com or provided in conjunction with such TI products. TI's provision of these resources does not expand or otherwise alter TI's applicable warranties or warranty disclaimers for TI products. Unless TI explicitly designates a product as custom or customer-specified, TI products are standard, catalog, general purpose devices.

TI objects to and rejects any additional or different terms you may propose.

Copyright © 2026, Texas Instruments Incorporated

Last updated 10/2025