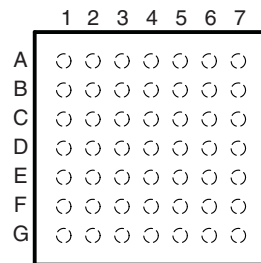
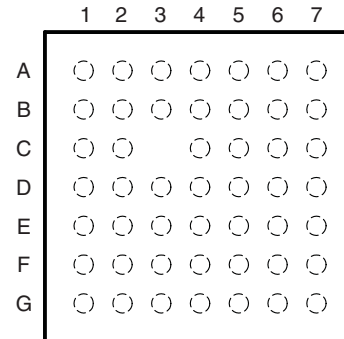

SDIO, UART, AND AUDIO VOLTAGE-TRANSLATION TRANSCEIVER

Check for Samples: [TWL1200](#)

FEATURES

- **Level Translator**
 - V_{CCA} and V_{CCB} Range of 1.1 V to 3.6 V
- **Seamlessly Bridges 1.8-V/2.6-V Digital-Switching Compatibility Gap Between 2.6-V processors and TI's Wi-Link (WL1271 and WL1273)**
- **Latch-Up Performance Exceeds 100 mA Per JESD 78, Class II**
- **ESD Protection Exceeds JESD 22**
 - 2500-V Human-Body Model (A114-B)
 - 250-V Machine Model (A115-A)
 - 1500-V Charged-Device Model (C101)

**YFF PACKAGE
(TOP VIEW)**

**ZQC PACKAGE
(TOP VIEW)**

BGA PACKAGE TERMINAL ASSIGNMENTS

	1	2	3	4	5	6	7
A	SDIO_CLK(A)	SDIO_CMD(A)	AUDIO_CLK(A)	AUD_DIR	AUDIO_CLK(B)	SDIO_CMD(B)	SDIO_CLK(B)
B	SDIO_DATA3(A)	SDIO_DATA0(A)	AUDIO_F-SYN(A)	\overline{OE}	AUDIO_F-SYN(B)	SDIO_DATA0(B)	SDIO_DATA3(B)
C	SDIO_DATA2(A)	SDIO_DATA1(A)		V_{CCA}	V_{CCB}	SDIO_DATA1(B)	SDIO_DATA2(B)
D	WLAN_EN(A)	WLAN_IRQ(A)	GND	V_{CCA}	V_{CCB}	WLAN_EN(B)	WLAN_IRQ(B)
E	CLK_REQ(A)	BT_EN(A)	GND	GND	GND	BT_EN(B)	CLK_REQ(B)
F	BT_UART_CTS(A)	BT_UART_RTS(A)	AUDIO_IN(A)	SLOW_CLK(B)	AUDIO_IN(B)	BT_UART_RTS(B)	BT_UART_CTS(B)
G	BT_UART_RX(A)	BT_UART_TX(A)	AUDIO_OUT(A)	SLOW_CLK(A)	AUDIO_OUT(B)	BT_UART_TX(B)	BT_UART_RX(B)

WCS PACKAGE TERMINAL ASSIGNMENTS

	1	2	3	4	5	6	7
A	SDIO_CLK(A)	SDIO_CMD(A)	AUDIO_CLK(A)	AUD_DIR	AUDIO_CLK(B)	SDIO_CMD(B)	SDIO_CLK(B)
B	SDIO_DATA3(A)	SDIO_DATA0(A)	AUDIO_F-SYN(A)	\overline{OE}	AUDIO_F-SYN(B)	SDIO_DATA0(B)	SDIO_DATA3(B)
C	SDIO_DATA2(A)	SDIO_DATA1(A)	NC ⁽¹⁾	V_{CCA}	V_{CCB}	SDIO_DATA1(B)	SDIO_DATA2(B)
D	WLAN_EN(A)	WLAN_IRQ(A)	GND	V_{CCA}	V_{CCB}	WLAN_EN(B)	WLAN_IRQ(B)
E	CLK_REQ(A)	BT_EN(A)	GND	GND	GND	BT_EN(B)	CLK_REQ(B)
F	BT_UART_CTS(A)	BT_UART_RTS(A)	AUDIO_IN(A)	SLOW_CLK(B)	AUDIO_IN(B)	BT_UART_RTS(B)	BT_UART_CTS(B)
G	BT_UART_RX(A)	BT_UART_TX(A)	AUDIO_OUT(A)	SLOW_CLK(A)	AUDIO_OUT(B)	BT_UART_TX(B)	BT_UART_RX(B)

(1) NC – No internal connection



Please be aware that an important notice concerning availability, standard warranty, and use in critical applications of Texas Instruments semiconductor products and disclaimers thereto appears at the end of this data sheet.

DESCRIPTION/ORDERING INFORMATION

The TWL1200 is an 19-bit voltage translator specifically designed to seamlessly bridge the 1.8-V/2.6-V digital-switching compatibility gap between 2.6-V baseband and the TI Wi-Link-6 (WL1271/3). It is optimized for SDIO, UART, and audio functions. The TWL1200 has two supply-voltage pins, V_{CCA} and V_{CCB} , that can be operated over the full range of 1.1 V to 3.6 V. The TWL1200 enables system designers to easily interface applications processors or digital basebands to peripherals operating at a different I/O voltage levels, such as the TI Wi-Link-6 (WL1271/3) or other SDIO/memory cards.

The TWL1200 is offered in both 48-ball 0.5-mm ball grid array (BGA) and 49-bump 0.4-mm wafer chip scale package (WCSP) packages. Low static power consumption and small package size make the TWL1200 an ideal choice for mobile-phone applications.

ORDERING INFORMATION⁽¹⁾

T_A	PACKAGE ⁽²⁾		ORDERABLE PART NUMBER	TOP-SIDE MARKING
–40°C to 85°C	BGA MicroStar Junior™ – ZQC (Pb-free)	Tape and reel	TWL1200ZQCR	YW200
	WCSP™ – YFF (Pb-free)	Tape and reel	TWL1200YFFR	YW200

- (1) For the most current package and ordering information, see the Package Option Addendum at the end of this document, or see the TI web site at www.ti.com.
 (2) Package drawings, thermal data, and symbolization are available at www.ti.com/packaging.

TERMINAL FUNCTIONS

TERMINAL			TYPE	DESCRIPTION
ZQC BALL NO.	YFF BUMP NO.	NAME		
C4, D4	C4, D4	V_{CCA}	Power	A-side supply voltage (1.1 V to 3.6 V)
B2	B2	SDIO_DATA0(A)	I/O	Data bit 1 connected to baseband SDIO controller
C2	C2	SDIO_DATA1(A)	I/O	Data bit 2 connected to baseband SDIO controller
C1	C1	SDIO_DATA2(A)	I/O	Data bit 3 connected to baseband SDIO controller
B1	B1	SDIO_DATA3(A)	I/O	Data bit 4 connected to baseband SDIO controller
A2	A2	SDIO_CMD(A)	I/O	Command bit connected to baseband SDIO controller. Referenced to V_{CCA} .
A6	A6	SDIO_CMD(B)	I/O	Command bit connected to SD/SDIO peripheral. Includes a 15-k Ω pullup resistor to V_{CCB} .
D3, E3, E4, E5	D3, E3, E4, E5	GND		Ground
B6	B6	SDIO_DATA0(B)	I/O	Data bit 1 connected to SD/SDIO peripheral
C6	C6	SDIO_DATA1(B)	I/O	Data bit 2 connected to SD/SDIO peripheral
C7	C7	SDIO_DATA2(B)	I/O	Data bit 3 connected to SD/SDIO peripheral
B7	B7	SDIO_DATA3(B)	I/O	Data bit 4 connected to SD/SDIO peripheral
A1	A1	SDIO_CLK(A)	I	Clock signal connected to baseband SDIO controller. Referenced to V_{CCA} .
A7	A7	SDIO_CLK(B)	O	Clock signal connected to SD/SDIO peripheral. Referenced to V_{CCB} ; drive strength = 8 mA
C5, D5	C5, D5	V_{CCB}	Pwr	B-side supply voltage (1.1 V to 3.6 V)
C3	C3	–	–	No ball (for ZQC) and No-Connect (for YFF)
B4	B4	\overline{OE}	I	Output enable (active low)
A4	A4	AUD_DIR	I	Direction control signal for AUDIO_CLK and AUDIO_F-SYNC signals
G3	G3	AUDIO_OUT(A)	O	Connected to baseband audio subsystem; drive strength = 4 mA
G5	G5	AUDIO_OUT(B)	I	Connected to Wi-Link-6 PCM subsystem
D1	D1	WLAN_EN(A)	I	Connected to baseband SDIO controller
D6	D6	WLAN_EN(B)	O	Connected to SD/SDIO peripheral; drive strength = 2 mA
G2	G2	BT_UART_TX(A)	O	Connected to baseband UART subsystem; drive strength = 8 mA
G6	G6	BT_UART_TX(B)	I	Connected to BT UART subsystem of Wi-Link-6
D2	D2	WLAN_IRQ(A)	O	Connected to baseband SDIO controller; drive strength = 4 mA

TERMINAL FUNCTIONS (continued)

TERMINAL			TYPE	DESCRIPTION
ZQC BALL NO.	YFF BUMP NO.	NAME		
D7	D7	WLAN_IRQ(B)	I	Connected to SD/SDIO peripheral
G4	G4	SLOW_CLK(A)	I	Low frequency 32-kHz clock connected to baseband device
F4	F4	SLOW_CLK(B)	O	Low frequency 32-kHz clock connected to Wi-Link-6 device; drive strength = 2 mA
G1	G1	BT_UART_RX(A)	I	Connected to baseband UART subsystem
G7	G7	BT_UART_RX(B)	O	Connected to BT UART subsystem of Wi-Link-6; drive strength = 8 mA
E1	E1	CLK_REQ(A)	O	Connected to baseband SDIO controller; drive strength = 4 mA
E7	E7	CLK_REQ(B)	I	Connected to SD/SDIO peripheral
F1	F1	BT_UART_CTS(A)	I	Connected to baseband UART subsystem
F3	F3	AUDIO_IN(A)	I	Connected to baseband audio subsystem
F5	F5	AUDIO_IN(B)	O	Connected to Wi-Link-6 PCM subsystem; drive strength = 4 mA
A3	A3	AUDIO_CLK(A)	I/O	Connected to baseband audio subsystem; drive strength = 4 mA
A5	A5	AUDIO_CLK(B)	I/O	Connected to Wi-Link-6 PCM subsystem; drive strength = 4 mA
E2	E2	BT_EN(A)	I	Connected to baseband UART subsystem
E6	E6	BT_EN(B)	O	Connected to BT UART subsystem of Wi-Link-6; drive strength = 2 mA
F7	F7	BT_UART_CTS(B)	O	Connected to BT UART subsystem of Wi-Link-6; drive strength = 4 mA
F2	F2	BT_UART_RTS(A)	O	Connected to baseband UART subsystem; drive strength = 4 mA
F6	F6	BT_UART_RTS(B)	I	Connected to BT UART subsystem of Wi-Link-6
B3	B3	AUDIO_F-SYN(A)	I/O	Connected to baseband audio subsystem; drive strength = 4 mA
B5	B5	AUDIO_F-SYN(B)	I/O	Connected to Wi-Link-6 PCM subsystem; drive strength = 4 mA

Table 1. FUNCTION TABLE

CONTROL INPUTS		OPERATION
\overline{OE}	AUD_DIR	
H	X	All outputs are Hi-Z
L	H	AUDIO_CLK(A) to AUDIO_CLK(B) and AUDIO_F-SYNC(A) to AUDIO_F-SYNC(B)
L	L	AUDIO_CLK(B) to AUDIO_CLK(A) and AUDIO_F-SYNC(B) to AUDIO_F-SYNC(A)

LOGIC DIAGRAM

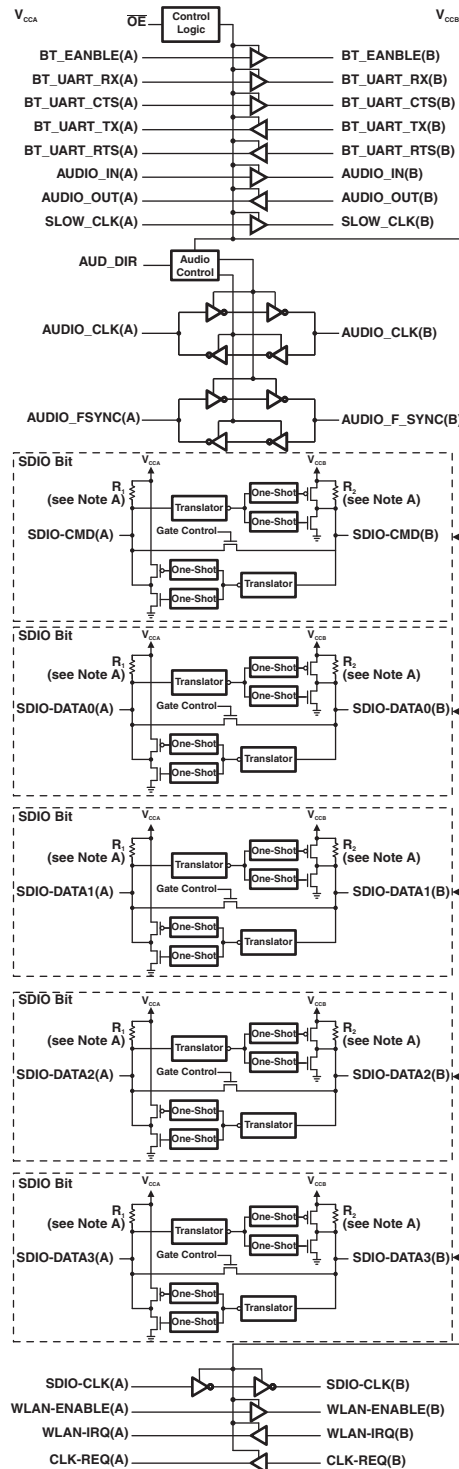

- A. R_1 and R_2 resistor values are determined based upon the logic level applied to the A port or B port as follows:
 R_1 and $R_2 = 25\text{ k}\Omega$ when a logic level low is applied to the A port or B port.
 R_1 and $R_2 = 4\text{ k}\Omega$ when a logic level high is applied to the A port or B port.
 R_1 and $R_2 = 70\text{ k}\Omega$ when the port is deselected (or in High-Z or 3-state).
- B. \overline{OE} controls all output buffers. When $\overline{OE} = \text{high}$, all outputs are Hi-Z.

TYPICAL APPLICATION BLOCK DIAGRAM

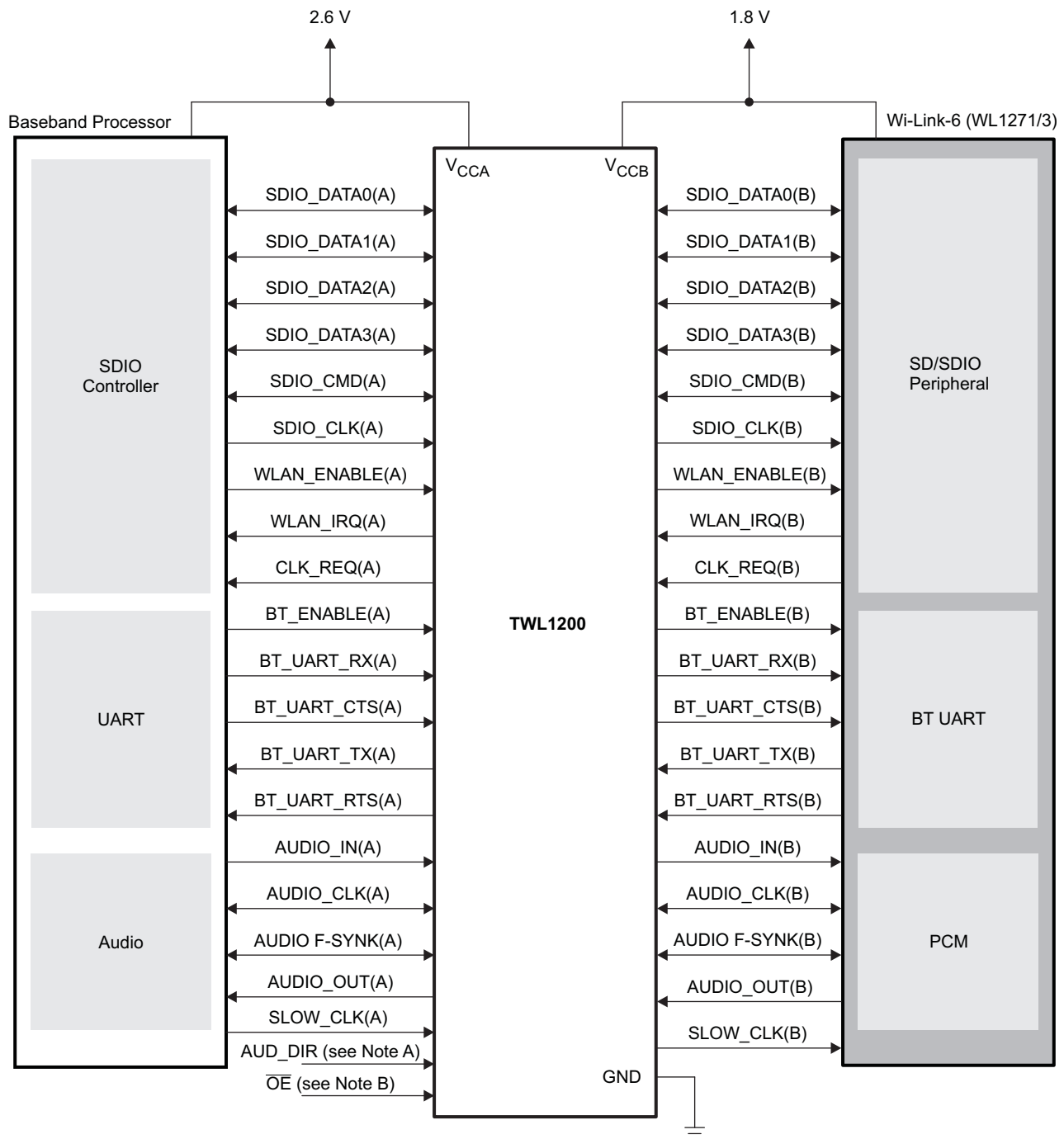

- A. AUD_DIR must be biased to determine audio direction (see Function Table for properly establishing the bias).
- B. \overline{OE} is an active-low pin that must be grounded to 0 V to enable operation of the TWL1200 device.

ABSOLUTE MAXIMUM RATINGS⁽¹⁾

over operating free-air temperature range (unless otherwise noted)

		MIN	MAX	UNIT	
V_{CCA}	Supply voltage range	-0.5	4.6	V	
V_{CCB}	Supply voltage range	-0.5	4.6	V	
V_I	Input voltage range	I/O ports (A port)	-0.5	4.6	V
		I/O ports (B port)	-0.5	4.6	
		Control inputs	-0.5	4.6	
V_O	Voltage range applied to any output in the high-impedance or power-off state ⁽²⁾	A port	-0.5	4.6	V
		B port	-0.5	4.6	
V_O	Voltage range applied to any output in the high or low state ⁽²⁾	A port	-0.5	4.6	V
		B port	-0.5	4.6	
I_{IK}	Input clamp current	$V_I < 0$	-50	mA	
I_{OK}	Output clamp current	$V_O < 0$	-50	mA	
I_O	Continuous output current		±50	mA	
	Continuous current through V_{CCA} , V_{CCB} , or GND		±100	mA	
T_{stg}	Storage temperature range	-65	150	°C	

- (1) Stresses beyond those listed under "absolute maximum ratings" may cause permanent damage to the device. These are stress ratings only, and functional operation of the device at these or any other conditions beyond those indicated under "recommended operating conditions" is not implied. Exposure to absolute-maximum-rated conditions for extended periods may affect device reliability.
- (2) The input and output voltage ratings may be exceeded if the input and output clamp-current ratings are observed.

THERMAL IMPEDANCE RATINGS

			UNIT
θ_{JA}	Package thermal impedance ⁽¹⁾	ZQC package	171.6
		YFF package	75

- (1) The package thermal impedance is calculated in accordance with JESD 51-7.

RECOMMENDED OPERATING CONDITIONS⁽¹⁾

			V_{CCI}	V_{CCO}	MIN	MAX	UNIT
V_{CCA}	Supply voltage				1.1	3.6	V
V_{CCB}	Supply voltage				1.1	3.6	V
V_{IH}	High-level input voltage	Buffer type	1.1 V to 3.6 V	1.1 V to 3.6 V	$V_{CCI} \times 0.65$	3.6	V
		\overline{OE} and AUD_DIR			$V_{CCA} \times 0.65$	3.6	
V_{IH}	High-level input voltage	Switch type	1.1 V to 3.6 V	1.1 V to 3.6 V	$V_{CCI} - 0.2$	V_{CCI}	V
V_{IL}	Low-level input voltage	Buffer type and Control Logic	1.1 V to 3.6 V	1.1 V to 3.6 V	0	$V_{CCI} \times 0.35$	V
		\overline{OE} and AUD_DIR			0	$V_{CCA} \times 0.35$	
$V_{IL}^{(2)}$	Low-level input voltage	Switch type	1.1 V to 3.6 V	1.1 V to 3.6 V	0	0.15	V
V_I	Input voltage				0	3.6	V
V_O	Output voltage	Active state			0	V_{CCO}	V
		3-state			0	3.6	
I_{OH}	High-level output current			1.1 V to 1.3 V		-0.5	mA
				1.4 V to 1.6 V		-1	
				1.65 V to 1.95 V		-2	
				2.3 V to 2.7 V		-4	
				3 V to 3.6 V		-8	
I_{OL}	Low-level output current			1.1 V to 1.3 V		0.5	mA
				1.4 V to 1.6 V		1	
				1.65 V to 1.95 V		2	
				2.3 V to 2.7 V		4	
				3 V to 3.6 V		8	
$\Delta t/\Delta v$	Input transition rise or fall rate					5	ns/V
T_A	Operating free-air temperature				-40	85	°C

(1) All unused data inputs of the device must be held at V_{CCI} or GND to ensure proper device operation. Refer to the TI application report, *Implications of Slow or Floating CMOS Inputs*, literature number SCBA004.

(2) Note, the max V_{IL} value is provided to ensure that a valid V_{OL} is maintained. The V_{OL} value is the V_{IL} + the voltage-drop across the pass-gate transistor.

ELECTRICAL CHARACTERISTICS

over recommended operating free-air temperature range (unless otherwise noted)

PARAMETER		TEST CONDITIONS	V _{CCA}	V _{CCB}	MIN	TYP ⁽¹⁾	MAX	UNIT		
V _{OH}	A port (Buffer-type output, 8-mA drive)	I _{OH} = -100 μA	1.1 V to 3.6 V	1.1 V to 3.6 V	V _{CC0} - 0.2			V		
		I _{OH} = -8 mA	1.65 V	1.65 V	1.2					
			2.5 V	2.5 V	1.97					
	A port (Buffer-type output, 4-mA drive)	I _{OH} = -100 μA	1.1 V to 3.6 V	1.1 V to 3.6 V	V _{CC0} - 0.2					
		I _{OH} = -4 mA	1.65 V	1.65 V	1.2					
			2.5 V	2.5 V	1.97					
V _{OH}	A port (Switch-type outputs)	I _{OH} = -20 μA	1.65 V	1.65 V	1.5			V		
			2.5 V	2.5 V	2.3					
V _{OL}	A port (Buffer-type output, 8-mA drive)	I _{OL} = 100 μA	1.1 V to 3.6 V	1.1 V to 3.6 V			0.2	V		
		I _{OL} = 8 mA	1.65 V	1.65 V			0.45			
			2.5 V	2.5 V			0.55			
	A port (Buffer-type output, 4-mA drive)	I _{OL} = 100 μA	1.1 V to 3.6 V	1.1 V to 3.6 V			0.2			
		I _{OL} = 4 mA	1.65 V	1.65 V			0.45			
			2.5 V	2.5 V			0.55			
V _{OL}	A port (Switch-type outputs)	I _{OL} = 220 μA, V _{IN} = 0.15 V	1.65 V	1.65 V			0.45	V		
		I _{OL} = 300 μA, V _{IN} = 0.15 V	2.5 V	2.5 V			0.55			
V _{OH}	B port (Buffer-type output, 8-mA drive)	I _{OH} = -100 μA	1.1 V to 3.6 V	1.1 V to 3.6 V	V _{CC0} - 0.2			V		
			I _{OH} = -8 mA	1.65 V	1.65 V	1.2				
				2.5 V	2.5 V	1.97				
	B port (Buffer-type output, 4-mA drive)	I _{OH} = -100 μA	I _{OH} = -4 mA	1.1 V to 3.6 V	1.1 V to 3.6 V	V _{CC0} - 0.2				
				1.65 V	1.65 V	1.2				
				2.5 V	2.5 V	1.97				
	B port (Buffer-type output, 2-mA drive)	I _{OH} = -100 μA	I _{OH} = -2 mA	1.1 V to 3.6 V	1.1 V to 3.6 V	V _{CC0} - 0.2				
				1.65 V	1.65 V	1.2				
				2.5 V	2.5 V	1.97				
	B port (Switch-type outputs)	I _{OH} = -20 μA		1.65 V	1.65 V	1.5				
				2.5 V	2.5 V	2.3				
V _{OL}	B port (Buffer-type output, 8-mA drive)	I _{OL} = 100 μA	1.1 V to 3.6 V	1.1 V to 3.6 V			0.2	V		
			I _{OL} = 8 mA	1.65 V	1.65 V				0.45	
				2.5 V	2.5 V				0.55	
	B port (Buffer-type output, 4-mA drive)	I _{OL} = 100 μA	I _{OL} = 4 mA	1.1 V to 3.6 V	1.1 V to 3.6 V				0.2	
				1.65 V	1.65 V				0.45	
				2.5 V	2.5 V				0.55	
	B port (Buffer-type output, 2-mA drive)	I _{OL} = 100 μA	I _{OL} = 2 mA	1.1 V to 3.6 V	1.1 V to 3.6 V				0.2	
				1.65 V	1.65 V				0.45	
				2.5 V	2.5 V				0.55	
	B port (Switch-type outputs)	I _{OL} = 220 μA, V _{IN} = 0.15 V	I _{OL} = 300 μA, V _{IN} = 0.15 V	1.65 V	1.65 V				0.45	
				2.5 V	2.5 V				0.55	
	I _I		V _I = V _{CCA} or GND	1.1 V to 3.6 V	1.1 V to 3.6 V				±1	μA
	I _{CCA}		Switch-type I/O are open and all other inputs are biased at either V _{CC} or GND	1.1 V to 3.6 V	1.1 V to 3.6 V				15	μA
				3.6 V	0 V				14	
0 V				3.6 V			-12			

(1) All typical values are at T_A = 25°C.

ELECTRICAL CHARACTERISTICS (continued)

over recommended operating free-air temperature range (unless otherwise noted)

PARAMETER		TEST CONDITIONS	V _{CCA}	V _{CCB}	MIN	TYP ⁽¹⁾	MAX	UNIT
I _{CCB}		Switch-type I/O are open and all other inputs are biased at either V _{CC} or GND	1.1 V to 3.6 V	1.1 V to 3.6 V			15	μA
			3.6 V	0 V			-12	
			0 V	3.6 V			14	
I _{CCA} + I _{CCB}		V _I = V _{CCI} or GND, I _O = 0	1.1 V to 3.6 V	1.1 V to 3.6 V			30	μA
C _{IO}	Auto-Dir (SDIO lines)	V _I = V _{CCI}					5.5	pF
	Bi-Dir buffer	V _I = V _{CCX} or GND					4.5	
C _I	AUD_DIR / $\overline{\text{OE}}$	V _I = V _{CCA} or GND					4	pF
	Buffer	V _I = V _{CCX} or GND					4	
C _O	2-mA buffer	V _I = V _{CCX} or GND					5	pF
	4-mA buffer	V _I = V _{CCX} or GND					5	
	8-mA buffer	V _I = V _{CCX} or GND					6	

OUTPUT DRIVE STRENGTH

2 mA	4 mA	8 mA
WLAN_EN(B)	AUDIO_OUT(A)	SDIO_CLK(B)
SLOW_CLK(B)	WLAN_IRQ(A)	BT_UART_TX(A)
BT_EN(B)	CLK_REQ(A)	BT_UART_RX(B)
	AUDIO_IN(B)	
	AUDIO_CLK(A)	
	BT_UART_CTS(B)	
	BT_UART_RTS(A)	
	AUDIO_F-SYNC(A)	

TIMING REQUIREMENTS

$V_{CCA} = 2.5 \text{ V} \pm 0.2 \text{ V}$

over recommended operating free-air temperature range (unless otherwise noted)

			$V_{CCB} = 1.8 \text{ V} \pm 0.15 \text{ V}$		UNIT
			MIN	MAX	
Data rate	SDIO_CMD	Push-pull driving	60		Mbps
		Open-drain driving	1		
	SDIO_CLK	Push-pull driving	50		MHz
	SDIO_DATAx		60		Mbps
t_w Pulse duration	SDIO_CMD	Push-pull driving	17		ns
		Open-drain driving	1		μs
	SDIO_CLK	Push-pull driving	10		ns
	SDIO_DATAx		17		ns

TIMING REQUIREMENTS

$V_{CCA} = 3.3 \text{ V} \pm 0.3 \text{ V}$

over recommended operating free-air temperature range (unless otherwise noted)

			$V_{CCB} = 1.8 \text{ V} \pm 0.15 \text{ V}$		UNIT
			MIN	MAX	
Data rate	SDIO_CMD	Push-pull driving	60		Mbps
		Open-drain driving	1		
	SDIO_CLK	Push-pull driving	50		MHz
	SDIO_DATAx		60		Mbps
t_w Pulse duration	SDIO_CMD	Push-pull driving	17		ns
		Open-drain driving	1		μs
	SDIO_CLK	Push-pull driving	10		ns
	SDIO_DATAx		17		ns

SWITCHING CHARACTERISTICS

$V_{CCA} = 2.5 \text{ V} \pm 0.2 \text{ V}$

over recommended operating free-air temperature range (unless otherwise noted)

PARAMETER	FROM (INPUT)	TO (OUTPUT)	TEST CONDITIONS	$V_{CCB} = 1.8 \text{ V} \pm 0.15 \text{ V}$		UNIT
				MIN	MAX	
t_{pd}	SDIO_CMD(A)	SDIO_CMD(B)	Push-pull driving		7	ns
			Open-drain driving (H-to-L)	1.1	7	
			Open-drain driving (L-to-H)	30	510	
	SDIO_CMD(B)	SDIO_CMD(A)	Push-pull driving		7	
			Open-drain driving (H-to-L)	1	7.5	
			Open-drain driving (L-to-H)	30	515	
	SDIO_CLK(A)	SDIO_CLK(B)	Push-pull driving	1	6.5	
	SDIO_DATAx(A)	SDIO_DATAx(B)	Push-pull driving	1	7	
	SDIO_DATAx(B)	SDIO_DATAx(A)		1	7	
		Buffered input	2-mA drive strength output	Push-pull driving	1	
	Buffered input	4-mA drive strength output	Push-pull driving	1	7	
	Buffered input	8-mA drive strength output	Push-pull driving	1	6.5	
t_{en}	OE	2-mA drive strength output	Push-pull driving		16	ns
		4-mA drive strength output	Push-pull driving		19	
		8-mA drive strength output	Push-pull driving		18	
		Switch-type output	Push-pull driving		1	μs
t_{dis}	OE	2-mA drive strength output	Push-pull driving		17	ns
		4-mA drive strength output	Push-pull driving		16.5	
		8-mA drive strength output	Push-pull driving		16	
		Switch-type outputs	Push-pull driving		1	μs
t_{rA}	SDIO_CMD(A) rise time		Push-pull driving	1	5	ns
			Open-drain driving	15	420	
		SDIO_DATAx(A) rise time		Push-pull driving	1	4.7
t_{rB}	SDIO_CMD(B) rise time		Push-pull driving	1	9.7	ns
			Open-drain driving	15	420	
	SDIO_CLK(B) rise time		Push-pull driving	0.5	6	
		SDIO_DATAx(B) rise time		1	9.7	
t_{fA}	SDIO_CMD(A) fall time		Push-pull driving	0.7	8.3	ns
			Open-drain driving	1.6	8.3	
		SDIO_DATAx(A) fall time		1	8.3	
t_{fB}	SDIO_CMD(B) fall time		Push-pull driving	1	9.9	ns
			Open-drain driving	1.6	10.9	
	SDIO_CLK(B) fall time		Push-pull driving	0.5	5.3	
		SDIO_DATAx(B) fall time		1	9.9	
$t_{sk(O)}$	SDIO Ch-A to Ch-B skew		Push-pull driving		0.4	ns
	SDIO Ch-B to Ch-A skew		Push-pull driving		0.4	
	SDIO channel-to-clock skew		Push-pull driving		1.3	
Max data rate	SDIO_CMD		Push-pull driving		60	Mbps
			Open-drain driving		1	
	SDIO_CLK		Push-pull driving		50	MHz
SDIO_DATAx		Push-pull driving		60	Mbps	

SWITCHING CHARACTERISTICS

$V_{CCA} = 3.3 \text{ V} \pm 0.3 \text{ V}$

over recommended operating free-air temperature range (unless otherwise noted)

PARAMETER	FROM (INPUT)	TO (OUTPUT)	TEST CONDITIONS	$V_{CCB} = 1.8 \text{ V} \pm 0.15 \text{ V}$		UNIT
				MIN	MAX	
t_{pd}	SDIO_CMD(A)	SDIO_CMD(B)	Push-pull driving		7	ns
			Open-drain driving (H-to-L)	1.1	7	
			Open-drain driving (L-to-H)	30	510	
	SDIO_CMD(B)	SDIO_CMD(A)	Push-pull driving		7	
			Open-drain driving (H-to-L)	1	7.5	
			Open-drain driving (L-to-H)	30	515	
	SDIO_CLK(A)	SDIO_CLK(B)	Push-pull driving	1	6.5	
	SDIO_DATAx(A)	SDIO_DATAx(B)	Push-pull driving	1	7	
	SDIO_DATAx(B)	SDIO_DATAx(A)		1	7	
	Buffered input	2-mA drive strength output	Push-pull driving	1	7.6	
Buffered input	4-mA drive strength output	Push-pull driving	1	7		
Buffered -nput	8-mA drive strength output	Push-pull driving	1	6.5		
t_{en}	OE	2-mA drive strength output	Push-pull driving		16	ns
		4-mA drive strength output	Push-pull driving		19	
		8-mA drive strength output	Push-pull driving		19	
		Switch-type output	Push-pull driving		1	μs
t_{dis}	OE	2-mA drive strength output	Push-pull driving		17	ns
		4-mA drive strength output	Push-pull driving		16	
		8-mA drive strength output	Push-pull driving		16	
		Switch-type output	Push-pull driving		1	μs
t_{rA}	SDIO_CMD(A) rise time		Push-pull driving	1	4.25	ns
	SDIO_DATAx(A) rise time		Open-drain driving	15	420	
t_{rB}	SDIO_CMD(B) rise time		Push-pull driving	1	9.5	ns
	SDIO_CLK(B) rise time		Open-drain driving	15	420	
	SDIO_DATAx(B) rise time		Push-pull driving	0.5	5.9	
t_{fA}	SDIO_CMD(A) fall time		Push-pull driving	0.7	8.2	ns
	SDIO_DATAx(A) fall time		Open-drain driving	1.6	8.2	
t_{fB}	SDIO_CMD(B) fall time		Push-pull driving	1	9.2	ns
	SDIO_CLK(B) fall time		Open-drain driving	1.6	10.8	
	SDIO_DATAx(B) fall time		Push-pull driving	0.5	5.2	
$t_{sk(O)}$	SDIO Ch-A to Ch-B skew		Push-pull driving		0.4	ns
	SDIO Ch-B to Ch-A skew		Push-pull driving		0.4	
	SDIO Channel-to-Clock skew		Push-pull driving		1.3	
Max data rate	SDIO_CMD		Push-pull driving		60	Mbps
	SDIO_CMD		Open-drain driving		1	
	SDIO_CLK		Push-pull driving		50	MHz
SDIO_DATAx		Push-pull driving		60	Mbps	

OPERATING CHARACTERISTICS
 $T_A = 25^\circ\text{C}$

PARAMETER			TEST CONDITIONS	$V_{CCA} = V_{CCB} = 1.8\text{ V}$	$V_{CCA} = V_{CCB} = 2.5\text{ V}$	UNIT
DATAx and CMD	Enabled	C_{pd} input side	$C_L = 0,$ $f = 10\text{ MHz},$ $t_r = t_f = 1\text{ ns}$	18.3	20.3	pF
		C_{pd} output side		18.25	19.52	
	Disabled	C_{pd} input side		0.8	0.8	
		C_{pd} output side		0.1	0.1	
Clock	Enabled	C_{pd} input side	$C_L = 0,$ $f = 10\text{ MHz},$ $t_r = t_f = 1\text{ ns}$	0.6	0.9	pF
		C_{pd} output side		8.8	10.1	
	Disabled	C_{pd} input side		0.1	0.1	
		C_{pd} output side		0.1	0.1	
2-mA buffer	Enabled	C_{pd} input side	$C_L = 0,$ $f = 10\text{ MHz},$ $t_r = t_f = 1\text{ ns}$	0.6	1.0	pF
		C_{pd} output side		7.1	7.9	
	Disabled	C_{pd} input side		0.1	0.1	
		C_{pd} output side		0.1	0.1	
4-mA buffer	Enabled	C_{pd} input side	$C_L = 0,$ $f = 10\text{ MHz},$ $t_r = t_f = 1\text{ ns}$	0.6	1.0	pF
		C_{pd} output side		7.6	8.6	
	Disabled	C_{pd} input side		0.1	0.1	
		C_{pd} output side		0.1	0.1	
8-mA buffer	Enabled	C_{pd} input side	$C_L = 0,$ $f = 10\text{ MHz},$ $t_r = t_f = 1\text{ ns}$	0.6	1.0	pF
		C_{pd} output side		8.8	10.1	
	Disabled	C_{pd} input side		0.1	0.1	
		C_{pd} output side		0.1	0.1	
4-mA I/O	Enabled	C_{pd} input side	$C_L = 0,$ $f = 10\text{ MHz},$ $t_r = t_f = 1\text{ ns}$	0.6	0.95	pF
		C_{pd} output side		8.2	9.1	
	Disabled	C_{pd} input side		0.1	0.1	
		C_{pd} output side		0.1	0.1	

TYPICAL CHARACTERISTICS

LOW-LEVEL OUTPUT VOLTAGE
vs
LOW-LEVEL OUTPUT CURRENT

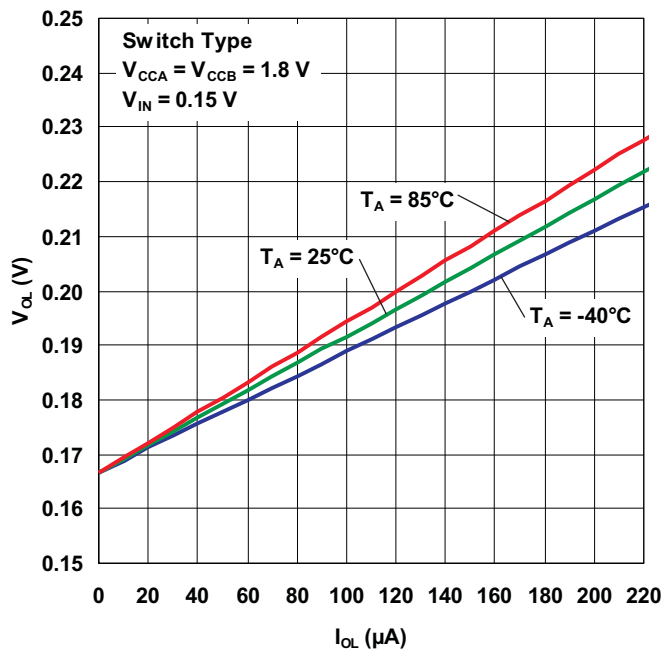

Figure 1.

LOW-LEVEL OUTPUT VOLTAGE
vs
LOW-LEVEL OUTPUT CURRENT

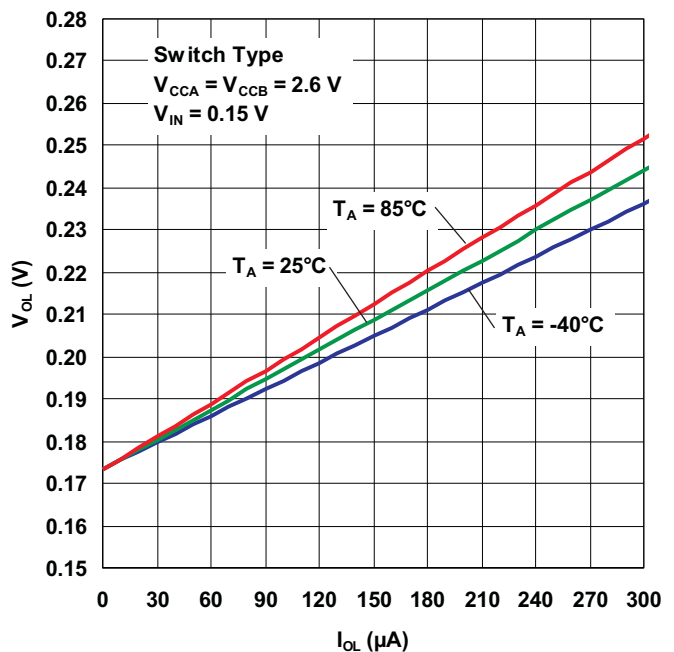

Figure 2.

LOW-LEVEL OUTPUT VOLTAGE
vs
LOW-LEVEL OUTPUT CURRENT

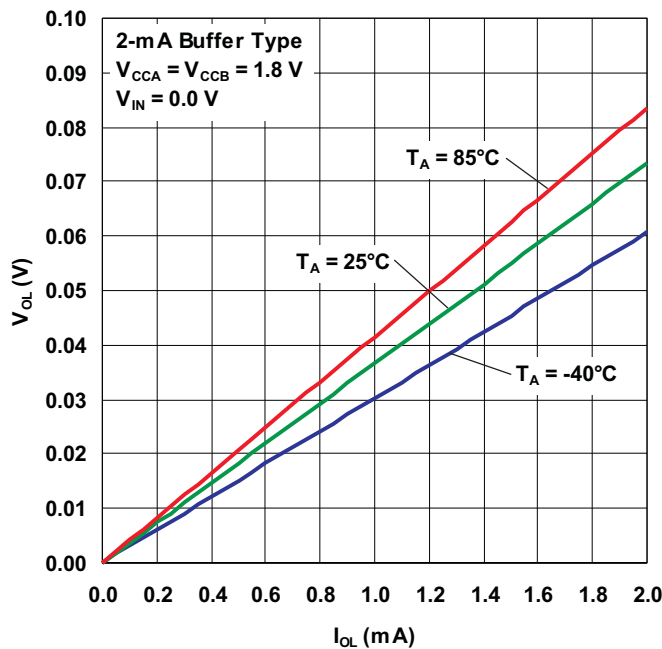

Figure 3.

LOW-LEVEL OUTPUT VOLTAGE
vs
LOW-LEVEL OUTPUT CURRENT

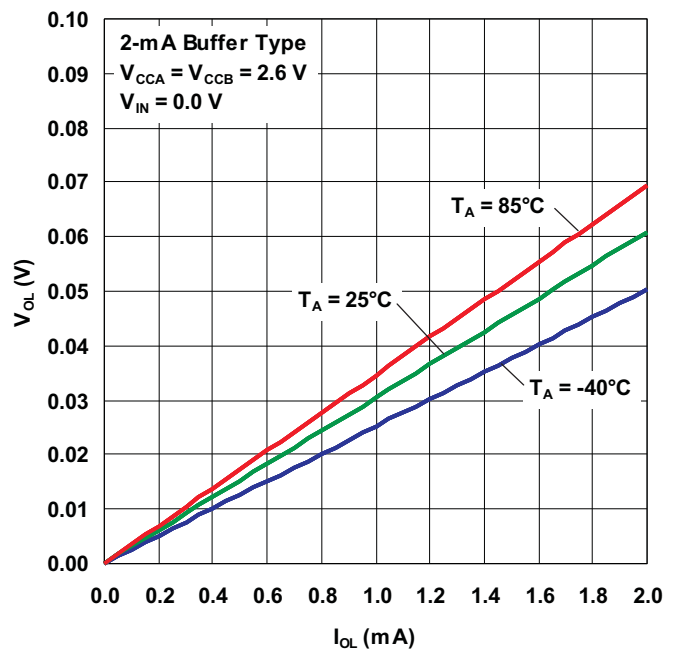

Figure 4.

TYPICAL CHARACTERISTICS (continued)

LOW-LEVEL OUTPUT VOLTAGE
VS
LOW-LEVEL OUTPUT CURRENT

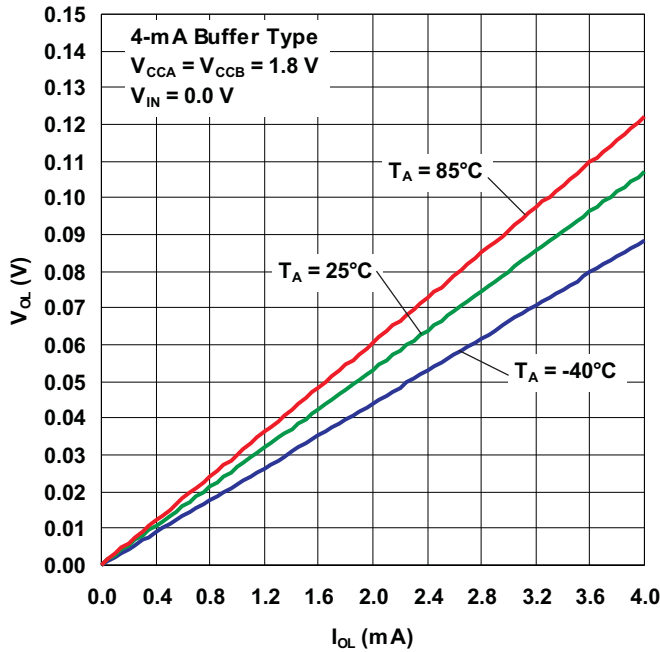

Figure 5.

LOW-LEVEL OUTPUT VOLTAGE
VS
LOW-LEVEL OUTPUT CURRENT

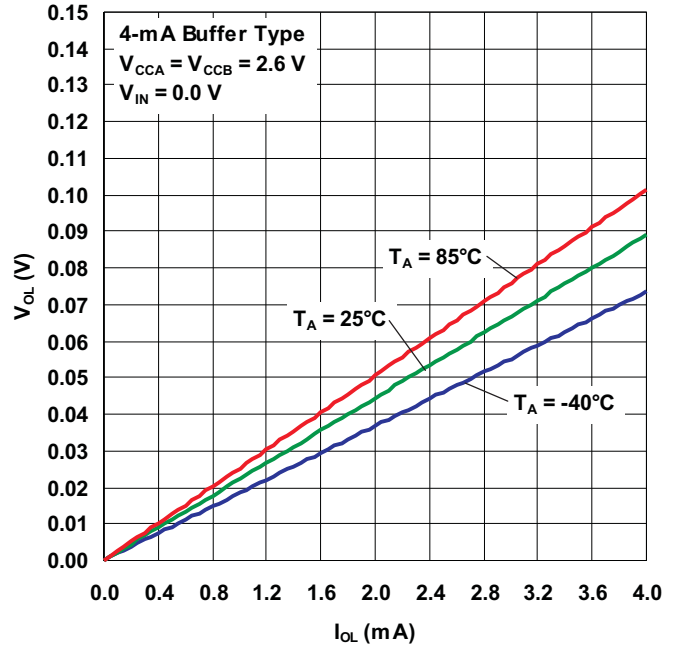

Figure 6.

LOW-LEVEL OUTPUT VOLTAGE
VS
LOW-LEVEL OUTPUT CURRENT

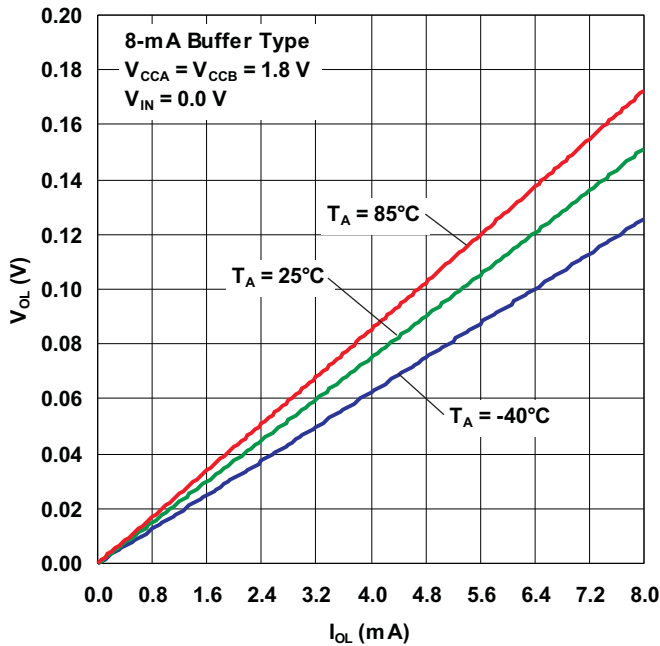

Figure 7.

LOW-LEVEL OUTPUT VOLTAGE
VS
LOW-LEVEL OUTPUT CURRENT

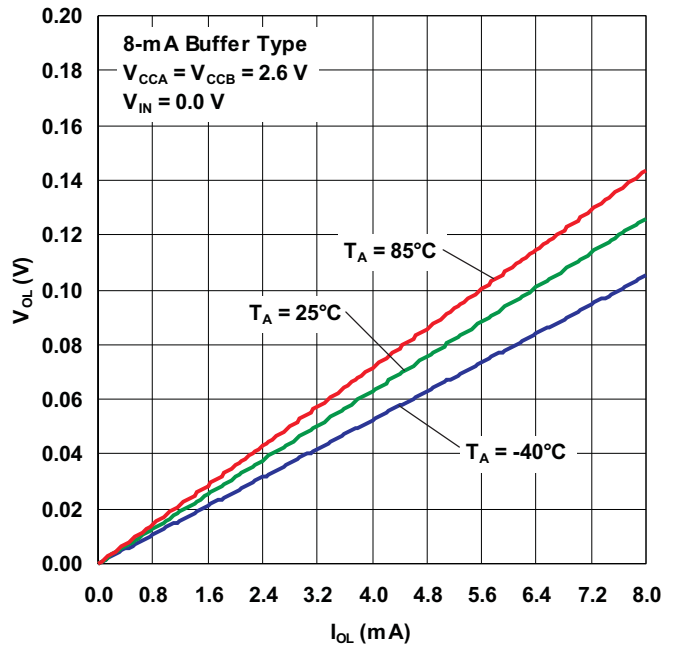

Figure 8.

TYPICAL CHARACTERISTICS (continued)

**HIGH-LEVEL OUTPUT VOLTAGE
vs
HIGH-LEVEL OUTPUT CURRENT**

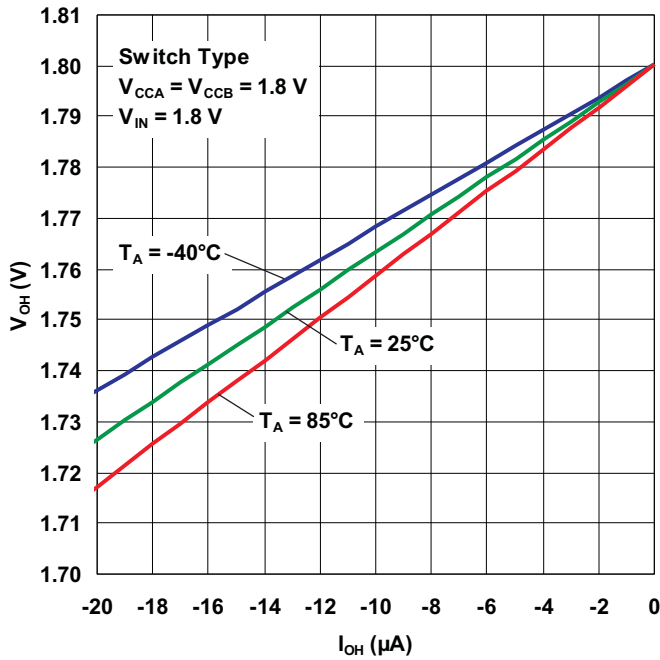

Figure 9.

**HIGH-LEVEL OUTPUT VOLTAGE
vs
HIGH-LEVEL OUTPUT CURRENT**

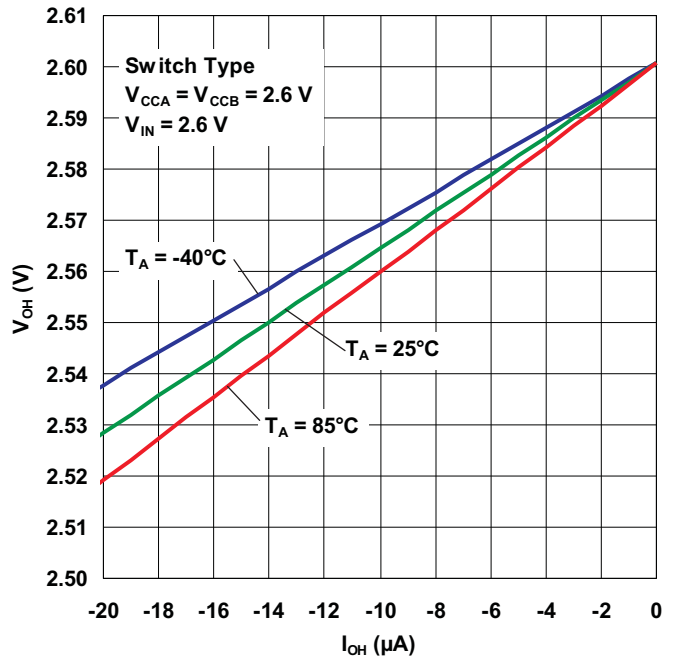

Figure 10.

**HIGH-LEVEL OUTPUT VOLTAGE
vs
HIGH-LEVEL OUTPUT CURRENT**

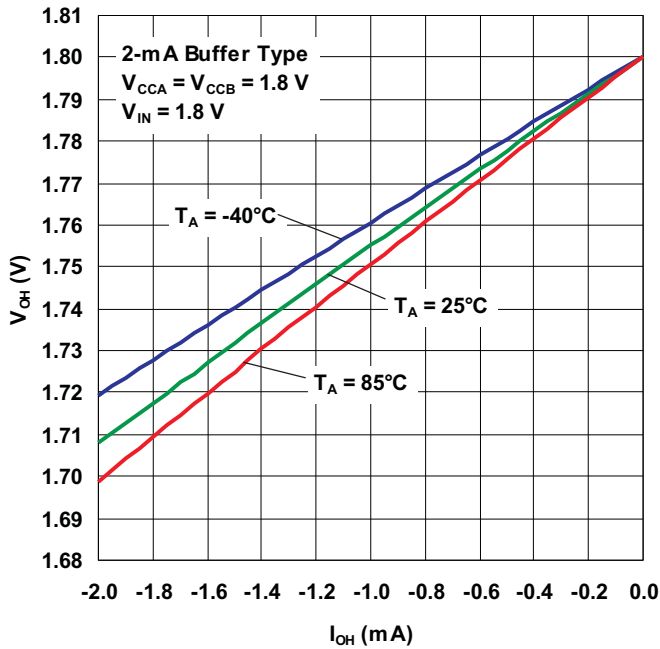

Figure 11.

**HIGH-LEVEL OUTPUT VOLTAGE
vs
HIGH-LEVEL OUTPUT CURRENT**

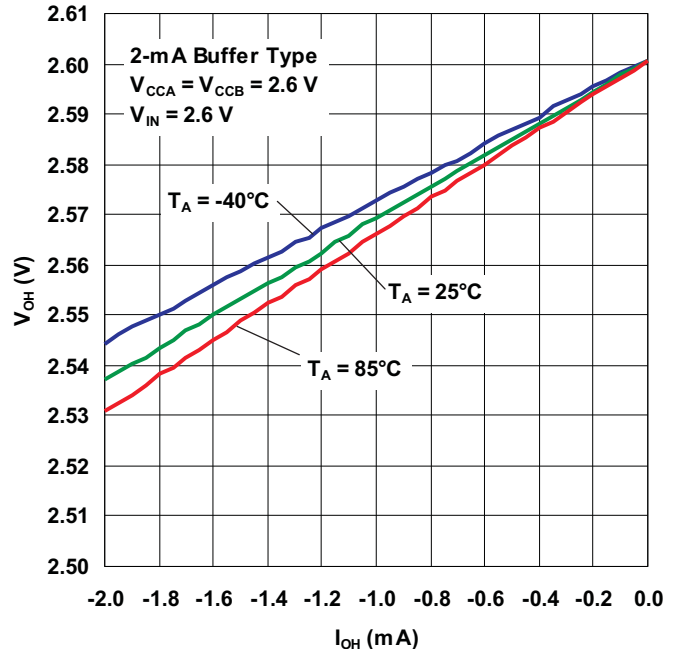

Figure 12.

TYPICAL CHARACTERISTICS (continued)

HIGH-LEVEL OUTPUT VOLTAGE
VS
HIGH-LEVEL OUTPUT CURRENT

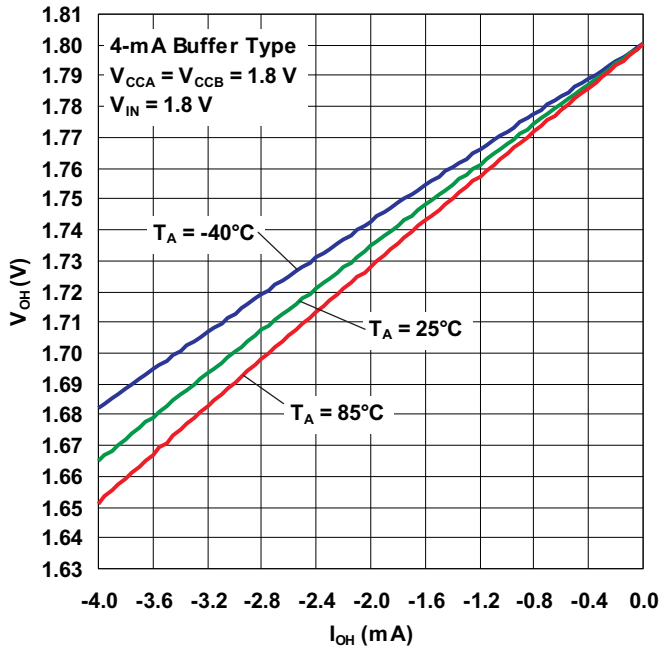

Figure 13.

HIGH-LEVEL OUTPUT VOLTAGE
VS
HIGH-LEVEL OUTPUT CURRENT

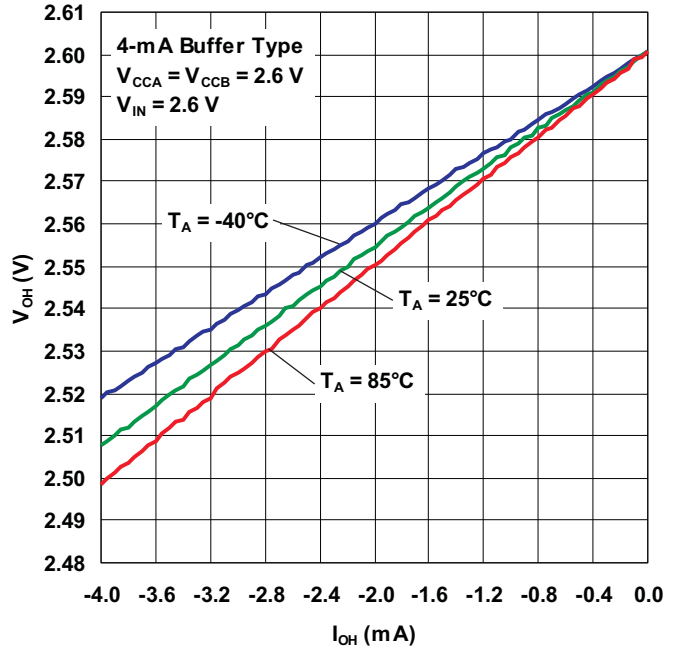

Figure 14.

HIGH-LEVEL OUTPUT VOLTAGE
VS
HIGH-LEVEL OUTPUT CURRENT

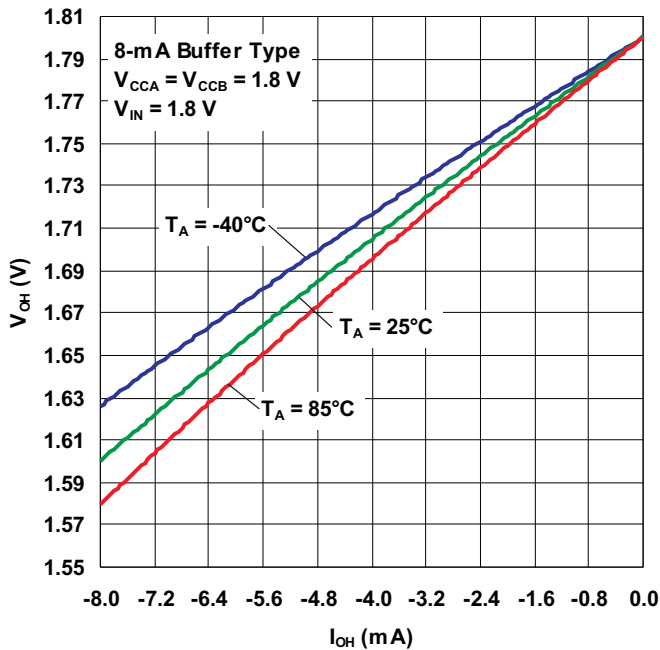

Figure 15.

HIGH-LEVEL OUTPUT VOLTAGE
VS
HIGH-LEVEL OUTPUT CURRENT

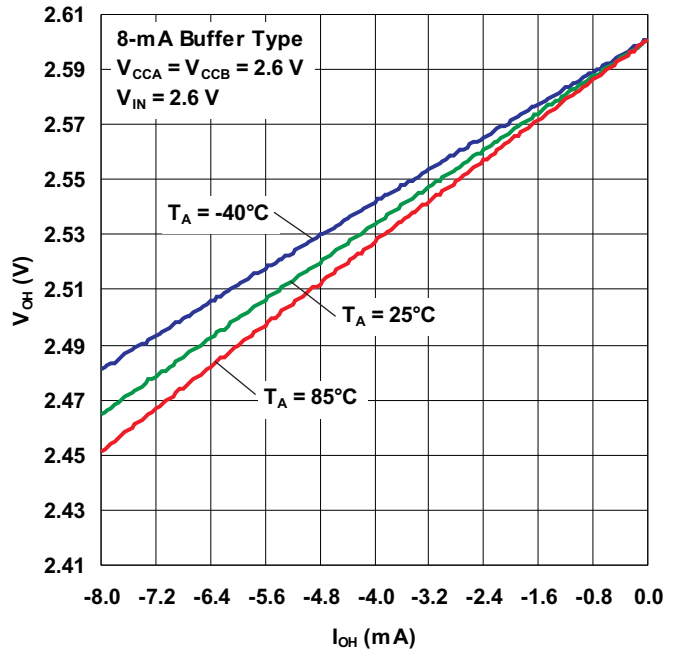

Figure 16.

TYPICAL CHARACTERISTICS (continued)

**PROPAGATION DELAY TIME (HIGH TO LOW)
VS
LOAD CAPACITANCE**

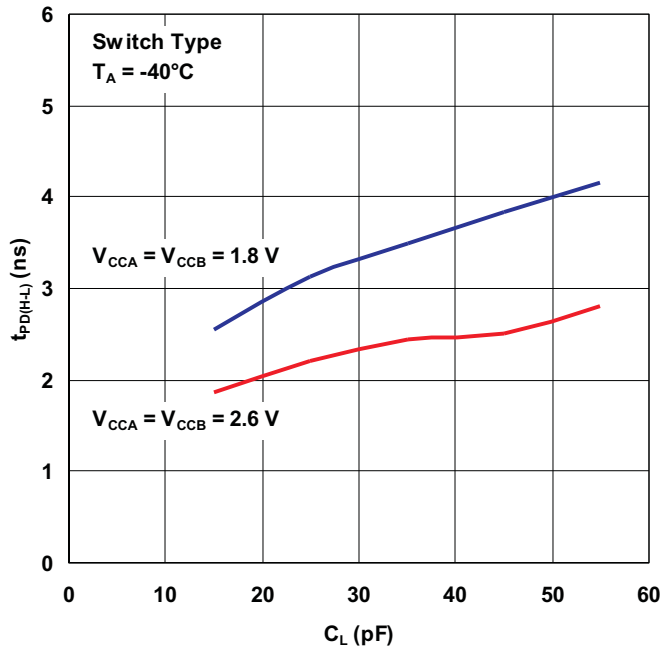

Figure 17.

**PROPAGATION DELAY TIME (LOW TO HIGH)
VS
LOAD CAPACITANCE**

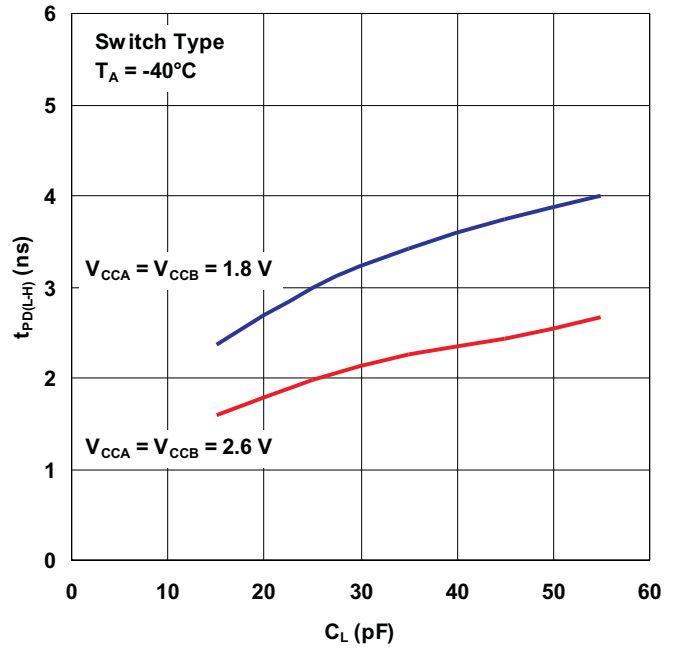

Figure 18.

**PROPAGATION DELAY TIME (HIGH TO LOW)
VS
LOAD CAPACITANCE**

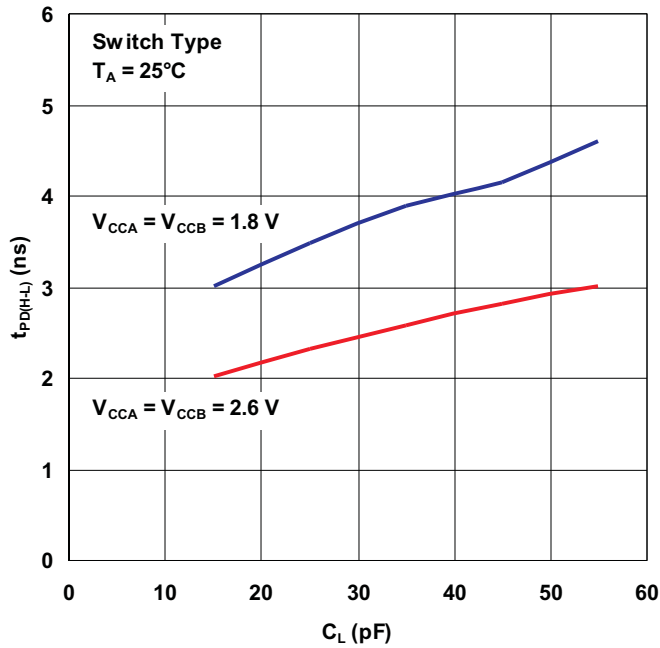

Figure 19.

**PROPAGATION DELAY TIME (LOW TO HIGH)
VS
LOAD CAPACITANCE**

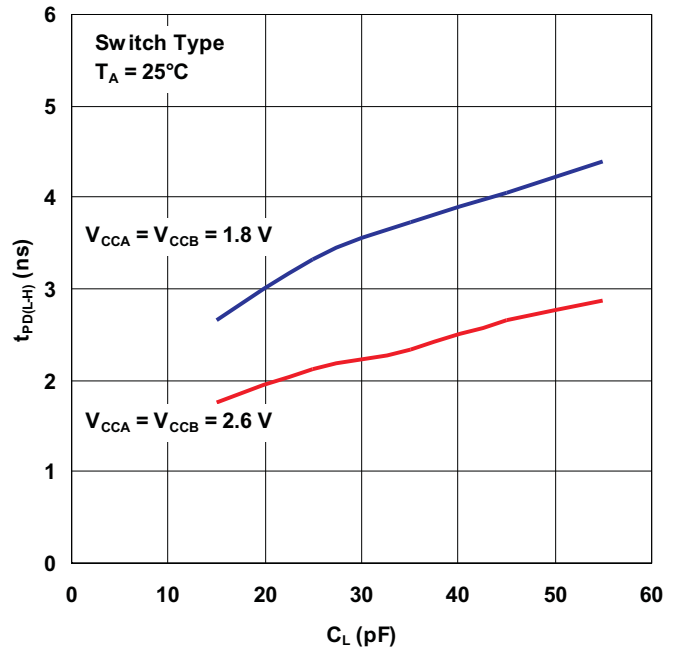

Figure 20.

TYPICAL CHARACTERISTICS (continued)

PROPAGATION DELAY TIME (HIGH TO LOW)
VS
LOAD CAPACITANCE

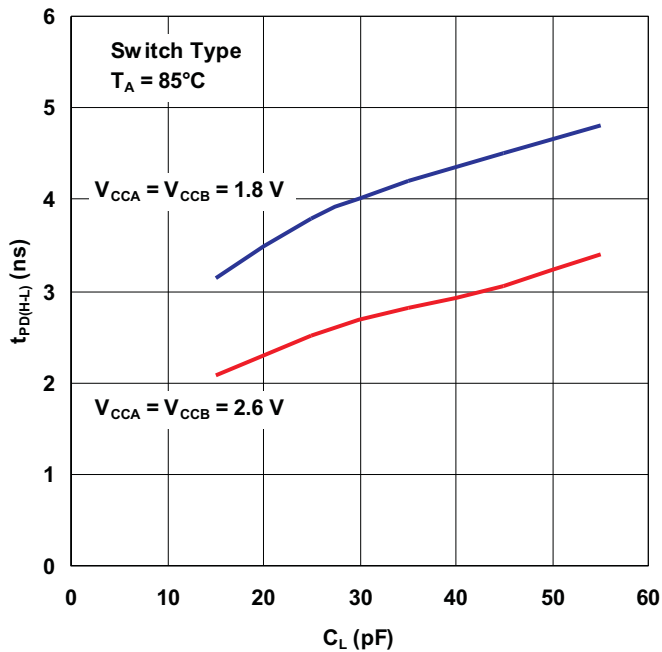

Figure 21.

PROPAGATION DELAY TIME (LOW TO HIGH)
VS
LOAD CAPACITANCE

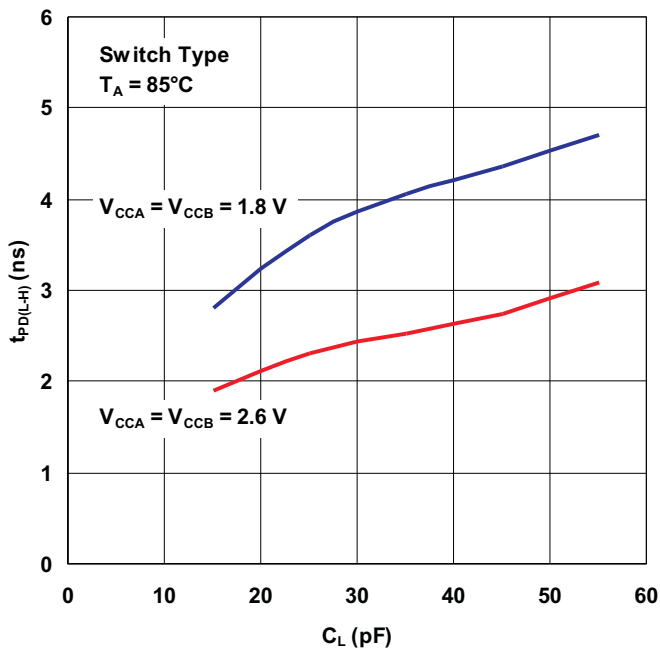

Figure 22.

Typical Application Wiring for TWL1200 When Connecting to the WL1271

Table 2. WL1271+TWL1200 Interface

HOST (MSM)	PIN NAME	BALL NO.	TYPE		TYPE	BALL NO.	PIN NAME	WL1271 COB
	VCCA	C4	Power (3.0 V)	TWL1200	Power (1.8 V)	C5	VCCB	
	VCCA	D4	Power (3.0 V)		Power (1.8 V)	D5	VCCB	
	SDIO_DATA0(A)	B2	I/O ↔		I/O ↔	B6	SDIO_DATA0(B)	K4
	SDIO_DATA1(A)	C2	I/O ↔		I/O ↔	C6	SDIO_DATA1(B)	J4
	SDIO_DATA2(A)	C1	I/O ↔		I/O ↔	C7	SDIO_DATA2(B)	J3
	SDIO_DATA3(A)	B1	I/O ↔		I/O ↔	B7	SDIO_DATA3(B)	J5
	SDIO_CMD(A)	A2	I/O ↔		I/O ↔	A6	SDIO_CMD(B)	L3
	SDIO_CLK(A)	A1	I →		O →	A7	SDIO_CLK(B)	M3
	WLAN_EN(A)	D1	I →		O →	D6	WLAN_EN(B)	J2
	WLAN_IRQ(A)	D2	O ←		I ←	D7	WLAN_IRQ(B)	G4
	CLK_REQ(A)	E1	O ←		I ←	E7	CLK_REQ(B)	F5
	BT_EN(A)	E2	I →		O →	E6	BT_EN(B)	G5
	BT_UART_RX(A)	G1	I →		O →	G7	BT_UART_RX(B)	G7
	BT_UART_CTS(A)	F1	I →		O →	F7	BT_UART_CTS(B)	E11
	BT_UART_TX(A)	G2	O ←		I ←	G6	BT_UART_TX(B)	G8
	BT_UART_RTS(A)	F2	O ←		I ←	F6	BT_UART_RTS(B)	G11
	AUDIO_IN(A)	F3	I →		I/O ↔	F5	AUDIO_IN(B)	F6
	AUDIO_CLK(A)	A3	I/O ↔		I/O ↔	A5	AUDIO_CLK(B)	F8
	AUDIO_F-SYN(A)	B3	I/O ↔		I/O ↔	B5	AUDIO_F-SYN(B)	H11
	AUDIO_OUT(A)	G3	O ←		I ←	G5	AUDIO_OUT(B)	F7
	SLOW_CLK(A)	G4	I →		O →	F4	SLOW_CLK(B)	K9
	AUD_DIR	A4	I →		GND	D3	GND	
	\overline{OE}	B4	active low			E3	GND	
						E4	GND	
						E5	GND	

PARAMETER MEASUREMENT INFORMATION

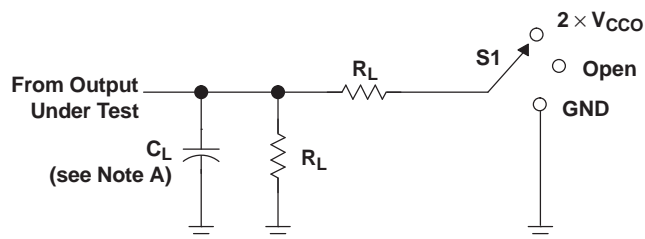

LOAD CIRCUIT FOR BUFFER-TYPE OUTPUTS

V_{CCO}	C_L	R_L	V_{TP}
$1.8\text{ V} \pm 0.15\text{ V}$	15 pF	2 k Ω	0.15 V
$2.5\text{ V} \pm 0.2\text{ V}$	15 pF	2 k Ω	0.15 V
$3.3\text{ V} \pm 0.3\text{ V}$	15 pF	2 k Ω	0.3 V

TEST	S1
t_{pd}	Open
t_{PLZ}/t_{PZL}	$2 \times V_{CCO}$
t_{PHZ}/t_{PZH}	GND

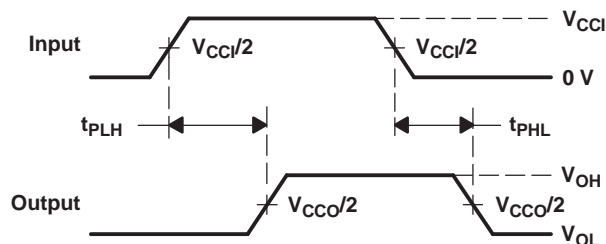
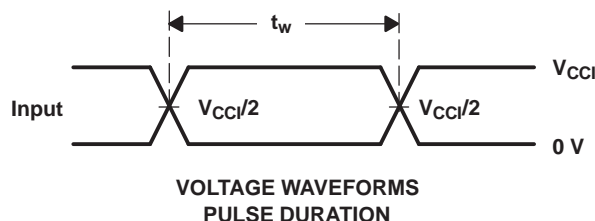

VOLTAGE WAVEFORMS PROPAGATION DELAY TIMES

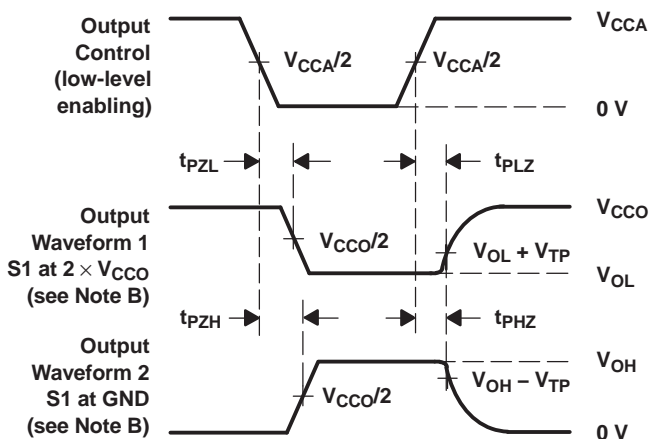

VOLTAGE WAVEFORMS ENABLE AND DISABLE TIMES

- NOTES:
- A. C_L includes probe and jig capacitance.
 - B. Waveform 1 is for an output with internal conditions such that the output is low, except when disabled by the output control. Waveform 2 is for an output with internal conditions such that the output is high, except when disabled by the output control.
 - C. All input pulses are supplied by generators having the following characteristics: $PRR \leq 10\text{ MHz}$, $Z_O = 50\ \Omega$, $dv/dt \geq 1\text{ V/ns}$.
 - D. The outputs are measured one at a time, with one transition per measurement.
 - E. t_{PLZ} and t_{PHZ} are the same as t_{dis} .
 - F. t_{PZL} and t_{PZH} are the same as t_{en} .
 - G. t_{PLH} and t_{PHL} are the same as t_{pd} .
 - H. V_{CC1} is the V_{CC} associated with the input port.
 - I. V_{CCO} is the V_{CC} associated with the output port.

Figure 23. Push-Pull Buffered Direction Control Load Circuit and Voltage Waveform

PARAMETER MEASUREMENT INFORMATION (continued)

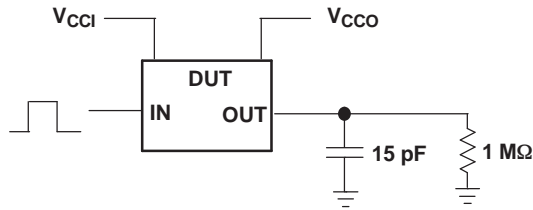

DATA RATE, PULSE DURATION, PROPAGATION DELAY, OUTPUT RISE AND FALL TIME MEASUREMENT USING A PUSH-PULL DRIVER

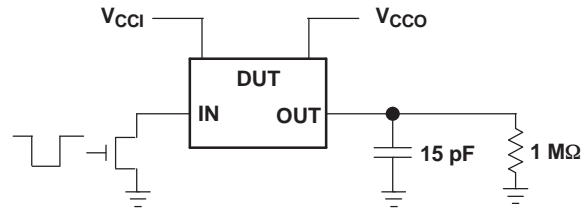

DATA RATE, PULSE DURATION, PROPAGATION DELAY, OUTPUT RISE AND FALL TIME MEASUREMENT USING AN OPEN-DRAIN DRIVER

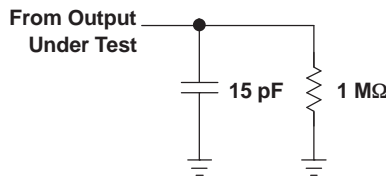

LOAD CIRCUIT FOR ENABLE/DISABLE TIME MEASUREMENT – SWITCH-TYPE SDIOS

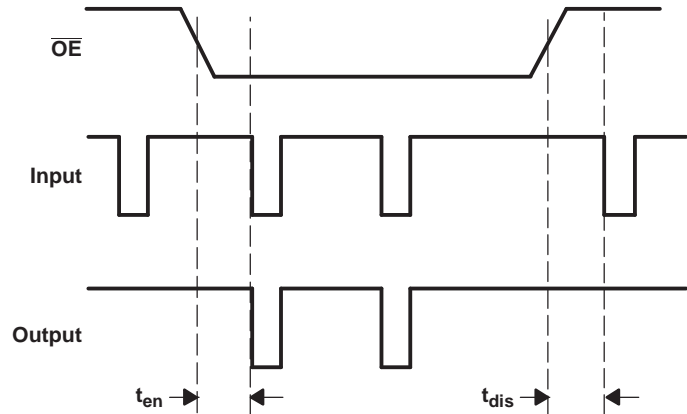
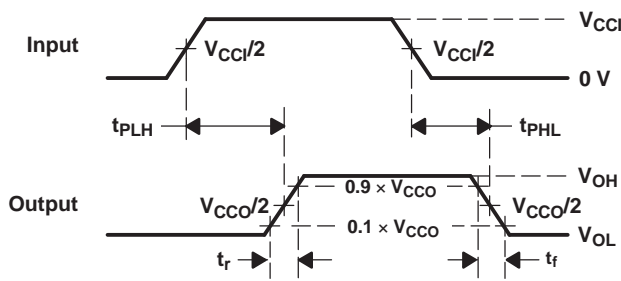
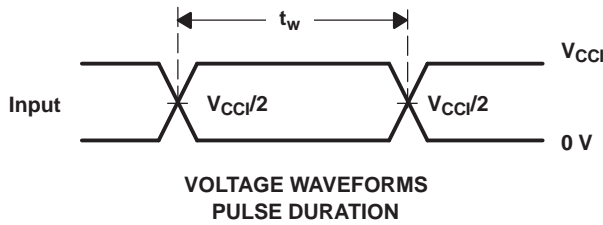

- A. C_L includes probe and jig capacitance.
- B. Waveform 1 is for an output with internal conditions such that the output is low, except when disabled by the output control. Waveform 2 is for an output with internal conditions such that the output is high, except when disabled by the output control.
- C. All input pulses are supplied by generators having the following characteristics: $PRR \leq 10 \text{ MHz}$, $Z_O = 50 \Omega$, $dv/dt \geq 1 \text{ V/ns}$.
- D. The outputs are measured one at a time, with one transition per measurement.
- E. t_{PLZ} and t_{PHZ} are the same as t_{dis} .
- F. t_{PZL} and t_{PZH} are the same as t_{en} .
- G. t_{PLH} and t_{PHL} are the same as t_{pd} .
- H. V_{CCI} is the V_{CC} associated with the input port.
- I. V_{CCO} is the V_{CC} associated with the output port.
- J. All parameters and waveforms are not applicable to all devices.

Figure 24. Auto-Direction Control Load Circuit and Voltage Waveform

APPLICATION CIRCUIT EXAMPLES

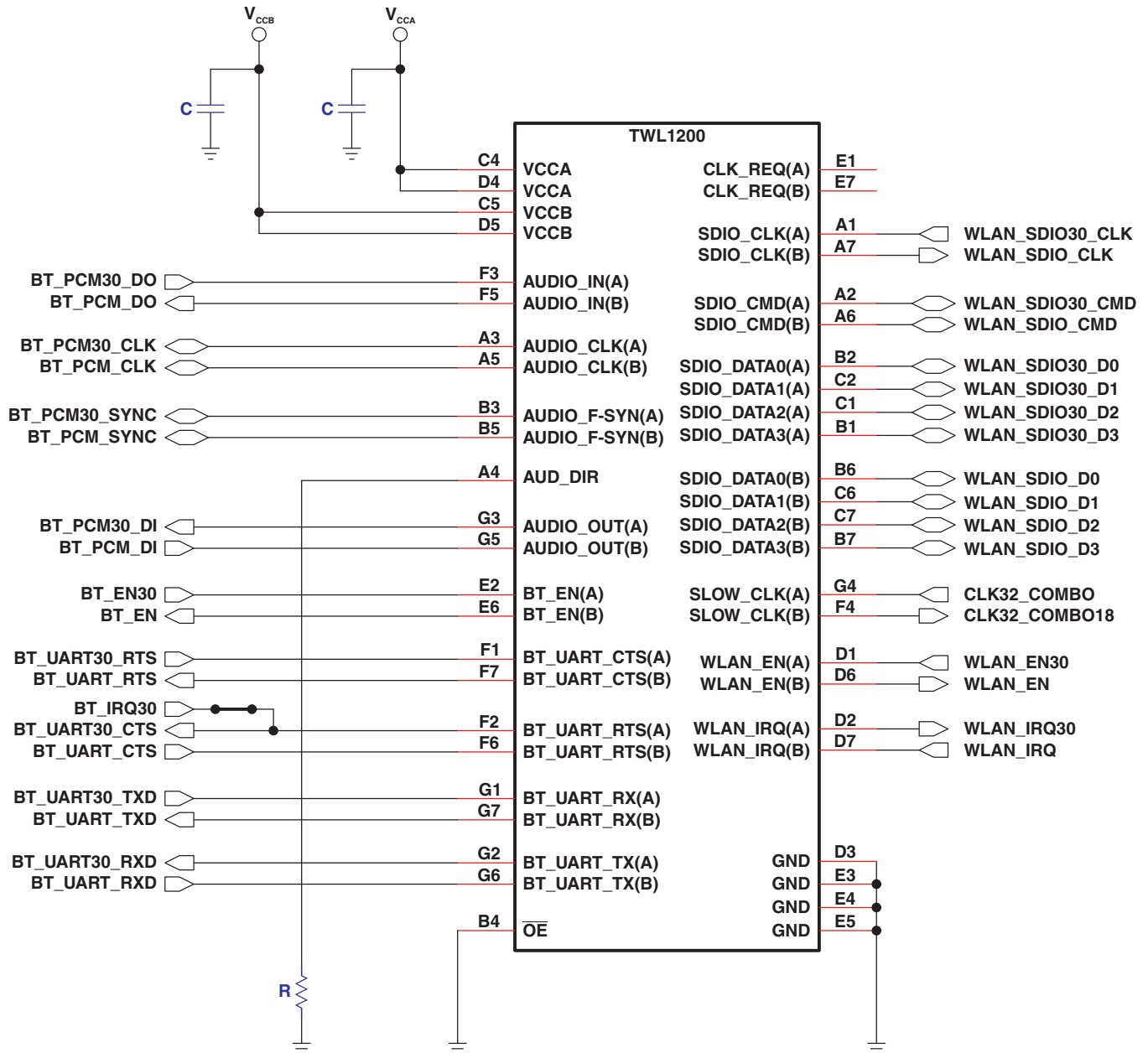

Figure 25. Application Circuit Example, \overline{OE} Connection With Audio_CLK and Audio_F-SYNC Channels Established From B Side to A Side

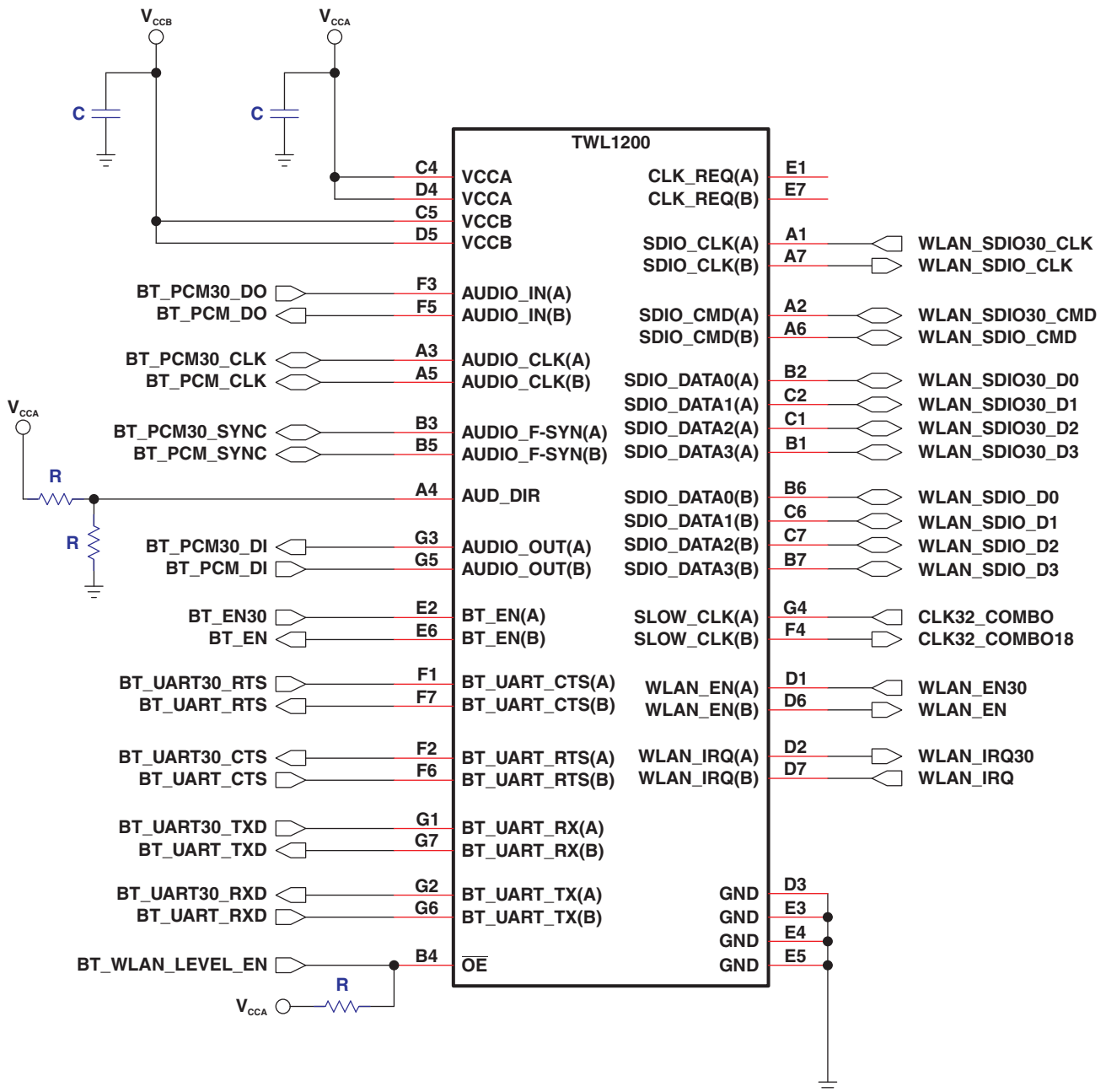

Figure 26. Application Circuit Example, With Voltage Divider for AUD_DIR Connection

PRINCIPLES OF OPERATION

Applications

The TWL1200 device has been designed to bridge the digital-switching compatibility gap between two voltage nodes to successfully interface logic threshold levels between a host processor and the Texas Instruments Wi-Link-6 WLAN/BT/FM products. It is intended to be used in a point-to-point topology when interfacing these devices that may or may not be operating at different interface voltages.

Architecture

The BT/UART and PCM/Audio subsystem interfaces consist of a fully-buffered voltage translator design that has its output transistors to source and sink current optimized for drive strength.

The SDIO lines comprise a semi-buffered auto-direction-sensing based translator architecture (see Figure 27) that does not require a direction-control signal to control the direction of data flow of the A to B ports (or from B to A ports).

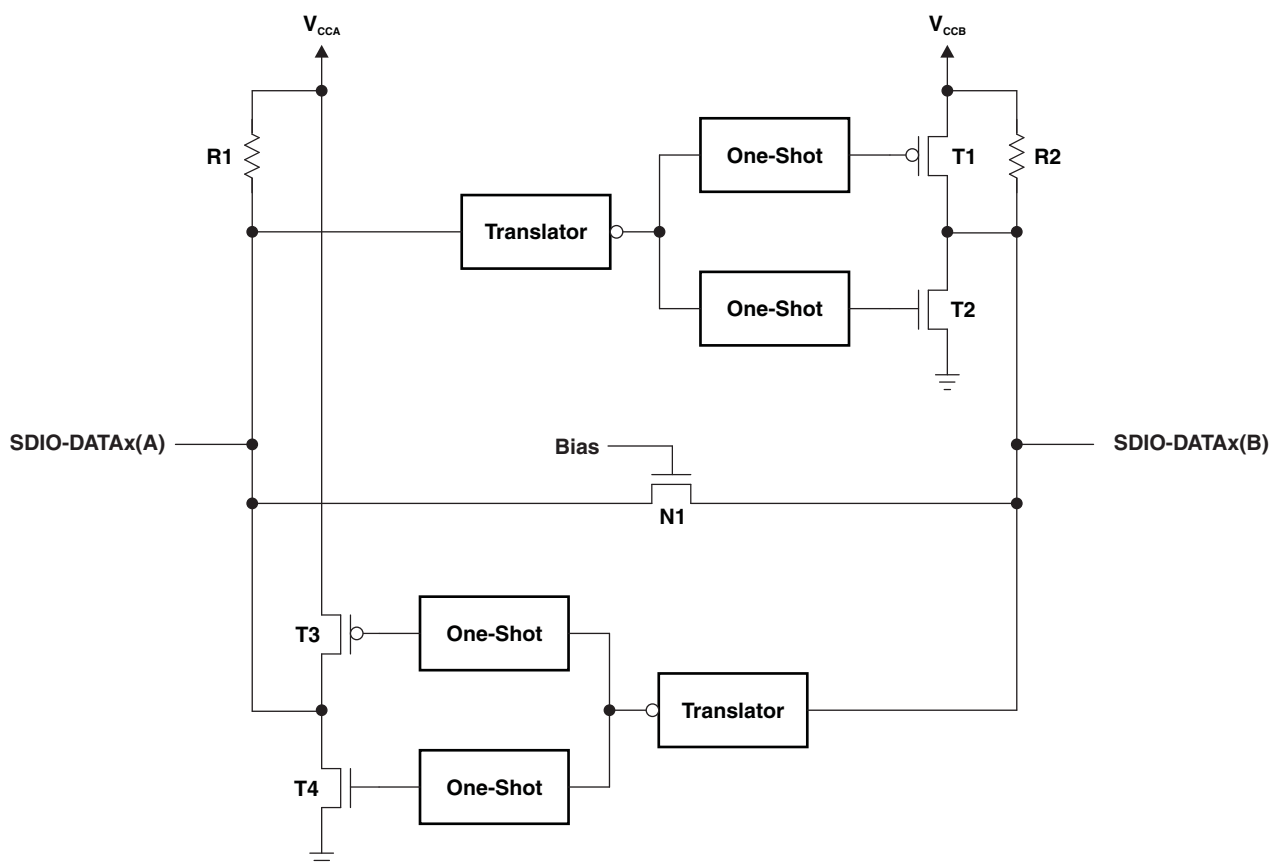

Figure 27. Architecture of an SDIO Switch-Type Cell

Each of these bidirectional SDIO channels independently determines the direction of data flow without a direction-control signal. Each I/O pin can be automatically reconfigured as either an input or an output, which is how this auto-direction feature is realized.

The following two key circuits are employed to facilitate the "switch-type" voltage translation function:

1. Integrated pullup resistors to provide dc-bias and drive capabilities
2. An N-channel pass-gate transistor topology (with a high R_{ON} of $\sim 300 \Omega$) that ties the A-port to the B-port
3. Output one-shot (O.S.) edge-rate accelerator circuitry to detect and accelerate rising edges on the A or B ports

For bidirectional voltage translation, pullup resistors are included on the device for dc current sourcing capability. The V_{GATE} gate bias of the N-channel pass transistor is set at a level that optimizes the switch characteristics for maximum data rate as well as minimal static supply leakage. Data can flow in either direction without guidance from a control signal.

The edge-rate acceleration circuitry speeds up the output slew rate by monitoring the input edge for transitions, helping maintain the data rate through the device.

During a low-to-high signal rising-edge, the O.S. circuits turn on the PMOS transistors (T_1, T_3) and its associated driver output resistance of the driver is decreased to approximately $50\ \Omega$ to $70\ \Omega$ during this acceleration phase to increase the current drive capability of the driver for approximately 30 ns or 95% of the input edge, whichever occurs first. This edge-rate acceleration provides high ac drive by bypassing the internal pullup resistors during the low-to-high transition to speed up the rising-edge signal.

During a high-to-low signal falling-edge, the O.S. circuits turn on the NMOS transistors (T_2, T_4) and its associated driver output resistance of the driver is decreased to approximately $50\ \Omega$ to $70\ \Omega$ during this acceleration phase to increase the current drive capability of the driver for approximately 30 ns or 95% of the input edge, whichever occurs first.

To minimize dynamic I_{CC} and the possibility of signal contention, the user should wait for the O.S. circuit to turn-off before applying a signal in the opposite direction. The worst-case duration is equal to the minimum pulse-width number provided in the *Timing Requirements* section of this data sheet.

Once the O.S. is triggered and switched off, both the A and B ports must go to the same state (i.e. both High or both Low) for the one-shot to trigger again. In a DC state, the output drivers maintain a Low state through the pass transistor. The output drivers maintain a High through the "smart pullup resistors" that dynamically change value based on whether a Low or a High is being passed through the SDIO lines, as follows:

- R_{PU1} and R_{PU2} values are $25\ k\Omega$ when the output is driving a low
- R_{PU1} and R_{PU2} values are $4\ k\Omega$ when the output is driving a high
- R_{PU1} and R_{PU2} values are $70\ k\Omega$ when the device is disabled via the \overline{OE} pin or by pulling the either V_{CCA} or V_{CCB} to 0 V.

The reason for using these "smart" pullup resistors is to allow the TWL1200 to realize a lower static power consumption (when the I/Os are low), support lower V_{OL} values for the same size pass-gate transistor, and improved simultaneous switching performance.

Input Driver Requirements

The continuous dc-current "sinking" capability is determined by the external system-level driver interfaced to the SDIO pins. Since the high bandwidth of these bidirectional SDIO circuits necessitates the need for a port to quickly change from an input to an output (and vice-versa), they have a modest dc-current "sourcing" capability of hundreds of micro-Amps, as determined by the smart pullup resistor values.

The fall time (t_{fA}, t_{fB}) of a signal depends on the edge rate and output impedance of the external device driving the SDIO I/Os, as well as the capacitive loading on these lines.

Similarly, the t_{pd} and max data rates also depend on the output impedance of the external driver. The values for t_{fA}, t_{fB}, t_{pd} , and maximum data rates in the data sheet assume that the output impedance of the external driver is less than $50\ \Omega$.

Output Load Considerations

TI recommends careful PCB layout practices with short PCB trace lengths to avoid excessive capacitive loading and to ensure that proper O.S. triggering takes place. PCB signal trace-lengths should be kept short enough such that the round trip delay of any reflection is less than the one-shot duration. This improves signal integrity by ensuring that any reflection sees a low impedance at the driver. The O.S. circuits have been designed to stay on for approximately 30 ns. The maximum capacitance of the lumped load that can be driven also depends directly on the one-shot duration. With very heavy capacitive loads, the one-shot can time-out before the signal is driven fully to the positive rail. The O.S. duration has been set to best optimize trade-offs between dynamic I_{CC} , load driving capability, and maximum bit-rate considerations. Both PCB trace length and connectors add to the capacitance that the TWL1200 SDIO output sees, so it is recommended that this lumped-load capacitance be considered and kept below $75\ pF$ to avoid O.S. retriggering, bus contention, output signal oscillations, or other adverse system-level affects.

Package Dimensions

The dimensions for the YFF package are shown in [Table 3](#). See the package drawing at the end of this data sheet.

Table 3. YFF Package Dimensions

Packaged Device	D	E
TWL1200YFFR	2.76 ± 0.03 mm	2.76 ± 0.03 mm

PACKAGING INFORMATION

Orderable part number	Status (1)	Material type (2)	Package Pins	Package qty Carrier	RoHS (3)	Lead finish/ Ball material (4)	MSL rating/ Peak reflow (5)	Op temp (°C)	Part marking (6)
TWL1200YFFR	Active	Production	DSBGA (YFF) 49	3000 LARGE T&R	Yes	SNAGCU	Level-1-260C-UNLIM	-40 to 85	YW200
TWL1200YFFR.B	Active	Production	DSBGA (YFF) 49	3000 LARGE T&R	Yes	SNAGCU	Level-1-260C-UNLIM	-40 to 85	YW200

(1) **Status:** For more details on status, see our [product life cycle](#).

(2) **Material type:** When designated, preproduction parts are prototypes/experimental devices, and are not yet approved or released for full production. Testing and final process, including without limitation quality assurance, reliability performance testing, and/or process qualification, may not yet be complete, and this item is subject to further changes or possible discontinuation. If available for ordering, purchases will be subject to an additional waiver at checkout, and are intended for early internal evaluation purposes only. These items are sold without warranties of any kind.

(3) **RoHS values:** Yes, No, RoHS Exempt. See the [TI RoHS Statement](#) for additional information and value definition.

(4) **Lead finish/Ball material:** Parts may have multiple material finish options. Finish options are separated by a vertical ruled line. Lead finish/Ball material values may wrap to two lines if the finish value exceeds the maximum column width.

(5) **MSL rating/Peak reflow:** The moisture sensitivity level ratings and peak solder (reflow) temperatures. In the event that a part has multiple moisture sensitivity ratings, only the lowest level per JEDEC standards is shown. Refer to the shipping label for the actual reflow temperature that will be used to mount the part to the printed circuit board.

(6) **Part marking:** There may be an additional marking, which relates to the logo, the lot trace code information, or the environmental category of the part.

Multiple part markings will be inside parentheses. Only one part marking contained in parentheses and separated by a "~" will appear on a part. If a line is indented then it is a continuation of the previous line and the two combined represent the entire part marking for that device.

Important Information and Disclaimer:The information provided on this page represents TI's knowledge and belief as of the date that it is provided. TI bases its knowledge and belief on information provided by third parties, and makes no representation or warranty as to the accuracy of such information. Efforts are underway to better integrate information from third parties. TI has taken and continues to take reasonable steps to provide representative and accurate information but may not have conducted destructive testing or chemical analysis on incoming materials and chemicals. TI and TI suppliers consider certain information to be proprietary, and thus CAS numbers and other limited information may not be available for release.

In no event shall TI's liability arising out of such information exceed the total purchase price of the TI part(s) at issue in this document sold by TI to Customer on an annual basis.

OTHER QUALIFIED VERSIONS OF TWL1200 :

- Automotive : [TWL1200-Q1](#)

NOTE: Qualified Version Definitions:

- Automotive - Q100 devices qualified for high-reliability automotive applications targeting zero defects

TAPE AND REEL INFORMATION

QUADRANT ASSIGNMENTS FOR PIN 1 ORIENTATION IN TAPE

*All dimensions are nominal

Device	Package Type	Package Drawing	Pins	SPQ	Reel Diameter (mm)	Reel Width W1 (mm)	A0 (mm)	B0 (mm)	K0 (mm)	P1 (mm)	W (mm)	Pin1 Quadrant
TWL1200YFFR	DSBGA	YFF	49	3000	180.0	8.4	2.93	2.93	0.81	4.0	8.0	Q1

TAPE AND REEL BOX DIMENSIONS



*All dimensions are nominal

Device	Package Type	Package Drawing	Pins	SPQ	Length (mm)	Width (mm)	Height (mm)
TWL1200YFFR	DSBGA	YFF	49	3000	182.0	182.0	20.0

MECHANICAL DATA

YFF (R-XBGA-N49)

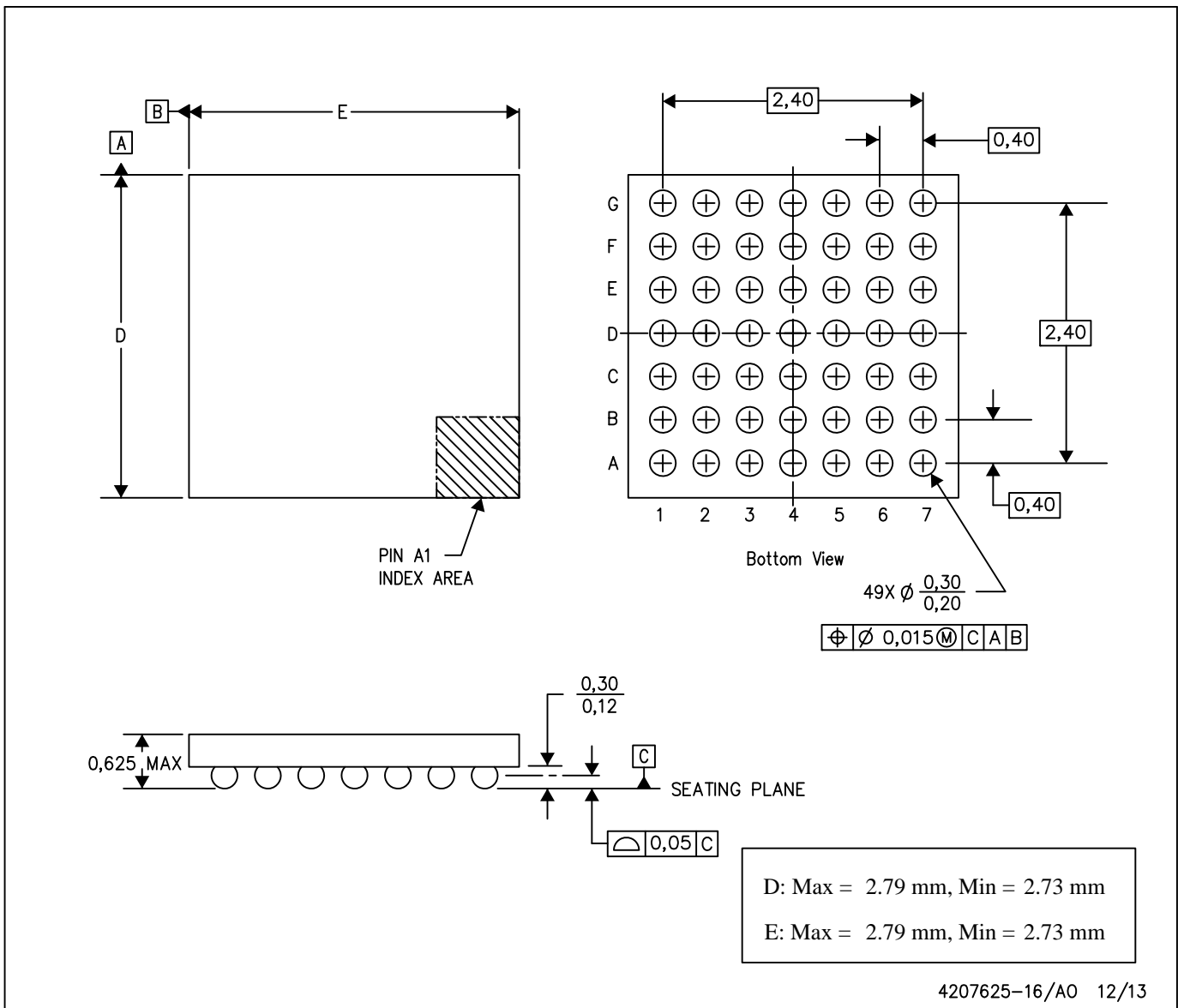
DIE-SIZE BALL GRID ARRAY



- NOTES: A. All linear dimensions are in millimeters. Dimensioning and tolerancing per ASME Y14.5M-1994.
B. This drawing is subject to change without notice.
C. NanoFree™ package configuration.

NanoFree is a trademark of Texas Instruments.

IMPORTANT NOTICE AND DISCLAIMER

TI PROVIDES TECHNICAL AND RELIABILITY DATA (INCLUDING DATASHEETS), DESIGN RESOURCES (INCLUDING REFERENCE DESIGNS), APPLICATION OR OTHER DESIGN ADVICE, WEB TOOLS, SAFETY INFORMATION, AND OTHER RESOURCES "AS IS" AND WITH ALL FAULTS, AND DISCLAIMS ALL WARRANTIES, EXPRESS AND IMPLIED, INCLUDING WITHOUT LIMITATION ANY IMPLIED WARRANTIES OF MERCHANTABILITY, FITNESS FOR A PARTICULAR PURPOSE OR NON-INFRINGEMENT OF THIRD PARTY INTELLECTUAL PROPERTY RIGHTS.

These resources are intended for skilled developers designing with TI products. You are solely responsible for (1) selecting the appropriate TI products for your application, (2) designing, validating and testing your application, and (3) ensuring your application meets applicable standards, and any other safety, security, regulatory or other requirements.

These resources are subject to change without notice. TI grants you permission to use these resources only for development of an application that uses the TI products described in the resource. Other reproduction and display of these resources is prohibited. No license is granted to any other TI intellectual property right or to any third party intellectual property right. TI disclaims responsibility for, and you fully indemnify TI and its representatives against any claims, damages, costs, losses, and liabilities arising out of your use of these resources.

TI's products are provided subject to [TI's Terms of Sale](#), [TI's General Quality Guidelines](#), or other applicable terms available either on [ti.com](#) or provided in conjunction with such TI products. TI's provision of these resources does not expand or otherwise alter TI's applicable warranties or warranty disclaimers for TI products. Unless TI explicitly designates a product as custom or customer-specified, TI products are standard, catalog, general purpose devices.

TI objects to and rejects any additional or different terms you may propose.

Copyright © 2025, Texas Instruments Incorporated

Last updated 10/2025