

bq27520EVM With System-Side, Single-Cell Impedance Track™ Technology

This evaluation module (EVM) is a complete evaluation system for the bq27520. The EVM includes one bq27520 circuit module, a current sense resistor, and one thermistor. An EV2300 board is required to interface this EVM with the PC and can be purchased separately. The circuit module includes one bq27520 integrated circuit and all other onboard components necessary to monitor and predict capacity for a system-side fuel gauge solution. The circuit module connects directly across the battery pack. With the EV2300 interface board and software, the user can read the bq27520 data registers, program the chipset for different pack configurations, log cycling data for further evaluation, and evaluate the overall functionality of the bq27520 solution under different charge and discharge conditions. The latest Microsoft® Windows® based PC software can be downloaded from the product folder on the Texas Instruments Web site.

Contents

1	Features.....	2
2	bq27520-Based Circuit Module	2
3	Circuit Module Physical Layouts, Bill of Materials, and Schematic	3
4	EVM Hardware and Software Setup	7
5	Troubleshooting Unexpected Dialog Boxes	7
6	Hardware Connection	8
7	Operation	9
8	Calibration	12
9	Advanced Communication I ² C	14
10	bqStudio™ Software	16
11	Related Documentation From Texas Instruments	17

List of Figures

1	bq27520EVM-001 Layout – Silk Screen.....	3
2	Top Assembly	4
3	Top Layer	4
4	Bottom Layer	5
5	Schematic.....	6
6	bq27520 Circuit Module Connection to Cell and System Load/Charger	8
7	Registers Screen	9
8	bqStudio Default Page	10
9	Data Memory Screen	11
10	Calibration Window	12
11	Advanced Communication I ² C.....	14
12	Parameter Q&A Screen	15
13	Golden Image Output Screen	15
14	Perform Programming Screen.....	15
15	bqStudio Flowchart.....	17

List of Tables

Impedance Track, bqStudio are trademarks of Texas Instruments.
Microsoft, Windows are registered trademarks of Microsoft Corporation.

1	Ordering Information	2
2	Bill of Materials	5
3	Performance Specification Summary	7
4	Circuit Module to EV2300 Connections	8

1 Features

- Complete evaluation system for the bq27520 gas gauge with Impedance Track technology
- Populated circuit module for quick setup
- Personal computer (PC) software and interface board for easy evaluation
- Software that allows data logging for system analysis
- Ability to upgrade to the latest firmware version by flash reprogramming

1.1 Kit Contents

- bq27520 circuit module (HPA568)
- NTC103AT thermistor

This EVM is used for the evaluation of different bq27520-based products. Ensure that you visit the product Web folder at www.ti.com to download the latest firmware version, evaluation software, and documentation for the associated product to be evaluated.

1.2 Ordering Information

Table 1. Ordering Information

EVM PART NUMBER	CHEMISTRY	CONFIGURATION	CAPACITY
bq27520EVM	Li-ion	1 cell	Any

2 bq27520-Based Circuit Module

The bq27520-based circuit module is a complete and compact example solution of a bq27520 circuit for battery management. The circuit module incorporates a bq27520 battery gas gauge integrated circuit (IC) and all other components necessary to accurately predict the capacity of 1-series Li-ion cell.

2.1 Circuit Module Connections

Contacts on the circuit module provide the following connections:

- Direct connection to the battery pack (J2 or J3): PACK+, PACK–, and TS
- To the serial communications port (J8): SDA, SCL, and VSS
- The system load and charger connect across charger and load (J6 and J7): CHARGER–/LOAD– and CHARGER+/LOAD+.
- Access to signal outputs (J5): SOC_INT, BAT_GD, and BAT_LOW

2.2 Pin Descriptions

PIN NAME	DESCRIPTION
PACK+	Pack positive terminal
PACK–	Pack negative terminal
TS	Pack thermistor input that leads to IC TS pin
SDA	I ² C communication data line
SCL	I ² C communication clock line
VSS	Signal return for communication line, shared with charger and ground

PIN NAME	DESCRIPTION
CHG+/LOAD+	High potential of load or charger connection
CHG-/LOAD-	Low potential of load or charger connection (system VSS)
BAT_GD	Access to push-pull output that indicates that pack is ready to be connected to system
BAT_LOW	Access to push-pull output that signals low State-of-Charge (SOC)
SOC_INT	Access to open-drain output that signals interrupt for changes in SOC

3 Circuit Module Physical Layouts, Bill of Materials, and Schematic

This section contains the board layout, bill of materials, assembly drawings, and schematic for the bq27520 circuit module.

3.1 Board Layout

This section shows the printed-circuit board (PCB) layers (Figure 1 through Figure 4), assembly drawing, and schematic for the bq27520 module.

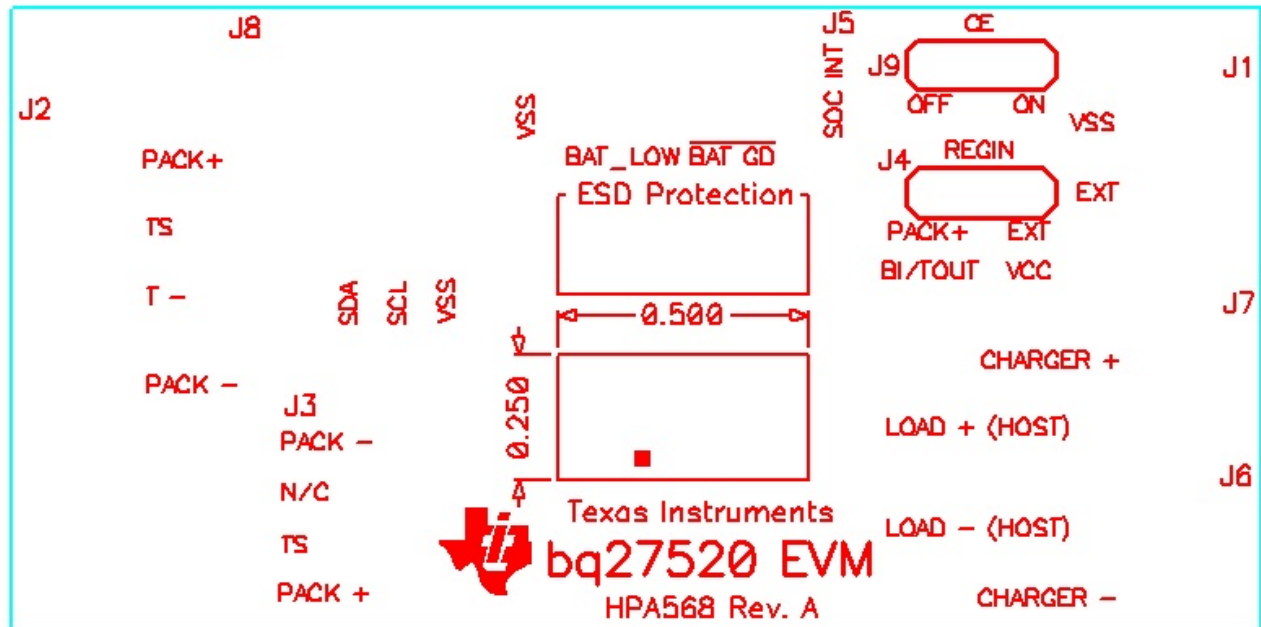

Figure 1. bq27520EVM-001 Layout – Silk Screen

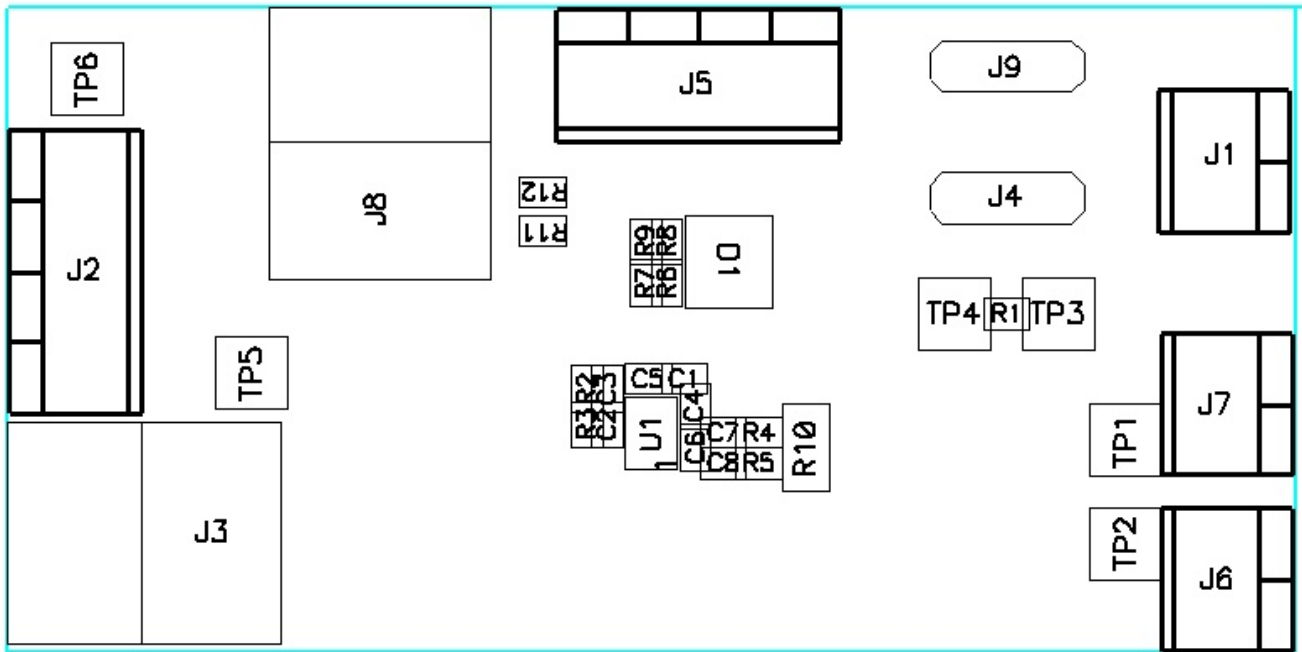

Figure 2. Top Assembly

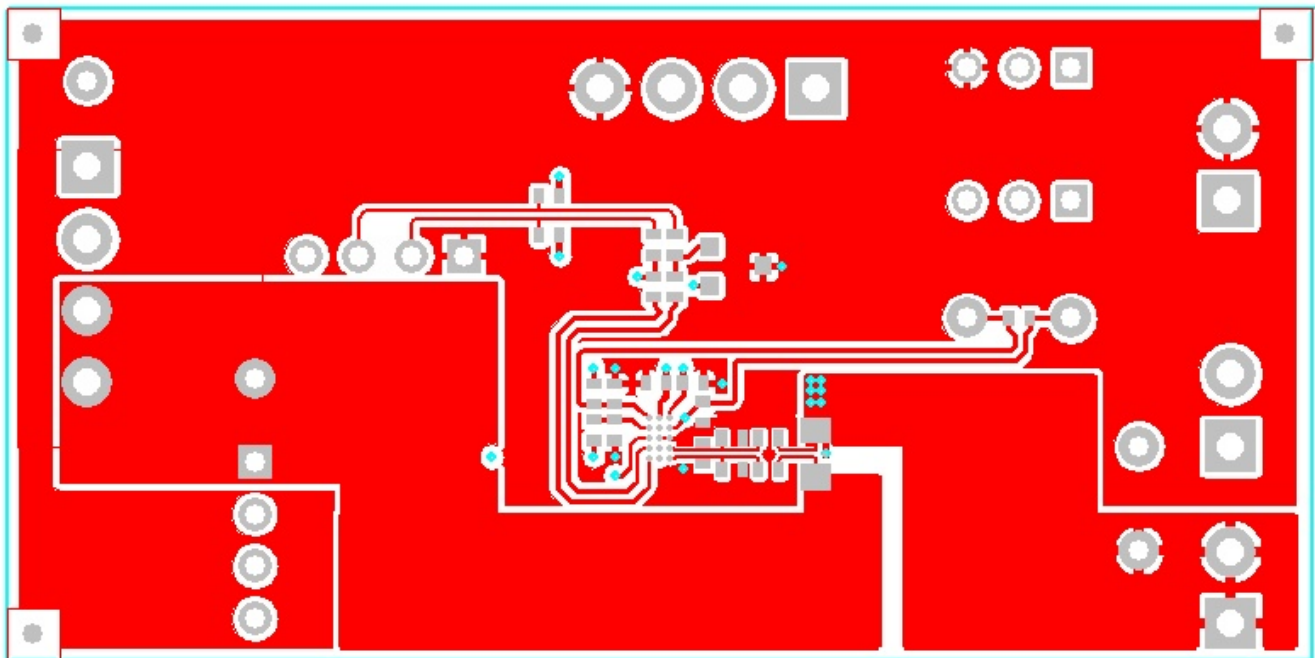
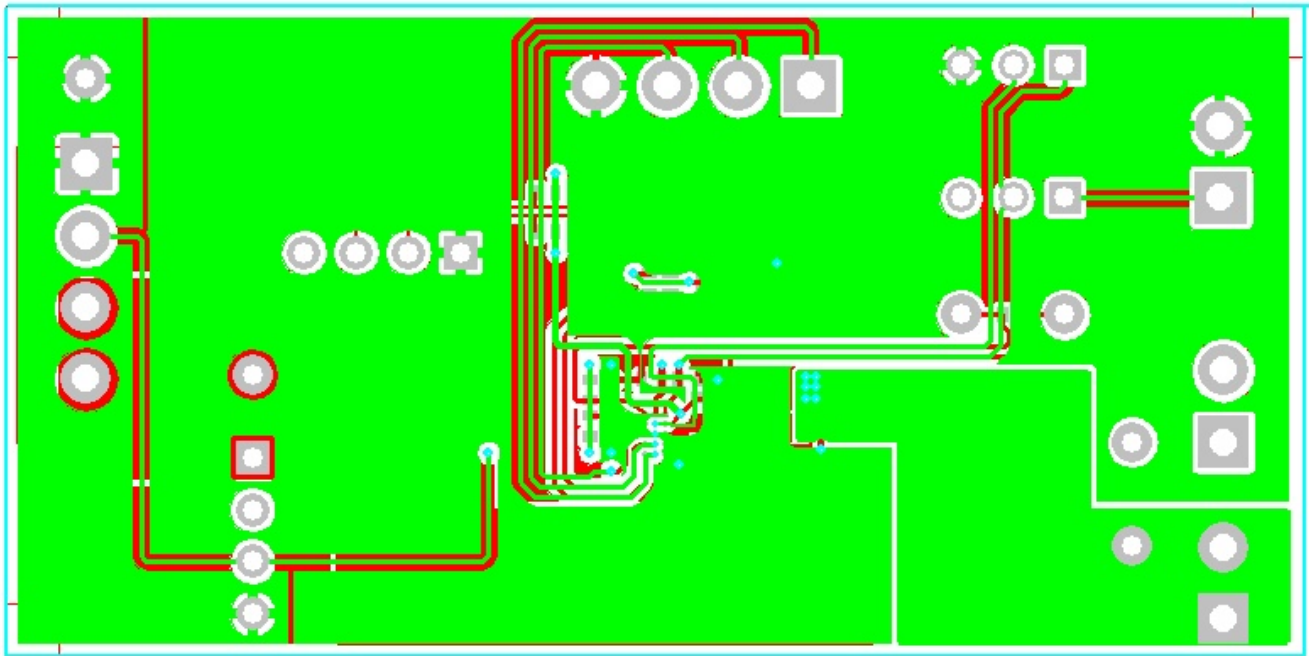

Figure 3. Top Layer

Figure 4. Bottom Layer

3.2 Bill of Materials and Schematic

Table 2. Bill of Materials

Count	Ref Des	Description	Size	MFG	Part Number
6	C1, C2, C5–C8	Capacitor, Ceramic, 0.1 μ F, 10 V, X5R	0402	Murata	GRM155R61A104KA01D
1	C3	Capacitor, Ceramic, 33 nF, 10 V, X7R, +/-10%	0402	Murata	GRM155R71A333KA01D
1	C4	Capacitor, Ceramic, 1 μ F, 6.3V, X5R	0402	Murata	GRM155R60J105KE19D
1	D1	Diode, Dual, Zener, 5.6 V, 300 mW	SOT23	Diodes	AZ23C5V6-7
3	J1, J6, J7	Terminal Block, 2-pin, 6 A, 3.5 mm	0.27 x 0.25 inch	OST	ED555/2DS
2	J2, J5	Terminal Block, 4-pin, 6 A, 3.5 mm	0.55 x 0.25 inch	OST	ED555/4DS
2	J3, J8	Header, Friction Lock Assy, 4-pin Right Angle,	0.400 x 0.500	Molex	22-05-3041
2	J4, J9	Header, Male 3-pin, 100-mil spacing, (36-pin strip)	0.100 inch x 3	Sullins	PEC36SAAN
1	R1	Resistor, Chip, 1.80 M Ω , 1/16 W, 5%	0402	Std	Std
1	R10	Resistor, Chip, 0.01 Ω , 1/4 W, 1%	0805	Vishay	WSL0805R0100FEA18
2	R11, R12	Resistor, Chip, 10 k Ω , 1/16 W, 5%	0402	Std	Std
1	R2	Resistor, Chip, 18.2 k Ω , 1/16 W, 5%	0402	Std	Std
1	R3	Resistor, Chip, 1 k Ω , 1/16 W, 5%	0402	Std	Std
6	R4–R9	Resistor, Chip, 100 Ω , 1/16 W, 5%	0402	Std	Std
3	TP1, TP3, TP6	Test Point, Red, Thru Hole Color Keyed	0.100 x 0.100 inch	Keystone	5000
2	TP2, TP5	Test Point, Black, Thru Hole Color Keyed	0.100 x 0.100 inch	Keystone	5001
1	TP4	Test Point, White, Thru Hole Color Keyed	0.100 x 0.100 inch	Keystone	5002
1	U1	IC, System-Side Impedance-Track Fuel Gauge	BGA	Texas Instruments	BQ27520YZF

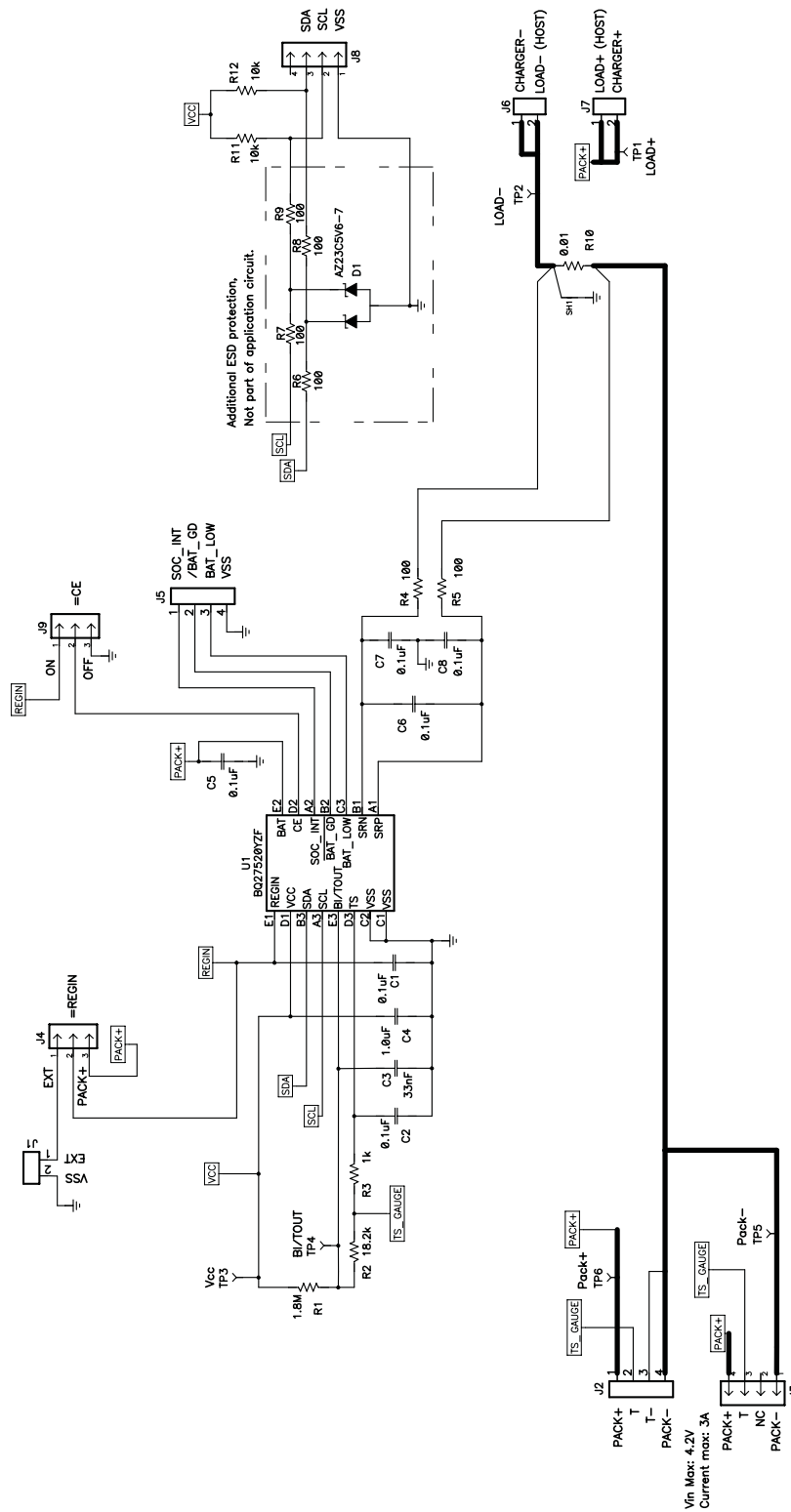

Figure 5. Schematic

3.3 bq27520 Circuit Module Performance Specification Summary

This section summarizes the performance specifications of the bq27520 circuit module.

Table 3. Performance Specification Summary

Specification	Min	Typ	Max	Units
Input voltage Pack+ to Pack-	2.7	3.6	4.3	V
Charge and discharge current	0	1	2	A

4 EVM Hardware and Software Setup

This section describes how to install the bq27520EVM PC software and how to connect the different components of the EVM.

4.1 Software Installation

Find the latest software version at <http://www.ti.com/tool/bqStudio>. Use the following steps to install Battery Management Studio:

1. Ensure that the EV2300 is not connected to the PC through a USB cable before starting this procedure.
2. Select the *Tool and Software* tab in the product folder.
3. Under the *Software* section, click on *Battery Management Studio (bqStudio) Software Suite*.
4. Click the **Download** button to download the software.
5. Download software to hard drive.
6. Double-click the software executable and follow all instructions and prompts.

5 Troubleshooting Unexpected Dialog Boxes

The user that is downloading the files must be logged in as the administrator.

The driver is not signed, so the administrator must allow installation of unsigned drivers in the operating system policy.

6 Hardware Connection

The bq27520EVM-001 comprises three hardware components: the bq27520 circuit module, the EV2300 PC interface board, and the PC.

6.1 Connecting the bq27520 Circuit Module to a Battery Pack

Figure 6 shows how to connect the bq27520 circuit module to the cells and system load/charger.

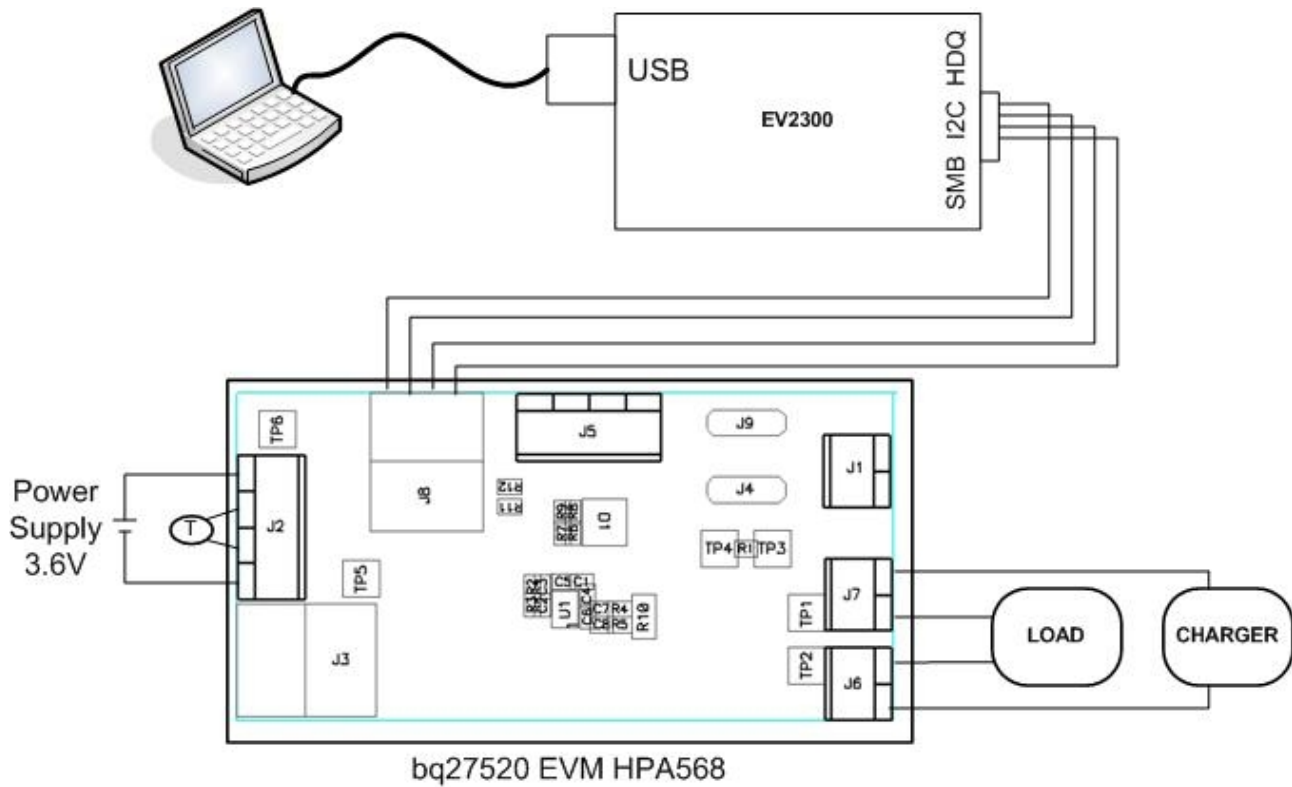

Figure 6. bq27520 Circuit Module Connection to Cell and System Load/Charger

6.2 PC Interface Connection

The following steps configure the hardware for interface to the PC.

1. Connect the bq27520-based EVM to the EV2300 using wire leads as shown in Table 4.

Table 4. Circuit Module to EV2300 Connections

bq27520-Based Battery	EV2300
SDA	SDA
SCL	SCL
VSS	GND

2. Connect the PC USB cable to the EV2300 and the PC USB port.

The bq27520EVM-001 is now set up for operation.

7 Operation

This section details the operation of the bqStudio software.

7.1 Starting the Program

Run bqStudio from the Start | All Programs | Texas Instruments | Battery Management Studio. The main screen (Figure 7) appears. If instead of Figure 7 appearing, Figure 8 appears, it may mean that the EVM is not connected to the computer correctly. Make sure that the USB interface (EV2300 or EV2400 or GDK) and the bq27520 are connected and restart bqStudio. If this still does not resolve the issue, check if the I²C pull-up resistors are connected. Data begins to appear once the <Refresh> (single-time scan) button is clicked, or when the Scan button is clicked. To disable the scan feature, simply click the **Scan** button again.

The continuous scanning period can be set by opening Window | Preferences → Registers section. The range for this interval is 0 ms to 65,535 ms. Only items that are selected for scanning are scanned within this period.

Battery Management Studio provides a logging function which logs the values that were last scanned. To enable this function, select the Start Log button; this causes the Scan button to be pressed. When logging is Stopped, the Scan button will still be selected and has to be manually clicked again.

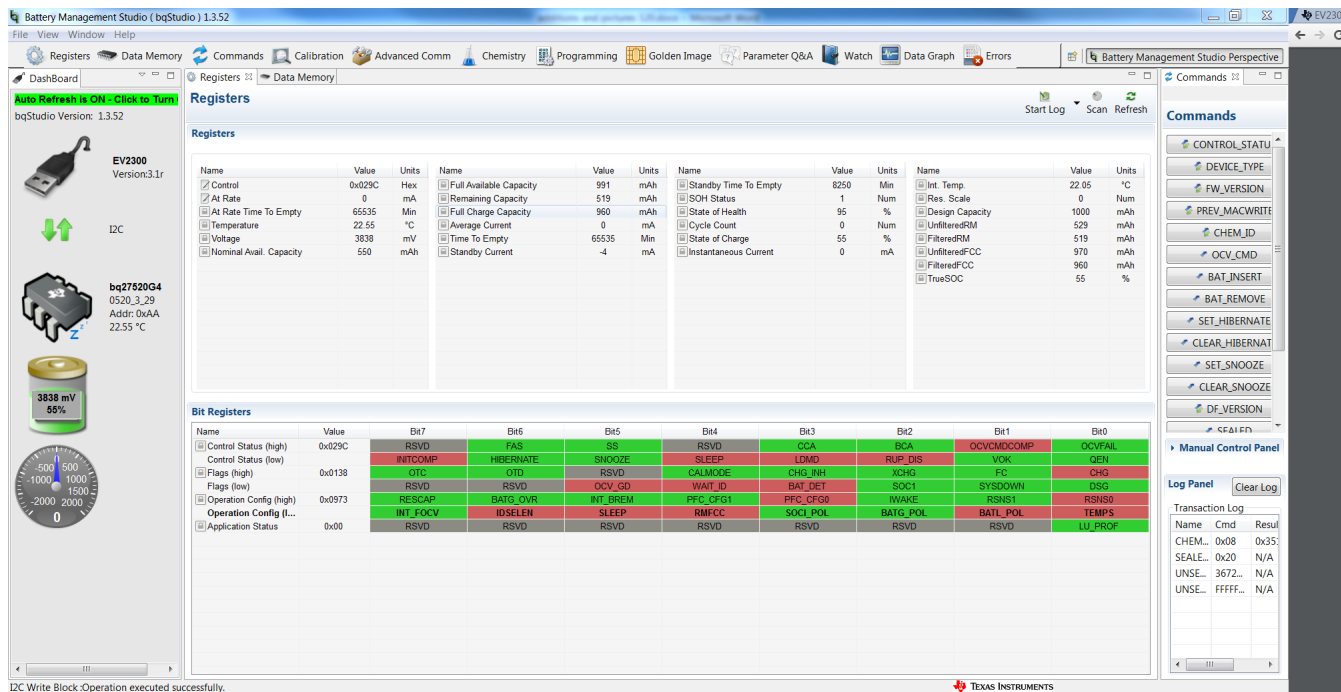

Figure 7. Registers Screen

This screen (Figure 7) shows the RAM data in the bq27520 device. Additional *Flags* and *Status* data can be viewed at the bottom of the *Registers* screen.

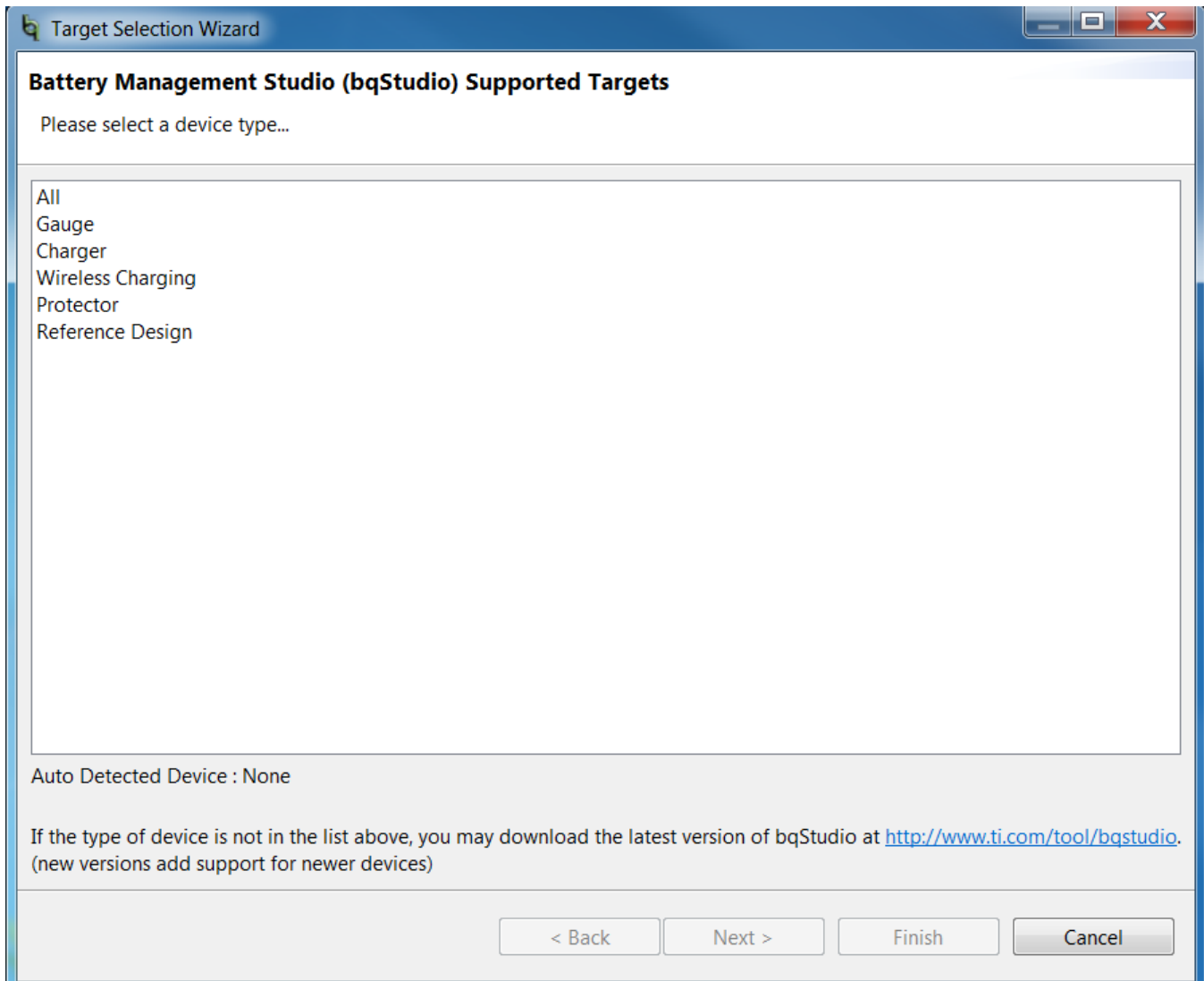

Figure 8. bqStudio Default Page

7.2 Setting Programmable bq27520 Options

The bq27520 data memory comes configured per the default settings detailed in the bq27520 technical reference manual (SLUUA35). Ensure that the settings are correctly changed to match the pack and application for the bq27520 solution being evaluated.

IMPORTANT: The correct setting of these options is essential to get the best performance.

The settings can be configured using the *Data Memory* screen (Figure 9).

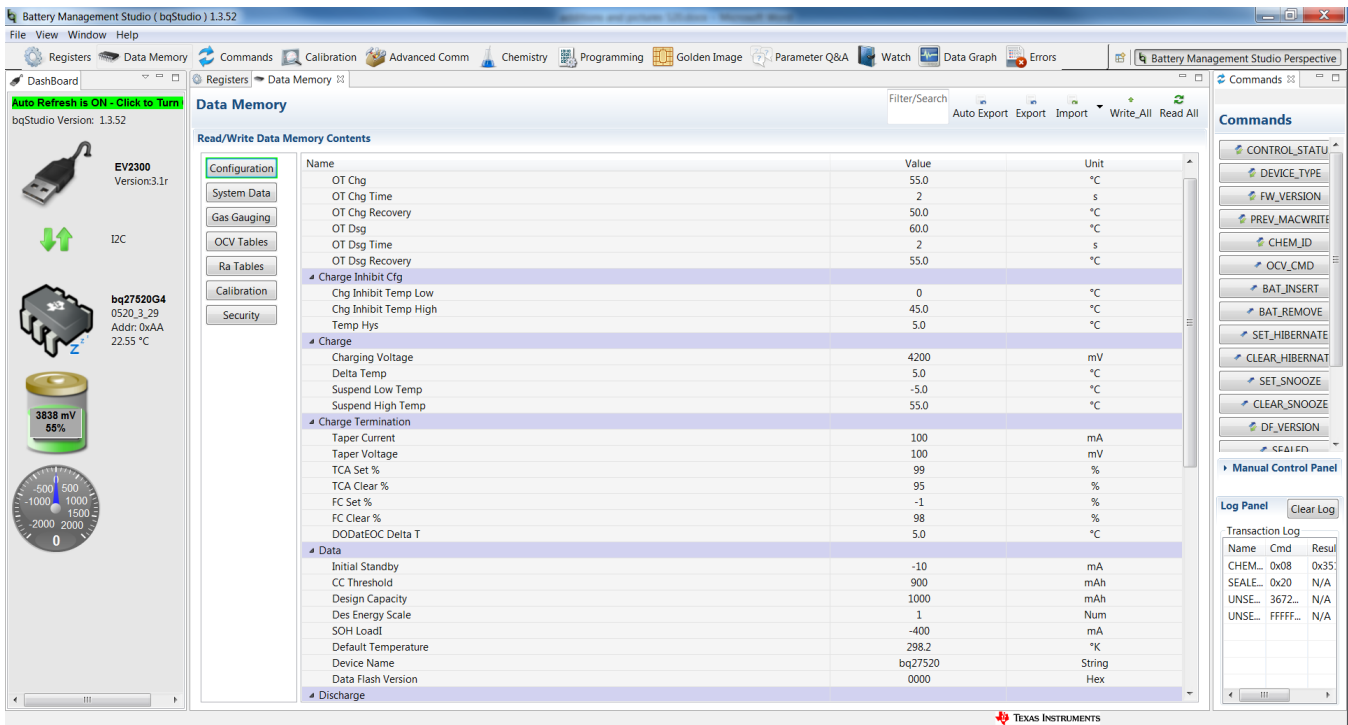

Figure 9. Data Memory Screen

To read all the data from the bq27520 non-volatile flash memory, click on the **Read All** button on the *Data Memory* window. Make sure the device is not sealed and in full access to read or write to the data memory. To update a parameter, click on the desired parameter and a window pops-up that provides details on the selected parameter. Next, enter the value in the value textbox and press **Enter**. After pressing **Enter**, bqStudio updates the selected parameter. The **Import** button in the *Data Memory* window can be clicked in order to import an entire configuration from a specified *.gg.csv file.

Save the configuration to a file by clicking the **Export** button in the *Data Memory* window and entering a file name. The configuration is saved to a *.gg.csv file. The module calibration data is also held in the bq27520 data memory. If the Gauge Dashboard is not displaying any information, then the bq27520 may not be supported by the bqStudio version being used, a bqStudio upgrade may be required.

8 Calibration

The bq27520EVM must be calibrated to ensure accurate value reporting. This can be done by going to the *Calibration* window in bqStudio (Figure 10).

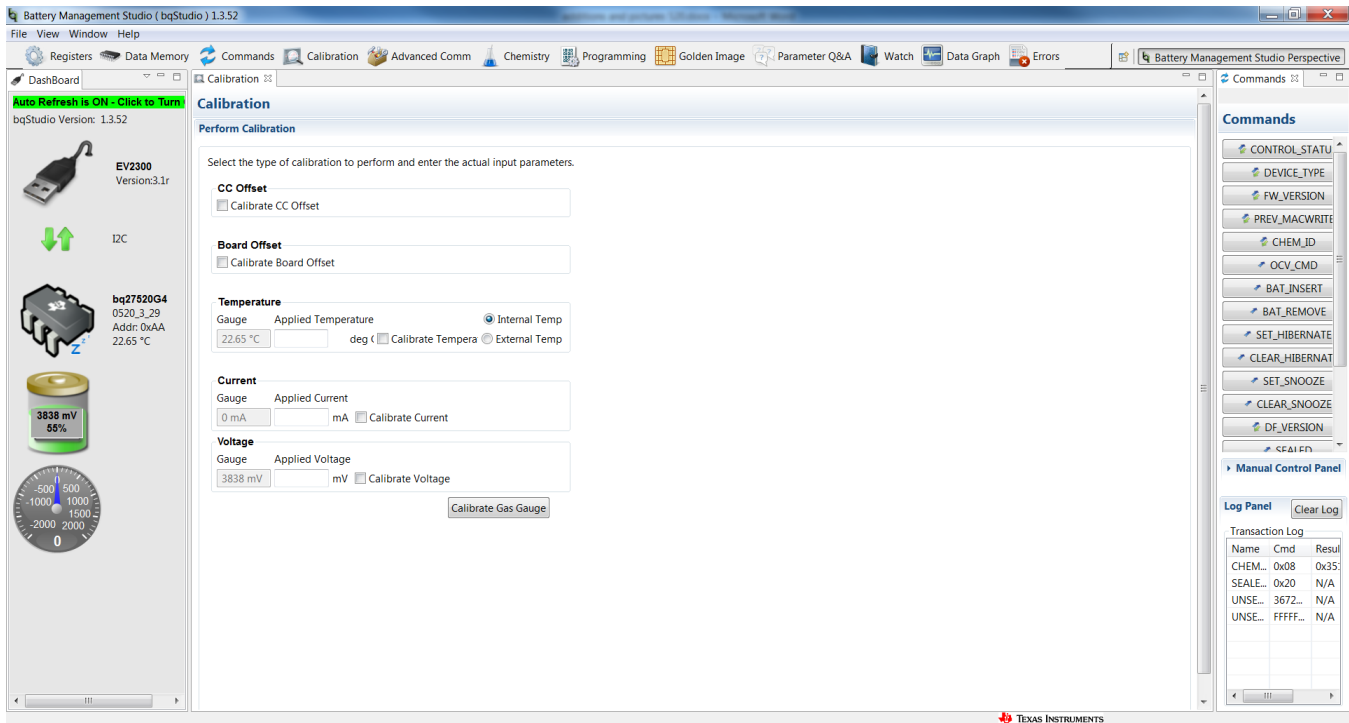

Figure 10. Calibration Window

8.1 Calibrating the bq27520

Calibrate each item one at a time in the order presented in this document. Select the types of calibration to be performed by selecting the corresponding checkbox (see Figure 10).

Enter the measured values for the types selected, if necessary.

Then press the *Calibrate Part as indicated below* button. After all calibration is complete, close the Calibrate subwindow. While the Calibrate subwindow is open, even in the background, the calibration routines are running in firmware. Close the subwindow to ensure that they are stopped before you proceed with configuration or testing.

8.2 CC Offset Calibration

This performs the internal calibration of the coulomb counter input offset. Press the *Calibrate Gas Gauge as indicated below* button.

8.3 Board Offset Calibration

This performs the offset calibration for the current offset of the board. It is expected that no current is flowing through the sense resistor while performing this calibration step.

- Remove load and short Pack– to GND.
- Press the **Calibration Board Offset** button.

8.4 Voltage Calibration

Use the following procedures to calibrate voltage:

- Measure the voltage across Pack+ and Pack– with a calibrated meter.
- Type the voltage value in *mV* into *Enter Actual Voltage*.
- Measure the temperature for PACK.
- Type the temperature value into *Enter Actual Temperature*.
- Press the *Calibrate Voltage and Temperature as indicated below* button.

8.5 Temperature Calibration

- Measure the temperature for PACK.
- Type the temperature value into *Enter Actual Temperature*.
- Select if the temperature sensor to calibrate is the internal or external.
- Press the *Calibrate Gas Gauge as indicated below* button.

8.6 Pack Current Calibration

- Connect a load to LOAD– and LOAD+ that draws approximately 1 A, or connect a current source to LOAD– and Pack–. Ensure that the *Measured Current* reported is negative, or else reverse the connections.
- Measure the current with a calibrated meter, and type the value into *Enter Actual Current* using (-) for current in discharge direction.
- Press the *Calibrate Gas Gauge as indicated below* button.

9 Advanced Communication I²C

9.1 I²C Communication

I²C read/write operations are not specific to any gas gauge. These operations serve as general-purpose communication tools (Figure 11).

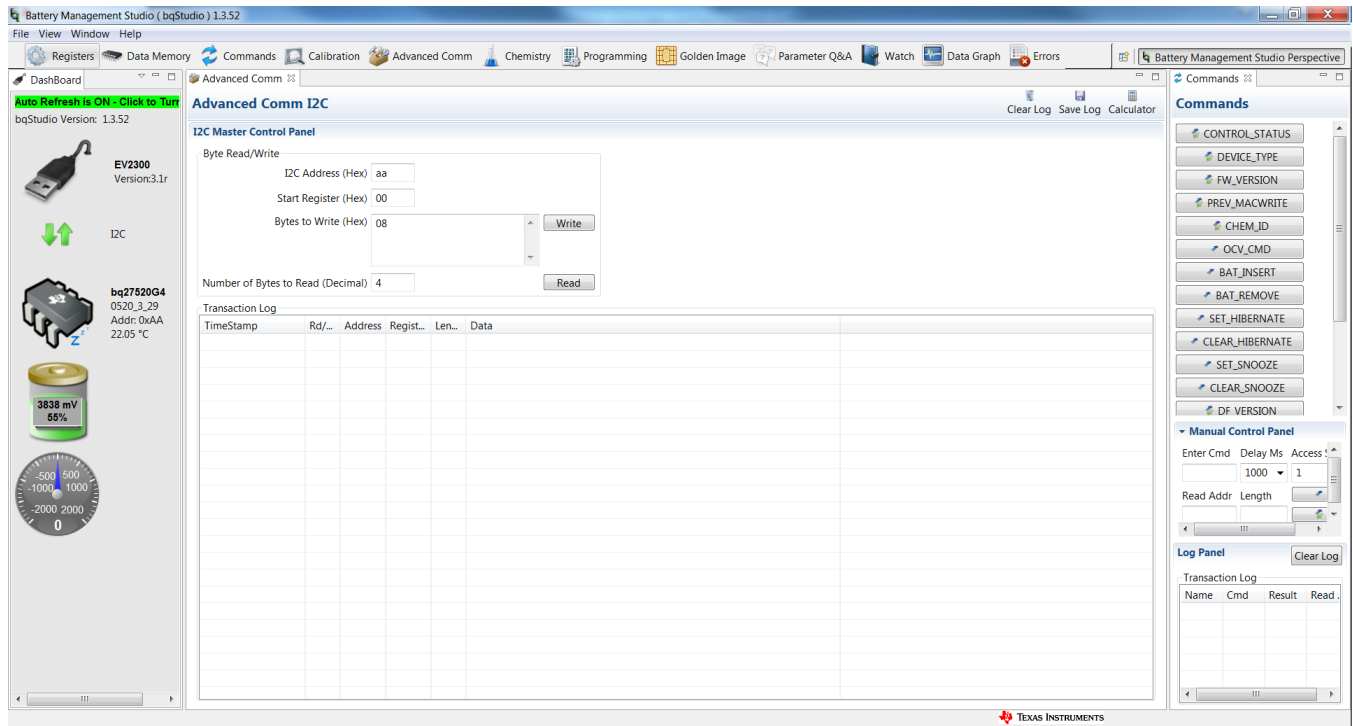

Figure 11. Advanced Communication I²C

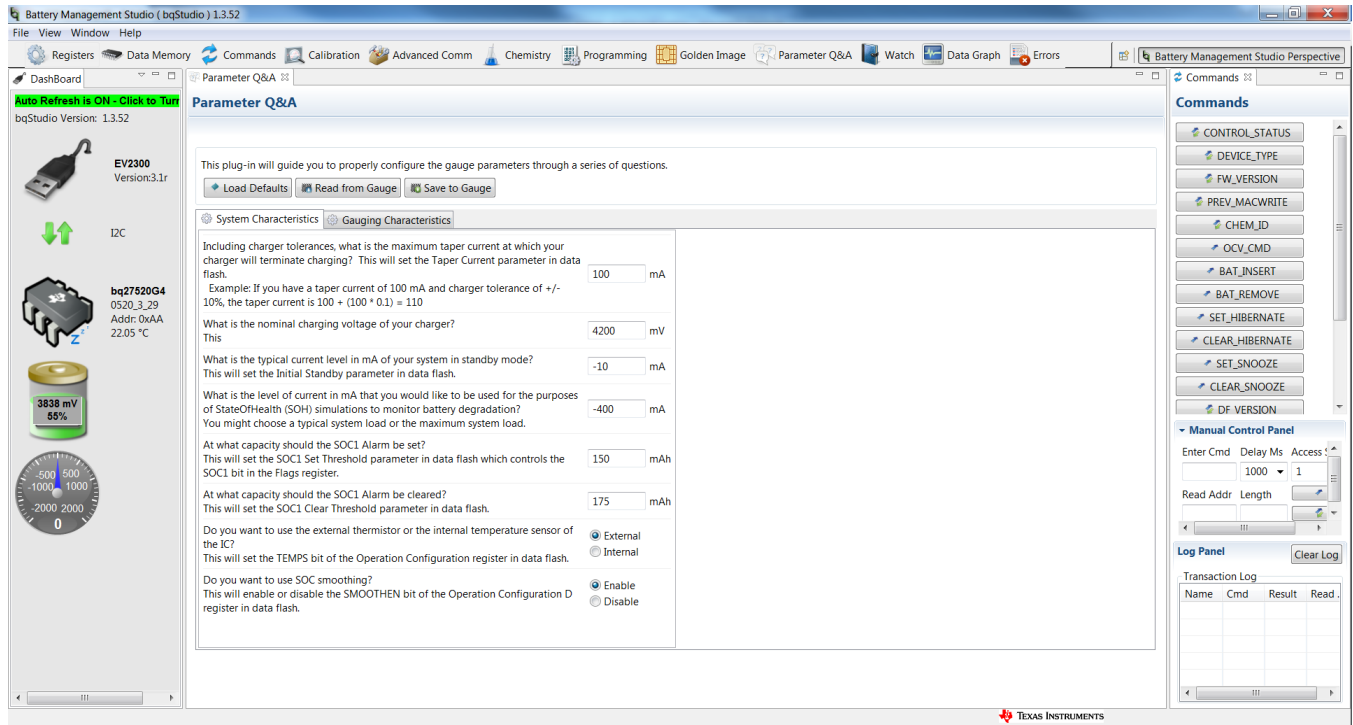

Figure 12. Parameter Q&A Screen

Golden Image

Golden Image Export

This plug-in will allow you to export image files. It will read the data memory contents of the connected gauge and save it to your hard drive in various formats.

Output Location

Output Directory: C:\ti\BatteryManagementStudio\OutputFiles Browse

Base File Name: 0520_3_29-bq27520G4 Open Directory

Output Formats

SREC File (.srec) 0520_3_29-bq27520G4.srec Options

BQFS File (.fs) 0520_3_29-bq27520G4.bq.fs Options

DFFS File (.fs) 0520_3_29-bq27520G4.df.fs Options

Create Image Files

Figure 13. Golden Image Output Screen

Programming

Perform Programming

This plug-in will allow you to program image files to a device.

Select Programmable File

Browse...

Program

Execute FW

Figure 14. Perform Programming Screen

10 bqStudio™ Software

10.1 Introduction

Texas Instruments fuel gauges, employing the Impedance Track algorithm, offer an unmatched array of features and benefits. Sometimes, however, the wide range of configuration settings can seem challenging to get started with the evaluation process. In addition, determining the correct chemistry model and producing the 'golden image' file can be time consuming. The bqStudio program is designed to greatly simplify the process of configuring, calibrating, selecting chemistry, and performing learning cycles through the step-by-step use of a wizard program.

10.2 Program Navigation and Flowchart

The sequence of operation of the bqStudio program can be understood by reviewing the basic flowchart in [Figure 15](#). Using the program is simple – just start a new project and follow the steps sequentially from 1A to 5C. You can use the Next button, or click on the top tabs and left subsection labels to move to any desired page. Some operations must be completed in sequence due to data dependencies, or to implement the proper flow. Therefore, it is recommended that the prescribed sequence be followed, at least at first.

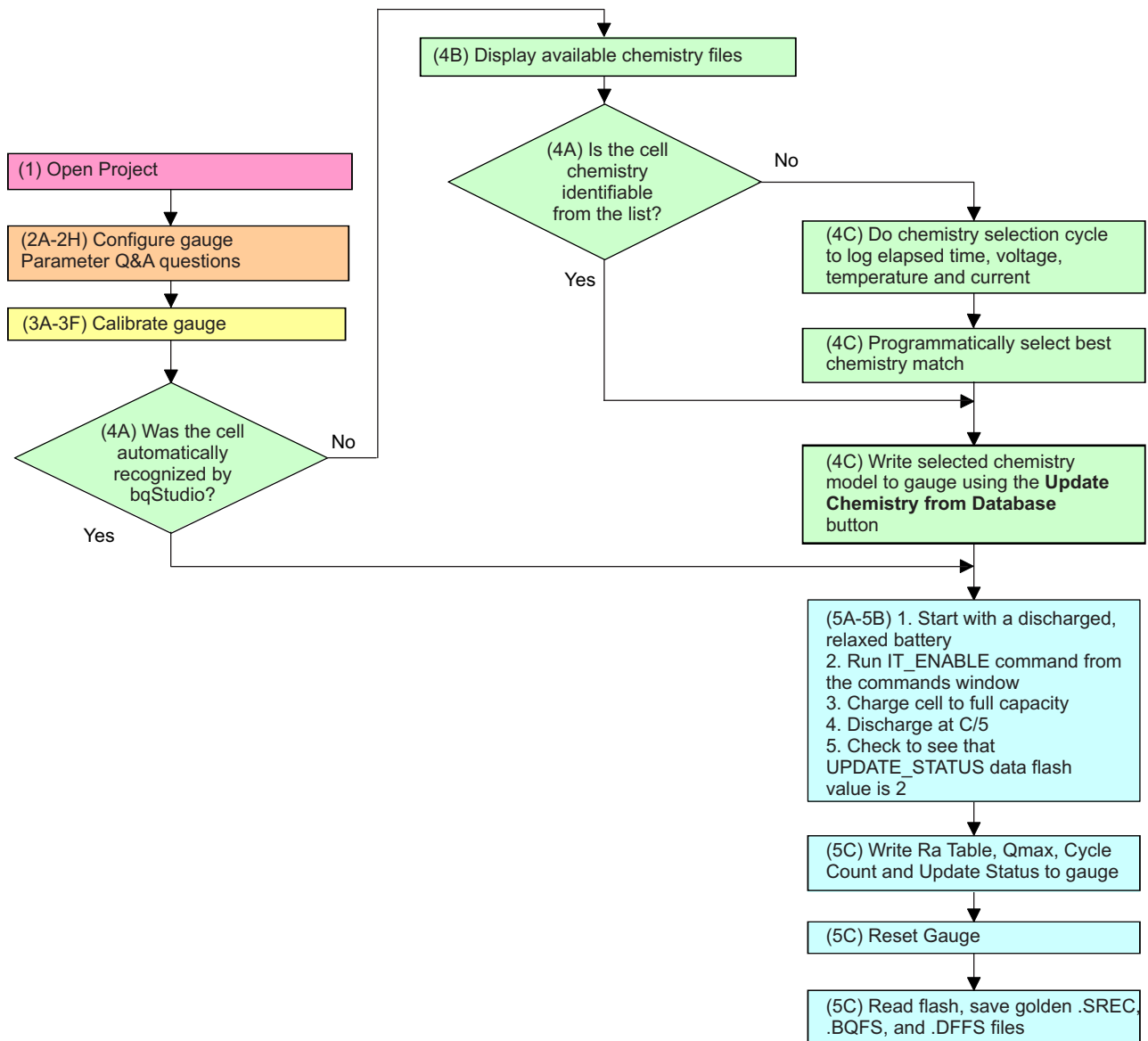

There is not a **Learning Cycle** button in the bq27520EVM bqStudio display.

Figure 15. bqStudio Flowchart

11 Related Documentation From Texas Instruments

To obtain a copy of any of the following TI documents, call the Texas Instruments Literature Response Center at (800) 477-8924 or the Product Information Center (PIC) at (972) 644-5580. When ordering, identify this document by its title and literature number. Updated documents also can be obtained through the TI Web site at www.ti.com.

- *bq27520, System-Side Impedance Track Fuel Gauge With Integrated LDO* data sheet ([SLUS955](#))

Revision History

NOTE: Page numbers for previous revisions may differ from page numbers in the current version.

Changes from A Revision (October 2013) to B Revision	Page
• Deleted <i>System Requirements</i> and reworded <i>Software Installation</i> sections in <i>EVM Hardware and Software Setup</i>	7
• Changed the entire <i>Operation</i> section, text and images.	9
• Changed <i>Calibrate Screen</i> section to <i>Calibration</i> section, and changed much of the text in the section.	12
• Changed <i>PC Pro Screen</i> section to <i>Advanced Communication PC</i> , changed some text and the images in this section..	14
• Changed bqEASY to bqStudio globally in the document. Removed all images and content related to bqEASY.....	16
• Changed the <i>Flowchart</i> image.	17
• Deleted <i>Simplified Configuration Procedures, Files, Completion Checkmarks, and Device Detection</i> sections.	17

STANDARD TERMS AND CONDITIONS FOR EVALUATION MODULES

1. *Delivery:* TI delivers TI evaluation boards, kits, or modules, including any accompanying demonstration software, components, or documentation (collectively, an "EVM" or "EVMs") to the User ("User") in accordance with the terms and conditions set forth herein. Acceptance of the EVM is expressly subject to the following terms and conditions.
 - 1.1 EVMs are intended solely for product or software developers for use in a research and development setting to facilitate feasibility evaluation, experimentation, or scientific analysis of TI semiconductor products. EVMs have no direct function and are not finished products. EVMs shall not be directly or indirectly assembled as a part or subassembly in any finished product. For clarification, any software or software tools provided with the EVM ("Software") shall not be subject to the terms and conditions set forth herein but rather shall be subject to the applicable terms and conditions that accompany such Software
 - 1.2 EVMs are not intended for consumer or household use. EVMs may not be sold, sublicensed, leased, rented, loaned, assigned, or otherwise distributed for commercial purposes by Users, in whole or in part, or used in any finished product or production system.
2. *Limited Warranty and Related Remedies/Disclaimers:*
 - 2.1 These terms and conditions do not apply to Software. The warranty, if any, for Software is covered in the applicable Software License Agreement.
 - 2.2 TI warrants that the TI EVM will conform to TI's published specifications for ninety (90) days after the date TI delivers such EVM to User. Notwithstanding the foregoing, TI shall not be liable for any defects that are caused by neglect, misuse or mistreatment by an entity other than TI, including improper installation or testing, or for any EVMs that have been altered or modified in any way by an entity other than TI. Moreover, TI shall not be liable for any defects that result from User's design, specifications or instructions for such EVMs. Testing and other quality control techniques are used to the extent TI deems necessary or as mandated by government requirements. TI does not test all parameters of each EVM.
 - 2.3 If any EVM fails to conform to the warranty set forth above, TI's sole liability shall be at its option to repair or replace such EVM, or credit User's account for such EVM. TI's liability under this warranty shall be limited to EVMs that are returned during the warranty period to the address designated by TI and that are determined by TI not to conform to such warranty. If TI elects to repair or replace such EVM, TI shall have a reasonable time to repair such EVM or provide replacements. Repaired EVMs shall be warranted for the remainder of the original warranty period. Replaced EVMs shall be warranted for a new full ninety (90) day warranty period.
3. *Regulatory Notices:*
 - 3.1 *United States*
 - 3.1.1 *Notice applicable to EVMs not FCC-Approved:*

This kit is designed to allow product developers to evaluate electronic components, circuitry, or software associated with the kit to determine whether to incorporate such items in a finished product and software developers to write software applications for use with the end product. This kit is not a finished product and when assembled may not be resold or otherwise marketed unless all required FCC equipment authorizations are first obtained. Operation is subject to the condition that this product not cause harmful interference to licensed radio stations and that this product accept harmful interference. Unless the assembled kit is designed to operate under part 15, part 18 or part 95 of this chapter, the operator of the kit must operate under the authority of an FCC license holder or must secure an experimental authorization under part 5 of this chapter.
 - 3.1.2 *For EVMs annotated as FCC – FEDERAL COMMUNICATIONS COMMISSION Part 15 Compliant:*

CAUTION

This device complies with part 15 of the FCC Rules. Operation is subject to the following two conditions: (1) This device may not cause harmful interference, and (2) this device must accept any interference received, including interference that may cause undesired operation.

Changes or modifications not expressly approved by the party responsible for compliance could void the user's authority to operate the equipment.

FCC Interference Statement for Class A EVM devices

NOTE: This equipment has been tested and found to comply with the limits for a Class A digital device, pursuant to part 15 of the FCC Rules. These limits are designed to provide reasonable protection against harmful interference when the equipment is operated in a commercial environment. This equipment generates, uses, and can radiate radio frequency energy and, if not installed and used in accordance with the instruction manual, may cause harmful interference to radio communications. Operation of this equipment in a residential area is likely to cause harmful interference in which case the user will be required to correct the interference at his own expense.

FCC Interference Statement for Class B EVM devices

NOTE: This equipment has been tested and found to comply with the limits for a Class B digital device, pursuant to part 15 of the FCC Rules. These limits are designed to provide reasonable protection against harmful interference in a residential installation. This equipment generates, uses and can radiate radio frequency energy and, if not installed and used in accordance with the instructions, may cause harmful interference to radio communications. However, there is no guarantee that interference will not occur in a particular installation. If this equipment does cause harmful interference to radio or television reception, which can be determined by turning the equipment off and on, the user is encouraged to try to correct the interference by one or more of the following measures:

- Reorient or relocate the receiving antenna.
- Increase the separation between the equipment and receiver.
- Connect the equipment into an outlet on a circuit different from that to which the receiver is connected.
- Consult the dealer or an experienced radio/TV technician for help.

3.2 Canada

3.2.1 For EVMs issued with an Industry Canada Certificate of Conformance to RSS-210

Concerning EVMs Including Radio Transmitters:

This device complies with Industry Canada license-exempt RSS standard(s). Operation is subject to the following two conditions: (1) this device may not cause interference, and (2) this device must accept any interference, including interference that may cause undesired operation of the device.

Concernant les EVMs avec appareils radio:

Le présent appareil est conforme aux CNR d'Industrie Canada applicables aux appareils radio exempts de licence. L'exploitation est autorisée aux deux conditions suivantes: (1) l'appareil ne doit pas produire de brouillage, et (2) l'utilisateur de l'appareil doit accepter tout brouillage radioélectrique subi, même si le brouillage est susceptible d'en compromettre le fonctionnement.

Concerning EVMs Including Detachable Antennas:

Under Industry Canada regulations, this radio transmitter may only operate using an antenna of a type and maximum (or lesser) gain approved for the transmitter by Industry Canada. To reduce potential radio interference to other users, the antenna type and its gain should be so chosen that the equivalent isotropically radiated power (e.i.r.p.) is not more than that necessary for successful communication. This radio transmitter has been approved by Industry Canada to operate with the antenna types listed in the user guide with the maximum permissible gain and required antenna impedance for each antenna type indicated. Antenna types not included in this list, having a gain greater than the maximum gain indicated for that type, are strictly prohibited for use with this device.

Concernant les EVMs avec antennes détachables

Conformément à la réglementation d'Industrie Canada, le présent émetteur radio peut fonctionner avec une antenne d'un type et d'un gain maximal (ou inférieur) approuvé pour l'émetteur par Industrie Canada. Dans le but de réduire les risques de brouillage radioélectrique à l'intention des autres utilisateurs, il faut choisir le type d'antenne et son gain de sorte que la puissance isotrope rayonnée équivalente (p.i.r.e.) ne dépasse pas l'intensité nécessaire à l'établissement d'une communication satisfaisante. Le présent émetteur radio a été approuvé par Industrie Canada pour fonctionner avec les types d'antenne énumérés dans le manuel d'usage et ayant un gain admissible maximal et l'impédance requise pour chaque type d'antenne. Les types d'antenne non inclus dans cette liste, ou dont le gain est supérieur au gain maximal indiqué, sont strictement interdits pour l'exploitation de l'émetteur.

3.3 Japan

3.3.1 *Notice for EVMs delivered in Japan:* Please see http://www.tij.co.jp/lstds/ti_ja/general/eStore/notice_01.page 日本国内に輸入される評価用キット、ボードについては、次のところをご覧ください。
http://www.tij.co.jp/lstds/ti_ja/general/eStore/notice_01.page

3.3.2 *Notice for Users of EVMs Considered "Radio Frequency Products" in Japan:* EVMs entering Japan may not be certified by TI as conforming to Technical Regulations of Radio Law of Japan.

If User uses EVMs in Japan, not certified to Technical Regulations of Radio Law of Japan, User is required by Radio Law of Japan to follow the instructions below with respect to EVMs:

1. Use EVMs in a shielded room or any other test facility as defined in the notification #173 issued by Ministry of Internal Affairs and Communications on March 28, 2006, based on Sub-section 1.1 of Article 6 of the Ministry's Rule for Enforcement of Radio Law of Japan,
2. Use EVMs only after User obtains the license of Test Radio Station as provided in Radio Law of Japan with respect to EVMs, or
3. Use of EVMs only after User obtains the Technical Regulations Conformity Certification as provided in Radio Law of Japan with respect to EVMs. Also, do not transfer EVMs, unless User gives the same notice above to the transferee. Please note that if User does not follow the instructions above, User will be subject to penalties of Radio Law of Japan.

【無線電波を送信する製品の開発キットをお使いになる際の注意事項】 開発キットの中には技術基準適合証明を受けていないものがあります。技術適合証明を受けていないもののご使用に際しては、電波法遵守のため、以下のいずれかの措置を取っていただく必要がありますのでご注意ください。

1. 電波法施行規則第6条第1項第1号に基づく平成18年3月28日総務省告示第173号で定められた電波暗室等の試験設備でご使用いただく。
2. 実験局の免許を取得後ご使用いただく。
3. 技術基準適合証明を取得後ご使用いただく。

なお、本製品は、上記の「ご使用にあたっての注意」を譲渡先、移転先に通知しない限り、譲渡、移転できないものとします。

上記を遵守頂けない場合は、電波法の罰則が適用される可能性があることをご留意ください。日本テキサス・インスツルメンツ株式会社
東京都新宿区西新宿 6 丁目 2 4 番 1 号
西新宿三井ビル

3.3.3 *Notice for EVMs for Power Line Communication:* Please see http://www.tij.co.jp/llds/ti_ja/general/eStore/notice_02.page
電力線搬送波通信についての開発キットをお使いになる際の注意事項については、次のところをご覧ください。http://www.tij.co.jp/llds/ti_ja/general/eStore/notice_02.page

4 *EVM Use Restrictions and Warnings:*

4.1 EVMS ARE NOT FOR USE IN FUNCTIONAL SAFETY AND/OR SAFETY CRITICAL EVALUATIONS, INCLUDING BUT NOT LIMITED TO EVALUATIONS OF LIFE SUPPORT APPLICATIONS.

4.2 User must read and apply the user guide and other available documentation provided by TI regarding the EVM prior to handling or using the EVM, including without limitation any warning or restriction notices. The notices contain important safety information related to, for example, temperatures and voltages.

4.3 *Safety-Related Warnings and Restrictions:*

4.3.1 User shall operate the EVM within TI's recommended specifications and environmental considerations stated in the user guide, other available documentation provided by TI, and any other applicable requirements and employ reasonable and customary safeguards. Exceeding the specified performance ratings and specifications (including but not limited to input and output voltage, current, power, and environmental ranges) for the EVM may cause personal injury or death, or property damage. If there are questions concerning performance ratings and specifications, User should contact a TI field representative prior to connecting interface electronics including input power and intended loads. Any loads applied outside of the specified output range may also result in unintended and/or inaccurate operation and/or possible permanent damage to the EVM and/or interface electronics. Please consult the EVM user guide prior to connecting any load to the EVM output. If there is uncertainty as to the load specification, please contact a TI field representative. During normal operation, even with the inputs and outputs kept within the specified allowable ranges, some circuit components may have elevated case temperatures. These components include but are not limited to linear regulators, switching transistors, pass transistors, current sense resistors, and heat sinks, which can be identified using the information in the associated documentation. When working with the EVM, please be aware that the EVM may become very warm.

4.3.2 EVMs are intended solely for use by technically qualified, professional electronics experts who are familiar with the dangers and application risks associated with handling electrical mechanical components, systems, and subsystems. User assumes all responsibility and liability for proper and safe handling and use of the EVM by User or its employees, affiliates, contractors or designees. User assumes all responsibility and liability to ensure that any interfaces (electronic and/or mechanical) between the EVM and any human body are designed with suitable isolation and means to safely limit accessible leakage currents to minimize the risk of electrical shock hazard. User assumes all responsibility and liability for any improper or unsafe handling or use of the EVM by User or its employees, affiliates, contractors or designees.

4.4 User assumes all responsibility and liability to determine whether the EVM is subject to any applicable international, federal, state, or local laws and regulations related to User's handling and use of the EVM and, if applicable, User assumes all responsibility and liability for compliance in all respects with such laws and regulations. User assumes all responsibility and liability for proper disposal and recycling of the EVM consistent with all applicable international, federal, state, and local requirements.

5. *Accuracy of Information:* To the extent TI provides information on the availability and function of EVMs, TI attempts to be as accurate as possible. However, TI does not warrant the accuracy of EVM descriptions, EVM availability or other information on its websites as accurate, complete, reliable, current, or error-free.

6. *Disclaimers:*

6.1 EXCEPT AS SET FORTH ABOVE, EVMS AND ANY WRITTEN DESIGN MATERIALS PROVIDED WITH THE EVM (AND THE DESIGN OF THE EVM ITSELF) ARE PROVIDED "AS IS" AND "WITH ALL FAULTS." TI DISCLAIMS ALL OTHER WARRANTIES, EXPRESS OR IMPLIED, REGARDING SUCH ITEMS, INCLUDING BUT NOT LIMITED TO ANY IMPLIED WARRANTIES OF MERCHANTABILITY OR FITNESS FOR A PARTICULAR PURPOSE OR NON-INFRINGEMENT OF ANY THIRD PARTY PATENTS, COPYRIGHTS, TRADE SECRETS OR OTHER INTELLECTUAL PROPERTY RIGHTS.

6.2 EXCEPT FOR THE LIMITED RIGHT TO USE THE EVM SET FORTH HEREIN, NOTHING IN THESE TERMS AND CONDITIONS SHALL BE CONSTRUED AS GRANTING OR CONFERRING ANY RIGHTS BY LICENSE, PATENT, OR ANY OTHER INDUSTRIAL OR INTELLECTUAL PROPERTY RIGHT OF TI, ITS SUPPLIERS/LICENSORS OR ANY OTHER THIRD PARTY, TO USE THE EVM IN ANY FINISHED END-USER OR READY-TO-USE FINAL PRODUCT, OR FOR ANY INVENTION, DISCOVERY OR IMPROVEMENT MADE, CONCEIVED OR ACQUIRED PRIOR TO OR AFTER DELIVERY OF THE EVM.

7. *USER'S INDEMNITY OBLIGATIONS AND REPRESENTATIONS.* USER WILL DEFEND, INDEMNIFY AND HOLD TI, ITS LICENSORS AND THEIR REPRESENTATIVES HARMLESS FROM AND AGAINST ANY AND ALL CLAIMS, DAMAGES, LOSSES, EXPENSES, COSTS AND LIABILITIES (COLLECTIVELY, "CLAIMS") ARISING OUT OF OR IN CONNECTION WITH ANY HANDLING OR USE OF THE EVM THAT IS NOT IN ACCORDANCE WITH THESE TERMS AND CONDITIONS. THIS OBLIGATION SHALL APPLY WHETHER CLAIMS ARISE UNDER STATUTE, REGULATION, OR THE LAW OF TORT, CONTRACT OR ANY OTHER LEGAL THEORY, AND EVEN IF THE EVM FAILS TO PERFORM AS DESCRIBED OR EXPECTED.

8. *Limitations on Damages and Liability:*

8.1 *General Limitations.* IN NO EVENT SHALL TI BE LIABLE FOR ANY SPECIAL, COLLATERAL, INDIRECT, PUNITIVE, INCIDENTAL, CONSEQUENTIAL, OR EXEMPLARY DAMAGES IN CONNECTION WITH OR ARISING OUT OF THESE TERMS AND CONDITIONS OR THE USE OF THE EVMS PROVIDED HEREUNDER, REGARDLESS OF WHETHER TI HAS BEEN ADVISED OF THE POSSIBILITY OF SUCH DAMAGES. EXCLUDED DAMAGES INCLUDE, BUT ARE NOT LIMITED TO, COST OF REMOVAL OR REINSTALLATION, ANCILLARY COSTS TO THE PROCUREMENT OF SUBSTITUTE GOODS OR SERVICES, RETESTING, OUTSIDE COMPUTER TIME, LABOR COSTS, LOSS OF GOODWILL, LOSS OF PROFITS, LOSS OF SAVINGS, LOSS OF USE, LOSS OF DATA, OR BUSINESS INTERRUPTION. NO CLAIM, SUIT OR ACTION SHALL BE BROUGHT AGAINST TI MORE THAN ONE YEAR AFTER THE RELATED CAUSE OF ACTION HAS OCCURRED.

8.2 *Specific Limitations.* IN NO EVENT SHALL TI'S AGGREGATE LIABILITY FROM ANY WARRANTY OR OTHER OBLIGATION ARISING OUT OF OR IN CONNECTION WITH THESE TERMS AND CONDITIONS, OR ANY USE OF ANY TI EVM PROVIDED HEREUNDER, EXCEED THE TOTAL AMOUNT PAID TO TI FOR THE PARTICULAR UNITS SOLD UNDER THESE TERMS AND CONDITIONS WITH RESPECT TO WHICH LOSSES OR DAMAGES ARE CLAIMED. THE EXISTENCE OF MORE THAN ONE CLAIM AGAINST THE PARTICULAR UNITS SOLD TO USER UNDER THESE TERMS AND CONDITIONS SHALL NOT ENLARGE OR EXTEND THIS LIMIT.

9. *Return Policy.* Except as otherwise provided, TI does not offer any refunds, returns, or exchanges. Furthermore, no return of EVM(s) will be accepted if the package has been opened and no return of the EVM(s) will be accepted if they are damaged or otherwise not in a resalable condition. If User feels it has been incorrectly charged for the EVM(s) it ordered or that delivery violates the applicable order, User should contact TI. All refunds will be made in full within thirty (30) working days from the return of the components(s), excluding any postage or packaging costs.

10. *Governing Law:* These terms and conditions shall be governed by and interpreted in accordance with the laws of the State of Texas, without reference to conflict-of-laws principles. User agrees that non-exclusive jurisdiction for any dispute arising out of or relating to these terms and conditions lies within courts located in the State of Texas and consents to venue in Dallas County, Texas. Notwithstanding the foregoing, any judgment may be enforced in any United States or foreign court, and TI may seek injunctive relief in any United States or foreign court.

IMPORTANT NOTICE AND DISCLAIMER

TI PROVIDES TECHNICAL AND RELIABILITY DATA (INCLUDING DATASHEETS), DESIGN RESOURCES (INCLUDING REFERENCE DESIGNS), APPLICATION OR OTHER DESIGN ADVICE, WEB TOOLS, SAFETY INFORMATION, AND OTHER RESOURCES "AS IS" AND WITH ALL FAULTS, AND DISCLAIMS ALL WARRANTIES, EXPRESS AND IMPLIED, INCLUDING WITHOUT LIMITATION ANY IMPLIED WARRANTIES OF MERCHANTABILITY, FITNESS FOR A PARTICULAR PURPOSE OR NON-INFRINGEMENT OF THIRD PARTY INTELLECTUAL PROPERTY RIGHTS.

These resources are intended for skilled developers designing with TI products. You are solely responsible for (1) selecting the appropriate TI products for your application, (2) designing, validating and testing your application, and (3) ensuring your application meets applicable standards, and any other safety, security, regulatory or other requirements.

These resources are subject to change without notice. TI grants you permission to use these resources only for development of an application that uses the TI products described in the resource. Other reproduction and display of these resources is prohibited. No license is granted to any other TI intellectual property right or to any third party intellectual property right. TI disclaims responsibility for, and you fully indemnify TI and its representatives against any claims, damages, costs, losses, and liabilities arising out of your use of these resources.

TI's products are provided subject to [TI's Terms of Sale](#), [TI's General Quality Guidelines](#), or other applicable terms available either on [ti.com](#) or provided in conjunction with such TI products. TI's provision of these resources does not expand or otherwise alter TI's applicable warranties or warranty disclaimers for TI products. Unless TI explicitly designates a product as custom or customer-specified, TI products are standard, catalog, general purpose devices.

TI objects to and rejects any additional or different terms you may propose.

Copyright © 2026, Texas Instruments Incorporated

Last updated 10/2025