

# TPS55285 Buck-Boost Converter Evaluation Module



## Description

The TPS55285 integrates four MOSFETs providing a compact design for a variety of applications and is optimized for converting battery voltage, USB Power Delivery (USB PD) or adaptor voltage into power supply rails. Through the I<sup>2</sup>C interface, the output voltage can be programmed from 0.8V to 22V with 10mV step and the output current limit is programmable up to 6.35A with 50mA step, which is a good choice for USB PD applications. The TPS55285 has adjustable external loop compensation, programmable switching frequency, optional spread spectrum and rich protection features. All these features bring flexibility and design optimization for overall performance, as well as BOM optimization and design cost.

## Get Started

1. Order the EVM at [ti.com](https://www.ti.com).
2. Read the user's guide carefully.
3. Prepare the bench setup per instructions. Take precautions to prevent damage by ESD when handling the EVM.
4. Power the EVM by following the recommended steps.
5. Run tests and measurements. Take cautions of high voltage and hot temperature produced by the EVM during test.

## Features

- Wide input and output voltage range
- Programmable power supply (PPS) support
- I<sup>2</sup>C interface
- Programmable output voltage from 0.8V to 22V with 10mV step
- Programmable output current limit up to 6.35A with 50mA step
- Forced discharge function
- User flexibilities in optimizing loop compensation
- Programmable PFM and FPWM mode at light load
- Optional programmable spread spectrum
- Adjustable output voltage compensation for voltage droop over the cable
- Rich protection features
- Small solution-size

## Applications

- [USB PD](#)
- [Wireless charger](#)
- [Docking Station](#)
- [Notebook computer](#)
- [SSD](#)

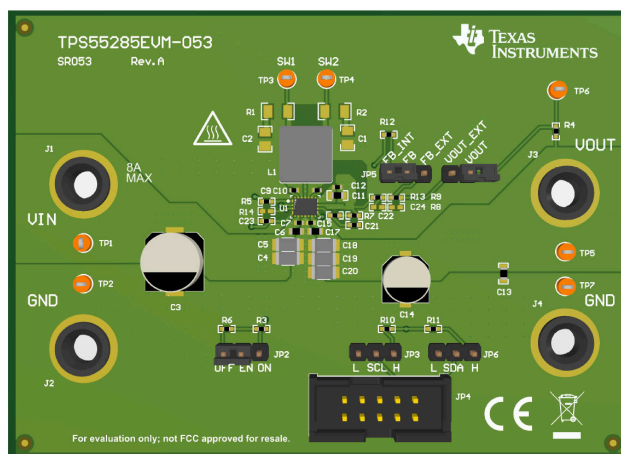

# 1 Evaluation Module Overview

## 1.1 Introduction

The TPS55285EVM-053 is designed to demonstrate the features and functionality of the TPS55285 device, which is a high-performance, high-efficiency synchronous buck-boost converter with I<sup>2</sup>C interface. The TPS55285 also verifies safe operating with optional output current limit and hiccup-mode protection in sustained overload conditions. The operation status can be read through the I<sup>2</sup>C interface to know if SCP/OCP/OVP is triggered.

This user's guide describes the characteristics and operation of the evaluation module TPS55285EVM-053. This document provides instructions on how to use the evaluation module. Throughout this document, the terms of evaluation board, evaluation module, and EVM are synonymous with the TPS55285EVM-053. This document also includes a schematic, reference printed circuit board (PCB) layout, and a complete bill of materials (BOM).

**CAUTION**



Hot surface! Contact can cause burns. Do not touch!

## 1.2 Kit Contents

Table 1-1 details the contents of the EVM kit.

**Table 1-1. EVM Kit Contents**

ITEM	QUANTITY
TPS55285EVM-053	1

## 1.3 Specification

Table 1-2 provides a summary of the TPS55285 EVM performance specifications. All specifications are given for an ambient temperature of 25°C.

**Table 1-2. Performance Specification Summary**

Parameter	Test Condition	Value	Unit
Input voltage		2.4–22	V
Output voltage		0.8–22	V
Maximum output current	$V_{IN} \geq 5V, V_{OUT} = 10V$	3	A
	$V_{IN} \geq 6V, V_{OUT} = 12V$		
	$V_{IN} \geq 12V, V_{OUT} = 20V$		
Default switching frequency		400	kHz

## 1.4 Device Information

The TPS55285 is a synchronous buck-boost converter which integrates four MOSFET switches, providing a compact device for a variety of applications, especially for USB Power Delivery (USB PD) application. The device has up to 22V input voltage capability. Through the I<sup>2</sup>C interface, the output voltage can be programmed from 0.8V to 22V with 10mV step, and the output current limit can be programmed up to 6.35A with 50mA step. The switching frequency is set by FSW bit in register 06H with four options: 400kHz, 800kHz, 1.6MHz, 2.2MHz. The spread spectrum function is optional to minimize peak EMI. The input/output over-voltage protection, average inductor current limit, cycle-by-cycle peak current limit, and output short circuit protection are provided. Refer to [TPS55285 22-V, 8-A Buck-Boost Converter with I<sup>2</sup>C Interface Data Sheet](#) for more detailed information of the TPS55285 fully integrated buck-boost converter.

The factory default settings of the TPS55285EVM allow the operation with an input voltage range from 2.4V to 22V. Fine-tuning of the output voltage can be realized by adjusting the internal reference voltage and feedback ratio. In addition, users can set register to adjust the switching frequency. To meet the current ripple requirement, the inductor also needs to change according to the switching frequency, as well as the external compensation parameter to obtain enough phase margin and gain margin.

## 2 Hardware

This section describes how to properly connect, set up, and use the TPS55285EVM-053.

### 2.1 Modification

This EVM requires an appropriate I<sup>2</sup>C interface, such as the TI [USB2ANY](#), to configure the TPS55285. The external components can be changed by the user according to the real application.

### 2.2 Connector, Test Point, and Jumper Descriptions

This section describes how to properly connect, set up, and use the TPS55285EVM-053.

#### 2.2.1 Connector and Test Point Descriptions

This EVM includes I/O connectors and test points as shown in [Table 2-1](#). The power supply must be connected to input connectors, J1 and J2. The load must be connected to output connectors, J3 and J4.

**Table 2-1. Connectors and Test Points**

Reference Designator	Description
J1	Input voltage positive connection
J2	Input voltage return connection
J3	Output voltage connection
J4	Output voltage return connection
JP4	I <sup>2</sup> C connector

#### 2.2.2 Jumper Configuration

##### 2.2.2.1 JP2 (ENABLE)

The JP2 jumper enables the device. By default, this jumper is set to the OFF position. If  $V_{in} > 5.1V$ , put this jumper in the ON position to enable the output. Put this jumper in the OFF position to disable the output. If  $V_{in} < 5.1V$ , connect EN to an external 3V power supply or adjust R3, R6 resistor values according to datasheet EV/UVLO function description, note that EN/UVLO pin max voltage is 6V.

### 2.2.2.2 JP5 and JP1 (External Feedback and Internal Feedback Selection)

The JP5 jumper is for the external feedback or the internal feedback selection. By default, this jumper is set to the FB\_INT position. Place this jumper in the FB\_EXT position for the external output voltage feedback.

The JP1 jumper is for the external feedback connection. Place a jumper across JP1 when using external feedback. Leave JP1 open when using internal feedback.

When using external output voltage feedback, the output voltage is determined by [Equation 1](#):

$$V_{OUT} = V_{REF} \times \left( 1 + \frac{R_{FB\_UP}}{R_{FB\_BT}} \right) \quad (1)$$

TI recommends to use 100 kΩ for the up resistor,  $R_{FB\_UP}$ . The reference voltage,  $V_{REF}$ , at the FB/INT pin is programmable from 45 mV to 1.2 V by writing a 11-bit data into registers 00H and 01H.

## 2.3 Test Procedure

1. Set the power supply current limit to 10A. Set the power supply to approximately 12V. Turn off the power supply. Connect the positive output of the power supply to J1 and the negative output to J2.
2. Connect the load to J3 for the positive connection and connect the load J4 for the negative connection.
3. Turn on the power supply.
4. Set the JP2 jumper across EN and ON. Enable the IC with the GUI. The default output voltage is 5V.
5. Set the output voltage to the target value on the GUI user interface page.
6. Slowly increase the load while monitoring the output voltage between J3 and J4. The output voltage must remain in regulation when the load current is lower than 5A.
7. Slowly sweep the input voltage from 5.5V to 20V. The output voltage must remain in regulation when the load current is lower than the maximum load current specified in [Table 1-2](#).
8. Turn off the load and power supply. Then, turn on the load to discharge the output capacitors.

## 3 Software

### 3.1 Software User Interface

#### 3.1.1 Install USB2ANY Explorer

Download and install the USB2ANY explorer from <http://www.ti.com/tool/USB2ANY>. Upgrade the firmware version to 2.8.2.0.

#### 3.1.2 GUI Installation

A graphical user interface (GUI) is available from [www.dev.ti.com](http://www.dev.ti.com). The GUI allows simple and convenient programming of the device through the TI USB2ANY device.

1. Download the zip file for the desired platform.
2. Download GUI Composer Runtime.
3. Extract the zip folder and install the GUI.
4. Run through the installation steps. The installation wizard shows a prompt for GUI Composer Runtime. This is done automatically.
5. Open the GUI – TPS55285.

#### 3.1.3 Interface Hardware Setup

Connect the USB2ANY adapter to your PC using the supplied USB cable. Connect the TPS55285EVM connector JP4 to the USB2ANY adapter using the supplied 10-pin ribbon cable. The connectors on the ribbon cable are keyed to prevent incorrect installation.

Figure 3-1 shows a quick connection overview.

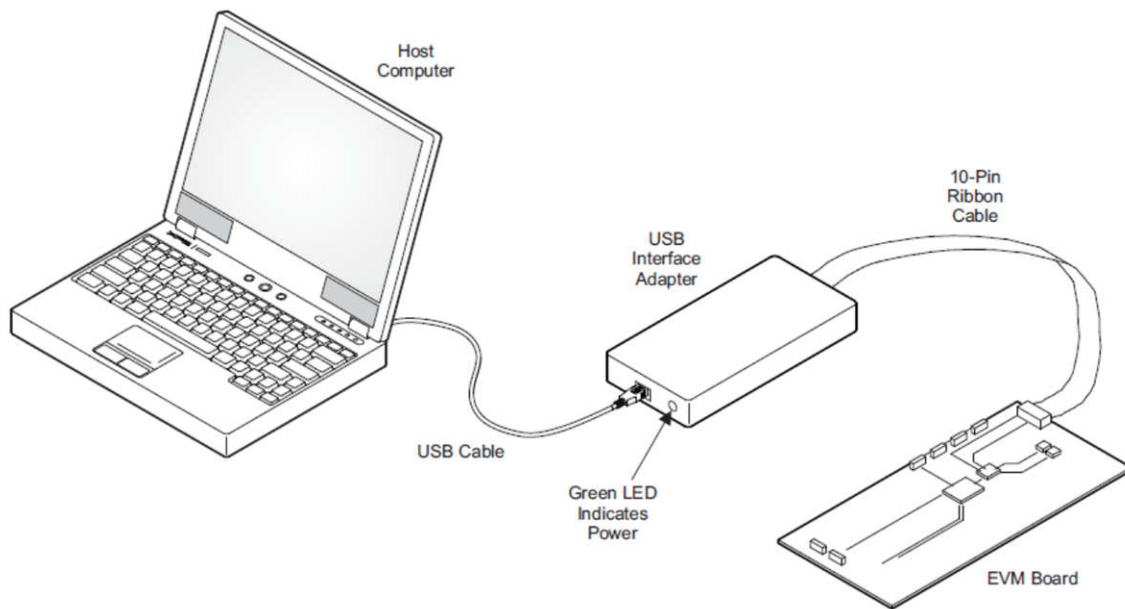

Figure 3-1. Quick Connection Overview

### 3.1.4 User Interface Operation

The TPS55285EVM board can be enabled to work by the following steps:

1. Turn on the power supply.
2. If  $V_{in} > 5.1V$ , put JP2 in the ON position to enable the output. If  $V_{in} < 5.1V$ , connect EN to an external 3V power supply or adjust R3, R6 resistor values to enable the output.
3. Open the TPS55285EVM GUI.
4. Click the auto connect button on the target address widget (Figure 3-2). This automatically checks for target addresses (0x74, 0x75) and connect the GUI with the device. After the GUI and device are connected, the GUI reads all eight registers and shows a notification (Figure 3-3).

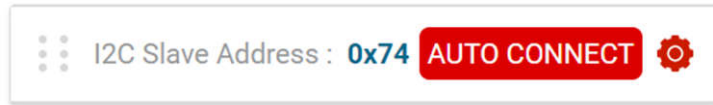

Figure 3-2. GUI Auto Connect Button



Figure 3-3. GUI Auto Connect Notification

5. Click the start button. This shows the GUI user interface of TPS55285EVM-053 (Figure 3-4).

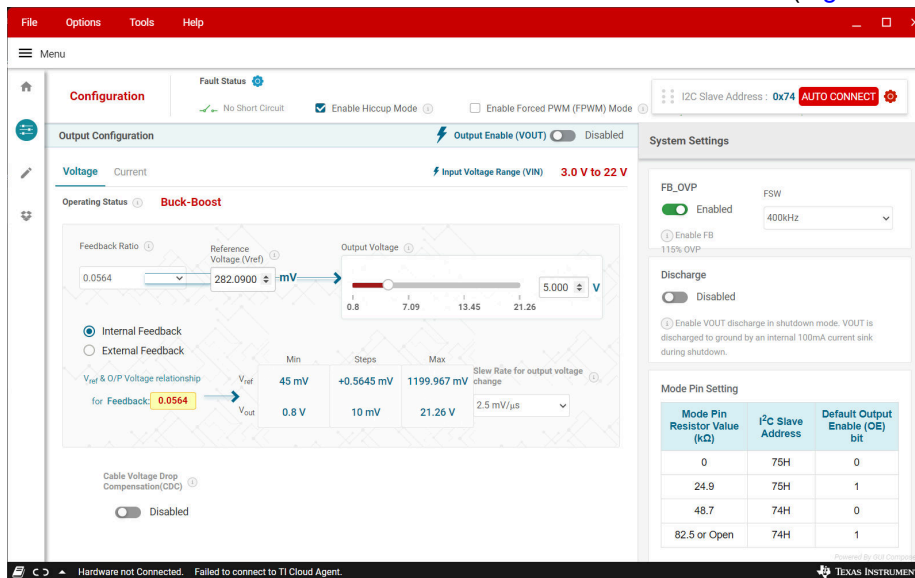

Figure 3-4. GUI User Interface of TPS55285EVM-053

6. Click the Enable button (Figure 3-5). The default output voltage is 5V.

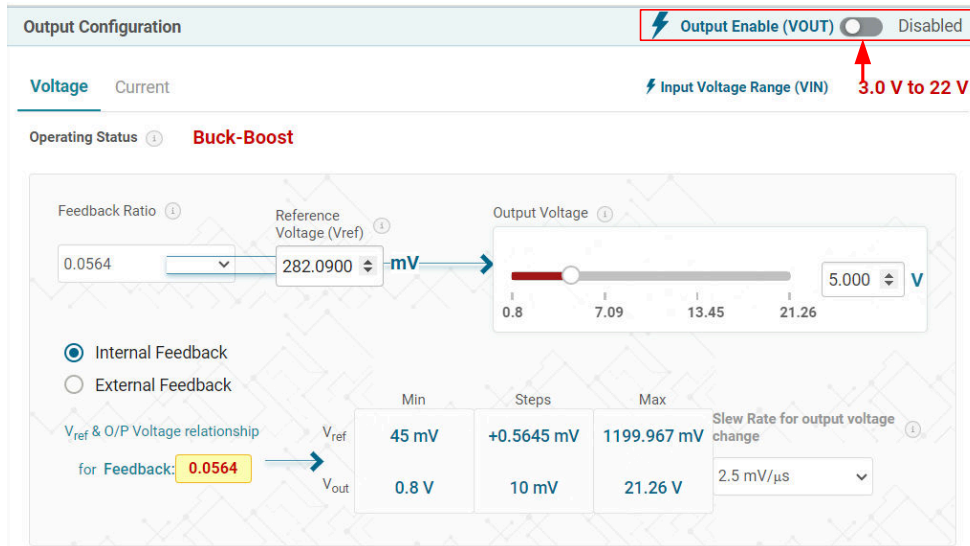
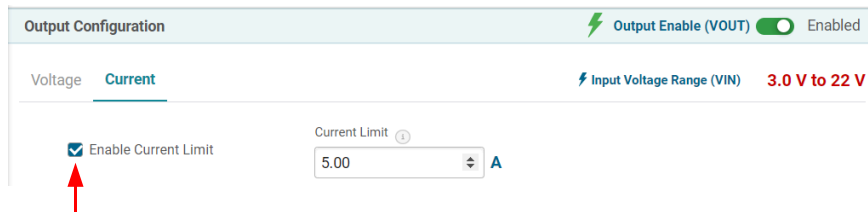

Figure 3-5. ENABLE Button

- Set the output voltage, current limit point, and so forth according to the design target. If the maximum load current is  $\geq 5A$ , then uncheck the *Enable Current Limit* check box or increase the current limit value (Figure 3-6).



When  $I_{out} \geq 5A$ : untick the Enable Current Limit check box or increase the current limit value

Figure 3-6. Output Current Limit Point Setting

### 3.1.5 Register Map Screen

The Register Map screen shows a register-wise view of all parameters. Here, single registers can be read or written to the device (if applicable). Refer to the [TPS55285 22-V, 8-A Buck-Boost Converter with I<sup>2</sup>C Interface Data Sheet](#) for a detailed description of the TPS55285 registers.

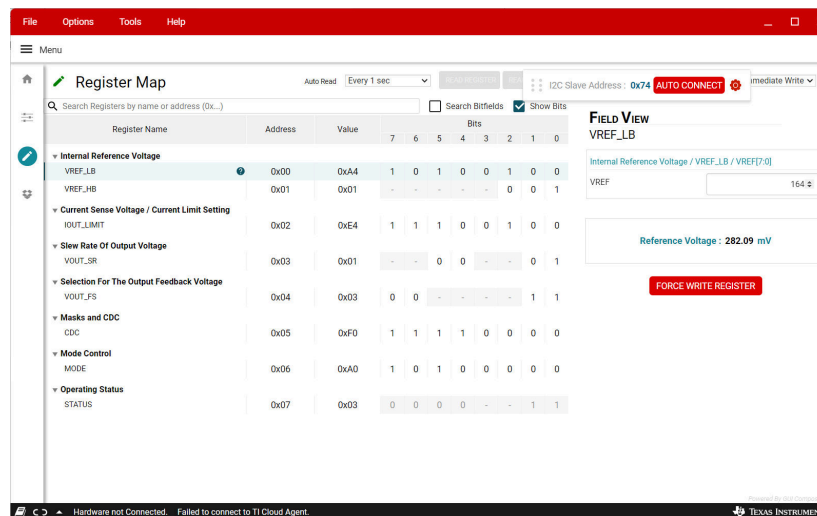

Figure 3-7. GUI Register Map Screen



## 4 Hardware Design Files

This section provides the TPS55285EVM-053 schematic, board layout and bill of materials (BOM).

### 4.1 Schematic

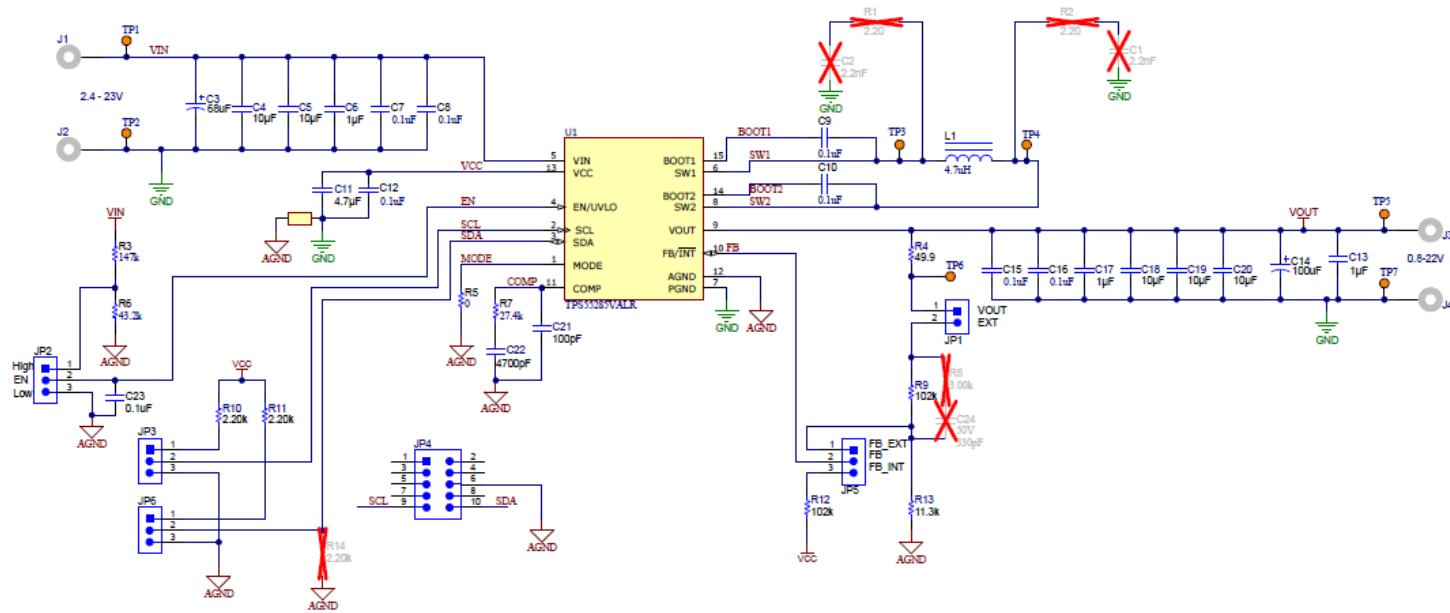

Figure 4-1. TPS55285EVM-053 Schematic

## 4.2 PCB Layouts

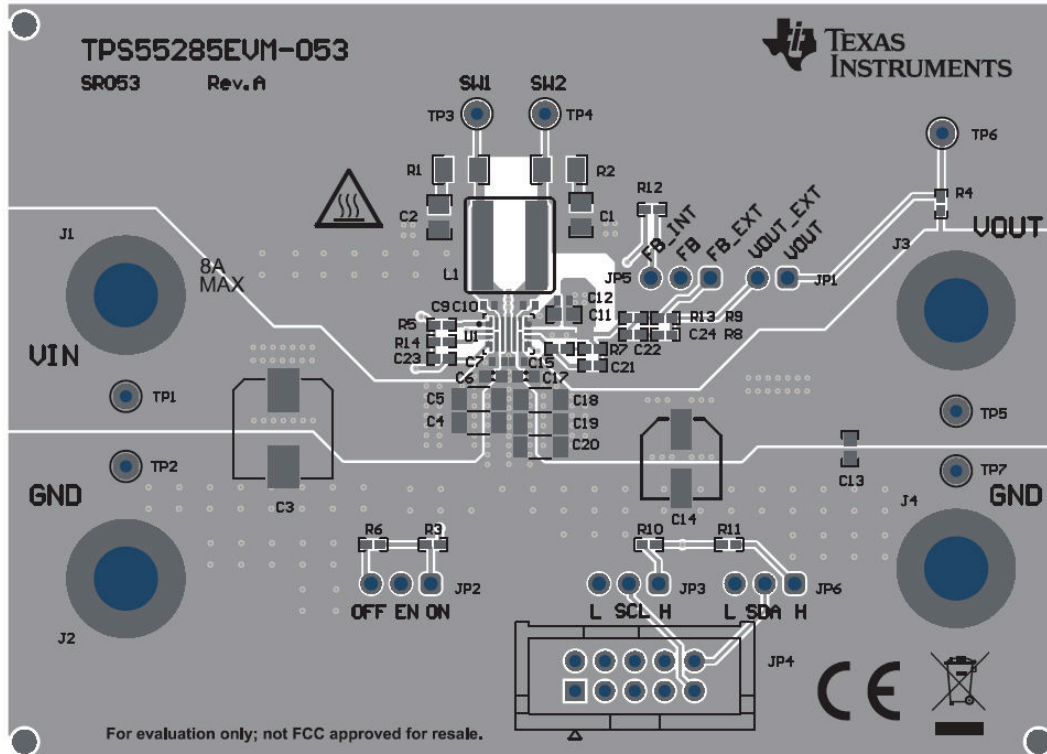

Figure 4-2. TPS55285EVM-053 Top-Side Layout

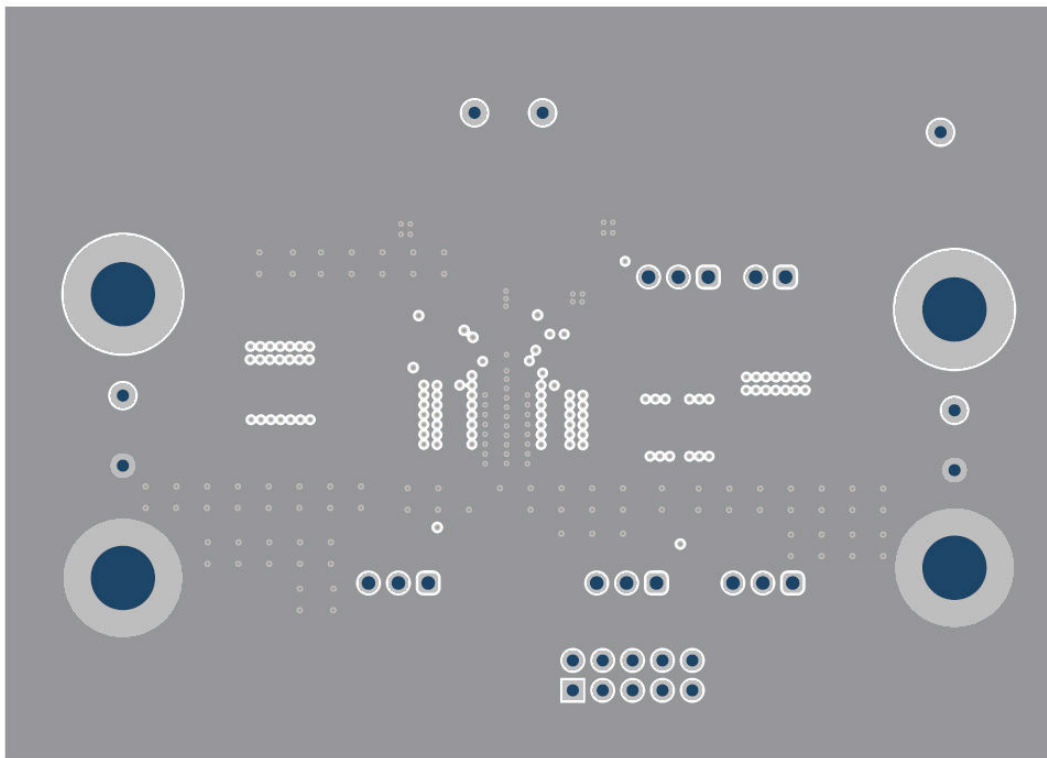

Figure 4-3. TPS55285EVM-053 Inner Layer1

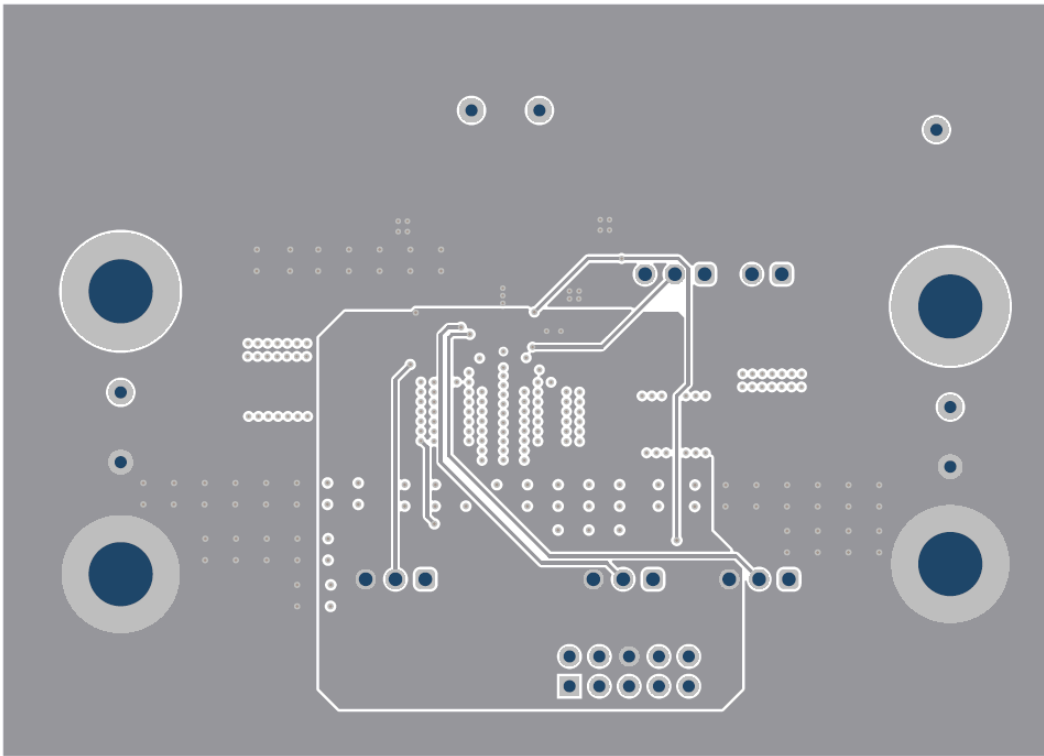

Figure 4-4. TPS55285EVM-053 Inner Layer2

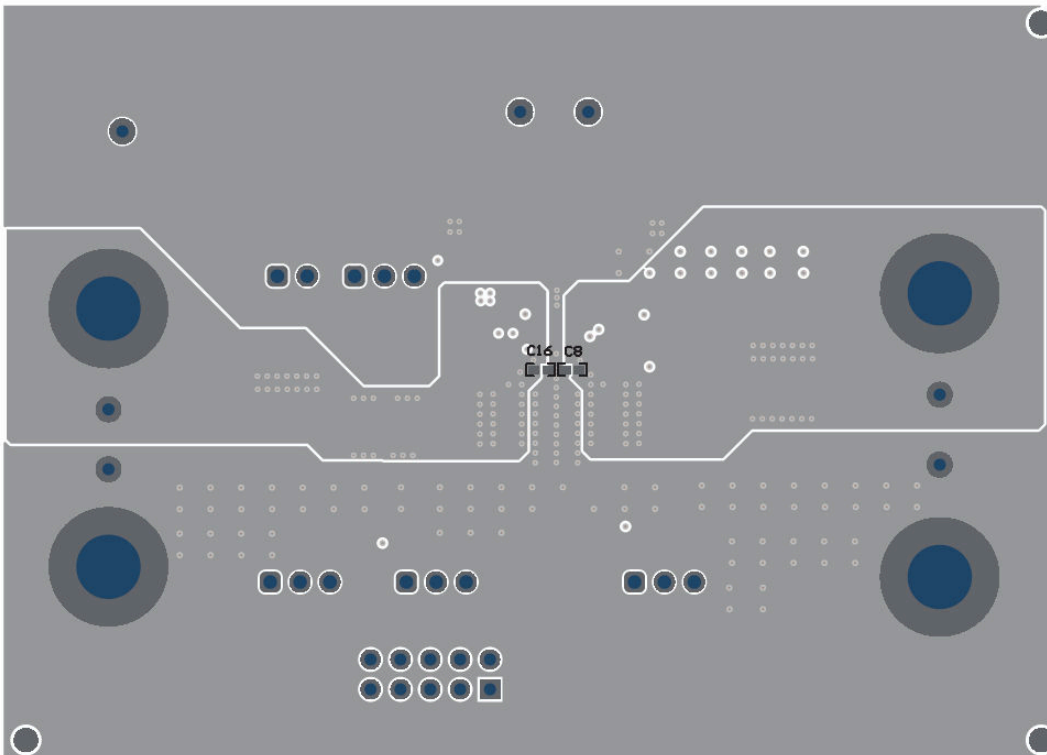

Figure 4-5. TPS55285EVM-053 Bottom-Side Layout

### 4.3 Bill of Materials

**Table 4-1. Bill of Materials**

Designator	Qty	Value	Description	Package	Part Number	Manufacturer
C3	1	68uF	CAP, Polymer Hybrid, 68uF, 50V, +/- 20%, 30ohm, 8x10 SMD	8x10	EEHZA1H680P	Panasonic
C4, C5, C18, C19, C20	5	10uF	CAP, CERM, 10µF, 50V,+/- 10%, X7R, AEC-Q200 Grade 1, 1206	1206	CGA5L1X7R1H106K160AC	TDK
C6, C13, C17	3	1uF	CAP, CERM, 1µF, 50V,+/- 20%, X5R, AEC-Q200 Grade 3, 0603	0603	GRT188R61H105ME13D	MuRata
C7, C8, C9, C10, C12, C15, C16	7	0.1uF	CAP, CERM, 0.1uF, 50V, +/- 20%, X7R, 0402	0402	GRM155R71H104ME14D	MuRata
C11	1	4.7uF	CAP, CERM, 4.7µF, 16V,+/- 10%, X5R, AEC-Q200 Grade 3, 0603	0603	GRT188R61C475KE13D	MuRata
C14	1	100uF	CAP, AL, 100uF, 35V, AEC-Q200 Grade 2, SMD	D6.3xL5.8mm	EEHZK1V101XP	Panasonic
C21	1	100pF	CAP, CERM, 100pF, 50V, +/- 5%, C0G/NP0, AEC-Q200 Grade 1, 0402	0402	CGA2B2C0G1H101J050BA	TDK
C22	1	4700pF	CAP, CERM, 4700pF, 50V, +/- 10%, X7R, AEC-Q200 Grade 1, 0402	0402	CGA2B2X7R1H472K050BA	TDK
C23	1	0.1uF	CAP, CERM, 0.1uF, 50V, +/- 10%, X7R, AEC-Q200 Grade 1, 0402	0402	CGA2B3X7R1H104K050BB	TDK
FID1, FID4, FID5, FID6	4		Fiducial mark. There is nothing to buy or mount.	N/A	N/A	N/A
J1, J2, J3, J4	4		Standard Banana Jack, Uninsulated, 6.73mm	Standard Banana Jack, Uninsulated, 6.73mm	575-6	Keystone
JP1	1		Header, 2.54mm, 2x1, Gold, TH	Header, 2.54mm, 2x1, TH	61300211121	Würth Elektronik
JP2, JP3, JP5, JP6	4		Header, 2.54mm, 3x1, Gold, TH	Header, 2.54mm, 3x1, TH	61300311121	Würth Elektronik
JP4	1		Header (shrouded), 100mil, 5x2, Gold, TH	5x2 Shrouded header	5103308-1	TE Connectivity
L1	1	4.7uH	Inductor, Shielded, Composite, 4.7uH, 13.6A, 0.01ohm, SMD	7.2x7x7.5mm	XAL7070-472MEB	Coilcraft
R3	1	147k	RES, 147k, 1%, 0.063 W, AEC-Q200 Grade 0, 0402	0402	CRCW0402147KFKE D	Vishay-Dale
R4	1	49.9	RES, 49.9, 1%, 0.063 W, AEC-Q200 Grade 0, 0402	0402	CRCW040249R9FK ED	Vishay-Dale
R5	1	0	RES, 0, 5%, 0.063 W, AEC-Q200 Grade 0, 0402	0402	CRCW04020000Z0E D	Vishay-Dale
R6	1	43.2k	RES, 43.2k, 1%, 0.063 W, AEC-Q200 Grade 0, 0402	0402	CRCW040243K2FKE D	Vishay-Dale

**Table 4-1. Bill of Materials (continued)**

Designator	Qty	Value	Description	Package	Part Number	Manufacturer
R7	1	27.4k	RES, 27.4k, 1%, 0.063 W, AEC-Q200 Grade 0, 0402	0402	CRCW040227K4FKE D	Vishay-Dale
R9, R12	2	102k	RES, 102k, 1%, 0.063 W, AEC-Q200 Grade 0, 0402	0402	CRCW0402102KFKE D	Vishay-Dale
R10, R11	2	2.20k	RES, 2.20k, 1%, 0.063 W, AEC-Q200 Grade 0, 0402	0402	CRCW04022K20FKE D	Vishay-Dale
R13	1	11.3k	RES, 11.3k, 1%, 0.063 W, AEC-Q200 Grade 0, 0402	0402	CRCW040211K3FKE D	Vishay-Dale
SH-JP1, SH-JP2, SH-JP3	3		Shunt, 100mil, Gold plated, Black	Shunt 2 pos. 100 mil	881545-2	TE Connectivity
TP1, TP2, TP3, TP4, TP5, TP6, TP7	7		Test Point, Miniature, Orange, TH	Orange Miniature Testpoint	5003	Keystone Electronics
U1	1		TPS55285VALR	WQFN-HR15	TPS55285VALR	Texas Instruments
C1, C2	0	2200pF	CAP, CERM, 2200pF, 250V, +/- 10%, X7R, 0805	0805	GRM21AR72E222K W01D	MuRata
C24	0	330pF	CAP, CERM, 330pF, 50V, +/- 10%, X7R, AEC-Q200 Grade 1, 0402	0402	CGA2B2X7R1H331K 050BA	TDK
FID2, FID3	0		Fiducial mark. There is nothing to buy or mount.	N/A	N/A	N/A
R1, R2	0	2.2	RES, 2.20, 1%, 0.25 W, AEC-Q200 Grade 0, 1206	1206	ERJ-8RQF2R2V	Panasonic
R8	0	3.00k	RES, 3.00k, 1%, 0.063 W, AEC-Q200 Grade 0, 0402	0402	CRCW04023K00FKE D	Vishay-Dale
R14	0	2.20k	RES, 2.20 k, 1%, 0.063 W, AEC-Q200 Grade 0, 0402	0402	CRCW04022K20FKE D	Vishay-Dale

## **5 Additional Information**

### **Trademarks**

All trademarks are the property of their respective owners.

## STANDARD TERMS FOR EVALUATION MODULES

1. *Delivery:* TI delivers TI evaluation boards, kits, or modules, including any accompanying demonstration software, components, and/or documentation which may be provided together or separately (collectively, an "EVM" or "EVMs") to the User ("User") in accordance with the terms set forth herein. User's acceptance of the EVM is expressly subject to the following terms.
  - 1.1 EVMs are intended solely for product or software developers for use in a research and development setting to facilitate feasibility evaluation, experimentation, or scientific analysis of TI semiconductor products. EVMs have no direct function and are not finished products. EVMs shall not be directly or indirectly assembled as a part or subassembly in any finished product. For clarification, any software or software tools provided with the EVM ("Software") shall not be subject to the terms and conditions set forth herein but rather shall be subject to the applicable terms that accompany such Software
  - 1.2 EVMs are not intended for consumer or household use. EVMs may not be sold, sublicensed, leased, rented, loaned, assigned, or otherwise distributed for commercial purposes by Users, in whole or in part, or used in any finished product or production system.
2. *Limited Warranty and Related Remedies/Disclaimers:*
  - 2.1 These terms do not apply to Software. The warranty, if any, for Software is covered in the applicable Software License Agreement.
  - 2.2 TI warrants that the TI EVM will conform to TI's published specifications for ninety (90) days after the date TI delivers such EVM to User. Notwithstanding the foregoing, TI shall not be liable for a nonconforming EVM if (a) the nonconformity was caused by neglect, misuse or mistreatment by an entity other than TI, including improper installation or testing, or for any EVMs that have been altered or modified in any way by an entity other than TI, (b) the nonconformity resulted from User's design, specifications or instructions for such EVMs or improper system design, or (c) User has not paid on time. Testing and other quality control techniques are used to the extent TI deems necessary. TI does not test all parameters of each EVM. User's claims against TI under this Section 2 are void if User fails to notify TI of any apparent defects in the EVMs within ten (10) business days after delivery, or of any hidden defects with ten (10) business days after the defect has been detected.
  - 2.3 TI's sole liability shall be at its option to repair or replace EVMs that fail to conform to the warranty set forth above, or credit User's account for such EVM. TI's liability under this warranty shall be limited to EVMs that are returned during the warranty period to the address designated by TI and that are determined by TI not to conform to such warranty. If TI elects to repair or replace such EVM, TI shall have a reasonable time to repair such EVM or provide replacements. Repaired EVMs shall be warranted for the remainder of the original warranty period. Replaced EVMs shall be warranted for a new full ninety (90) day warranty period.

### **WARNING**

**Evaluation Kits are intended solely for use by technically qualified, professional electronics experts who are familiar with the dangers and application risks associated with handling electrical mechanical components, systems, and subsystems.**

**User shall operate the Evaluation Kit within TI's recommended guidelines and any applicable legal or environmental requirements as well as reasonable and customary safeguards. Failure to set up and/or operate the Evaluation Kit within TI's recommended guidelines may result in personal injury or death or property damage. Proper set up entails following TI's instructions for electrical ratings of interface circuits such as input, output and electrical loads.**

**NOTE:**

**EXPOSURE TO ELECTROSTATIC DISCHARGE (ESD) MAY CAUSE DEGRADATION OR FAILURE OF THE EVALUATION KIT; TI RECOMMENDS STORAGE OF THE EVALUATION KIT IN A PROTECTIVE ESD BAG.**

### 3 Regulatory Notices:

#### 3.1 United States

##### 3.1.1 Notice applicable to EVMs not FCC-Approved:

**FCC NOTICE:** This kit is designed to allow product developers to evaluate electronic components, circuitry, or software associated with the kit to determine whether to incorporate such items in a finished product and software developers to write software applications for use with the end product. This kit is not a finished product and when assembled may not be resold or otherwise marketed unless all required FCC equipment authorizations are first obtained. Operation is subject to the condition that this product not cause harmful interference to licensed radio stations and that this product accept harmful interference. Unless the assembled kit is designed to operate under part 15, part 18 or part 95 of this chapter, the operator of the kit must operate under the authority of an FCC license holder or must secure an experimental authorization under part 5 of this chapter.

##### 3.1.2 For EVMs annotated as FCC – FEDERAL COMMUNICATIONS COMMISSION Part 15 Compliant:

#### **CAUTION**

This device complies with part 15 of the FCC Rules. Operation is subject to the following two conditions: (1) This device may not cause harmful interference, and (2) this device must accept any interference received, including interference that may cause undesired operation.

Changes or modifications not expressly approved by the party responsible for compliance could void the user's authority to operate the equipment.

#### **FCC Interference Statement for Class A EVM devices**

*NOTE: This equipment has been tested and found to comply with the limits for a Class A digital device, pursuant to part 15 of the FCC Rules. These limits are designed to provide reasonable protection against harmful interference when the equipment is operated in a commercial environment. This equipment generates, uses, and can radiate radio frequency energy and, if not installed and used in accordance with the instruction manual, may cause harmful interference to radio communications. Operation of this equipment in a residential area is likely to cause harmful interference in which case the user will be required to correct the interference at his own expense.*

#### **FCC Interference Statement for Class B EVM devices**

*NOTE: This equipment has been tested and found to comply with the limits for a Class B digital device, pursuant to part 15 of the FCC Rules. These limits are designed to provide reasonable protection against harmful interference in a residential installation. This equipment generates, uses and can radiate radio frequency energy and, if not installed and used in accordance with the instructions, may cause harmful interference to radio communications. However, there is no guarantee that interference will not occur in a particular installation. If this equipment does cause harmful interference to radio or television reception, which can be determined by turning the equipment off and on, the user is encouraged to try to correct the interference by one or more of the following measures:*

- Reorient or relocate the receiving antenna.
- Increase the separation between the equipment and receiver.
- Connect the equipment into an outlet on a circuit different from that to which the receiver is connected.
- Consult the dealer or an experienced radio/TV technician for help.

#### 3.2 Canada

##### 3.2.1 For EVMs issued with an Industry Canada Certificate of Conformance to RSS-210 or RSS-247

#### **Concerning EVMs Including Radio Transmitters:**

This device complies with Industry Canada license-exempt RSSs. Operation is subject to the following two conditions:

(1) this device may not cause interference, and (2) this device must accept any interference, including interference that may cause undesired operation of the device.

#### **Concernant les EVMs avec appareils radio:**

Le présent appareil est conforme aux CNR d'Industrie Canada applicables aux appareils radio exempts de licence. L'exploitation est autorisée aux deux conditions suivantes: (1) l'appareil ne doit pas produire de brouillage, et (2) l'utilisateur de l'appareil doit accepter tout brouillage radioélectrique subi, même si le brouillage est susceptible d'en compromettre le fonctionnement.

#### **Concerning EVMs Including Detachable Antennas:**

Under Industry Canada regulations, this radio transmitter may only operate using an antenna of a type and maximum (or lesser) gain approved for the transmitter by Industry Canada. To reduce potential radio interference to other users, the antenna type and its gain should be so chosen that the equivalent isotropically radiated power (e.i.r.p.) is not more than that necessary for successful communication. This radio transmitter has been approved by Industry Canada to operate with the antenna types listed in the user guide with the maximum permissible gain and required antenna impedance for each antenna type indicated. Antenna types not included in this list, having a gain greater than the maximum gain indicated for that type, are strictly prohibited for use with this device.



### Concernant les EVMs avec antennes détachables

Conformément à la réglementation d'Industrie Canada, le présent émetteur radio peut fonctionner avec une antenne d'un type et d'un gain maximal (ou inférieur) approuvé pour l'émetteur par Industrie Canada. Dans le but de réduire les risques de brouillage radioélectrique à l'intention des autres utilisateurs, il faut choisir le type d'antenne et son gain de sorte que la puissance isotrope rayonnée équivalente (p.i.r.e.) ne dépasse pas l'intensité nécessaire à l'établissement d'une communication satisfaisante. Le présent émetteur radio a été approuvé par Industrie Canada pour fonctionner avec les types d'antenne énumérés dans le manuel d'usage et ayant un gain admissible maximal et l'impédance requise pour chaque type d'antenne. Les types d'antenne non inclus dans cette liste, ou dont le gain est supérieur au gain maximal indiqué, sont strictement interdits pour l'exploitation de l'émetteur.

#### 3.3 Japan

3.3.1 *Notice for EVMs delivered in Japan:* Please see [http://www.tij.co.jp/lstds/ti\\_ja/general/eStore/notice\\_01.page](http://www.tij.co.jp/lstds/ti_ja/general/eStore/notice_01.page) 日本国内に輸入される評価用キット、ボードについては、次のところをご覧ください。

<https://www.ti.com/ja-jp/legal/notice-for-evaluation-kits-delivered-in-japan.html>

3.3.2 *Notice for Users of EVMs Considered "Radio Frequency Products" in Japan:* EVMs entering Japan may not be certified by TI as conforming to Technical Regulations of Radio Law of Japan.

If User uses EVMs in Japan, not certified to Technical Regulations of Radio Law of Japan, User is required to follow the instructions set forth by Radio Law of Japan, which includes, but is not limited to, the instructions below with respect to EVMs (which for the avoidance of doubt are stated strictly for convenience and should be verified by User):

1. Use EVMs in a shielded room or any other test facility as defined in the notification #173 issued by Ministry of Internal Affairs and Communications on March 28, 2006, based on Sub-section 1.1 of Article 6 of the Ministry's Rule for Enforcement of Radio Law of Japan,
2. Use EVMs only after User obtains the license of Test Radio Station as provided in Radio Law of Japan with respect to EVMs, or
3. Use of EVMs only after User obtains the Technical Regulations Conformity Certification as provided in Radio Law of Japan with respect to EVMs. Also, do not transfer EVMs, unless User gives the same notice above to the transferee. Please note that if User does not follow the instructions above, User will be subject to penalties of Radio Law of Japan.

【無線電波を送信する製品の開発キットをお使いになる際の注意事項】 開発キットの中には技術基準適合証明を受けていないものがあります。技術適合証明を受けていないものご使用に際しては、電波法遵守のため、以下のいずれかの措置を取っていただく必要がありますのでご注意ください。

1. 電波法施行規則第6条第1項第1号に基づく平成18年3月28日総務省告示第173号で定められた電波暗室等の試験設備でご使用いただく。
2. 実験局の免許を取得後ご使用いただく。
3. 技術基準適合証明を取得後ご使用いただく。

なお、本製品は、上記の「ご使用にあたっての注意」を譲渡先、移転先に通知しない限り、譲渡、移転できないものとします。

上記を遵守頂けない場合は、電波法の罰則が適用される可能性があることをご留意ください。日本テキサス・イ

ンスツルメンツ株式会社

東京都新宿区西新宿 6 丁目 2 4 番 1 号

西新宿三井ビル

3.3.3 *Notice for EVMs for Power Line Communication:* Please see [http://www.tij.co.jp/lstds/ti\\_ja/general/eStore/notice\\_02.page](http://www.tij.co.jp/lstds/ti_ja/general/eStore/notice_02.page)

電力線搬送波通信についての開発キットをお使いになる際の注意事項については、次のところをご覧ください。 <https://www.ti.com/ja-jp/legal/notice-for-evaluation-kits-for-power-line-communication.html>

#### 3.4 European Union

3.4.1 *For EVMs subject to EU Directive 2014/30/EU (Electromagnetic Compatibility Directive):*

This is a class A product intended for use in environments other than domestic environments that are connected to a low-voltage power-supply network that supplies buildings used for domestic purposes. In a domestic environment this product may cause radio interference in which case the user may be required to take adequate measures.

- 
4. *EVM Use Restrictions and Warnings:*
    - 4.1 EVMS ARE NOT FOR USE IN FUNCTIONAL SAFETY AND/OR SAFETY CRITICAL EVALUATIONS, INCLUDING BUT NOT LIMITED TO EVALUATIONS OF LIFE SUPPORT APPLICATIONS.
    - 4.2 User must read and apply the user guide and other available documentation provided by TI regarding the EVM prior to handling or using the EVM, including without limitation any warning or restriction notices. The notices contain important safety information related to, for example, temperatures and voltages.
    - 4.3 *Safety-Related Warnings and Restrictions:*
      - 4.3.1 User shall operate the EVM within TI's recommended specifications and environmental considerations stated in the user guide, other available documentation provided by TI, and any other applicable requirements and employ reasonable and customary safeguards. Exceeding the specified performance ratings and specifications (including but not limited to input and output voltage, current, power, and environmental ranges) for the EVM may cause personal injury or death, or property damage. If there are questions concerning performance ratings and specifications, User should contact a TI field representative prior to connecting interface electronics including input power and intended loads. Any loads applied outside of the specified output range may also result in unintended and/or inaccurate operation and/or possible permanent damage to the EVM and/or interface electronics. Please consult the EVM user guide prior to connecting any load to the EVM output. If there is uncertainty as to the load specification, please contact a TI field representative. During normal operation, even with the inputs and outputs kept within the specified allowable ranges, some circuit components may have elevated case temperatures. These components include but are not limited to linear regulators, switching transistors, pass transistors, current sense resistors, and heat sinks, which can be identified using the information in the associated documentation. When working with the EVM, please be aware that the EVM may become very warm.
      - 4.3.2 EVMs are intended solely for use by technically qualified, professional electronics experts who are familiar with the dangers and application risks associated with handling electrical mechanical components, systems, and subsystems. User assumes all responsibility and liability for proper and safe handling and use of the EVM by User or its employees, affiliates, contractors or designees. User assumes all responsibility and liability to ensure that any interfaces (electronic and/or mechanical) between the EVM and any human body are designed with suitable isolation and means to safely limit accessible leakage currents to minimize the risk of electrical shock hazard. User assumes all responsibility and liability for any improper or unsafe handling or use of the EVM by User or its employees, affiliates, contractors or designees.
    - 4.4 User assumes all responsibility and liability to determine whether the EVM is subject to any applicable international, federal, state, or local laws and regulations related to User's handling and use of the EVM and, if applicable, User assumes all responsibility and liability for compliance in all respects with such laws and regulations. User assumes all responsibility and liability for proper disposal and recycling of the EVM consistent with all applicable international, federal, state, and local requirements.
  5. *Accuracy of Information:* To the extent TI provides information on the availability and function of EVMs, TI attempts to be as accurate as possible. However, TI does not warrant the accuracy of EVM descriptions, EVM availability or other information on its websites as accurate, complete, reliable, current, or error-free.
  6. *Disclaimers:*
    - 6.1 EXCEPT AS SET FORTH ABOVE, EVMS AND ANY MATERIALS PROVIDED WITH THE EVM (INCLUDING, BUT NOT LIMITED TO, REFERENCE DESIGNS AND THE DESIGN OF THE EVM ITSELF) ARE PROVIDED "AS IS" AND "WITH ALL FAULTS." TI DISCLAIMS ALL OTHER WARRANTIES, EXPRESS OR IMPLIED, REGARDING SUCH ITEMS, INCLUDING BUT NOT LIMITED TO ANY EPIDEMIC FAILURE WARRANTY OR IMPLIED WARRANTIES OF MERCHANTABILITY OR FITNESS FOR A PARTICULAR PURPOSE OR NON-INFRINGEMENT OF ANY THIRD PARTY PATENTS, COPYRIGHTS, TRADE SECRETS OR OTHER INTELLECTUAL PROPERTY RIGHTS.
    - 6.2 EXCEPT FOR THE LIMITED RIGHT TO USE THE EVM SET FORTH HEREIN, NOTHING IN THESE TERMS SHALL BE CONSTRUED AS GRANTING OR CONFERRING ANY RIGHTS BY LICENSE, PATENT, OR ANY OTHER INDUSTRIAL OR INTELLECTUAL PROPERTY RIGHT OF TI, ITS SUPPLIERS/LICENSORS OR ANY OTHER THIRD PARTY, TO USE THE EVM IN ANY FINISHED END-USER OR READY-TO-USE FINAL PRODUCT, OR FOR ANY INVENTION, DISCOVERY OR IMPROVEMENT, REGARDLESS OF WHEN MADE, CONCEIVED OR ACQUIRED.
  7. *USER'S INDEMNITY OBLIGATIONS AND REPRESENTATIONS.* USER WILL DEFEND, INDEMNIFY AND HOLD TI, ITS LICENSORS AND THEIR REPRESENTATIVES HARMLESS FROM AND AGAINST ANY AND ALL CLAIMS, DAMAGES, LOSSES, EXPENSES, COSTS AND LIABILITIES (COLLECTIVELY, "CLAIMS") ARISING OUT OF OR IN CONNECTION WITH ANY HANDLING OR USE OF THE EVM THAT IS NOT IN ACCORDANCE WITH THESE TERMS. THIS OBLIGATION SHALL APPLY WHETHER CLAIMS ARISE UNDER STATUTE, REGULATION, OR THE LAW OF TORT, CONTRACT OR ANY OTHER LEGAL THEORY, AND EVEN IF THE EVM FAILS TO PERFORM AS DESCRIBED OR EXPECTED.

8. *Limitations on Damages and Liability:*

8.1 *General Limitations.* IN NO EVENT SHALL TI BE LIABLE FOR ANY SPECIAL, COLLATERAL, INDIRECT, PUNITIVE, INCIDENTAL, CONSEQUENTIAL, OR EXEMPLARY DAMAGES IN CONNECTION WITH OR ARISING OUT OF THESE TERMS OR THE USE OF THE EVMS , REGARDLESS OF WHETHER TI HAS BEEN ADVISED OF THE POSSIBILITY OF SUCH DAMAGES. EXCLUDED DAMAGES INCLUDE, BUT ARE NOT LIMITED TO, COST OF REMOVAL OR REINSTALLATION, ANCILLARY COSTS TO THE PROCUREMENT OF SUBSTITUTE GOODS OR SERVICES, RETESTING, OUTSIDE COMPUTER TIME, LABOR COSTS, LOSS OF GOODWILL, LOSS OF PROFITS, LOSS OF SAVINGS, LOSS OF USE, LOSS OF DATA, OR BUSINESS INTERRUPTION. NO CLAIM, SUIT OR ACTION SHALL BE BROUGHT AGAINST TI MORE THAN TWELVE (12) MONTHS AFTER THE EVENT THAT GAVE RISE TO THE CAUSE OF ACTION HAS OCCURRED.

8.2 *Specific Limitations.* IN NO EVENT SHALL TI'S AGGREGATE LIABILITY FROM ANY USE OF AN EVM PROVIDED HEREUNDER, INCLUDING FROM ANY WARRANTY, INDEMNITY OR OTHER OBLIGATION ARISING OUT OF OR IN CONNECTION WITH THESE TERMS, , EXCEED THE TOTAL AMOUNT PAID TO TI BY USER FOR THE PARTICULAR EVM(S) AT ISSUE DURING THE PRIOR TWELVE (12) MONTHS WITH RESPECT TO WHICH LOSSES OR DAMAGES ARE CLAIMED. THE EXISTENCE OF MORE THAN ONE CLAIM SHALL NOT ENLARGE OR EXTEND THIS LIMIT.

9. *Return Policy.* Except as otherwise provided, TI does not offer any refunds, returns, or exchanges. Furthermore, no return of EVM(s) will be accepted if the package has been opened and no return of the EVM(s) will be accepted if they are damaged or otherwise not in a resalable condition. If User feels it has been incorrectly charged for the EVM(s) it ordered or that delivery violates the applicable order, User should contact TI. All refunds will be made in full within thirty (30) working days from the return of the components(s), excluding any postage or packaging costs.

10. *Governing Law:* These terms and conditions shall be governed by and interpreted in accordance with the laws of the State of Texas, without reference to conflict-of-laws principles. User agrees that non-exclusive jurisdiction for any dispute arising out of or relating to these terms and conditions lies within courts located in the State of Texas and consents to venue in Dallas County, Texas. Notwithstanding the foregoing, any judgment may be enforced in any United States or foreign court, and TI may seek injunctive relief in any United States or foreign court.

Mailing Address: Texas Instruments, Post Office Box 655303, Dallas, Texas 75265  
Copyright © 2023, Texas Instruments Incorporated

## IMPORTANT NOTICE AND DISCLAIMER

TI PROVIDES TECHNICAL AND RELIABILITY DATA (INCLUDING DATA SHEETS), DESIGN RESOURCES (INCLUDING REFERENCE DESIGNS), APPLICATION OR OTHER DESIGN ADVICE, WEB TOOLS, SAFETY INFORMATION, AND OTHER RESOURCES "AS IS" AND WITH ALL FAULTS, AND DISCLAIMS ALL WARRANTIES, EXPRESS AND IMPLIED, INCLUDING WITHOUT LIMITATION ANY IMPLIED WARRANTIES OF MERCHANTABILITY, FITNESS FOR A PARTICULAR PURPOSE OR NON-INFRINGEMENT OF THIRD PARTY INTELLECTUAL PROPERTY RIGHTS.

These resources are intended for skilled developers designing with TI products. You are solely responsible for (1) selecting the appropriate TI products for your application, (2) designing, validating and testing your application, and (3) ensuring your application meets applicable standards, and any other safety, security, regulatory or other requirements.

These resources are subject to change without notice. TI grants you permission to use these resources only for development of an application that uses the TI products described in the resource. Other reproduction and display of these resources is prohibited. No license is granted to any other TI intellectual property right or to any third party intellectual property right. TI disclaims responsibility for, and you will fully indemnify TI and its representatives against, any claims, damages, costs, losses, and liabilities arising out of your use of these resources.

TI's products are provided subject to [TI's Terms of Sale](#) or other applicable terms available either on [ti.com](https://www.ti.com) or provided in conjunction with such TI products. TI's provision of these resources does not expand or otherwise alter TI's applicable warranties or warranty disclaimers for TI products.

TI objects to and rejects any additional or different terms you may have proposed.

Mailing Address: Texas Instruments, Post Office Box 655303, Dallas, Texas 75265

Copyright © 2025, Texas Instruments Incorporated