

AN-1988 LMH0340 / LMH0341 SerDes Family LVDS Timing Overview

ABSTRACT

This application report discusses the LVDS timing requirements for the LMH0340 and LMH0341 family of products.

Contents

1	Introduction	2
2	Serializer Device Timing Requirements	2
3	Serializer Register Programmability	4
4	Deserializer Device Timing Requirements	6
5	Deserializer Register Programmability	6
6	Conclusion	7
7	Referenced Parts	7

List of Figures

1	FPGA-Attach System Diagram.....	2
2	Single Clock Sampling Data Setup and Hold Time.....	3
3	DDR Interface Setup and Hold Time	3
4	Serializer Setup and Hold Time.....	4
5	Clock and Data Phase Adjustment	5
6	Deserializer (Setup and Hold Time) Data Valid Times.....	6
7	Deserializer (Setup and Hold Time) Data Valid Times Programability.....	7

List of Tables

1	Register 0x30 bits 7:5 Setup/Hold Delay Settings (* = default).....	4
2	Deserializer Clock and Data Phase Offset Settings Register 0x28 bits [3:2] (* = Default).....	6

1 Introduction

The LMH0340 and LMH0341 were designed to allow low cost FPGAs to be used in the implementation of advanced Serial Digital Interfaces, up to and including the 3 Gbps interface. They feature advanced on-chip signal and clock conditioning circuitry that extends data transmission reach with Belden 1694A or comparable broadcast video cable over 300m (for Standard Definition Video) with the use of an external cable equalizer such as the LMH0384.

The SerDes unique architecture is designed specifically to address the interface requirements of low cost FPGA devices. The 5-bit LVDS parallel data interface simplifies board layout by reducing the number of input/output (I/O) pins and traces between the serializer, deserializer and the FPGA. The 5-bit wide interface was chosen so that the data rate of the 3 Gbps signals would be brought down under 600 Mbps where it can be handled by the I/O of low cost FPGA devices.

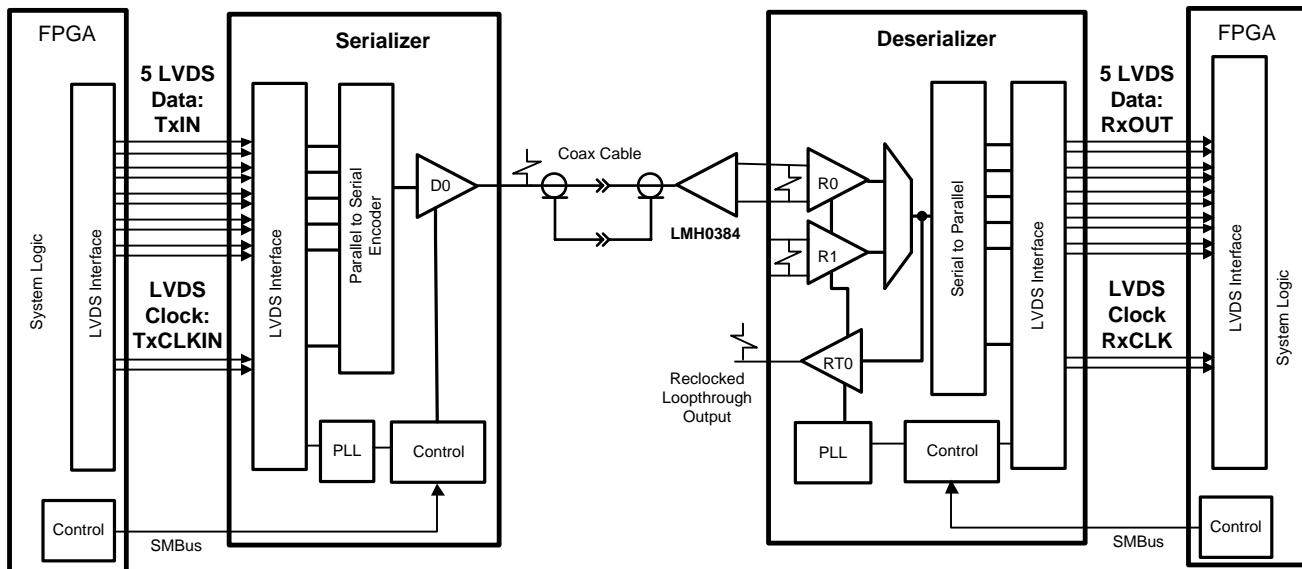

Figure 1. FPGA-Attach System Diagram

2 Serializer Device Timing Requirements

Consider how a simple register such as the 74LS174 D Flip Flop is specified, there is a single clock edge sampling a single data edge. The clock samples the data on a single edge, either positive or negative depending on the flip-flop. The setup time is on the order of 10's of nanoseconds and hold times very close to 0. The optimal clock position for the flip-flop is in the middle of the bit period of the data, as seen in [Figure 2](#), although with a 0 hold time, it is also possible to implement systems in which the clock and the data all switch at the same time.

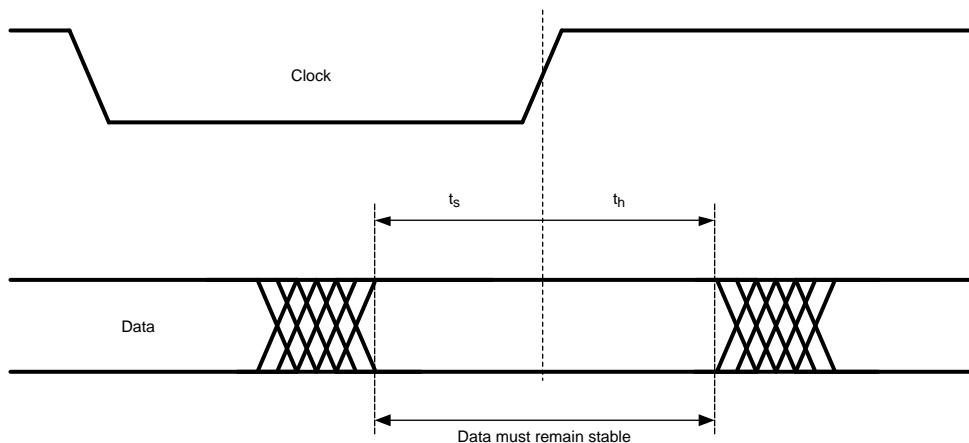

Figure 2. Single Clock Sampling Data Setup and Hold Time

For dual data rate (DDR) interfaces, the clock samples the data on both edges of the clock. CMOS, LVPECL or LVDS interfaces can utilize a DDR interface. The main advantage of DDR interfaces is that the clock and data frequency are identical, which maximizes data throughput for the protocol. The duty cycle distortion of the clock plays a critical part in the setup and hold time as both edges must meet the setup and hold time requirements to sample the data in the mid-bit transition.

Note that if there is skew between the various data lines, or if there is duty cycle distortion of the clock, all of these non-idealities work to reduce the amount of timing margin in the system, so all effort should be taken to reduce inter-pair data skew and clock distortion.

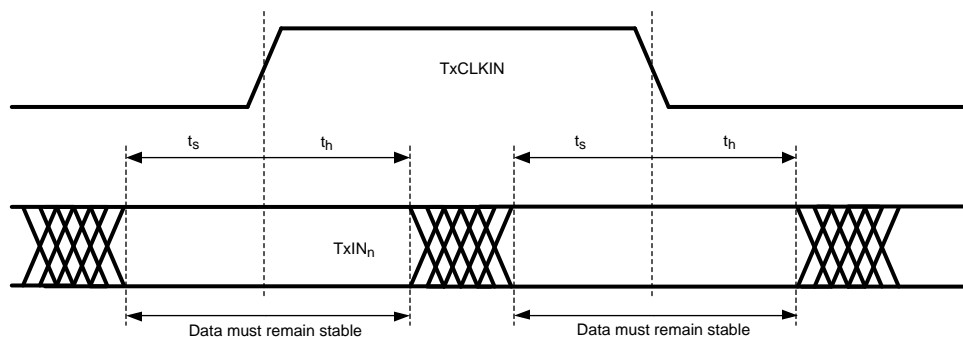
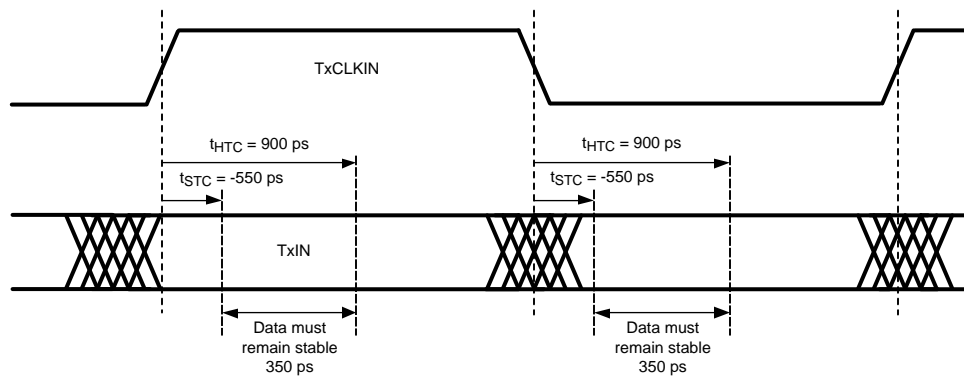

Figure 3. DDR Interface Setup and Hold Time

The LVDS DDR input implementation in the serializer reduces the number of Clock / PLL resources required in the host FPGA. The setup and hold time requirements for the LVDS interface input latch expects the alignment of the clock and data transitions. An additional clock resource is not needed to offset the clock edges in the middle of the data bits.

The numbers that are specified in the data sheet (minimum setup time is -550 ps and the maximum hold time is 900 ps) are worst case numbers and by assuring that each of your data lines meets these timing requirements, you are ensuring that the device will properly latch its input data. A negative setup time comes about because within the device there is a delay on the clock line that allows the FPGA to shift out the clock and data on the same clock edge. Internal to the serializer, the clock is shifted to sample the data. When the clock transitions, the actual data that is sampled is the data that was on the input pins a few hundred ps earlier. A graphical explanation of these timings is shown in the [Figure 4](#) and shows a sampling window of 350 ps.

Figure 4. Serializer Setup and Hold Time

3 Serializer Register Programmability

For the serializer (LMH0340, LMH0040, LMH0050, and LMH0070), the clock to data delay can be optimized by programming register bits in the serializer. This feature allows adjustment of the serializer setup and hold time locations to be optimized to the data valid time provided by the FPGA host device.

To adjust the serializer clock and data delay, use register 0x30 bits [7:5]. The default delay between the clock and data is 725 ps (value 011'b). Each LSB changes the delay by 125 ps, which gives a range in delay from 350 ps to 1225 ps.

For more information, see [Table 1](#) and [Figure 5](#).

Table 1. Register 0x30 bits 7:5 Setup/Hold Delay Settings (* = default)

Register Setting Reg 0x30 bits [7:5]	Sample Time Instant (ps)	Setup Time (ps)	Hold Time (ps)	Data Valid (ps)
000'b	350	- 175	525	350
001'b	475	- 300	650	350
010'b	600	- 425	775	350
011'b *	725	- 550	900	350
100'b	850	- 675	1025	350
101'b	975	- 800	1150	350
110'b	1100	- 925	1275	350
111'b	1225	- 1050	1400	350

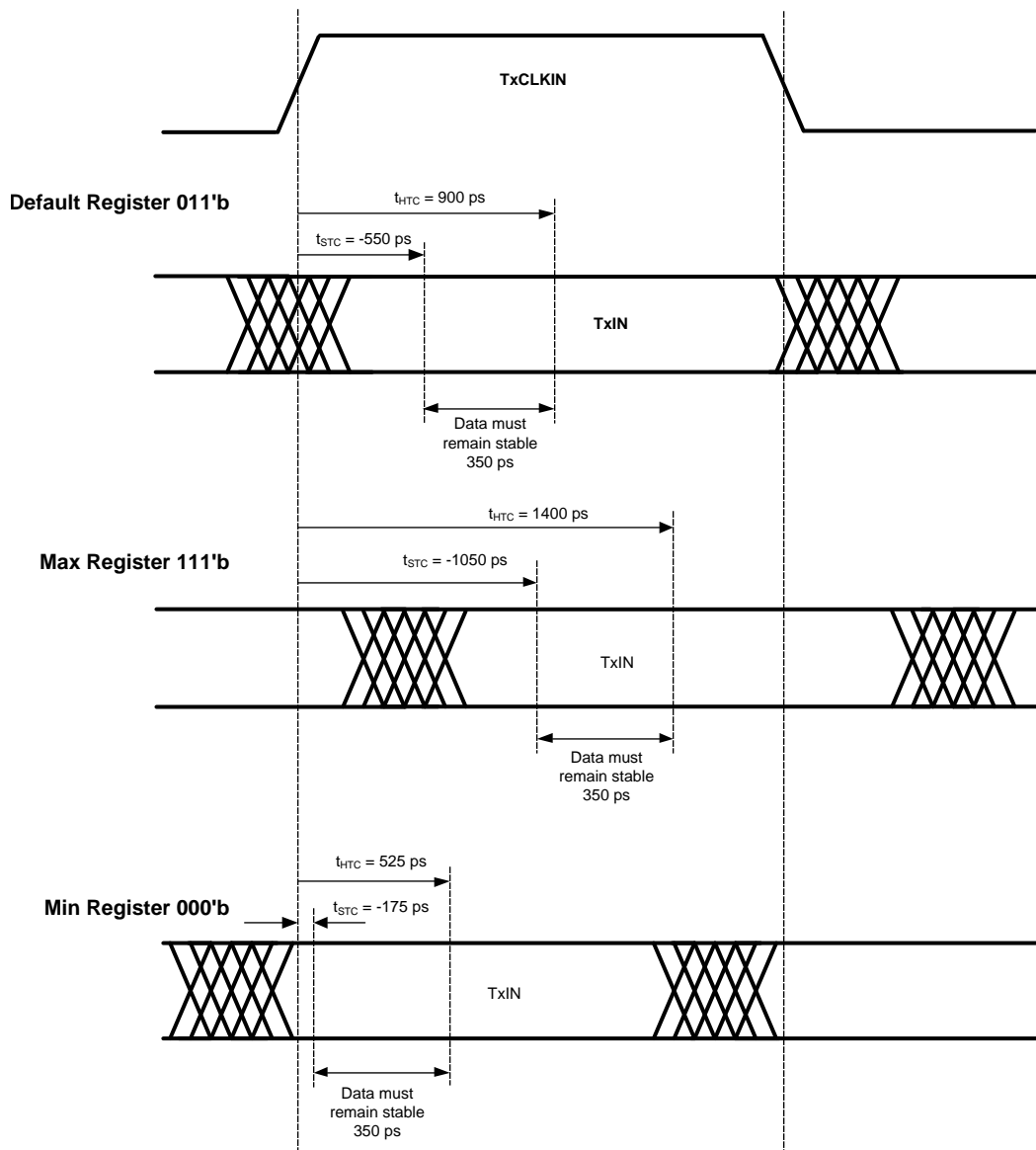

Figure 5. Clock and Data Phase Adjustment

4 Deserializer Device Timing Requirements

For the deserializers (LM0341, LMH0041, LMH0051 and LMH0071), the LVDS clock and data outputs are skewed to provide maximum setup and hold durations for the target FPGA. The deserializer data sheet specifies t_{DVBC} and t_{DVAC} , which specify the time during which the data is valid before and after the clock edge transition, centering the clock and data at a maximum line rate.

For example at a maximum line rate of 2.97 Gbps, the LVDS clock rate is 297 MHz or 3.4 ns. Divide this by 2 due to the DDR clocking and the data period is 1.7 ns. This timing is shown in [Figure 6](#).

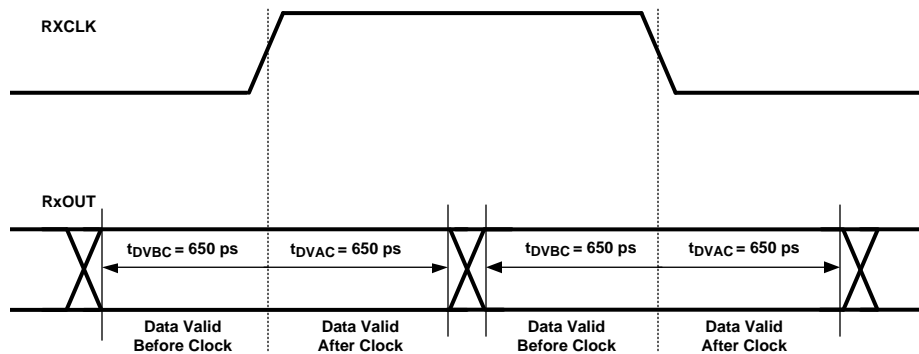

Figure 6. Deserializer (Setup and Hold Time) Data Valid Times

5 Deserializer Register Programmability

Like the serializer, the deserializer can also be optimized to adjust the clock edge location to be compatible with the downstream device's input timing requirement. To adjust the deserializer, use register 0x28. Bits 2 and 3 of register 0x28 adjust the phase in 80 ps steps that gives 240 ps adjustment. The default value of register 0x28 is 10'b for an 800 ps setup and hold time. The time can be adjusted to a minimum of 640 ps and a maximum of 880 ps. The data valid after clock (Hold) can be set from 960 ps to 720 ps.

The clock phase can also be inverted by bit 4 of register 0x28.

For more information, see [Table 2](#) and [Figure 7](#).

Table 2. Deserializer Clock and Data Phase Offset Settings Register 0x28 bits [3:2] (* = Default)

Register Setting Reg 0x28 bits [3:2]	Offset (ps)	Data Valid Before Clock (ps)	Data Valid After Clock (ps)
00'b	160	490	810
01'b	80	570	730
10'b *	0	650	650
11'b	-80	730	570

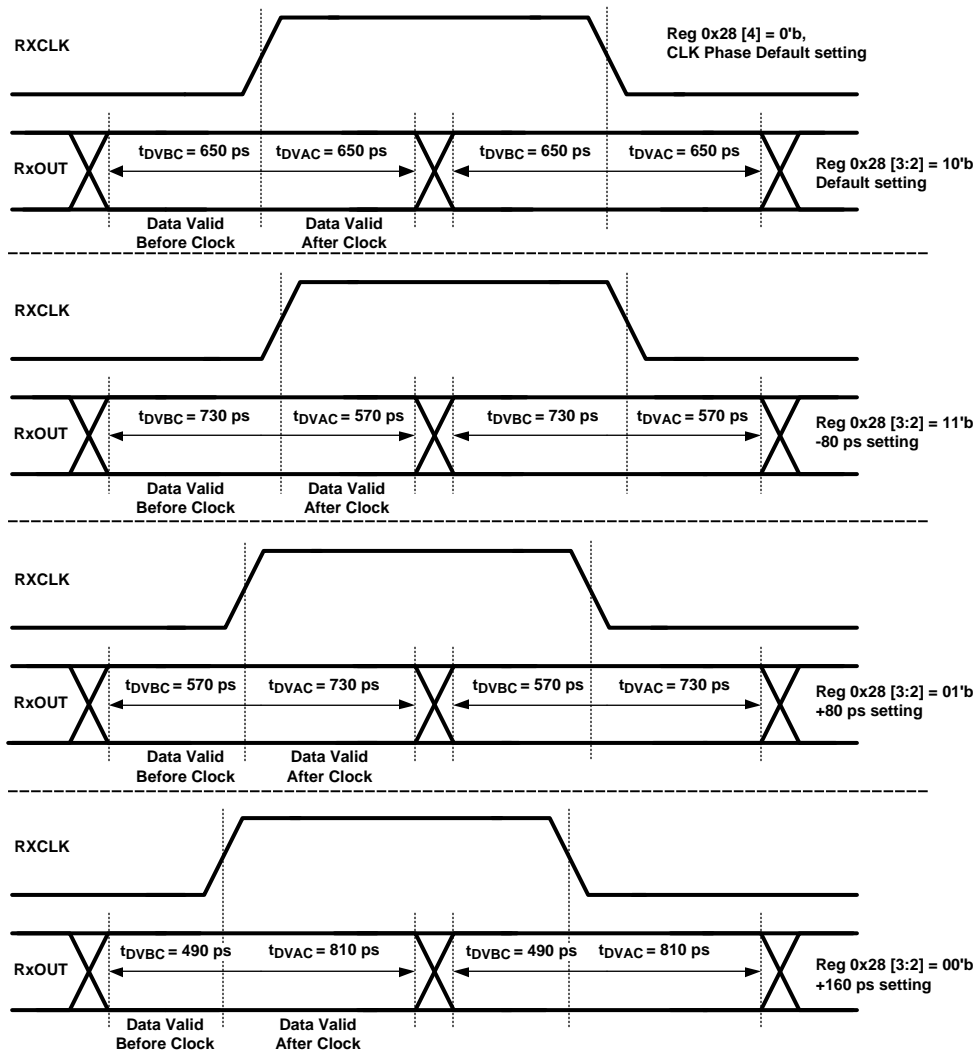

Figure 7. Deserializer (Setup and Hold Time) Data Valid Times Programmability

6 Conclusion

In summary, the DDR timing of the FPGA-attach serializers and deserializers have been optimized for use with low cost FPGAs. Further, adjustability of the delay between the clock and data allows you to configure the sampling window or the clock edge to optimize it for specific FPGA requirements.

7 Referenced Parts

This application report refers to LMH0340, LMH0040, LMH0050, LMH0070, LMH00341, LMH00041, LMH00051 and LMH00071.

IMPORTANT NOTICE

Texas Instruments Incorporated and its subsidiaries (TI) reserve the right to make corrections, enhancements, improvements and other changes to its semiconductor products and services per JESD46, latest issue, and to discontinue any product or service per JESD48, latest issue. Buyers should obtain the latest relevant information before placing orders and should verify that such information is current and complete. All semiconductor products (also referred to herein as "components") are sold subject to TI's terms and conditions of sale supplied at the time of order acknowledgment.

TI warrants performance of its components to the specifications applicable at the time of sale, in accordance with the warranty in TI's terms and conditions of sale of semiconductor products. Testing and other quality control techniques are used to the extent TI deems necessary to support this warranty. Except where mandated by applicable law, testing of all parameters of each component is not necessarily performed.

TI assumes no liability for applications assistance or the design of Buyers' products. Buyers are responsible for their products and applications using TI components. To minimize the risks associated with Buyers' products and applications, Buyers should provide adequate design and operating safeguards.

TI does not warrant or represent that any license, either express or implied, is granted under any patent right, copyright, mask work right, or other intellectual property right relating to any combination, machine, or process in which TI components or services are used. Information published by TI regarding third-party products or services does not constitute a license to use such products or services or a warranty or endorsement thereof. Use of such information may require a license from a third party under the patents or other intellectual property of the third party, or a license from TI under the patents or other intellectual property of TI.

Reproduction of significant portions of TI information in TI data books or data sheets is permissible only if reproduction is without alteration and is accompanied by all associated warranties, conditions, limitations, and notices. TI is not responsible or liable for such altered documentation. Information of third parties may be subject to additional restrictions.

Resale of TI components or services with statements different from or beyond the parameters stated by TI for that component or service voids all express and any implied warranties for the associated TI component or service and is an unfair and deceptive business practice. TI is not responsible or liable for any such statements.

Buyer acknowledges and agrees that it is solely responsible for compliance with all legal, regulatory and safety-related requirements concerning its products, and any use of TI components in its applications, notwithstanding any applications-related information or support that may be provided by TI. Buyer represents and agrees that it has all the necessary expertise to create and implement safeguards which anticipate dangerous consequences of failures, monitor failures and their consequences, lessen the likelihood of failures that might cause harm and take appropriate remedial actions. Buyer will fully indemnify TI and its representatives against any damages arising out of the use of any TI components in safety-critical applications.

In some cases, TI components may be promoted specifically to facilitate safety-related applications. With such components, TI's goal is to help enable customers to design and create their own end-product solutions that meet applicable functional safety standards and requirements. Nonetheless, such components are subject to these terms.

No TI components are authorized for use in FDA Class III (or similar life-critical medical equipment) unless authorized officers of the parties have executed a special agreement specifically governing such use.

Only those TI components which TI has specifically designated as military grade or "enhanced plastic" are designed and intended for use in military/aerospace applications or environments. Buyer acknowledges and agrees that any military or aerospace use of TI components which have **not** been so designated is solely at the Buyer's risk, and that Buyer is solely responsible for compliance with all legal and regulatory requirements in connection with such use.

TI has specifically designated certain components as meeting ISO/TS16949 requirements, mainly for automotive use. In any case of use of non-designated products, TI will not be responsible for any failure to meet ISO/TS16949.

Products

Audio	www.ti.com/audio
Amplifiers	amplifier.ti.com
Data Converters	dataconverter.ti.com
DLP® Products	www.dlp.com
DSP	dsp.ti.com
Clocks and Timers	www.ti.com/clocks
Interface	interface.ti.com
Logic	logic.ti.com
Power Mgmt	power.ti.com
Microcontrollers	microcontroller.ti.com
RFID	www.ti-rfid.com
OMAP Applications Processors	www.ti.com/omap
Wireless Connectivity	www.ti.com/wirelessconnectivity

Applications

Automotive and Transportation	www.ti.com/automotive
Communications and Telecom	www.ti.com/communications
Computers and Peripherals	www.ti.com/computers
Consumer Electronics	www.ti.com/consumer-apps
Energy and Lighting	www.ti.com/energy
Industrial	www.ti.com/industrial
Medical	www.ti.com/medical
Security	www.ti.com/security
Space, Avionics and Defense	www.ti.com/space-avionics-defense
Video and Imaging	www.ti.com/video

TI E2E Community

e2e.ti.com