

1-MHz, Micro-Power, Low-Noise, RRIO, 1.8-V CMOS OPERATIONAL AMPLIFIER Precision Value Line Series

Check for Samples: [OPA313](#), [OPA2313](#), [OPA4313](#)

FEATURES

- **Low I_Q :** 50 $\mu\text{A}/\text{ch}$
- **Wide Supply Range:** 1.8 V to 5.5 V
- **Low Noise:** 25 $\text{nV}/\sqrt{\text{Hz}}$ at 1 kHz
- **Gain Bandwidth:** 1 MHz
- **Low Input Bias Current:** 0.2 pA
- **Low Offset Voltage:** 0.5 mV
- **Unity-Gain Stable**
- **Internal RF/EMI Filter**
- **Extended Temperature Range:**
–40°C to +125°C

APPLICATIONS

- **Battery-Powered Instruments:**
 - Consumer, Industrial, Medical
 - Notebooks, Portable Media Players
- **Sensor Signal Conditioning:**
 - Loop-Powered
 - Notebooks, Portable Media Players
- **Wireless Sensors:**
 - Home Security
 - Remote Sensing
 - Wireless Metering

DESCRIPTION

The OPA313 family of single-, dual-, and quad-channel op amps represents a new generation of low-cost, general purpose, micro-power operational amplifiers. Featuring rail-to-rail input and output swings, and low quiescent current (50 μA , typ) combined with a wide bandwidth of 1 MHz and very low noise (25 $\text{nV}/\sqrt{\text{Hz}}$ at 1 kHz) makes this family very attractive for a variety of battery-powered applications that require a good balance between cost and performance. The low input bias current supports those op amps to be used in applications with megaohm source impedances.

The robust design of the OPA313 devices provides ease-of-use to the circuit designer: unity-gain stability with capacitive loads of up to 150 pF, integrated RF/EMI rejection filter, no phase reversal in overdrive conditions, and high electrostatic discharge (ESD) protection (4-kV HBM).

These devices are optimized for operation at voltages as low as +1.8 V (± 0.9 V) and up to +5.5 V (± 2.75 V), and are specified over the extended temperature range of –40°C to +125°C.

The OPA313 (single) is available in both SC70-5 and SOT23-5 packages. The OPA2313 (dual) is offered in SO-8, MSOP-8, and DFN-8 packages. The quad-channel OPA4313 is offered in a TSSOP-14 package.



Please be aware that an important notice concerning availability, standard warranty, and use in critical applications of Texas Instruments semiconductor products and disclaimers thereto appears at the end of this data sheet.

All trademarks are the property of their respective owners.



This integrated circuit can be damaged by ESD. Texas Instruments recommends that all integrated circuits be handled with appropriate precautions. Failure to observe proper handling and installation procedures can cause damage.

ESD damage can range from subtle performance degradation to complete device failure. Precision integrated circuits may be more susceptible to damage because very small parametric changes could cause the device not to meet its published specifications.

PACKAGE INFORMATION⁽¹⁾

PRODUCT	PACKAGE-LEAD	PACKAGE DESIGNATOR	SPECIFIED TEMPERATURE RANGE	PACKAGE MARKING
OPA313	SC70-5	DCK	–40°C to +125°C	SIE
	SOT23-5	DBV	–40°C to +125°C	SIF
OPA2313	SO-8	D	–40°C to +125°C	OP2313
	MSOP-8	DGK	–40°C to +125°C	OUSS
	DFN-8	DRG	–40°C to +125°C	SDY
OPA4313	TSSOP-14	PW	–40°C to +125°C	OPA4313

(1) For the most current package and ordering information, see the Package Option Addendum at the end of this document, or visit the device product folder at www.ti.com.

ABSOLUTE MAXIMUM RATINGS⁽¹⁾

Over operating free-air temperature range, unless otherwise noted.

		OPA313, OPA2313, OPA4313	UNIT
Supply voltage		7	V
Signal input terminals	Voltage ⁽²⁾	(V–) – 0.5 to (V+) + 0.5	V
	Current ⁽²⁾	±10	mA
Output short-circuit ⁽³⁾		Continuous	mA
Operating temperature, T _A		–40 to +150	°C
Storage temperature, T _{stg}		–65 to +150	°C
Junction temperature, T _J		+150	°C
ESD rating	Human body model (HBM)	4000	V
	Charged device model (CDM)	1000	V
	Machine model (MM)	200	V

- (1) Stresses above these ratings may cause permanent damage. Exposure to absolute maximum conditions for extended periods may degrade device reliability. These are stress ratings only, and functional operation of the device at these or any other conditions beyond those specified is not supported.
- (2) Input terminals are diode-clamped to the power-supply rails. Input signals that can swing more than 0.5 V beyond the supply rails should be current limited to 10 mA or less.
- (3) Short-circuit to ground, one amplifier per package.

ELECTRICAL CHARACTERISTICS: +5.5 V⁽¹⁾

 At $T_A = +25^\circ\text{C}$, $R_L = 10\text{ k}\Omega$ connected to $V_S / 2$, and $V_{CM} = V_{OUT} = V_S / 2$, unless otherwise noted.

PARAMETER		TEST CONDITIONS	OPA313, OPA2313, OPA4313			UNIT
			MIN	TYP	MAX	
OFFSET VOLTAGE						
V_{OS}	Input offset voltage			0.5	2.5	mV
dV_{OS}/dT	vs Temperature	$T_A = -40^\circ\text{C}$ to $+125^\circ\text{C}$		2		$\mu\text{V}/^\circ\text{C}$
PSRR	vs power supply	$T_A = -40^\circ\text{C}$ to $+125^\circ\text{C}$	74	90		dB
	Channel separation, dc	At dc		10		$\mu\text{V}/\text{V}$
INPUT VOLTAGE RANGE						
V_{CM}	Common-mode voltage range	No phase reversal, rail-to-rail input	$(V_-) - 0.2$		$(V_+) + 0.2$	V
CMRR	Common-mode rejection ratio	$T_A = -40^\circ\text{C}$ to $+125^\circ\text{C}$, $(V_{S-}) - 0.2\text{ V} < V_{CM} < (V_{S+}) - 1.3\text{ V}$	70	85		dB
		$T_A = -40^\circ\text{C}$ to $+125^\circ\text{C}$, $V_{CM} = -0.2\text{ V}$ to 5.7 V	64	80		dB
INPUT BIAS CURRENT						
I_B	Input bias current			± 0.2	± 10	pA
		$T_A = -40^\circ\text{C}$ to $+85^\circ\text{C}^{(2)}$			± 50	pA
		$T_A = -40^\circ\text{C}$ to $+125^\circ\text{C}^{(2)}$			± 600	pA
I_{OS}	Input offset current			± 0.2	± 10	pA
		$T_A = -40^\circ\text{C}$ to $+85^\circ\text{C}^{(2)}$			± 50	pA
		$T_A = -40^\circ\text{C}$ to $+125^\circ\text{C}^{(2)}$			± 600	pA
NOISE						
	Input voltage noise (peak-to-peak)	$f = 0.1\text{ Hz}$ to 10 Hz		6		μV_{PP}
e_n	Input voltage noise density	$f = 10\text{ kHz}$		22		$\text{nV}/\sqrt{\text{Hz}}$
		$f = 1\text{ kHz}$		25		$\text{nV}/\sqrt{\text{Hz}}$
i_n	Input current noise density	$f = 1\text{ kHz}$		5		$\text{fA}/\sqrt{\text{Hz}}$
INPUT CAPACITANCE						
C_{IN}	Differential			1		pF
	Common-mode			5		pF
OPEN-LOOP GAIN						
A_{OL}	Open-loop voltage gain	$0.05\text{ V} < V_O < (V_+) - 0.05\text{ V}$, $R_L = 100\text{ k}\Omega$	90	104		dB
		$T_A = -40^\circ\text{C}$ to $+125^\circ\text{C}$, $0.1\text{ V} < V_O < (V_+) - 0.1\text{ V}$	104	116		dB
		$0.3\text{ V} < V_O < (V_+) - 0.3\text{ V}$, $R_L = 2\text{ k}\Omega$	100	110		dB
	Phase margin	$V_S = 5.0\text{ V}$, $G = +1$		65		degrees

- (1) Parameters with minimum or maximum specification limits are 100% production tested at $+25^\circ\text{C}$, unless otherwise noted. Over temperature limits are based on characterization and statistical analysis.
- (2) Specified by design and characterization; not production tested.

ELECTRICAL CHARACTERISTICS: +5.5 V⁽¹⁾ (continued)

At $T_A = +25\text{ }^\circ\text{C}$, $R_L = 10\text{ k}\Omega$ connected to $V_S / 2$, and $V_{CM} = V_{OUT} = V_S / 2$, unless otherwise noted.

PARAMETER		TEST CONDITIONS	OPA313, OPA2313, OPA4313			UNIT
			MIN	TYP	MAX	
FREQUENCY RESPONSE						
GBW	Gain-bandwidth product	$V_S = 5.0\text{ V}$, $C_L = 10\text{ pF}$		1		MHz
SR	Slew rate	$V_S = 5.0\text{ V}$, $G = +1$		0.5		V/ μs
t_S	Settling time	To 0.1%, $V_S = 5.0\text{ V}$, 2-V step, $G = +1$		5		μs
		To 0.01%, $V_S = 5.0\text{ V}$, 2-V step, $G = +1$		6		μs
	Overload recovery time	$V_S = 5.0\text{ V}$, $V_{IN} \times \text{Gain} > V_S$		3		μs
THD+N	Total harmonic distortion + noise ⁽³⁾	$V_S = 5.0\text{ V}$, $V_O = 1\text{ V}_{RMS}$, $G = +1$, $f = 1\text{ kHz}$		0.0045%		
OUTPUT						
V_O	Voltage output swing from supply rails	$R_L = 100\text{ k}\Omega$ ⁽⁴⁾		5	20	mV
		$T_A = -40\text{ }^\circ\text{C}$ to $+125\text{ }^\circ\text{C}$, $R_L = 100\text{ k}\Omega$ ⁽⁴⁾			30	mV
		$R_L = 2\text{ k}\Omega$ ⁽⁴⁾		75	100	mV
		$T_A = -40\text{ }^\circ\text{C}$ to $+125\text{ }^\circ\text{C}$, $R_L = 2\text{ k}\Omega$			125	mV
I_{SC}	Short-circuit current			± 15		mA
		$T_A = -40\text{ }^\circ\text{C}$ to $+125\text{ }^\circ\text{C}$			± 12	mA
R_O	Open-loop output impedance			2300		Ω
POWER SUPPLY						
V_S	Specified voltage range		1.8 (± 0.9)	5.5 (± 2.75)		V
I_Q	Quiescent current per amplifier	$I_O = 0\text{ mA}$, $V_S = 5.0\text{ V}$		50	60	μA
		$T_A = -40\text{ }^\circ\text{C}$ to $+125\text{ }^\circ\text{C}$, $V_S = 5.0\text{ V}$, $I_O = 0\text{ mA}$			85	μA
	Power-on time	$V_S = 0\text{ V}$ to 5 V , to 90% I_Q level		10		μs
TEMPERATURE						
	Specified range		-40	+125		$^\circ\text{C}$
	Operating range		-40	+150		$^\circ\text{C}$
	Storage range		-65	+150		$^\circ\text{C}$

(3) Third-order filter; bandwidth = 80 kHz at -3 dB.

(4) Specified by design and characterization; not production tested.

ELECTRICAL CHARACTERISTICS: +1.8 V⁽¹⁾

 At $T_A = +25^\circ\text{C}$, $R_L = 10\text{ k}\Omega$ connected to $V_S / 2$, $V_{CM} = V_{S+} - 1.3\text{ V}$, and $V_{OUT} = V_S / 2$, unless otherwise noted.

PARAMETER		TEST CONDITIONS	OPA313, OPA2313, OPA4313			UNIT
			MIN	TYP	MAX	
OFFSET VOLTAGE						
V_{OS}	Input offset voltage			0.5	2.5	mV
dV_{OS}/dT	vs Temperature	$T_A = -40^\circ\text{C}$ to $+125^\circ\text{C}$		2		$\mu\text{V}/^\circ\text{C}$
PSRR	vs power supply	$T_A = -40^\circ\text{C}$ to $+125^\circ\text{C}$	74	90		dB
	Channel separation, dc	At dc		10		$\mu\text{V}/\text{V}$
INPUT VOLTAGE RANGE						
V_{CM}	Common-mode voltage range	No phase reversal, rail-to-rail input	$(V_-) - 0.2$		$(V_+) + 0.2$	V
CMRR	Common-mode rejection ratio	$T_A = -40^\circ\text{C}$ to $+125^\circ\text{C}$, $(V_{S-}) - 0.2\text{ V} < V_{CM} < (V_{S+}) - 1.3\text{ V}$	70	85		dB
		$V_S = 1.8\text{ V}$, $V_{CM} = -0.2\text{ V}$ to $+1.8\text{ V}$	58	73		
		$T_A = -40^\circ\text{C}$ to $+125^\circ\text{C}$, $V_{CM} = -0.2\text{ V}$ to 1.6 V	58	70		dB
INPUT BIAS CURRENT						
I_B	Input bias current			± 0.2	± 10	μA
		$T_A = -40^\circ\text{C}$ to $+85^\circ\text{C}^{(2)}$			± 50	μA
		$T_A = -40^\circ\text{C}$ to $+125^\circ\text{C}^{(2)}$			± 600	μA
I_{OS}	Input offset current			± 0.2	± 10	μA
		$T_A = -40^\circ\text{C}$ to $+85^\circ\text{C}^{(2)}$			± 50	μA
		$T_A = -40^\circ\text{C}$ to $+125^\circ\text{C}^{(2)}$			± 600	μA
NOISE						
	Input voltage noise (peak-to-peak)	$f = 0.1\text{ Hz}$ to 10 Hz		6		μV_{PP}
e_n	Input voltage noise density	$f = 10\text{ kHz}$		22		$\text{nV}/\sqrt{\text{Hz}}$
		$f = 1\text{ kHz}$		25		$\text{nV}/\sqrt{\text{Hz}}$
i_n	Input current noise density	$f = 1\text{ kHz}$		5		$\text{fA}/\sqrt{\text{Hz}}$
INPUT CAPACITANCE						
C_{IN}	Differential			1		pF
	Common-mode			5		pF
OPEN-LOOP GAIN						
A_{OL}	Open-loop voltage gain	$T_A = -40^\circ\text{C}$ to $+125^\circ\text{C}$, $0.1\text{ V} < V_O < (V_+) - 0.1\text{ V}$	90	110		dB
		$0.05\text{ V} < V_O < (V_+) - 0.05\text{ V}$, $R_L = 100\text{ k}\Omega$	100	110		dB

- (1) Parameters with minimum or maximum specification limits are 100% production tested at $+25^\circ\text{C}$, unless otherwise noted. Over temperature limits are based on characterization and statistical analysis.
- (2) Specified by design and characterization; not production tested.

ELECTRICAL CHARACTERISTICS: +1.8 V⁽¹⁾ (continued)

At T_A = +25 °C, R_L = 10 kΩ connected to V_S / 2, V_{CM} = V_{S+} – 1.3 V, and V_{OUT} = V_S / 2, unless otherwise noted.

PARAMETER		TEST CONDITIONS	OPA313, OPA2313, OPA4313			UNIT
			MIN	TYP	MAX	
FREQUENCY RESPONSE						
GBW	Gain-bandwidth product	C _L = 10 pF	0.9			MHz
SR	Slew rate	G = +1	0.45			V/μs
t _S	Settling time	To 0.1%, V _S = 5.0 V, 2-V step, G = +1	5			μs
		To 0.01%, V _S = 5.0 V, 2-V step, G = +1	6			μs
	Overload recovery time	V _S = 5.0 V, V _{IN} × Gain > V _S	3			μs
THD+N	Total harmonic distortion + noise ⁽³⁾	V _S = 5.0 V, V _O = 1 V _{RMS} , G = +1, f = 1 kHz	0.0045%			
OUTPUT						
V _O	Voltage output swing from supply rails	R _L = 100 kΩ ⁽⁴⁾	5	15		mV
		T _A = –40°C to +125°C, R _L = 100 kΩ ⁽⁴⁾			30	mV
		R _L = 2 kΩ ⁽⁴⁾	25	50		mV
		T _A = –40°C to +125°C, R _L = 2 kΩ			125	mV
I _{SC}	Short-circuit current		±6			mA
R _O	Open-loop output impedance		2300			Ω
POWER SUPPLY						
V _S	Specified voltage range		1.8 (±0.9)	5.5 (±2.75)		V
I _Q	Quiescent current per amplifier	I _O = 0 mA	50	60		μA
	Power-on time	V _S = 0 V to 5 V, to 90% I _Q level	10			μs
TEMPERATURE						
	Specified range		–40	+125		°C
	Operating range		–40	+150		°C
	Storage range		–65	+150		°C

(3) Third-order filter; bandwidth = 80 kHz at –3 dB.

(4) Specified by design and characterization; not production tested.

THERMAL INFORMATION: OPA313

THERMAL METRIC ⁽¹⁾		OPA313		UNITS
		DBV (SOT23)	DCK (SC70)	
		5 PINS	5 PINS	
θ_{JA}	Junction-to-ambient thermal resistance	228.5	281.4	°C/W
$\theta_{JC(top)}$	Junction-to-case(top) thermal resistance	99.1	91.6	
θ_{JB}	Junction-to-board thermal resistance	54.6	59.6	
Ψ_{JT}	Junction-to-top characterization parameter	7.7	1.5	
Ψ_{JB}	Junction-to-board characterization parameter	53.8	58.8	
$\theta_{JC(bottom)}$	Junction-to-case(bottom) thermal resistance	N/A	N/A	

(1) For more information about traditional and new thermal metrics, see the *IC Package Thermal Metrics* application report, [SPRA953](#).

THERMAL INFORMATION: OPA2313

THERMAL METRIC ⁽¹⁾		OPA2313			UNITS
		D (SO)	DGK (MSOP)	DRG (DFN)	
		8 PINS	8 PINS	8 PINS	
θ_{JA}	Junction-to-ambient thermal resistance	138.4	191.2	53.8	°C/W
$\theta_{JC(top)}$	Junction-to-case(top) thermal resistance	89.5	61.9	69.2	
θ_{JB}	Junction-to-board thermal resistance	78.6	111.9	20.1	
Ψ_{JT}	Junction-to-top characterization parameter	29.9	5.1	3.8	
Ψ_{JB}	Junction-to-board characterization parameter	78.1	110.2	20.0	
$\theta_{JC(bottom)}$	Junction-to-case(bottom) thermal resistance	N/A	N/A	11.6	

(1) For more information about traditional and new thermal metrics, see the *IC Package Thermal Metrics* application report, [SPRA953](#).

THERMAL INFORMATION: OPA4313

THERMAL METRIC ⁽¹⁾		OPA4313	UNITS
		PW (TSSOP)	
		14 PINS	
θ_{JA}	Junction-to-ambient thermal resistance	121.0	°C/W
$\theta_{JC(top)}$	Junction-to-case(top) thermal resistance	49.4	
θ_{JB}	Junction-to-board thermal resistance	62.8	
Ψ_{JT}	Junction-to-top characterization parameter	5.9	
Ψ_{JB}	Junction-to-board characterization parameter	62.2	
$\theta_{JC(bottom)}$	Junction-to-case(bottom) thermal resistance	N/A	

(1) For more information about traditional and new thermal metrics, see the *IC Package Thermal Metrics* application report, [SPRA953](#).

PIN CONFIGURATIONS

**DCK PACKAGE
 SC70-5
 (TOP VIEW)**

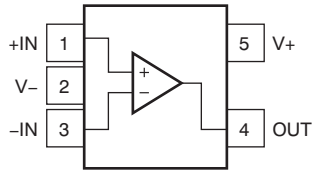

**DBV PACKAGE
 SOT23-5
 (TOP VIEW)**

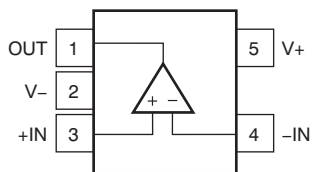

**D, DGK PACKAGES
 SO-8, MSOP-8
 (TOP VIEW)**

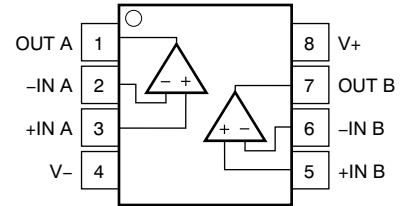

**DRG PACKAGE⁽¹⁾
 DFN-8
 (TOP VIEW)**

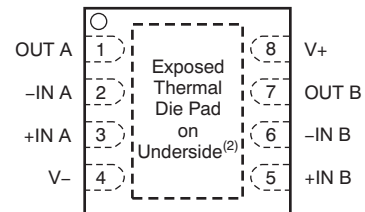

**PW PACKAGE
 TSSOP-14
 (TOP VIEW)**

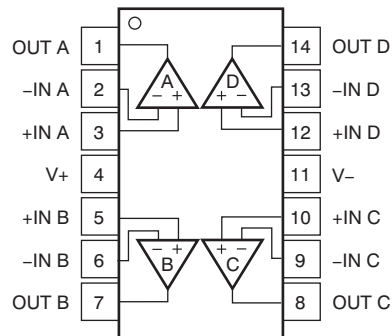

(1) Pitch: 0,65 mm.

(2) Connect thermal pad to V-. Pad size: 1,8 mm x 1,5 mm.

TYPICAL CHARACTERISTICS

Table 1. Characteristic Performance Measurements

TITLE	FIGURE
Open-Loop Gain and Phase vs Frequency	Figure 1
Open-Loop Gain vs Temperature	Figure 2
Quiescent Current vs Supply Voltage	Figure 3
Quiescent Current vs Temperature	Figure 4
Offset Voltage Production Distribution	Figure 5
Offset Voltage Drift Distribution	Figure 6
Offset Voltage vs Common-Mode Voltage (Maximum Supply)	Figure 7
Offset Voltage vs Temperature	Figure 8
CMRR and PSRR vs Frequency (RTI)	Figure 9
CMRR and PSRR vs Temperature	Figure 10
0.1-Hz to 10-Hz Input Voltage Noise (5.5 V)	Figure 11
Input Voltage Noise Spectral Density vs Frequency (1.8 V, 5.5 V)	Figure 12
Input Voltage Noise vs Common-Mode Voltage (5.5 V)	Figure 13
Input Bias and Offset Current vs Temperature	Figure 14
Open-Loop Output Impedance vs Frequency	Figure 15
Maximum Output Voltage vs Frequency and Supply Voltage	Figure 16
Output Voltage Swing vs Output Current (over Temperature)	Figure 17
Closed-Loop Gain vs Frequency, G = 1, -1, 10 (1.8 V)	Figure 18
Closed-Loop Gain vs Frequency, G = 1, -1, 10 (5.5 V)	Figure 19
Small-Signal Overshoot vs Load Capacitance	Figure 20
Phase Margin vs Capacitive Load	Figure 21
Small-Signal Step Response, Noninverting (1.8 V)	Figure 22
Small-Signal Step Response, Noninverting (5.5 V)	Figure 23
Large-Signal Step Response, Noninverting (1.8 V)	Figure 24
Large-Signal Step Response, Noninverting (5.5 V)	Figure 25
Positive Overload Recovery	Figure 26
Negative Overload Recovery	Figure 27
No Phase Reversal	Figure 28
Channel Separation vs Frequency (Dual)	Figure 29
THD+N vs Amplitude (G = +1, 2 k Ω , 10 k Ω)	Figure 30
THD+N vs Amplitude (G = -1, 2 k Ω , 10 k Ω)	Figure 31
THD+N vs Frequency (0.5 V _{RMS} , G = +1, 2 k Ω , 10 k Ω)	Figure 32
EMIRR IN+ vs Frequency	Figure 33

TYPICAL CHARACTERISTICS

At $T_A = +25\text{ }^\circ\text{C}$, $V_S = 5\text{ V}$, $R_L = 10\text{ k}\Omega$ connected to $V_S / 2$, and $V_{CM} = V_{OUT} = V_S / 2$, unless otherwise noted.

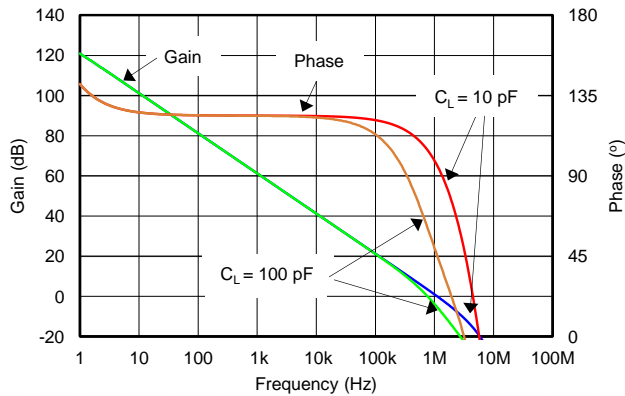

Figure 1. OPEN-LOOP GAIN AND PHASE vs FREQUENCY

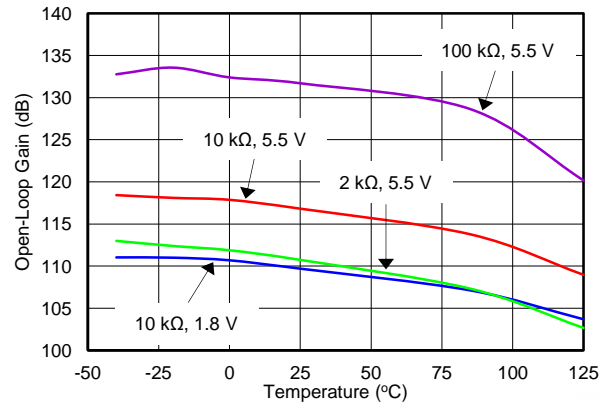

Figure 2. OPEN-LOOP GAIN vs TEMPERATURE

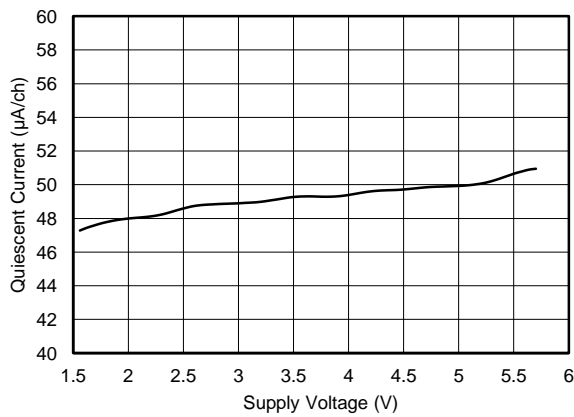

Figure 3. QUIESCENT CURRENT vs SUPPLY

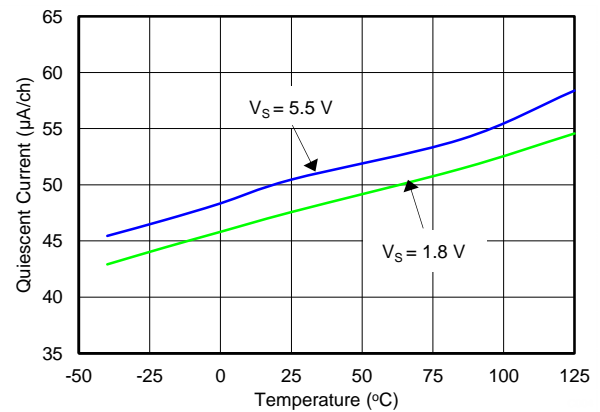

Figure 4. QUIESCENT CURRENT vs TEMPERATURE

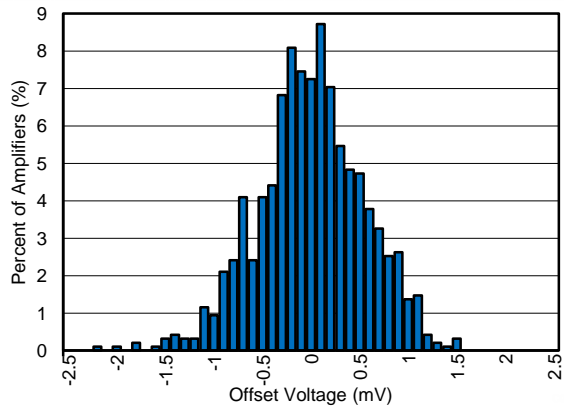

Figure 5. OFFSET VOLTAGE PRODUCTION DISTRIBUTION

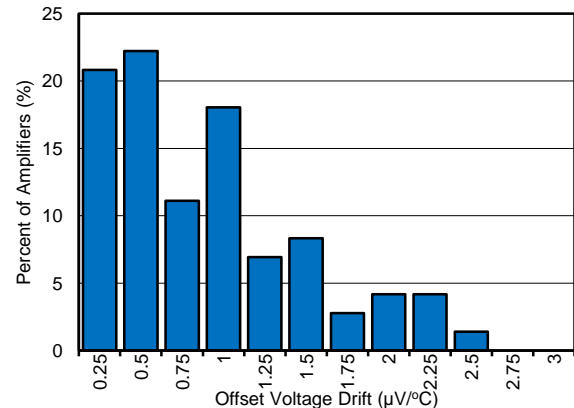

Figure 6. OFFSET VOLTAGE DRIFT DISTRIBUTION

TYPICAL CHARACTERISTICS (continued)

At $T_A = +25\text{ }^\circ\text{C}$, $V_S = 5\text{ V}$, $R_L = 10\text{ k}\Omega$ connected to $V_S / 2$, and $V_{CM} = V_{OUT} = V_S / 2$, unless otherwise noted.

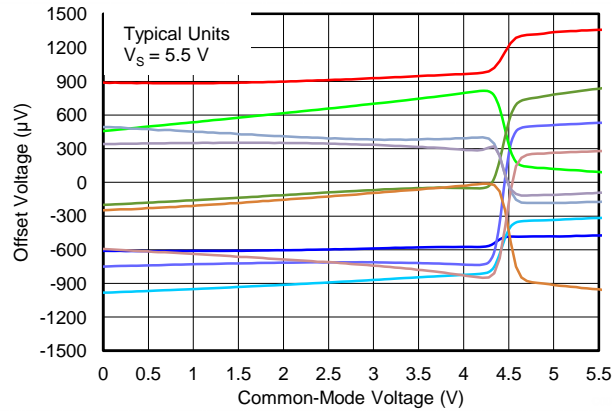

Figure 7. OFFSET VOLTAGE vs COMMON-MODE VOLTAGE

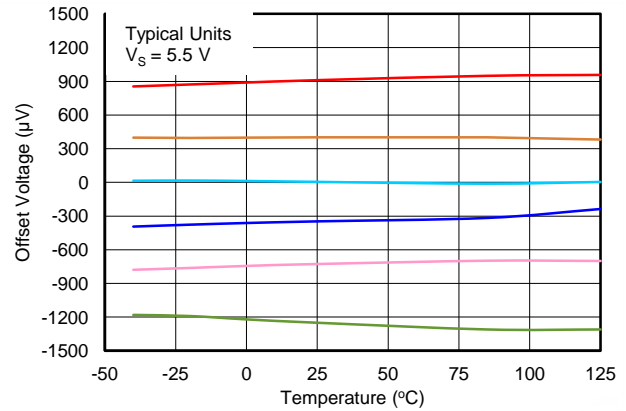

Figure 8. OFFSET VOLTAGE vs TEMPERATURE

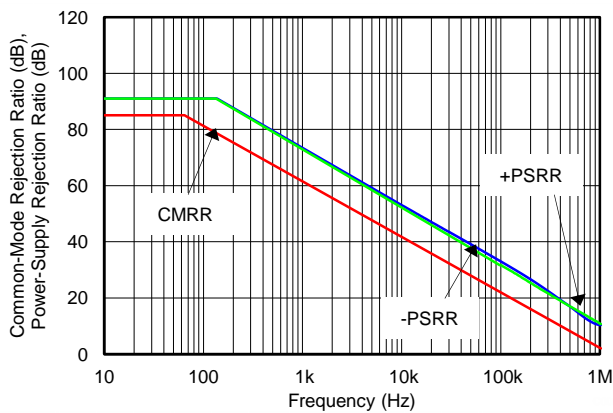

Figure 9. CMRR AND PSRR vs FREQUENCY (Referred-to-Input)

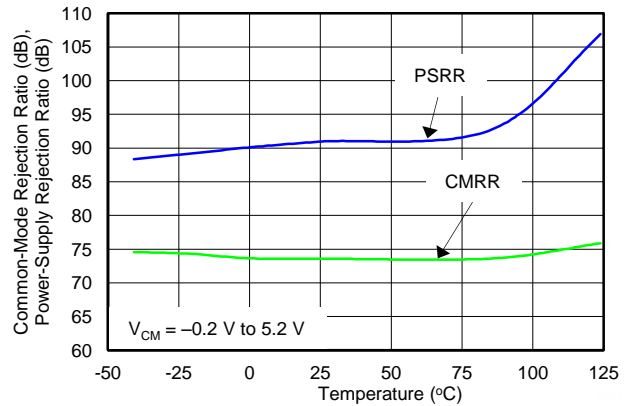

Figure 10. CMRR AND PSRR vs TEMPERATURE

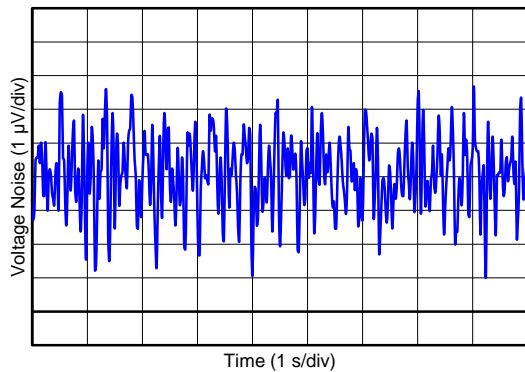

Figure 11. 0.1-Hz TO 10-Hz INPUT VOLTAGE NOISE

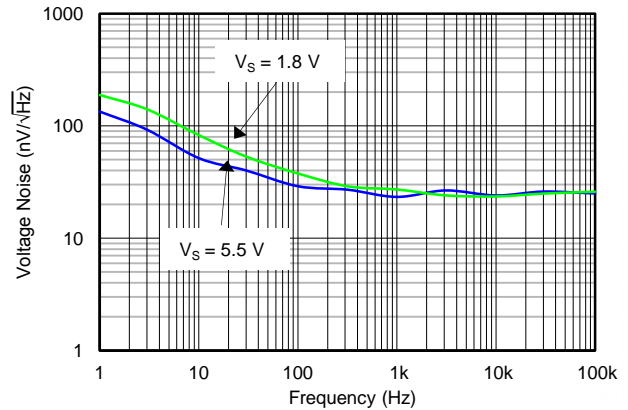

Figure 12. INPUT VOLTAGE NOISE SPECTRAL DENSITY vs FREQUENCY

TYPICAL CHARACTERISTICS (continued)

At $T_A = +25\text{ }^\circ\text{C}$, $V_S = 5\text{ V}$, $R_L = 10\text{ k}\Omega$ connected to $V_S / 2$, and $V_{CM} = V_{OUT} = V_S / 2$, unless otherwise noted.

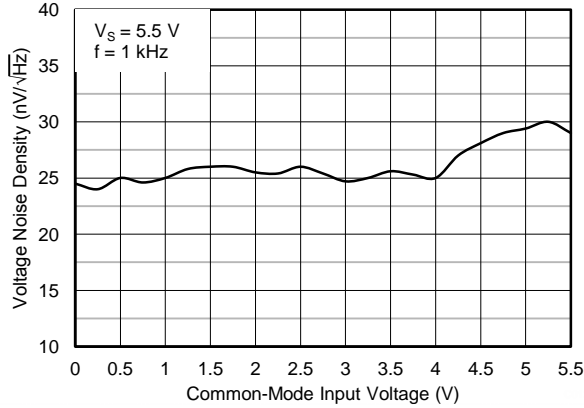

Figure 13. VOLTAGE NOISE vs COMMON-MODE VOLTAGE

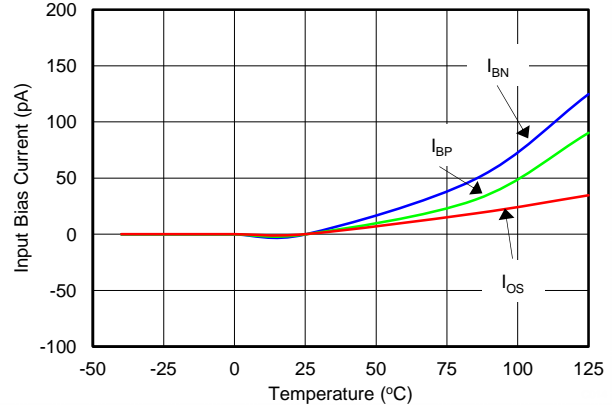

Figure 14. INPUT BIAS AND OFFSET CURRENT vs TEMPERATURE

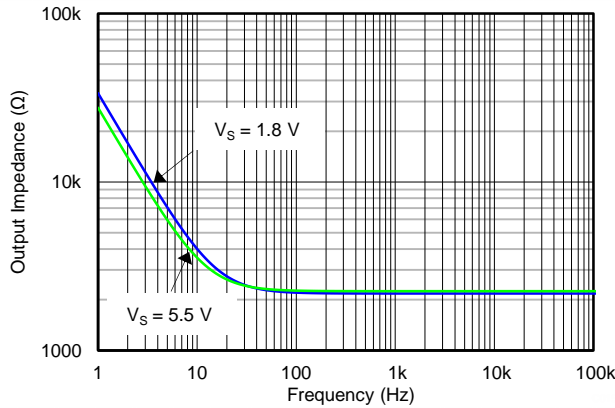

Figure 15. OPEN-LOOP OUTPUT IMPEDANCE vs FREQUENCY

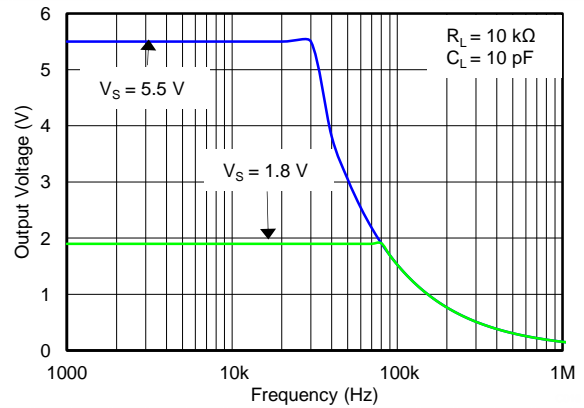

Figure 16. MAXIMUM OUTPUT VOLTAGE vs FREQUENCY AND SUPPLY VOLTAGE

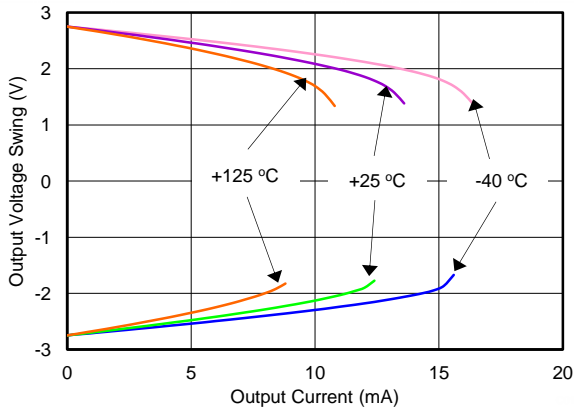

Figure 17. OUTPUT VOLTAGE SWING vs OUTPUT CURRENT (Over Temperature)

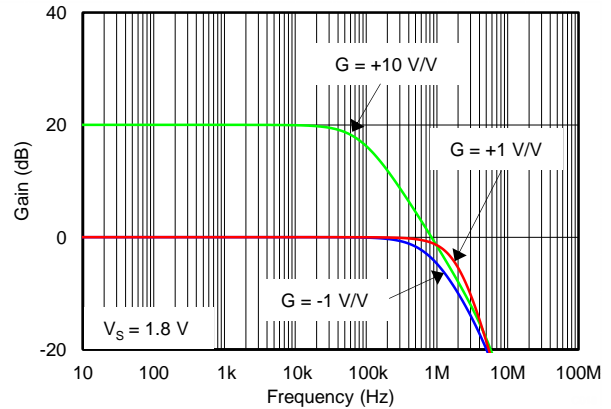

Figure 18. CLOSED-LOOP GAIN vs FREQUENCY (Minimum Supply)

TYPICAL CHARACTERISTICS (continued)

At $T_A = +25\text{ }^\circ\text{C}$, $V_S = 5\text{ V}$, $R_L = 10\text{ k}\Omega$ connected to $V_S / 2$, and $V_{CM} = V_{OUT} = V_S / 2$, unless otherwise noted.

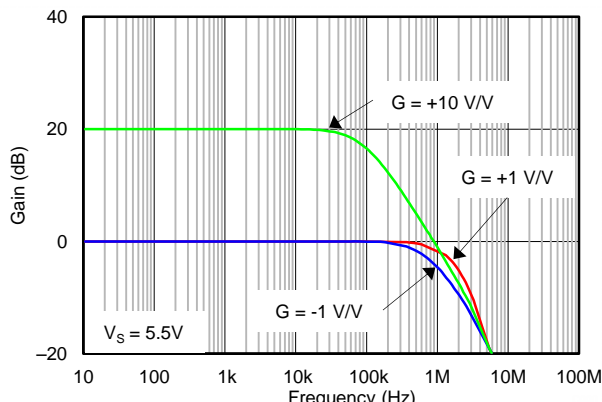

Figure 19. CLOSED-LOOP GAIN vs FREQUENCY (Maximum Supply)

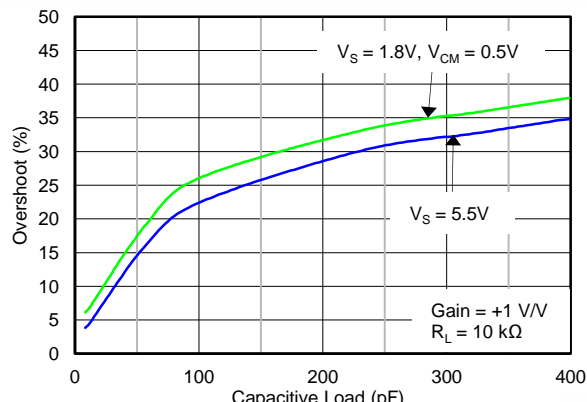

Figure 20. SMALL-SIGNAL OVERSHOOT vs LOAD CAPACITANCE

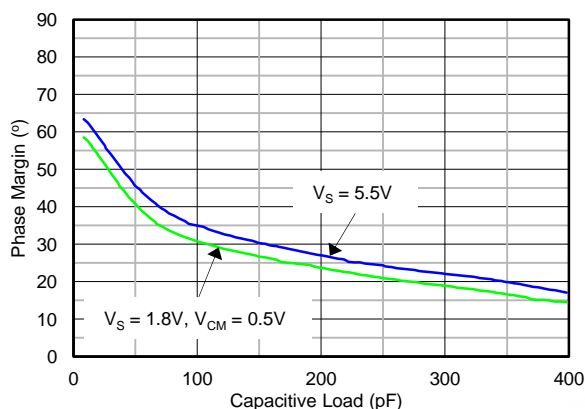

Figure 21. PHASE MARGIN vs CAPACITIVE LOAD

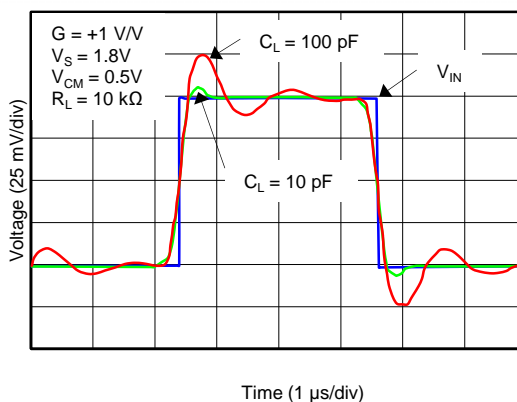

Figure 22. SMALL-SIGNAL PULSE RESPONSE (Minimum Supply)

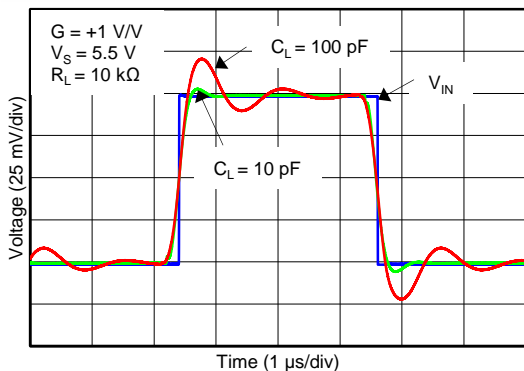

Figure 23. SMALL-SIGNAL PULSE RESPONSE (Maximum Supply)

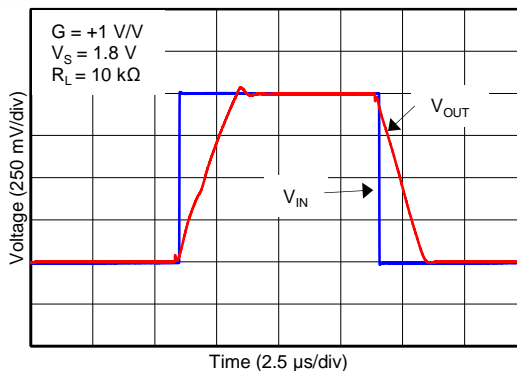

Figure 24. LARGE-SIGNAL PULSE RESPONSE (Minimum Supply)

TYPICAL CHARACTERISTICS (continued)

At $T_A = +25\text{ }^\circ\text{C}$, $V_S = 5\text{ V}$, $R_L = 10\text{ k}\Omega$ connected to $V_S / 2$, and $V_{CM} = V_{OUT} = V_S / 2$, unless otherwise noted.

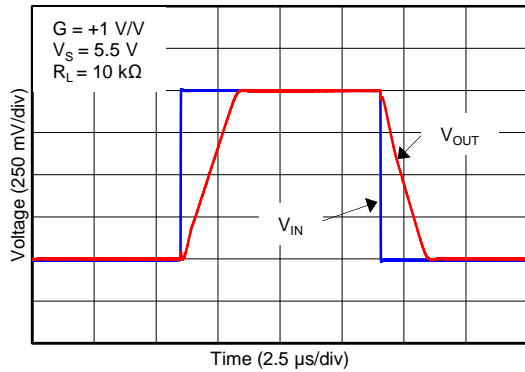

Figure 25. LARGE-SIGNAL PULSE RESPONSE (Maximum Supply)

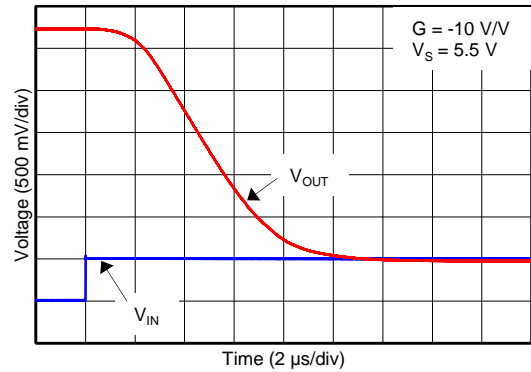

Figure 26. POSITIVE OVERLOAD RECOVERY

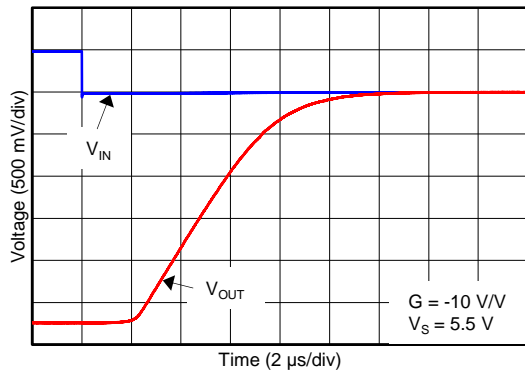

Figure 27. NEGATIVE OVERLOAD RECOVERY

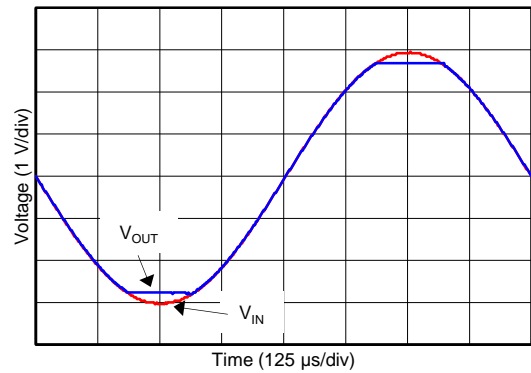

Figure 28. NO PHASE REVERSAL

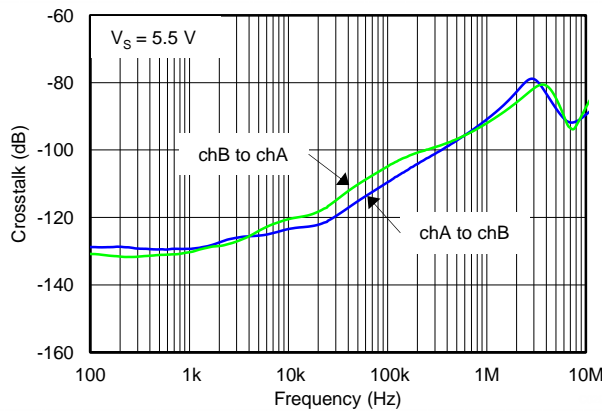

Figure 29. CHANNEL SEPARATION vs FREQUENCY

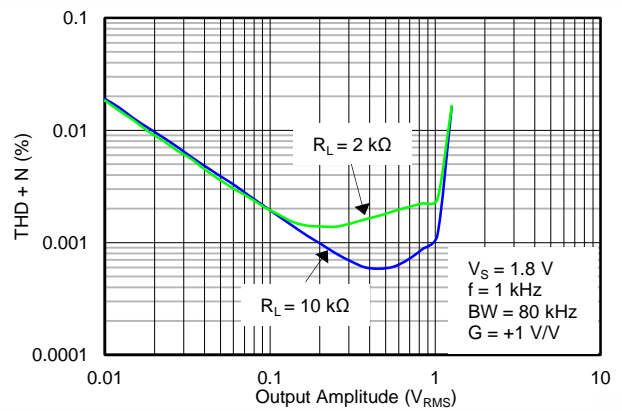

Figure 30. THD+N vs OUTPUT AMPLITUDE (Minimum Supply)

TYPICAL CHARACTERISTICS (continued)

At $T_A = +25\text{ }^\circ\text{C}$, $V_S = 5\text{ V}$, $R_L = 10\text{ k}\Omega$ connected to $V_S / 2$, and $V_{CM} = V_{OUT} = V_S / 2$, unless otherwise noted.

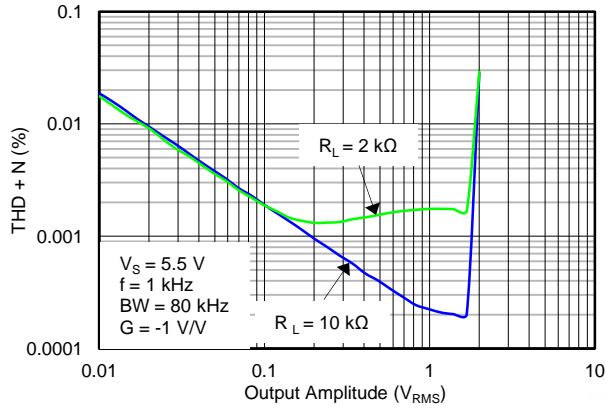

Figure 31. THD+N vs OUTPUT AMPLITUDE (Maximum Supply)

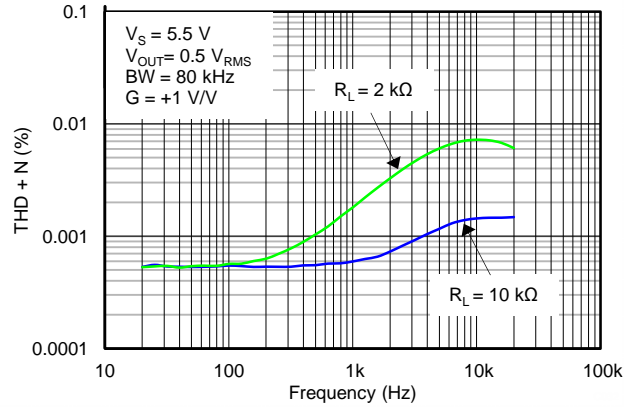

Figure 32. THD+N vs FREQUENCY

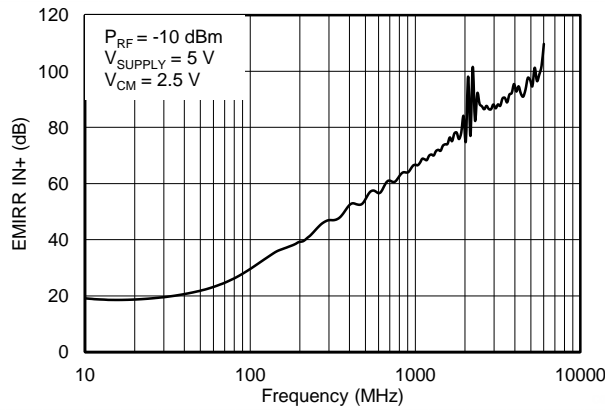

Figure 33. EMIRR IN+ vs FREQUENCY

APPLICATION INFORMATION

The OPA313 is a family of low-power, rail-to-rail input and output operational amplifiers specifically designed for portable applications. These devices operate from 1.8 V to 5.5 V, are unity-gain stable, and suitable for a wide range of general-purpose applications. The class AB output stage is capable of driving $\leq 10\text{-k}\Omega$ loads connected to any point between V_+ and ground. The input common-mode voltage range includes both rails, and allows the OPA313 family to be used in virtually any single-supply application. Rail-to-rail input and output swing significantly increases dynamic range, especially in low-supply applications, and makes them ideal for driving sampling analog-to-digital converters (ADCs).

The OPA313 features 1-MHz bandwidth and $0.5\text{-V}/\mu\text{s}$ slew rate with only $50\text{-}\mu\text{A}$ supply current per channel, providing good ac performance at very low power consumption. DC applications are also well served with a low input noise voltage of $25\text{ nV}/\sqrt{\text{Hz}}$ at 1 kHz, low input bias current (0.2 pA), and an input offset voltage of 0.5 mV (typical). The typical offset voltage drift is $2\text{ }\mu\text{V}/^\circ\text{C}$; over the full temperature range the input offset voltage changes only $200\text{ }\mu\text{V}$ (0.5 mV to 0.7 mV).

OPERATING VOLTAGE

The OPA313 series op amps are fully specified and ensured for operation from $+1.8\text{ V}$ to $+5.5\text{ V}$. In addition, many specifications apply from -40°C to $+125^\circ\text{C}$. Parameters that vary significantly with operating voltages or temperature are shown in the [Typical Characteristics](#) graphs. Power-supply pins should be bypassed with $0.01\text{-}\mu\text{F}$ ceramic capacitors.

RAIL-TO-RAIL INPUT

The input common-mode voltage range of the OPA313 series extends 200 mV beyond the supply rails. This performance is achieved with a complementary input stage: an N-channel input differential pair in parallel with a P-channel differential pair, as shown in [Figure 34](#). The N-channel pair is active for input voltages close to the positive rail, typically $(V_+) - 1.3\text{ V}$ to 200 mV above the positive supply, while the P-channel pair is on for inputs from 200 mV below the negative supply to approximately $(V_+) - 1.3\text{ V}$. There is a small transition region, typically $(V_+) - 1.4\text{ V}$ to $(V_+) - 1.2\text{ V}$, in which both pairs are on. This 200-mV transition region can vary up to 300 mV with process variation. Thus, the transition region (both stages on) can range from $(V_+) - 1.7\text{ V}$ to $(V_+) - 1.5\text{ V}$ on the low end, up to $(V_+) - 1.1\text{ V}$ to $(V_+) - 0.9\text{ V}$ on the high end. Within this transition region, PSRR, CMRR, offset voltage, offset drift, and THD may be degraded compared to device operation outside this region.

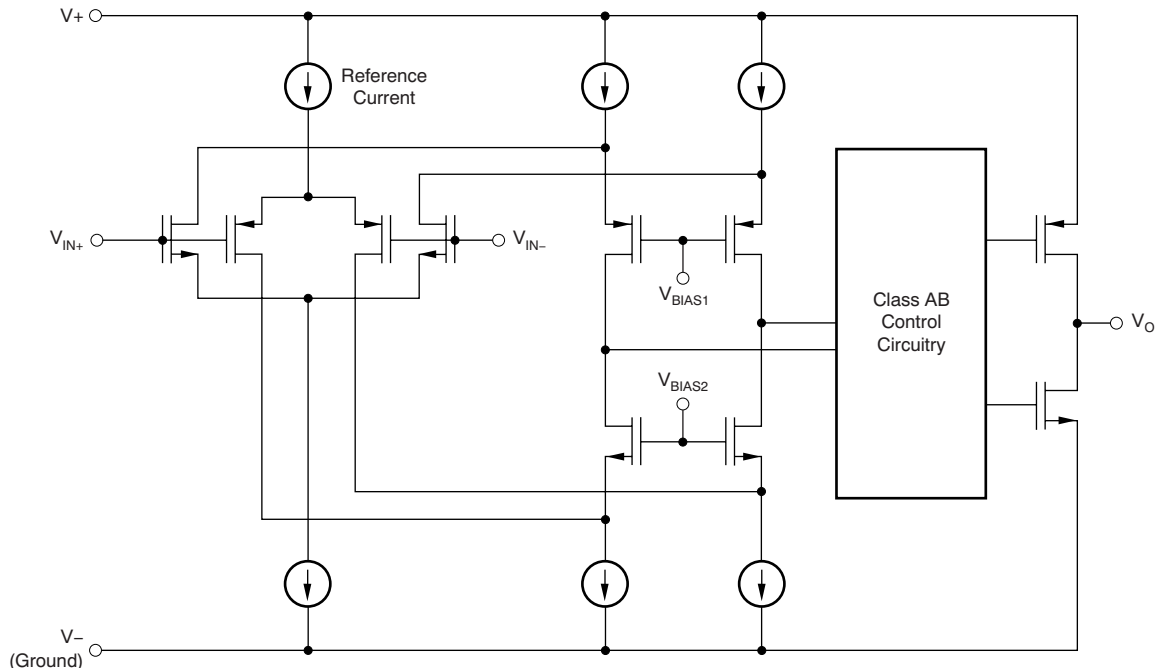

Figure 34. Simplified Schematic

INPUT AND ESD PROTECTION

The OPA313 family incorporates internal electrostatic discharge (ESD) protection circuits on all pins. In the case of input and output pins, this protection primarily consists of current-steering diodes connected between the input and power-supply pins. These ESD protection diodes also provide in-circuit, input overdrive protection, as long as the current is limited to 10 mA as stated in the [Absolute Maximum Ratings](#). [Figure 35](#) shows how a series input resistor may be added to the driven input to limit the input current. The added resistor contributes thermal noise at the amplifier input and its value should be kept to a minimum in noise-sensitive applications.

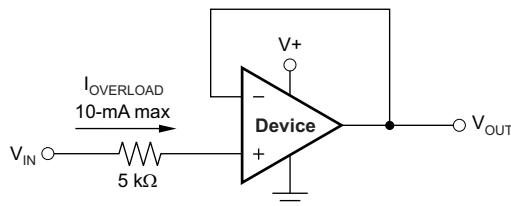

Figure 35. Input Current Protection

COMMON-MODE REJECTION RATIO (CMRR)

CMRR for the OPA313 is specified in several ways so the best match for a given application may be used; see the [Electrical Characteristics](#). First, the CMRR of the device in the common-mode range below the transition region [$V_{CM} < (V+) - 1.3\text{ V}$] is given. This specification is the best indicator of the capability of the device when the application requires use of one of the differential input pairs. Second, the CMRR over the entire common-mode range is specified at ($V_{CM} = -0.2\text{ V}$ to 5.7 V). This last value includes the variations seen through the transition region (see [Figure 7](#)).

EMI SUSCEPTIBILITY AND INPUT FILTERING

Operational amplifiers vary with regard to the susceptibility of the device to electromagnetic interference (EMI). If conducted EMI enters the op amp, the dc offset observed at the amplifier output may shift from its nominal value while EMI is present. This shift is a result of signal rectification associated with the internal semiconductor junctions. While all op amp pin functions can be affected by EMI, the signal input pins are likely to be the most susceptible. The OPA313 operational amplifier family incorporate an internal input low-pass filter that reduces the amplifiers response to EMI. Both common-mode and differential mode filtering are provided by this filter. The filter is designed for a cutoff frequency of approximately 35 MHz (-3 dB), with a roll-off of 20 dB per decade.

Texas Instruments has developed the ability to accurately measure and quantify the immunity of an operational amplifier over a broad frequency spectrum extending from 10 MHz to 6 GHz. The EMI rejection ratio (EMIRR) metric allows op amps to be directly compared by the EMI immunity. [Figure 33](#) illustrates the results of this testing on the OPA313 family. Detailed information can also be found in the application report, *EMI Rejection Ratio of Operational Amplifiers* ([SBOA128](#)), available for download from www.ti.com.

RAIL-TO-RAIL OUTPUT

Designed as a micro-power, low-noise operational amplifier, the OPA313 delivers a robust output drive capability. A class AB output stage with common-source transistors is used to achieve full rail-to-rail output swing capability. For resistive loads up to 10 k Ω , the output swings typically to within 5 mV of either supply rail regardless of the power-supply voltage applied. Different load conditions change the ability of the amplifier to swing close to the rails; refer to the typical characteristic graph, [Output Voltage Swing vs Output Current](#).

CAPACITIVE LOAD AND STABILITY

The OPA313 is designed to be used in applications where driving a capacitive load is required. As with all op amps, there may be specific instances where the OPA313 can become unstable. The particular op amp circuit configuration, layout, gain, and output loading are some of the factors to consider when establishing whether or not an amplifier is stable in operation. An op amp in the unity-gain (+1-V/V) buffer configuration that drives a capacitive load exhibits a greater tendency to be unstable than an amplifier operated at a higher noise gain. The capacitive load, in conjunction with the op amp output resistance, creates a pole within the feedback loop that degrades the phase margin. The degradation of the phase margin increases as the capacitive loading increases. When operating in the unity-gain configuration, the OPA313 remains stable with a pure capacitive load up to approximately 1 nF. The equivalent series resistance (ESR) of some very large capacitors (C_L greater than 1 μ F) is sufficient to alter the phase characteristics in the feedback loop such that the amplifier remains stable. Increasing the amplifier closed-loop gain allows the amplifier to drive increasingly larger capacitance. This increased capability is evident when observing the overshoot response of the amplifier at higher voltage gains. See the typical characteristic graph, [Small-Signal Overshoot vs. Capacitive Load](#).

One technique for increasing the capacitive load drive capability of the amplifier operating in a unity-gain configuration is to insert a small resistor, typically 10 Ω to 20 Ω , in series with the output, as shown in [Figure 36](#). This resistor significantly reduces the overshoot and ringing associated with large capacitive loads. One possible problem with this technique, however, is that a voltage divider is created with the added series resistor and any resistor connected in parallel with the capacitive load. The voltage divider introduces a gain error at the output that reduces the output swing.

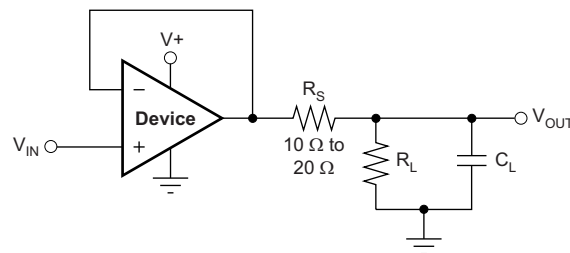

Figure 36. Improving Capacitive Load Drive

DFN PACKAGE

The OPA2313 (dual version) uses the DFN style package (also known as SON); this package is a QFN with contacts on only two sides of the package bottom. This leadless package maximizes printed circuit board (PCB) space and offers enhanced thermal and electrical characteristics through an exposed pad. One of the primary advantages of the DFN package is its low, 0.9-mm height. DFN packages are physically small, have a smaller routing area, improved thermal performance, reduced electrical parasitics, and use a pinout scheme that is consistent with other commonly-used packages, such as SO and MSOP. Additionally, the absence of external leads eliminates bent-lead issues.

The DFN package can easily be mounted using standard PCB assembly techniques. See Application Note, [QFN/SON PCB Attachment \(SLUA271\)](#) and Application Report, [Quad Flatpack No-Lead Logic Packages \(SCBA017\)](#), both available for download from www.ti.com.

NOTE

The exposed leadframe die pad on the bottom of the DFN package should be connected to the most negative potential (V-).

APPLICATION EXAMPLES

GENERAL CONFIGURATIONS

When receiving low-level signals, limiting the bandwidth of the incoming signals into the system is often required. The simplest way to establish this limited bandwidth is to place an RC filter at the noninverting terminal of the amplifier, as [Figure 37](#) shows.

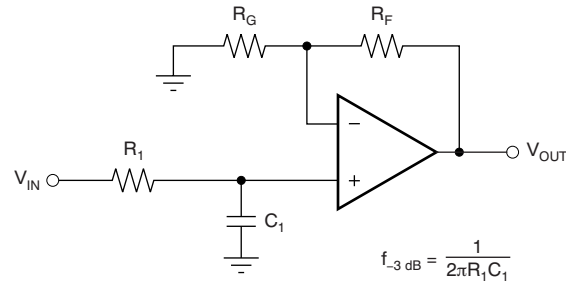

$$\frac{V_{OUT}}{V_{IN}} = \left(1 + \frac{R_F}{R_G}\right) \left(\frac{1}{1 + sR_1C_1}\right)$$

Figure 37. Single-Pole Low-Pass Filter

If even more attenuation is needed, a multiple pole filter is required. The Sallen-Key filter can be used for this task, as [Figure 38](#) shows. For best results, the amplifier should have a bandwidth that is eight to 10 times the filter frequency bandwidth. Failure to follow this guideline can result in phase shift of the amplifier.

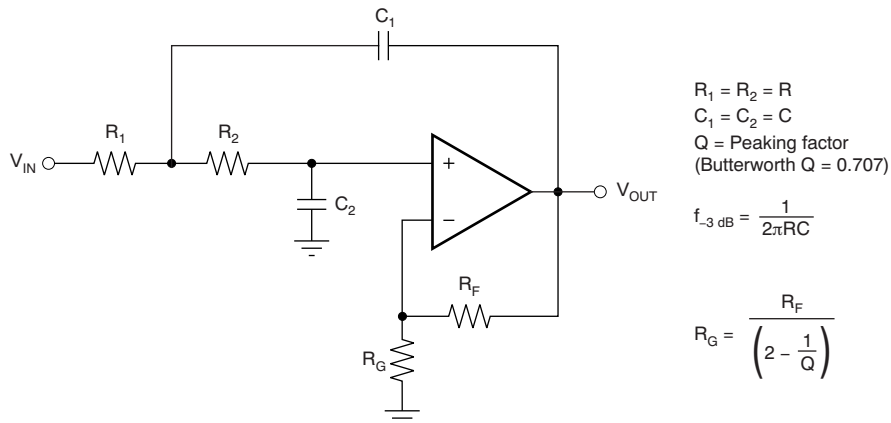

Figure 38. Two-Pole Low-Pass Sallen-Key Filter

REVISION HISTORY

NOTE: Page numbers for previous revisions may differ from page numbers in the current version.

Changes from Revision B (December 2012) to Revision C	Page
• Changed first Open-Loop Gain, A_{OL} typical specification in Electrical Characteristics: +5.5 V table	3
• Updated Figure 10	11
• Updated Figure 19 through Figure 22	12

Changes from Revision A (September 2012) to Revision B	Page
• Changed title of document	1
• Changed third paragraph of Description section	1
• Changed title of Electrical Characteristics: +5.5 V table	3
• Deleted middle two rows from Input Voltage Range, $CMRR$ parameter in Electrical Characteristics: +5.5 V table	3
• Changed test conditions of Input Voltage Range, $CMRR$ parameter in Electrical Characteristics: +5.5 V table	3
• Added footnote to Input Bias Current, I_B and I_{OS} parameters in Electrical Characteristics: +5.5 V table	3
• Changed Open-Loop Gain, A_{OL} parameter in Electrical Characteristics: +5.5 V table	3
• Deleted first row from Frequency Response, GBW parameter in Electrical Characteristics: +5.5 V table	4
• Deleted first row from Frequency Response, SR parameter in Electrical Characteristics: +5.5 V table	4
• Changed Output, V_O parameter in Electrical Characteristics: +5.5 V table	4
• Changed Output, I_{SC} parameter in Electrical Characteristics: +5.5 V table	4
• Changed test conditions for the first row in the Power Supply, I_Q parameter in Electrical Characteristics: +5.5 V table	4
• Changed Electrical Characteristics: +1.8 V table	5
• Changed conditions of Electrical Characteristics: +1.8 V table	5
• Changed last row of Input Voltage Range, $CMRR$ parameter in Electrical Characteristics: +1.8 V table	5
• Changed footnote to Input Bias Current, I_B and I_{OS} parameters in Electrical Characteristics: +1.8 V table	5
• Changed Open-Loop Gain, A_{OL} parameter in Electrical Characteristics: +1.8 V table	5
• Changed Frequency Response, GBW parameter test conditions in Electrical Characteristics: +1.8 V table	6
• Changed Frequency Response, SR parameter test conditions in Electrical Characteristics: +1.8 V table	6
• Changed Output, V_O parameter test conditions in Electrical Characteristics: +1.8 V table	6
• Changed Output, I_{SC} parameter in Electrical Characteristics: +1.8 V table	6
• Deleted last row from Power Supply, I_Q parameter in Electrical Characteristics: +1.8 V table	6
• Updated Figure 2	10

Changes from Original (September 2012) to Revision A	Page
• Changed from product preview to production data	1

PACKAGING INFORMATION

Orderable part number	Status (1)	Material type (2)	Package Pins	Package qty Carrier	RoHS (3)	Lead finish/ Ball material (4)	MSL rating/ Peak reflow (5)	Op temp (°C)	Part marking (6)
OPA2313ID	Active	Production	SOIC (D) 8	75 TUBE	Yes	NIPDAU	Level-2-260C-1 YEAR	-40 to 125	OP2313
OPA2313ID.A	Active	Production	SOIC (D) 8	75 TUBE	Yes	NIPDAU	Level-2-260C-1 YEAR	-40 to 125	OP2313
OPA2313IDGK	Active	Production	VSSOP (DGK) 8	80 TUBE	Yes	NIPDAUAG	Level-2-260C-1 YEAR	-40 to 125	OUSS
OPA2313IDGK.A	Active	Production	VSSOP (DGK) 8	80 TUBE	Yes	NIPDAUAG	Level-2-260C-1 YEAR	-40 to 125	OUSS
OPA2313IDGKR	Active	Production	VSSOP (DGK) 8	2500 LARGE T&R	Yes	NIPDAU NIPDAUAG SN	Level-2-260C-1 YEAR	-40 to 125	OUSS
OPA2313IDGKR.A	Active	Production	VSSOP (DGK) 8	2500 LARGE T&R	Yes	NIPDAU	Level-2-260C-1 YEAR	-40 to 125	OUSS
OPA2313IDR	Active	Production	SOIC (D) 8	2500 LARGE T&R	Yes	NIPDAU	Level-2-260C-1 YEAR	-40 to 125	OP2313
OPA2313IDR.A	Active	Production	SOIC (D) 8	2500 LARGE T&R	Yes	NIPDAU	Level-2-260C-1 YEAR	-40 to 125	OP2313
OPA2313IDRGR	Active	Production	SON (DRG) 8	3000 LARGE T&R	Yes	NIPDAU	Level-2-260C-1 YEAR	-40 to 125	SDY
OPA2313IDRGR.A	Active	Production	SON (DRG) 8	3000 LARGE T&R	Yes	NIPDAU	Level-2-260C-1 YEAR	-40 to 125	SDY
OPA2313IDRGT	Active	Production	SON (DRG) 8	250 SMALL T&R	Yes	NIPDAU	Level-2-260C-1 YEAR	-40 to 125	SDY
OPA2313IDRGT.A	Active	Production	SON (DRG) 8	250 SMALL T&R	Yes	NIPDAU	Level-2-260C-1 YEAR	-40 to 125	SDY
OPA2313IDRGTG4	Active	Production	SON (DRG) 8	250 SMALL T&R	Yes	NIPDAU	Level-2-260C-1 YEAR	-40 to 125	SDY
OPA2313IDRGTG4.A	Active	Production	SON (DRG) 8	250 SMALL T&R	Yes	NIPDAU	Level-2-260C-1 YEAR	-40 to 125	SDY
OPA313IDBVR	Active	Production	SOT-23 (DBV) 5	3000 LARGE T&R	Yes	NIPDAU	Level-2-260C-1 YEAR	-40 to 125	SIE
OPA313IDBVR.A	Active	Production	SOT-23 (DBV) 5	3000 LARGE T&R	Yes	NIPDAU	Level-2-260C-1 YEAR	-40 to 125	SIE
OPA313IDBVRG4	Active	Production	SOT-23 (DBV) 5	3000 LARGE T&R	Yes	NIPDAU	Level-2-260C-1 YEAR	-40 to 125	SIE
OPA313IDBVRG4.A	Active	Production	SOT-23 (DBV) 5	3000 LARGE T&R	Yes	NIPDAU	Level-2-260C-1 YEAR	-40 to 125	SIE
OPA313IDBVT	Active	Production	SOT-23 (DBV) 5	250 SMALL T&R	Yes	NIPDAU	Level-2-260C-1 YEAR	-40 to 125	SIE
OPA313IDBVT.A	Active	Production	SOT-23 (DBV) 5	250 SMALL T&R	Yes	NIPDAU	Level-2-260C-1 YEAR	-40 to 125	SIE
OPA313IDCKR	Active	Production	SC70 (DCK) 5	3000 LARGE T&R	Yes	NIPDAU SN	Level-1-260C-UNLIM	-40 to 125	SIF
OPA313IDCKR.A	Active	Production	SC70 (DCK) 5	3000 LARGE T&R	Yes	SN	Level-1-260C-UNLIM	-40 to 125	SIF
OPA313IDCKRG4	Active	Production	SC70 (DCK) 5	3000 LARGE T&R	Yes	NIPDAU	Level-1-260C-UNLIM	-40 to 125	SIF
OPA313IDCKRG4.A	Active	Production	SC70 (DCK) 5	3000 LARGE T&R	Yes	NIPDAU	Level-1-260C-UNLIM	-40 to 125	SIF
OPA313IDCKT	Active	Production	SC70 (DCK) 5	250 SMALL T&R	Yes	NIPDAU SN	Level-1-260C-UNLIM	-40 to 125	SIF
OPA313IDCKT.A	Active	Production	SC70 (DCK) 5	250 SMALL T&R	Yes	SN	Level-1-260C-UNLIM	-40 to 125	SIF
OPA4313IPW	Active	Production	TSSOP (PW) 14	90 TUBE	Yes	NIPDAU	Level-2-260C-1 YEAR	-40 to 125	OPA4313
OPA4313IPW.A	Active	Production	TSSOP (PW) 14	90 TUBE	Yes	NIPDAU	Level-2-260C-1 YEAR	-40 to 125	OPA4313

Orderable part number	Status (1)	Material type (2)	Package Pins	Package qty Carrier	RoHS (3)	Lead finish/ Ball material (4)	MSL rating/ Peak reflow (5)	Op temp (°C)	Part marking (6)
OPA4313IPWR	Active	Production	TSSOP (PW) 14	2000 LARGE T&R	Yes	NIPDAU	Level-2-260C-1 YEAR	-40 to 125	OPA4313
OPA4313IPWR.A	Active	Production	TSSOP (PW) 14	2000 LARGE T&R	Yes	NIPDAU	Level-2-260C-1 YEAR	-40 to 125	OPA4313

(1) **Status:** For more details on status, see our [product life cycle](#).

(2) **Material type:** When designated, preproduction parts are prototypes/experimental devices, and are not yet approved or released for full production. Testing and final process, including without limitation quality assurance, reliability performance testing, and/or process qualification, may not yet be complete, and this item is subject to further changes or possible discontinuation. If available for ordering, purchases will be subject to an additional waiver at checkout, and are intended for early internal evaluation purposes only. These items are sold without warranties of any kind.

(3) **RoHS values:** Yes, No, RoHS Exempt. See the [TI RoHS Statement](#) for additional information and value definition.

(4) **Lead finish/Ball material:** Parts may have multiple material finish options. Finish options are separated by a vertical ruled line. Lead finish/Ball material values may wrap to two lines if the finish value exceeds the maximum column width.

(5) **MSL rating/Peak reflow:** The moisture sensitivity level ratings and peak solder (reflow) temperatures. In the event that a part has multiple moisture sensitivity ratings, only the lowest level per JEDEC standards is shown. Refer to the shipping label for the actual reflow temperature that will be used to mount the part to the printed circuit board.

(6) **Part marking:** There may be an additional marking, which relates to the logo, the lot trace code information, or the environmental category of the part.

Multiple part markings will be inside parentheses. Only one part marking contained in parentheses and separated by a "-" will appear on a part. If a line is indented then it is a continuation of the previous line and the two combined represent the entire part marking for that device.

Important Information and Disclaimer: The information provided on this page represents TI's knowledge and belief as of the date that it is provided. TI bases its knowledge and belief on information provided by third parties, and makes no representation or warranty as to the accuracy of such information. Efforts are underway to better integrate information from third parties. TI has taken and continues to take reasonable steps to provide representative and accurate information but may not have conducted destructive testing or chemical analysis on incoming materials and chemicals. TI and TI suppliers consider certain information to be proprietary, and thus CAS numbers and other limited information may not be available for release.

In no event shall TI's liability arising out of such information exceed the total purchase price of the TI part(s) at issue in this document sold by TI to Customer on an annual basis.

OTHER QUALIFIED VERSIONS OF OPA2313 :

- Automotive : [OPA2313-Q1](#)

NOTE: Qualified Version Definitions:

- Automotive - Q100 devices qualified for high-reliability automotive applications targeting zero defects

TAPE AND REEL INFORMATION



QUADRANT ASSIGNMENTS FOR PIN 1 ORIENTATION IN TAPE

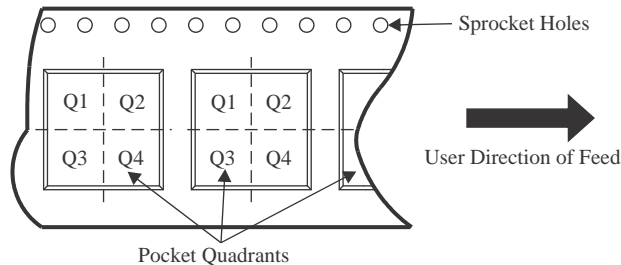

*All dimensions are nominal

Device	Package Type	Package Drawing	Pins	SPQ	Reel Diameter (mm)	Reel Width W1 (mm)	A0 (mm)	B0 (mm)	K0 (mm)	P1 (mm)	W (mm)	Pin1 Quadrant
OPA2313IDGKR	VSSOP	DGK	8	2500	330.0	12.4	5.3	3.4	1.4	8.0	12.0	Q1
OPA2313IDR	SOIC	D	8	2500	330.0	12.4	6.4	5.2	2.1	8.0	12.0	Q1
OPA2313IDRGR	SON	DRG	8	3000	330.0	12.4	3.3	3.3	1.1	8.0	12.0	Q2
OPA2313IDRGT	SON	DRG	8	250	180.0	12.4	3.3	3.3	1.1	8.0	12.0	Q2
OPA2313IDRGTG4	SON	DRG	8	250	180.0	12.4	3.3	3.3	1.1	8.0	12.0	Q2
OPA313IDBVR	SOT-23	DBV	5	3000	178.0	9.0	3.3	3.2	1.4	4.0	8.0	Q3
OPA313IDBVRG4	SOT-23	DBV	5	3000	178.0	9.0	3.3	3.2	1.4	4.0	8.0	Q3
OPA313IDBVT	SOT-23	DBV	5	250	178.0	9.0	3.23	3.17	1.37	4.0	8.0	Q3
OPA313IDCKR	SC70	DCK	5	3000	180.0	8.4	2.3	2.5	1.2	4.0	8.0	Q3
OPA313IDCKRG4	SC70	DCK	5	3000	178.0	9.0	2.4	2.5	1.2	4.0	8.0	Q3
OPA313IDCKT	SC70	DCK	5	250	180.0	8.4	2.3	2.5	1.2	4.0	8.0	Q3
OPA4313IPWR	TSSOP	PW	14	2000	330.0	12.4	6.9	5.6	1.6	8.0	12.0	Q1

TAPE AND REEL BOX DIMENSIONS

*All dimensions are nominal

Device	Package Type	Package Drawing	Pins	SPQ	Length (mm)	Width (mm)	Height (mm)
OPA2313IDGKR	VSSOP	DGK	8	2500	353.0	353.0	32.0
OPA2313IDR	SOIC	D	8	2500	353.0	353.0	32.0
OPA2313IDRGR	SON	DRG	8	3000	346.0	346.0	33.0
OPA2313IDRGT	SON	DRG	8	250	210.0	185.0	35.0
OPA2313IDRGTG4	SON	DRG	8	250	210.0	185.0	35.0
OPA313IDBVR	SOT-23	DBV	5	3000	180.0	180.0	18.0
OPA313IDBVRG4	SOT-23	DBV	5	3000	180.0	180.0	18.0
OPA313IDBVT	SOT-23	DBV	5	250	180.0	180.0	18.0
OPA313IDCKR	SC70	DCK	5	3000	210.0	185.0	35.0
OPA313IDCKRG4	SC70	DCK	5	3000	180.0	180.0	18.0
OPA313IDCKT	SC70	DCK	5	250	210.0	185.0	35.0
OPA4313IPWR	TSSOP	PW	14	2000	353.0	353.0	32.0

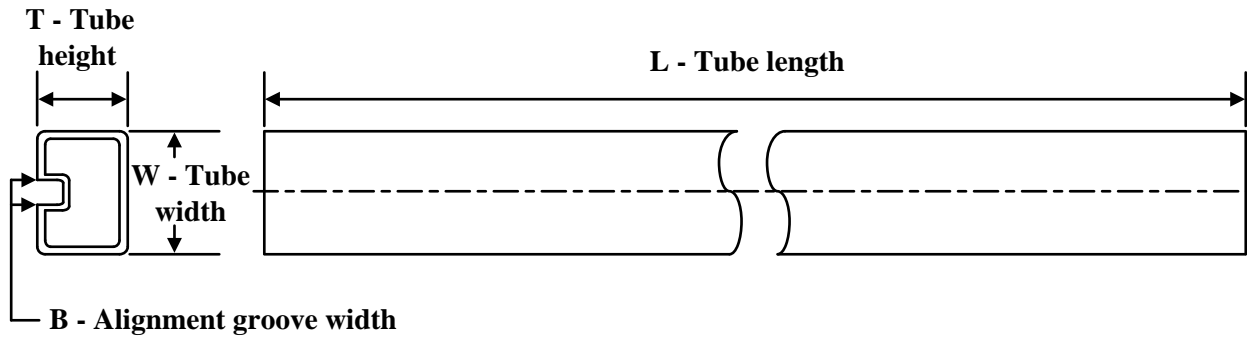
TUBE

*All dimensions are nominal

Device	Package Name	Package Type	Pins	SPQ	L (mm)	W (mm)	T (μm)	B (mm)
OPA2313ID	D	SOIC	8	75	507	8	3940	4.32
OPA2313ID.A	D	SOIC	8	75	507	8	3940	4.32
OPA2313IDGK	DGK	VSSOP	8	80	330	6.55	500	2.88
OPA2313IDGK.A	DGK	VSSOP	8	80	330	6.55	500	2.88
OPA4313IPW	PW	TSSOP	14	90	530	10.2	3600	3.5
OPA4313IPW.A	PW	TSSOP	14	90	530	10.2	3600	3.5

EXAMPLE BOARD LAYOUT

DBV0005A

SOT-23 - 1.45 mm max height

SMALL OUTLINE TRANSISTOR



LAND PATTERN EXAMPLE
EXPOSED METAL SHOWN
SCALE:15X



SOLDER MASK DETAILS

4214839/K 08/2024

NOTES: (continued)

- 6. Publication IPC-7351 may have alternate designs.
- 7. Solder mask tolerances between and around signal pads can vary based on board fabrication site.

EXAMPLE STENCIL DESIGN

DBV0005A

SOT-23 - 1.45 mm max height

SMALL OUTLINE TRANSISTOR



SOLDER PASTE EXAMPLE
BASED ON 0.125 mm THICK STENCIL
SCALE:15X

4214839/K 08/2024

NOTES: (continued)

8. Laser cutting apertures with trapezoidal walls and rounded corners may offer better paste release. IPC-7525 may have alternate design recommendations.
9. Board assembly site may have different recommendations for stencil design.

DGK0008A



PACKAGE OUTLINE

VSSOP - 1.1 mm max height

SMALL OUTLINE PACKAGE



4214862/A 04/2023

NOTES:

PowerPAD is a trademark of Texas Instruments.

1. All linear dimensions are in millimeters. Any dimensions in parenthesis are for reference only. Dimensioning and tolerancing per ASME Y14.5M.
2. This drawing is subject to change without notice.
3. This dimension does not include mold flash, protrusions, or gate burrs. Mold flash, protrusions, or gate burrs shall not exceed 0.15 mm per side.
4. This dimension does not include interlead flash. Interlead flash shall not exceed 0.25 mm per side.
5. Reference JEDEC registration MO-187.

EXAMPLE BOARD LAYOUT

DGK0008A

™ VSSOP - 1.1 mm max height

SMALL OUTLINE PACKAGE



LAND PATTERN EXAMPLE
EXPOSED METAL SHOWN
SCALE: 15X



SOLDER MASK DETAILS

4214862/A 04/2023

NOTES: (continued)

6. Publication IPC-7351 may have alternate designs.
7. Solder mask tolerances between and around signal pads can vary based on board fabrication site.
8. Vias are optional depending on application, refer to device data sheet. If any vias are implemented, refer to their locations shown on this view. It is recommended that vias under paste be filled, plugged or tented.
9. Size of metal pad may vary due to creepage requirement.

EXAMPLE STENCIL DESIGN

DGK0008A

™ VSSOP - 1.1 mm max height

SMALL OUTLINE PACKAGE



SOLDER PASTE EXAMPLE
SCALE: 15X

4214862/A 04/2023

NOTES: (continued)

11. Laser cutting apertures with trapezoidal walls and rounded corners may offer better paste release. IPC-7525 may have alternate design recommendations.
12. Board assembly site may have different recommendations for stencil design.

GENERIC PACKAGE VIEW

DRG 8

WSO - 0.8 mm max height

3 x 3, 0.5 mm pitch

PLASTIC SMALL OUTLINE - NO LEAD

This image is a representation of the package family, actual package may vary.
Refer to the product data sheet for package details.

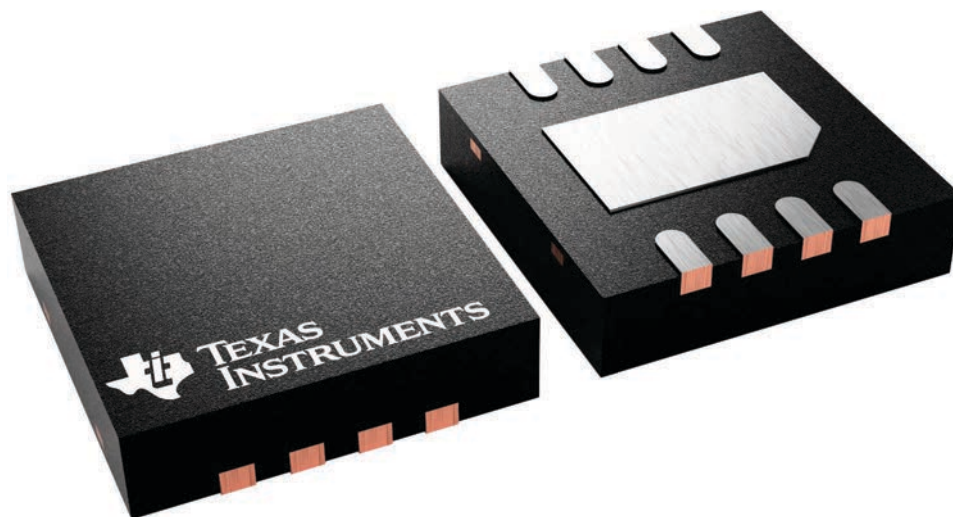

4225794/A

EXAMPLE BOARD LAYOUT

DRG0008A

WSON - 0.8 mm max height

PLASTIC SMALL OUTLINE - NO LEAD

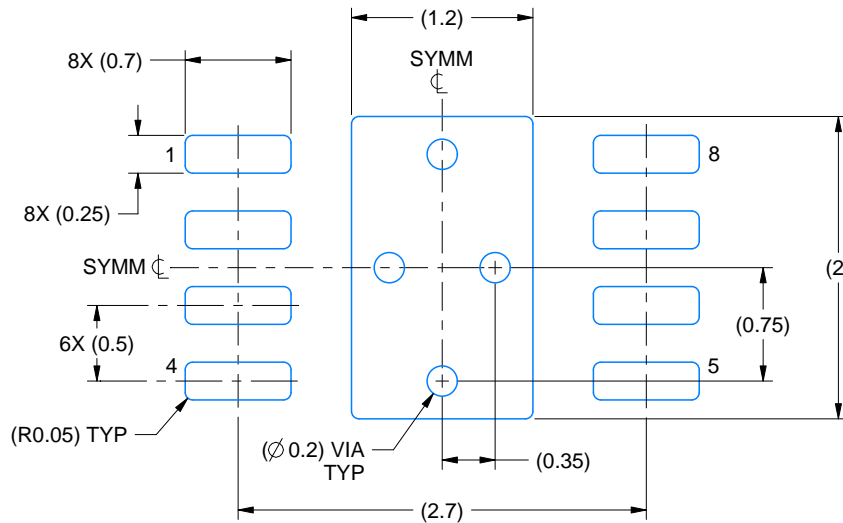

LAND PATTERN EXAMPLE
EXPOSED METAL SHOWN
SCALE:20X

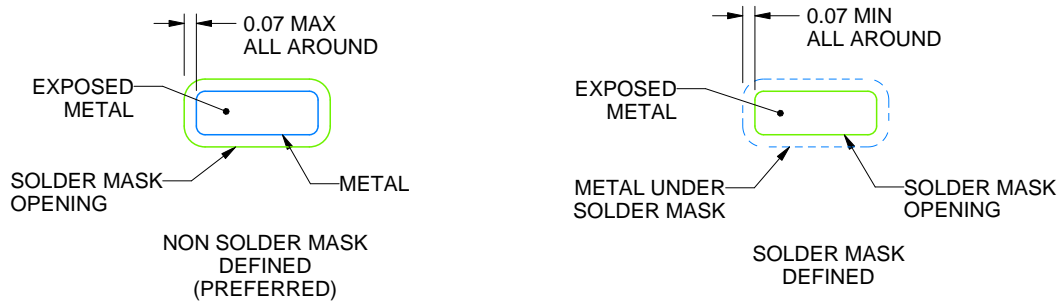

SOLDER MASK DETAILS

4218885/A 03/2020

NOTES: (continued)

4. This package is designed to be soldered to a thermal pad on the board. For more information, see Texas Instruments literature number SLUA271 (www.ti.com/lit/slua271).
5. Vias are optional depending on application, refer to device data sheet. If any vias are implemented, refer to their locations shown on this view. It is recommended that vias under paste be filled, plugged or tented.

EXAMPLE STENCIL DESIGN

DRG0008A

WSON - 0.8 mm max height

PLASTIC SMALL OUTLINE - NO LEAD

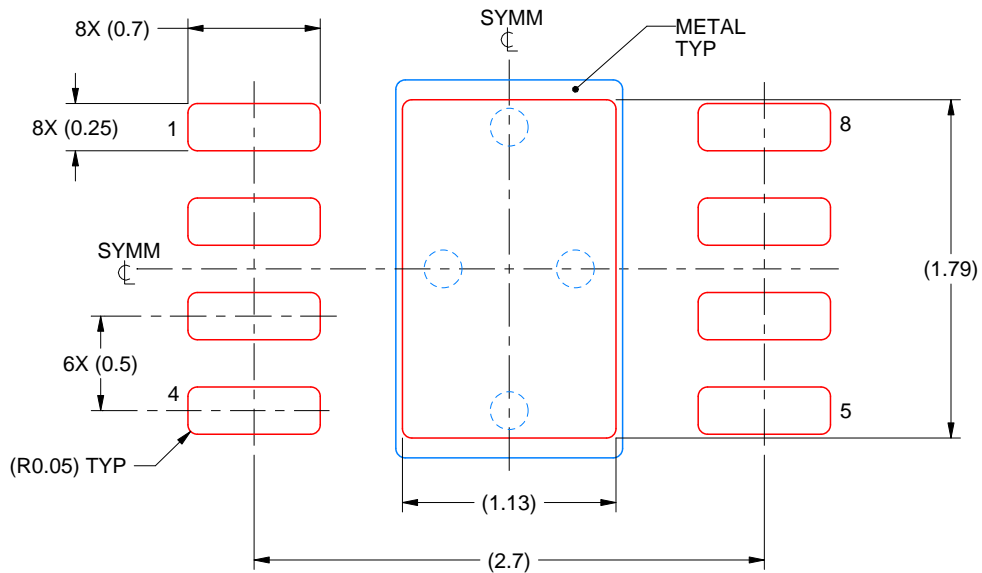

SOLDER PASTE EXAMPLE
BASED ON 0.125 mm THICK STENCIL

EXPOSED PAD
84% PRINTED SOLDER COVERAGE BY AREA
SCALE:25X

4218885/A 03/2020

NOTES: (continued)

6. Laser cutting apertures with trapezoidal walls and rounded corners may offer better paste release. IPC-7525 may have alternate design recommendations.

DCK0005A



PACKAGE OUTLINE

SOT - 1.1 max height

SMALL OUTLINE TRANSISTOR

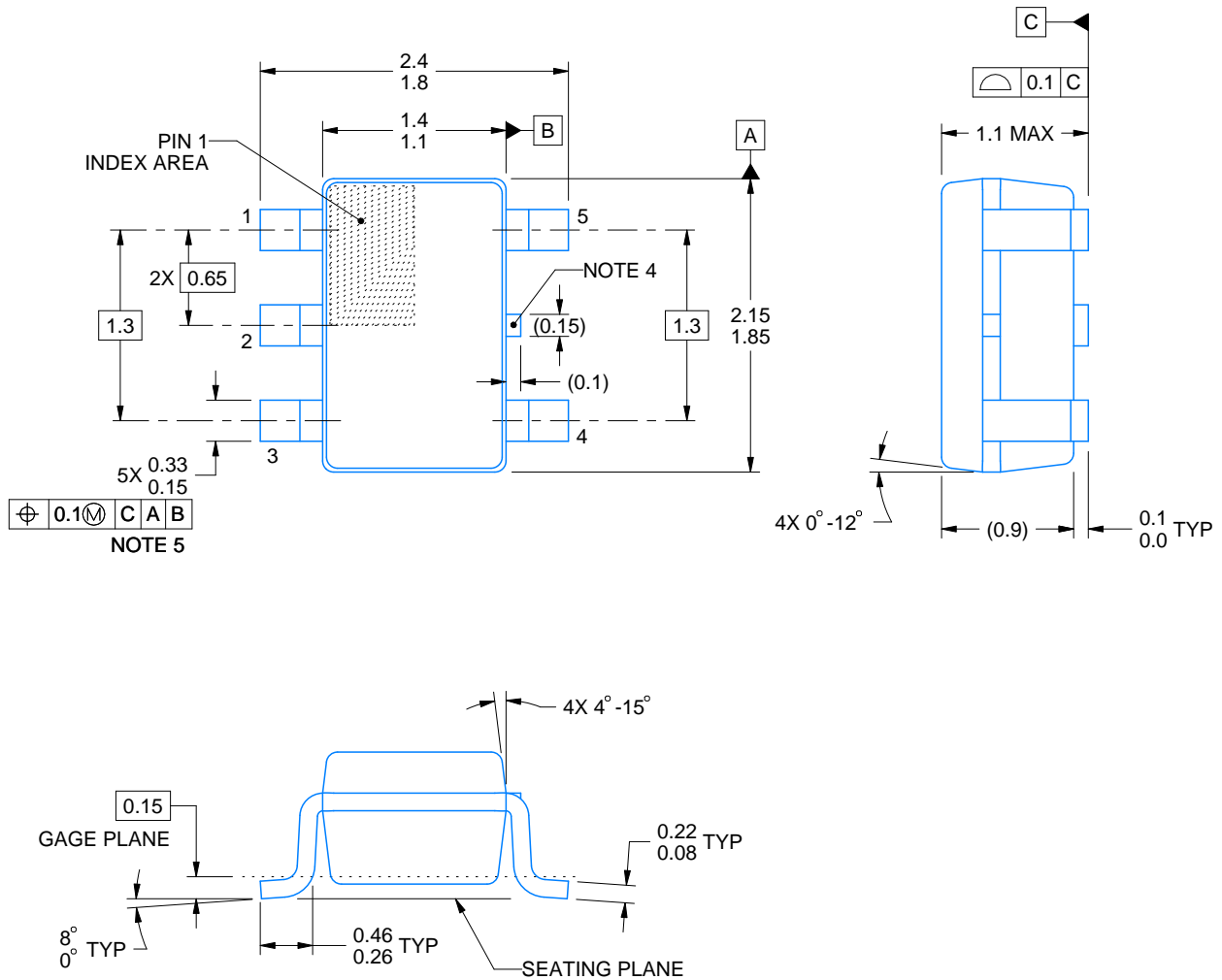

4214834/G 11/2024

NOTES:

1. All linear dimensions are in millimeters. Any dimensions in parenthesis are for reference only. Dimensioning and tolerancing per ASME Y14.5M.
2. This drawing is subject to change without notice.
3. Reference JEDEC MO-203.
4. Support pin may differ or may not be present.
5. Lead width does not comply with JEDEC.
6. Body dimensions do not include mold flash, protrusions, or gate burrs. Mold flash, protrusions, or gate burrs shall not exceed 0.25mm per side

EXAMPLE BOARD LAYOUT

DCK0005A

SOT - 1.1 max height

SMALL OUTLINE TRANSISTOR



LAND PATTERN EXAMPLE
EXPOSED METAL SHOWN
SCALE:18X



SOLDER MASK DETAILS

4214834/G 11/2024

NOTES: (continued)

- 7. Publication IPC-7351 may have alternate designs.
- 8. Solder mask tolerances between and around signal pads can vary based on board fabrication site.

EXAMPLE STENCIL DESIGN

DCK0005A

SOT - 1.1 max height

SMALL OUTLINE TRANSISTOR



SOLDER PASTE EXAMPLE
BASED ON 0.125 THICK STENCIL
SCALE:18X

4214834/G 11/2024

NOTES: (continued)

9. Laser cutting apertures with trapezoidal walls and rounded corners may offer better paste release. IPC-7525 may have alternate design recommendations.
10. Board assembly site may have different recommendations for stencil design.



D0008A

PACKAGE OUTLINE

SOIC - 1.75 mm max height

SMALL OUTLINE INTEGRATED CIRCUIT



4214825/C 02/2019

NOTES:

1. Linear dimensions are in inches [millimeters]. Dimensions in parenthesis are for reference only. Controlling dimensions are in inches. Dimensioning and tolerancing per ASME Y14.5M.
2. This drawing is subject to change without notice.
3. This dimension does not include mold flash, protrusions, or gate burrs. Mold flash, protrusions, or gate burrs shall not exceed $.006$ [0.15] per side.
4. This dimension does not include interlead flash.
5. Reference JEDEC registration MS-012, variation AA.

EXAMPLE BOARD LAYOUT

D0008A

SOIC - 1.75 mm max height

SMALL OUTLINE INTEGRATED CIRCUIT



LAND PATTERN EXAMPLE
 EXPOSED METAL SHOWN
 SCALE:8X



SOLDER MASK DETAILS

4214825/C 02/2019

NOTES: (continued)

- 6. Publication IPC-7351 may have alternate designs.
- 7. Solder mask tolerances between and around signal pads can vary based on board fabrication site.

EXAMPLE STENCIL DESIGN

D0008A

SOIC - 1.75 mm max height

SMALL OUTLINE INTEGRATED CIRCUIT



SOLDER PASTE EXAMPLE
BASED ON .005 INCH [0.125 MM] THICK STENCIL
SCALE:8X

4214825/C 02/2019

NOTES: (continued)

8. Laser cutting apertures with trapezoidal walls and rounded corners may offer better paste release. IPC-7525 may have alternate design recommendations.
9. Board assembly site may have different recommendations for stencil design.

PW0014A



PACKAGE OUTLINE
TSSOP - 1.2 mm max height

SMALL OUTLINE PACKAGE



4220202/B 12/2023

NOTES:

1. All linear dimensions are in millimeters. Any dimensions in parenthesis are for reference only. Dimensioning and tolerancing per ASME Y14.5M.
2. This drawing is subject to change without notice.
3. This dimension does not include mold flash, protrusions, or gate burrs. Mold flash, protrusions, or gate burrs shall not exceed 0.15 mm per side.
4. This dimension does not include interlead flash. Interlead flash shall not exceed 0.25 mm per side.
5. Reference JEDEC registration MO-153.

EXAMPLE BOARD LAYOUT

PW0014A

TSSOP - 1.2 mm max height

SMALL OUTLINE PACKAGE



LAND PATTERN EXAMPLE
EXPOSED METAL SHOWN
SCALE: 10X



4220202/B 12/2023

NOTES: (continued)

- 6. Publication IPC-7351 may have alternate designs.
- 7. Solder mask tolerances between and around signal pads can vary based on board fabrication site.

EXAMPLE STENCIL DESIGN

PW0014A

TSSOP - 1.2 mm max height

SMALL OUTLINE PACKAGE



SOLDER PASTE EXAMPLE
BASED ON 0.125 mm THICK STENCIL
SCALE: 10X

4220202/B 12/2023

NOTES: (continued)

8. Laser cutting apertures with trapezoidal walls and rounded corners may offer better paste release. IPC-7525 may have alternate design recommendations.
9. Board assembly site may have different recommendations for stencil design.

IMPORTANT NOTICE AND DISCLAIMER

TI PROVIDES TECHNICAL AND RELIABILITY DATA (INCLUDING DATASHEETS), DESIGN RESOURCES (INCLUDING REFERENCE DESIGNS), APPLICATION OR OTHER DESIGN ADVICE, WEB TOOLS, SAFETY INFORMATION, AND OTHER RESOURCES "AS IS" AND WITH ALL FAULTS, AND DISCLAIMS ALL WARRANTIES, EXPRESS AND IMPLIED, INCLUDING WITHOUT LIMITATION ANY IMPLIED WARRANTIES OF MERCHANTABILITY, FITNESS FOR A PARTICULAR PURPOSE OR NON-INFRINGEMENT OF THIRD PARTY INTELLECTUAL PROPERTY RIGHTS.

These resources are intended for skilled developers designing with TI products. You are solely responsible for (1) selecting the appropriate TI products for your application, (2) designing, validating and testing your application, and (3) ensuring your application meets applicable standards, and any other safety, security, regulatory or other requirements.

These resources are subject to change without notice. TI grants you permission to use these resources only for development of an application that uses the TI products described in the resource. Other reproduction and display of these resources is prohibited. No license is granted to any other TI intellectual property right or to any third party intellectual property right. TI disclaims responsibility for, and you fully indemnify TI and its representatives against any claims, damages, costs, losses, and liabilities arising out of your use of these resources.

TI's products are provided subject to [TI's Terms of Sale](#), [TI's General Quality Guidelines](#), or other applicable terms available either on ti.com or provided in conjunction with such TI products. TI's provision of these resources does not expand or otherwise alter TI's applicable warranties or warranty disclaimers for TI products. Unless TI explicitly designates a product as custom or customer-specified, TI products are standard, catalog, general purpose devices.

TI objects to and rejects any additional or different terms you may propose.

Copyright © 2026, Texas Instruments Incorporated

Last updated 10/2025