

Table of Contents

1 特長.....	1	7.3 Feature Description.....	26
2 アプリケーション.....	1	7.4 Device Functional Modes.....	29
3 概要.....	1	8 Application and Implementation.....	30
4 Revision History.....	2	8.1 Application Information.....	30
5 Pin Configuration and Functions.....	3	8.2 Typical Applications.....	49
6 Specifications.....	4	9 Power Supply Recommendations.....	50
6.1 Absolute Maximum Ratings.....	4	10 Layout.....	51
6.2 ESD Ratings.....	4	10.1 Layout Guidelines.....	51
6.3 Recommended Operating Conditions.....	5	10.2 Layout Example.....	51
6.4 Thermal Information.....	5	11 Device and Documentation Support.....	52
6.5 Electrical Characteristics: General.....	6	11.1 Device Support.....	52
6.6 Electrical Characteristics: TPS7A8400A.....	7	11.2 Documentation Support.....	52
6.7 Electrical Characteristics: TPS7A8401A.....	8	11.3 ドキュメントの更新通知を受け取る方法.....	52
6.8 Typical Characteristics: TPS7A8400A.....	9	11.4 サポート・リソース.....	52
6.9 Typical Characteristics: TPS7A8401A.....	16	11.5 Trademarks.....	52
7 Detailed Description.....	24	11.6 静電気放電に関する注意事項.....	52
7.1 Overview.....	24	11.7 用語集.....	53
7.2 Functional Block Diagrams.....	24		

4 Revision History

資料番号末尾の英字は改訂を表しています。その改訂履歴は英語版に準じています。

Changes from Revision B (June 2020) to Revision C (December 2020)	Page
• 文書全体にわたって表と図の採番方法を更新.....	1
• TPS7A8401A をプレビューから量産データに変更.....	1
• Changed noise plots.....	16
Changes from Revision A (April 2020) to Revision B (June 2020)	Page
• TPS7A8401A のステータスを「事前情報」から「量産データ」に変更.....	1
• changed pin function allocation of TPS7A8401A to match pinout.....	3
• Changed <i>PSRR vs Frequency and C_{OUT}</i> figure condition statement.....	9
• Added <i>Typical Characteristics: TPS7A8401A</i> section.....	16
Changes from Revision * (April 2017) to Revision A (April 2020)	Page
• ドキュメントに TPS7A8401A を追加.....	1
• 「特長」セクションから低熱抵抗の箇条書き項目を削除.....	1
• 「アプリケーション」セクションを変更.....	1
• 「概要」セクションで TPS7A8400A の説明に「50mV 刻みで」を追加.....	1
• Added TPS7A8401A to <i>Pin Configurations and Functions</i> section.....	3
• Added <i>Recommended Feedback-Resistor Values (TPS7A8401A)</i> table.....	30
• Added <i>ADDITIVE OUTPUT VOLTAGE LEVEL (TPS7A8401A)</i> column to <i>ANY-OUT Programmable Output Voltage (RGR Package)</i> table.....	31
• Added <i>TPS7A8401A User-Configurable Output Voltage Settings</i> table.....	31
• Changed RGR Package to TPS7A8400A in title of <i>ANY-OUT Programmable Output Voltage With 800 mV Tied to SNS (TPS7A8400A)</i> table.....	36
• Changed <i>Current Sharing</i> section.....	36

5 Pin Configuration and Functions

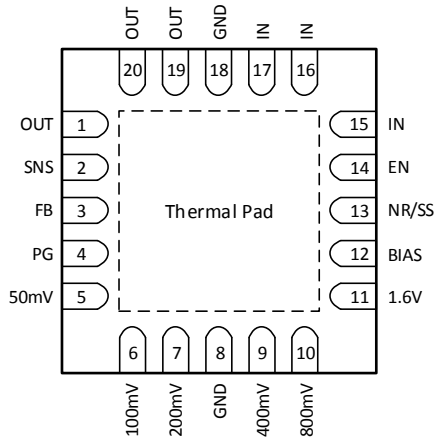

5-1. RGR Package (TPS7A8400A), 20-Pin VQFN, Top View

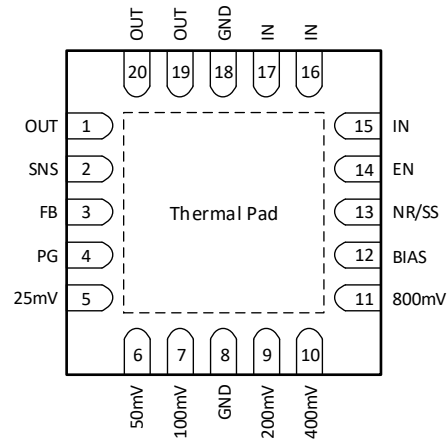

5-2. RGR Package (TPS7A8401A), 20-Pin VQFN, Top View

表 5-1. Pin Functions

PIN	TPS7A8400A	TPS7A8401A	I/O	DESCRIPTION
25mV	—	5	I	ANY-OUT voltage setting pins. These pins connect to an internal feedback network. Connect these pins to ground, SNS, or leave floating. Connecting these pins to ground increases the output voltage, whereas connecting these pins to SNS increases the resolution of the ANY-OUT network but decreases the range of the network; multiple pins may be simultaneously connected to GND or SNS to select the desired output voltage. Leave these pins floating (open) when not in use. See the ANY-OUT Programmable Output Voltage section for additional details.
50mV	5	6		
100mV	6	7		
200mV	7	9		
400mV	9	10		
800mV	10	11		
1.6V	11	—		
BIAS	12	12	I	BIAS supply voltage. This pin enables the use of low-input voltage, low-output (LILo) voltage conditions (that is, $V_{IN} = 1.2\text{ V}$, $V_{OUT} = 1\text{ V}$) to reduce power dissipation across the die. The use of a BIAS voltage improves dc and ac performance for $V_{IN} \leq 2.2\text{ V}$. A 1- μF capacitor (0.47- μF capacitance) or larger must be connected between this pin and ground. If not used, this pin must be left floating or tied to ground.
EN	14	14	I	Enable pin. Driving this pin to logic high enables the device; driving this pin to logic low disables the device. If enable functionality is not required, this pin must be connected to IN or BIAS.
FB	3	3	I	Feedback pin connected to the error amplifier. Although not required, TI recommends a 10-nF feed-forward capacitor from FB to OUT (as close to the device as possible) to maximize ac performance. The use of a feed-forward capacitor may disrupt Power-Good (PG) functionality. See the ANY-OUT Programmable Output Voltage and Adjustable Operation sections for more details.
GND	8, 18	8, 18	—	Ground pin. These pins must be connected to ground, the thermal pad, and each other with a low-impedance connection.
IN	15-17	15-17	I	Input supply voltage pin. A 10- μF or larger ceramic capacitor (5 μF of capacitance or greater) from IN to ground is required to reduce the impedance of the input supply. Place the input capacitor as close as possible to the input. See the Input and Output Capacitor Requirements section for more details.

表 5-1. Pin Functions (continued)

PIN	TPS7A8400A	TPS7A8401A	I/O	DESCRIPTION
NR/SS	13	13	—	Noise-reduction and soft-start pin. Connecting an external capacitor between this pin and ground reduces reference voltage noise and also enables the soft-start function. Although not required, TI recommends a 10-nF or larger capacitor be connected from NR/SS to GND (as close as possible to the pin) to maximize ac performance. See the <i>Input and Output Capacitor Requirements</i> section for more details.
OUT	1, 19, 20	1, 19, 20	O	Regulated output pin. A 47- μ F or larger ceramic capacitor (25 μ F of capacitance or greater) from OUT to ground is required for stability and must be placed as close as possible to the output. Minimize the impedance from the OUT pin to the load. See the <i>Input and Output Capacitor Requirements</i> sections for more details.
PG	4	4	O	Active-high, PG pin. An open-drain output indicates when the output voltage reaches $V_{IT(PG)}$ of the target. The use of a feed-forward capacitor may disrupt PG functionality. See the <i>Input and Output Capacitor Requirements</i> sections for more details.
SNS	2	2	I	Output voltage sense input pin. This pin connects the internal R_1 resistor to the output. Connect this pin to the load side of the output trace only if the ANY-OUT feature is used. If the ANY-OUT feature is not used, leave this pin floating. See the <i>ANY-OUT Programmable Output Voltage and Adjustable Operation</i> sections for more details.
Thermal pad			—	Connect the thermal pad to a large-area ground plane. The thermal pad is internally connected to GND.

6 Specifications

6.1 Absolute Maximum Ratings

over junction temperature range (unless otherwise noted)⁽¹⁾

		MIN	MAX	UNIT
Voltage	IN, BIAS, PG, EN	-0.3	7.0	V
	IN, BIAS, PG, EN (5% duty cycle, pulse duration = 200 μ s)	-0.3	7.5	V
	SNS, OUT	-0.3	$V_{IN} + 0.3$ ⁽²⁾	V
	NR/SS, FB	-0.3	3.6	V
	50mV, 100mV, 200mV, 400mV, 800mV, 1.6V	-0.3	$V_{OUT} + 0.3$	V
Current	OUT	Internally limited	Internally limited	A
	PG (sink current into device)		5	mA
Temperature	Operating junction, T_J	-55	150	°C
	Storage, T_{stg}	-55	150	

- (1) Stresses beyond those listed under *Absolute Maximum Ratings* may cause permanent damage to the device. These are stress ratings only, which do not imply functional operation of the device at these or any other conditions beyond those indicated under *Recommended Operating Conditions*. Exposure to absolute-maximum-rated conditions for extended periods may affect device reliability.
- (2) The absolute maximum rating is $V_{IN} + 0.3$ V or 7.0 V, whichever is smaller.

6.2 ESD Ratings

			VALUE	UNIT
$V_{(ESD)}$	Electrostatic discharge	Human-body model (HBM), per ANSI/ESDA/JEDEC JS-001 ⁽¹⁾	± 2000	V
		Charged-device model (CDM), per JEDEC specification JESD22-C101 ⁽²⁾	± 500	

- (1) JEDEC document JEP155 states that 500-V HBM allows safe manufacturing with a standard ESD control process.
- (2) JEDEC document JEP157 states that 250-V CDM allows safe manufacturing with a standard ESD control process.

6.3 Recommended Operating Conditions

over junction temperature range (unless otherwise noted)

		MIN	NOM	MAX	UNIT
V _{IN}	Input supply voltage range	1.1		6.5	V
V _{BIAS}	Bias supply voltage range ⁽¹⁾	3.0		6.5	V
V _{OUT}	Output voltage range (TPS7A8400A) ⁽²⁾	0.8		5.15	V
V _{OUT}	Output voltage range (TPS7A8401A) ⁽²⁾	0.5		5.15	V
V _{EN}	Enable voltage range	0		V _{IN}	V
I _{OUT}	Output current	0		3	A
C _{IN}	Input capacitor	10	47		μF
C _{OUT}	Output capacitor	47	47 10 10 ⁽³⁾		μF
C _{BIAS}	Bias pin capacitor	1	10		μF
R _{PG}	Power-good pullup resistance	10		100	kΩ
C _{NR/SS}	NR/SS capacitor		10		nF
C _{FF}	Feed-forward capacitor		10		nF
R ₁	Top resistor value in feedback network for adjustable operation		12.1 ⁽⁴⁾		kΩ
R ₂	Bottom resistor value in feedback network for adjustable operation			160 ⁽⁵⁾	kΩ
T _J	Operating junction temperature	-40		125	°C

- (1) BIAS supply is required when the V_{IN} supply is below 1.4 V. Conversely, no BIAS supply is required when the V_{IN} supply is higher than or equal to 1.4 V. A BIAS supply helps improve dc and ac performance for V_{IN} ≤ 2.2 V.
- (2) This output voltage range does not include device accuracy or accuracy of the feedback resistors.
- (3) The recommended output capacitors are selected to optimize PSRR for the frequency range of 400 kHz to 700 kHz. This frequency range is a typical value for dc-dc supplies.
- (4) The 12.1-kΩ resistor is selected to optimize PSRR and noise by matching the internal R₁ value.
- (5) The upper limit for the R₂ resistor is to ensure accuracy by making the current through the feedback network much larger than the leakage current into the feedback node.

6.4 Thermal Information

THERMAL METRIC ⁽¹⁾		TPS7A84A	UNIT
		RGR (VQFN)	
		20 PINS	
R _{θJA}	Junction-to-ambient thermal resistance	43.4	°C/W
R _{θJC(top)}	Junction-to-case (top) thermal resistance	36.8	°C/W
R _{θJB}	Junction-to-board thermal resistance	17.6	°C/W
ψ _{JT}	Junction-to-top characterization parameter	0.8	°C/W
ψ _{JB}	Junction-to-board characterization parameter	17.6	°C/W
R _{θJC(bot)}	Junction-to-case (bottom) thermal resistance	3.4	°C/W

- (1) For more information about traditional and new thermal metrics, see the [Semiconductor and IC Package Thermal Metrics](#) application report.

6.5 Electrical Characteristics: General

Over operating junction temperature range ($T_J = -40^\circ\text{C}$ to $+125^\circ\text{C}$), $V_{IN} = 1.4\text{ V}$ or $V_{IN} = V_{OUT(nom)} + 0.4\text{ V}$ (whichever is greater), $V_{BIAS} = \text{open}$, $V_{OUT(nom)} = 0.8\text{ V}$ ⁽¹⁾, OUT connected to $50\ \Omega$ to GND⁽²⁾, $V_{EN} = 1.1\text{ V}$, $C_{IN} = 10\ \mu\text{F}$, $C_{OUT} = 47\ \mu\text{F}$, $C_{NR/SS} = 0\text{ nF}$, without C_{FF} , and PG pin pulled up to V_{IN} with $100\text{ k}\Omega$, unless otherwise noted. Typical values are at $T_J = 25^\circ\text{C}$.

PARAMETER		TEST CONDITIONS	MIN	TYP	MAX	UNIT
$V_{UVLO1(IN)}$	Input supply UVLO with BIAS	V_{IN} rising with $V_{BIAS} = 3.0\text{ V}$		1.02	1.085	V
$V_{HYS1(IN)}$	$V_{UVLO1(IN)}$ hysteresis	$V_{BIAS} = 3.0\text{ V}$		320		mV
$V_{UVLO2(IN)}$	Input supply UVLO without BIAS	V_{IN} rising		1.31	1.39	V
$V_{HYS2(IN)}$	$V_{UVLO2(IN)}$ hysteresis			253		mV
$V_{UVLO(BIAS)}$	Bias supply UVLO	V_{BIAS} rising, $V_{IN} = 1.1\text{ V}$		2.83	2.9	V
$V_{HYS(BIAS)}$	$V_{UVLO(BIAS)}$ hysteresis	$V_{IN} = 1.1\text{ V}$		290		mV
I_{EN}	EN pin current	$V_{IN} = 6.5\text{ V}$, $V_{EN} = 0\text{ V}$ and 6.5 V	-0.1		0.1	μA
I_{BIAS}	BIAS pin current	$V_{IN} = 1.1\text{ V}$, $V_{BIAS} = 6.5\text{ V}$, $V_{OUT(nom)} = 0.8\text{ V}$, $I_{OUT} = 3\text{ A}$		2.4	3.5	mA
$V_{IL(EN)}$	EN pin low-level input voltage (disable device)		0		0.5	V
$V_{IH(EN)}$	EN pin high-level input voltage (enable device)		1.1		6.5	V
$V_{OL(PG)}$	PG pin low-level output voltage	$V_{OUT} < V_{IT(PG)}$, $I_{PG} = -1\text{ mA}$ (current into device)			0.4	V
$I_{kg(PG)}$	PG pin leakage current	$V_{OUT} > V_{IT(PG)}$, $V_{PG} = 6.5\text{ V}$			1	μA
$I_{NR/SS}$	NR/SS pin charging current	$V_{NR/SS} = \text{GND}$, $V_{IN} = 6.5\text{ V}$	4.0	6.6	9.0	μA
I_{FB}	FB pin leakage current	$V_{IN} = 6.5\text{ V}$	-100		100	nA
T_{sd}	Thermal shutdown temperature	Shutdown, temperature increasing		160		$^\circ\text{C}$
		Reset, temperature decreasing		140		
T_J	Operating junction temperature		-40		125	$^\circ\text{C}$

- $V_{OUT(nom)}$ is the calculated V_{OUT} target value from the ANY-OUT in a fixed configuration. In an adjustable configuration, $V_{OUT(nom)}$ is the expected V_{OUT} value set by the external feedback resistors.
- This $50\text{-}\Omega$ load is disconnected when the test conditions specify an I_{OUT} value.

6.6 Electrical Characteristics: TPS7A8400A

Over operating junction temperature range ($T_J = -40^\circ\text{C}$ to $+125^\circ\text{C}$), $V_{IN} = 1.4\text{ V}$ or $V_{IN} = V_{OUT(nom)} + 0.4\text{ V}$ (whichever is greater), $V_{BIAS} = \text{open}$, $V_{OUT(nom)} = 0.8\text{ V}$ ⁽¹⁾, OUT connected to $50\ \Omega$ to GND⁽²⁾, $V_{EN} = 1.1\text{ V}$, $C_{IN} = 10\ \mu\text{F}$, $C_{OUT} = 47\ \mu\text{F}$, $C_{NR/SS} = 0\text{ nF}$, without C_{FF} , and PG pin pulled up to V_{IN} with $100\ \text{k}\Omega$, unless otherwise noted. Typical values are at $T_J = 25^\circ\text{C}$.

PARAMETER		TEST CONDITIONS	MIN	TYP	MAX	UNIT
V_{FB}	Feedback voltage			0.8		V
$V_{NR/SS}$	NR/SS pin voltage			0.8		V
V_{OUT}	Output voltage	Range	Using the ANY-OUT pins	0.8 – 1.0%	3.95 + 1.0%	V
		Range	Using external resistors ⁽³⁾	0.8 – 1.0%	5.15 + 1.0%	
		Accuracy ^{(3) (4)}	$0.8\text{ V} \leq V_{OUT} \leq 5.15$ ⁽⁵⁾ V, $5\text{ mA} \leq I_{OUT} \leq 3\text{ A}$, over V_{IN}	-1.0%		1.0%
		Accuracy with BIAS	$1.1\text{ V} \leq V_{IN} \leq 2.2\text{ V}$, $5\text{ mA} \leq I_{OUT} \leq 3\text{ A}$, $3.0\text{ V} \leq V_{BIAS} \leq 6.5\text{ V}$	-0.75%		0.75%
$\Delta V_{OUT}/\Delta V_{IN}$	Line regulation	$I_{OUT} = 5\text{ mA}$, $1.4\text{ V} \leq V_{IN} \leq 6.5\text{ V}$		0.03		mV/V
$\Delta V_{OUT}/\Delta I_{OUT}$	Load regulation	$5\text{ mA} \leq I_{OUT} \leq 3\text{ A}$, $3.0\text{ V} \leq V_{BIAS} \leq 6.5\text{ V}$, $V_{IN} = 1.1\text{ V}$		0.07		mV/A
		$5\text{ mA} \leq I_{OUT} \leq 3\text{ A}$		0.08		
		$5\text{ mA} \leq I_{OUT} \leq 3\text{ A}$, $V_{OUT} = 5.15\text{ V}$		0.04		
V_{DO}	Dropout voltage	$V_{IN} = 1.4\text{ V}$, $I_{OUT} = 3\text{ A}$, $V_{FB} = 0.8\text{ V} - 3\%$		155	250	mV
		$V_{IN} = 5.4\text{ V}$, $I_{OUT} = 3\text{ A}$, $V_{FB} = 0.8\text{ V} - 3\%$		225	340	
		$V_{IN} = 5.6\text{ V}$, $I_{OUT} = 3\text{ A}$, $V_{FB} = 0.8\text{ V} - 3\%$		270	450	
		$V_{IN} = 1.1\text{ V}$, $V_{BIAS} = 5\text{ V}$, $I_{OUT} = 3\text{ A}$, $V_{FB} = 0.8\text{ V} - 3\%$		110	180	
I_{LIM}	Output current limit	V_{OUT} forced at $0.9 \times V_{OUT(nom)}$, $V_{IN} = V_{OUT(nom)} + 0.4\text{ V}$	3.7	4.2	4.7	A
I_{SC}	Short-circuit current limit	$R_{LOAD} = 20\ \text{m}\Omega$, under foldback operation		1.0		A
PSRR	Power-supply ripple rejection	$V_{IN} - V_{OUT} = 0.4\text{ V}$, $I_{OUT} = 3\text{ A}$, $C_{NR/SS} = 100\ \text{nF}$, $C_{FF} = 10\ \text{nF}$, $C_{OUT} = 22\ \mu\text{F}$	$f = 10\ \text{kHz}$, $V_{OUT} = 0.8\text{ V}$, $V_{BIAS} = 5.0\text{ V}$		42	dB
			$f = 500\ \text{kHz}$, $V_{OUT} = 0.8\text{ V}$, $V_{BIAS} = 5.0\text{ V}$		39	
			$f = 10\ \text{kHz}$, $V_{OUT} = 5.0\text{ V}$		40	
			$f = 500\ \text{kHz}$, $V_{OUT} = 5.0\text{ V}$		25	
V_n	Output noise voltage	$BW = 10\ \text{Hz}$ to $100\ \text{kHz}$, $V_{IN} = 1.1\text{ V}$, $V_{OUT} = 0.8\text{ V}$, $V_{BIAS} = 5.0\text{ V}$, $I_{OUT} = 3\text{ A}$, $C_{NR/SS} = 100\ \text{nF}$, $C_{FF} = 10\ \text{nF}$, $C_{OUT} = 47\ \mu\text{F} \parallel 10\ \mu\text{F} \parallel 10\ \mu\text{F}$		4.4		μV_{RMS}
		$BW = 10\ \text{Hz}$ to $100\ \text{kHz}$, $V_{OUT} = 5.0\text{ V}$, $I_{OUT} = 3\text{ A}$, $C_{NR/SS} = 100\ \text{nF}$, $C_{FF} = 10\ \text{nF}$, $C_{OUT} = 47\ \mu\text{F} \parallel 10\ \mu\text{F} \parallel 10\ \mu\text{F}$		7.7		
I_{GND}	GND pin current	$V_{IN} = 6.5\text{ V}$, $I_{OUT} = 5\text{ mA}$		3	4	mA
		$V_{IN} = 1.4\text{ V}$, $I_{OUT} = 3\text{ A}$		4.3	5.5	
		Shutdown, PG = open, $V_{IN} = 6.5\text{ V}$, $V_{EN} = 0.5\text{ V}$		1.2	25	
$V_{IT(PG)}$	PG pin threshold	For falling V_{OUT}	$82\% \times V_{OUT}$	$88\% \times V_{OUT}$	$93\% \times V_{OUT}$	V
$V_{HYS(PG)}$	PG pin hysteresis	For rising V_{OUT}	$2\% \times V_{OUT}$			V

- (1) $V_{OUT(nom)}$ is the calculated V_{OUT} target value from the ANY-OUT in a fixed configuration. In an adjustable configuration, $V_{OUT(nom)}$ is the expected V_{OUT} value set by the external feedback resistors.
- (2) This $50\text{-}\Omega$ load is disconnected when the test conditions specify an I_{OUT} value.
- (3) When the device is connected to external feedback resistors at the FB pin, external resistor tolerances are not included.
- (4) The device is not tested under conditions where $V_{IN} > V_{OUT} + 1.7\text{ V}$ and $I_{OUT} = 3\text{ A}$, because the power dissipation is higher than the maximum rating of the package.
- (5) For $V_{OUT} \leq 5\text{ V}$, $V_{IN} = V_{OUT} + 0.4\text{ V}$; For $V_{OUT} > 5\text{ V}$, $V_{IN} = V_{OUT} + 0.45\text{ V}$

6.7 Electrical Characteristics: TPS7A8401A

Over operating junction temperature range ($T_J = -40^\circ\text{C}$ to $+125^\circ\text{C}$), $V_{IN} = 1.4\text{ V}$ or $V_{IN} = V_{OUT(nom)} + 0.4\text{ V}$ (whichever is greater), $V_{BIAS} = \text{open}$, $V_{OUT(nom)} = 0.5\text{ V}$ ⁽¹⁾, OUT connected to $50\ \Omega$ to GND⁽²⁾, $V_{EN} = 1.1\text{ V}$, $C_{IN} = 10\ \mu\text{F}$, $C_{OUT} = 47\ \mu\text{F}$, $C_{NR/SS} = 0\text{ nF}$, without C_{FF} , and PG pin pulled up to V_{IN} with $100\ \text{k}\Omega$, unless otherwise noted. Typical values are at $T_J = 25^\circ\text{C}$.

PARAMETER		TEST CONDITIONS	MIN	TYP	MAX	UNIT	
V_{FB}	Feedback voltage			0.5		V	
$V_{NR/SS}$	NR/SS pin voltage			0.5		V	
V_{OUT}	Output voltage	Range	Using the ANY-OUT pins	0.5 – 1.2%		2.075 + 1.0%	
		Range	Using external resistors ⁽³⁾	0.5 – 1.2%		5.15 + 1.0%	
		Accuracy ^{(3) (4)}	$0.5\text{ V} \leq V_{OUT} \leq 5.15$ ⁽⁵⁾ V, $5\text{ mA} \leq I_{OUT} \leq 3\text{ A}$, over V_{IN}	–1.25%		1.25%	V
		Accuracy with BIAS	$V_{IN} = 1.1\text{ V}$, $V_{OUT} = 0.5\text{ V}$, $5\text{ mA} \leq I_{OUT} \leq 3\text{ A}$, $3.0\text{ V} \leq V_{BIAS} \leq 6.5\text{ V}$	–1.0%		1.1%	
$\Delta V_{OUT}/\Delta V_{IN}$	Line regulation	$I_{OUT} = 5\text{ mA}$, $1.4\text{ V} \leq V_{IN} \leq 6.5\text{ V}$		0.03		mV/V	
$\Delta V_{OUT}/\Delta I_{OUT}$	Load regulation	$5\text{ mA} \leq I_{OUT} \leq 3\text{ A}$, $3.0\text{ V} \leq V_{BIAS} \leq 6.5\text{ V}$, $V_{IN} = 1.1\text{ V}$		0.07		mV/A	
		$5\text{ mA} \leq I_{OUT} \leq 3\text{ A}$		0.08			
		$5\text{ mA} \leq I_{OUT} \leq 3\text{ A}$, $V_{OUT} = 5.15\text{ V}$		0.04			
V_{DO}	Dropout voltage	$V_{IN} = 1.4\text{ V}$, $I_{OUT} = 3\text{ A}$, $V_{FB} = 0.5\text{ V} - 3\%$		155	260	mV	
		$V_{IN} = 5.4\text{ V}$, $I_{OUT} = 3\text{ A}$, $V_{FB} = 0.5\text{ V} - 3\%$		225	375		
		$V_{IN} = 5.6\text{ V}$, $I_{OUT} = 3\text{ A}$, $V_{FB} = 0.5\text{ V} - 3\%$		270	490		
		$V_{IN} = 1.1\text{ V}$, $V_{BIAS} = 5\text{ V}$, $I_{OUT} = 3\text{ A}$, $V_{FB} = 0.5\text{ V} - 3\%$		110	180		
I_{LIM}	Output current limit	V_{OUT} forced at $0.9 \times V_{OUT(nom)}$, $V_{IN} = V_{OUT(nom)} + 0.4\text{ V}$	3.3	4.2	4.75	A	
I_{SC}	Short-circuit current limit	$R_{LOAD} = 20\ \text{m}\Omega$, under foldback operation		2.5		A	
PSRR	Power-supply ripple rejection	$V_{IN} - V_{OUT} = 0.4\text{ V}$, $I_{OUT} = 3\text{ A}$, $C_{NR/SS} = 100\ \text{nF}$, $C_{FF} = 10\ \text{nF}$, $C_{OUT} = 22\ \mu\text{F}$	$f = 10\ \text{kHz}$, $V_{OUT} = 0.5\text{ V}$, $V_{BIAS} = 5.0\text{ V}$		42	dB	
			$f = 500\ \text{kHz}$, $V_{OUT} = 0.5\text{ V}$, $V_{BIAS} = 5.0\text{ V}$		39		
			$f = 10\ \text{kHz}$, $V_{OUT} = 5.0\text{ V}$		40		
			$f = 500\ \text{kHz}$, $V_{OUT} = 5.0\text{ V}$		25		
V_n	Output noise voltage	BW = 10 Hz to 100 kHz, $V_{IN} = 1.1\text{ V}$, $V_{OUT} = 0.5\text{ V}$, $V_{BIAS} = 5.0\text{ V}$, $I_{OUT} = 3\text{ A}$, $C_{NR/SS} = 100\ \text{nF}$, $C_{FF} = 10\ \text{nF}$, $C_{OUT} = 47\ \mu\text{F} \parallel 10\ \mu\text{F} \parallel 10\ \mu\text{F}$		4.8		μV_{RMS}	
			4.8		15.8		
I_{GND}	GND pin current	$V_{IN} = 6.5\text{ V}$, $I_{OUT} = 5\text{ mA}$		3	4.3	mA	
		$V_{IN} = 1.4\text{ V}$, $I_{OUT} = 3\text{ A}$		4.3	5.5		
		Shutdown, PG = open, $V_{IN} = 6.5\text{ V}$, $V_{EN} = 0.5\text{ V}$		1.2	25		μA
$V_{IT(PG)}$	PG pin threshold	For falling V_{OUT}	$80\% \times V_{OUT}$	$86\% \times V_{OUT}$	$91\% \times V_{OUT}$	V	
$V_{HYS(PG)}$	PG pin hysteresis	For rising V_{OUT}		$5\% \times V_{OUT}$		V	

- $V_{OUT(nom)}$ is the calculated V_{OUT} target value from the ANY-OUT in a fixed configuration. In an adjustable configuration, $V_{OUT(nom)}$ is the expected V_{OUT} value set by the external feedback resistors.
- This 50- Ω load is disconnected when the test conditions specify an I_{OUT} value.
- When the device is connected to external feedback resistors at the FB pin, external resistor tolerances are not included.
- The device is not tested under conditions where $V_{IN} > V_{OUT} + 1.7\text{ V}$ and $I_{OUT} = 3\text{ A}$, because the power dissipation is higher than the maximum rating of the package.
- For $V_{OUT} \leq 5\text{ V}$, $V_{IN} = V_{OUT} + 0.4\text{ V}$; For $V_{OUT} > 5\text{ V}$, $V_{IN} = V_{OUT} + 0.45\text{ V}$

6.8 Typical Characteristics: TPS7A8400A

at $T_A = 25^\circ\text{C}$, $V_{IN} = 1.4\text{ V}$ or $V_{IN} = V_{OUT(nom)} + 0.4\text{ V}$ (whichever is greater), $V_{BIAS} = \text{open}$, $V_{OUT(nom)} = 0.8\text{ V}$, $V_{EN} = 1.1\text{ V}$, $C_{IN} = 10\text{ }\mu\text{F}$, $C_{OUT} = 47\text{ }\mu\text{F}$, $C_{NR/SS} = 0\text{ nF}$, no C_{FF} , and PG pin pulled up to V_{IN} with $100\text{ k}\Omega$ (unless otherwise noted)

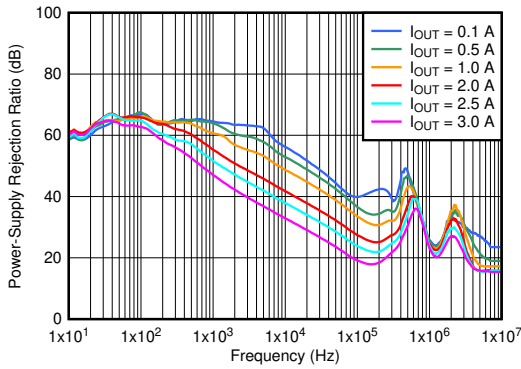

$V_{IN} = 1.1\text{ V}$, $V_{BIAS} = 5\text{ V}$, $C_{OUT} = 47\text{ }\mu\text{F} \parallel 10\text{ }\mu\text{F} \parallel 10\text{ }\mu\text{F}$,
 $C_{NR/SS} = 10\text{ nF}$, $C_{FF} = 10\text{ nF}$

6-1. PSRR vs Frequency and I_{OUT}

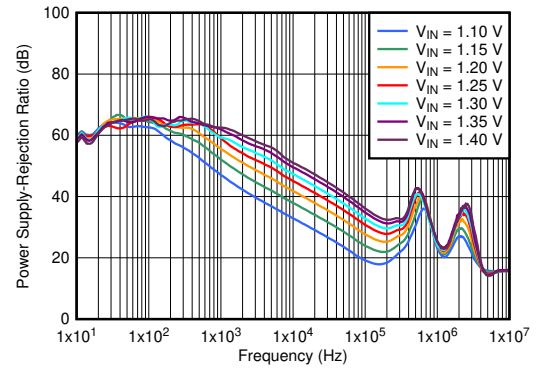

$I_{OUT} = 3\text{ A}$, $V_{BIAS} = 5\text{ V}$, $C_{OUT} = 47\text{ }\mu\text{F} \parallel 10\text{ }\mu\text{F} \parallel 10\text{ }\mu\text{F}$,
 $C_{NR/SS} = 10\text{ nF}$, $C_{FF} = 10\text{ nF}$

6-2. PSRR vs Frequency and V_{IN} With Bias

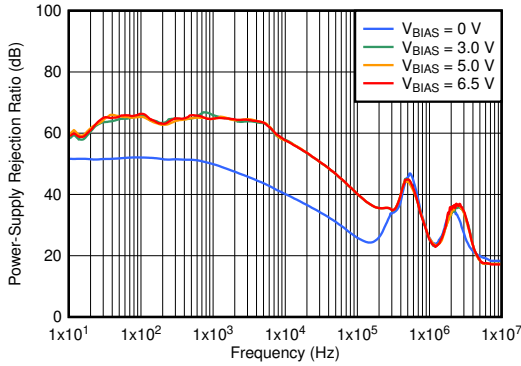

$V_{IN} = 1.4\text{ V}$, $I_{OUT} = 1\text{ A}$, $C_{OUT} = 47\text{ }\mu\text{F} \parallel 10\text{ }\mu\text{F} \parallel 10\text{ }\mu\text{F}$,
 $C_{NR/SS} = 10\text{ nF}$, $C_{FF} = 10\text{ nF}$

6-3. PSRR vs Frequency and V_{BIAS}

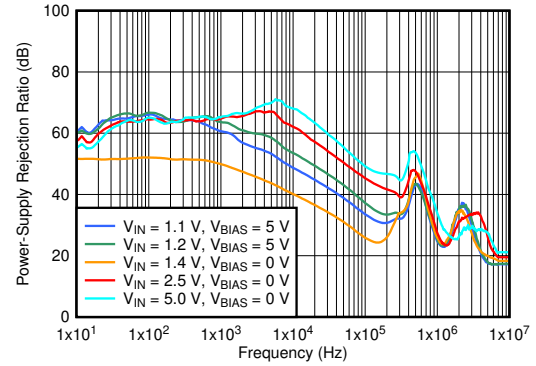

$I_{OUT} = 1\text{ A}$, $C_{OUT} = 47\text{ }\mu\text{F} \parallel 10\text{ }\mu\text{F} \parallel 10\text{ }\mu\text{F}$,
 $C_{NR/SS} = 10\text{ nF}$, $C_{FF} = 10\text{ nF}$

6-4. PSRR vs Frequency and V_{IN}

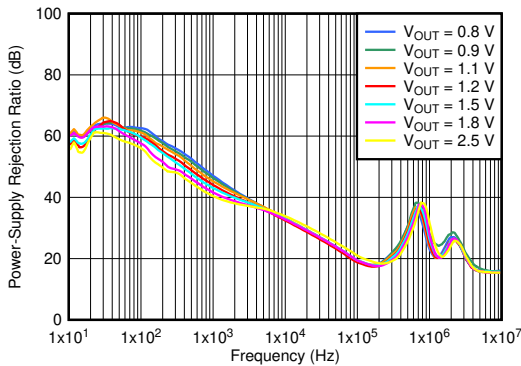

$V_{IN} = V_{OUT} + 0.3\text{ V}$, $V_{BIAS} = 5\text{ V}$, $I_{OUT} = 3\text{ A}$, $C_{OUT} = 47\text{ }\mu\text{F} \parallel 10\text{ }\mu\text{F} \parallel 10\text{ }\mu\text{F}$,
 $C_{NR/SS} = 10\text{ nF}$, $C_{FF} = 10\text{ nF}$

6-5. PSRR vs Frequency and V_{OUT} With Bias

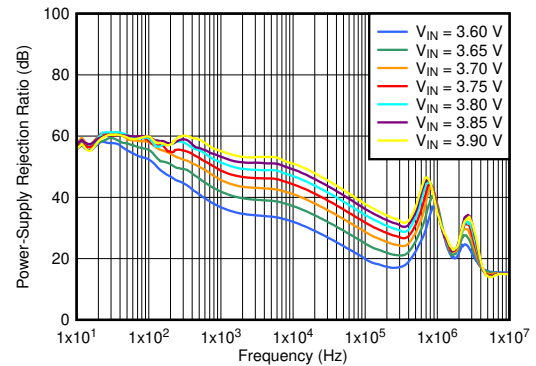

$I_{OUT} = 3\text{ A}$, $C_{OUT} = 47\text{ }\mu\text{F} \parallel 10\text{ }\mu\text{F} \parallel 10\text{ }\mu\text{F}$,
 $C_{NR/SS} = 10\text{ nF}$, $C_{FF} = 10\text{ nF}$

6-6. PSRR vs Frequency and V_{IN} ($V_{OUT} = 3.3\text{ V}$)

6.8 Typical Characteristics: TPS7A8400A (continued)

at $T_A = 25^\circ\text{C}$, $V_{IN} = 1.4\text{ V}$ or $V_{IN} = V_{OUT(nom)} + 0.4\text{ V}$ (whichever is greater), $V_{BIAS} = \text{open}$, $V_{OUT(nom)} = 0.8\text{ V}$, $V_{EN} = 1.1\text{ V}$, $C_{IN} = 10\text{ }\mu\text{F}$, $C_{OUT} = 47\text{ }\mu\text{F}$, $C_{NR/SS} = 0\text{ nF}$, no C_{FF} , and PG pin pulled up to V_{IN} with $100\text{ k}\Omega$ (unless otherwise noted)

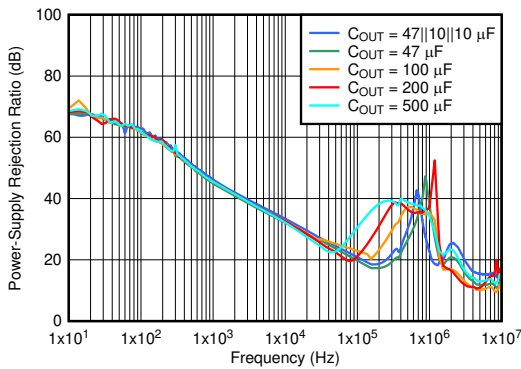

$V_{IN} = 1.4\text{ V}$, $V_{BIAS} = 5\text{ V}$, $V_{OUT} = 1\text{ V}$, $I_{OUT} = 3\text{ A}$,
 $C_{NR/SS} = 10\text{ nF}$, $C_{FF} = 10\text{ nF}$

6-7. PSRR vs Frequency and C_{OUT}

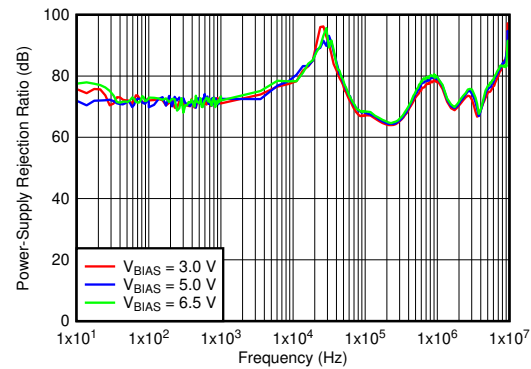

$V_{IN} = V_{OUT} + 0.3\text{ V}$, $V_{OUT} = 1\text{ V}$, $I_{OUT} = 3\text{ A}$, $C_{OUT} = 47\text{ }\mu\text{F} \parallel 10\text{ }\mu\text{F} \parallel 10\text{ }\mu\text{F}$, $C_{NR/SS} = 10\text{ nF}$, $C_{FF} = 10\text{ nF}$

6-8. V_{BIAS} PSRR vs Frequency

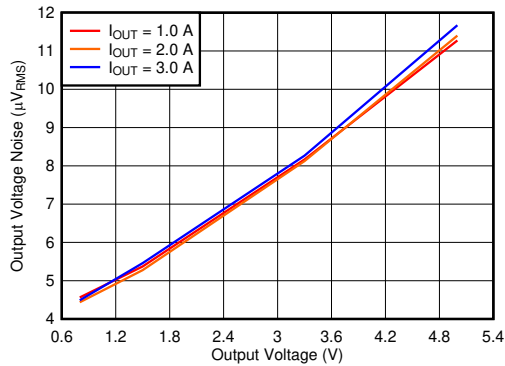

$V_{IN} = V_{OUT} + 0.3\text{ V}$ and $V_{BIAS} = 5\text{ V}$ for $V_{OUT} \leq 2.2\text{ V}$,
 $C_{OUT} = 47\text{ }\mu\text{F} \parallel 10\text{ }\mu\text{F} \parallel 10\text{ }\mu\text{F}$, $C_{NR/SS} = 10\text{ nF}$, $C_{FF} = 10\text{ nF}$,
RMS noise BW = 10 Hz to 100 kHz

6-9. Output Voltage Noise vs V_{OUT}

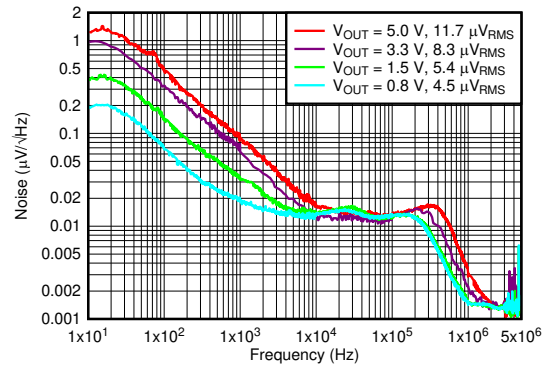

$V_{IN} = V_{OUT} + 0.3\text{ V}$ and $V_{BIAS} = 5\text{ V}$ for $V_{OUT} \leq 2.2\text{ V}$, $I_{OUT} = 3\text{ A}$, $C_{OUT} = 47\text{ }\mu\text{F} \parallel 10\text{ }\mu\text{F} \parallel 10\text{ }\mu\text{F}$, $C_{NR/SS} = 10\text{ nF}$, $C_{FF} = 10\text{ nF}$, RMS noise BW = 10 Hz to 100 kHz

6-10. Output Noise vs Frequency and V_{OUT}

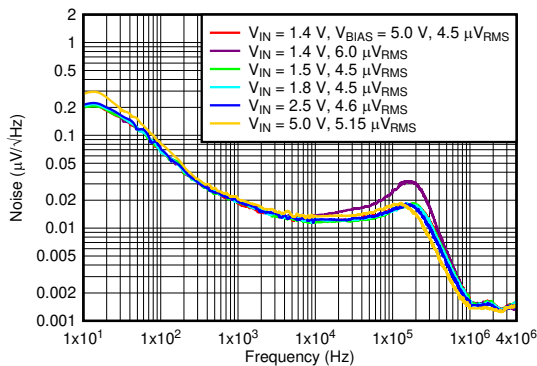

$I_{OUT} = 3\text{ A}$, $C_{OUT} = 47\text{ }\mu\text{F} \parallel 10\text{ }\mu\text{F} \parallel 10\text{ }\mu\text{F}$, $C_{NR/SS} = 10\text{ nF}$,
 $C_{FF} = 10\text{ nF}$, RMS noise BW = 10 Hz to 100 kHz

6-11. Output Noise vs Frequency and V_{IN}

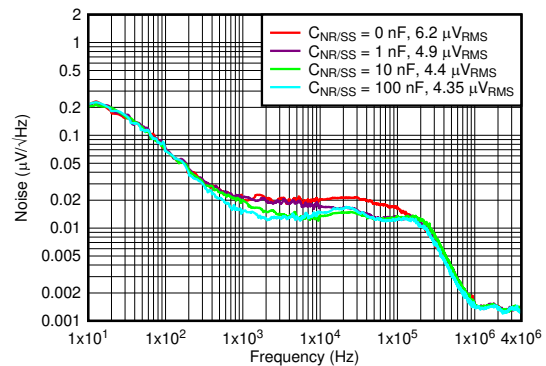

$V_{IN} = V_{OUT} + 0.3\text{ V}$, $V_{BIAS} = 5\text{ V}$, $I_{OUT} = 3\text{ A}$, $C_{OUT} = 47\text{ }\mu\text{F} \parallel 10\text{ }\mu\text{F} \parallel 10\text{ }\mu\text{F}$, $C_{FF} = 10\text{ nF}$, RMS noise BW = 10 Hz to 100 kHz

6-12. Output Noise vs Frequency and $C_{NR/SS}$

6.8 Typical Characteristics: TPS7A8400A (continued)

at $T_A = 25^\circ\text{C}$, $V_{IN} = 1.4\text{ V}$ or $V_{IN} = V_{OUT(nom)} + 0.4\text{ V}$ (whichever is greater), $V_{BIAS} = \text{open}$, $V_{OUT(nom)} = 0.8\text{ V}$, $V_{EN} = 1.1\text{ V}$, $C_{IN} = 10\text{ }\mu\text{F}$, $C_{OUT} = 47\text{ }\mu\text{F}$, $C_{NR/SS} = 0\text{ nF}$, no C_{FF} , and PG pin pulled up to V_{IN} with $100\text{ k}\Omega$ (unless otherwise noted)

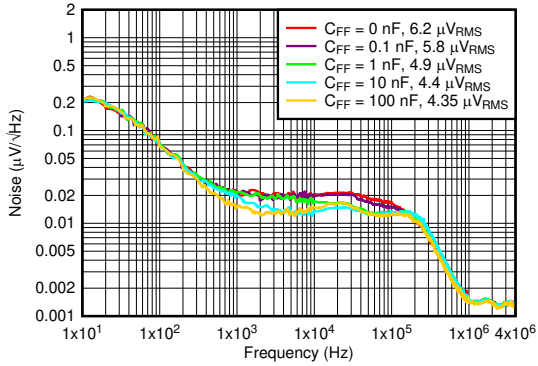

$V_{IN} = V_{OUT} + 0.3\text{ V}$, $V_{BIAS} = 5\text{ V}$, $I_{OUT} = 3\text{ A}$, $C_{OUT} = 47\text{ }\mu\text{F}$ || $10\text{ }\mu\text{F}$ || $10\text{ }\mu\text{F}$, $C_{NR/SS} = 10\text{ nF}$, RMS noise BW = 10 Hz to 100 kHz

6-13. Output Noise vs Frequency and C_{FF}

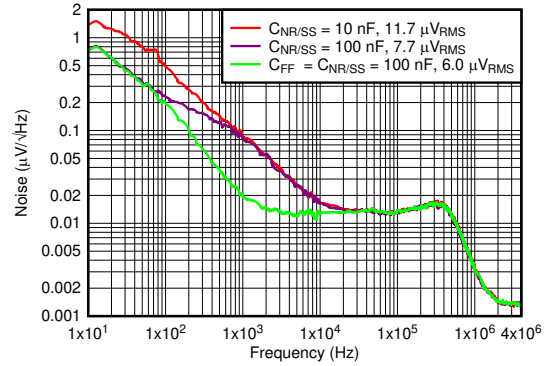

$I_{OUT} = 3\text{ A}$, $C_{OUT} = 47\text{ }\mu\text{F}$ || $10\text{ }\mu\text{F}$ || $10\text{ }\mu\text{F}$, $C_{FF} = 10\text{ nF}$, RMS noise BW = 10 Hz to 100 kHz

6-14. Output Noise at 5-V Output

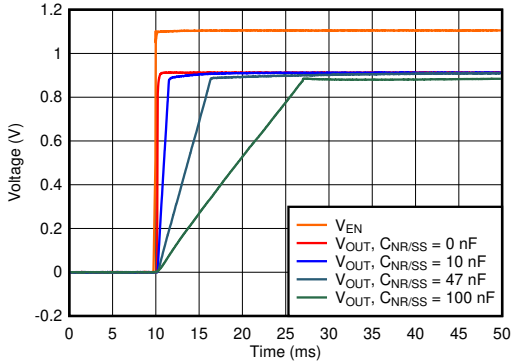

$V_{IN} = 1.2\text{ V}$, $V_{OUT} = 0.9\text{ V}$, $V_{BIAS} = 5\text{ V}$, $I_{OUT} = 3\text{ A}$, $C_{OUT} = 47\text{ }\mu\text{F}$ || $10\text{ }\mu\text{F}$ || $10\text{ }\mu\text{F}$, $C_{FF} = 10\text{ nF}$

6-15. Start-Up Waveform vs Time and $C_{NR/SS}$

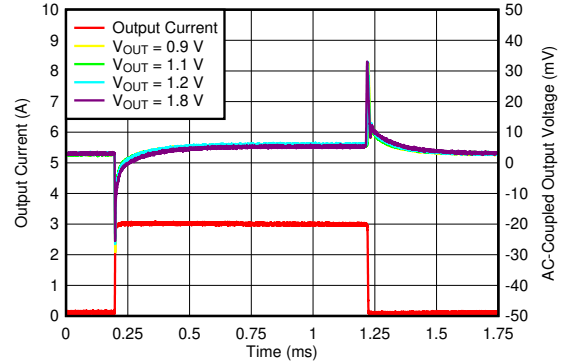

$V_{IN} = V_{OUT} + 0.3\text{ V}$, $V_{BIAS} = 5\text{ V}$, $I_{OUT, DC} = 100\text{ mA}$, slew rate = $1\text{ A}/\mu\text{s}$, $C_{NR/SS} = C_{FF} = 10\text{ nF}$, $C_{OUT} = 47\text{ }\mu\text{F}$ || $10\text{ }\mu\text{F}$ || $10\text{ }\mu\text{F}$

6-16. Load Transient vs Time and V_{OUT} With Bias

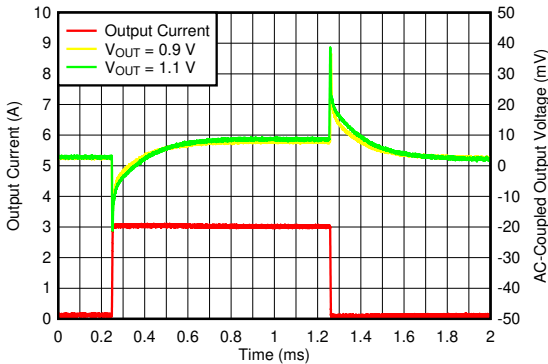

$I_{OUT, DC} = 100\text{ mA}$, $C_{OUT} = 47\text{ }\mu\text{F}$ || $10\text{ }\mu\text{F}$ || $10\text{ }\mu\text{F}$, $C_{NR/SS} = C_{FF} = 10\text{ nF}$, slew rate = $1\text{ A}/\mu\text{s}$

6-17. Load Transient vs Time and V_{OUT} Without Bias

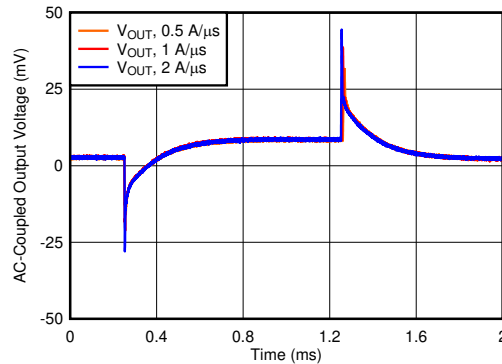

$V_{OUT} = 5\text{ V}$, $I_{OUT, DC} = 100\text{ mA}$, $I_{OUT} = 100\text{ mA}$ to 3 A , $C_{OUT} = 47\text{ }\mu\text{F}$ || $10\text{ }\mu\text{F}$ || $10\text{ }\mu\text{F}$, $C_{NR/SS} = C_{FF} = 10\text{ nF}$

6-18. Load Transient vs Time and Slew Rate

6.8 Typical Characteristics: TPS7A8400A (continued)

at $T_A = 25^\circ\text{C}$, $V_{IN} = 1.4\text{ V}$ or $V_{IN} = V_{OUT(nom)} + 0.4\text{ V}$ (whichever is greater), $V_{BIAS} = \text{open}$, $V_{OUT(nom)} = 0.8\text{ V}$, $V_{EN} = 1.1\text{ V}$, $C_{IN} = 10\text{ }\mu\text{F}$, $C_{OUT} = 47\text{ }\mu\text{F}$, $C_{NR/SS} = 0\text{ nF}$, no C_{FF} , and PG pin pulled up to V_{IN} with $100\text{ k}\Omega$ (unless otherwise noted)

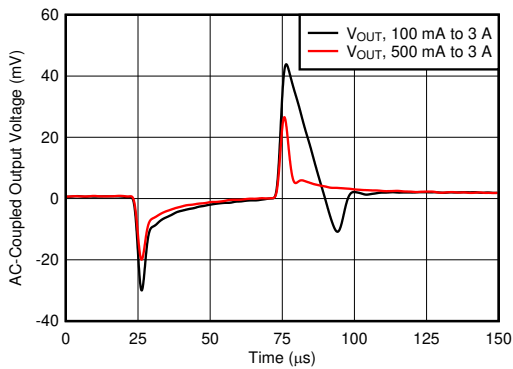

$V_{IN} = 1.2\text{ V}$, $V_{BIAS} = 5\text{ V}$, $C_{OUT} = 47\text{ }\mu\text{F} \parallel 10\text{ }\mu\text{F} \parallel 10\text{ }\mu\text{F}$, $V_{OUT} = 0.9\text{ V}$, $C_{NR/SS} = C_{FF} = 10\text{ nF}$, slew rate = $1\text{ A}/\mu\text{s}$

6-19. Load Transient vs Time and DC Load

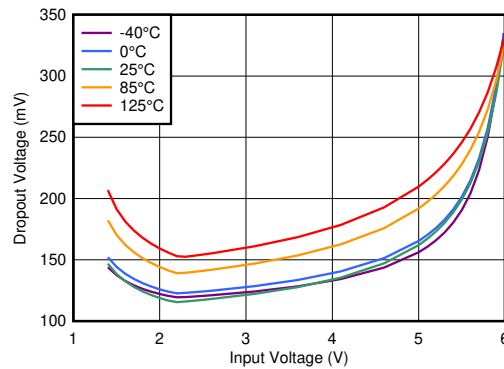

$I_{OUT} = 3\text{ A}$

6-20. Dropout Voltage vs V_{IN} Without Bias

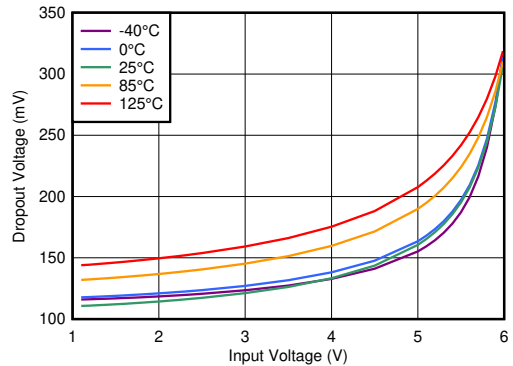

$I_{OUT} = 3\text{ A}$, $V_{BIAS} = 6.5\text{ V}$

6-21. Dropout Voltage vs V_{IN} With Bias

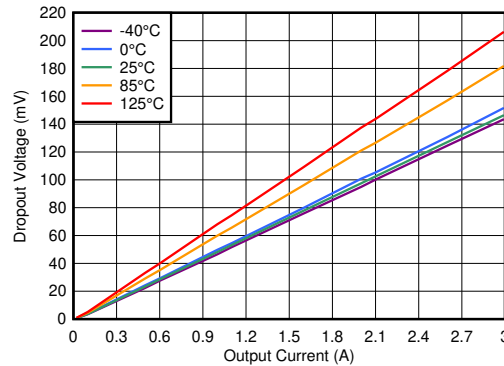

$V_{IN} = 1.4\text{ V}$

6-22. Dropout Voltage vs I_{OUT} Without Bias

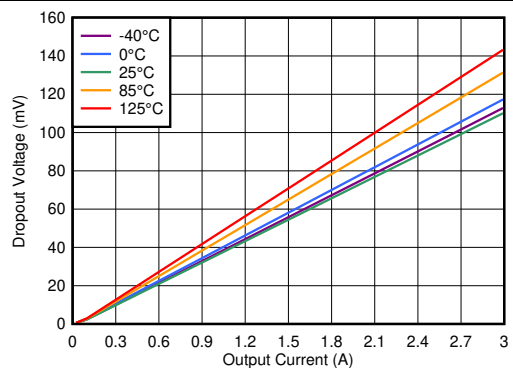

$V_{IN} = 1.1\text{ V}$, $V_{BIAS} = 3\text{ V}$

6-23. Dropout Voltage vs I_{OUT} With Bias

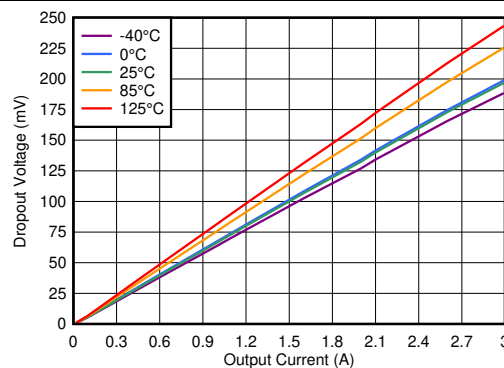

$V_{IN} = 5.5\text{ V}$

6-24. Dropout Voltage vs I_{OUT} (High V_{IN})

6.8 Typical Characteristics: TPS7A8400A (continued)

at $T_A = 25^\circ\text{C}$, $V_{IN} = 1.4\text{ V}$ or $V_{IN} = V_{OUT(nom)} + 0.4\text{ V}$ (whichever is greater), $V_{BIAS} = \text{open}$, $V_{OUT(nom)} = 0.8\text{ V}$, $V_{EN} = 1.1\text{ V}$, $C_{IN} = 10\text{ }\mu\text{F}$, $C_{OUT} = 47\text{ }\mu\text{F}$, $C_{NR/SS} = 0\text{ nF}$, no C_{FF} , and PG pin pulled up to V_{IN} with $100\text{ k}\Omega$ (unless otherwise noted)

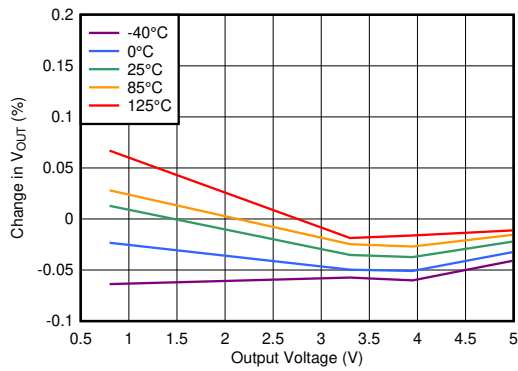

$I_{OUT} = 100\text{ mA to }3\text{ A}$

6-25. Load Regulation vs V_{OUT}

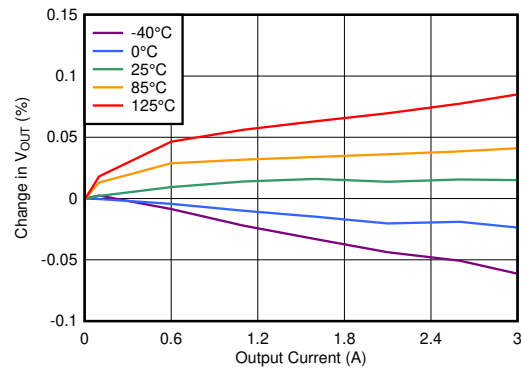

$V_{IN} = 1.4\text{ V}$

6-26. Load Regulation vs I_{OUT}

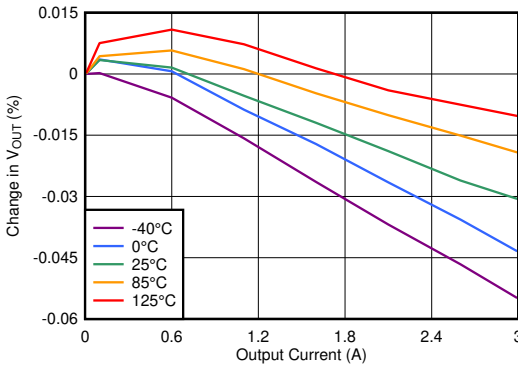

$V_{IN} = 3.8\text{ V}$

6-27. Load Regulation vs I_{OUT} (3.3-V Output)

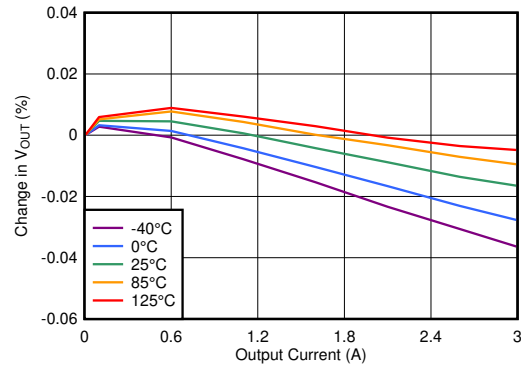

$V_{IN} = 5.5\text{ V}$

6-28. Load Regulation vs I_{OUT} (5-V Output)

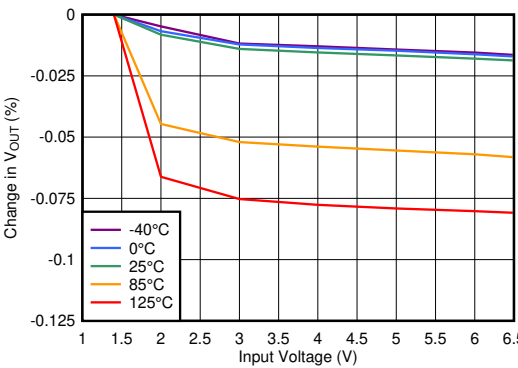

$V_{OUT} = 0.8\text{ V}$, $I_{OUT} = 5\text{ mA}$

6-29. Line Regulation vs V_{IN}

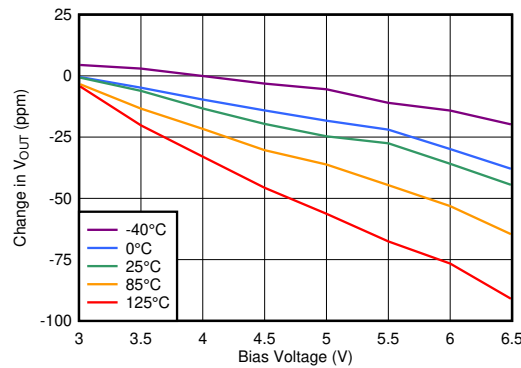

$V_{OUT} = 0.8\text{ V}$, $V_{IN} = 1.1\text{ V}$, $I_{OUT} = 5\text{ mA}$, $V_{BIAS} = 5\text{ V}$

6-30. Line Regulation With Bias

6.8 Typical Characteristics: TPS7A8400A (continued)

at $T_A = 25^\circ\text{C}$, $V_{IN} = 1.4\text{ V}$ or $V_{IN} = V_{OUT(nom)} + 0.4\text{ V}$ (whichever is greater), $V_{BIAS} = \text{open}$, $V_{OUT(nom)} = 0.8\text{ V}$, $V_{EN} = 1.1\text{ V}$, $C_{IN} = 10\text{ }\mu\text{F}$, $C_{OUT} = 47\text{ }\mu\text{F}$, $C_{NR/SS} = 0\text{ nF}$, no C_{FF} , and PG pin pulled up to V_{IN} with $100\text{ k}\Omega$ (unless otherwise noted)

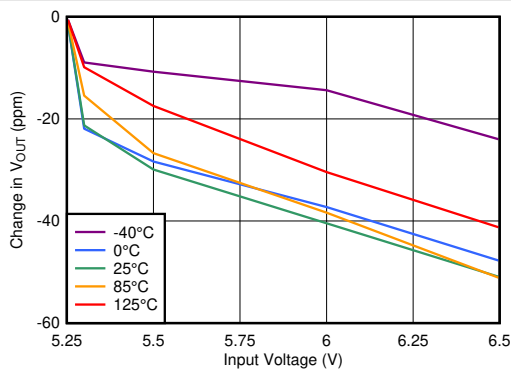

6-31. Line Regulation vs V_{IN} (5-V Output)

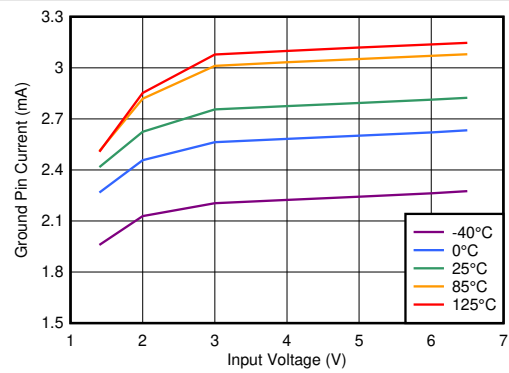

6-32. Ground Pin Current vs V_{IN}

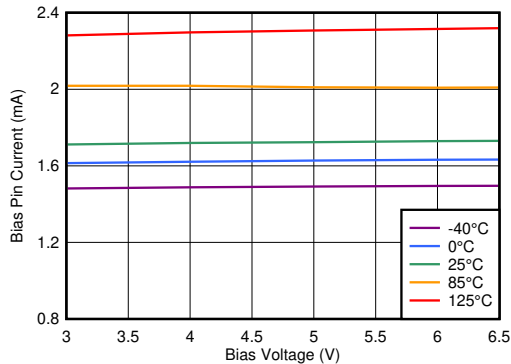

6-33. Bias Pin Current vs Bias Voltage

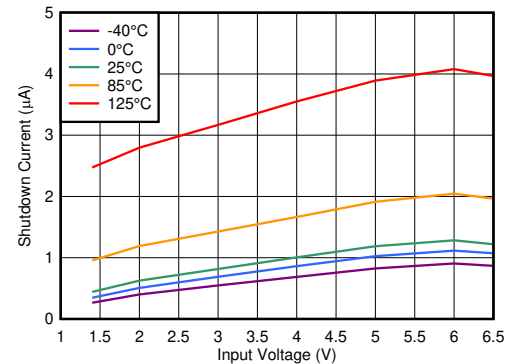

6-34. Shutdown Current vs V_{IN}

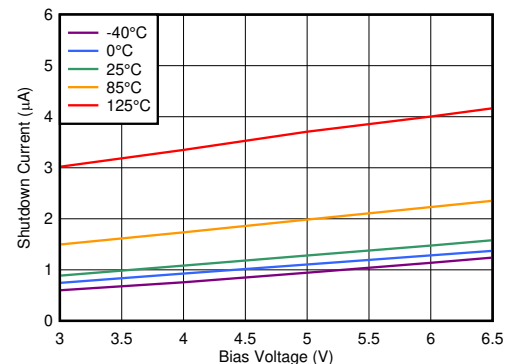

6-35. Shutdown Current vs Bias Voltage

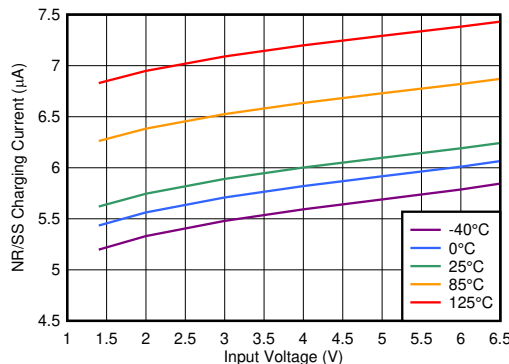

6-36. $I_{NR/SS}$ Current vs V_{IN}

6.8 Typical Characteristics: TPS7A8400A (continued)

at $T_A = 25^\circ\text{C}$, $V_{IN} = 1.4\text{ V}$ or $V_{IN} = V_{OUT(nom)} + 0.4\text{ V}$ (whichever is greater), $V_{BIAS} = \text{open}$, $V_{OUT(nom)} = 0.8\text{ V}$, $V_{EN} = 1.1\text{ V}$, $C_{IN} = 10\text{ }\mu\text{F}$, $C_{OUT} = 47\text{ }\mu\text{F}$, $C_{NR/SS} = 0\text{ nF}$, no C_{FF} , and PG pin pulled up to V_{IN} with $100\text{ k}\Omega$ (unless otherwise noted)

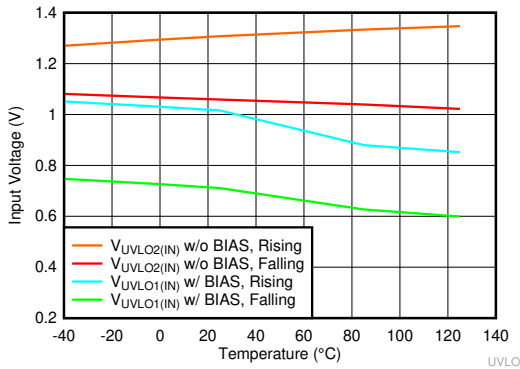

6-37. V_{IN} UVLO vs Temperature

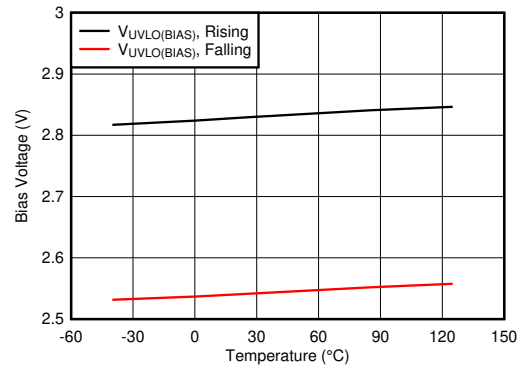

6-38. V_{BIAS} UVLO vs Temperature

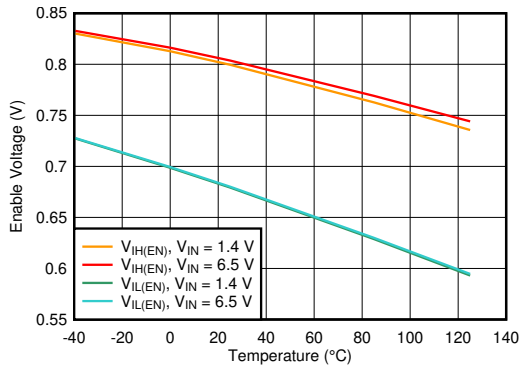

6-39. Enable Threshold vs Temperature

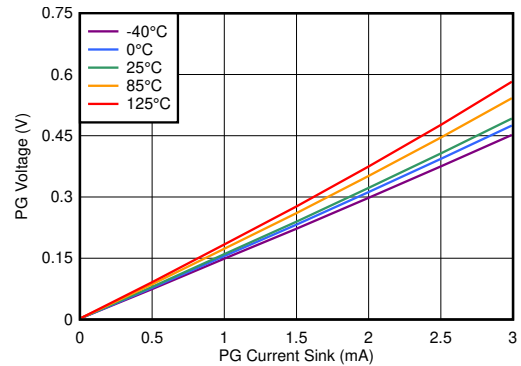

6-40. PG Voltage vs PG Current Sink

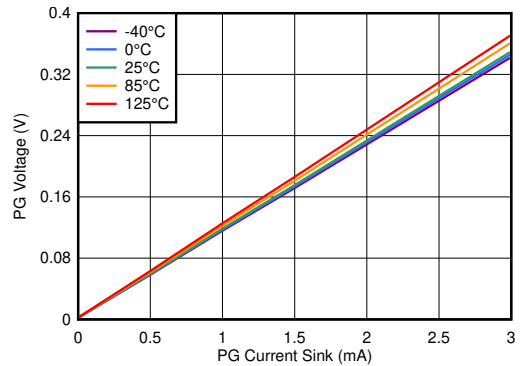

6-41. PG Voltage vs PG Current Sink

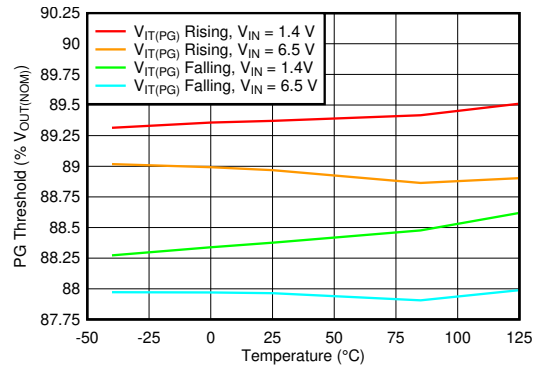

6-42. PG Threshold vs Temperature

6.9 Typical Characteristics: TPS7A8401A

at $T_A = 25^\circ\text{C}$, $V_{IN} = 1.4\text{ V}$ or $V_{IN} = V_{OUT(\text{nom})} + 0.4\text{ V}$ (whichever is greater), $V_{BIAS} = \text{open}$, $V_{OUT(\text{nom})} = 0.5\text{ V}$, $V_{EN} = 1.1\text{ V}$, $C_{IN} = 10\text{ }\mu\text{F}$, $C_{OUT} = 47\text{ }\mu\text{F}$, $C_{NR/SS} = 0\text{ nF}$, no C_{FF} , and PG pin pulled up to V_{IN} with $100\text{ k}\Omega$ (unless otherwise noted)

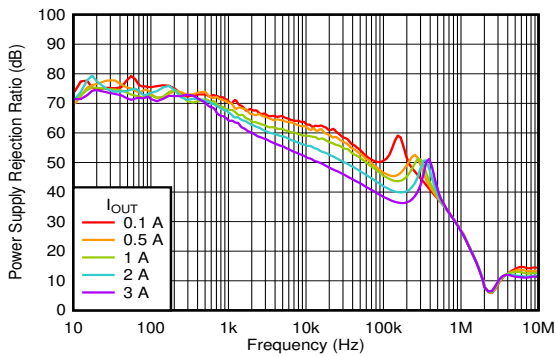

$V_{IN} = 1.1\text{ V}$, $V_{BIAS} = 5\text{ V}$, $C_{OUT} = 47\text{ }\mu\text{F} \parallel 10\text{ }\mu\text{F} \parallel 10\text{ }\mu\text{F}$,
 $C_{NR/SS} = 10\text{ nF}$, $C_{FF} = 10\text{ nF}$

6-43. PSRR vs Frequency and I_{OUT}

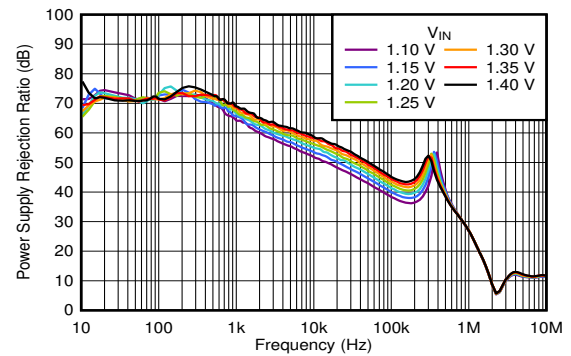

$I_{OUT} = 3\text{ A}$, $V_{BIAS} = 5\text{ V}$, $C_{OUT} = 47\text{ }\mu\text{F} \parallel 10\text{ }\mu\text{F} \parallel 10\text{ }\mu\text{F}$,
 $C_{NR/SS} = 10\text{ nF}$, $C_{FF} = 10\text{ nF}$

6-44. PSRR vs Frequency and V_{IN} With Bias

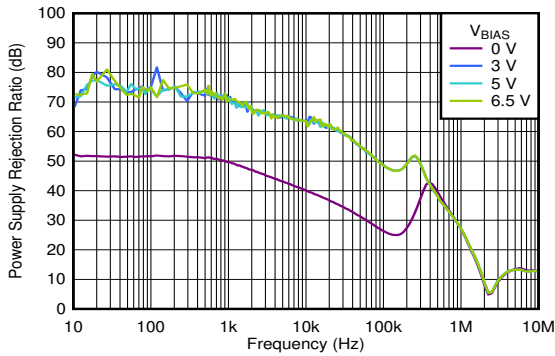

$V_{IN} = 1.4\text{ V}$, $I_{OUT} = 1\text{ A}$, $C_{OUT} = 47\text{ }\mu\text{F} \parallel 10\text{ }\mu\text{F} \parallel 10\text{ }\mu\text{F}$,
 $C_{NR/SS} = 10\text{ nF}$, $C_{FF} = 10\text{ nF}$

6-45. PSRR vs Frequency and V_{BIAS}

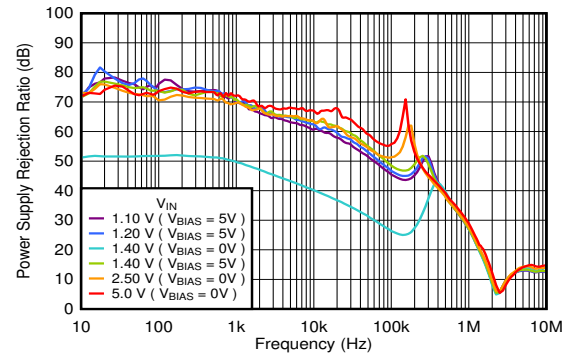

$I_{OUT} = 1\text{ A}$, $C_{OUT} = 47\text{ }\mu\text{F} \parallel 10\text{ }\mu\text{F} \parallel 10\text{ }\mu\text{F}$, $C_{NR/SS} = 10\text{ nF}$,
 $C_{FF} = 10\text{ nF}$

6-46. PSRR vs Frequency and V_{IN}

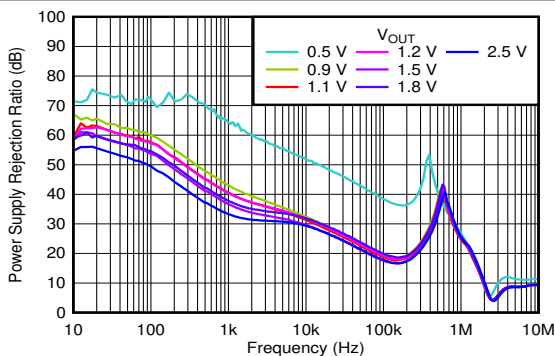

$V_{IN} = V_{OUT} + 0.3\text{ V}$ or $V_{IN} = 1.1\text{ V}$ (whichever is greater), $V_{BIAS} = 5\text{ V}$, $I_{OUT} = 3\text{ A}$, $C_{OUT} = 47\text{ }\mu\text{F} \parallel 10\text{ }\mu\text{F} \parallel 10\text{ }\mu\text{F}$,
 $C_{NR/SS} = 10\text{ nF}$, $C_{FF} = 10\text{ nF}$

6-47. PSRR vs Frequency and V_{OUT} With Bias

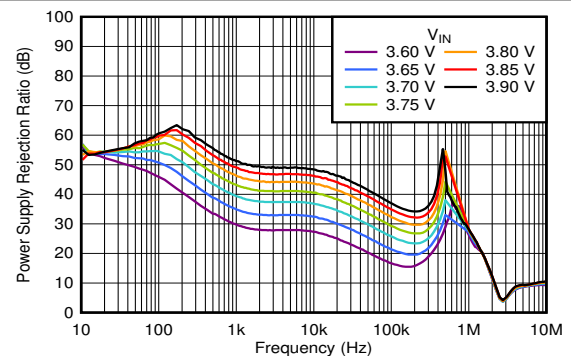

$I_{OUT} = 3\text{ A}$, $C_{OUT} = 47\text{ }\mu\text{F} \parallel 10\text{ }\mu\text{F} \parallel 10\text{ }\mu\text{F}$, $C_{NR/SS} = 10\text{ nF}$,
 $C_{FF} = 10\text{ nF}$

6-48. PSRR vs Frequency and V_{IN} ($V_{OUT} = 3.3\text{ V}$)

6.9 Typical Characteristics: TPS7A8401A (continued)

at $T_A = 25^\circ\text{C}$, $V_{IN} = 1.4\text{ V}$ or $V_{IN} = V_{OUT(nom)} + 0.4\text{ V}$ (whichever is greater), $V_{BIAS} = \text{open}$, $V_{OUT(nom)} = 0.5\text{ V}$, $V_{EN} = 1.1\text{ V}$, $C_{IN} = 10\text{ }\mu\text{F}$, $C_{OUT} = 47\text{ }\mu\text{F}$, $C_{NR/SS} = 0\text{ nF}$, no C_{FF} , and PG pin pulled up to V_{IN} with $100\text{ k}\Omega$ (unless otherwise noted)

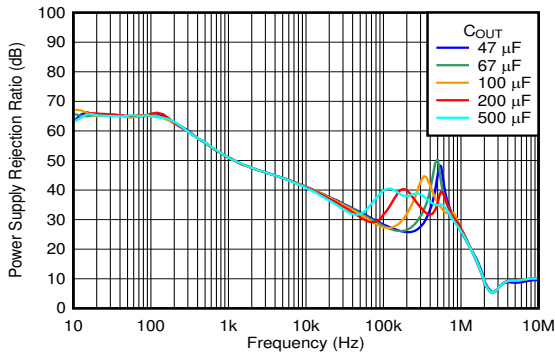

$V_{IN} = 1.4\text{ V}$, $V_{BIAS} = 5\text{ V}$, $V_{OUT} = 1\text{ V}$, $I_{OUT} = 3\text{ A}$,
 $C_{NR/SS} = 10\text{ nF}$, $C_{FF} = 10\text{ nF}$

6-49. PSRR vs Frequency and C_{OUT}

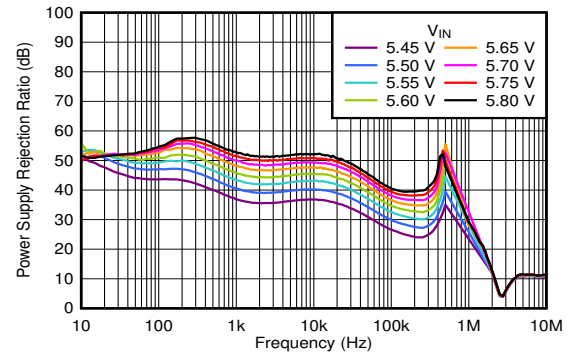

$V_{OUT} = 5\text{ V}$, $I_{OUT} = 3\text{ A}$, $C_{OUT} = 47\text{ }\mu\text{F} \parallel 10\text{ }\mu\text{F} \parallel 10\text{ }\mu\text{F}$,
 $C_{NR/SS} = 10\text{ nF}$, $C_{FF} = 10\text{ nF}$

6-50. PSRR vs Frequency and V_{IN}
($V_{OUT} = 5\text{ V}$)

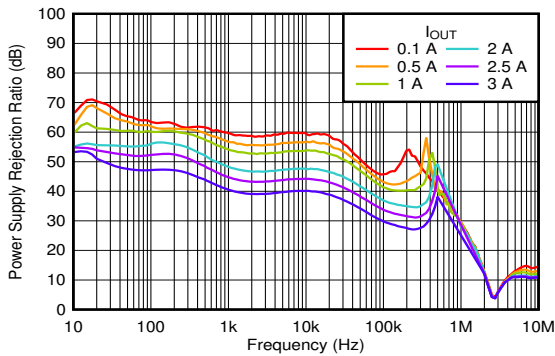

$V_{IN} = 5.5\text{ V}$, $V_{OUT} = 5\text{ V}$, $I_{OUT} = 3\text{ A}$, $C_{OUT} = 47\text{ }\mu\text{F} \parallel 10\text{ }\mu\text{F} \parallel 10\text{ }\mu\text{F}$,
 $C_{NR/SS} = 10\text{ nF}$, $C_{FF} = 10\text{ nF}$

6-51. PSRR vs Frequency and I_{OUT}
($V_{OUT} = 5\text{ V}$)

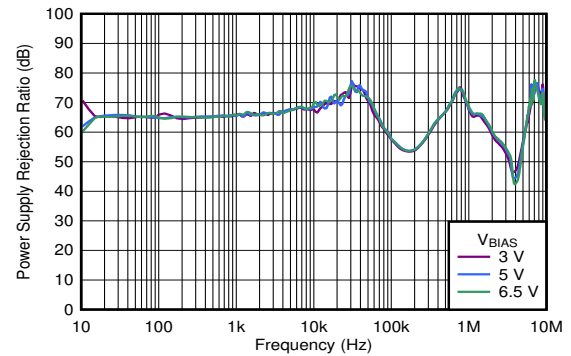

$V_{IN} = V_{OUT} + 0.3\text{ V}$, $V_{OUT} = 1\text{ V}$, $I_{OUT} = 3\text{ A}$, $C_{OUT} = 47\text{ }\mu\text{F} \parallel 10\text{ }\mu\text{F} \parallel 10\text{ }\mu\text{F}$,
 $C_{NR/SS} = 10\text{ nF}$, $C_{FF} = 10\text{ nF}$

6-52. V_{BIAS} PSRR vs Frequency

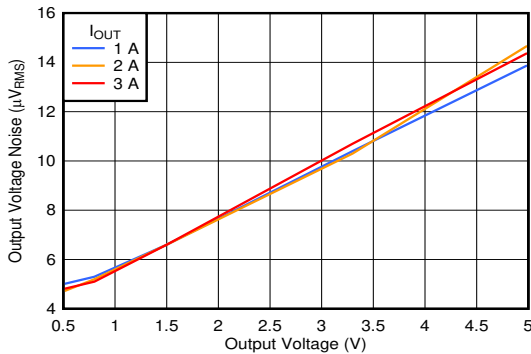

$V_{IN} = V_{OUT} + 0.3\text{ V}$ or $V_{IN} = 1.1\text{ V}$ (whichever is greater), $V_{BIAS} = 5\text{ V}$ for $V_{IN} \leq 2.2\text{ V}$, $C_{OUT} = 47\text{ }\mu\text{F} \parallel 10\text{ }\mu\text{F} \parallel 10\text{ }\mu\text{F}$, $C_{NR/SS} = 10\text{ nF}$, $C_{FF} = 10\text{ nF}$, RMS noise BW = 10 Hz to 100 kHz

6-53. Output Voltage Noise vs V_{OUT}

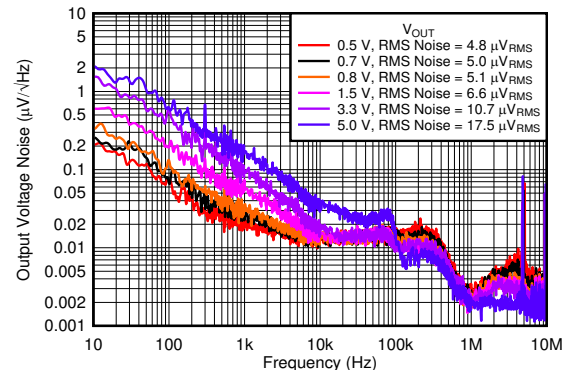

$V_{IN} = V_{OUT} + 0.3\text{ V}$ or $V_{IN} = 1.1\text{ V}$ (whichever is greater), $V_{BIAS} = 5\text{ V}$ for $V_{IN} \leq 2.2\text{ V}$, $I_{OUT} = 3\text{ A}$, $C_{OUT} = 47\text{ }\mu\text{F} \parallel 10\text{ }\mu\text{F} \parallel 10\text{ }\mu\text{F}$, $C_{NR/SS} = 10\text{ nF}$, $C_{FF} = 10\text{ nF}$, RMS noise BW = 10 Hz to 100 kHz

6-54. Output Noise vs Frequency and V_{OUT}

6.9 Typical Characteristics: TPS7A8401A (continued)

at $T_A = 25^\circ\text{C}$, $V_{IN} = 1.4\text{ V}$ or $V_{IN} = V_{OUT(nom)} + 0.4\text{ V}$ (whichever is greater), $V_{BIAS} = \text{open}$, $V_{OUT(nom)} = 0.5\text{ V}$, $V_{EN} = 1.1\text{ V}$, $C_{IN} = 10\text{ }\mu\text{F}$, $C_{OUT} = 47\text{ }\mu\text{F}$, $C_{NR/SS} = 0\text{ nF}$, no C_{FF} , and PG pin pulled up to V_{IN} with $100\text{ k}\Omega$ (unless otherwise noted)

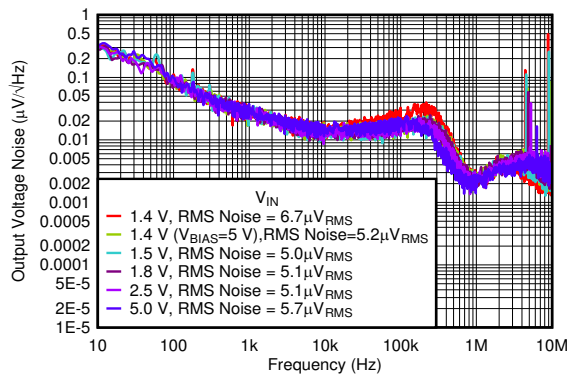

$V_{OUT} = 0.7\text{ V}$, $I_{OUT} = 3\text{ A}$, $C_{OUT} = 47\text{ }\mu\text{F} \parallel 10\text{ }\mu\text{F} \parallel 10\text{ }\mu\text{F}$,
 $C_{NR/SS} = 10\text{ nF}$, $C_{FF} = 10\text{ nF}$, RMS noise BW = 10 Hz to 100 kHz

6-55. Output Noise vs Frequency and V_{IN}

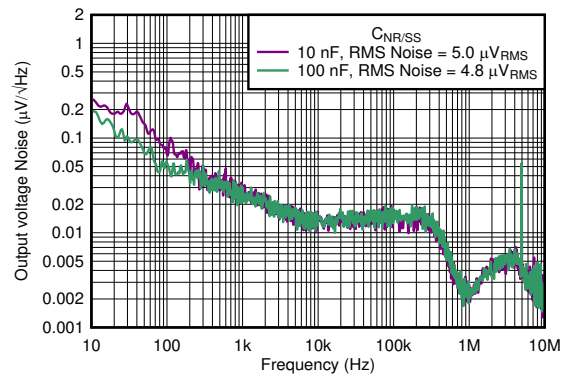

$V_{OUT} = 0.7\text{ V}$, $V_{IN} = 1.1\text{ V}$, $V_{BIAS} = 5\text{ V}$, $I_{OUT} = 3\text{ A}$, $C_{OUT} = 47\text{ }\mu\text{F} \parallel 10\text{ }\mu\text{F} \parallel 10\text{ }\mu\text{F}$, $C_{FF} = 10\text{ nF}$, RMS noise BW = 10 Hz to 100 kHz

6-56. Output Noise vs Frequency and $C_{NR/SS}$

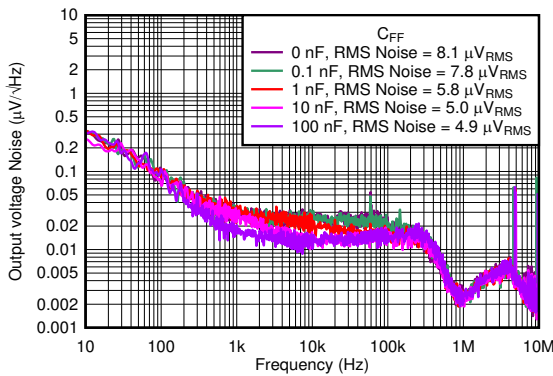

$V_{OUT} = 0.7\text{ V}$, $V_{IN} = 1.1\text{ V}$, $V_{BIAS} = 5\text{ V}$, $I_{OUT} = 3\text{ A}$, $C_{OUT} = 47\text{ }\mu\text{F} \parallel 10\text{ }\mu\text{F} \parallel 10\text{ }\mu\text{F}$, $C_{NR/SS} = 10\text{ nF}$, RMS noise BW = 10 Hz to 100 kHz

6-57. Output Noise vs Frequency and C_{FF}

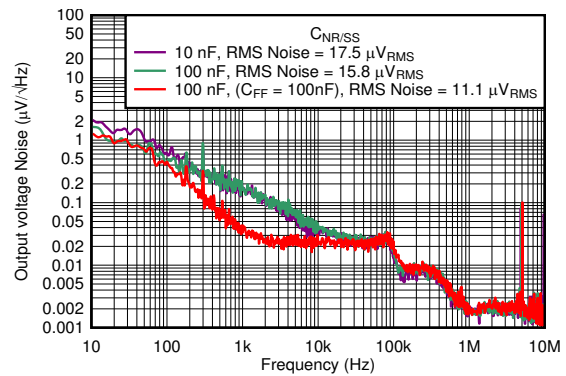

$V_{IN} = V_{OUT} + 0.3\text{ V}$, $V_{BIAS} = 5\text{ V}$, $I_{OUT} = 3\text{ A}$, $C_{OUT} = 47\text{ }\mu\text{F} \parallel 10\text{ }\mu\text{F} \parallel 10\text{ }\mu\text{F}$, $C_{FF} = 10\text{ nF}$, RMS noise BW = 10 Hz to 100 kHz

6-58. Output Noise vs Frequency (5-V Output)

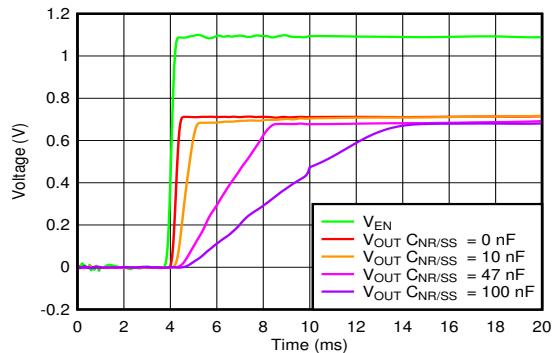

$V_{IN} = 1.2\text{ V}$, $V_{OUT} = 0.7\text{ V}$, $V_{BIAS} = 5\text{ V}$, $I_{OUT} = 3\text{ A}$,
 $C_{OUT} = 47\text{ }\mu\text{F} \parallel 10\text{ }\mu\text{F} \parallel 10\text{ }\mu\text{F}$, $C_{FF} = 10\text{ nF}$

6-59. Start-Up Waveform vs Time and $C_{NR/SS}$

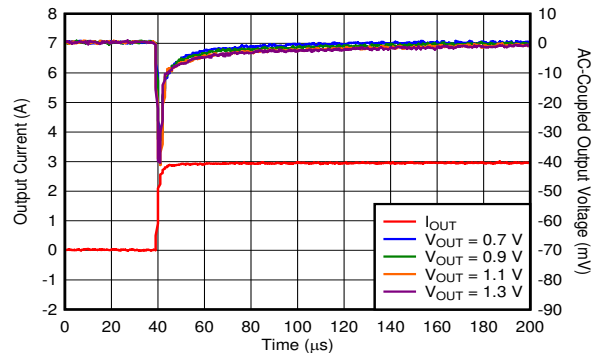

$V_{IN} = V_{OUT} + 0.5\text{ V}$, $V_{BIAS} = 5\text{ V}$, $I_{OUT} = 100\text{ mA}$ to 3 A ,
slew rate = $1\text{ A}/\mu\text{s}$, $C_{NR/SS} = C_{FF} = 10\text{ nF}$,
 $C_{OUT} = 47\text{ }\mu\text{F} \parallel 10\text{ }\mu\text{F} \parallel 10\text{ }\mu\text{F}$

6-60. Load Transient vs Time and V_{OUT} With Bias

6.9 Typical Characteristics: TPS7A8401A (continued)

at $T_A = 25^\circ\text{C}$, $V_{IN} = 1.4\text{ V}$ or $V_{IN} = V_{OUT(nom)} + 0.4\text{ V}$ (whichever is greater), $V_{BIAS} = \text{open}$, $V_{OUT(nom)} = 0.5\text{ V}$, $V_{EN} = 1.1\text{ V}$, $C_{IN} = 10\text{ }\mu\text{F}$, $C_{OUT} = 47\text{ }\mu\text{F}$, $C_{NR/SS} = 0\text{ nF}$, no C_{FF} , and PG pin pulled up to V_{IN} with $100\text{ k}\Omega$ (unless otherwise noted)

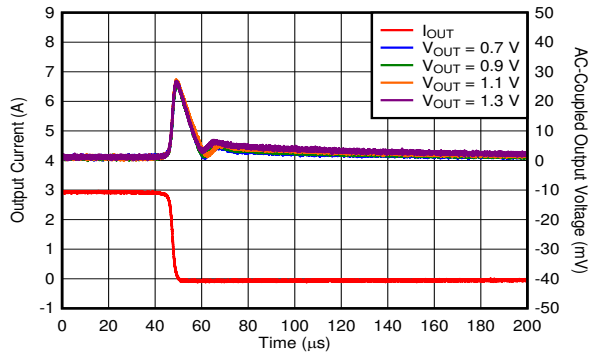

$V_{IN} = V_{OUT} + 0.5\text{ V}$, $V_{BIAS} = 5\text{ V}$, $I_{OUT} = 3\text{ A to } 100\text{ mA}$,
slew rate = $1\text{ A}/\mu\text{s}$, $C_{NR/SS} = C_{FF} = 10\text{ nF}$,
 $C_{OUT} = 47\text{ }\mu\text{F} \parallel 10\text{ }\mu\text{F} \parallel 10\text{ }\mu\text{F}$

6-61. Load Transient vs Time and V_{OUT} With Bias

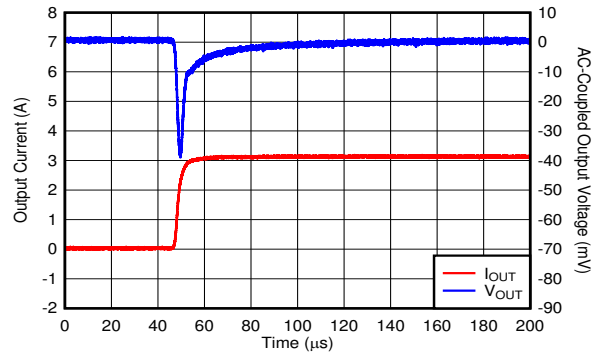

$V_{IN} = V_{OUT} + 0.5\text{ V}$, $V_{OUT} = 0.7\text{ V}$, $I_{OUT} = 100\text{ mA to } 3\text{ A}$,
 $C_{OUT} = 47\text{ }\mu\text{F} \parallel 10\text{ }\mu\text{F} \parallel 10\text{ }\mu\text{F}$, $C_{NR/SS} = C_{FF} = 10\text{ nF}$, slew
rate = $1\text{ A}/\mu\text{s}$

6-62. Load Transient vs Time and V_{OUT} Without Bias

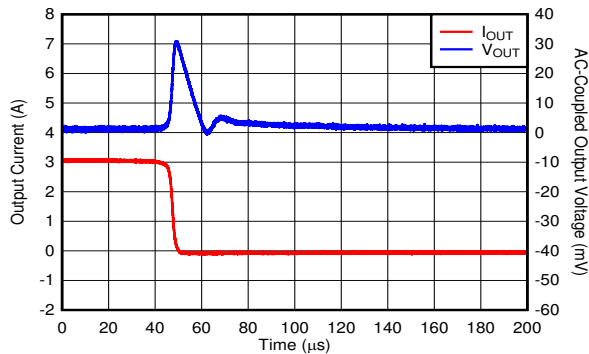

$V_{IN} = V_{OUT} + 0.5\text{ V}$, $V_{OUT} = 0.7\text{ V}$, $I_{OUT} = 3\text{ A to } 100\text{ mA}$,
 $C_{OUT} = 47\text{ }\mu\text{F} \parallel 10\text{ }\mu\text{F} \parallel 10\text{ }\mu\text{F}$, $C_{NR/SS} = C_{FF} = 10\text{ nF}$, slew
rate = $1\text{ A}/\mu\text{s}$

6-63. Load Transient vs Time and V_{OUT} Without Bias

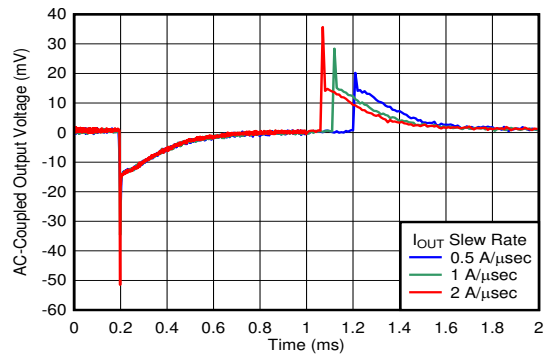

$V_{OUT} = 5\text{ V}$, $I_{OUT,DC} = 100\text{ mA}$, $I_{OUT} = 100\text{ mA to } 3\text{ A}$,
 $C_{OUT} = 47\text{ }\mu\text{F} \parallel 10\text{ }\mu\text{F} \parallel 10\text{ }\mu\text{F}$, $C_{NR/SS} = C_{FF} = 10\text{ nF}$

6-64. Load Transient vs Time and Slew Rate

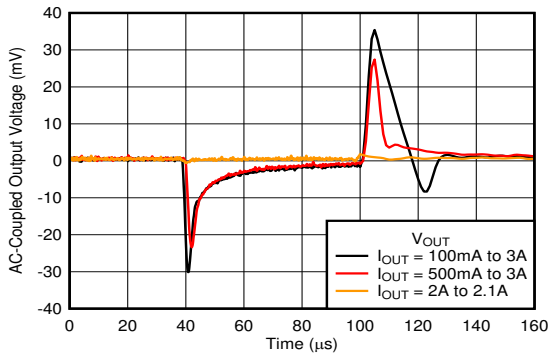

$V_{IN} = 1.2\text{ V}$, $V_{OUT} = 0.7\text{ V}$, $V_{BIAS} = 5\text{ V}$, slew rate = $1\text{ A}/\mu\text{s}$,
 $C_{OUT} = 47\text{ }\mu\text{F} \parallel 10\text{ }\mu\text{F} \parallel 10\text{ }\mu\text{F}$, $C_{NR/SS} = C_{FF} = 10\text{ nF}$

6-65. Load Transient vs Time and DC Load

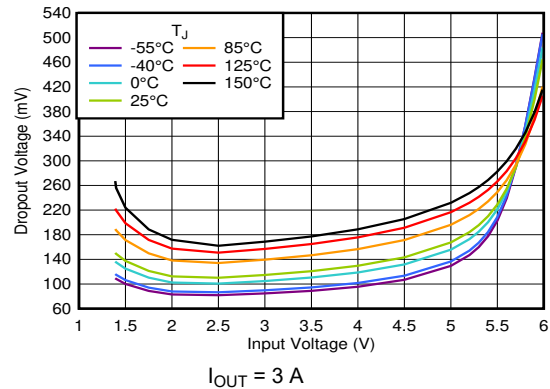

$I_{OUT} = 3\text{ A}$

6-66. Dropout Voltage vs V_{IN} Without Bias

6.9 Typical Characteristics: TPS7A8401A (continued)

at $T_A = 25^\circ\text{C}$, $V_{IN} = 1.4\text{ V}$ or $V_{IN} = V_{OUT(nom)} + 0.4\text{ V}$ (whichever is greater), $V_{BIAS} = \text{open}$, $V_{OUT(nom)} = 0.5\text{ V}$, $V_{EN} = 1.1\text{ V}$, $C_{IN} = 10\text{ }\mu\text{F}$, $C_{OUT} = 47\text{ }\mu\text{F}$, $C_{NR/SS} = 0\text{ nF}$, no C_{FF} , and PG pin pulled up to V_{IN} with $100\text{ k}\Omega$ (unless otherwise noted)

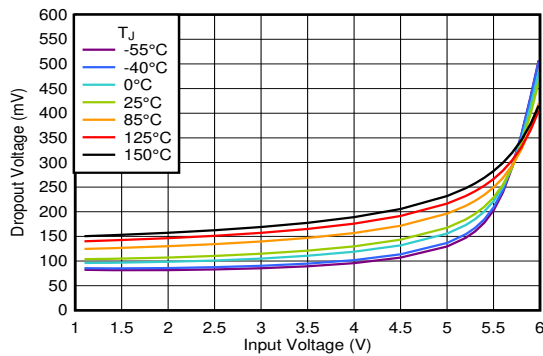

$I_{OUT} = 3\text{ A}$, $V_{BIAS} = 5.0\text{ V}$

6-67. Dropout Voltage vs V_{IN} With Bias

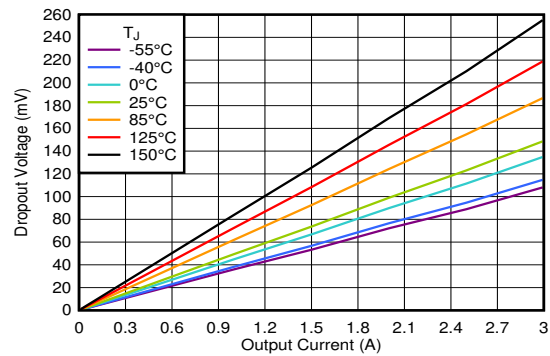

$V_{IN} = 1.4\text{ V}$

6-68. Dropout Voltage vs I_{OUT} Without Bias

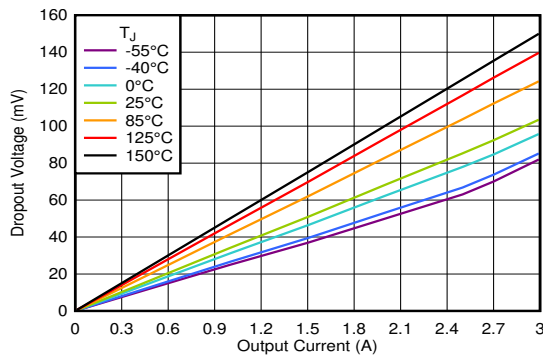

$V_{IN} = 1.1\text{ V}$, $V_{BIAS} = 5.0\text{ V}$

6-69. Dropout Voltage vs I_{OUT} With Bias

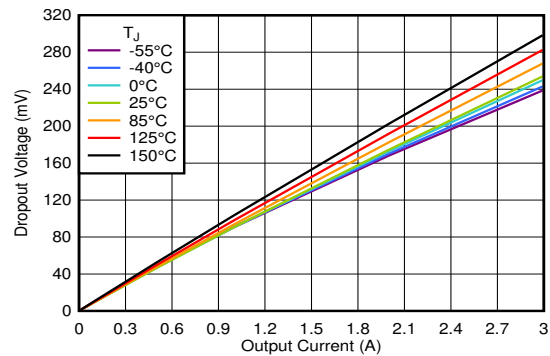

$V_{IN} = 5.6\text{ V}$

6-70. Dropout Voltage vs I_{OUT} (High V_{IN})

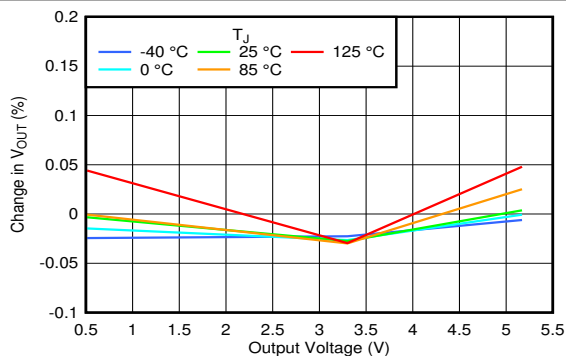

$I_{OUT} = 100\text{ mA to }3\text{ A}$

6-71. Load Regulation vs V_{OUT}

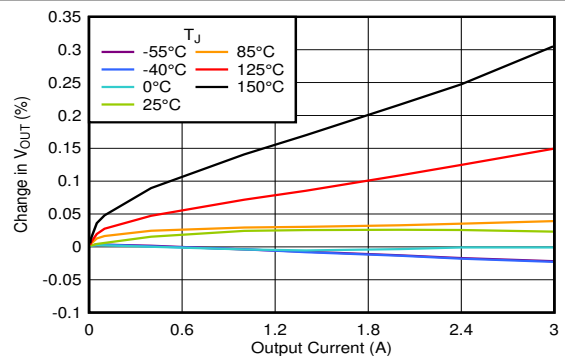

$V_{IN} = 1.4\text{ V}$

6-72. Load Regulation vs I_{OUT}

6.9 Typical Characteristics: TPS7A8401A (continued)

at $T_A = 25^\circ\text{C}$, $V_{IN} = 1.4\text{ V}$ or $V_{IN} = V_{OUT(nom)} + 0.4\text{ V}$ (whichever is greater), $V_{BIAS} = \text{open}$, $V_{OUT(nom)} = 0.5\text{ V}$, $V_{EN} = 1.1\text{ V}$, $C_{IN} = 10\text{ }\mu\text{F}$, $C_{OUT} = 47\text{ }\mu\text{F}$, $C_{NR/SS} = 0\text{ nF}$, no C_{FF} , and PG pin pulled up to V_{IN} with $100\text{ k}\Omega$ (unless otherwise noted)

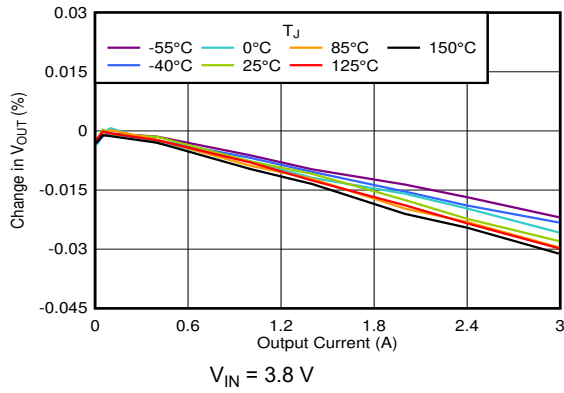

6-73. Load Regulation vs I_{OUT} (3.3-V Output)

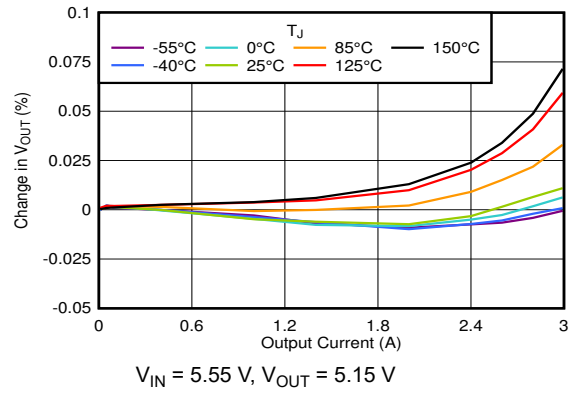

6-74. Load Regulation vs I_{OUT} (5-V Output)

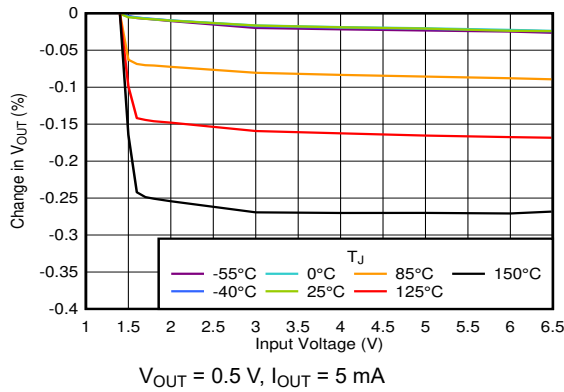

6-75. Line Regulation vs V_{IN}

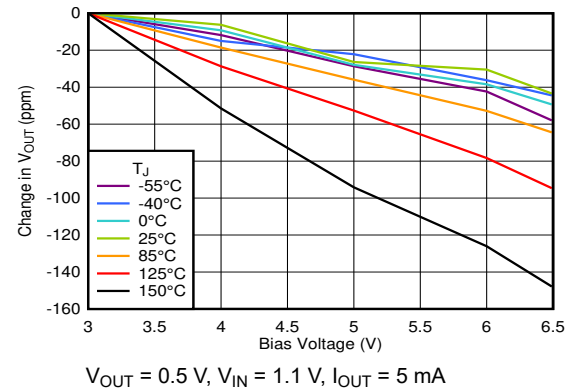

6-76. Line Regulation With Bias

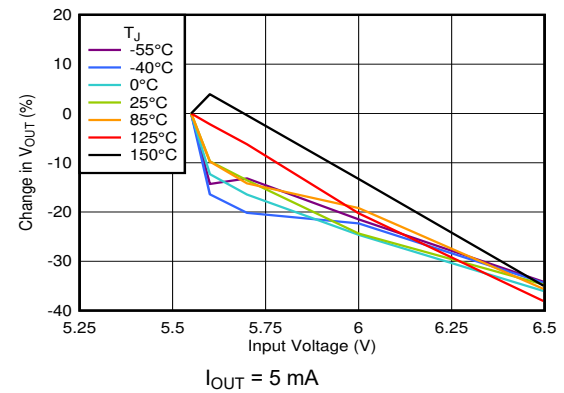

6-77. Line Regulation vs V_{IN} (5.15-V Output)

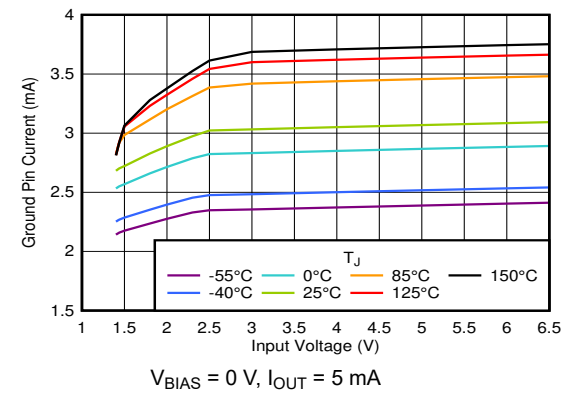

6-78. Ground Pin Current vs V_{IN}

6.9 Typical Characteristics: TPS7A8401A (continued)

at $T_A = 25^\circ\text{C}$, $V_{IN} = 1.4\text{ V}$ or $V_{IN} = V_{OUT(nom)} + 0.4\text{ V}$ (whichever is greater), $V_{BIAS} = \text{open}$, $V_{OUT(nom)} = 0.5\text{ V}$, $V_{EN} = 1.1\text{ V}$, $C_{IN} = 10\text{ }\mu\text{F}$, $C_{OUT} = 47\text{ }\mu\text{F}$, $C_{NR/SS} = 0\text{ nF}$, no C_{FF} , and PG pin pulled up to V_{IN} with $100\text{ k}\Omega$ (unless otherwise noted)

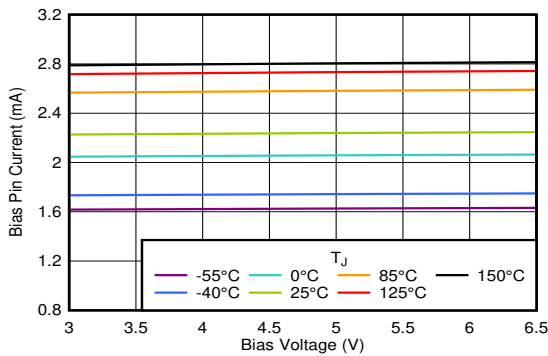

6-79. Bias Pin Current With Bias

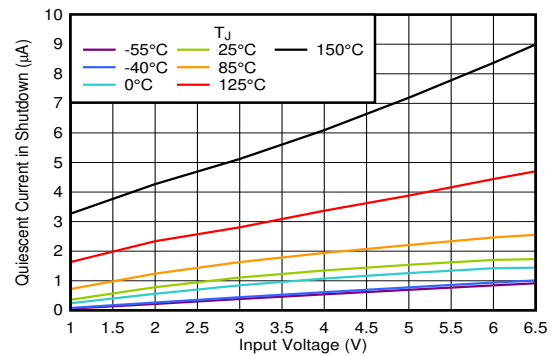

6-80. Shutdown Current vs V_{IN}

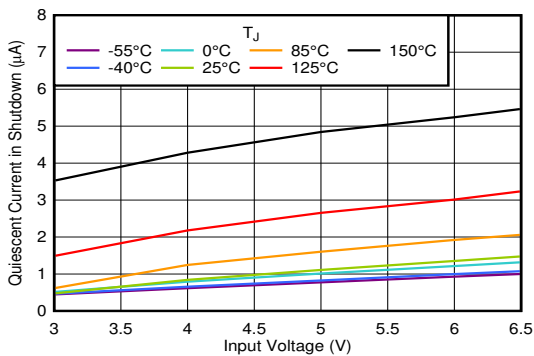

6-81. Shutdown Current vs V_{IN} With Bias

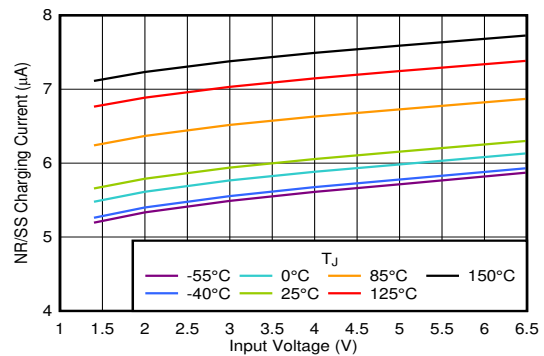

6-82. $I_{NR/SS}$ Current vs V_{IN}

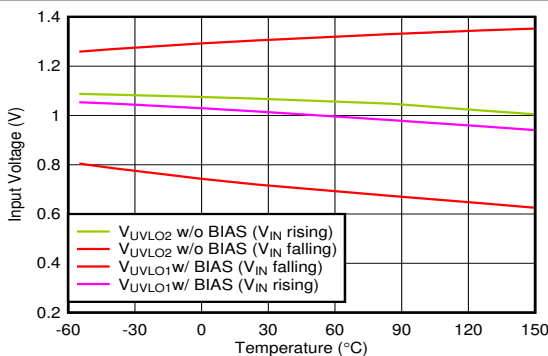

6-83. V_{IN} UVLO vs Temperature

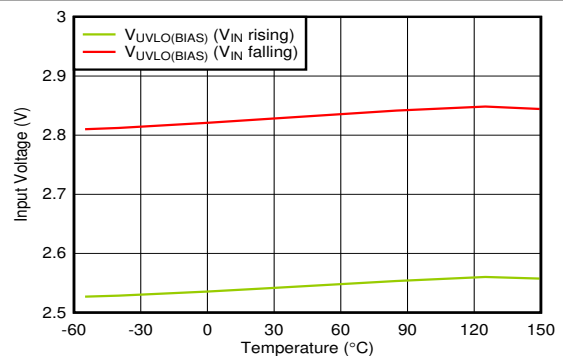

6-84. V_{BIAS} UVLO vs Temperature

6.9 Typical Characteristics: TPS7A8401A (continued)

at $T_A = 25^\circ\text{C}$, $V_{IN} = 1.4\text{ V}$ or $V_{IN} = V_{OUT(nom)} + 0.4\text{ V}$ (whichever is greater), $V_{BIAS} = \text{open}$, $V_{OUT(nom)} = 0.5\text{ V}$, $V_{EN} = 1.1\text{ V}$, $C_{IN} = 10\text{ }\mu\text{F}$, $C_{OUT} = 47\text{ }\mu\text{F}$, $C_{NR/SS} = 0\text{ nF}$, no C_{FF} , and PG pin pulled up to V_{IN} with $100\text{ k}\Omega$ (unless otherwise noted)

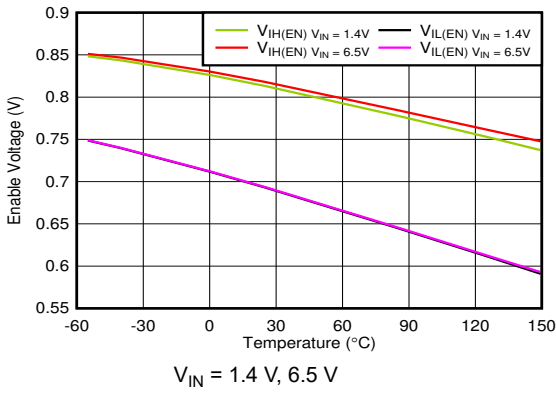

6-85. Enable Threshold vs Temperature

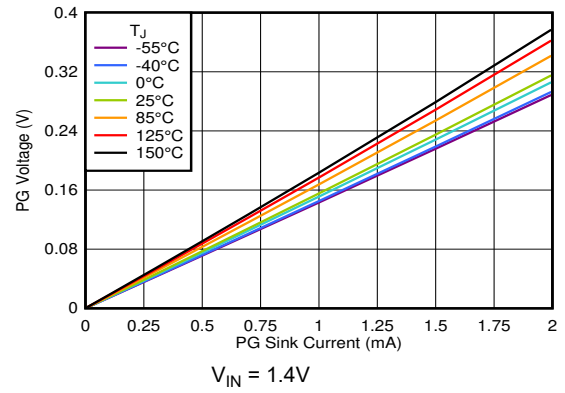

6-86. PG Voltage vs PG Current Sink

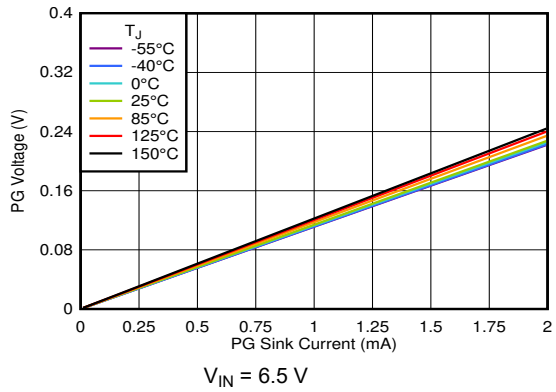

6-87. PG Voltage vs PG Current Sink

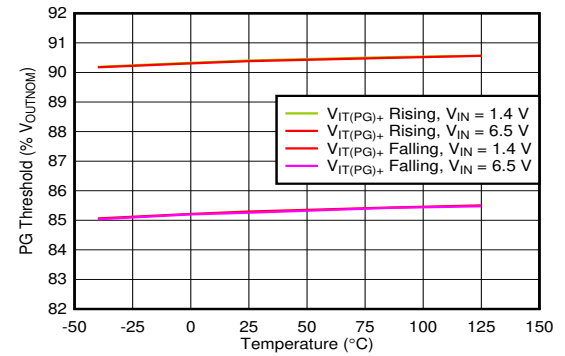

6-88. PG Threshold vs Temperature

7 Detailed Description

7.1 Overview

The TPS7A84A is a high-current (3 A), low-noise (4.4 μV_{RMS}), high accuracy (0.75%) low-dropout linear voltage regulator (LDO). These features make the device a robust solution to solve many challenging problems in generating a clean, accurate power supply.

The TPS7A84A has several features that makes the device useful in a variety of applications. See 表 7-1 for a categorization of the functionalities shown in the *Functional Block Diagrams* section.

Overall, these features make the TPS7A84 the component of choice due to its versatility and ability to generate a supply for most applications.

表 7-1. Features

VOLTAGE REGULATION	SYSTEM START-UP	INTERNAL PROTECTION
High accuracy	Programmable soft-start	Foldback current limit
Low-noise, high-PSRR output	No sequencing requirement between BIAS, IN and EN	Thermal shutdown
Fast transient response	Power-good output	
	Start-up with negative bias on OUT	

7.2 Functional Block Diagrams

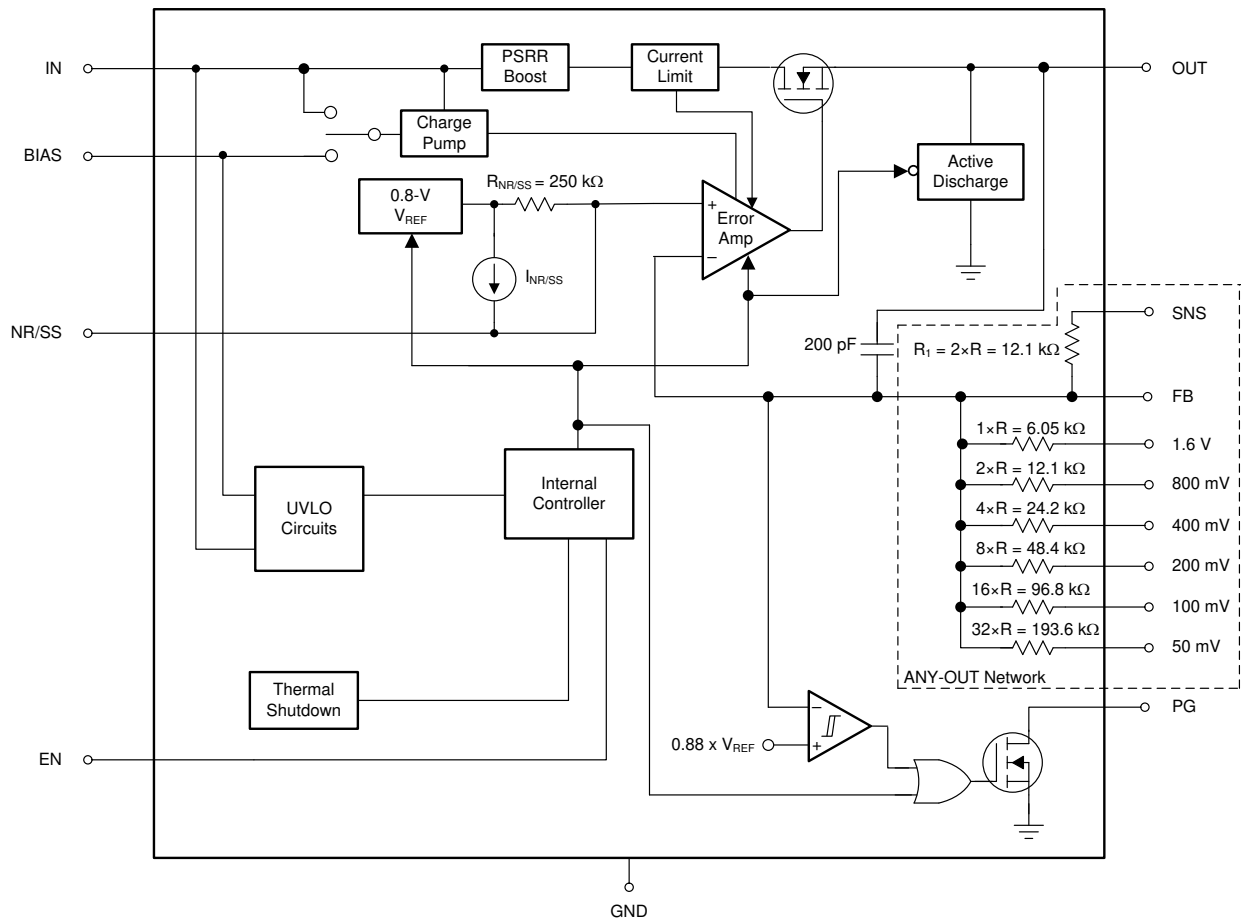

For the ANY-OUT network, the ratios between the values are highly accurate as a result of matching, but the actual resistance may vary significantly from the numbers listed.

图 7-1. TPS7A8400A Block Diagram

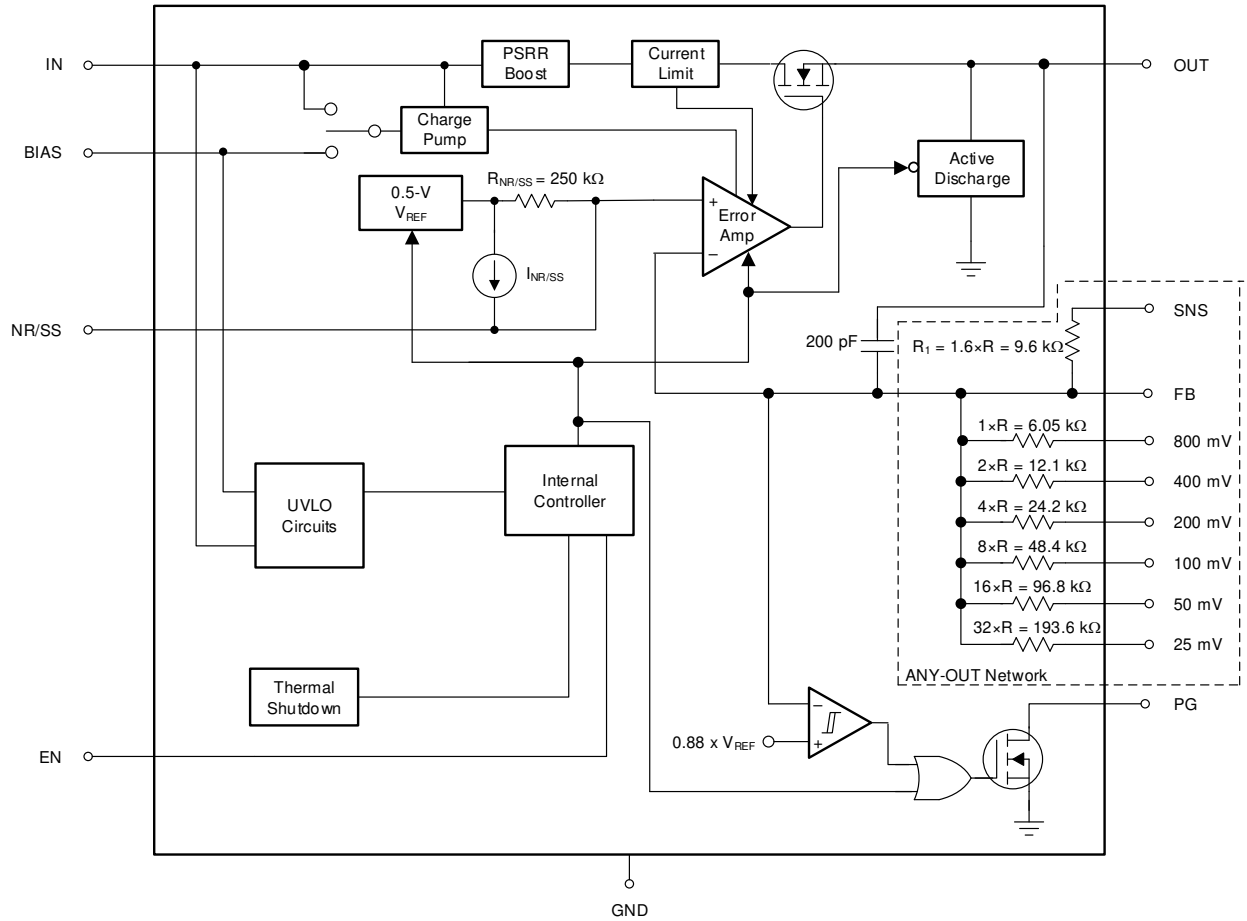

For the ANY-OUT network, the ratios between the values are highly accurate as a result of matching, but the actual resistance may vary significantly from the numbers listed.

7-2. TPS7A8401A Block Diagram

7.3 Feature Description

7.3.1 Voltage Regulation Features

7.3.1.1 DC Regulation

An LDO functions as a class-B amplifier in which the input signal is the internal reference voltage (V_{REF}), as shown in [Simplified Regulation Circuit](#). V_{REF} is designed to have a very low bandwidth at the input to the error amplifier through the use of a low-pass filter ($V_{NR/SS}$).

As such, the reference can be considered as a pure dc input signal. The low output impedance of an LDO comes from the combination of the output capacitor and pass element. The pass element also presents a high input impedance to the source voltage when operating as a current source. A positive LDO can only source current because of the class-B architecture.

This device achieves a maximum of 0.75% output voltage accuracy primarily because of the high-precision band-gap voltage (V_{BG}) that creates V_{REF} . The low dropout voltage (V_{DO}) reduces the thermal power dissipation required by the device to regulate the output voltage at a given current level, thereby improving system efficiency. These features combine to make this device a good approximation of an ideal voltage source.

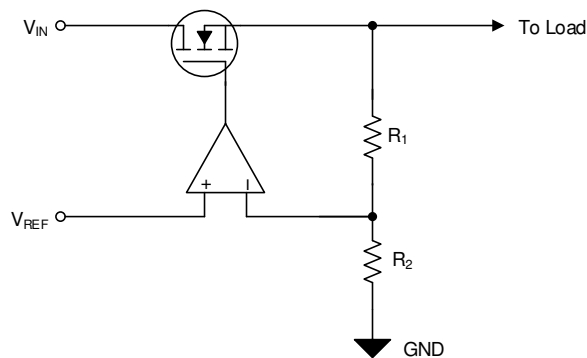

$$V_{OUT} = V_{REF} \times (1 + R_1 / R_2).$$

7-3. Simplified Regulation Circuit

7.3.1.2 AC and Transient Response

The LDO responds quickly to a transient (large-signal response) on the input supply (line transient) or the output current (load transient) resulting from the LDO high-input impedance and low output-impedance across frequency. This same capability also means that the LDO has a high power-supply rejection ratio (PSRR) and, when coupled with a low internal noise-floor (V_n), the LDO approximates an ideal power supply in ac (small-signal) and large-signal conditions.

The choice of external component values optimizes the small- and large-signal response. The NR/SS capacitor ($C_{NR/SS}$) and feed-forward capacitor (C_{FF}) easily reduce the device noise floor and improve PSRR; see the [Optimizing Noise and PSRR](#) section for more information on optimizing the noise and PSRR performance.

7.3.2 System Start-Up Features

In many different applications, the power-supply output must turn on within a specific window of time to either ensure proper operation of the load or to minimize the loading on the input supply or other sequencing requirements. The LDO start-up is well-controlled and user-adjustable, solving the demanding requirements faced by many power-supply design engineers in a simple fashion.

7.3.2.1 Programmable Soft Start (NR/SS)

Soft start directly controls the output start-up time and indirectly controls the output current during start-up (in-rush current).

The external capacitor at the NR/SS pin ($C_{NR/SS}$) sets the output start-up time by setting the rise time of the internal reference ($V_{NR/SS}$), as illustrated in [7-4](#).



图 7-4. Simplified Soft-Start Circuit

7.3.2.2 Internal Sequencing

Controlling when a single power supply turns on can be difficult in a power distribution network (PDN) because of the high power levels inherent in a PDN, and the variations between all of the supplies. The LDO turnon and turnoff time is set by the enable circuit (EN) and undervoltage lockout circuits (UVLO_{1,2(IN)} and UVLO_{BIAS}), as shown in 图 7-5 and 表 7-2.

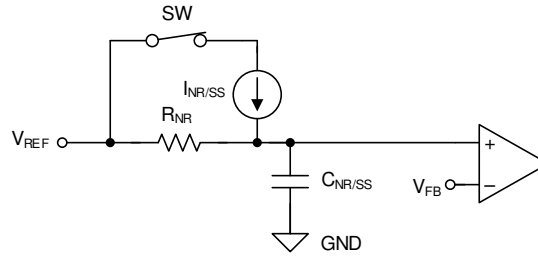

图 7-5. Simplified Turnon Control

表 7-2. Internal Sequencing Functionality Table

INPUT VOLTAGE	BIAS VOLTAGE	ENABLE STATUS	LDO STATUS	ACTIVE DISCHARGE	POWER GOOD
$V_{IN} \geq V_{UVLO_1,2(IN)}$	$V_{BIAS} \geq V_{UVLO(BIAS)}$	EN = 1	On	Off	PG = 1 when $V_{OUT} \geq V_{IT(PG)}$
	$V_{BIAS} < V_{UVLO(BIAS)} + V_{HYS(BIAS)}$	EN = 0	Off	On	PG = 0
$V_{IN} < V_{UVLO_1,2(IN)} - V_{HYS1,2(IN)}$	BIAS = don't care	EN = don't care	Off	On ⁽¹⁾	
IN = don't care	$V_{BIAS} \geq V_{UVLO(BIAS)}$		Off		

(1) The active discharge remains on as long as V_{IN} or V_{BIAS} provides enough headroom for the discharge circuit to function.

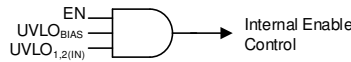
7.3.2.2.1 Enable (EN)

The enable signal (V_{EN}) is an active-high digital control that enables the LDO when the enable voltage is past the rising threshold ($V_{EN} \geq V_{IH(EN)}$) and disables the LDO when the enable voltage is below the falling threshold ($V_{EN} \leq V_{IL(EN)}$). The exact enable threshold is between $V_{IH(EN)}$ and $V_{IL(EN)}$ because EN is a digital control. Connect EN to V_{IN} if enable functionality is not desired.

7.3.2.2.2 Undervoltage Lockout (UVLO) Control

The UVLO circuits respond quickly to glitches on IN or BIAS and attempts to disable the output of the device if either of these rails collapse.

The local input capacitance prevents severe brownouts in most applications; see the [Undervoltage Lockout \(UVLO\)](#) section for more details.

7.3.2.2.3 Active Discharge

When either EN or UVLO is low, the device connects a resistor of several hundred ohms from V_{OUT} to GND, discharging the output capacitance.

Do not rely on the active discharge circuit for discharging large output capacitors when the input voltage drops below the targeted output voltage. Current flows from the output to the input (reverse current) when $V_{OUT} > V_{IN}$, which can cause damage to the device (when $V_{OUT} > V_{IN} + 0.3$ V); see the [Reverse Current Protection](#) section for more details.

7.3.2.3 Power-Good Output (PG)

The PG signal provides an easy solution to meet demanding sequencing requirements because PG signals when the output nears its nominal value. PG can be used to signal other devices in a system when the output voltage is near, at, or above the set output voltage ($V_{OUT(nom)}$). A simplified schematic is shown in [Figure 7-6](#).

The PG signal is an open-drain digital output that requires a pullup resistor to a voltage source and is active high. The PG circuit sets the PG pin into a high-impedance state to indicate that the power is good.

Using a large feed-forward capacitor (C_{FF}) delays the output voltage and, because the PG circuit monitors the FB pin, the PG signal can indicate a false positive. A simple solution to this scenario is to use an external voltage detector device, such as the [TPS3890](#); see the [Feed-Forward Capacitor \(\$C_{FF}\$ \)](#) section for more information.

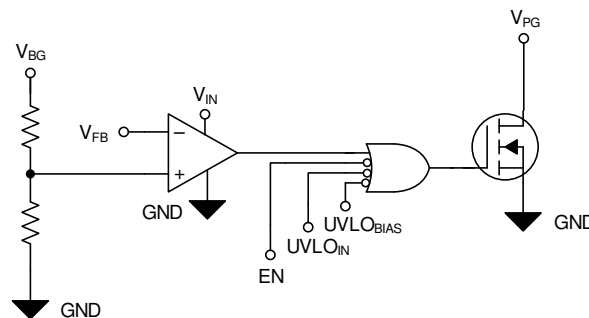

Figure 7-6. Simplified PG Circuit

7.3.3 Internal Protection Features

In many applications, fault events can occur that damage devices in the system. Short circuits and excessive heat are the most common fault events for power supplies. The TPS7A84A implements circuitry to protect the device and its load during these events. Continuously operating in these fault conditions or above a junction temperature of 125°C is not recommended because the long-term reliability of the device is reduced.

7.3.3.1 Foldback Current Limit (I_{CL})

The internal current limit circuit is used to protect the LDO against high load-current faults or shorting events. During a current-limit event, the LDO sources constant current; therefore, the output voltage falls with decreased load impedance. Thermal shutdown can activate during a current limit event because of the high power dissipation typically found in these conditions. To ensure proper operation of the current limit, minimize the inductances to the input and load. Continuous operation in current limit is not recommended.

7.3.3.2 Thermal Protection (T_{sd})

The thermal shutdown circuit protects the LDO against excessive heat in the system, either resulting from current limit or high ambient temperature.

The output of the LDO turns off when the LDO temperature (junction temperature, T_J) exceeds the rising thermal shutdown temperature. The output turns on again after T_J decreases below the falling thermal shutdown temperature.

A high power dissipation across the device, combined with a high ambient temperature (T_A), can cause T_J to be greater than or equal to T_{sd} , triggering the thermal shutdown and causing the output to fall to 0 V. The LDO can cycle on and off when thermal shutdown is reached under these conditions.

7.4 Device Functional Modes

表 7-3 provides a quick comparison between the regulation and disabled operation.

表 7-3. Device Functional Modes Comparison

OPERATING MODE	PARAMETER				
	V_{IN}	V_{BIAS}	EN	I_{OUT}	T_J
Regulation ⁽¹⁾	$V_{IN} > V_{OUT(nom)} + V_{DO}$	$V_{BIAS} \geq V_{UVLO(BIAS)}$ ⁽³⁾	$V_{EN} > V_{IH(EN)}$	$I_{OUT} < I_{CL}$	$T_J \leq T_{J(maximum)}$
Disabled ⁽²⁾	$V_{IN} < V_{UVLO_1,2(IN)}$	$V_{BIAS} < V_{UVLO(BIAS)}$	$V_{EN} < V_{IL(EN)}$		$T_J > T_{sd}$
Current limit operation				$I_{OUT} \geq I_{CL}$	

(1) All table conditions must be met.

(2) The device is disabled when any condition is met.

(3) V_{BIAS} only required for $V_{IN} < 1.4$ V.

7.4.1 Regulation

The device regulates the output to the nominal output voltage when all the conditions in 表 7-3 are met.

7.4.2 Disabled

When disabled, the pass device is turned off, the internal circuits are shut down, and the output voltage is actively discharged to ground by an internal resistor from the output to ground. See the [Active Discharge](#) section for additional information.

8 Application and Implementation

Note

Information in the following applications sections is not part of the TI component specification, and TI does not warrant its accuracy or completeness. TI's customers are responsible for determining suitability of components for their purposes, as well as validating and testing their design implementation to confirm system functionality.

8.1 Application Information

Successfully implementing an LDO in an application depends on the application requirements. This section discusses key device features and how to best implement them to achieve a reliable design.

8.1.1 External Component Selection

8.1.1.1 Adjustable Operation

The TPS7A84A can be used either with the internal ANY-OUT network or by using external resistors. Using the ANY-OUT network allows the TPS7A8400A to be programmed from 0.8 V to 3.95 V and from 0.5 V to 2.075 V for the TPS7A8401A. For an output voltage range greater than 2.075 V for the TPS7A8401A and 3.95 V for the TPS7A8400A and up to 5.15 V, external resistors must be used. This configuration is referred to as the adjustable configuration of the TPS7A84A throughout this document. The output voltage is set by two resistors, as shown in [Figure 8-1](#). 0.75% accuracy can be achieved with an external BIAS for V_{IN} lower than 2.2 V.

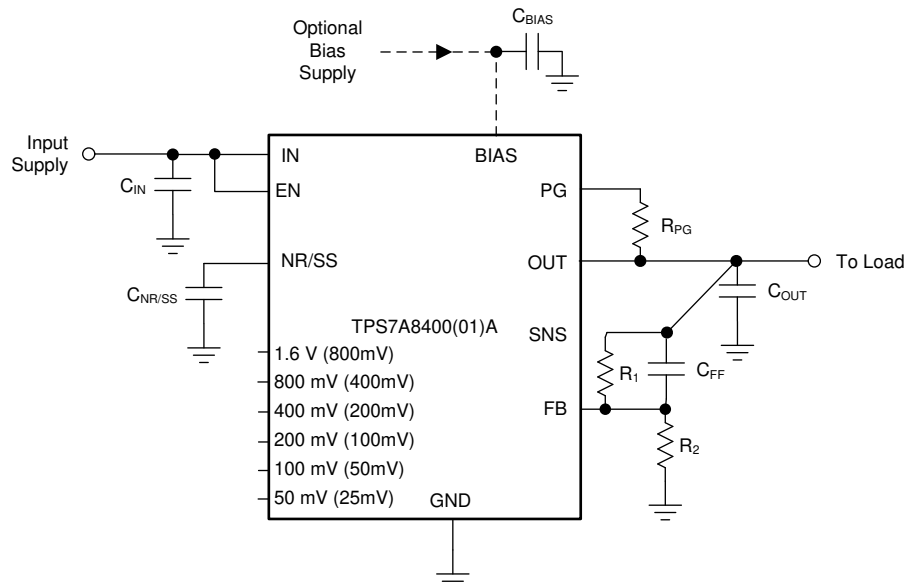

Figure 8-1. Adjustable Operation

R_1 and R_2 can be calculated for any output voltage range using [Equation 1](#). This resistive network must provide a current equal to or greater than 5 μ A for dc accuracy. TI recommends using an R_1 approximately 12 k Ω to optimize the noise and PSRR.

$$V_{OUT} = V_{NR/SS} \times (1 + R_1 / R_2) \quad (1)$$

表 8-1 shows the resistor combinations required to achieve several common rails using standard 1%-tolerance resistors.

表 8-1. Recommended Feedback-Resistor Values (TPS7A8400A)⁽¹⁾

TARGETED OUTPUT VOLTAGE (V)	FEEDBACK RESISTOR VALUES		CALCULATED OUTPUT VOLTAGE (V)
	R ₁ (kΩ)	R ₂ (kΩ)	
0.9	12.4	100	0.899
0.95	12.4	66.5	0.949
1.00	12.4	49.9	0.999
1.10	12.4	33.2	1.099
1.20	12.4	24.9	1.198
1.50	12.4	14.3	1.494
1.80	12.4	10	1.798
1.90	12.1	8.87	1.89
2.50	12.4	5.9	2.48
2.85	12.1	4.75	2.838
3.00	12.1	4.42	2.990
3.30	11.8	3.74	3.324
3.60	12.1	3.48	3.582
4.5	11.8	2.55	4.502
5.00	12.4	2.37	4.985

(1) R₁ is connected from OUT to FB; R₂ is connected from FB to GND.

表 8-2. Recommended Feedback-Resistor Values (TPS7A8401A)⁽¹⁾

TARGETED OUTPUT VOLTAGE (V)	FEEDBACK RESISTOR VALUES		CALCULATED OUTPUT VOLTAGE (V)
	R ₁ (kΩ)	R ₂ (kΩ)	
0.6	11	54.9	0.600
0.7	10.2	25.5	0.700
0.75	10	20	0.750
0.8	10.7	17.8	0.800
0.9	11	13.7	0.901
1.0	9.09	9.09	1.000
1.05	11	10	1.050
1.1	10.7	8.87	1.103
1.2	9.31	6.65	1.200
1.5	11	5.49	1.502
1.8	10.2	3.92	1.801
3.30	10.7	1.91	3.301
5.00	10.2	1.13	5.013

8.1.1.2 ANY-OUT Programmable Output Voltage

The TPS7A84A can use either external resistors or the internally-matched ANY-OUT feedback resistor network to set output voltage. The ANY-OUT resistors are accessible via pin 2 and pins 5 to 11 and are used to program the regulated output voltage. Each pin is can be connected to ground (active) or left open (floating), or connected to SNS. ANY-OUT programming is set by 式 2 as the sum of the internal reference voltage ($V_{NR/SS} = 0.8$ V) plus the accumulated sum of the respective voltages assigned to each active pin; that is, for the TPS7A8400A, 50mV (pin 5), 100mV (pin 6), 200mV (pin 7), 400mV (pin 9), 800mV (pin 10), or 1.6V (pin 11), and for the TPS7A8401A, 25mV (pin 5), 50mV (pin 6), 100mV (pin 7), 200mV (pin 9), 400mV (pin 10), or 800mV (pin 11). 表 8-3 summarizes these voltage values associated with each active pin setting for reference. By leaving all

program pins open or floating, the output is thereby programmed to the minimum possible output voltage equal to V_{FB} .

$$V_{OUT} = V_{NR/SS} + (\Sigma \text{ ANY-OUT Pins to Ground}) \quad (2)$$

表 8-3. ANY-OUT Programmable Output Voltage (RGR Package)

ANY-OUT PROGRAM PINS (Active Low)	ADDITIVE OUTPUT VOLTAGE LEVEL (TPS7A8400A)	ADDITIVE OUTPUT VOLTAGE LEVEL (TPS7A8401A)
Pin 5	50 mV	25 mV
Pin 6	100 mV	50 mV
Pin 7	200 mV	100 mV
Pin 9	400 mV	200 mV
Pin 10	800 mV	400 mV
Pin 11	1.6 V	800 mV

表 8-4 和 表 8-5 provide a full list of target output voltages and corresponding pin settings when the ANY-OUT pins are only tied to ground or left floating. The voltage setting pins have a binary weight; therefore, the output voltage can be programmed to any value from 0.8 V to 3.95 V in 50-mV steps for the TPS7A8400A and from 0.5 V to 2.075 V for the TPS7A8401A in 25-mV steps when tying these pins to ground. There are several alternative ways to set the output voltage. The program pins can be driven using external general-purpose input/output pins (GPIOs), manually connected using 0- Ω resistors (or left open), or hardwired by the given layout of the printed circuit board (PCB) to set the ANY-OUT voltage. As with the adjustable operation, the output voltage is set according to 式 3 except that R_1 and R_2 are internally integrated and matched for higher accuracy. Tying any of the ANY-OUT pins to SNS can increase the resolution of the internal feedback network by lowering the value of R_1 . See the [Increasing ANY-OUT Resolution for LILO Conditions](#) section for additional information.

$$V_{OUT} = V_{NR/SS} \times (1 + R_1 / R_2) \quad (3)$$

Note

For output voltages greater than 3.95 V, use a traditional adjustable configuration (see the [Adjustable Operation](#) section).

表 8-4. TPS7A8400A User-Configurable Output Voltage Settings

$V_{OUT(NOM)}$ (V)	50mV	100mV	200mV	400mV	800mV	1.6V	$V_{OUT(NOM)}$ (V)	50mV	100mV	200mV	400mV	800mV	1.6V
0.80	Open	Open	Open	Open	Open	Open	2.40	Open	Open	Open	Open	Open	GND
0.85	GND	Open	Open	Open	Open	Open	2.45	GND	Open	Open	Open	Open	GND
0.90	Open	GND	Open	Open	Open	Open	2.50	Open	GND	Open	Open	Open	GND
0.95	GND	GND	Open	Open	Open	Open	2.55	GND	GND	Open	Open	Open	GND
1.00	Open	Open	GND	Open	Open	Open	2.60	Open	Open	GND	Open	Open	GND
1.05	GND	Open	GND	Open	Open	Open	2.65	GND	Open	GND	Open	Open	GND
1.10	Open	GND	GND	Open	Open	Open	2.70	Open	GND	GND	Open	Open	GND
1.15	GND	GND	GND	Open	Open	Open	2.75	GND	GND	GND	Open	Open	GND
1.20	Open	Open	Open	GND	Open	Open	2.80	Open	Open	Open	GND	Open	GND
1.25	GND	Open	Open	GND	Open	Open	2.85	GND	Open	Open	GND	Open	GND
1.30	Open	GND	Open	GND	Open	Open	2.90	Open	GND	Open	GND	Open	GND
1.35	GND	GND	Open	GND	Open	Open	2.95	GND	GND	Open	GND	Open	GND
1.40	Open	Open	GND	GND	Open	Open	3.00	Open	Open	GND	GND	Open	GND
1.45	GND	Open	GND	GND	Open	Open	3.05	GND	Open	GND	GND	Open	GND
1.50	Open	GND	GND	GND	Open	Open	3.10	Open	GND	GND	GND	Open	GND
1.55	GND	GND	GND	GND	Open	Open	3.15	GND	GND	GND	GND	Open	GND
1.60	Open	Open	Open	Open	GND	Open	3.20	Open	Open	Open	Open	GND	GND
1.65	GND	Open	Open	Open	GND	Open	3.25	GND	Open	Open	Open	GND	GND
1.70	Open	GND	Open	Open	GND	Open	3.30	Open	GND	Open	Open	GND	GND
1.75	GND	GND	Open	Open	GND	Open	3.35	GND	GND	Open	Open	GND	GND
1.80	Open	Open	GND	Open	GND	Open	3.40	Open	Open	GND	Open	GND	GND
1.85	GND	Open	GND	Open	GND	Open	3.45	GND	Open	GND	Open	GND	GND
1.90	Open	GND	GND	Open	GND	Open	3.50	Open	GND	GND	Open	GND	GND
1.95	GND	GND	GND	Open	GND	Open	3.55	GND	GND	GND	Open	GND	GND
2.00	Open	Open	Open	GND	GND	Open	3.60	Open	Open	Open	GND	GND	GND
2.05	GND	Open	Open	GND	GND	Open	3.65	GND	Open	Open	GND	GND	GND
2.10	Open	GND	Open	GND	GND	Open	3.70	Open	GND	Open	GND	GND	GND
2.15	GND	GND	Open	GND	GND	Open	3.75	GND	GND	Open	GND	GND	GND
2.20	Open	Open	GND	GND	GND	Open	3.80	Open	Open	GND	GND	GND	GND
2.25	GND	Open	GND	GND	GND	Open	3.85	GND	Open	GND	GND	GND	GND
2.30	Open	GND	GND	GND	GND	Open	3.90	Open	GND	GND	GND	GND	GND
2.35	GND	GND	GND	GND	GND	Open	3.95	GND	GND	GND	GND	GND	GND

表 8-5. TPS7A8401A User-Configurable Output Voltage Settings

V _{OUT(NOM)} (V)	25mV	50mV	100mV	200mV	400mV	800mV	V _{OUT(NOM)} (V)	25mV	50mV	100mV	200mV	400mV	800mV
0.500	Open	Open	Open	Open	Open	Open	1.300	Open	Open	Open	Open	Open	GND
0.525	GND	Open	Open	Open	Open	Open	1.325	GND	Open	Open	Open	Open	GND
0.550	Open	GND	Open	Open	Open	Open	1.350	Open	GND	Open	Open	Open	GND
0.575	GND	GND	Open	Open	Open	Open	1.375	GND	GND	Open	Open	Open	GND
0.600	Open	Open	GND	Open	Open	Open	1.400	Open	Open	GND	Open	Open	GND
0.625	GND	Open	GND	Open	Open	Open	1.425	GND	Open	GND	Open	Open	GND
0.650	Open	GND	GND	Open	Open	Open	1.450	Open	GND	GND	Open	Open	GND
0.675	GND	GND	GND	Open	Open	Open	1.475	GND	GND	GND	Open	Open	GND
0.700	Open	Open	Open	GND	Open	Open	1.500	Open	Open	Open	GND	Open	GND
0.725	GND	Open	Open	GND	Open	Open	1.525	GND	Open	Open	GND	Open	GND
0.750	Open	GND	Open	GND	Open	Open	1.550	Open	GND	Open	GND	Open	GND
0.775	GND	GND	Open	GND	Open	Open	1.575	GND	GND	Open	GND	Open	GND
0.800	Open	Open	GND	GND	Open	Open	1.600	Open	Open	GND	GND	Open	GND
0.825	GND	Open	GND	GND	Open	Open	1.625	GND	Open	GND	GND	Open	GND
0.850	Open	GND	GND	GND	Open	Open	1.650	Open	GND	GND	GND	Open	GND
0.875	GND	GND	GND	GND	Open	Open	1.675	GND	GND	GND	GND	Open	GND
0.900	Open	Open	Open	Open	GND	Open	1.700	Open	Open	Open	Open	GND	GND
0.925	GND	Open	Open	Open	GND	Open	1.725	GND	Open	Open	Open	GND	GND
0.950	Open	GND	Open	Open	GND	Open	1.750	Open	GND	Open	Open	GND	GND
0.975	GND	GND	Open	Open	GND	Open	1.775	GND	GND	Open	Open	GND	GND
1.000	Open	Open	GND	Open	GND	Open	1.800	Open	Open	GND	Open	GND	GND
1.025	GND	Open	GND	Open	GND	Open	1.825	GND	Open	GND	Open	GND	GND
1.050	Open	GND	GND	Open	GND	Open	1.850	Open	GND	GND	Open	GND	GND
1.075	GND	GND	GND	Open	GND	Open	1.875	GND	GND	GND	Open	GND	GND
1.100	Open	Open	Open	GND	GND	Open	1.900	Open	Open	Open	GND	GND	GND
1.125	GND	Open	Open	GND	GND	Open	1.925	GND	Open	Open	GND	GND	GND
1.150	Open	GND	Open	GND	GND	Open	1.950	Open	GND	Open	GND	GND	GND
1.175	GND	GND	Open	GND	GND	Open	1.975	GND	GND	Open	GND	GND	GND
1.200	Open	Open	GND	GND	GND	Open	2.000	Open	Open	GND	GND	GND	GND
1.225	GND	Open	GND	GND	GND	Open	2.025	GND	Open	GND	GND	GND	GND
1.250	Open	GND	GND	GND	GND	Open	2.050	Open	GND	GND	GND	GND	GND
1.275	GND	GND	GND	GND	GND	Open	2.075	GND	GND	GND	GND	GND	GND

8.1.1.3 ANY-OUT Operation

Considering the use of the ANY-OUT internal network (where the unit resistance of 1R, see , is equal to 6.05 kΩ) the output voltage is set by grounding the appropriate control pins, as shown in 8-2. When grounded, all control pins add a specific voltage on top of the internal reference voltage ($V_{NR/SS} = 0.8\text{ V}$). The output voltage can be calculated by 式 4 and 式 5. 8-2 and 8-3 show a 0.9-V output voltage, respectively, that provide an example of the circuit usage with and without bias voltage.

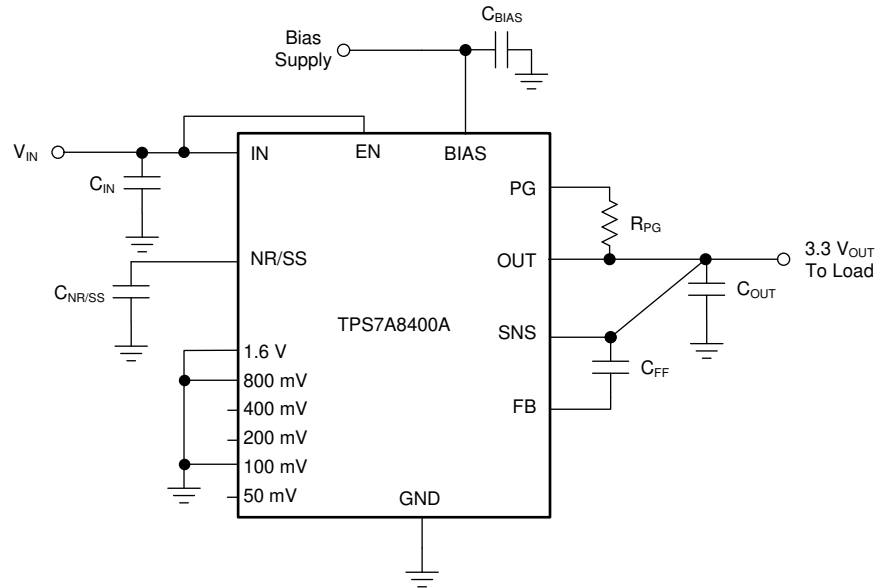

8-2. ANY-OUT Configuration Circuit (TPS7A8400A) (3.3-V Output, No External Bias)

$$V_{OUT(nom)} = V_{NR/SS} + 1.6\text{ V} + 0.8\text{ V} + 0.1\text{ V} = 0.8\text{ V} + 1.6\text{ V} + 0.8\text{ V} + 0.1\text{ V} = 3.3\text{ V} \quad (4)$$

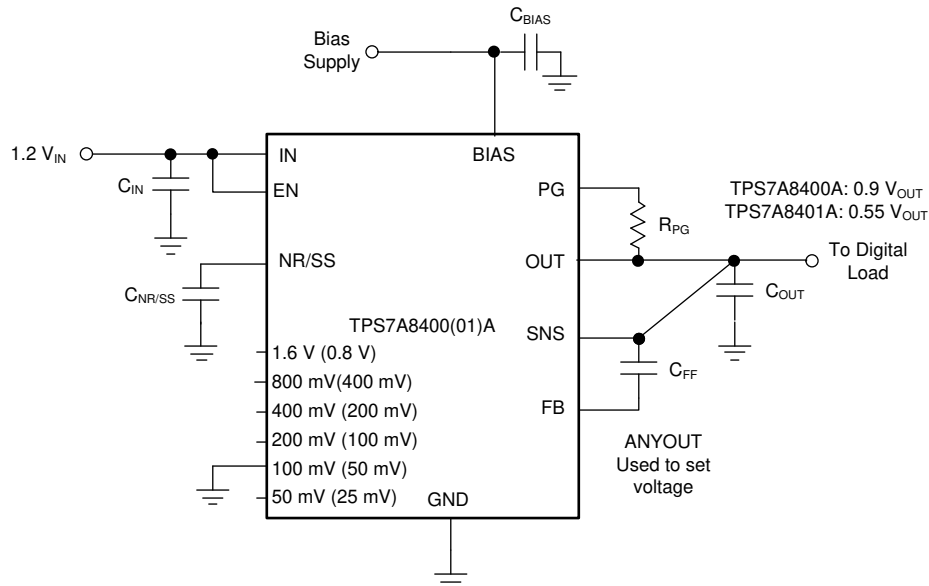

8-3. ANY-OUT Configuration Circuit (0.9-V, 0.55-V Output with Bias)

$$V_{OUT(nom)} = V_{NR/SS} + 0.1\text{ V} = 0.8\text{ V} + 0.1\text{ V} = 0.9\text{ V} \quad (5)$$

8.1.1.4 Increasing ANY-OUT Resolution for LILO Conditions

As with the adjustable operation, the output voltage is set according to 式 3, except that R_1 and R_2 are internally integrated and matched for higher accuracy. Tying any of the ANY-OUT pins to SNS can increase the resolution of the internal feedback network by lowering the value of R_1 . One of the more useful pin combinations is to tie the 800mV pin to SNS, which reduces the resolution by 50% to 25 mV but limits the range. The new ANY-OUT ranges are 0.8 V to 1.175 V and 1.6 V to 1.975 V. The new additive output voltage levels are listed in 表 8-6.

表 8-6. ANY-OUT Programmable Output Voltage With 800 mV Tied to SNS (TPS7A8400A)

ANY-OUT PROGRAM PINS (Active Low)	ADDITIVE OUTPUT VOLTAGE LEVEL
Pin 5 (50mV)	25 mV
Pin 6 (100mV)	50 mV
Pin 7 (200mV)	100 mV
Pin 9 (400mV)	200 mV
Pin 11 (1.6V)	800 V

8.1.1.5 Current Sharing

There are two main current sharing implementations:

1. Through the use of external operational amplifiers. For more details, see the [Current-Sharing Dual LDOs](#) and [6 A Current-Sharing Dual LDO reference guides](#).
2. Through the use of external ballast resistors. For more details of this implementation, see the [High-Current Low-Noise Parallel LDO reference design](#).

8.1.1.6 Recommended Capacitor Types

The TPS7A84A is designed to be stable using low equivalent series resistance (ESR) ceramic capacitors at the input, output, and noise-reduction pin (NR/SS). Multilayer ceramic capacitors have become the industry standard for these types of applications and are recommended, but must be used with good judgment. Ceramic capacitors that employ X7R-, X5R-, and COG-rated dielectric materials provide relatively good capacitive stability across temperature, whereas the use of Y5V-rated capacitors is discouraged because of large variations in capacitance.

Regardless of the ceramic capacitor type selected, ceramic capacitance varies with operating voltage and temperature; derate ceramic capacitors by at least 50%. The input and output capacitors recommended herein account for a capacitance derating of approximately 50%, but at high V_{IN} and V_{OUT} conditions (for example, $V_{IN} = 5.6$ V to $V_{OUT} = 5.15$ V) the derating can be greater than 50% and must be taken into consideration.

8.1.1.7 Input and Output Capacitor Requirements (C_{IN} and C_{OUT})

The TPS7A84A is designed and characterized for operation with ceramic capacitors of 47 μ F or greater (22 μ F or greater of capacitance) at the output and 10 μ F or greater (5 μ F or greater of capacitance) at the input. Using at least a 47- μ F capacitor is highly recommended at the input to minimize input impedance. Place the input and output capacitors as near as practical to the respective input and output pins to minimize trace parasitic. If the trace inductance from the input supply to the TPS7A84A is high, a fast current transient can cause V_{IN} to ring above the absolute maximum voltage rating and damage the device. This situation can be mitigated by additional input capacitors to dampen the ringing and to keep it below the device absolute maximum ratings.

A combination of multiple output capacitors boosts the high-frequency PSRR as shown in several of the PSRR curves. The combination of one 0805-sized, 47- μ F ceramic capacitor in parallel with two 0805-sized, 10- μ F ceramic capacitors with a sufficient voltage rating in conjunction with the PSRR boost circuit optimizes PSRR for the frequency range of 400 kHz to 700 kHz, a typical range for dc-dc supply switching frequency. This 47- μ F || 10- μ F || 10- μ F combination also ensures that at high input voltage and high output voltage configurations, the minimum effective capacitance is met. Many 0805-sized, 47- μ F ceramic capacitors have a voltage derating of approximately 60% to 80% at 5.15 V, so the addition of the two 10- μ F capacitors ensures that the capacitance is at or above 25 μ F.

8.1.1.8 Feed-Forward Capacitor (C_{FF})

Although a feed-forward capacitor (C_{FF}) from the FB pin to the OUT pin is not required to achieve stability, a 10-nF external feed-forward capacitor optimizes the transient, noise, and PSRR performance. A higher capacitance C_{FF} can be used; however, the start-up time is longer, and the PG signal can incorrectly indicate that the output voltage is settled. For a detailed description, see [Pros and Cons of Using a Feed-Forward Capacitor with a Low Dropout Regulator](#).

8.1.1.9 Noise-Reduction and Soft-Start Capacitor ($C_{NR/SS}$)

The TPS7A84A features a programmable, monotonic, voltage-controlled soft-start that is set with an external capacitor ($C_{NR/SS}$). The use of an external $C_{NR/SS}$ is highly recommended, especially to minimize in-rush current into the output capacitors. This soft-start eliminates power-up initialization problems when powering field-programmable gate arrays (FPGAs), digital signal processors (DSPs), or other processors. The controlled voltage ramp of the output also reduces peak in-rush current during start-up, minimizing start-up transients to the input power bus.

To achieve a monotonic start-up, the TPS7A84A error amplifier tracks the voltage ramp of the external soft-start capacitor until the voltage approaches the internal reference. The soft-start ramp time depends on the soft-start charging current ($I_{NR/SS}$), the soft-start capacitance ($C_{NR/SS}$), and the internal reference ($V_{NR/SS}$). Soft-start ramp time can be calculated with [式 6](#):

$$t_{SS} = (V_{NR/SS} \times C_{NR/SS}) / I_{NR/SS} \quad (6)$$

$I_{NR/SS}$ is provided in the *Electrical Characteristics: General* table in the [Specifications](#) section.

The noise-reduction capacitor, in conjunction with the noise-reduction resistor, forms a low-pass filter (LPF) that filters out the noise from the reference before being gained up with the error amplifier, thereby reducing the device noise floor. The LPF is a single-pole filter and the cutoff frequency can be calculated with [式 7](#). The typical value of $R_{NR/SS}$ is 250 k Ω . Increasing the $C_{NR/SS}$ capacitor has a greater affect because the output voltage increases when the noise from the reference is gained up even more at higher output voltages. For low-noise applications, a 10-nF to 1- μ F $C_{NR/SS}$ is recommended. Note that as a $C_{NR/SS}$ capacitor gets larger, the capacitor leakage will increase causing longer than expected start-up time.

$$f_{cutoff} = 1 / (2 \times \pi \times R_{NR/SS} \times C_{NR/SS}) \quad (7)$$

8.1.2 Start-Up

8.1.2.1 Circuit Soft-Start Control (NR/SS)

Each output of the device features a user-adjustable, monotonic, voltage-controlled soft-start that is set with an external capacitor ($C_{NR/SS}$). This soft-start eliminates power-up initialization problems when powering field-programmable gate arrays (FPGAs), digital signal processors (DSPs), or other processors. The controlled voltage ramp of the output also reduces peak inrush current during start-up, thus minimizing start-up transients to the input power bus.

The output voltage (V_{OUT}) rises proportionally to $V_{NR/SS}$ during start-up as the LDO regulates so that the feedback voltage equals the NR/SS voltage ($V_{FB} = V_{NR/SS}$). As such, the time required for $V_{NR/SS}$ to reach its nominal value determines the rise time of V_{OUT} (start-up time).

Not using a noise-reduction capacitor on the NR/SS pin may result in output voltage overshoot of approximately 10%. Using a capacitor on the NR/SS pin minimizes the overshoot.

Values for the soft-start charging currents are provided in the *Electrical Characteristics: General* table in the [Specifications](#) section.

8.1.2.1.1 Inrush Current

Inrush current is defined as the current into the LDO at the IN pin during start-up. Inrush current then consists primarily of the sum of load current and the current used to charge the output capacitor. This current is difficult to measure because the input capacitor must be removed, which is not recommended. However, this soft-start current can be estimated by 式 8:

$$I_{OUT}(t) = \left(\frac{C_{OUT} \times dV_{OUT}(t)}{dt} \right) + \left(\frac{V_{OUT}(t)}{R_{LOAD}} \right) \tag{8}$$

where:

- $V_{OUT}(t)$ is the instantaneous output voltage of the turnon ramp
- $dV_{OUT}(t) / dt$ is the slope of the V_{OUT} ramp
- R_{LOAD} is the resistive load impedance

8.1.2.2 Undervoltage Lockout (UVLO)

The UVLO circuits ensure that the device stays disabled before its input or bias supplies reach the minimum operational voltage range, and ensures that the device properly shuts down when either the input or bias supply collapses.

图 8-4 和 表 8-7 解释其中一个的 UVLO 电路 being triggered to various input voltage events, assuming $V_{EN} \geq V_{IH(EN)}$.



图 8-4. Typical UVLO Operation

表 8-7. Typical UVLO Operation Description

REGION	EVENT	V _{OUT} STATUS	COMMENT
A	Turnon, $V_{IN} \geq V_{UVLO_1,2(IN)}$ and $V_{BIAS} \geq V_{UVLO(BIAS)}$	Off	Start-up
B	Regulation	On	Regulates to target V_{OUT}
C	Brownout, $V_{IN} \geq V_{UVLO_1,2(IN)} - V_{HYS_1,2(IN)}$ or $V_{BIAS} \geq V_{UVLO(BIAS)} - V_{HYS(BIAS)}$	On	The output can fall out of regulation but the device is still enabled.
D	Regulation	On	Regulates to target V_{OUT}
E	Brownout, $V_{IN} < V_{UVLO_1,2(IN)} - V_{HYS_1,2(IN)}$ or $V_{BIAS} < V_{UVLO(BIAS)} - V_{HYS(BIAS)}$	Off	The device is disabled and the output falls because of the load and active discharge circuit. The device is reenabled when the UVLO fault is removed when either the IN or BIAS UVLO rising threshold is reached by the input or bias voltage and a normal start-up then follows.
F	Regulation	On	Regulates to target V_{OUT}
G	Turnoff, $V_{IN} < V_{UVLO_1,2(IN)} - V_{HYS_1,2(IN)}$ or $V_{BIAS} < V_{UVLO(BIAS)} - V_{HYS(BIAS)}$	Off	The output falls because of the load and active discharge circuit.

Similar to many other LDOs with this feature, the UVLO circuits take a few microseconds to fully assert. During this time, a downward line transient below approximately 0.8 V causes the UVLO to assert for a short time; however, the UVLO circuits do not have enough stored energy to fully discharge the internal circuits inside of the device. When the UVLO circuits are not given enough time to fully discharge the internal nodes, the outputs are not fully disabled.

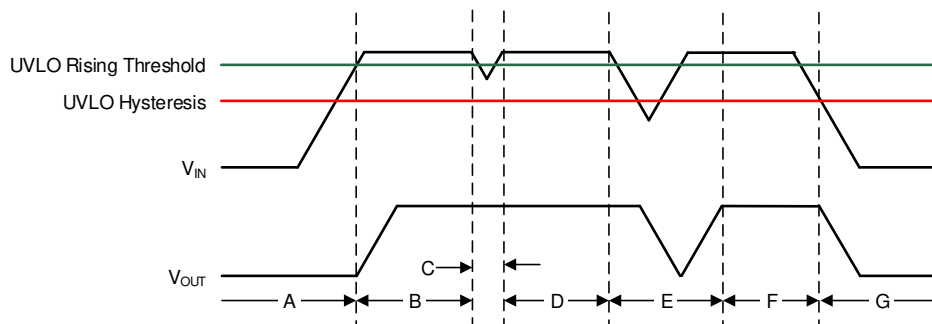
The effect of the downward line transient can be mitigated by using a larger input capacitor to increase the fall time of the input supply when operating near the minimum V_{IN} .

8.1.2.3 Power-Good (PG) Function

The PG circuit monitors the voltage at the feedback pin to indicate the status of the output voltage. The PG circuit asserts whenever V_{FB} , V_{IN} , or EN are below their thresholds. The PG operation versus the output voltage is shown in [Figure 8-5](#), which is described by [Table 8-8](#).

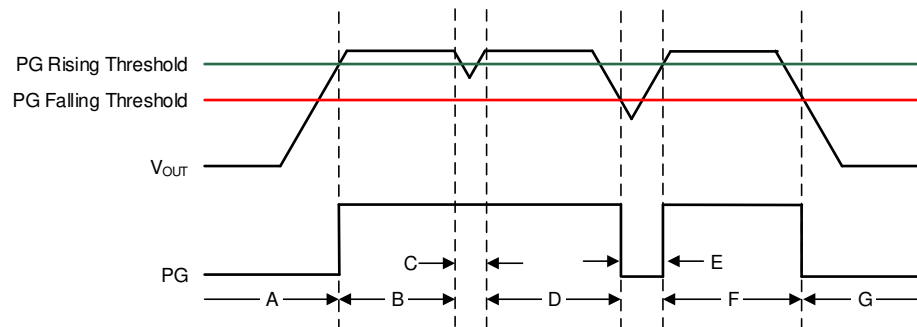

Figure 8-5. Typical PG Operation

Table 8-8. Typical PG Operation Description

REGION	EVENT	PG STATUS	FB VOLTAGE
A	Turnon	0	$V_{FB} < V_{IT(PG)} + V_{HYS(PG)}$
B	Regulation	Hi-Z	$V_{FB} \geq V_{IT(PG)}$
C	Output voltage dip	Hi-Z	
D	Regulation	Hi-Z	
E	Output voltage dip	0	$V_{FB} < V_{IT(PG)}$
F	Regulation	Hi-Z	$V_{FB} \geq V_{IT(PG)}$
G	Turnoff	0	$V_{FB} < V_{IT(PG)}$

The PG pin is open-drain, and connecting a pullup resistor to an external supply enables others devices to receive Power Good as a logic signal that can be used for sequencing. Make sure that the external pullup supply voltage results in a valid logic signal for the receiving device or devices.

To ensure proper operation of the PG circuit, the pullup resistor value must be from 10 k Ω and 100 k Ω . The lower limit of 10 k Ω results from the maximum pulldown strength of the PG transistor, and the upper limit of 100 k Ω results from the maximum leakage current at the PG node. If the pullup resistor is outside of this range, then the PG signal may not read a valid digital logic level.

Using a large C_{FF} with a small $C_{NR/SS}$ causes the PG signal to incorrectly indicate that the output voltage has settled during turnon. The C_{FF} time constant must be greater than the soft-start time constant to ensure proper operation of the PG during start-up. For a detailed description, see [Pros and Cons of Using a Feed-Forward Capacitor with a Low Drop-out Regulator](#).

The state of PG is only valid when the device operates above the minimum supply voltage. During short brownout events and at light loads, PG does not assert because the output voltage (therefore V_{FB}) is sustained by the output capacitance.

8.1.3 AC and Transient Performance

LDO ac performance includes power-supply-rejection ratio, output-current transient response, and output noise. These metrics are primarily a function of open-loop gain, bandwidth, and phase margin that control the closed-loop input and output impedance of the LDO. The output noise is primarily a result of the reference and error amplifier noise.

8.1.3.1 Power-Supply Rejection Ratio (PSRR)

PSRR is a measure of how well the LDO control loop rejects signals from V_{IN} to V_{OUT} across the frequency spectrum (usually 10 Hz to 10 MHz). 式 9 gives the PSRR calculation as a function of frequency for the input signal $[V_{IN}(f)]$ and output signal $[V_{OUT}(f)]$.

$$PSRR(dB) = 20 \text{Log}_{10} \left(\frac{V_{IN}(f)}{V_{OUT}(f)} \right) \tag{9}$$

Even though PSRR is a loss in signal amplitude, PSRR is shown as positive values in decibels (dB) for convenience.

A simplified diagram of PSRR versus frequency is shown in [Figure 8-6](#).

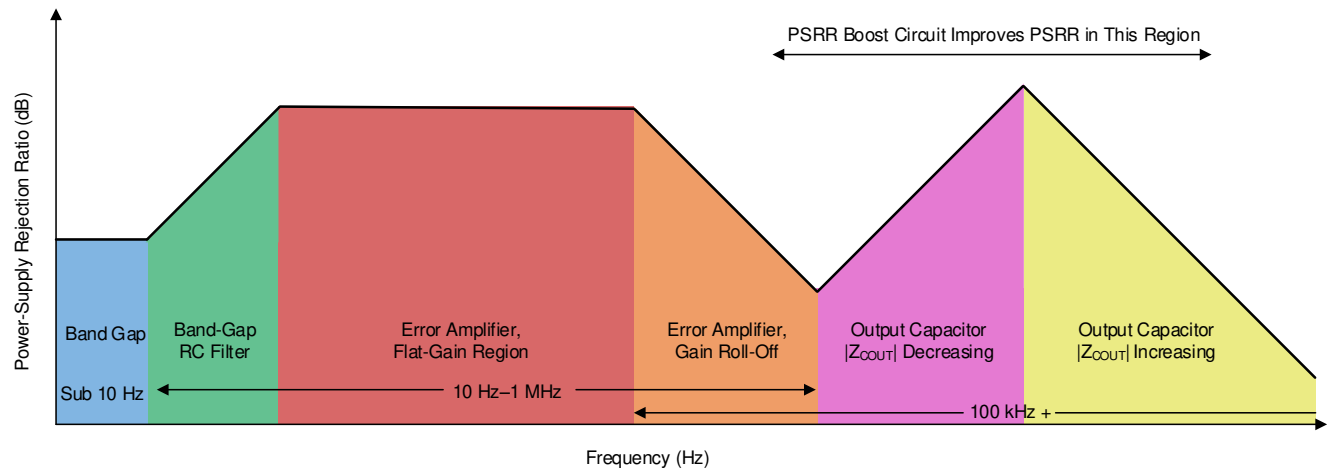

Figure 8-6. Power-Supply Rejection Ratio Diagram

An LDO is often employed not only as a dc-dc regulator, but also to provide exceptionally clean power-supply voltages that exhibit ultra-low noise and ripple to sensitive system components. This usage is especially true for the TPS7A84A.

The TPS7A84A features an innovative circuit to boost the PSRR from 200 kHz to 1 MHz; see [PSRR vs Frequency and \$I_{OUT}\$](#) . To achieve the maximum benefit of this PSRR boost circuit, TI recommends using a capacitor with a minimum impedance in the 100-kHz to 1-MHz band.

8.1.3.2 Output Voltage Noise

The TPS7A84A is designed for system applications where minimizing noise on the power-supply rail is critical to system performance. For example, the TPS7A84A can be used in a phase-locked loop (PLL)-based clocking circuit can be used for minimum phase noise, or in test and measurement systems where even small power-supply noise fluctuations reduce system dynamic range.

LDO noise is defined as the internally-generated intrinsic noise created by the semiconductor circuits alone. This noise is the sum of various types of noise (such as shot noise associated with current-through-pin junctions, thermal noise caused by thermal agitation of charge carriers, flicker noise, or 1/f noise and dominates at lower frequencies as a function of 1/f). [Figure 8-7](#) shows a simplified output voltage noise density plot versus frequency.

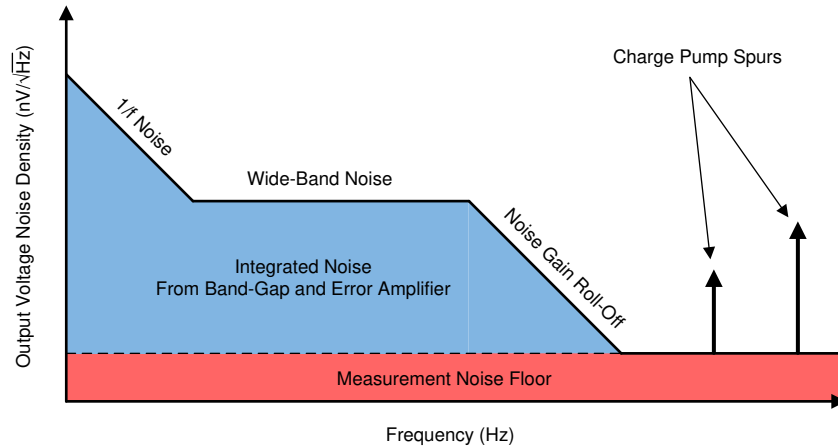

Figure 8-7. Output Voltage Noise Diagram

For further details, see the [How to Measure LDO Noise](#) white paper.

8.1.3.3 Optimizing Noise and PSRR

The ultra-low noise floor and PSRR of the device can be improved in several ways, as described in [Table 8-9](#).

Table 8-9. Effect of Various Parameters on AC Performance^{(1) (2)}

PARAMETER	NOISE			PSRR		
	LOW-FREQUENCY	MID-FREQUENCY	HIGH-FREQUENCY	LOW-FREQUENCY	MID-FREQUENCY	HIGH-FREQUENCY
$C_{NR/SS}$	+++	No effect	No effect	+++	+	No effect
C_{FF}	++	+++	+	++	+++	+
C_{OUT}	No effect	+	+++	No effect	+	+++
$V_{IN} - V_{OUT}$	+	+	+	+++	+++	++
PCB layout	++	++	+	+	+++	+++

(1) The number of '+'s indicates the improvement in noise or PSRR performance by increasing the parameter value.

(2) Shaded cells indicate the easiest improvement to noise or PSRR performance.

The noise-reduction capacitor, in conjunction with the noise-reduction resistor, forms a low-pass filter (LPF) that filters out the noise from the reference before being gained up with the error amplifier, thereby minimizing the output voltage noise floor. The LPF is a single-pole filter, and the cutoff frequency can be calculated with [Equation 10](#). The typical value of $R_{NR/SS}$ is 250 kΩ. The effect of the $C_{NR/SS}$ capacitor increases when $V_{OUT(nom)}$ increases because the noise from the reference is gained up when the output voltage increases. For low-noise applications, TI recommends a 10-nF to 10-μF $C_{NR/SS}$.

$$f_{cutoff} = 1 / (2 \times \pi \times R_{NR/SS} \times C_{NR/SS}) \quad (10)$$

The feed-forward capacitor reduces output voltage noise by filtering out the mid-band frequency noise. The feed-forward capacitor can be optimized by placing a pole-zero pair near the edge of the loop bandwidth and pushing out the loop bandwidth, thus improving mid-band PSRR.

A larger C_{OUT} or multiple output capacitors reduces high-frequency output voltage noise and PSRR by reducing the high-frequency output impedance of the power supply.

Additionally, a higher input voltage improves the noise and PSRR because greater headroom is provided for the internal circuits. However, a high power dissipation across the die increases the output noise because of the increase in junction temperature.

Good PCB layout improves the PSRR and noise performance by providing heat sinking at low frequencies and isolating V_{OUT} at high frequencies.

表 8-10 lists the output voltage noise for the 10-Hz to 100-kHz band at a 5-V output for a variety of conditions with an input voltage of 5.5 V and a load current of 3 A. The 5-V output was chosen as a worst-case nominal operation for output voltage noise.

表 8-10. Output Noise Voltage at a 5-V Output (TPS7A8400A)

OUTPUT VOLTAGE NOISE (μV_{RMS})	$C_{\text{NR/SS}}$ (nF)	C_{FF} (nF)	C_{OUT} (μF)
11.7	10	10	47 10 10
7.7	100	10	47 10 10
6	100	100	47 10 10
7.4	100	10	1000
5.8	100	100	1000

8.1.3.3.1 Charge Pump Noise

The device internal charge pump generates a minimal amount of noise, as shown in 图 8-8.

Using a bias rail minimizes the internal charge-pump noise when the internal voltage is clamped, thereby reducing the overall output noise floor.

The high-frequency components of the output voltage noise density curve are filtered out in most applications by using 10-nF to 100-nF bypass capacitors close to the load. Using a ferrite bead between the LDO output and the load input capacitors forms a pi-filter, further reducing the high-frequency noise contribution.



图 8-8. Charge Pump Noise

8.1.3.4 Load Transient Response

The load-step transient response is the output voltage response by the LDO to a step in load current, whereby output voltage regulation is maintained. There are two key transitions during a load transient response: the transition from a light to a heavy load and the transition from a heavy to a light load. The regions shown in [Figure 8-9](#) are broken down in this section and are described in [Table 8-11](#). Regions A, E, and H are where the output voltage is in steady-state.

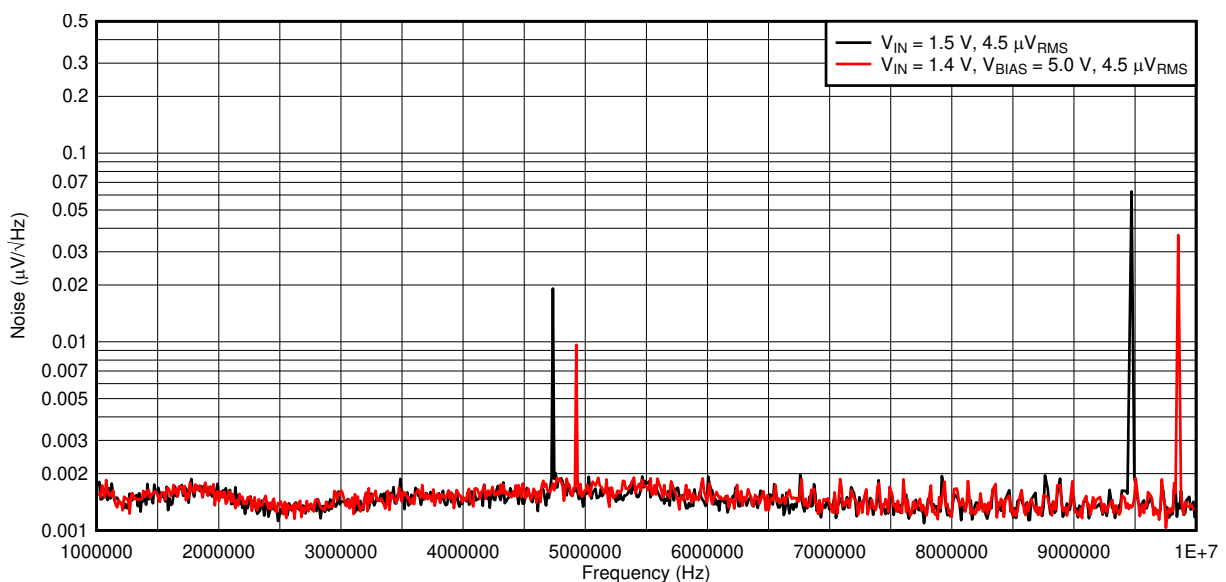
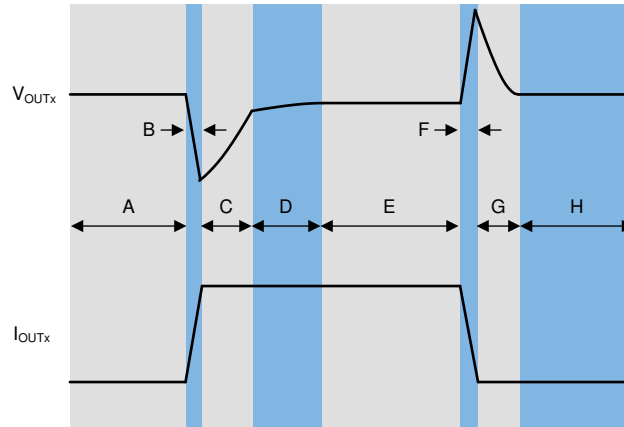
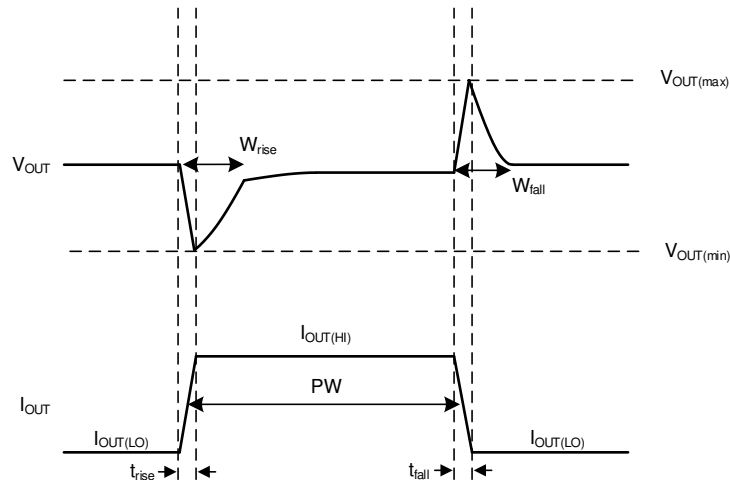

Figure 8-9. Load Transient Waveform

Table 8-11. Load Transient Waveform Description

REGION	DESCRIPTION	COMMENT
A	Regulation	Regulation
B	Output current ramping	Initial voltage dip is a result of the depletion of the output capacitor charge.
C	LDO responding to transient	Recovery from the dip results from the LDO increasing its sourcing current, and leads to output voltage regulation.
D	Reaching thermal equilibrium	At high load currents the LDO takes some time to heat up. During this time the output voltage changes slightly.
E	Regulation	Regulation
F	Output current ramping	Initial voltage rise results from the LDO sourcing a large current, and leads to the output capacitor charge to increase.
G	LDO responding to transient	Recovery from the rise results from the LDO decreasing its sourcing current in combination with the load discharging the output capacitor.
H	Regulation	Regulation

The transient response peaks ($V_{OUT(max)}$ and $V_{OUT(min)}$) are improved by using more output capacitance; however, doing so slows down the recovery time (W_{rise} and W_{fall}). [Figure 8-10](#) illustrates these parameters during a load transient, with a given pulse duration (PW) and current levels ($I_{OUT(LO)}$ and $I_{OUT(HI)}$).



8-10. Simplified Load Transient Waveform

8.1.4 DC Performance

8.1.4.1 Output Voltage Accuracy (V_{OUT})

The device features an output voltage accuracy of 0.75% maximum, with BIAS, that includes the errors introduced by the internal reference, load regulation, line regulation, and operating temperature as specified by the *Electrical Characteristics* tables in the [Specifications](#) section. Output voltage accuracy specifies minimum and maximum output voltage error, relative to the expected nominal output voltage stated as a percent.

8.1.4.2 Dropout Voltage (V_{DO})

Generally speaking, the dropout voltage often refers to the minimum voltage difference between the input and output voltage ($V_{DO} = V_{IN} - V_{OUT}$) that is required for regulation. When V_{IN} drops below the required V_{DO} for the given load current, the device functions as a resistive switch and does not regulate output voltage. Dropout voltage is proportional to the output current because the device is operating as a resistive switch, as shown in [8-11](#).

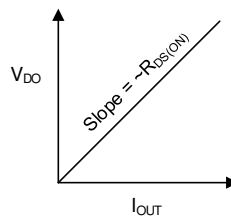

8-11. Dropout Voltage versus Output Current

Dropout voltage is affected by the drive strength for the gate of the pass element, which is nonlinear with respect to V_{IN} on this device because of the internal charge pump. Dropout voltage increases exponentially when the input voltage nears its maximum operating voltage because the charge pump multiplies the input voltage by a factor of 4 and then is internally clamped to 8 V.

8.1.4.2.1 Behavior When Transitioning From Dropout Into Regulation

Some applications can have transients that place the LDO into dropout, such as slower ramps on V_{IN} for start-up or load transients. As with many other LDOs, the output can overshoot on recovery from these conditions.

A ramping input supply can cause an LDO to overshoot on start-up when the slew rate and voltage levels are in the right range, as shown in [Figure 8-12](#). This condition is easily avoided through either the use of an enable signal, or by increasing the soft-start time with C_{SS}/NR .

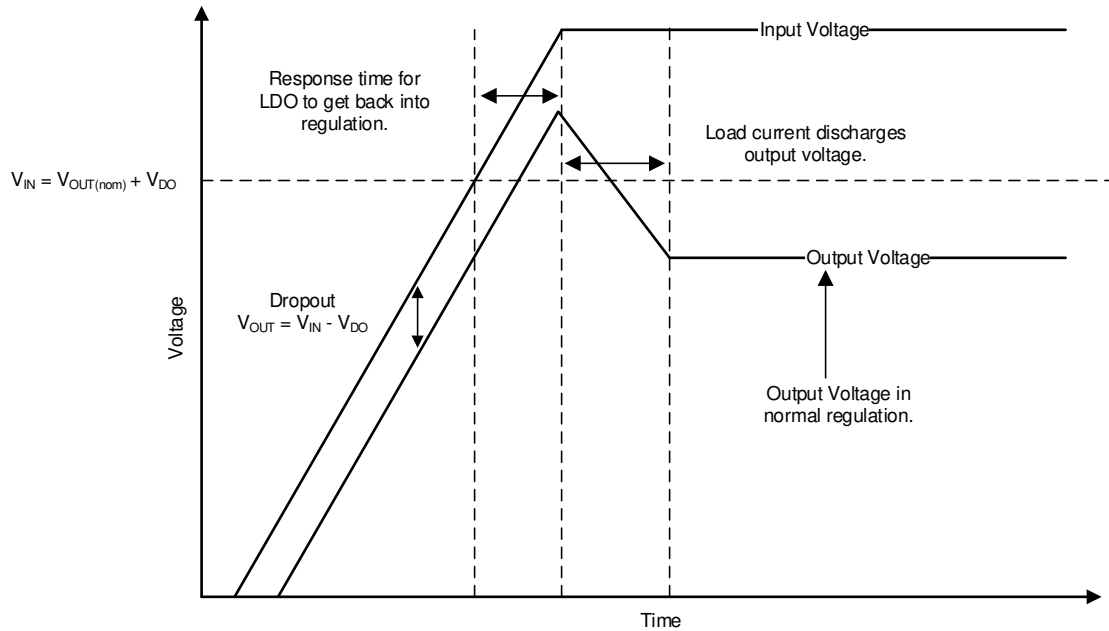

Figure 8-12. Start-Up Into Dropout

8.1.5 Sequencing Requirements

There is no sequencing requirement between the BIAS, IN, and EN pins in the TPS7A84A.

8.1.6 Negatively Biased Output

The TPS7A84A output can be negatively biased to the absolute maximum rating, without affecting start-up condition.

8.1.7 Reverse Current Protection

As with most LDOs, this device can be damaged by excessive reverse current.

Reverse current is current that flows through the body diode on the pass element instead of the normal conducting channel. This current flow, at high enough magnitudes, degrades long-term reliability of the device resulting from risks of electromigration and excess heat being dissipated across the device. If the current flow gets high enough, a latch-up condition can be entered.

Conditions where excessive reverse current can occur are outlined in this section, all of which can exceed the absolute maximum rating of $V_{OUT} > V_{IN} + 0.3\text{ V}$:

- If the device has a large C_{OUT} and the input supply collapses quickly with little or no load current,
- The output is biased when the input supply is not established, or
- The output is biased above the input supply.

If excessive reverse current flow is expected in the application, then external protection must be used to protect the device. [Figure 8-13](#) illustrates one approach of protecting the device.



图 8-13. Example Circuit for Reverse Current Protection Using a Schottky Diode

8.1.8 Power Dissipation (P_D)

Circuit reliability demands that proper consideration is given to device power dissipation, location of the circuit on the printed circuit board (PCB), and correct sizing of the thermal plane. The PCB area around the regulator must be as free as possible of other heat-generating devices that cause added thermal stresses.

As a first-order approximation, power dissipation in the regulator depends on the input-to-output voltage difference and load conditions. P_D can be approximated using 式 11:

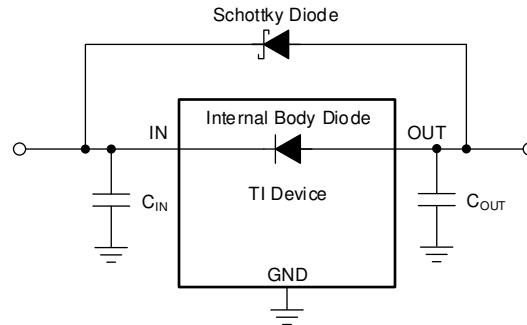
$$P_D = (V_{IN} - V_{OUT}) \times I_{OUT} \quad (11)$$

An important note is that power dissipation can be minimized, and thus greater efficiency achieved, by proper selection of the system voltage rails. Proper selection allows the minimum input-to-output voltage differential to be obtained. The low dropout of the device allows for maximum efficiency across a wide range of output voltages.

The main heat conduction path for the device is through the thermal pad on the package. As such, the thermal pad must be soldered to a copper pad area under the device. This pad area contains an array of plated vias that conduct heat to any inner plane areas or to a bottom-side copper plane.

The maximum power dissipation determines the maximum allowable junction temperature (T_J) for the device. Power dissipation and junction temperature are most often related by the junction-to-ambient thermal resistance ($R_{\theta JA}$) of the combined PCB, device package, and the temperature of the ambient air (T_A), according to 式 12. The equation is rearranged for output current in 式 13.

$$T_J = T_A + R_{\theta JA} \times P_D \quad (12)$$

$$I_{OUT} = (T_J - T_A) / [R_{\theta JA} \times (V_{IN} - V_{OUT})] \quad (13)$$

Unfortunately, this thermal resistance (θ_{JA}) is highly dependent on the heat-spreading capability built into the particular PCB design, and therefore varies according to the total copper area, copper weight, and location of the planes. The $R_{\theta JA}$ recorded in the *Thermal Information* table in the [Specifications](#) section is determined by the JEDEC standard, PCB, and copper-spreading area, and is only used as a relative measure of package thermal performance. For a well-designed thermal layout, $R_{\theta JA}$ is actually the sum of the VQFN package junction-to-case (bottom) thermal resistance ($R_{\theta JCbot}$) plus the thermal resistance contribution by the PCB copper.

8.1.8.1 Estimating Junction Temperature

The JEDEC standard now recommends the use of psi (Ψ) thermal metrics to estimate the junction temperatures of the LDO when in-circuit on a typical PCB board application. These metrics are not strictly speaking thermal resistances, but rather offer practical and relative means of estimating junction temperatures. These psi metrics are determined to be significantly independent of the copper-spreading area. The key thermal metrics (Ψ_{JT} and Ψ_{JB}) are given in the *Thermal Information* table in the [Specifications](#) section and are used in accordance with [式 14](#).

$$\begin{aligned} \Psi_{JT}: T_J &= T_T + \Psi_{JT} \times P_D \\ \Psi_{JB}: T_J &= T_B + \Psi_{JB} \times P_D \end{aligned} \tag{14}$$

where:

- P_D is the power dissipated as explained in [式 11](#)
- T_T is the temperature at the center-top of the device package, and
- T_B is the PCB surface temperature measured 1 mm from the device package and centered on the package edge

8.1.8.2 Recommended Area for Continuous Operation (RACO)

The operational area of an LDO is limited by the dropout voltage, output current, junction temperature, and input voltage. The recommended area for continuous operation for a linear regulator can be separated into the following parts, shown in [图 8-14](#):

- Limited by dropout: Dropout voltage limits the minimum differential voltage between the input and the output ($V_{IN} - V_{OUT}$) at a given output current level; see the [Dropout Voltage \(\$V_{DO}\$ \)](#) section for more details.
- Limited by rated output current: The rated output current limits the maximum recommended output current level. Exceeding this rating causes the device to fall out of specification.
- Limited by thermals: The shape of the slope is given by [式 13](#). The slope is nonlinear because the junction temperature of the LDO is controlled by the power dissipation across the LDO; therefore, when $V_{IN} - V_{OUT}$ increases, the output current must decrease in order to ensure that the rated junction temperature of the device is not exceeded. Exceeding this rating can cause the device to fall out of specifications and reduces long-term reliability.
- Limited by V_{IN} range: The rated input voltage range governs both the minimum and maximum of $V_{IN} - V_{OUT}$.



图 8-14. Continuous Operation Slope Region Description

☒ 8-15 to ☒ 8-20 show the recommended area of operation curves for this device on a JEDEC-standard, high-K board with a $R_{\theta JA} = 43.4^{\circ}\text{C}/\text{W}$, as given in the *Thermal Information* table in the *Specifications* section.



☒ 8-15. Recommended Area for Continuous Operation for $V_{OUT} = 0.9\text{ V}$

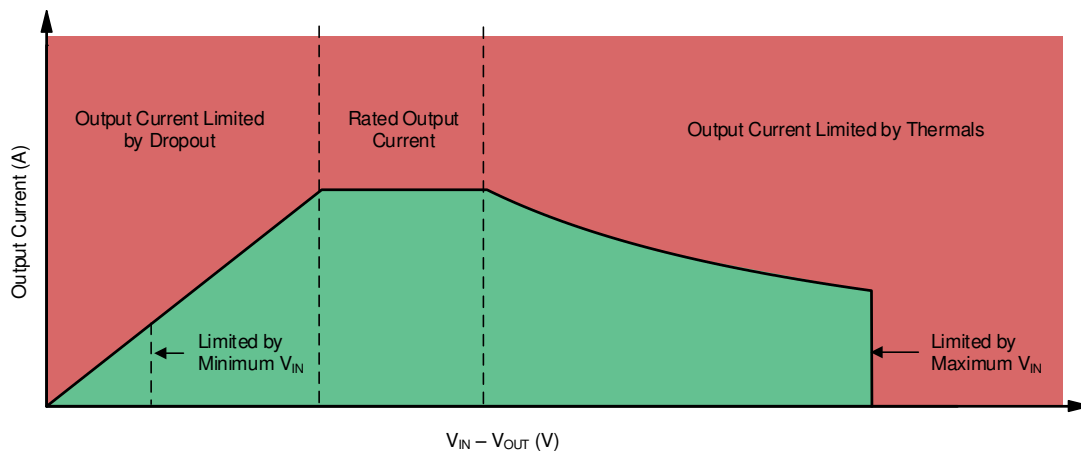
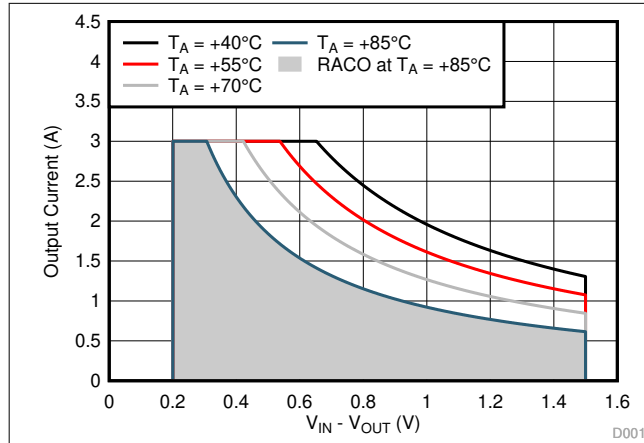
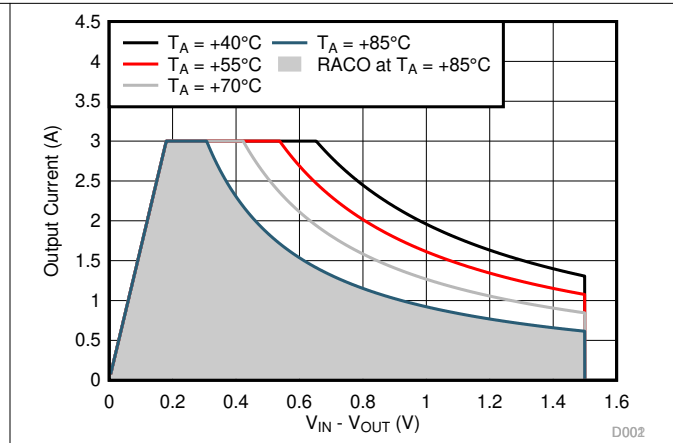

☒ 8-16. Recommended Area for Continuous Operation for $V_{OUT} = 1.2\text{ V}$

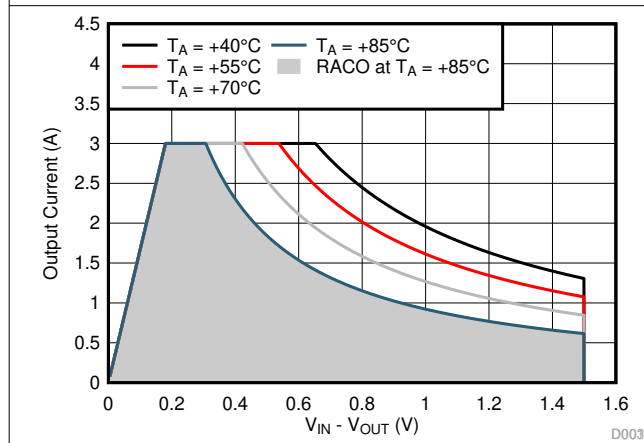

☒ 8-17. Recommended Area for Continuous Operation for $V_{OUT} = 1.8\text{ V}$

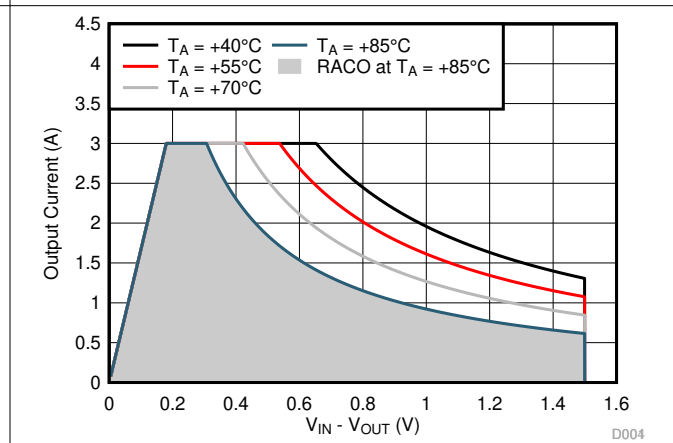

☒ 8-18. Recommended Area for Continuous Operation for $V_{OUT} = 2.5\text{ V}$

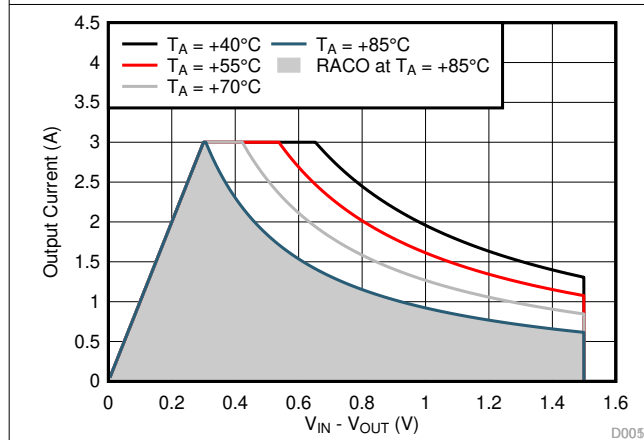

☒ 8-19. Recommended Area for Continuous Operation for $V_{OUT} = 3.3\text{ V}$

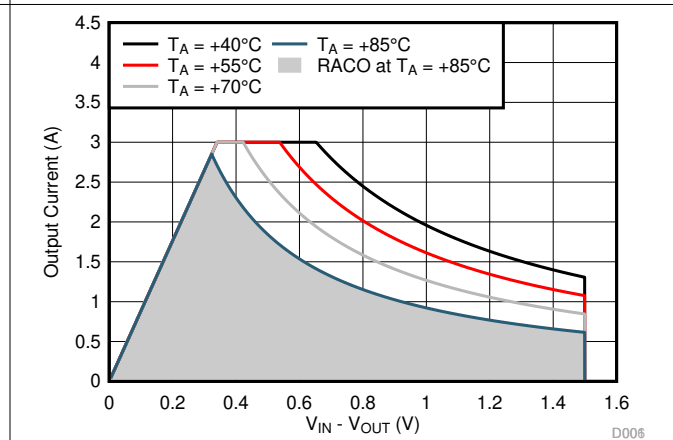

☒ 8-20. Recommended Area for Continuous Operation for $V_{OUT} = 5\text{ V}$

8.2 Typical Applications

8.2.1 Low-Input, Low-Output (LILO) Voltage Conditions

The TPS7A8400A device uses the ANY-OUT configuration to regulate a 3-A load requiring good PSRR at high frequency with low-noise at 0.9 V using a 1.2-V input voltage and a 5-V bias supply. The schematic for this typical application circuit is provided in [Figure 8-21](#).

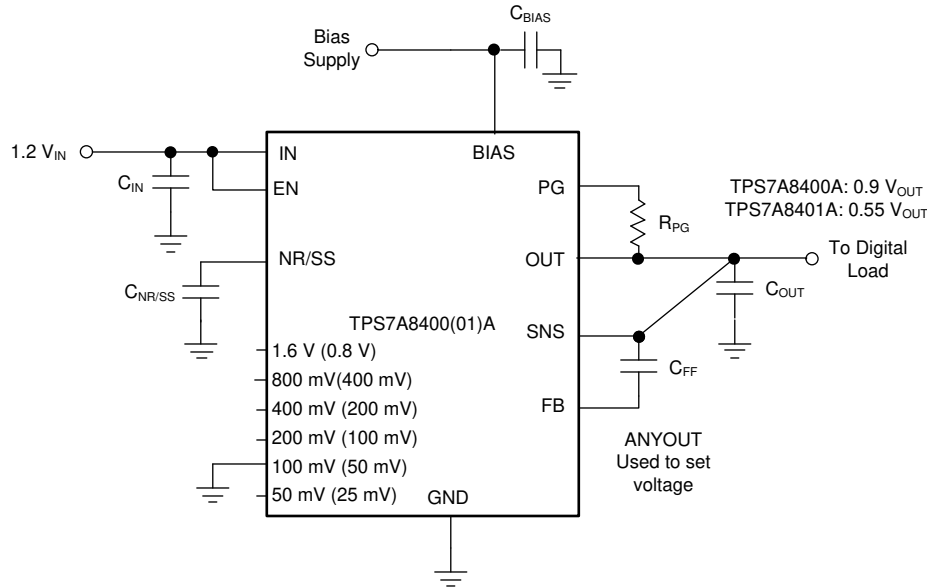

Figure 8-21. TPS7A84A Typical Application

8.2.1.1 Design Requirements

For this design example, use the parameters listed in [Table 8-12](#) as the input parameters.

Table 8-12. TPS7A8400A Design Parameters

PARAMETER	DESIGN REQUIREMENT
Input voltage	1.2 V, $\pm 3\%$, provided by the dc-dc converter switching at 500 kHz
Bias voltage	5 V, $\pm 5\%$
Output voltage	0.9 V, $\pm 1\%$
Output current	3 A (maximum), 100 mA (minimum)
RMS noise, 10 Hz to 100 kHz	$< 10 \mu\text{V}_{\text{RMS}}$
PSRR at 500 kHz	$> 40 \text{ dB}$
Start-up time	$< 25 \text{ ms}$

8.2.1.2 Detailed Design Procedure

At 3 A, the dropout of the TPS7A8400A has 180-mV maximum dropout over temperature, thus a 400-mV headroom is sufficient for operation over both input and output voltage accuracy. The bias rail is provided for better performance for the LILO conditions. The PSRR is greater than 40 dB in these conditions, and noise is less than $10 \mu\text{V}_{\text{RMS}}$, as per [Table 8-12](#).

The ANY-OUT internal resistor network is also used for maximum accuracy.

To achieve 0.9 V on the output, the 100-mV pin is grounded. The voltage value of 100 mV is added to the 0.8-V internal reference voltage for $V_{\text{OUT(nom)}}$ equal to 0.9 V, as described in [Equation 15](#).

$$V_{\text{OUT(nom)}} = V_{\text{NR/SS}} + 0.1 \text{ V} = 0.8 \text{ V} + 0.1 \text{ V} = 0.9 \text{ V} \quad (15)$$

Input and output capacitors are selected in accordance with the [External Component Selection](#) section. Ceramic capacitances of 47 μF for the input and one 47- μF capacitor in parallel with two 10- μF capacitors for the output are selected.

To satisfy the required start-up time and still maintain low-noise performance, a 100-nF $C_{\text{NR/SS}}$ is selected. This value is calculated with [式 16](#).

$$t_{\text{SS}} = (V_{\text{NR/SS}} \times C_{\text{NR/SS}}) / I_{\text{NR/SS}} \quad (16)$$

At the 3-A maximum load, the internal power dissipation is 0.9 W and corresponds to a 39.06°C junction temperature rise for the RGR package on a standard JEDEC board. With an 55°C maximum ambient temperature, the junction temperature is at 94.06°C. To further minimize noise, a feed-forward capacitance (C_{FF}) of 10 nF is selected.

8.2.1.3 Application Curves

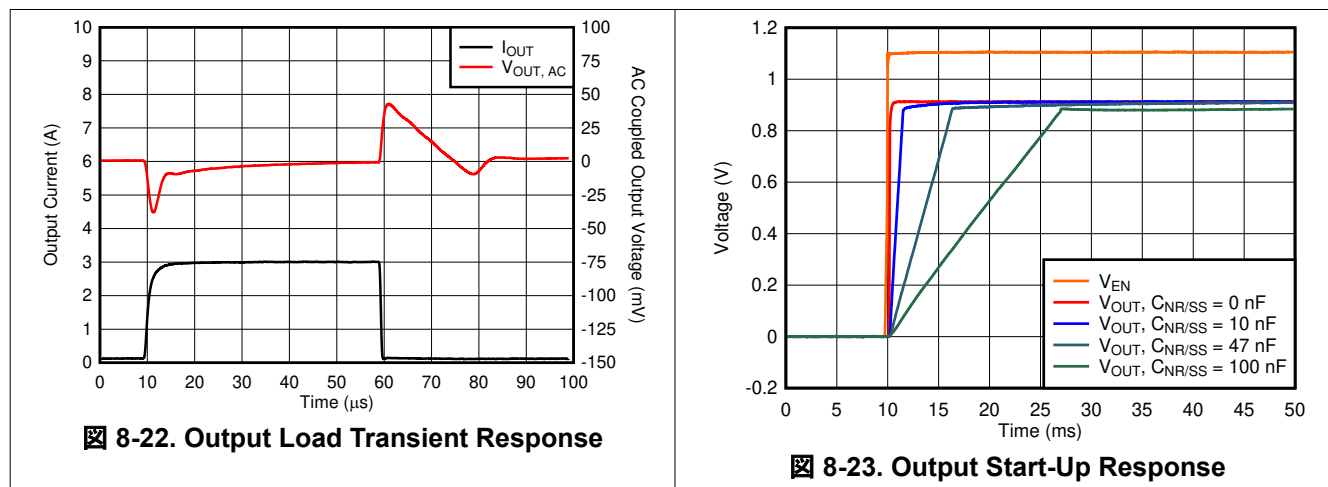

9 Power Supply Recommendations

The TPS7A84A device is designed to operate from an input voltage supply range from 1.1 V to 6.5 V. If the input supply is less than 1.4 V, then a bias rail of at least 3 V must be used. The input voltage range provides adequate headroom in order for the device to have a regulated output. This input supply must be well regulated. If the input supply is noisy, additional input capacitors with low ESR may help improve output noise performance.

10 Layout

10.1 Layout Guidelines

For best overall performance, place all circuit components on the same side of the circuit board and as near as practical to the respective LDO pin connections. Place ground return connections to the input and output capacitor, and to the LDO ground pin as close as possible to each other, connected by a wide, component-side, copper surface. The use of vias and long traces to the input and output capacitors is strongly discouraged and negatively affects system performance. The grounding and layout scheme shown in [10-1](#) minimizes inductive parasitics, and thereby reduces load-current transients, minimizes noise, and increases circuit stability.

TI also recommends a ground reference plane either embedded in the PCB itself or located on the bottom side of the PCB opposite the components. This reference plane serves to assure accuracy of the output voltage, shield noise, and behaves similarly to a thermal plane to spread (or sink) heat from the LDO device when connected to the thermal pad. In most applications, this ground plane is necessary to meet thermal requirements.

10.2 Layout Example

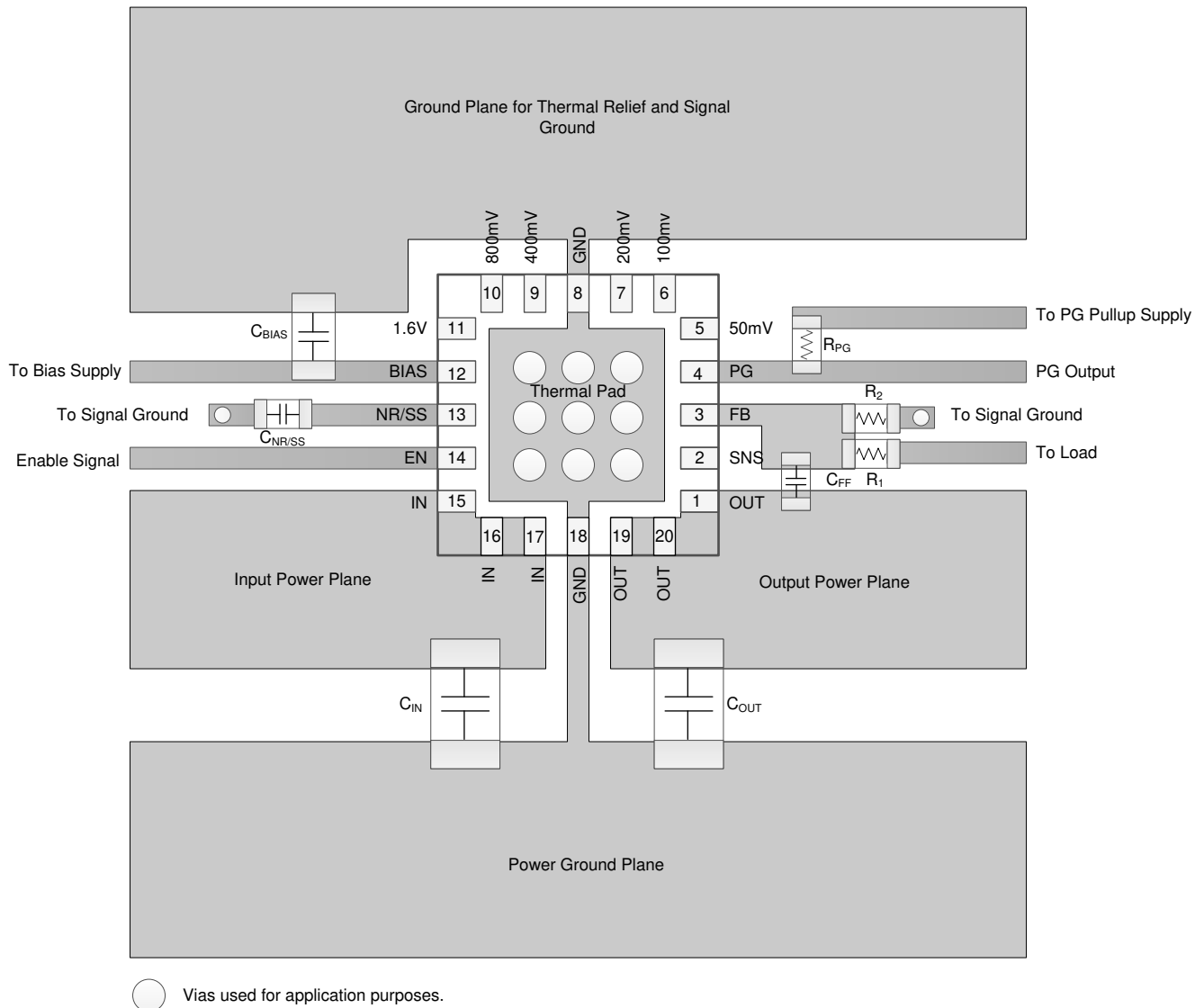

10-1. Example Layout

11 Device and Documentation Support

11.1 Device Support

11.1.1 Development Support

11.1.1.1 Evaluation Models

An evaluation module (EVM) is available to assist in the initial circuit performance evaluation using the TPS7A8400A. The summary information for this fixture is shown in [表 11-1](#).

表 11-1. Design Kits and Evaluation Models

NAME	EVALUATION MODEL
TPS7A8400EVM-753 Evaluation Module	SBVU028

The EVM may be requested at the Texas Instruments [web site](#) through the TPS7A84A product folder.

11.1.1.2 Spice Models

Computer simulation of circuit performance using SPICE is often useful when analyzing the performance of analog circuits and systems. A SPICE model for the TPS7A84A device is available through the TPS7A84A product folder under simulation models.

11.2 Documentation Support

11.2.1 Related Documentation

For related documentation see the following:

- Texas Instruments, [High-Accuracy, Overvoltage and Undervoltage Monitor data sheet](#)
- Texas Instruments, [TPS7A8400EVM-753 Evaluation Module user guide](#)
- Texas Instruments, [Pros and Cons of Using a Feed-Forward Capacitor with a Low Dropout Regulator application report](#)
- Texas Instruments, [6A Current-Sharing Dual LDO reference guide](#)
- Texas Instruments, [High-Current Low-Noise Parallel LDO reference design](#)

11.3 ドキュメントの更新通知を受け取る方法

ドキュメントの更新についての通知を受け取るには、[ti.com](#) のデバイス製品フォルダを開いてください。「更新の通知を受け取る」をクリックして登録すると、変更されたすべての製品情報に関するダイジェストを毎週受け取れます。変更の詳細については、修正されたドキュメントに含まれている改訂履歴をご覧ください。

11.4 サポート・リソース

[TI E2E™ サポート・フォーラム](#)は、エンジニアが検証済みの回答と設計に関するヒントをエキスパートから迅速かつ直接得ることができる場所です。既存の回答を検索したり、独自の質問をしたりすることで、設計に必要な支援を迅速に得ることができます。

リンクされているコンテンツは、該当する貢献者により、現状のまま提供されるものです。これらは TI の仕様を構成するものではなく、必ずしも TI の見解を反映したものではありません。TI の[使用条件](#)を参照してください。

11.5 Trademarks

ANY-OUT™ are trademarks of Texas Instruments.

TI E2E™ is a trademark of Texas Instruments.

すべての商標は、それぞれの所有者に帰属します。

11.6 静電気放電に関する注意事項



この IC は、ESD によって破損する可能性があります。テキサス・インスツルメンツは、IC を取り扱う際には常に適切な注意を払うことを推奨します。正しい ESD 対策をとらないと、デバイスを破損するおそれがあります。

ESD による破損は、わずかな性能低下からデバイスの完全な故障まで多岐にわたります。精密な IC の場合、パラメータがわずかに変化するだけで公表されている仕様から外れる可能性があるため、破損が発生しやすくなっています。

11.7 用語集

[TI 用語集](#) この用語集には、用語や略語の一覧および定義が記載されています。

Mechanical, Packaging, and Orderable Information

The following pages include mechanical, packaging, and orderable information. This information is the most current data available for the designated devices. This data is subject to change without notice and revision of this document. For browser-based versions of this data sheet, refer to the left-hand navigation.

PACKAGING INFORMATION

Orderable part number	Status (1)	Material type (2)	Package Pins	Package qty Carrier	RoHS (3)	Lead finish/ Ball material (4)	MSL rating/ Peak reflow (5)	Op temp (°C)	Part marking (6)
TPS7A8400ARGRR	Active	Production	VQFN (RGR) 20	3000 LARGE T&R	Yes	NIPDAU	Level-1-260C-UNLIM	-40 to 125	8400A
TPS7A8400ARGRR.A	Active	Production	VQFN (RGR) 20	3000 LARGE T&R	Yes	NIPDAU	Level-1-260C-UNLIM	-40 to 125	8400A
TPS7A8400ARGRT	Active	Production	VQFN (RGR) 20	250 SMALL T&R	Yes	NIPDAU	Level-1-260C-UNLIM	-40 to 125	8400A
TPS7A8400ARGRT.A	Active	Production	VQFN (RGR) 20	250 SMALL T&R	Yes	NIPDAU	Level-1-260C-UNLIM	-40 to 125	8400A
TPS7A8400ARGRTG4	Active	Production	VQFN (RGR) 20	250 SMALL T&R	Yes	NIPDAU	Level-1-260C-UNLIM	-40 to 125	8400A
TPS7A8400ARGRTG4.A	Active	Production	VQFN (RGR) 20	250 SMALL T&R	Yes	NIPDAU	Level-1-260C-UNLIM	-40 to 125	8400A
TPS7A8401ARGRR	Active	Production	VQFN (RGR) 20	3000 LARGE T&R	Yes	NIPDAU	Level-1-260C-UNLIM	-40 to 125	8401A
TPS7A8401ARGRR.A	Active	Production	VQFN (RGR) 20	3000 LARGE T&R	Yes	NIPDAU	Level-1-260C-UNLIM	-40 to 125	8401A

(1) **Status:** For more details on status, see our [product life cycle](#).

(2) **Material type:** When designated, preproduction parts are prototypes/experimental devices, and are not yet approved or released for full production. Testing and final process, including without limitation quality assurance, reliability performance testing, and/or process qualification, may not yet be complete, and this item is subject to further changes or possible discontinuation. If available for ordering, purchases will be subject to an additional waiver at checkout, and are intended for early internal evaluation purposes only. These items are sold without warranties of any kind.

(3) **RoHS values:** Yes, No, RoHS Exempt. See the [TI RoHS Statement](#) for additional information and value definition.

(4) **Lead finish/Ball material:** Parts may have multiple material finish options. Finish options are separated by a vertical ruled line. Lead finish/Ball material values may wrap to two lines if the finish value exceeds the maximum column width.

(5) **MSL rating/Peak reflow:** The moisture sensitivity level ratings and peak solder (reflow) temperatures. In the event that a part has multiple moisture sensitivity ratings, only the lowest level per JEDEC standards is shown. Refer to the shipping label for the actual reflow temperature that will be used to mount the part to the printed circuit board.

(6) **Part marking:** There may be an additional marking, which relates to the logo, the lot trace code information, or the environmental category of the part.

Multiple part markings will be inside parentheses. Only one part marking contained in parentheses and separated by a "-" will appear on a part. If a line is indented then it is a continuation of the previous line and the two combined represent the entire part marking for that device.

Important Information and Disclaimer: The information provided on this page represents TI's knowledge and belief as of the date that it is provided. TI bases its knowledge and belief on information provided by third parties, and makes no representation or warranty as to the accuracy of such information. Efforts are underway to better integrate information from third parties. TI has taken and continues to take reasonable steps to provide representative and accurate information but may not have conducted destructive testing or chemical analysis on incoming materials and chemicals. TI and TI suppliers consider certain information to be proprietary, and thus CAS numbers and other limited information may not be available for release.

In no event shall TI's liability arising out of such information exceed the total purchase price of the TI part(s) at issue in this document sold by TI to Customer on an annual basis.

TAPE AND REEL INFORMATION

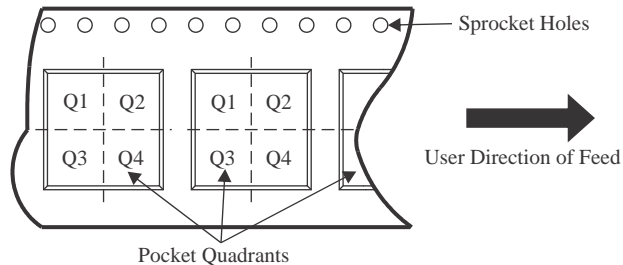
QUADRANT ASSIGNMENTS FOR PIN 1 ORIENTATION IN TAPE

*All dimensions are nominal

Device	Package Type	Package Drawing	Pins	SPQ	Reel Diameter (mm)	Reel Width W1 (mm)	A0 (mm)	B0 (mm)	K0 (mm)	P1 (mm)	W (mm)	Pin1 Quadrant
TPS7A8400ARGRR	VQFN	RGR	20	3000	330.0	12.4	3.75	3.75	1.15	8.0	12.0	Q2
TPS7A8400ARGRT	VQFN	RGR	20	250	180.0	12.4	3.75	3.75	1.15	8.0	12.0	Q2
TPS7A8400ARGRTG4	VQFN	RGR	20	250	180.0	12.4	3.75	3.75	1.15	8.0	12.0	Q2
TPS7A8401ARGRR	VQFN	RGR	20	3000	330.0	12.4	3.75	3.75	1.15	8.0	12.0	Q2

TAPE AND REEL BOX DIMENSIONS

*All dimensions are nominal

Device	Package Type	Package Drawing	Pins	SPQ	Length (mm)	Width (mm)	Height (mm)
TPS7A8400ARGRR	VQFN	RGR	20	3000	356.0	356.0	36.0
TPS7A8400ARGRT	VQFN	RGR	20	250	210.0	185.0	35.0
TPS7A8400ARGRTG4	VQFN	RGR	20	250	210.0	185.0	35.0
TPS7A8401ARGRR	VQFN	RGR	20	3000	367.0	367.0	35.0

GENERIC PACKAGE VIEW

RGR 20

VQFN - 1 mm max height

3.5 x 3.5, 0.5 mm pitch

PLASTIC QUAD FLATPACK - NO LEAD

This image is a representation of the package family, actual package may vary.
Refer to the product data sheet for package details.

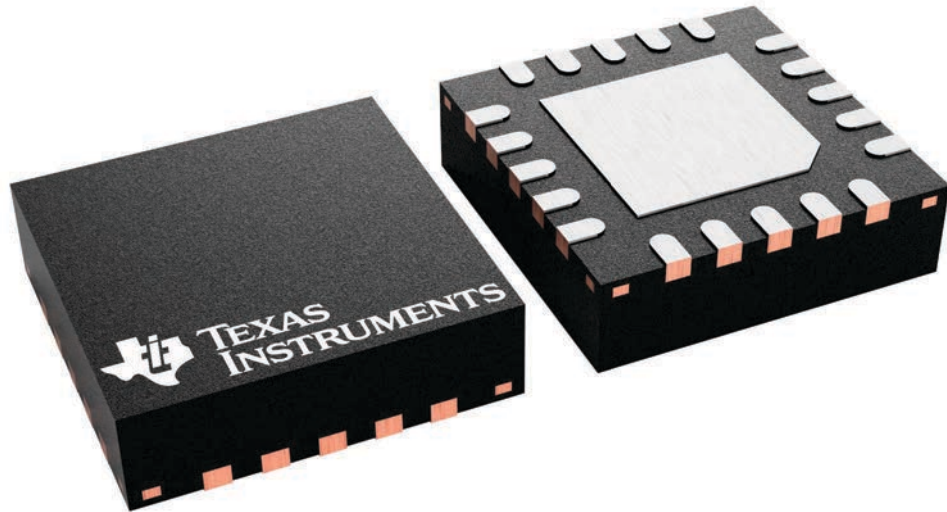

4228482/A

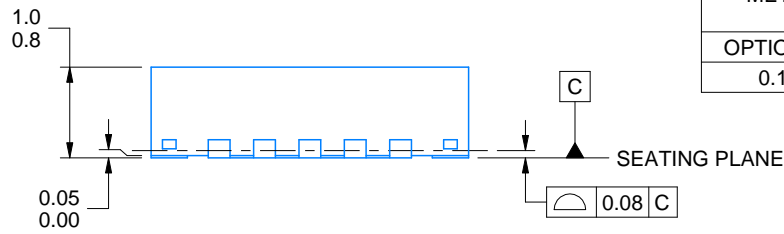
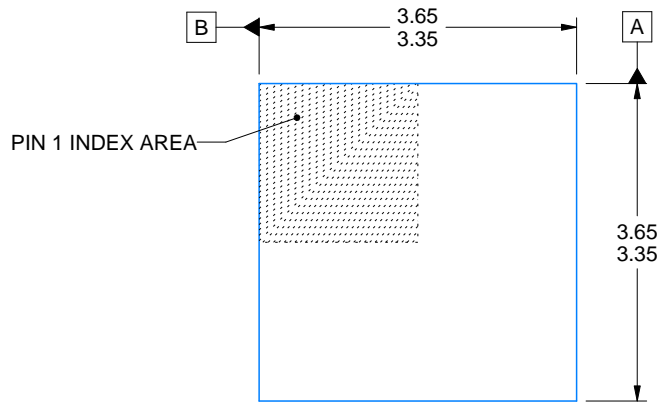

SIDE WALL METAL THICKNESS DIM A	
OPTION 1	OPTION 2
0.1	0.2

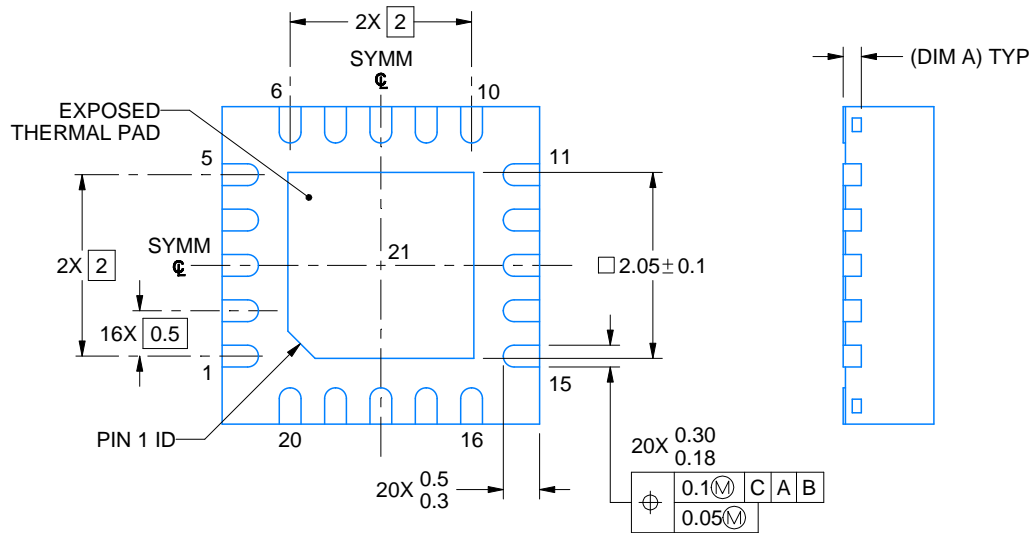

4219031/B 04/2022

NOTES:

1. All linear dimensions are in millimeters. Any dimensions in parenthesis are for reference only. Dimensioning and tolerancing per ASME Y14.5M.
2. This drawing is subject to change without notice.
3. The package thermal pad must be soldered to the printed circuit board for thermal and mechanical performance.

EXAMPLE BOARD LAYOUT

RGR0020A

VQFN - 1 mm max height

PLASTIC QUAD FLATPACK - NO LEAD

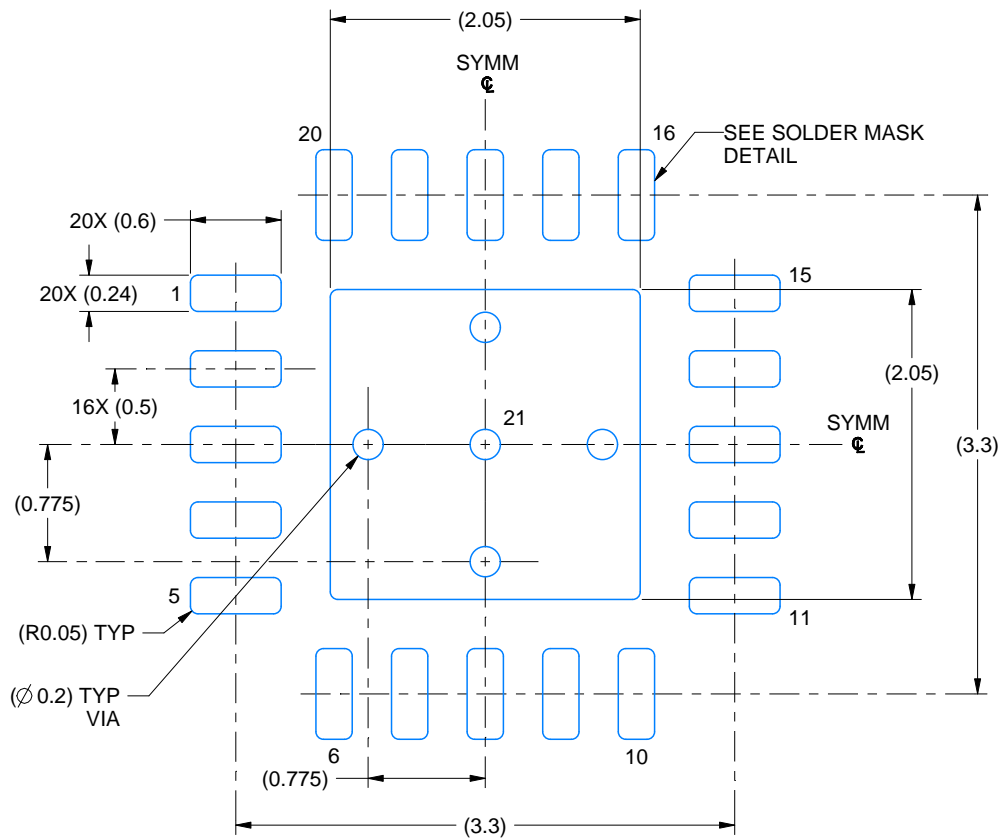

LAND PATTERN EXAMPLE
EXPOSED METAL SHOWN
SCALE: 20X

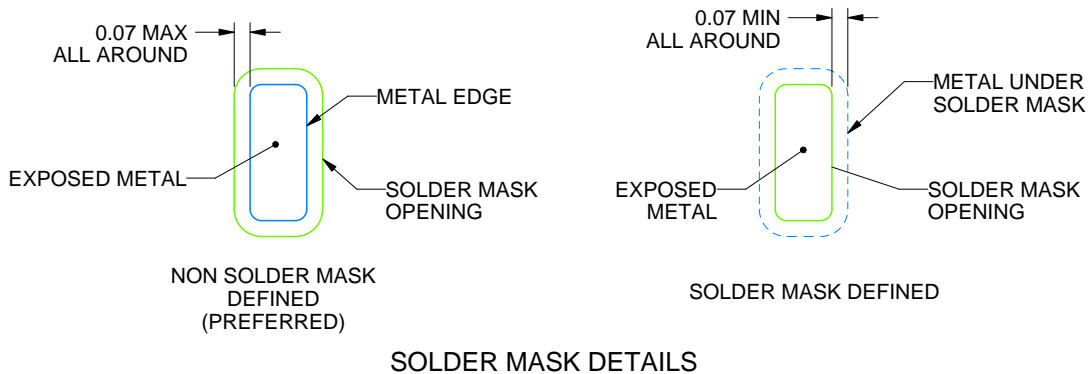

SOLDER MASK DETAILS

4219031/B 04/2022

NOTES: (continued)

4. This package is designed to be soldered to a thermal pad on the board. For more information, see Texas Instruments literature number SLUA271 (www.ti.com/lit/sluea271).
5. Vias are optional depending on application, refer to device data sheet. If any vias are implemented, refer to their locations shown on this view. It is recommended that vias under paste be filled, plugged or tented.

EXAMPLE STENCIL DESIGN

RGR0020A

VQFN - 1 mm max height

PLASTIC QUAD FLATPACK - NO LEAD

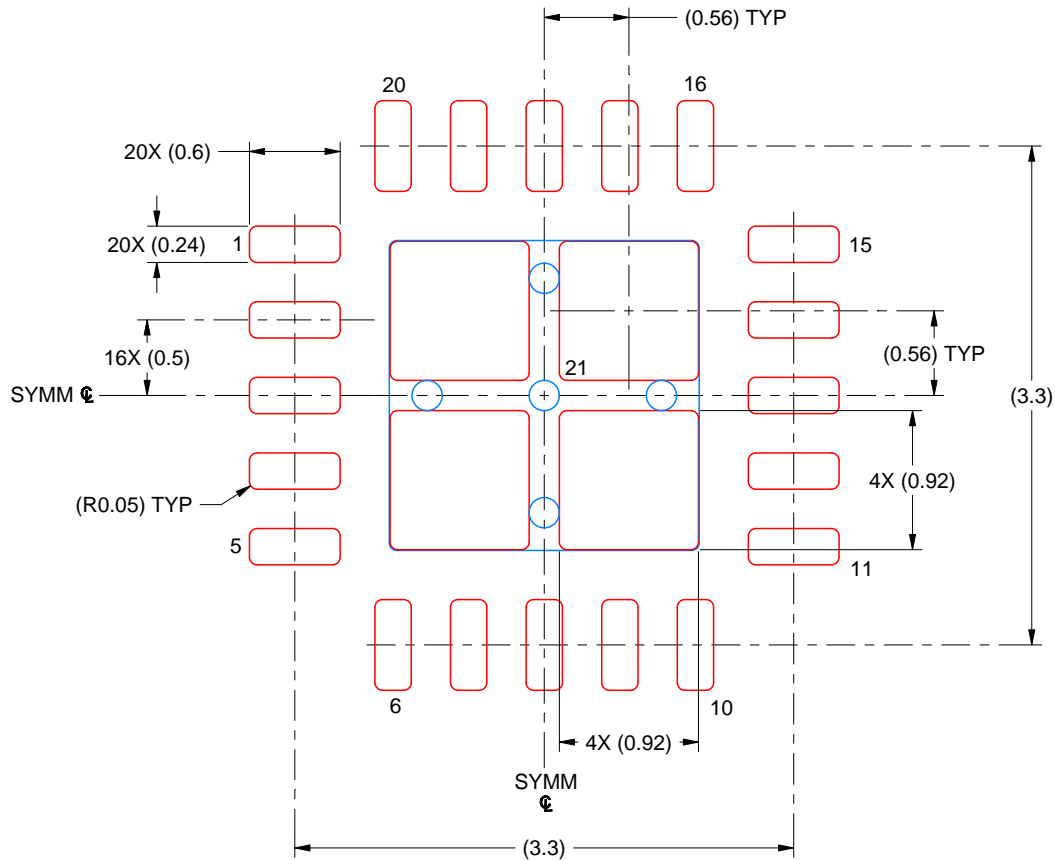

SOLDER PASTE EXAMPLE
BASED ON 0.125 MM THICK STENCIL
SCALE: 20X

EXPOSED PAD 21
81% PRINTED SOLDER COVERAGE BY AREA UNDER PACKAGE

4219031/B 04/2022

NOTES: (continued)

6. Laser cutting apertures with trapezoidal walls and rounded corners may offer better paste release. IPC-7525 may have alternate design recommendations.

重要なお知らせと免責事項

TI は、技術データと信頼性データ (データシートを含みます)、設計リソース (リファレンス デザインを含みます)、アプリケーションや設計に関する各種アドバイス、Web ツール、安全性情報、その他のリソースを、欠陥が存在する可能性のある「現状のまま」提供しており、商品性および特定目的に対する適合性の黙示保証、第三者の知的財産権の非侵害保証を含むいかなる保証も、明示的または黙示的にかかわらず拒否します。

これらのリソースは、TI 製品を使用する設計の経験を積んだ開発者への提供を意図したものです。(1) お客様のアプリケーションに適した TI 製品の選定、(2) お客様のアプリケーションの設計、検証、試験、(3) お客様のアプリケーションに該当する各種規格や、その他のあらゆる安全性、セキュリティ、規制、または他の要件への確実な適合に関する責任を、お客様のみが単独で負うものとし、

上記の各種リソースは、予告なく変更される可能性があります。これらのリソースは、リソースで説明されている TI 製品を使用するアプリケーションの開発の目的でのみ、TI はその使用をお客様に許諾します。これらのリソースに関して、他の目的で複製することや掲載することは禁止されています。TI や第三者の知的財産権のライセンスが付与されている訳ではありません。お客様は、これらのリソースを自身で使用した結果発生するあらゆる申し立て、損害、費用、損失、責任について、TI およびその代理人を完全に補償するものとし、TI は一切の責任を拒否します。

TI の製品は、[TI の販売条件](#)、[TI の総合的な品質ガイドライン](#)、[ti.com](#) または TI 製品などに関連して提供される他の適用条件に従い提供されます。TI がこれらのリソースを提供することは、適用される TI の保証または他の保証の放棄の拡大や変更を意味するものではありません。TI がカスタム、またはカスタマー仕様として明示的に指定していない限り、TI の製品は標準的なカタログに掲載される汎用機器です。

お客様がいかなる追加条項または代替条項を提案する場合も、TI はそれらに異議を唱え、拒否します。

Copyright © 2026, Texas Instruments Incorporated

最終更新日 : 2025 年 10 月