



Single-Supply, 10MHz, Rail-to-Rail Output, Low-Noise, JFET Amplifier

Check for Samples: [OPA141](#), [OPA2141](#), [OPA4141](#)

FEATURES

- **Low Supply Current:** 2.3mA max
- **Low Offset Drift:** 10 μ V/ $^{\circ}$ C max
- **Low Input Bias Current:** 20pA max
- **Very Low 1/f Noise:** 250nV_{PP}
- **Low Noise:** 6.5nV/ $\sqrt{\text{Hz}}$
- **Wide Bandwidth:** 10MHz
- **Slew Rate:** 20V/ μ s
- **Input Voltage Range Includes V₋**
- **Rail-to-Rail Output**
- **Single-Supply Operation:** 4.5V to 36V
- **Dual-Supply Operation:** \pm 2.25V to \pm 18V
- **No Phase Reversal**
- **MSOP-8, TSSOP Packages**

APPLICATIONS

- **Battery-Powered Instruments**
- **Industrial Controls**
- **Medical Instrumentation**
- **Photodiode Amplifiers**
- **Active Filters**
- **Data Acquisition Systems**
- **Portable Audio**
- **Automatic Test Systems**

0.1Hz to 10Hz NOISE

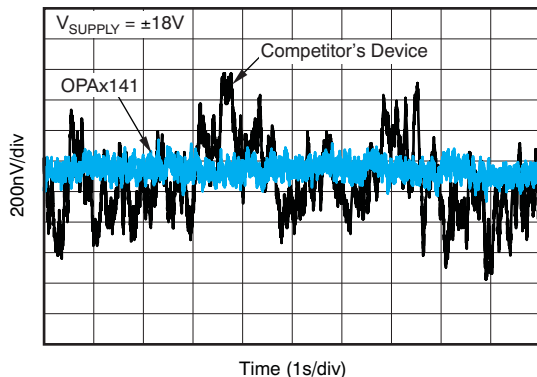

DESCRIPTION

The OPA141, OPA2141, and OPA4141 amplifier family is a series of low-power JFET input amplifiers that feature good drift and low input bias current. The rail-to-rail output swing and input range that includes V₋ allow designers to take advantage of the low-noise characteristics of JFET amplifiers while also interfacing to modern, single-supply, precision analog-to-digital converters (ADCs) and digital-to-analog converters (DACs).

The OPA141 achieves 10MHz unity-gain bandwidth and 20V/ μ s slew rate while consuming only 1.8mA (typ) of quiescent current. It runs on a single 4.5 to 36V supply or dual \pm 2.25V to \pm 18V supplies.

All versions are fully specified from -40°C to $+125^{\circ}\text{C}$ for use in the most challenging environments. The OPA141 (single) and OPA2141 (dual) versions are available in both MSOP-8 and SO-8 packages; the OPA4141 (quad) is available in the SO-14 and TSSOP-14 packages.

RELATED PRODUCTS

FEATURES	PRODUCT
Precision, Low-Power, 10MHz FET Input Industrial Op Amp	OPA140 ⁽¹⁾
2.2nV/ $\sqrt{\text{Hz}}$, Low-Power, 36V Operational Amplifier in SOT-23 Package	OPA209 ⁽¹⁾
Low-Noise, High-Precision, JFET-Input Operational Amplifier	OPA827
Low-Noise, Low I _Q Precision Operational Amplifier	OPA376
High-Speed, FET-Input Operational Amplifier	OPA132

1. Preview product; estimated availability in Q3 2010.



Please be aware that an important notice concerning availability, standard warranty, and use in critical applications of Texas Instruments semiconductor products and disclaimers thereto appears at the end of this data sheet.

All trademarks are the property of their respective owners.



This integrated circuit can be damaged by ESD. Texas Instruments recommends that all integrated circuits be handled with appropriate precautions. Failure to observe proper handling and installation procedures can cause damage.

ESD damage can range from subtle performance degradation to complete device failure. Precision integrated circuits may be more susceptible to damage because very small parametric changes could cause the device not to meet its published specifications.

ABSOLUTE MAXIMUM RATINGS⁽¹⁾

Over operating free-air temperature range (unless otherwise noted).

		VALUE	UNIT
Supply Voltage		±20	V
Signal Input Terminals	Voltage ⁽²⁾	(V–) –0.5 to (V+) +0.5	V
	Current ⁽²⁾	±10	mA
Output Short-Circuit ⁽³⁾		Continuous	
Operating Temperature, T _A		–55 to +150	°C
Storage Temperature, T _A		–65 to +150	°C
Junction Temperature, T _J		+150	°C
ESD Ratings	Human Body Model (HBM)	2000	V
	Charged Device Model (CDM)	500	V

- (1) Stresses above these ratings may cause permanent damage. Exposure to absolute maximum conditions for extended periods may degrade device reliability. These are stress ratings only, and functional operation of the device at these or any other conditions beyond those specified is not supported.
- (2) Input terminals are diode-clamped to the power-supply rails. Input signals that can swing more than 0.5V beyond the supply rails should be current limited to 10 mA or less.
- (3) Short-circuit to V_S/2 (ground in symmetrical dual-supply setups), one amplifier per package.

PACKAGE INFORMATION⁽¹⁾

PRODUCT	PACKAGE-LEAD	PACKAGE DESIGNATOR	PACKAGE MARKING
OPA141	SO-8	D	O141A
	MSOP-8	DGK	141
OPA2141	SO-8	D	O2141A
	MSOP-8	DGK	2141
OPA4141	TSSOP-14	PW	O4141A
	SO-14	D	O4141AG4

- (1) For the most current package and ordering information see the Package Option Addendum at the end of this document, or visit the device product folder at www.ti.com.

THERMAL INFORMATION

THERMAL METRIC		OPA141, OPA2141	OPA141, OPA2141	UNITS
		D (SO)	DGK (MSOP) ⁽¹⁾	
		8	8	
θ_{JA}	Junction-to-ambient thermal resistance ⁽²⁾	160	180	°C/W
$\theta_{JC(top)}$	Junction-to-case(top) thermal resistance ⁽³⁾	75	55	
θ_{JB}	Junction-to-board thermal resistance ⁽⁴⁾	60	130	
ψ_{JT}	Junction-to-top characterization parameter ⁽⁵⁾	9	n/a	
ψ_{JB}	Junction-to-board characterization parameter ⁽⁶⁾	50	120	
$\theta_{JC(bottom)}$	Junction-to-case(bottom) thermal resistance ⁽⁷⁾	n/a	n/a	

- (1) For more information about traditional and new thermal metrics, see the *IC Package Thermal Metrics* application report, [SPRA953](#).
- (2) The junction-to-ambient thermal resistance under natural convection is obtained in a simulation on a JEDEC-standard, high-K board, as specified in JESD51-7, in an environment described in JESD51-2a.
- (3) The junction-to-case (top) thermal resistance is obtained by simulating a cold plate test on the package top. No specific JEDEC-standard test exists, but a close description can be found in the ANSI SEMI standard G30-88.
- (4) The junction-to-board thermal resistance is obtained by simulating in an environment with a ring cold plate fixture to control the PCB temperature, as described in JESD51-8.
- (5) The junction-to-top characterization parameter, ψ_{JT} , estimates the junction temperature of a device in a real system and is extracted from the simulation data for obtaining θ_{JA} , using a procedure described in JESD51-2a (sections 6 and 7).
- (6) The junction-to-board characterization parameter, ψ_{JB} , estimates the junction temperature of a device in a real system and is extracted from the simulation data for obtaining θ_{JA} , using a procedure described in JESD51-2a (sections 6 and 7).
- (7) The junction-to-case (bottom) thermal resistance is obtained by simulating a cold plate test on the exposed (power) pad. No specific JEDEC standard test exists, but a close description can be found in the ANSI SEMI standard G30-88.

THERMAL INFORMATION

THERMAL METRIC		OPA4141	OPA4141	UNITS
		D (SO)	PW (TSSOP) ⁽¹⁾	
		14	14	
θ_{JA}	Junction-to-ambient thermal resistance ⁽²⁾	97	135	°C/W
$\theta_{JC(top)}$	Junction-to-case(top) thermal resistance ⁽³⁾	56	45	
θ_{JB}	Junction-to-board thermal resistance ⁽⁴⁾	53	66	
ψ_{JT}	Junction-to-top characterization parameter ⁽⁵⁾	19	n/a	
ψ_{JB}	Junction-to-board characterization parameter ⁽⁶⁾	46	60	
$\theta_{JC(bottom)}$	Junction-to-case(bottom) thermal resistance ⁽⁷⁾	n/a	n/a	

- (1) For more information about traditional and new thermal metrics, see the *IC Package Thermal Metrics* application report, [SPRA953](#).
- (2) The junction-to-ambient thermal resistance under natural convection is obtained in a simulation on a JEDEC-standard, high-K board, as specified in JESD51-7, in an environment described in JESD51-2a.
- (3) The junction-to-case (top) thermal resistance is obtained by simulating a cold plate test on the package top. No specific JEDEC-standard test exists, but a close description can be found in the ANSI SEMI standard G30-88.
- (4) The junction-to-board thermal resistance is obtained by simulating in an environment with a ring cold plate fixture to control the PCB temperature, as described in JESD51-8.
- (5) The junction-to-top characterization parameter, ψ_{JT} , estimates the junction temperature of a device in a real system and is extracted from the simulation data for obtaining θ_{JA} , using a procedure described in JESD51-2a (sections 6 and 7).
- (6) The junction-to-board characterization parameter, ψ_{JB} , estimates the junction temperature of a device in a real system and is extracted from the simulation data for obtaining θ_{JA} , using a procedure described in JESD51-2a (sections 6 and 7).
- (7) The junction-to-case (bottom) thermal resistance is obtained by simulating a cold plate test on the exposed (power) pad. No specific JEDEC standard test exists, but a close description can be found in the ANSI SEMI standard G30-88.

ELECTRICAL CHARACTERISTICS: $V_S = +4.5V$ to $+36V$; $\pm 2.25V$ to $\pm 18V$

Boldface limits apply over the specified temperature range, $T_A = -40^\circ C$ to $+125^\circ C$.

At $T_A = +25^\circ C$, $R_L = 2k\Omega$ connected to midsupply, $V_{CM} = V_{OUT} =$ midsupply, unless otherwise noted.

PARAMETER	CONDITIONS	OPA141, OPA2141, OPA4141			UNIT
		MIN	TYP	MAX	
OFFSET VOLTAGE					
Offset Voltage, RTI	V_{OS}	$V_S = \pm 18V$	± 1	± 3.5	mV
Over Temperature		$V_S = \pm 18V$		± 4.3	mV
Drift	dV_{OS}/dT	$V_S = \pm 18V$	± 2	± 10	$\mu V/^\circ C$
vs Power Supply	PSRR	$V_S = \pm 2.25V$ to $\pm 18V$	± 0.14	± 2	$\mu V/V$
Over Temperature		$V_S = \pm 2.25V$ to $\pm 18V$		± 4	$\mu V/V$
INPUT BIAS CURRENT					
Input Bias Current	I_B		± 2	± 20	pA
Over Temperature				± 5	nA
Input Offset Current	I_{OS}		± 2	± 20	pA
Over Temperature				± 1	nA
NOISE					
Input Voltage Noise					
				250	nV _{PP}
				42	nV _{RMS}
Input Voltage Noise Density					
	e_n			12	nV/ \sqrt{Hz}
				6.5	nV/ \sqrt{Hz}
				6.5	nV/ \sqrt{Hz}
Input Current Noise Density					
	i_n			0.8	fA/ \sqrt{Hz}
INPUT VOLTAGE RANGE					
Common-Mode Voltage Range	V_{CM}		(V-) -0.1	(V+) -3.5	V
Common-Mode Rejection Ratio	CMRR	$V_S = \pm 18V$, $V_{CM} = (V-) -0.1V$ to $(V+) -3.5V$	120	126	dB
Over Temperature		$V_S = \pm 18V$, $V_{CM} = (V-) -0.1V$ to $(V+) -3.5V$	120		dB
INPUT IMPEDANCE					
Differential					
				$10^{13} \parallel 8$	$\Omega \parallel pF$
Common-Mode					
		$V_{CM} = (V-) -0.1V$ to $(V+) -3.5V$		$10^{13} \parallel 6$	$\Omega \parallel pF$
OPEN-LOOP GAIN					
Open-Loop Voltage Gain	A_{OL}	$V_O = (V-) +0.35V$ to $(V+) -0.35V$, $R_L = 2k\Omega$	114	126	dB
Over Temperature		$V_O = (V-) +0.35V$ to $(V+) -0.35V$, $R_L = 2k\Omega$	108		dB
FREQUENCY RESPONSE					
Gain Bandwidth Product					
	BW			10	MHz
Slew Rate					
				20	V/ μs
Settling Time, 12-bit (0.024)					
				880	ns
THD+N					
		1kHz, $G = 1$, $V_O = 3.5V_{RMS}$		0.00005	%
Overload Recovery Time					
				600	ns

ELECTRICAL CHARACTERISTICS: $V_S = +4.5V$ to $+36V$; $\pm 2.25V$ to $\pm 18V$ (continued)
Boldface limits apply over the specified temperature range, $T_A = -40^\circ C$ to $+125^\circ C$.

 At $T_A = +25^\circ C$, $R_L = 2k\Omega$ connected to midsupply, $V_{CM} = V_{OUT} =$ midsupply, unless otherwise noted.

PARAMETER	CONDITIONS	OPA141, OPA2141, OPA4141			UNIT
		MIN	TYP	MAX	
OUTPUT					
Voltage Output V_O	$R_L = 10k\Omega$	$(V^-)+0.2$		$(V^+)-0.2$	V
	$R_L = 2k\Omega$	$(V^-)+0.35$		$(V^+)-0.35$	V
Short-Circuit Current I_{SC}	Source		+36		mA
	Sink		-30		mA
Capacitive Load Drive C_{LOAD}		See Figure 19 and Figure 20			
Open-Loop Output Impedance R_O	$f = 1MHz, I_O = 0$ (See Figure 18)		10		Ω
POWER SUPPLY					
Specified Voltage Range V_S		± 2.25		± 18	V
Quiescent Current (per amplifier) I_Q	$I_O = 0mA$		1.8	2.3	mA
		Over Temperature		3.1	mA
CHANNEL SEPARATION					
Channel Separation	At dc		0.02		$\mu V/V$
	At 100kHz		10		$\mu V/V$
TEMPERATURE RANGE					
Specified Range		-40		+125	$^\circ C$
Operating Range		-55		+150	$^\circ C$

PIN ASSIGNMENTS

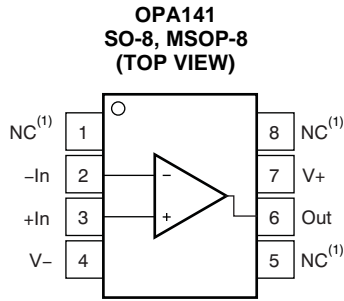

(1) NC denotes no internal connection.

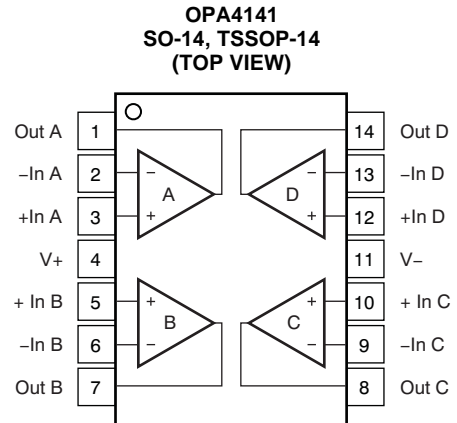
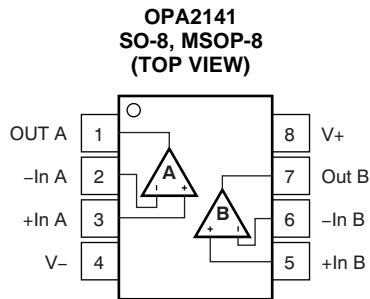

SIMPLIFIED BLOCK DIAGRAM

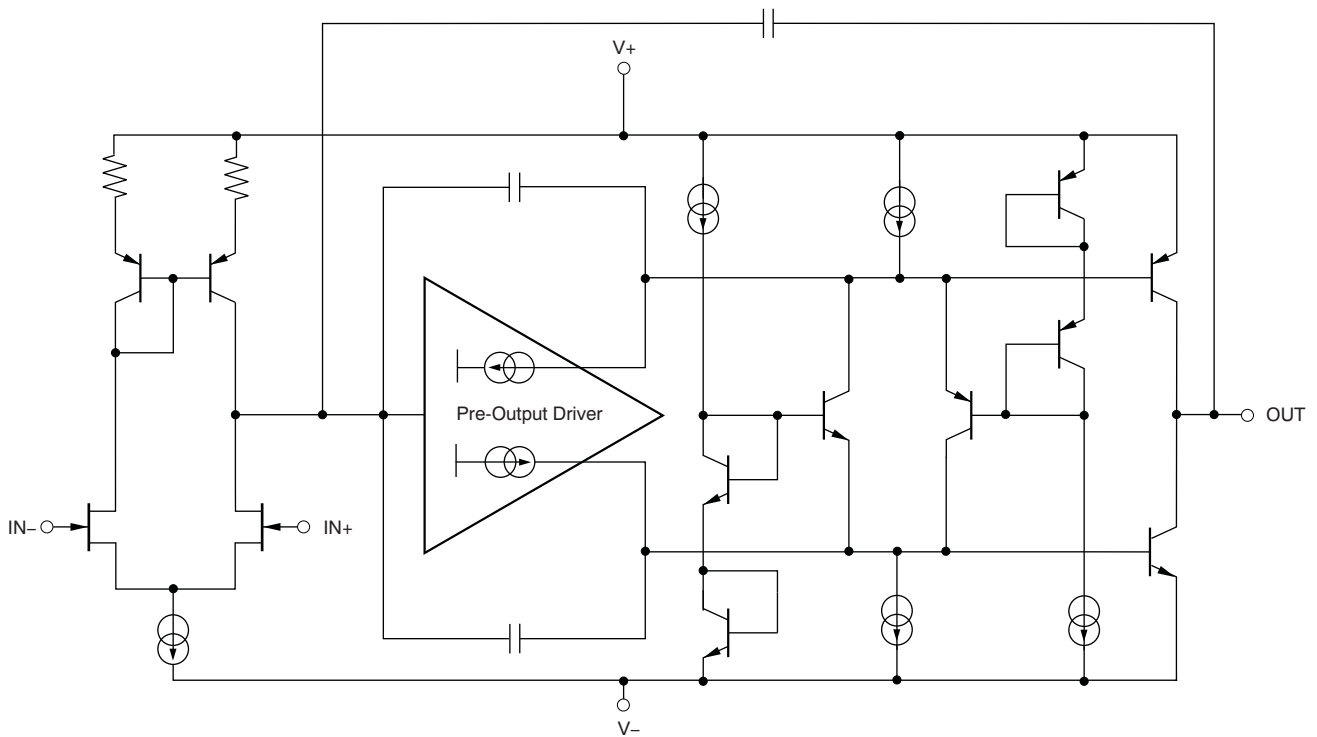

Figure 1.

TYPICAL CHARACTERISTICS SUMMARY

TABLE OF GRAPHS

Table 1. Characteristic Performance Measurements

DESCRIPTION	FIGURE
Offset Voltage Production Distribution	Figure 2
Offset Voltage Drift Distribution	Figure 3
Offset Voltage vs Common-Mode Voltage (Max Supply)	Figure 4
I_B and I_{OS} vs Common-Mode Voltage	Figure 5
Output Voltage Swing vs Output Current	Figure 6
CMRR and PSRR vs Frequency (RTI)	Figure 7
Common-Mode Rejection Ratio vs Temperature	Figure 8
0.1Hz to 10Hz Noise	Figure 9
Input Voltage Noise Density vs Frequency	Figure 10
THD+N Ratio vs Frequency (80kHz AP Bandwidth)	Figure 11
THD+N Ratio vs Output Amplitude	Figure 12
Quiescent Current vs Temperature	Figure 13
Quiescent Current vs Supply Voltage	Figure 14
Gain and Phase vs Frequency	Figure 15
Closed-Loop Gain vs Frequency	Figure 16
Open-Loop Gain vs Temperature	Figure 17
Open-Loop Output Impedance vs Frequency	Figure 18
Small-Signal Overshoot vs Capacitive Load ($G = +1$)	Figure 19
Small-Signal Overshoot vs Capacitive Load ($G = -1$)	Figure 20
No Phase Reversal	Figure 21
Positive Overload Recovery	Figure 22
Negative Overload Recovery	Figure 23
Small-Signal Step Response ($G = +1$)	Figure 24
Small-Signal Step Response ($G = -1$)	Figure 25
Large-Signal Step Response ($G = +1$)	Figure 26
Large-Signal Step Response ($G = -1$)	Figure 27
Short-Circuit Current vs Temperature	Figure 28
Maximum Output Voltage vs Frequency	Figure 29
Channel Separation vs Frequency	Figure 30

TYPICAL CHARACTERISTICS

At $T_A = +25^\circ\text{C}$, $V_S = \pm 18\text{V}$, $R_L = 2\text{k}\Omega$ connected to midsupply, $V_{CM} = V_{OUT} = \text{midsupply}$, unless otherwise noted.

OFFSET VOLTAGE PRODUCTION DISTRIBUTION

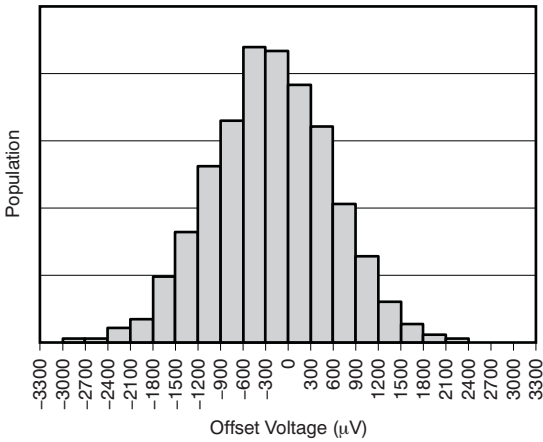

Figure 2.

OFFSET VOLTAGE DRIFT DISTRIBUTION

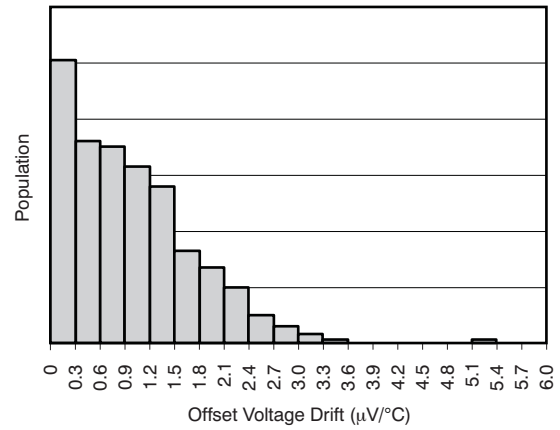

Figure 3.

OFFSET VOLTAGE vs COMMON-MODE VOLTAGE

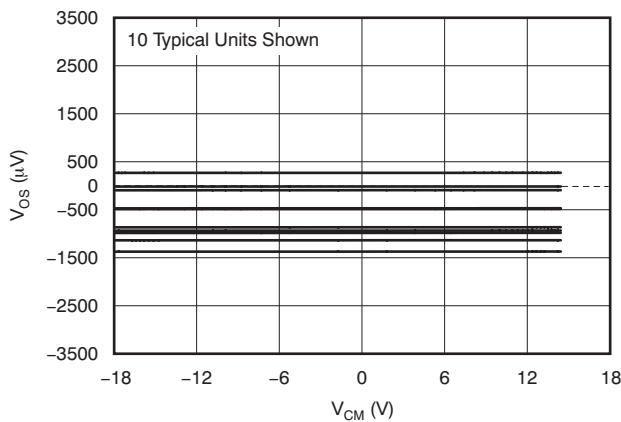

Figure 4.

I_B AND I_{OS} vs COMMON-MODE VOLTAGE

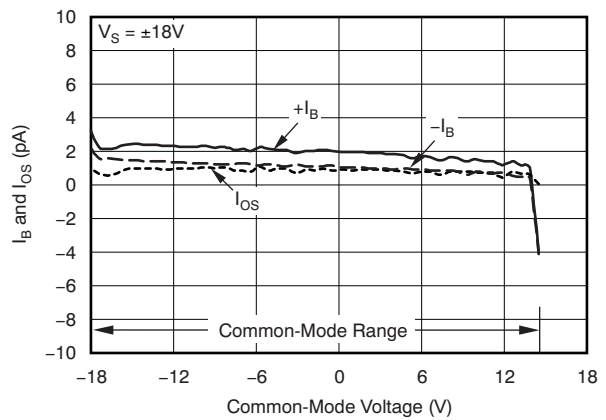

Figure 5.

OUTPUT VOLTAGE SWING vs OUTPUT CURRENT (MAX SUPPLY)

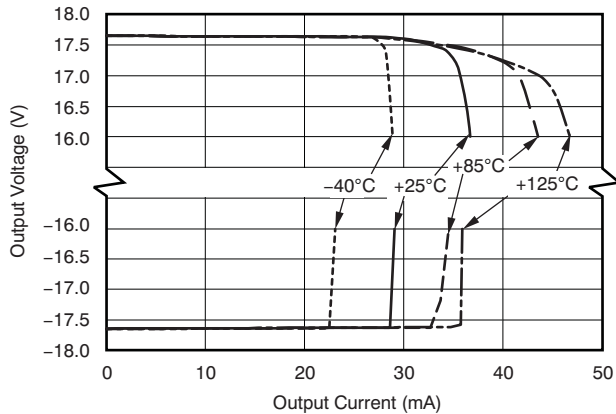

Figure 6.

CMRR AND PSRR vs FREQUENCY (Referred to Input)

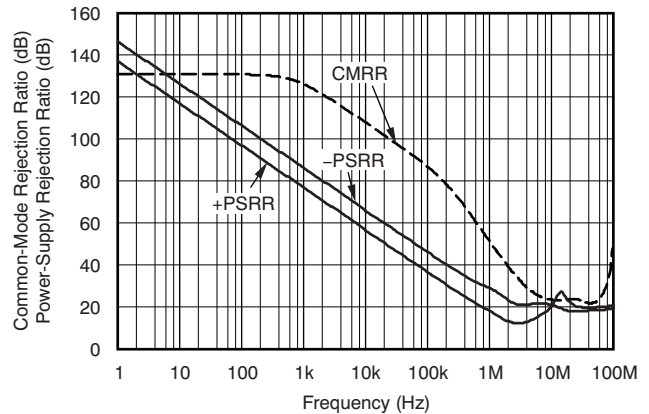

Figure 7.

TYPICAL CHARACTERISTICS (continued)

At $T_A = +25^\circ\text{C}$, $V_S = \pm 18\text{V}$, $R_L = 2\text{k}\Omega$ connected to midsupply, $V_{CM} = V_{OUT} = \text{midsupply}$, unless otherwise noted.

COMMON-MODE REJECTION RATIO vs TEMPERATURE

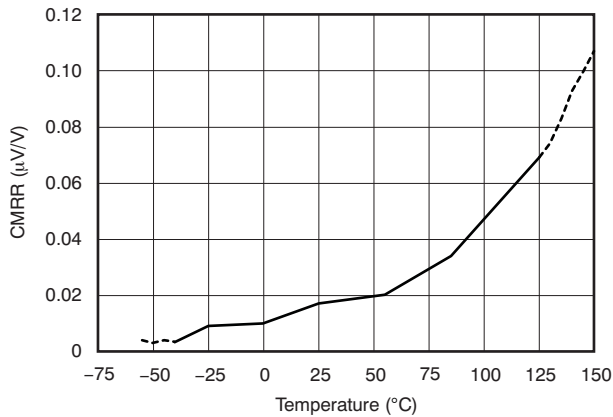

Figure 8.

0.1Hz to 10Hz NOISE

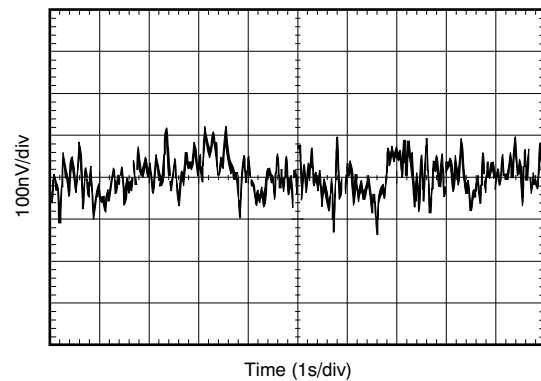

Figure 9.

INPUT VOLTAGE NOISE DENSITY vs FREQUENCY

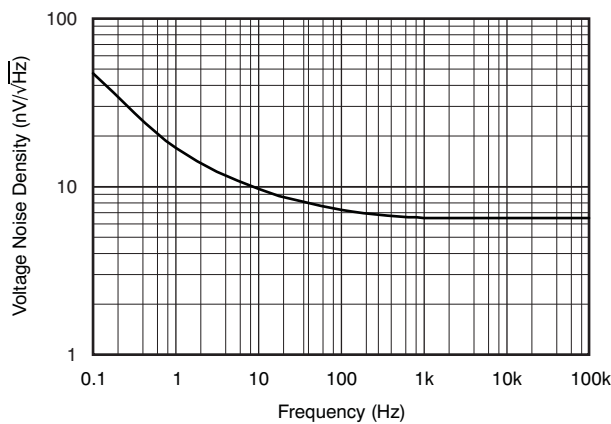

Figure 10.

THD+N RATIO vs FREQUENCY

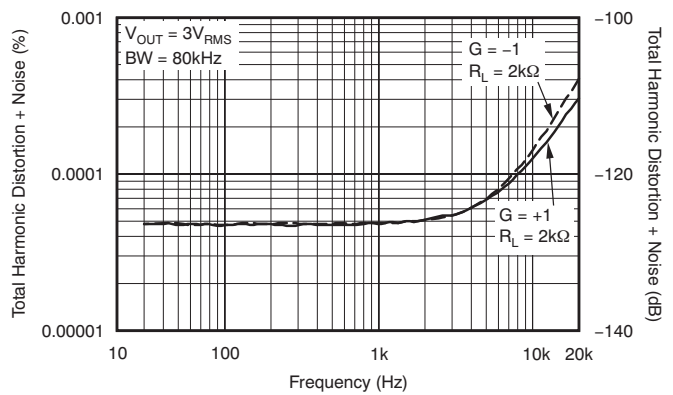

Figure 11.

THD+N RATIO vs OUTPUT AMPLITUDE

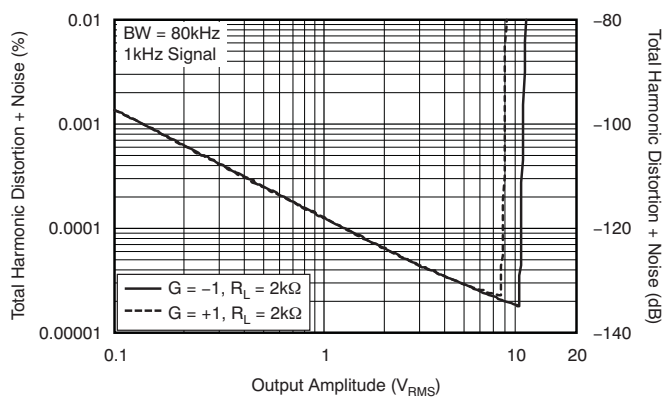

Figure 12.

QUIESCENT CURRENT vs TEMPERATURE

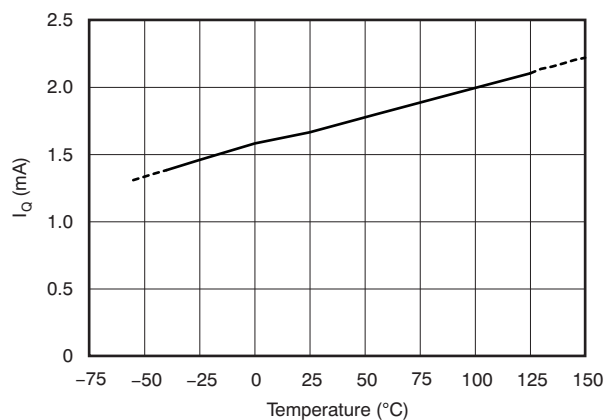

Figure 13.

TYPICAL CHARACTERISTICS (continued)

At $T_A = +25^\circ\text{C}$, $V_S = \pm 18\text{V}$, $R_L = 2\text{k}\Omega$ connected to midsupply, $V_{CM} = V_{OUT} = \text{midsupply}$, unless otherwise noted.

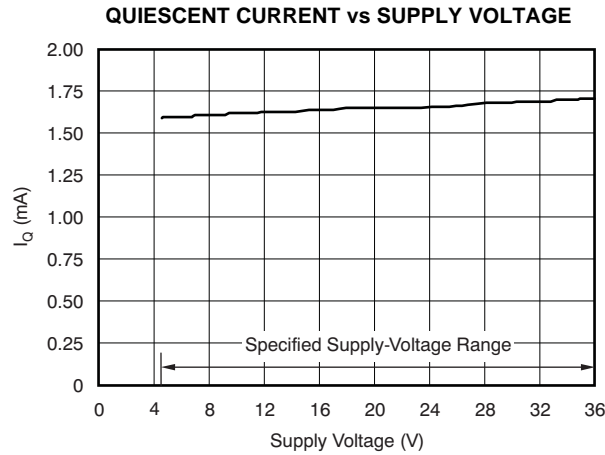

Figure 14.

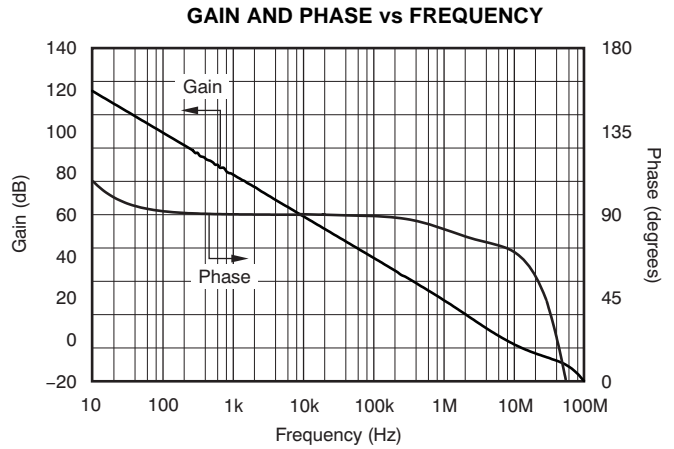

Figure 15.

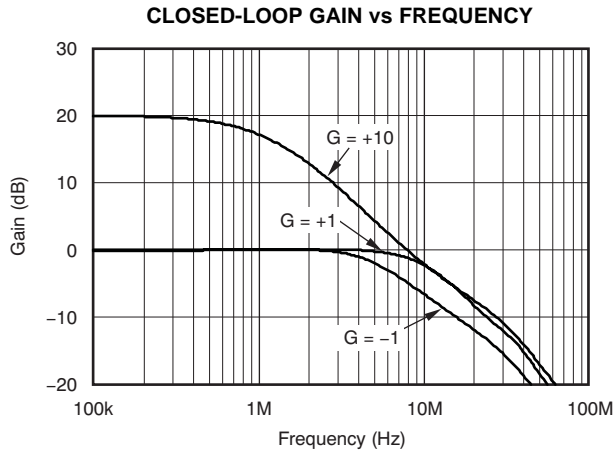

Figure 16.

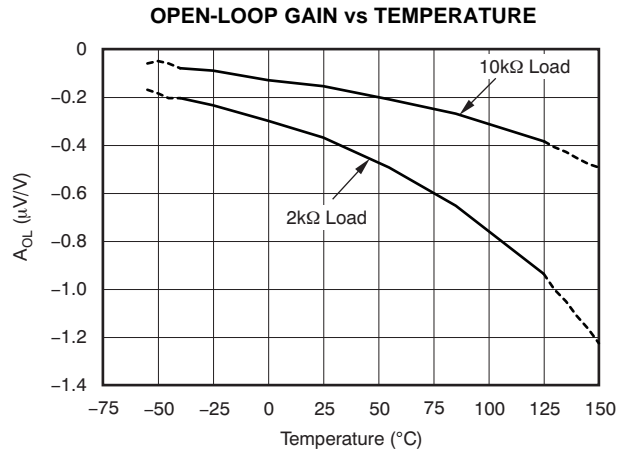

Figure 17.

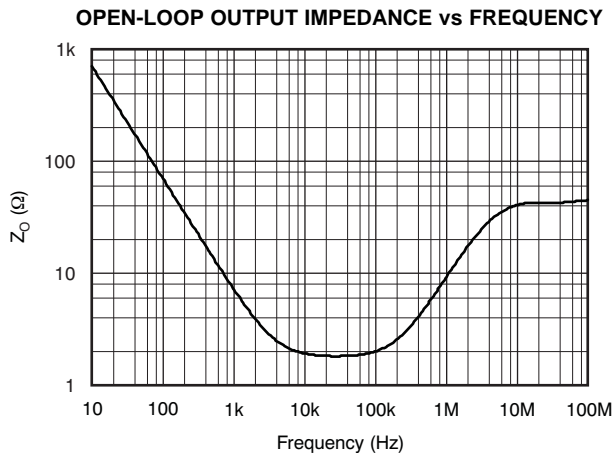

Figure 18.

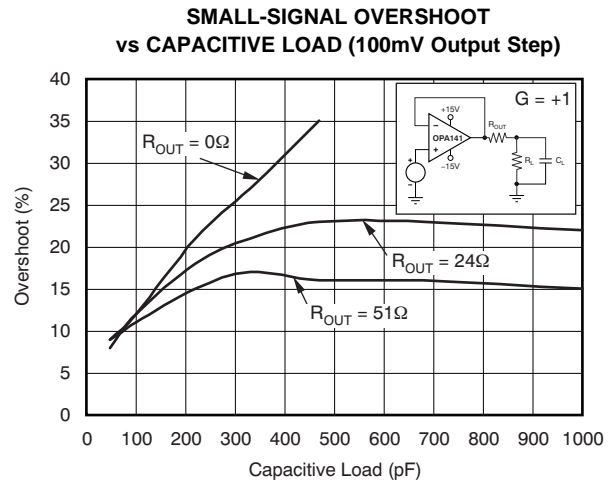

Figure 19.

TYPICAL CHARACTERISTICS (continued)

At $T_A = +25^\circ\text{C}$, $V_S = \pm 18\text{V}$, $R_L = 2\text{k}\Omega$ connected to midsupply, $V_{CM} = V_{OUT} = \text{midsupply}$, unless otherwise noted.

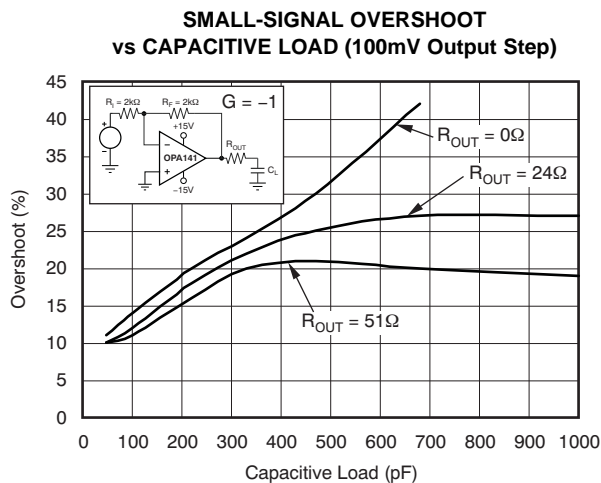

Figure 20.

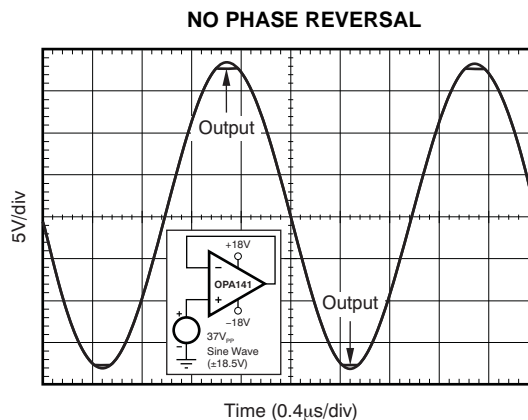

Figure 21.

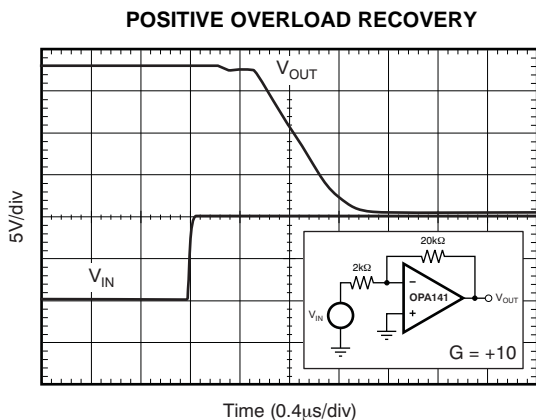

Figure 22.

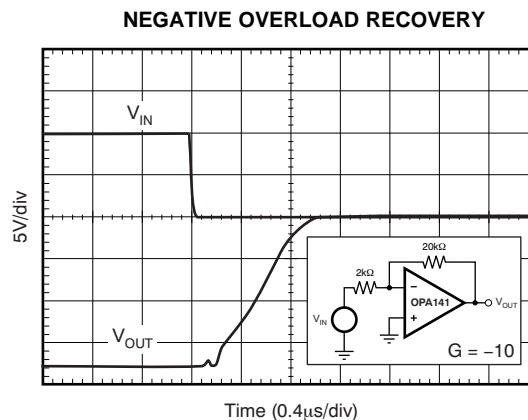

Figure 23.

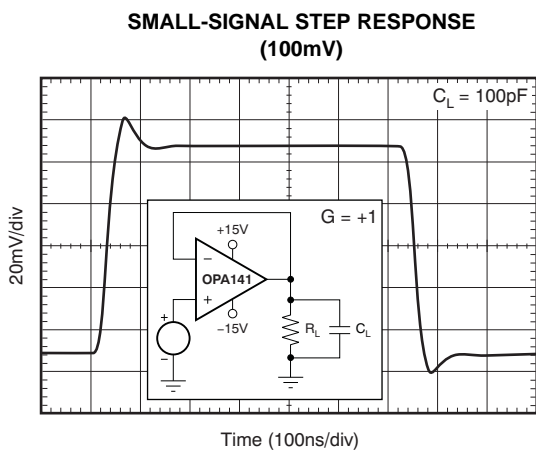

Figure 24.

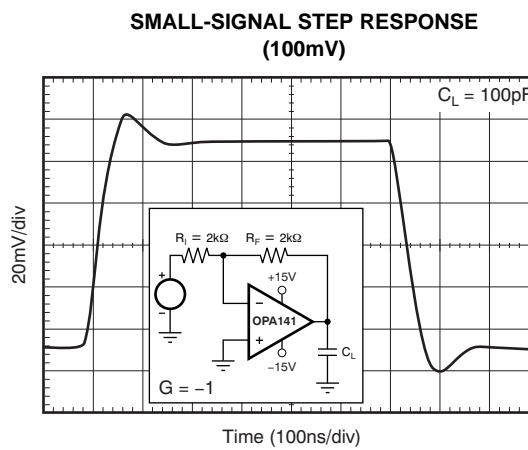

Figure 25.

TYPICAL CHARACTERISTICS (continued)

At $T_A = +25^\circ\text{C}$, $V_S = \pm 18\text{V}$, $R_L = 2\text{k}\Omega$ connected to midsupply, $V_{CM} = V_{OUT} = \text{midsupply}$, unless otherwise noted.

LARGE-SIGNAL STEP RESPONSE

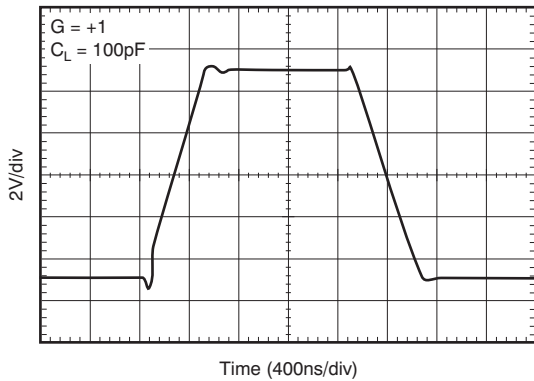

Figure 26.

LARGE-SIGNAL STEP RESPONSE

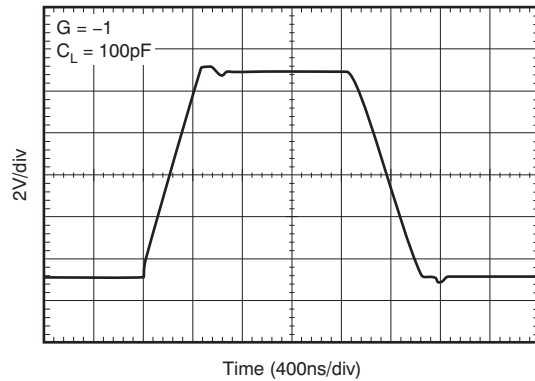

Figure 27.

SHORT-CIRCUIT CURRENT vs TEMPERATURE

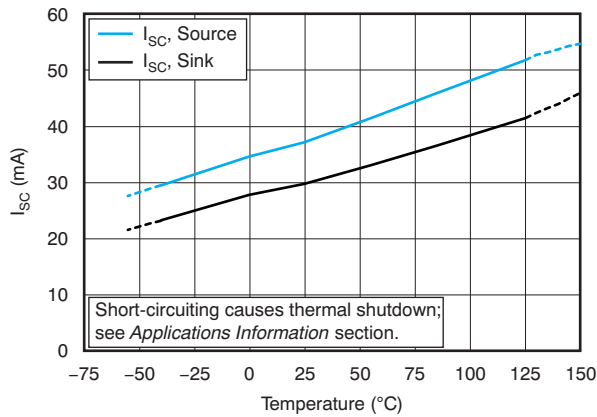

Figure 28.

MAXIMUM OUTPUT VOLTAGE vs FREQUENCY

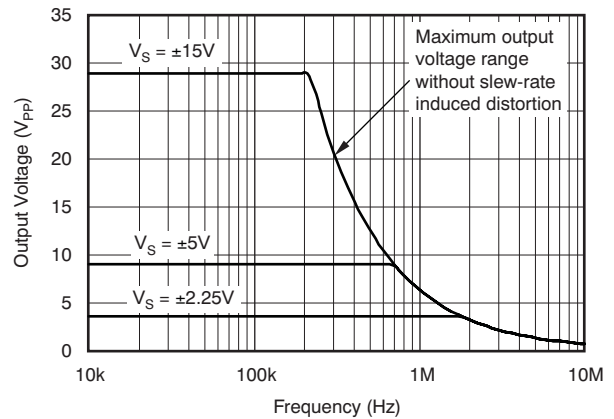

Figure 29.

CHANNEL SEPARATION vs FREQUENCY

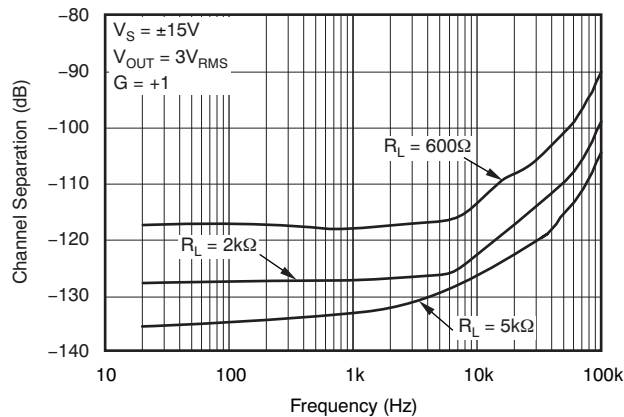

Figure 30.

APPLICATION INFORMATION

The OPA141, OPA2141, and OPA4141 are unity-gain stable, operational amplifiers with very low noise, input bias current, and input offset voltage. Applications with noisy or high-impedance power supplies require decoupling capacitors placed close to the device pins. In most cases, 0.1µF capacitors are adequate. Figure 1 shows a simplified schematic of the OPA141.

OPERATING VOLTAGE

The OPA141, OPA2141, and OPA4141 series of op amps can be used with single or dual supplies from an operating range of $V_S = +4.5V (\pm 2.25V)$ and up to $V_S = +36V (\pm 18V)$. These devices do not require symmetrical supplies; they only require a minimum supply voltage of +4.5V ($\pm 2.25V$). For V_S less than $\pm 3.5V$, the common-mode input range does not include midsupply. Supply voltages higher than +40V can permanently damage the device; see the [Absolute Maximum Ratings](#) table. Key parameters are specified over the operating temperature range, $T_A = -40^\circ C$ to $+125^\circ C$. Key parameters that vary over the supply voltage or temperature range are shown in the [Typical Characteristics](#) section of this data sheet.

CAPACITIVE LOAD AND STABILITY

The dynamic characteristics of the OPAX141 have been optimized for commonly encountered gains, loads, and operating conditions. The combination of low closed-loop gain and high capacitive loads decreases the phase margin of the amplifier and can lead to gain peaking or oscillations. As a result, heavier capacitive loads must be isolated from the output. The simplest way to achieve this isolation is to add a small resistor (R_{OUT} equal to 50Ω, for example) in series with the output.

Figure 19 and Figure 20 illustrate graphs of *Small-Signal Overshoot vs Capacitive Load* for several values of R_{OUT} . Also, refer to [Applications Bulletin AB-028](#) (literature number [SBOA015](#), available for download from the [TI web site](#)) for details of analysis techniques and application circuits.

NOISE PERFORMANCE

Figure 31 shows the total circuit noise for varying source impedances with the operational amplifier in a unity-gain configuration (with no feedback resistor network and therefore no additional noise contributions). The OPA141 and OPA211 are shown

with total circuit noise calculated. The op amp itself contributes both a voltage noise component and a current noise component. The voltage noise is commonly modeled as a time-varying component of the offset voltage. The current noise is modeled as the time-varying component of the input bias current and reacts with the source resistance to create a voltage component of noise. Therefore, the lowest noise op amp for a given application depends on the source impedance. For low source impedance, current noise is negligible, and voltage noise generally dominates. The OPA141, OPA2141, and OPA4141 family has both low voltage noise and extremely low current noise because of the FET input of the op amp. As a result, the current noise contribution of the OPAX141 series is negligible for any practical source impedance, which makes it the better choice for applications with high source impedance.

The equation in Figure 31 shows the calculation of the total circuit noise, with these parameters:

- e_n = voltage noise
- I_n = current noise
- R_S = source impedance
- k = Boltzmann's constant = 1.38×10^{-23} J/K
- T = temperature in degrees Kelvin (K)

For more details on calculating noise, see the section on [Basic Noise Calculations](#).

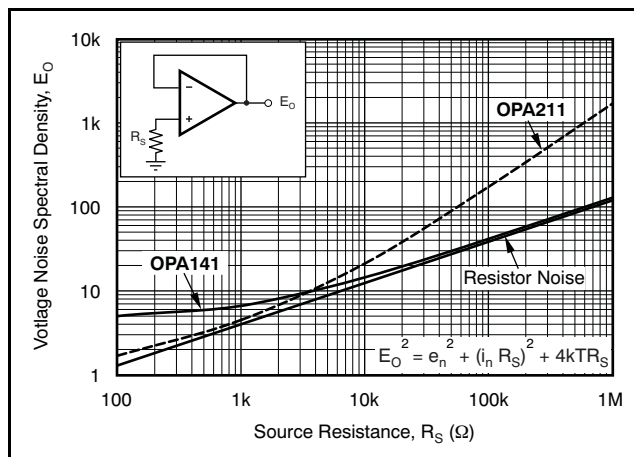

Figure 31. Noise Performance of the OPA141 and OPA211 in Unity-Gain Buffer Configuration

BASIC NOISE CALCULATIONS

Low-noise circuit design requires careful analysis of all noise sources. External noise sources can dominate in many cases; consider the effect of source resistance on overall op amp noise performance. Total noise of the circuit is the root-sum-square combination of all noise components.

The resistive portion of the source impedance produces thermal noise proportional to the square root of the resistance. This function is plotted in Figure 31. The source impedance is usually fixed; consequently, select the op amp and the feedback resistors to minimize the respective contributions to the total noise.

Figure 32 illustrates both noninverting (A) and inverting (B) op amp circuit configurations with gain. In circuit configurations with gain, the feedback network resistors also contribute noise. In general, the current noise of the op amp reacts with the feedback resistors to create additional noise components. However, the extremely low current noise of the OPAx141 means that its current noise contribution can be neglected.

The feedback resistor values can generally be chosen to make these noise sources negligible. Note that low impedance feedback resistors load the output of the amplifier. The equations for total noise are shown for both configurations.

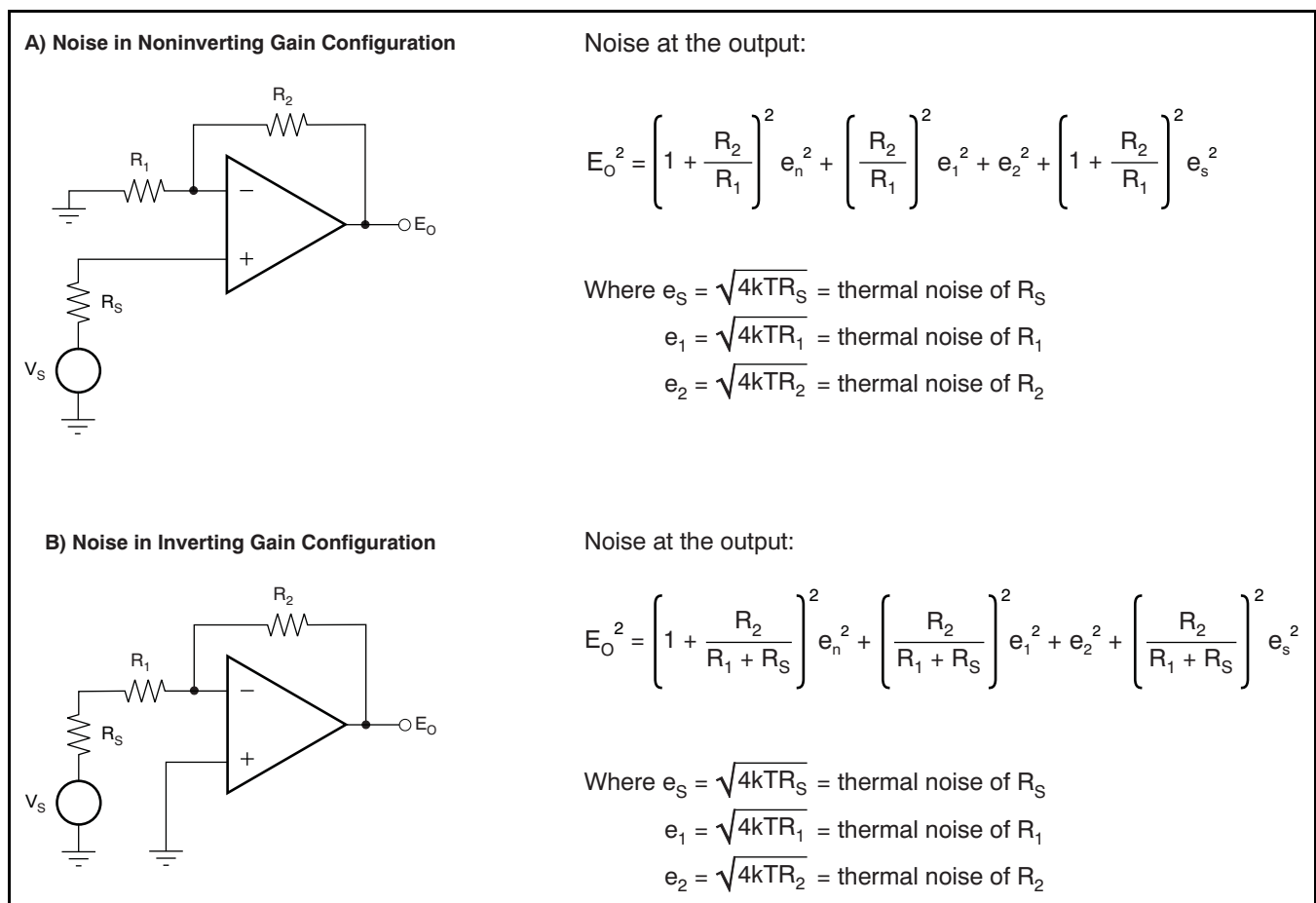

For the OPAx141 series of operational amplifiers at 1kHz, $e_n = 6.5\text{nV}/\sqrt{\text{Hz}}$.

Figure 32. Noise Calculation in Gain Configurations

PHASE-REVERSAL PROTECTION

The OPA141, OPA2141, and OPA4141 family has internal phase-reversal protection. Many FET- and bipolar-input op amps exhibit a phase reversal when the input is driven beyond its linear common-mode range. This condition is most often encountered in noninverting circuits when the input is driven beyond the specified common-mode voltage range, causing the output to reverse into the opposite rail. The input circuitry of the OPA141, OPA2141, and OPA4141 prevents phase reversal with excessive common-mode voltage; instead, the output limits into the appropriate rail (see [Figure 21](#)).

OUTPUT CURRENT LIMIT

The output current of the OPAx141 series is limited by internal circuitry to +36mA/–30mA (sourcing/sinking), to protect the device if the output is accidentally shorted. This short-circuit current depends on temperature, as shown in [Figure 28](#).

POWER DISSIPATION AND THERMAL PROTECTION

The OPAx141 series of op amps are capable of driving 2k Ω loads with power-supply voltages of up to ± 18 V over the specified temperature range. In a single-supply configuration, where the load is connected to the negative supply voltage, the minimum load resistance is 2.8k Ω at a supply voltage of +36V. For lower supply voltages (either single-supply or symmetrical supplies), a lower load resistance may be used, as long as the output current does not exceed 13mA; otherwise, the device short-circuit current protection circuit may activate.

Internal power dissipation increases when operating at high supply voltages. Copper leadframe construction used in the OPA141, OPA2141, and OPA4141 series devices improves heat dissipation compared to conventional materials. Printed circuit board (PCB) layout can also help reduce a possible increase in junction temperature. Wide copper traces help dissipate the heat by acting as an additional heatsink. Temperature rise can be further minimized by soldering the devices directly to the PCB rather than using a socket.

Although the output current is limited by internal protection circuitry, accidental shorting of one or more output channels of a device can result in excessive heating. For instance, when an output is shorted to mid-supply, the typical short-circuit current of 36mA leads to an internal power dissipation of over 600mW at a supply of ± 18 V.

In the case of a dual OPA2141 in an MSOP-8 package (thermal resistance $\theta_{JA} = 180^{\circ}\text{C}/\text{W}$), such power dissipation would lead the die temperature to be 220 $^{\circ}\text{C}$ above ambient temperature, when both channels are shorted. This temperature increase significantly decreases the operating life of the device.

In order to prevent excessive heating, the OPAx141 series has an internal thermal shutdown circuit, which shuts down the device if the die temperature exceeds approximately +180 $^{\circ}\text{C}$. Once this thermal shutdown circuit activates, a built-in hysteresis of 15 $^{\circ}\text{C}$ ensures that the die temperature must drop to approximately +165 $^{\circ}\text{C}$ before the device switches on again.

Additional consideration should be given to the combination of maximum operating voltage, maximum operating temperature, load, and package type. [Figure 33](#) and [Figure 34](#) show several practical considerations when evaluating the OPA2141 (dual version) and the OPA4141 (quad version).

As an example, the OPA4141 has a maximum total quiescent current of 12.4mA (3.1mA/channel) over temperature. The TSSOP-14 package has a typical thermal resistance of 135 $^{\circ}\text{C}/\text{W}$. This parameter means that because the junction temperature should not exceed 150 $^{\circ}\text{C}$ in order to ensure reliable operation, either the supply voltage must be reduced, or the ambient temperature should remain low enough so that the junction temperature does not exceed 150 $^{\circ}\text{C}$. This condition is illustrated in [Figure 33](#) for various package types. Moreover, resistive loading of the output causes additional power dissipation and thus self-heating, which also must be considered when establishing the maximum supply voltage or operating temperature. To this end, [Figure 34](#) shows the maximum supply voltage versus temperature for a worst-case dc load resistance of 2k Ω .

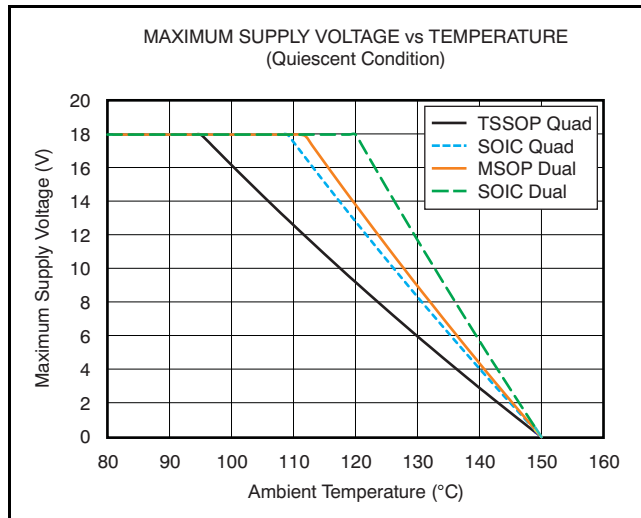

Figure 33. Maximum Supply Voltage vs Temperature (OPA2141 and OPA4141), Quiescent Condition

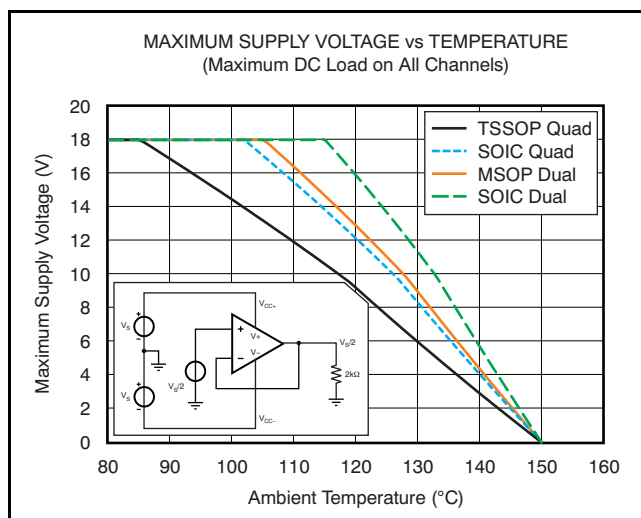

Figure 34. Maximum Supply Voltage vs Temperature (OPA2141 and OPA4141), Maximum DC Load

ELECTRICAL OVERSTRESS

Designers often ask questions about the capability of an operational amplifier to withstand electrical overstress. These questions tend to focus on the device inputs, but may involve the supply voltage pins or even the output pin. Each of these different pin

functions have electrical stress limits determined by the voltage breakdown characteristics of the particular semiconductor fabrication process and specific circuits connected to the pin. Additionally, internal electrostatic discharge (ESD) protection is built into these circuits to protect them from accidental ESD events both before and during product assembly.

It is helpful to have a good understanding of this basic ESD circuitry and its relevance to an electrical overstress event. See [Figure 35](#) for an illustration of the ESD circuits contained in the OPAx141 series (indicated by the dashed line area). The ESD protection circuitry involves several current-steering diodes connected from the input and output pins and routed back to the internal power-supply lines, where they meet at an absorption device internal to the operational amplifier. This protection circuitry is intended to remain inactive during normal circuit operation.

An ESD event produces a short duration, high-voltage pulse that is transformed into a short duration, high-current pulse as it discharges through a semiconductor device. The ESD protection circuits are designed to provide a current path around the operational amplifier core to prevent it from being damaged. The energy absorbed by the protection circuitry is then dissipated as heat.

When an ESD voltage develops across two or more of the amplifier device pins, current flows through one or more of the steering diodes. Depending on the path that the current takes, the absorption device may activate. The absorption device has a trigger, or threshold voltage, that is above the normal operating voltage of the OPAx141 but below the device breakdown voltage level. Once this threshold is exceeded, the absorption device quickly activates and clamps the voltage across the supply rails to a safe level.

When the operational amplifier connects into a circuit such as the one [Figure 35](#) shows, the ESD protection components are intended to remain inactive and not become involved in the application circuit operation. However, circumstances may arise where an applied voltage exceeds the operating voltage range of a given pin. Should this condition occur, there is a risk that some of the internal ESD protection circuits may be biased on, and conduct current. Any such current flow occurs through steering diode paths and rarely involves the absorption device.

Figure 35 depicts a specific example where the input voltage, V_{IN} , exceeds the positive supply voltage ($+V_S$) by 500mV or more. Much of what happens in the circuit depends on the supply characteristics. If $+V_S$ can sink the current, one of the upper input steering diodes conducts and directs current to $+V_S$. Excessively high current levels can flow with increasingly higher V_{IN} . As a result, the datasheet specifications recommend that applications limit the input current to 10mA.

If the supply is not capable of sinking the current, V_{IN} may begin sourcing current to the operational amplifier, and then take over as the source of positive supply voltage. The danger in this case is that the voltage can rise to levels that exceed the operational amplifier absolute maximum ratings.

Another common question involves what happens to the amplifier if an input signal is applied to the input while the power supplies $+V_S$ and/or $-V_S$ are at 0V.

Again, it depends on the supply characteristic while at 0V, or at a level below the input signal amplitude. If the supplies appear as high impedance, then the operational amplifier supply current may be supplied by the input source via the current steering diodes. This state is not a normal bias condition; the amplifier most likely will not operate normally. If the supplies are low impedance, then the current through the steering diodes can become quite high. The current level depends on the ability of the input source to deliver current, and any resistance in the input path.

If there is an uncertainty about the ability of the supply to absorb this current, external zener diodes may be added to the supply pins as shown in Figure 35. The zener voltage must be selected such that the diode does not turn on during normal operation.

However, its zener voltage should be low enough so that the zener diode conducts if the supply pin begins to rise above the safe operating supply voltage level.

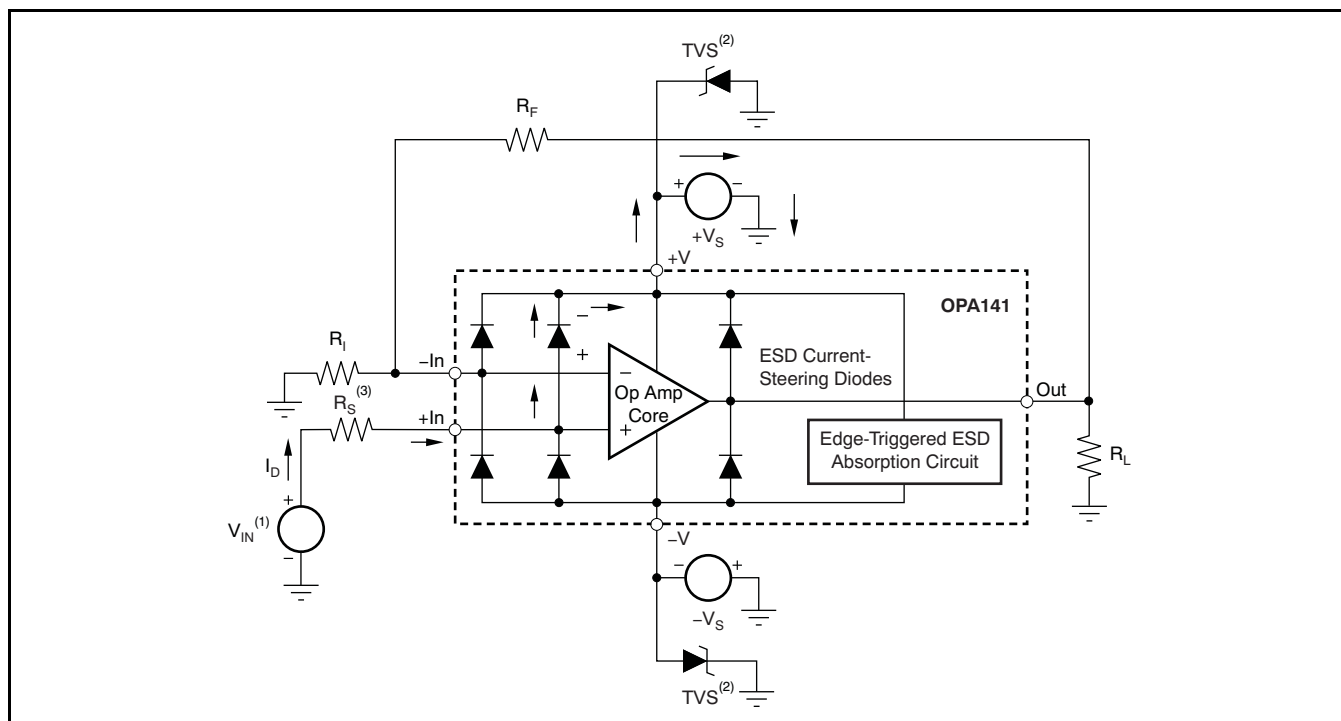

- (1) $V_{IN} = +V_S + 500\text{mV}$.
- (2) TVS: $+V_{S(\text{max})} > V_{\text{TVSBR}(\text{Min})} > +V_S$
- (3) Suggested value approximately 1k Ω .

Figure 35. Equivalent Internal ESD Circuitry and Its Relation to a Typical Circuit Application

PACKAGING INFORMATION

Orderable part number	Status (1)	Material type (2)	Package Pins	Package qty Carrier	RoHS (3)	Lead finish/ Ball material (4)	MSL rating/ Peak reflow (5)	Op temp (°C)	Part marking (6)
OPA141AID	Active	Production	SOIC (D) 8	75 TUBE	Yes	NIPDAU	Level-2-260C-1 YEAR	-40 to 125	O141A
OPA141AID.B	Active	Production	SOIC (D) 8	75 TUBE	Yes	NIPDAU	Level-2-260C-1 YEAR	-40 to 125	O141A
OPA141AIDGKR	Active	Production	VSSOP (DGK) 8	2500 LARGE T&R	Yes	Call TI Nipdauag Nipdau	Level-2-260C-1 YEAR	-40 to 125	141
OPA141AIDGKR.B	Active	Production	VSSOP (DGK) 8	2500 LARGE T&R	Yes	NIPDAU	Level-2-260C-1 YEAR	-40 to 125	141
OPA141AIDGKRG4	Active	Production	VSSOP (DGK) 8	2500 LARGE T&R	Yes	NIPDAU	Level-2-260C-1 YEAR	-40 to 125	141
OPA141AIDGKRG4.B	Active	Production	VSSOP (DGK) 8	2500 LARGE T&R	Yes	NIPDAU	Level-2-260C-1 YEAR	-40 to 125	141
OPA141AIDGKT	Active	Production	VSSOP (DGK) 8	250 SMALL T&R	Yes	Call TI Nipdauag Nipdau	Level-2-260C-1 YEAR	-40 to 125	141
OPA141AIDGKT.B	Active	Production	VSSOP (DGK) 8	250 SMALL T&R	Yes	NIPDAU	Level-2-260C-1 YEAR	-40 to 125	141
OPA141AIDR	Active	Production	SOIC (D) 8	2500 LARGE T&R	Yes	NIPDAU	Level-2-260C-1 YEAR	-40 to 125	O141A
OPA141AIDR.B	Active	Production	SOIC (D) 8	2500 LARGE T&R	Yes	NIPDAU	Level-2-260C-1 YEAR	-40 to 125	O141A
OPA141AIDRG4	Active	Production	SOIC (D) 8	2500 LARGE T&R	Yes	NIPDAU	Level-2-260C-1 YEAR	-40 to 125	O141A
OPA141AIDRG4.B	Active	Production	SOIC (D) 8	2500 LARGE T&R	Yes	NIPDAU	Level-2-260C-1 YEAR	-40 to 125	O141A
OPA2141AID	Active	Production	SOIC (D) 8	75 TUBE	Yes	NIPDAU	Level-2-260C-1 YEAR	-40 to 125	O2141A
OPA2141AID.B	Active	Production	SOIC (D) 8	75 TUBE	Yes	NIPDAU	Level-2-260C-1 YEAR	-40 to 125	O2141A
OPA2141AIDGKR	Active	Production	VSSOP (DGK) 8	2500 LARGE T&R	Yes	Call TI Nipdauag Nipdau	Level-2-260C-1 YEAR	-40 to 125	2141
OPA2141AIDGKR.B	Active	Production	VSSOP (DGK) 8	2500 LARGE T&R	Yes	NIPDAU	Level-2-260C-1 YEAR	-40 to 125	2141
OPA2141AIDGKRG4	Active	Production	VSSOP (DGK) 8	2500 LARGE T&R	Yes	NIPDAU	Level-2-260C-1 YEAR	-40 to 125	2141
OPA2141AIDGKRG4.B	Active	Production	VSSOP (DGK) 8	2500 LARGE T&R	Yes	NIPDAU	Level-2-260C-1 YEAR	-40 to 125	2141
OPA2141AIDGKT	Active	Production	VSSOP (DGK) 8	250 SMALL T&R	Yes	Call TI Nipdauag Nipdau	Level-2-260C-1 YEAR	-40 to 125	2141
OPA2141AIDGKT.B	Active	Production	VSSOP (DGK) 8	250 SMALL T&R	Yes	NIPDAU	Level-2-260C-1 YEAR	-40 to 125	2141
OPA2141AIDR	Active	Production	SOIC (D) 8	2500 LARGE T&R	Yes	NIPDAU	Level-2-260C-1 YEAR	-40 to 125	O2141A
OPA2141AIDR.B	Active	Production	SOIC (D) 8	2500 LARGE T&R	Yes	NIPDAU	Level-2-260C-1 YEAR	-40 to 125	O2141A
OPA4141AID	Active	Production	SOIC (D) 14	50 TUBE	Yes	NIPDAU	Level-2-260C-1 YEAR	-40 to 125	O4141A
OPA4141AID.B	Active	Production	SOIC (D) 14	50 TUBE	Yes	NIPDAU	Level-2-260C-1 YEAR	-40 to 125	O4141A
OPA4141AIDG4	Active	Production	SOIC (D) 14	50 TUBE	Yes	NIPDAU	Level-2-260C-1 YEAR	-40 to 125	O4141A
OPA4141AIDG4.B	Active	Production	SOIC (D) 14	50 TUBE	Yes	NIPDAU	Level-2-260C-1 YEAR	-40 to 125	O4141A

Orderable part number	Status (1)	Material type (2)	Package Pins	Package qty Carrier	RoHS (3)	Lead finish/ Ball material (4)	MSL rating/ Peak reflow (5)	Op temp (°C)	Part marking (6)
OPA4141AIDR	Active	Production	SOIC (D) 14	2500 LARGE T&R	Yes	NIPDAU	Level-2-260C-1 YEAR	-40 to 125	O4141A
OPA4141AIDR.B	Active	Production	SOIC (D) 14	2500 LARGE T&R	Yes	NIPDAU	Level-2-260C-1 YEAR	-40 to 125	O4141A
OPA4141AIPW	Active	Production	TSSOP (PW) 14	90 TUBE	Yes	NIPDAU	Level-2-260C-1 YEAR	-40 to 125	O4141A
OPA4141AIPW.B	Active	Production	TSSOP (PW) 14	90 TUBE	Yes	NIPDAU	Level-2-260C-1 YEAR	-40 to 125	O4141A
OPA4141AIPWG4	Active	Production	TSSOP (PW) 14	90 TUBE	Yes	NIPDAU	Level-2-260C-1 YEAR	-40 to 125	O4141A
OPA4141AIPWG4.B	Active	Production	TSSOP (PW) 14	90 TUBE	Yes	NIPDAU	Level-2-260C-1 YEAR	-40 to 125	O4141A
OPA4141AIPWR	Active	Production	TSSOP (PW) 14	2000 LARGE T&R	Yes	NIPDAU	Level-2-260C-1 YEAR	-40 to 125	O4141A
OPA4141AIPWR.B	Active	Production	TSSOP (PW) 14	2000 LARGE T&R	Yes	NIPDAU	Level-2-260C-1 YEAR	-40 to 125	O4141A

(1) **Status:** For more details on status, see our [product life cycle](#).

(2) **Material type:** When designated, preproduction parts are prototypes/experimental devices, and are not yet approved or released for full production. Testing and final process, including without limitation quality assurance, reliability performance testing, and/or process qualification, may not yet be complete, and this item is subject to further changes or possible discontinuation. If available for ordering, purchases will be subject to an additional waiver at checkout, and are intended for early internal evaluation purposes only. These items are sold without warranties of any kind.

(3) **RoHS values:** Yes, No, RoHS Exempt. See the [TI RoHS Statement](#) for additional information and value definition.

(4) **Lead finish/Ball material:** Parts may have multiple material finish options. Finish options are separated by a vertical ruled line. Lead finish/Ball material values may wrap to two lines if the finish value exceeds the maximum column width.

(5) **MSL rating/Peak reflow:** The moisture sensitivity level ratings and peak solder (reflow) temperatures. In the event that a part has multiple moisture sensitivity ratings, only the lowest level per JEDEC standards is shown. Refer to the shipping label for the actual reflow temperature that will be used to mount the part to the printed circuit board.

(6) **Part marking:** There may be an additional marking, which relates to the logo, the lot trace code information, or the environmental category of the part.

Multiple part markings will be inside parentheses. Only one part marking contained in parentheses and separated by a "-" will appear on a part. If a line is indented then it is a continuation of the previous line and the two combined represent the entire part marking for that device.

Important Information and Disclaimer:The information provided on this page represents TI's knowledge and belief as of the date that it is provided. TI bases its knowledge and belief on information provided by third parties, and makes no representation or warranty as to the accuracy of such information. Efforts are underway to better integrate information from third parties. TI has taken and continues to take reasonable steps to provide representative and accurate information but may not have conducted destructive testing or chemical analysis on incoming materials and chemicals. TI and TI suppliers consider certain information to be proprietary, and thus CAS numbers and other limited information may not be available for release.

In no event shall TI's liability arising out of such information exceed the total purchase price of the TI part(s) at issue in this document sold by TI to Customer on an annual basis.

TAPE AND REEL INFORMATION

QUADRANT ASSIGNMENTS FOR PIN 1 ORIENTATION IN TAPE

*All dimensions are nominal

Device	Package Type	Package Drawing	Pins	SPQ	Reel Diameter (mm)	Reel Width W1 (mm)	A0 (mm)	B0 (mm)	K0 (mm)	P1 (mm)	W (mm)	Pin1 Quadrant
OPA141AIDGKR	VSSOP	DGK	8	2500	330.0	12.4	5.3	3.4	1.4	8.0	12.0	Q1
OPA141AIDGKRG4	VSSOP	DGK	8	2500	330.0	12.4	5.3	3.4	1.4	8.0	12.0	Q1
OPA141AIDGKT	VSSOP	DGK	8	250	180.0	12.4	5.3	3.4	1.4	8.0	12.0	Q1
OPA141AIDR	SOIC	D	8	2500	330.0	12.4	6.4	5.2	2.1	8.0	12.0	Q1
OPA141AIDRG4	SOIC	D	8	2500	330.0	12.4	6.4	5.2	2.1	8.0	12.0	Q1
OPA2141AIDGKR	VSSOP	DGK	8	2500	330.0	12.4	5.3	3.4	1.4	8.0	12.0	Q1
OPA2141AIDGKRG4	VSSOP	DGK	8	2500	330.0	12.4	5.3	3.4	1.4	8.0	12.0	Q1
OPA2141AIDGKT	VSSOP	DGK	8	250	180.0	12.4	5.3	3.4	1.4	8.0	12.0	Q1
OPA2141AIDR	SOIC	D	8	2500	330.0	12.4	6.4	5.2	2.1	8.0	12.0	Q1
OPA4141AIDR	SOIC	D	14	2500	330.0	16.4	6.5	9.0	2.1	8.0	16.0	Q1
OPA4141AIPWR	TSSOP	PW	14	2000	330.0	12.4	6.9	5.6	1.6	8.0	12.0	Q1

TAPE AND REEL BOX DIMENSIONS

*All dimensions are nominal

Device	Package Type	Package Drawing	Pins	SPQ	Length (mm)	Width (mm)	Height (mm)
OPA141AIDGKR	VSSOP	DGK	8	2500	353.0	353.0	32.0
OPA141AIDGKRG4	VSSOP	DGK	8	2500	353.0	353.0	32.0
OPA141AIDGKT	VSSOP	DGK	8	250	213.0	191.0	35.0
OPA141AIDR	SOIC	D	8	2500	353.0	353.0	32.0
OPA141AIDRG4	SOIC	D	8	2500	353.0	353.0	32.0
OPA2141AIDGKR	VSSOP	DGK	8	2500	353.0	353.0	32.0
OPA2141AIDGKRG4	VSSOP	DGK	8	2500	353.0	353.0	32.0
OPA2141AIDGKT	VSSOP	DGK	8	250	213.0	191.0	35.0
OPA2141AIDR	SOIC	D	8	2500	353.0	353.0	32.0
OPA4141AIDR	SOIC	D	14	2500	353.0	353.0	32.0
OPA4141AIPWR	TSSOP	PW	14	2000	353.0	353.0	32.0

TUBE

*All dimensions are nominal

Device	Package Name	Package Type	Pins	SPQ	L (mm)	W (mm)	T (μm)	B (mm)
OPA141AID	D	SOIC	8	75	506.6	8	3940	4.32
OPA141AID.B	D	SOIC	8	75	506.6	8	3940	4.32
OPA2141AID	D	SOIC	8	75	506.6	8	3940	4.32
OPA2141AID.B	D	SOIC	8	75	506.6	8	3940	4.32
OPA4141AID	D	SOIC	14	50	506.6	8	3940	4.32
OPA4141AID.B	D	SOIC	14	50	506.6	8	3940	4.32
OPA4141AIDG4	D	SOIC	14	50	506.6	8	3940	4.32
OPA4141AIDG4.B	D	SOIC	14	50	506.6	8	3940	4.32
OPA4141AIPW	PW	TSSOP	14	90	508	8.5	3250	2.8
OPA4141AIPW.B	PW	TSSOP	14	90	508	8.5	3250	2.8
OPA4141AIPWG4	PW	TSSOP	14	90	508	8.5	3250	2.8
OPA4141AIPWG4.B	PW	TSSOP	14	90	508	8.5	3250	2.8

DGK0008A



PACKAGE OUTLINE

VSSOP - 1.1 mm max height

SMALL OUTLINE PACKAGE



4214862/A 04/2023

NOTES:

PowerPAD is a trademark of Texas Instruments.

1. All linear dimensions are in millimeters. Any dimensions in parenthesis are for reference only. Dimensioning and tolerancing per ASME Y14.5M.
2. This drawing is subject to change without notice.
3. This dimension does not include mold flash, protrusions, or gate burrs. Mold flash, protrusions, or gate burrs shall not exceed 0.15 mm per side.
4. This dimension does not include interlead flash. Interlead flash shall not exceed 0.25 mm per side.
5. Reference JEDEC registration MO-187.

EXAMPLE BOARD LAYOUT

DGK0008A

™ VSSOP - 1.1 mm max height

SMALL OUTLINE PACKAGE



LAND PATTERN EXAMPLE
EXPOSED METAL SHOWN
SCALE: 15X



SOLDER MASK DETAILS

4214862/A 04/2023

NOTES: (continued)

6. Publication IPC-7351 may have alternate designs.
7. Solder mask tolerances between and around signal pads can vary based on board fabrication site.
8. Vias are optional depending on application, refer to device data sheet. If any vias are implemented, refer to their locations shown on this view. It is recommended that vias under paste be filled, plugged or tented.
9. Size of metal pad may vary due to creepage requirement.

EXAMPLE STENCIL DESIGN

DGK0008A

TM VSSOP - 1.1 mm max height

SMALL OUTLINE PACKAGE



SOLDER PASTE EXAMPLE
SCALE: 15X

4214862/A 04/2023

NOTES: (continued)

11. Laser cutting apertures with trapezoidal walls and rounded corners may offer better paste release. IPC-7525 may have alternate design recommendations.
12. Board assembly site may have different recommendations for stencil design.



D0014A

PACKAGE OUTLINE

SOIC - 1.75 mm max height

SMALL OUTLINE INTEGRATED CIRCUIT



4220718/A 09/2016

NOTES:

1. All linear dimensions are in millimeters. Dimensions in parenthesis are for reference only. Dimensioning and tolerancing per ASME Y14.5M.
2. This drawing is subject to change without notice.
3. This dimension does not include mold flash, protrusions, or gate burrs. Mold flash, protrusions, or gate burrs shall not exceed 0.15 mm, per side.
4. This dimension does not include interlead flash. Interlead flash shall not exceed 0.43 mm, per side.
5. Reference JEDEC registration MS-012, variation AB.

EXAMPLE BOARD LAYOUT

D0014A

SOIC - 1.75 mm max height

SMALL OUTLINE INTEGRATED CIRCUIT



LAND PATTERN EXAMPLE
SCALE:8X



SOLDER MASK DETAILS

4220718/A 09/2016

NOTES: (continued)

- 6. Publication IPC-7351 may have alternate designs.
- 7. Solder mask tolerances between and around signal pads can vary based on board fabrication site.

EXAMPLE STENCIL DESIGN

D0014A

SOIC - 1.75 mm max height

SMALL OUTLINE INTEGRATED CIRCUIT



SOLDER PASTE EXAMPLE
BASED ON 0.125 mm THICK STENCIL
SCALE:8X

4220718/A 09/2016

NOTES: (continued)

8. Laser cutting apertures with trapezoidal walls and rounded corners may offer better paste release. IPC-7525 may have alternate design recommendations.
9. Board assembly site may have different recommendations for stencil design.



D0008A

PACKAGE OUTLINE

SOIC - 1.75 mm max height

SMALL OUTLINE INTEGRATED CIRCUIT



4214825/C 02/2019

NOTES:

- Linear dimensions are in inches [millimeters]. Dimensions in parenthesis are for reference only. Controlling dimensions are in inches. Dimensioning and tolerancing per ASME Y14.5M.
- This drawing is subject to change without notice.
- This dimension does not include mold flash, protrusions, or gate burrs. Mold flash, protrusions, or gate burrs shall not exceed $.006$ [0.15] per side.
- This dimension does not include interlead flash.
- Reference JEDEC registration MS-012, variation AA.

EXAMPLE BOARD LAYOUT

D0008A

SOIC - 1.75 mm max height

SMALL OUTLINE INTEGRATED CIRCUIT



LAND PATTERN EXAMPLE
 EXPOSED METAL SHOWN
 SCALE:8X



SOLDER MASK DETAILS

4214825/C 02/2019

NOTES: (continued)

- 6. Publication IPC-7351 may have alternate designs.
- 7. Solder mask tolerances between and around signal pads can vary based on board fabrication site.

EXAMPLE STENCIL DESIGN

D0008A

SOIC - 1.75 mm max height

SMALL OUTLINE INTEGRATED CIRCUIT



SOLDER PASTE EXAMPLE
BASED ON .005 INCH [0.125 MM] THICK STENCIL
SCALE:8X

4214825/C 02/2019

NOTES: (continued)

8. Laser cutting apertures with trapezoidal walls and rounded corners may offer better paste release. IPC-7525 may have alternate design recommendations.
9. Board assembly site may have different recommendations for stencil design.

PW0014A

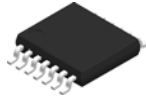

PACKAGE OUTLINE
TSSOP - 1.2 mm max height

SMALL OUTLINE PACKAGE

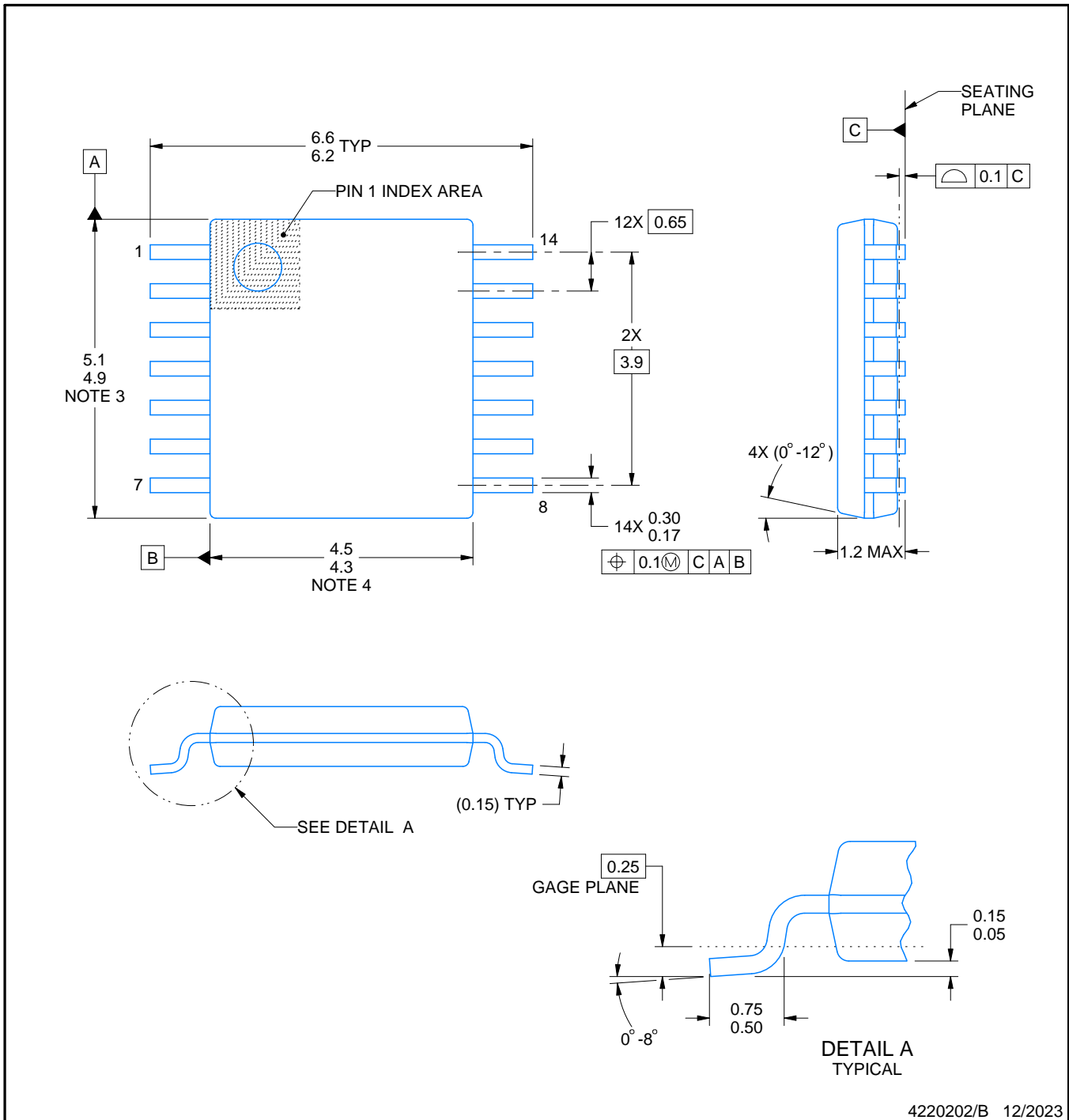

4220202/B 12/2023

NOTES:

1. All linear dimensions are in millimeters. Any dimensions in parenthesis are for reference only. Dimensioning and tolerancing per ASME Y14.5M.
2. This drawing is subject to change without notice.
3. This dimension does not include mold flash, protrusions, or gate burrs. Mold flash, protrusions, or gate burrs shall not exceed 0.15 mm per side.
4. This dimension does not include interlead flash. Interlead flash shall not exceed 0.25 mm per side.
5. Reference JEDEC registration MO-153.

EXAMPLE BOARD LAYOUT

PW0014A

TSSOP - 1.2 mm max height

SMALL OUTLINE PACKAGE



LAND PATTERN EXAMPLE
EXPOSED METAL SHOWN
SCALE: 10X



SOLDER MASK DETAILS

4220202/B 12/2023

NOTES: (continued)

6. Publication IPC-7351 may have alternate designs.
7. Solder mask tolerances between and around signal pads can vary based on board fabrication site.

EXAMPLE STENCIL DESIGN

PW0014A

TSSOP - 1.2 mm max height

SMALL OUTLINE PACKAGE



SOLDER PASTE EXAMPLE
BASED ON 0.125 mm THICK STENCIL
SCALE: 10X

4220202/B 12/2023

NOTES: (continued)

8. Laser cutting apertures with trapezoidal walls and rounded corners may offer better paste release. IPC-7525 may have alternate design recommendations.
9. Board assembly site may have different recommendations for stencil design.

IMPORTANT NOTICE AND DISCLAIMER

TI PROVIDES TECHNICAL AND RELIABILITY DATA (INCLUDING DATASHEETS), DESIGN RESOURCES (INCLUDING REFERENCE DESIGNS), APPLICATION OR OTHER DESIGN ADVICE, WEB TOOLS, SAFETY INFORMATION, AND OTHER RESOURCES "AS IS" AND WITH ALL FAULTS, AND DISCLAIMS ALL WARRANTIES, EXPRESS AND IMPLIED, INCLUDING WITHOUT LIMITATION ANY IMPLIED WARRANTIES OF MERCHANTABILITY, FITNESS FOR A PARTICULAR PURPOSE OR NON-INFRINGEMENT OF THIRD PARTY INTELLECTUAL PROPERTY RIGHTS.

These resources are intended for skilled developers designing with TI products. You are solely responsible for (1) selecting the appropriate TI products for your application, (2) designing, validating and testing your application, and (3) ensuring your application meets applicable standards, and any other safety, security, regulatory or other requirements.

These resources are subject to change without notice. TI grants you permission to use these resources only for development of an application that uses the TI products described in the resource. Other reproduction and display of these resources is prohibited. No license is granted to any other TI intellectual property right or to any third party intellectual property right. TI disclaims responsibility for, and you fully indemnify TI and its representatives against any claims, damages, costs, losses, and liabilities arising out of your use of these resources.

TI's products are provided subject to [TI's Terms of Sale](#), [TI's General Quality Guidelines](#), or other applicable terms available either on ti.com or provided in conjunction with such TI products. TI's provision of these resources does not expand or otherwise alter TI's applicable warranties or warranty disclaimers for TI products. Unless TI explicitly designates a product as custom or customer-specified, TI products are standard, catalog, general purpose devices.

TI objects to and rejects any additional or different terms you may propose.

Copyright © 2026, Texas Instruments Incorporated

Last updated 10/2025