

CLASS V 2x2 LVDS CROSSPOINT SWITCH

 Check for Samples: [SN55LVCP22-SP](#)

FEATURES

- High Speed (>1000 Mbps) Upgrade for DS90CP22 2x2 LVDS Crosspoint Switch
- Low-Jitter Fully Differential Data Path
- 50 ps (Typ), of Peak-to-Peak Jitter With PRBS = $2^{23}-1$ Pattern
- Less Than 200 mW (Typ), 300 mW (Max) Total Power Dissipation
- Output (Channel-to-Channel) Skew Is 80 ps (Typ)
- Configurable as 2:1 Mux, 1:2 Demux, Repeater or 1:2 Signal Splitter
- Inputs Accept LVDS, LVPECL, and CML Signals
- Fast Switch Time of 1.7 ns (Typ)
- Fast Propagation Delay of 0.65 ns (Typ)
- Available in 16 pin CFP Package
- Inter-Operates With TIA/EIA-644-A LVDS Standard
- Military Temperature Range: -55°C to 125°C

APPLICATIONS

- Base Stations
- Add/Drop Muxes
- Protection Switching for Serial Backplanes
- Network Switches/Routers
- Optical Networking Line Cards/Switches
- Clock Distribution
- Engineering Evaluation (/EM) Samples are Available ⁽¹⁾

- (1) These units are intended for engineering evaluation only. They are processed to a non-compliant flow (e.g. no burn-in, etc.) and are tested to temperature rating of 25°C only. These units are not suitable for qualification, production, radiation testing or flight use. Parts are not warranted for performance on full MIL specified temperature range of -55°C to 125°C or operating life.

DESCRIPTION

The SN55LVCP22 is a 2x2 crosspoint switch providing greater than 1000 Mbps operation for each path. The dual channels incorporate wide common-mode (0 V to 4 V) receivers, allowing for the receipt of LVDS, LVPECL, and CML signals. The dual outputs are LVDS drivers to provide low-power, low-EMI, high-speed operation. The SN55LVCP22 provides a single device supporting 2:2 buffering (repeating), 1:2 splitting, 2:1 multiplexing, 2x2 switching, and LVPECL/CML to LVDS level translation on each channel. The flexible operation of the SN55LVCP22 provides a single device to support the redundant serial bus transmission needs (working and protection switching cards) of fault-tolerant switch systems found in optical networking, wireless infrastructure, and data communications systems. TI offers additional gigabit repeater/ translator and crosspoint products in the SN65LVDS100 and SN65LVDS122.

The SN55LVCP22 uses a fully differential data path to ensure low-noise generation, fast switching times, low pulse width distortion, and low jitter. Output channel-to-channel skew is 80 ps (typ) to ensure accurate alignment of outputs in all applications. Both SOIC and TSSOP package options are available to allow easy upgrade for existing solutions, and board area savings where space is critical.

OUTPUTS OPERATING SIMULTANEOUSLY

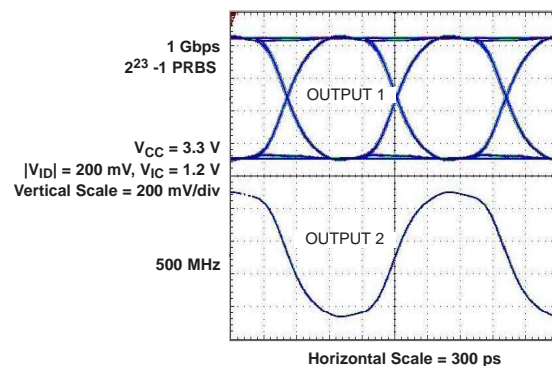

Please be aware that an important notice concerning availability, standard warranty, and use in critical applications of Texas Instruments semiconductor products and disclaimers thereto appears at the end of this data sheet.

SN55LVCP22-SP

SLLSE43A – JUNE 2012 – REVISED JANUARY 2014

www.ti.com



This integrated circuit can be damaged by ESD. Texas Instruments recommends that all integrated circuits be handled with appropriate precautions. Failure to observe proper handling and installation procedures can cause damage.

ESD damage can range from subtle performance degradation to complete device failure. Precision integrated circuits may be more susceptible to damage because very small parametric changes could cause the device not to meet its published specifications.

THERMAL CHARACTERISTICS

PARAMETER		TEST CONDITIONS		VALUE	UNITS
θ_{JA}	Junction-to-ambient thermal resistance			82.5	°C/W
θ_{JC}	Junction-to-case thermal resistance			7.5	°C/W
P_D	Device power dissipation	Typical	$V_{CC} = 3.3\text{ V}, T_A = 25^\circ\text{C}, 1\text{ Gbps}$	198	mW
		Maximum	$V_{CC} = 3.6\text{ V}, T_A = 125^\circ\text{C}, 1\text{ Gbps}$	313	

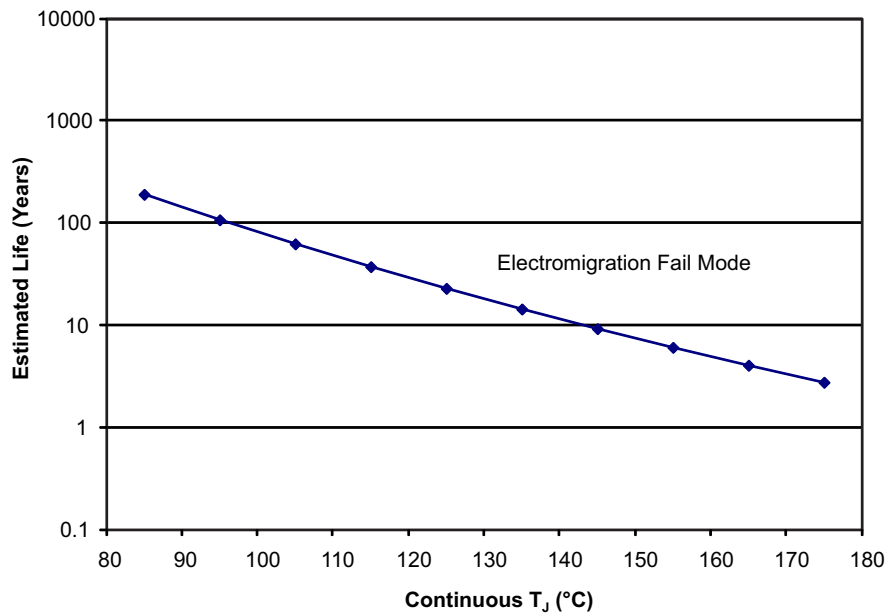

- A. See datasheet for absolute maximum and minimum recommended operating conditions.
- B. Silicon operating life design goal is 10 years at 105°C junction temperature (does not include package interconnect life).
- C. The predicted operating lifetime vs. junction temperature is based on reliability modeling using electromigration as the dominant failure mechanism affecting device wearout for the specific device process and design characteristics.

Figure 1. SN55LVCP22-SP Operating Life Derating Chart

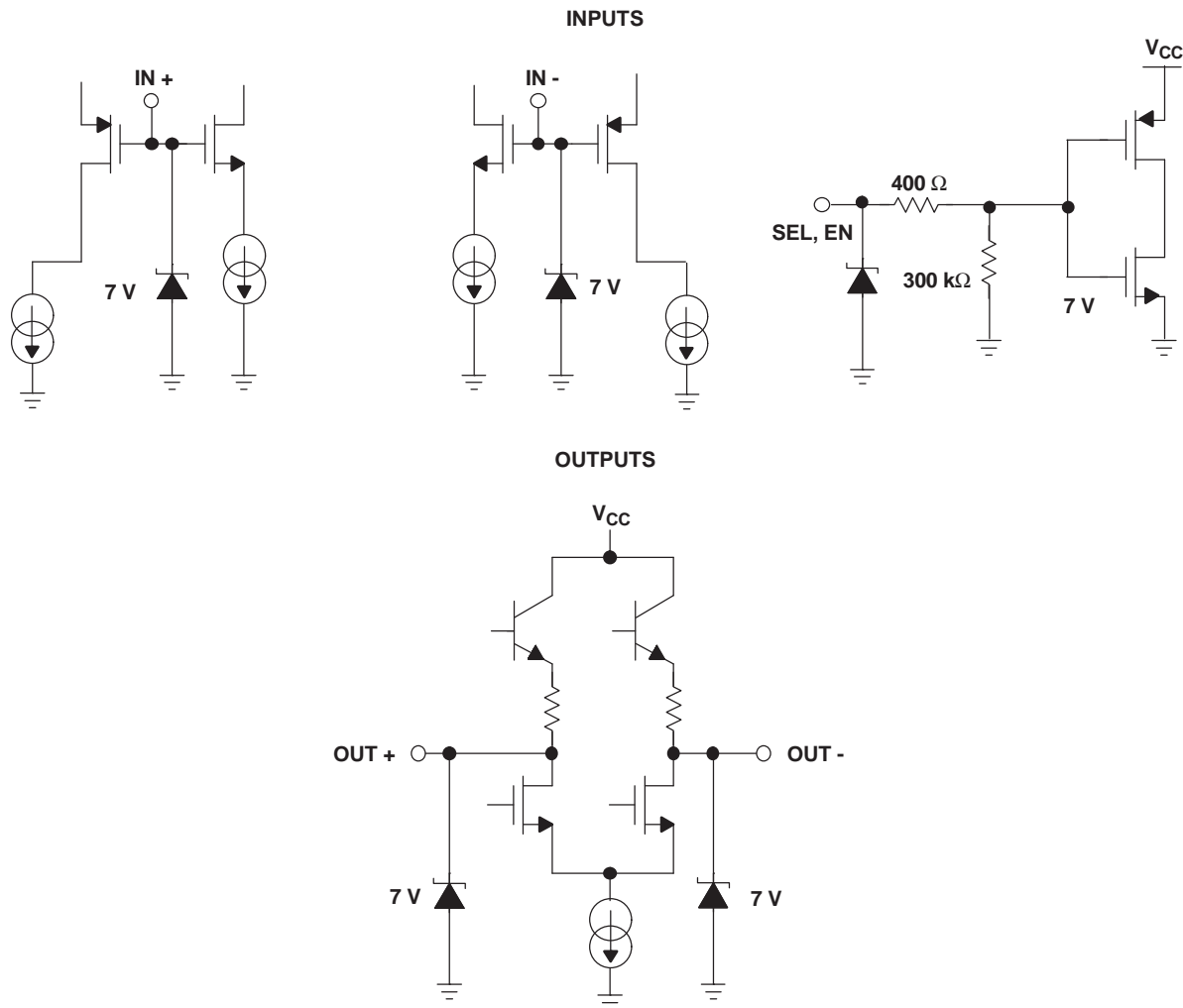
EQUIVALENT INPUT AND OUTPUT SCHEMATIC DIAGRAMS

ABSOLUTE MAXIMUM RATINGS

 over operating free-air temperature range unless otherwise noted⁽¹⁾

		UNITS
Supply voltage ⁽²⁾ range, V_{CC}		–0.5 V to 4 V
CMOS/TTL input voltage (ENO, EN1, SEL0, SEL1)		–0.5 V to 4 V
LVDS receiver input voltage (IN+, IN–)		–0.7 V to 4.3 V
LVDS driver output voltage (OUT+, OUT–)		–0.5 V to 4 V
LVDS output short circuit current		Continuous
Storage temperature range		–65°C to 125°C
Maximum Junction temperature		150°C
Electrostatic discharge	Human body model ⁽³⁾	All pins ±5 kV
	Charged-device mode ⁽⁴⁾	All pins ±500 V

- (1) Stresses beyond those listed under *absolute maximum ratings* may cause permanent damage to the device. These are stress ratings only, and functional operation of the device at these or any other conditions beyond those indicated under *recommended operating conditions* is not implied. Exposure to absolute-maximum-rated conditions for extended periods may affect device reliability.
- (2) All voltage values, except differential I/O bus voltages, are with respect to network ground terminals.
- (3) Tested in accordance with JEDEC Standard 22, Test Method A114-A.
- (4) Tested in accordance with JEDEC Standard 22, Test Method C101.

RECOMMENDED OPERATING CONDITIONS

	MIN	NOM	MAX	UNIT
Supply voltage, V_{CC}	3	3.3	3.6	V
Receiver input voltage	0		4	V
Operating Case Temperature range, T_C ⁽¹⁾	-55		125	°C
Magnitude of differential input voltage $ V_{ID} $	0.1		3	V

(1) Maximum case temperature operation is allowed as long as the device maximum junction temperature is not exceeded.

INPUT ELECTRICAL CHARACTERISTICS

over recommended operating conditions unless otherwise noted

PARAMETER	TEST CONDITIONS	MIN	TYP ⁽¹⁾	MAX	UNIT
CMOS/TTL DC SPECIFICATIONS (EN0, EN1, SEL0, SEL1)					
V_{IH} High-level input voltage		2		V_{CC}	V
V_{IL} Low-level input voltage		GND		0.8	V
I_{IH} High-level input current	$V_{IN} = 3.6\text{ V or }2.0\text{ V}, V_{CC} = 3.6\text{ V}$	-25	±3	25	µA
I_{IL} Low-level input current	$V_{IN} = 0.0\text{ V or }0.8\text{ V}, V_{CC} = 3.6\text{ V}$	-15	±1	15	µA
V_{CL} Input clamp voltage	$I_{CL} = -18\text{ mA}$		-0.8	-1.5	V
LVDS OUTPUT SPECIFICATIONS (OUT0, OUT1)					
$ V_{OD} $ Differential output voltage	$R_L = 75\ \Omega$, See Figure 3	255	365	475	mV
	$R_L = 75\ \Omega$, $V_{CC} = 3.3\text{ V}$, $T_A = 25^\circ\text{C}$, See Figure 3	285	365	440	
$\Delta V_{OD} $ Change in differential output voltage magnitude between logic states	$V_{ID} = \pm 100\text{ mV}$, See Figure 3	-25		25	mV
V_{OS} Steady-state offset voltage	See Figure 4	1	1.2	1.45	V
ΔV_{OS} Change in steady-state offset voltage between logic states	See Figure 4	-25		25	mV
$V_{OC(PP)}$ Peak-to-peak common-mode output voltage	See Figure 4		50		mV
I_{OZ} High-impedance output current	$V_{OUT} = \text{GND or } V_{CC}$	-15		15	µA
I_{OFF} Power-off leakage current	$V_{CC} = 0\text{ V}, 1.5\text{ V}; V_{OUT} = 3.6\text{ V or GND}$	-15		15	µA
I_{OS} Output short-circuit current	V_{OUT+} or $V_{OUT-} = 0\text{ V}$			-8	mA
I_{OSB} Both outputs short-circuit current	V_{OUT+} and $V_{OUT-} = 0\text{ V}$	-8		8	mA
C_O Differential output capacitance	$V_I = 0.4 \sin(4E6\pi t) + 0.5\text{ V}$		3		pF
LVDS RECEIVER DC SPECIFICATIONS (IN0, IN1)					
V_{TH} Positive-going differential input voltage threshold	See Figure 2 and Table 2			100	mV
V_{TL} Negative-going differential input voltage threshold	See Figure 2 and Table 2	-100			mV
$V_{ID(HYS)}$ Differential input voltage hysteresis			25	150	mV
V_{CMR} Common-mode voltage range	$V_{ID} = 100\text{ mV}, V_{CC} = 3.0\text{ V to }3.6\text{ V}$	0.05		3.95	V
I_{IN} Input current	$V_{IN} = 4\text{ V}, V_{CC} = 3.6\text{ V or }0.0$	-18	±1	18	µA
	$V_{IN} = 0\text{ V}, V_{CC} = 3.6\text{ V or }0.0$	-18	±1	18	
C_{IN} Differential input capacitance	$V_I = 0.4 \sin(4E6\pi t) + 0.5\text{ V}$		3		pF
SUPPLY CURRENT					
I_{CCQ} Quiescent supply current	$R_L = 75\ \Omega$, EN0=EN1=High		60	87	mA
I_{CCD} Total supply current	$R_L = 75\ \Omega$, $C_L = 5\text{ pF}$, 500 MHz (1000 Mbps), EN0=EN1=High		63	87	mA
I_{CCZ} 3-state supply current	EN0 = EN1 = Low		25	35	mA

(1) All typical values are at 25°C and with a 3.3-V supply.

SN55LVCP22-SP

SLLSE43A – JUNE 2012 – REVISED JANUARY 2014

www.ti.com

SWITCHING CHARACTERISTICS

over recommended operating conditions unless otherwise noted

parameter		TEST CONDITIONS	MIN	TYP	MAX	UNIT
t_{SET}	Input to SEL setup time	See Figure 7	2.2	0.8		ns
t_{HOLD}	Input to SEL hold time	See Figure 7	2.2	1.0		ns
t_{SWITCH}	SEL to switched output	See Figure 7		1.7	2.6	ns
t_{PHZ}	Disable time, high-level-to-high-impedance	See Figure 6		2	8	ns
t_{PLZ}	Disable time, low-level-to-high-impedance	See Figure 6		2	8	ns
t_{PZH}	Enable time, high-impedance -to-high-level output	See Figure 6		2	8	ns
t_{PZL}	Enable time, high-impedance-to-low-level output	See Figure 6		2	8	ns
t_{LHT}	Differential output signal rise time (20%-80%) ⁽¹⁾	$C_L = 5$ pF, See Figure 5		280	620	ps
t_{HLT}	Differential output signal fall time (20%-80%) ⁽¹⁾	$C_L = 5$ pF, See Figure 5		280	620	ps
t_{JIT}	Added peak-to-peak jitter	$V_{ID} = 200$ mV, 50% duty cycle, $V_{CM} = 1.2$ V, 50 MHz, $C_L = 5$ pF		13.7	22.2	ps
		$V_{ID} = 200$ mV, 50% duty cycle, $V_{CM} = 1.2$ V, 240 MHz, $C_L = 5$ pF		13.4	24.5	
		$V_{ID} = 200$ mV, 50% duty cycle, $V_{CM} = 1.2$ V, 500 MHz, $C_L = 5$ pF		14.4	35.7	
		$V_{ID} = 200$ mV, PRBS = $2^{15}-1$ data pattern, $V_{CM} = 1.2$ V, 240 Mbps, $C_L = 5$ pF		68.3	204	ps
		$V_{ID} = 200$ mV, PRBS = $2^{15}-1$ data pattern, $V_{CM} = 1.2$ V, 1000 Mbps, $C_L = 5$ pF		73.2	282	
t_{Jrms}	Added random jitter (rms)	$V_{ID} = 200$ mV, 50% duty cycle, $V_{CM} = 1.2$ V, 50 MHz, $C_L = 5$ pF		0.97	1.5	ps _{RMS}
		$V_{ID} = 200$ mV, 50% duty cycle, $V_{CM} = 1.2$ V, 240 MHz, $C_L = 5$ pF		0.85	1.53	
		$V_{ID} = 200$ mV, 50% duty cycle, $V_{CM} = 1.2$ V, 500 MHz, $C_L = 5$ pF		0.86	1.79	
t_{PLHD}	Propagation delay time, low-to-high-level output ⁽¹⁾		200	650	2350	ps
t_{PHLD}	Propagation delay time, high-to-low-level output ⁽¹⁾		200	650	2350	ps
$t_{skew}^{(2)}$	Pulse skew ($ t_{PLHD} - t_{PHLD} $) ⁽³⁾	$C_L = 5$ pF, See Figure 5		45	160	ps
t_{CCS}	Output channel-to-channel skew, splitter mode	$C_L = 5$ pF, See Figure 5		80		ps
$f_{MAX}^{(2)}$	Maximum operating frequency ⁽⁴⁾		1			GHz

(1) Input: $V_{IC} = 1.2$ V, $V_{ID} = 200$ mV, 50% duty cycle, 1 MHz, $t_r/t_f = 500$ ps

(2) t_{skew} and f_{MAX} parameters are guaranteed by characterization, but not production tested.

(3) t_{skew} is the magnitude of the time difference between the t_{PLHD} and t_{PHLD} of any output of a single device.

(4) Signal generator conditions: 50% duty cycle, t_r or $t_f \leq 100$ ps (10% to 90%), transmitter output criteria: duty cycle = 45% to 55% $V_{OD} \geq 300$ mV.

PIN ASSIGNMENTS

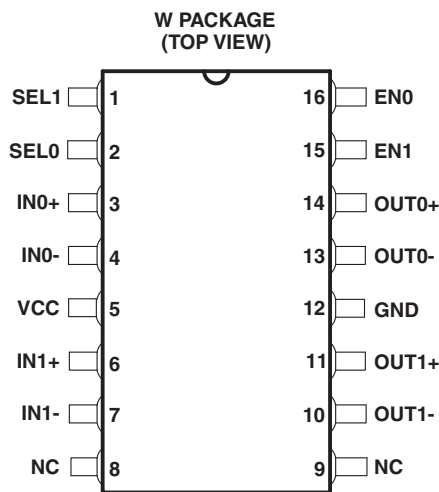

NC - No internal connection

PARAMETER MEASUREMENT INFORMATION

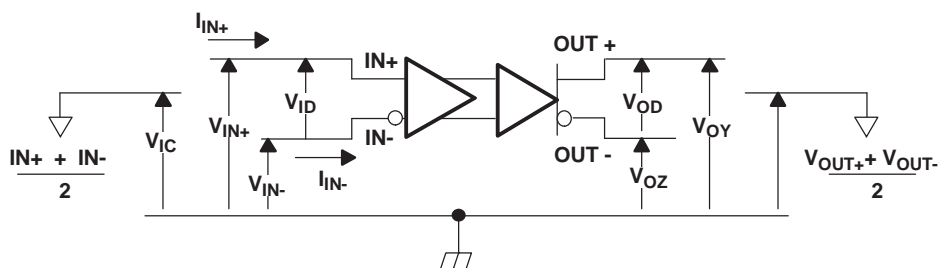

Figure 2. Voltage and Current Definitions

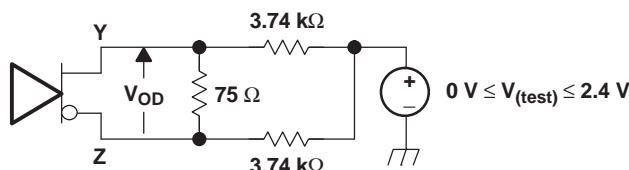
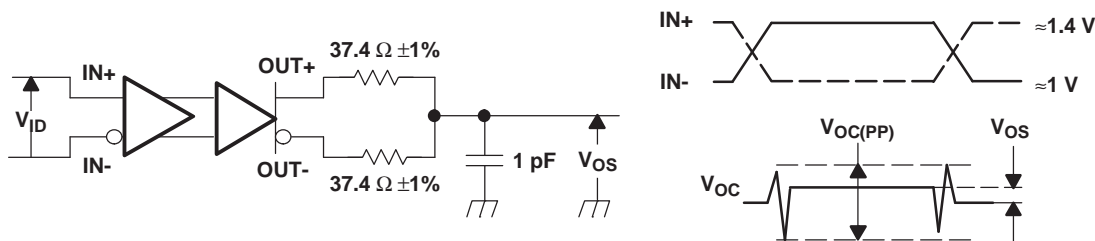

Figure 3. Differential Output Voltage (V_{OD}) Test Circuit



NOTE: All input pulses are supplied by a generator having the following characteristics: t_r or $t_f \leq 1$ ns, pulse-repetition rate (PRR) = 0.5 Mpps, pulse width = 500 ± 10 ns; $R_L = 100 \Omega$; C_L includes instrumentation and fixture capacitance within 0,06 mm of the D.U.T.; the measurement of $V_{OC(PP)}$ is made on test equipment with a -3 dB bandwidth of at least 300 MHz.

Figure 4. Test Circuit and Definitions for the Driver Common-Mode Output Voltage

PARAMETER MEASUREMENT INFORMATION (continued)

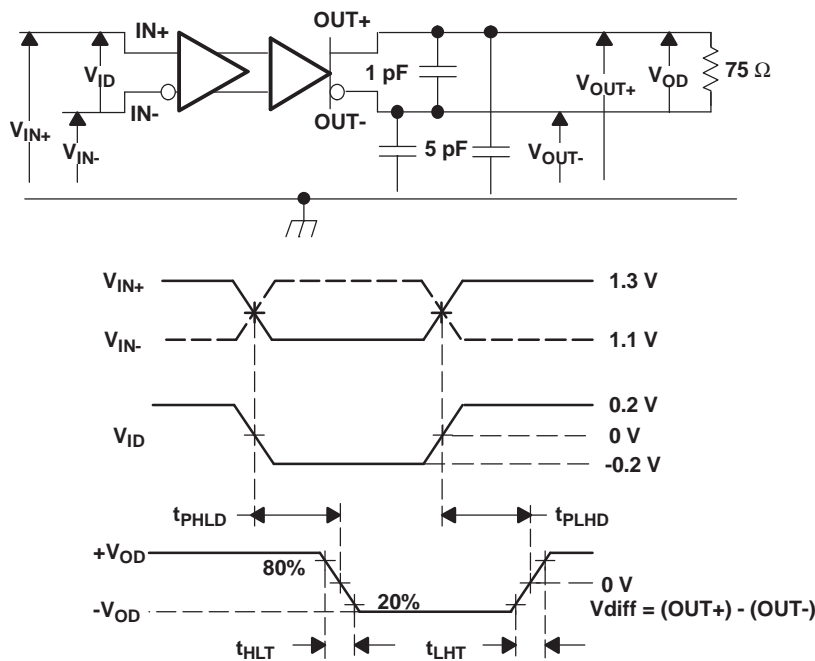

NOTE: All input pulses are supplied by a generator having the following characteristics: t_r or $t_f \leq .25$ ns, pulse-repetition rate (PRR) = 0.5 Mpps, pulse width = 500 ± 10 ns. C_L includes instrumentation and fixture capacitance within 0,06 mm of the D.U.T.

Figure 5. Timing Test Circuit and Waveforms

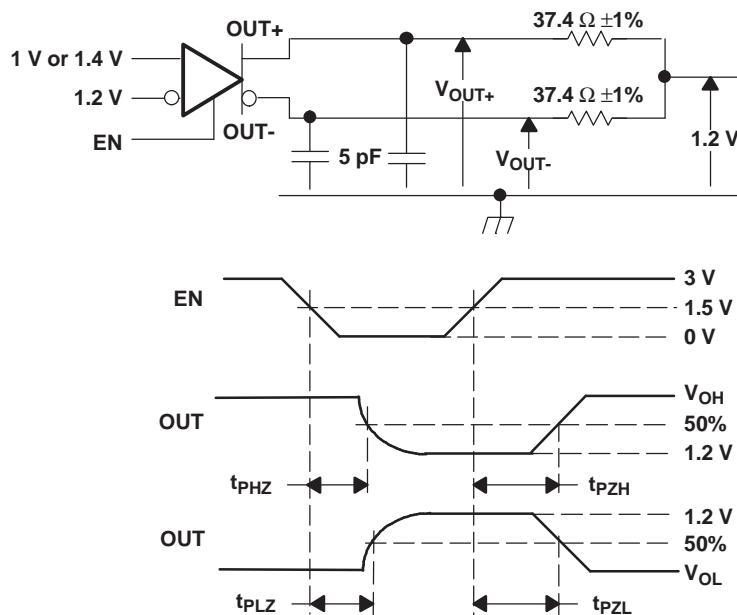

NOTE: All input pulses are supplied by a generator having the following characteristics: t_r or $t_f \leq 1$ ns, pulse-repetition rate (PRR) = 0.5 Mpps, pulse width = 500 ± 10 ns. C_L includes instrumentation and fixture capacitance within 0,06 mm of the D.U.T.

Figure 6. Enable and Disable Time Circuit and Definitions

Table 2. Receiver Input Voltage Threshold Test

APPLIED VOLTAGES		RESULTING DIFFERENTIAL INPUT VOLTAGE	RESULTING COMMON- MODE INPUT VOLTAGE	OUTPUT ⁽¹⁾
V_{IA}	V_{IB}	V_{ID}	V_{IC}	
1.25 V	1.15 V	100 mV	1.2 V	H
1.15 V	1.25 V	-100 mV	1.2 V	L
4.0 V	3.9 V	100 mV	3.95 V	H
3.9 V	4.0 V	-100 mV	3.95 V	L
0.1 V	0.0 V	100 mV	0.05 V	H
0.0 V	0.1 V	-100 mV	0.05 V	L
1.7 V	0.7 V	1000 mV	1.2 V	H
0.7 V	1.7 V	-1000 mV	1.2 V	L
4.0 V	3.0 V	1000 mV	3.5 V	H
3.0 V	4.0 V	-1000 mV	3.5 V	L
1.0 V	0.0 V	1000 mV	0.5 V	H
0.0 V	1.0 V	-1000 mV	0.5 V	L

(1) H = high level, L = low level

SN55LVCP22-SP

SLLSE43A – JUNE 2012 – REVISED JANUARY 2014

www.ti.com

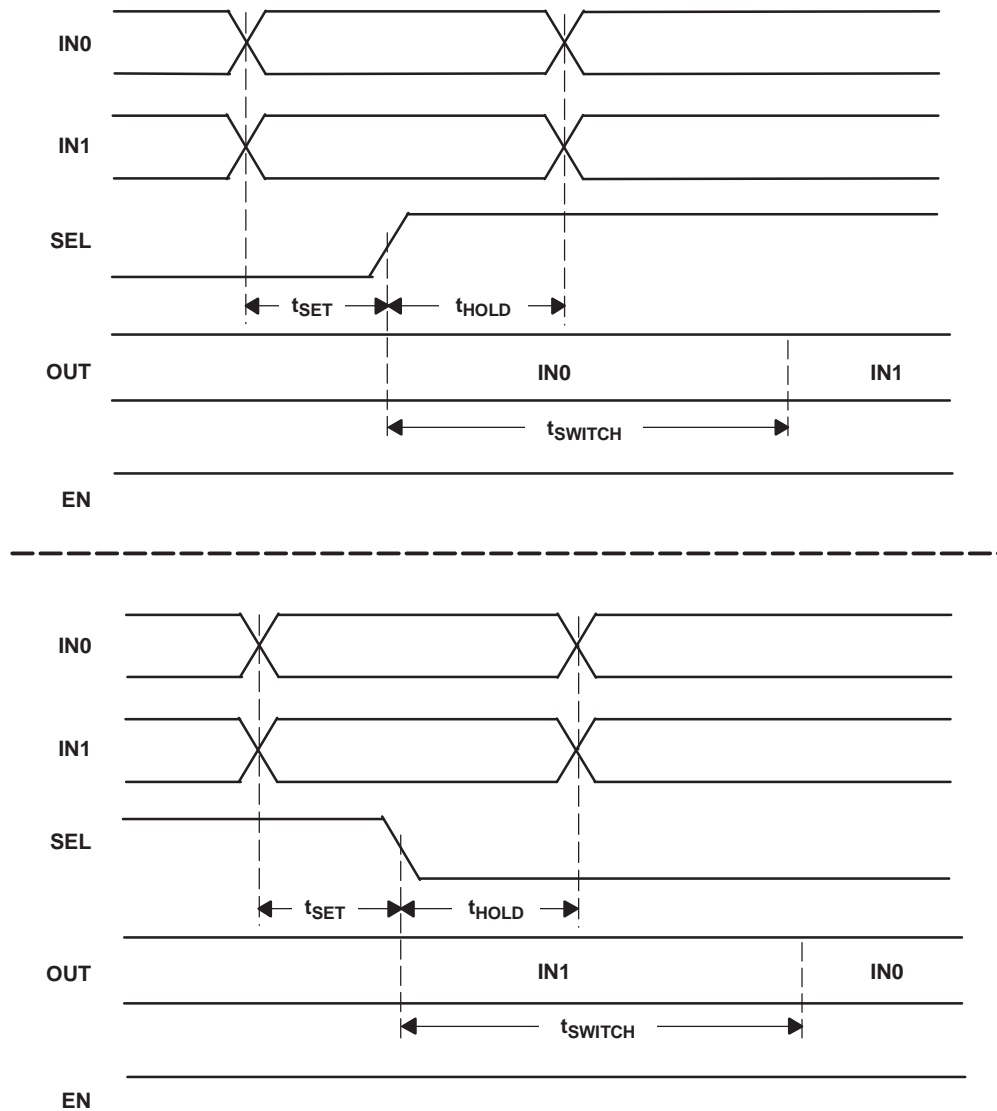

NOTE: t_{SET} and t_{HOLD} times specify that data must be in a stable state before and after mux control switches.

Figure 7. Input to Select for Both Rising and Falling Edge Setup and Hold Times

TYPICAL CHARACTERISTICS

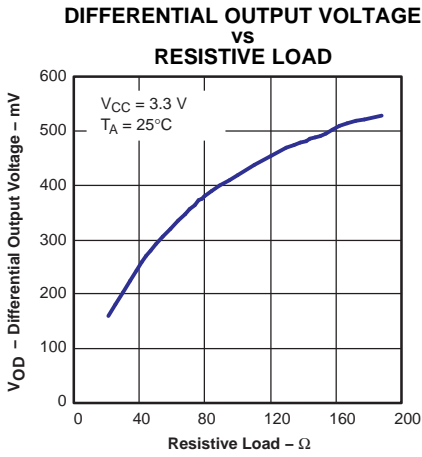

Figure 8.

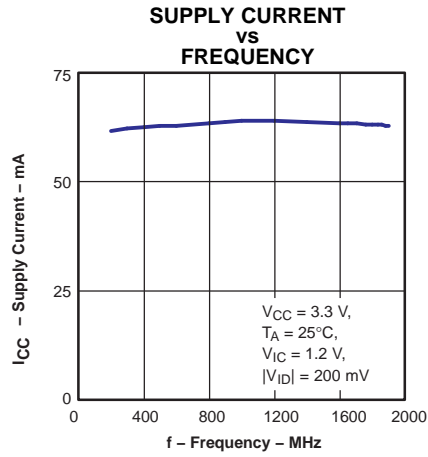

Figure 9.

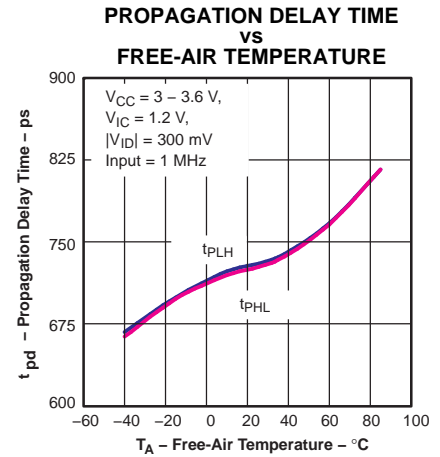

Figure 10.

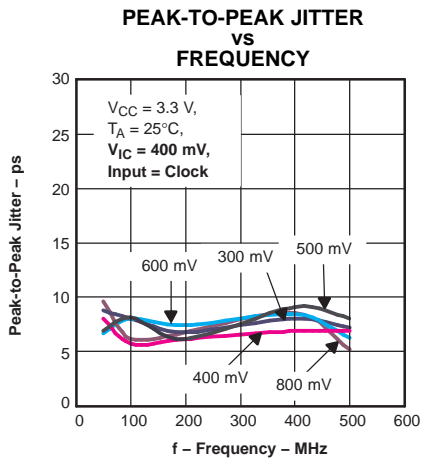

Figure 11.

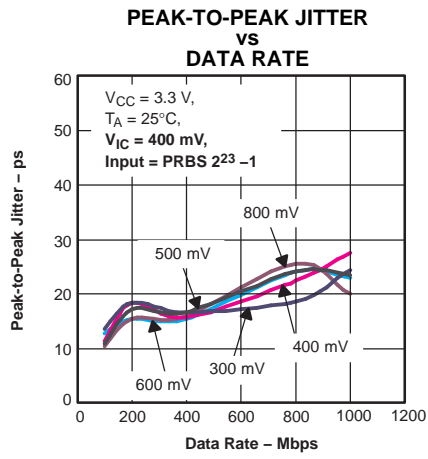

Figure 12.

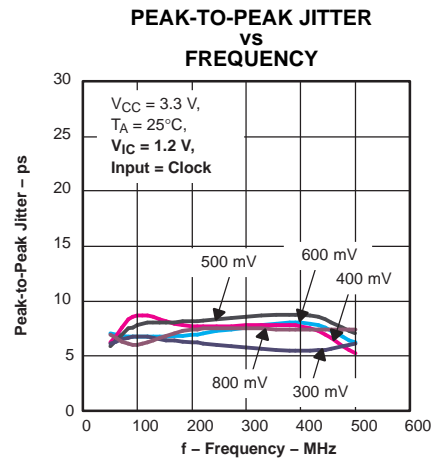

Figure 13.

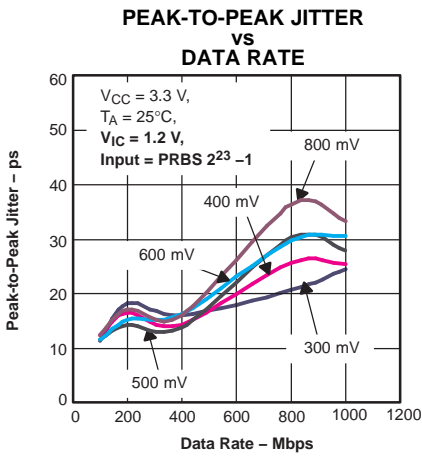

Figure 14.

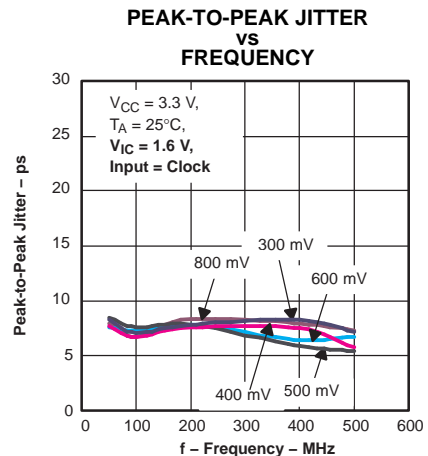

Figure 15.

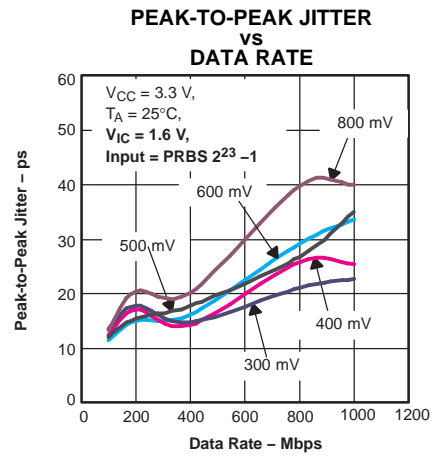

Figure 16.

TYPICAL CHARACTERISTICS (continued)

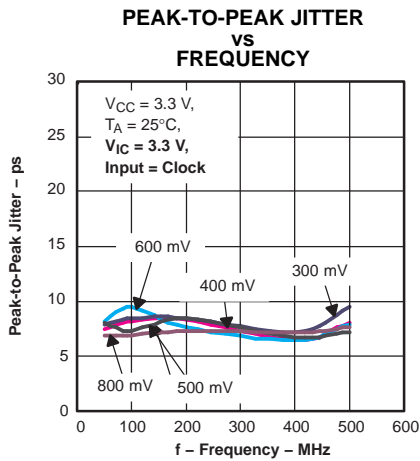

Figure 17.

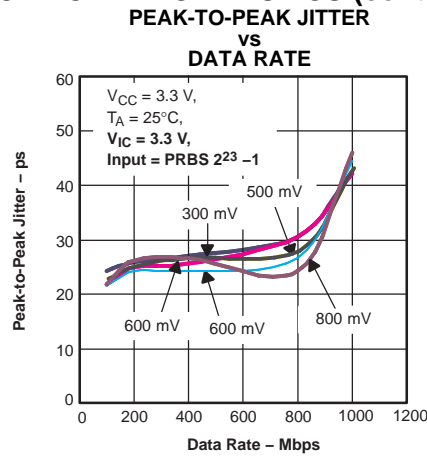

Figure 18.

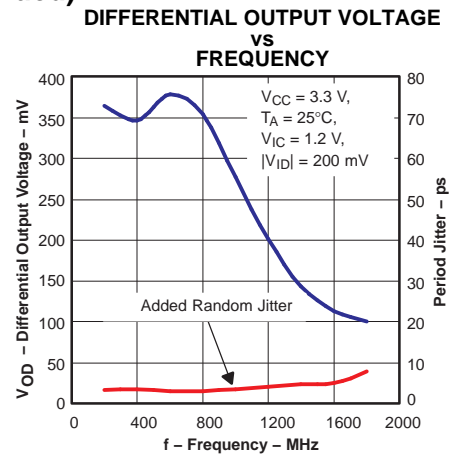

Figure 19.

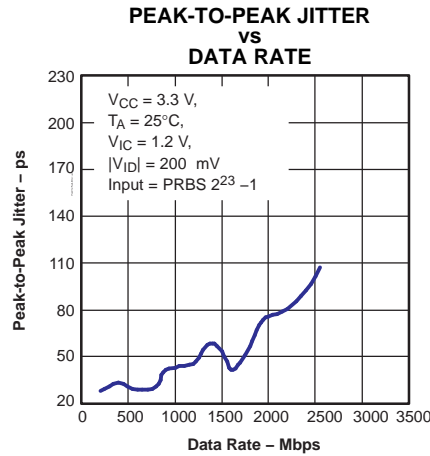

Figure 20.

APPLICATION INFORMATION

TYPICAL APPLICATION CIRCUITS (ECL, PECL, LVDS, etc.)

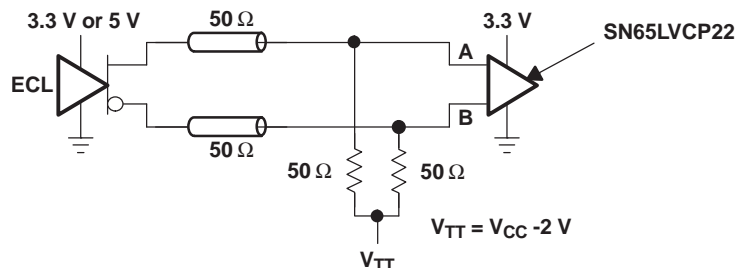

Figure 21. Low-Voltage Positive Emitter-Coupled Logic (LVPECL)

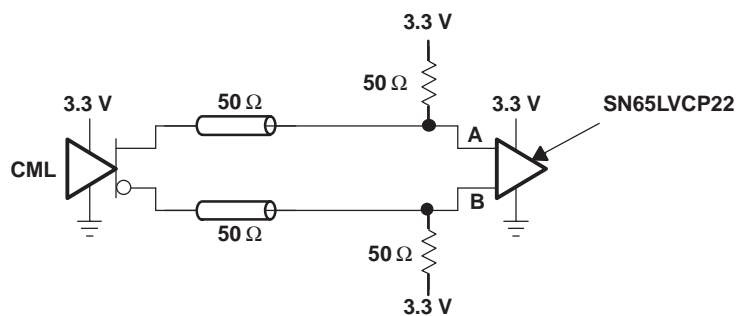

Figure 22. Current-Mode Logic (CML)

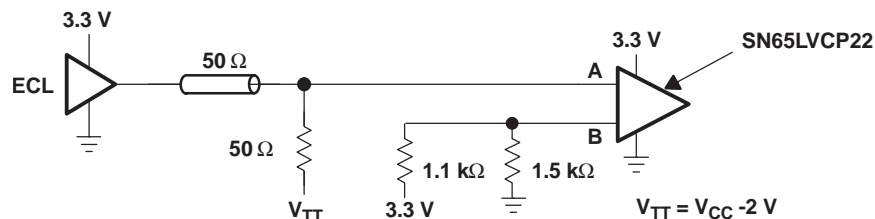

Figure 23. Single-Ended (LVPECL)

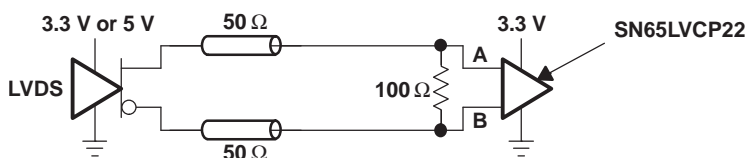

Figure 24. Low-Voltage Differential Signaling (LVDS)

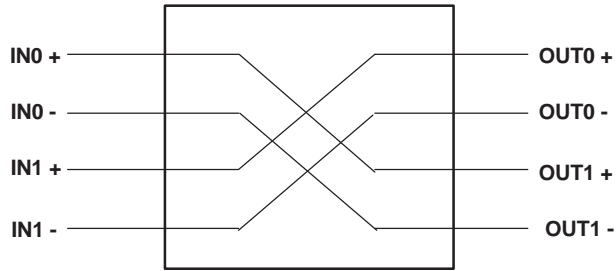

Figure 25. 2 x 2 Crosspoint

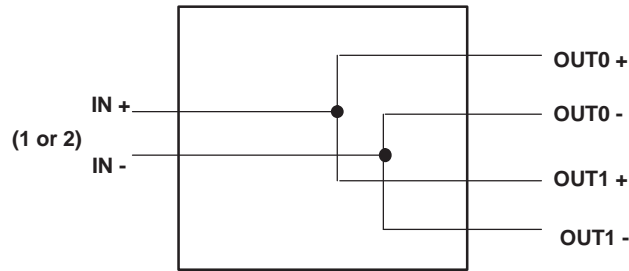

Figure 26. 1:2 Splitter



Figure 27. Dual Repeater

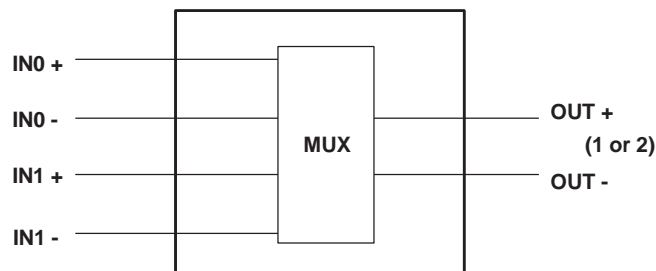

Figure 28. 2:1 MUX

REVISION HISTORY

Changes from Original (June 2012) to Revision A	Page
• Added /EM bullet to FEATURES	1
• Deleted PACKAGE/ORDERING INFORMATION table	2
• Changed SWITCHING CHARACTERISTICS, t_{JIT} and t_{Jrms}	6

PACKAGING INFORMATION

Orderable part number	Status (1)	Material type (2)	Package Pins	Package qty Carrier	RoHS (3)	Lead finish/ Ball material (4)	MSL rating/ Peak reflow (5)	Op temp (°C)	Part marking (6)
5962-1124201VFA	Last Time Buy	Production	CFP (W) 16	25 TUBE	-	Call TI	Call TI	-55 to 125	5962-1124201VF A LVCP22W-SP
SN55LVCP22W/EM	Last Time Buy	Production	CFP (W) 16	25 TUBE	-	Call TI	Call TI	0 to 0	SN55LVCP22W/EM EVAL ONLY

(1) **Status:** For more details on status, see our [product life cycle](#).

(2) **Material type:** When designated, preproduction parts are prototypes/experimental devices, and are not yet approved or released for full production. Testing and final process, including without limitation quality assurance, reliability performance testing, and/or process qualification, may not yet be complete, and this item is subject to further changes or possible discontinuation. If available for ordering, purchases will be subject to an additional waiver at checkout, and are intended for early internal evaluation purposes only. These items are sold without warranties of any kind.

(3) **RoHS values:** Yes, No, RoHS Exempt. See the [TI RoHS Statement](#) for additional information and value definition.

(4) **Lead finish/Ball material:** Parts may have multiple material finish options. Finish options are separated by a vertical ruled line. Lead finish/Ball material values may wrap to two lines if the finish value exceeds the maximum column width.

(5) **MSL rating/Peak reflow:** The moisture sensitivity level ratings and peak solder (reflow) temperatures. In the event that a part has multiple moisture sensitivity ratings, only the lowest level per JEDEC standards is shown. Refer to the shipping label for the actual reflow temperature that will be used to mount the part to the printed circuit board.

(6) **Part marking:** There may be an additional marking, which relates to the logo, the lot trace code information, or the environmental category of the part.

Multiple part markings will be inside parentheses. Only one part marking contained in parentheses and separated by a "~" will appear on a part. If a line is indented then it is a continuation of the previous line and the two combined represent the entire part marking for that device.

Important Information and Disclaimer:The information provided on this page represents TI's knowledge and belief as of the date that it is provided. TI bases its knowledge and belief on information provided by third parties, and makes no representation or warranty as to the accuracy of such information. Efforts are underway to better integrate information from third parties. TI has taken and continues to take reasonable steps to provide representative and accurate information but may not have conducted destructive testing or chemical analysis on incoming materials and chemicals. TI and TI suppliers consider certain information to be proprietary, and thus CAS numbers and other limited information may not be available for release.

In no event shall TI's liability arising out of such information exceed the total purchase price of the TI part(s) at issue in this document sold by TI to Customer on an annual basis.

OTHER QUALIFIED VERSIONS OF SN55LVCP22-SP :

- Catalog : [SN55LVCP22](#)

NOTE: Qualified Version Definitions:

- Catalog - TI's standard catalog product

W (R-GDFP-F16)

CERAMIC DUAL FLATPACK



- NOTES:
- A. All linear dimensions are in inches (millimeters).
 - B. This drawing is subject to change without notice.
 - C. This package can be hermetically sealed with a ceramic lid using glass frit.
 - D. Index point is provided on cap for terminal identification only.
 - E. Falls within MIL STD 1835 GDFP2-F16

IMPORTANT NOTICE AND DISCLAIMER

TI PROVIDES TECHNICAL AND RELIABILITY DATA (INCLUDING DATASHEETS), DESIGN RESOURCES (INCLUDING REFERENCE DESIGNS), APPLICATION OR OTHER DESIGN ADVICE, WEB TOOLS, SAFETY INFORMATION, AND OTHER RESOURCES "AS IS" AND WITH ALL FAULTS, AND DISCLAIMS ALL WARRANTIES, EXPRESS AND IMPLIED, INCLUDING WITHOUT LIMITATION ANY IMPLIED WARRANTIES OF MERCHANTABILITY, FITNESS FOR A PARTICULAR PURPOSE OR NON-INFRINGEMENT OF THIRD PARTY INTELLECTUAL PROPERTY RIGHTS.

These resources are intended for skilled developers designing with TI products. You are solely responsible for (1) selecting the appropriate TI products for your application, (2) designing, validating and testing your application, and (3) ensuring your application meets applicable standards, and any other safety, security, regulatory or other requirements.

These resources are subject to change without notice. TI grants you permission to use these resources only for development of an application that uses the TI products described in the resource. Other reproduction and display of these resources is prohibited. No license is granted to any other TI intellectual property right or to any third party intellectual property right. TI disclaims responsibility for, and you fully indemnify TI and its representatives against any claims, damages, costs, losses, and liabilities arising out of your use of these resources.

TI's products are provided subject to [TI's Terms of Sale](#), [TI's General Quality Guidelines](#), or other applicable terms available either on [ti.com](#) or provided in conjunction with such TI products. TI's provision of these resources does not expand or otherwise alter TI's applicable warranties or warranty disclaimers for TI products. Unless TI explicitly designates a product as custom or customer-specified, TI products are standard, catalog, general purpose devices.

TI objects to and rejects any additional or different terms you may propose.

Copyright © 2026, Texas Instruments Incorporated

Last updated 10/2025