

Low-Side Bidirectional Current Sensing Circuit with MSP430™ Smart Analog Combo



Design Goals

Input		Output		Supply	
I_{iMin}	I_{iMax}	V_{oMin}	V_{oMax}	V_{cc}	V_{ref}
-1 A	1 A	100 mV	3.2 V	3.3 V	1.65 V

Design Description

Some MSP430™ microcontrollers (MCUs) contain configurable integrated signal chain elements such as op-amps, DACs, and programmable gain stages. These elements make up a peripheral called the Smart Analog Combo (SAC). For information on the different types of SACs and how to leverage their configurable analog signal chain capabilities, visit [MSP430 MCUs Smart Analog Combo Training](#). To get started with your design, download the [Low-side Bidirectional Current Sensing Design Files](#).

This single-supply low-side, bidirectional current sensing solution can accurately detect load currents from -1 A to 1 A. The linear range of the output is from 100 mV to 3.2 V. Low-side current sensing keeps the common-mode voltage near ground, and is thus most useful in applications with large bus voltages. This design leverages two of the four integrated op-amp blocks (SACs) in the MSP430FR2355 MCU. One SAC_L3 peripheral is configured as a general purpose op-amp to amplify the voltage across the shunt resistor, while the other is configured as a buffer to provide the bias voltage (V_{ref}). The latter SAC_L3 block can also be configured in DAC buffer mode to provide V_{ref} , replacing the external voltage divider circuit. The output of the circuit can be internally or externally connected to other integrated peripherals in the MSP430FR2355 MCU. For example, the analog-to-digital converter (ADC) window comparator can sample this output periodically (with no CPU intervention) and trigger an interrupt when the signal crosses a threshold.

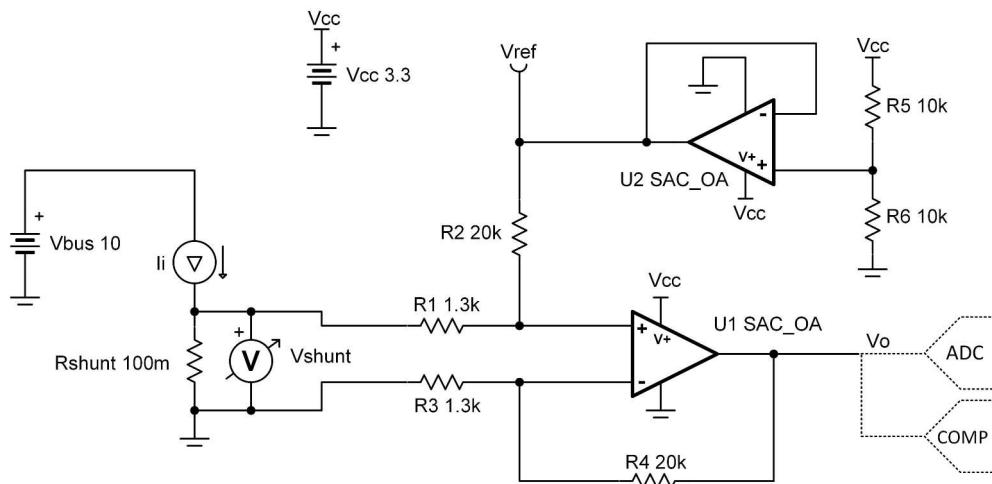

Design Notes

- To minimize errors, set $R_3 = R_1$ and $R_4 = R_2$.
- Use precision resistors for higher accuracy.
- Set output range based on linear output swing (see A_{oi} specification).
- Low-side sensing should not be used in applications where the system load cannot withstand small ground disturbances or in applications that need to detect load shorts.
- In the schematic above, the first SAC_L3 peripheral in the MSP430FR2355 MCU (U1) is configured in general purpose mode. The second SAC_L3 peripheral (U2) is also configured in general purpose mode, but with an external voltage divider.
- It is recommended to use the DAC buffer configuration for U2 (as seen in the code examples in the [Low-side Bidirectional Current Sensing Design Files](#)) to provide V_{ref} instead of using the external voltage divider circuit.
- This solution can also be implemented using the MSP430FR2311 device by using the internal transimpedance amplifier for U1, and the SAC_L1 op-amp for U2.
- The [Low-side Bidirectional Current Sensing Design Files](#) include code examples showing how to properly initialize the SAC peripherals.

Design Steps

1. Determine the transfer equation given $R_4 = R_2$ and $R_1 = R_3$.

$$V_o = \left(I_i \times R_{shunt} \times \frac{R_4}{R_3} \right) + V_{ref}$$

$$V_{ref} = V_{cc} \times \left(\frac{R_6}{R_5 + R_6} \right)$$

2. Determine the maximum shunt resistance.

$$R_{shunt} = \frac{V_{shunt}}{I_{imax}} = \frac{100mV}{1 \text{ A}} = 100m\Omega$$

3. Set reference voltage.

- a. Because the input current range is symmetric, the reference should be set to mid supply. Therefore, make R_5 and R_6 equal.

$$R_5 = R_6 = 10k\Omega$$

4. Set the difference amplifier gain based on the op amp output swing. The op amp output can swing from 100 mV to 3.2 V, given a 3.3-V supply.

$$\text{Gain} = \frac{V_{oMax} - V_{oMin}}{R_{shunt} \times (I_{iMax} - I_{iMin})} = \frac{3.2 \text{ V} - 100mV}{100m\Omega \times (1 \text{ A} - (-1 \text{ A}))} = 15.5 \frac{V}{V}$$

$$\text{Gain} = \frac{R_4}{R_3} = 15.5 \frac{V}{V}$$

Choose $R_1 = R_3 = 1.3k\Omega$ (Standard Value)

$$R_2 = R_4 = 15.5 \frac{V}{V} \times 1.3k\Omega = 20.15 \text{ k}\Omega \approx 20k\Omega \text{ (Standard Value)}$$

Design Simulations

DC Simulation Results

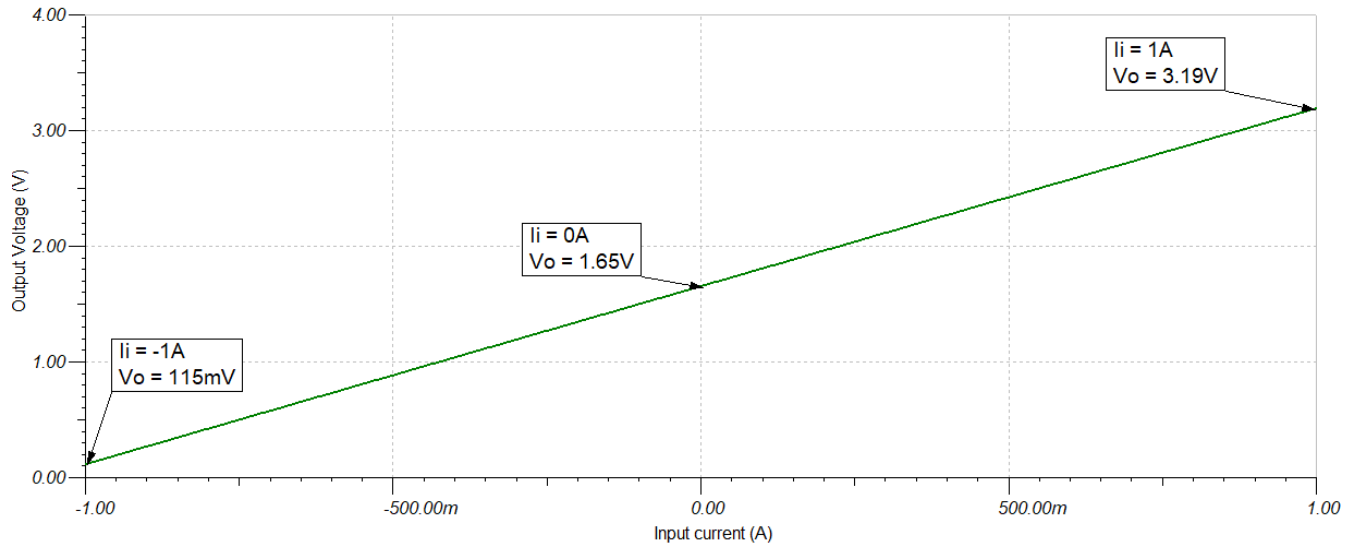

Closed Loop AC Simulation Results

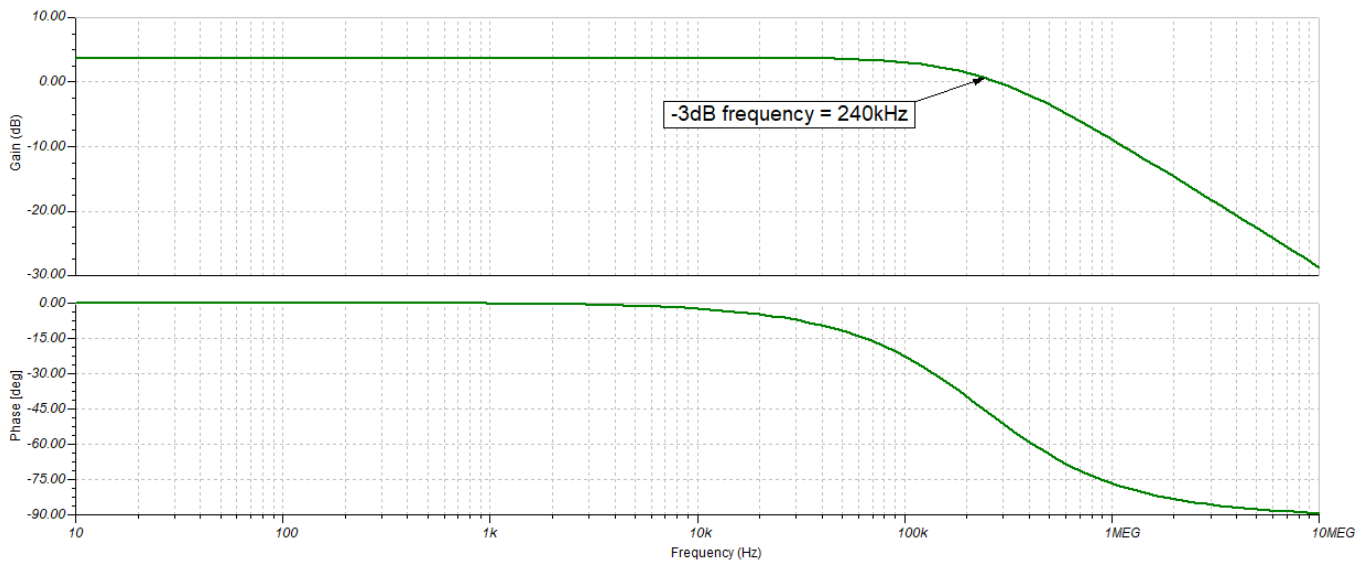

Transient Simulation Results

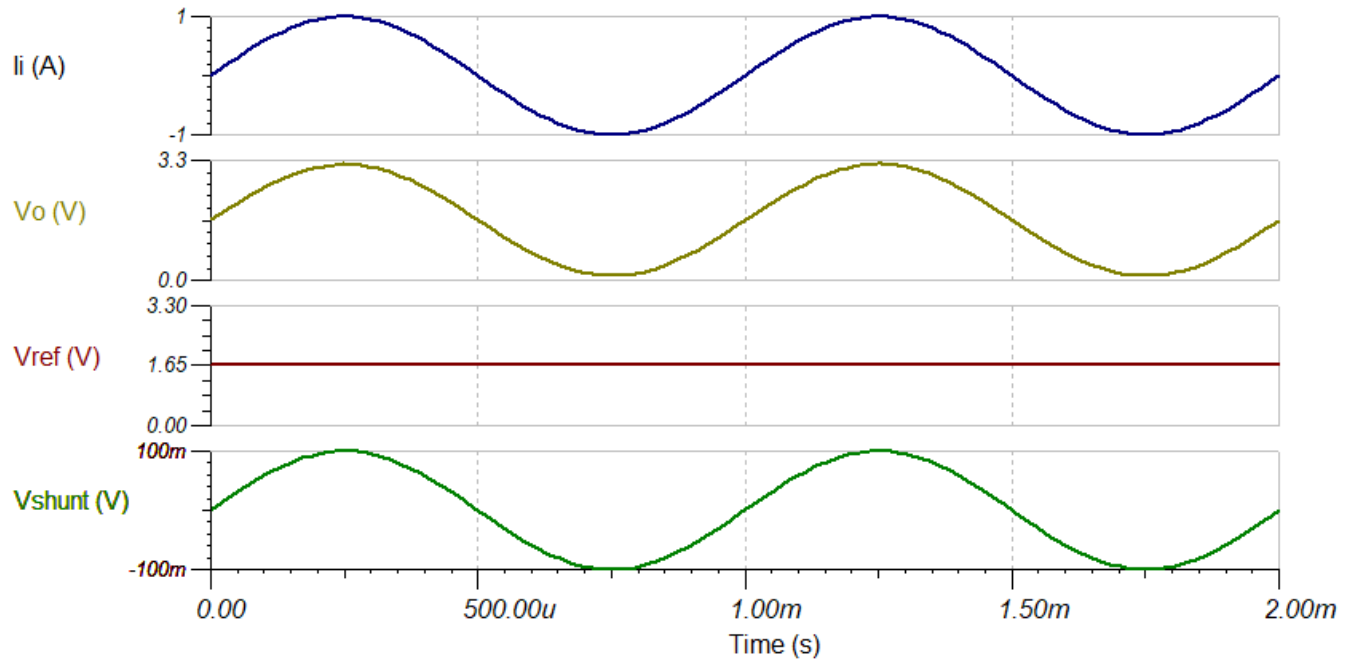

Target Applications

- [Motor Drives](#)
- [Servo Drive Functional Safety Module](#)
- [Merchant Battery Charger](#)
- [Battery Pack: Cordless Power Tool](#)
- [Battery Pack: E-Bike/E-Scooter/Light Electric Vehicle \(LEV\)](#)

Design References

1. [MSP430 Low-side Bidirectional Current Sensing Circuit Code Examples and SPICE Simulation File](#)
2. [Analog Engineer's Circuit Cookbooks](#)
3. [MSP430FR2311 TINA-TI Spice Model](#)
4. [MSP430 MCUs Smart Analog Combo Training](#)





Design Featured Op Amp

MSP430FRxx Smart Analog Combo		
	MSP430FR2311 SAC_L1	MSP430FR2355 SAC_L3
V_{CC}	2.0 V to 3.6 V	
V_{CM}	-0.1 V to $V_{CC} + 0.1$ V	
V_{out}	Rail-to-rail	
V_{os}	± 5 mV	
A_{OL}	100 dB	
I_q	350 μ A (high-speed mode)	
	120 μ A (low-power mode)	
I_b	50 pA	
UGBW	4 MHz (high-speed mode)	2.8 MHz (high-speed mode)
	1.4 MHz (low-power mode)	1 MHz (low-power mode)
SR	3 V/ μ s (high-speed mode)	
	1 V/ μ s (low-power mode)	
Number of channels	1	4
http://www.ti.com/product/MSP430FR2311		
http://www.ti.com/product/MSP430FR2355		

Design Alternate Op Amp

MSP430FR2311 Transimpedance Amplifier	
V_{CC}	2.0 V to 3.6 V
V_{CM}	-0.1 V to $V_{CC}/2$ V
V_{out}	Rail-to-rail
V_{os}	± 5 mV
A_{OL}	100 dB
I_q	350 μ A (high-speed mode)
	120 μ A (low-power mode)
I_b	5 pA (TSSOP-16 with OA-dedicated pin input)
	50 pA (TSSOP-20 and VQFN-16)
UGBW	5 MHz (high-speed mode)
	1.8 MHz (low-power mode)
SR	4 V/ μ s (high-speed mode)
	1 V/ μ s (low-power mode)
Number of channels	1
http://www.ti.com/product/MSP430FR2311	

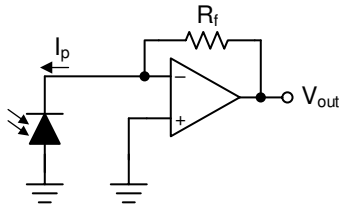
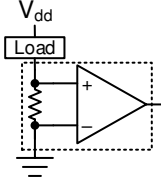
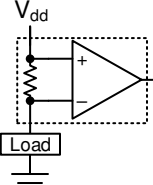
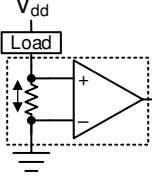
Related MSP430 Circuits

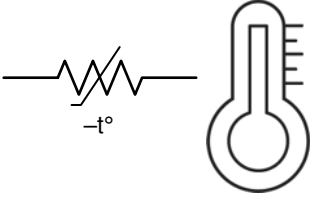
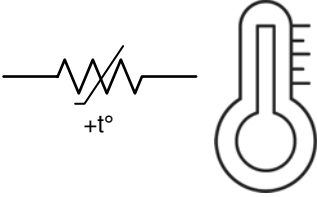
<p>Low-noise and long-range PIR sensor conditioner circuit</p> 	<p>Bridge amplifier circuit</p> 	<p>Transimpedance amplifier circuit</p> 
<p>Single-supply, low-side, unidirectional current-sensing circuit</p> 	<p>High-side current sensing with discrete difference amplifier circuit</p> 	<p>Low-side, bidirectional current-sensing circuit</p> 
<p>Half-wave rectifier circuit</p> 	<p>Temperature sensing with NTC thermistor circuit</p> 	<p>Temperature sensing with PTC thermistor circuit</p> 

Revision History

NOTE: Page numbers for previous revisions may differ from page numbers in the current version.

Changes from November 15, 2019 to March 6, 2020

Page

<p>• Added <i>Related MSP430 Circuits</i> section.....</p>	<p>1</p>
------------------------------------------------------------	-----------------

IMPORTANT NOTICE AND DISCLAIMER

TI PROVIDES TECHNICAL AND RELIABILITY DATA (INCLUDING DATA SHEETS), DESIGN RESOURCES (INCLUDING REFERENCE DESIGNS), APPLICATION OR OTHER DESIGN ADVICE, WEB TOOLS, SAFETY INFORMATION, AND OTHER RESOURCES "AS IS" AND WITH ALL FAULTS, AND DISCLAIMS ALL WARRANTIES, EXPRESS AND IMPLIED, INCLUDING WITHOUT LIMITATION ANY IMPLIED WARRANTIES OF MERCHANTABILITY, FITNESS FOR A PARTICULAR PURPOSE OR NON-INFRINGEMENT OF THIRD PARTY INTELLECTUAL PROPERTY RIGHTS.

These resources are intended for skilled developers designing with TI products. You are solely responsible for (1) selecting the appropriate TI products for your application, (2) designing, validating and testing your application, and (3) ensuring your application meets applicable standards, and any other safety, security, regulatory or other requirements.

These resources are subject to change without notice. TI grants you permission to use these resources only for development of an application that uses the TI products described in the resource. Other reproduction and display of these resources is prohibited. No license is granted to any other TI intellectual property right or to any third party intellectual property right. TI disclaims responsibility for, and you will fully indemnify TI and its representatives against, any claims, damages, costs, losses, and liabilities arising out of your use of these resources.

TI's products are provided subject to [TI's Terms of Sale](#) or other applicable terms available either on [ti.com](https://www.ti.com) or provided in conjunction with such TI products. TI's provision of these resources does not expand or otherwise alter TI's applicable warranties or warranty disclaimers for TI products.

TI objects to and rejects any additional or different terms you may have proposed.

Mailing Address: Texas Instruments, Post Office Box 655303, Dallas, Texas 75265
Copyright © 2023, Texas Instruments Incorporated