

# Single-supply strain gauge bridge amplifier circuit with MSP430™ smart analog combo

## Design Goals

Input $V_{iDiff}$ ( $V_{i2} - V_{i1}$ )		Output		Supply		
$V_{iDiff\_Min}$	$V_{iDiff\_Max}$	$V_{oMin}$	$V_{oMax}$	$V_{cc}$	$V_{ee}$	$V_{ref}$
-2.22 mV	2.27 mV	0.1 V	3.2 V	3.3 V	0 V	1.65 V

Strain Gauge Resistance Variation ( $R_{10}$ )	$V_{cm}$	Gain
115 $\Omega$ to 125 $\Omega$	1.34 V	690 V/V

## Design Description

Some MSP430™ microcontrollers (MCUs) contain configurable integrated signal chain elements such as op-amps, DACs, and programmable gain stages. These elements make up a peripheral called the Smart Analog Combo (SAC). For information on the different types of SACs and how to leverage their configurable analog signal chain capabilities, visit [MSP430 MCUs Smart Analog Combo Training](#). To get started with your design, download the [Strain Gauge Bridge Amplifier Circuit Design Files](#).

A strain gauge is a sensor whose resistance varies with applied force. The change in resistance is directly proportional to how much strain the sensor is experiencing due to the force applied. This pressure sensing circuit uses a strain gauge placed in a bridge configuration to measure the variation in resistance. This design leverages all four of the built-in op-amp blocks (SACs) in the [MSP430FR2355](#). Two SAC\_L3 peripherals are configured in general-purpose mode to amplify a differential signal created by the change in resistance of a strain gauge while the other two are configured in DAC mode to supply the reference voltage ( $V_{ref}$ ) and the excitation voltage ( $V_{ex}$ ). By varying  $R_{10}$ , a small differential voltage is created at the output of the Wheatstone bridge which is fed to the 2 SAC op-amp instrumentation amplifier inputs. The linearity of the instrumentation amplifier is based on the input common-mode and output-swing ranges of the MSP430 SAC op-amp, which can be found in the specification chart at the end of this document. The output of the second stage op-amp can be sampled directly by the on-board ADC or monitored by the on-board comparator for further processing inside the MCU.

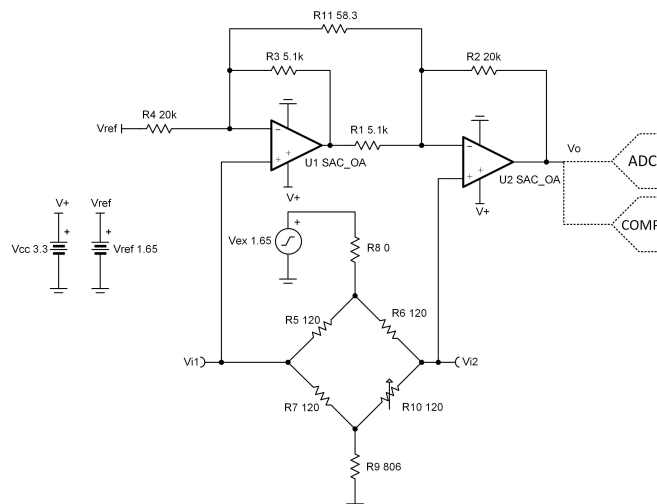

## Design Notes

- Resistors  $R_5$ ,  $R_6$ , and  $R_7$  of the Wheatstone bridge must match the strain gauge nominal resistance and must be equal to avoid creating a bridge offset voltage.
- Low tolerance resistors must be used to minimize the offset and gain errors due to the bridge resistors.
- $V_{ex}$  sets the excitation voltage of the bridge and the common-mode voltage  $V_{cm}$ .
- $V_{ref}$  biases the output voltage of the MSP430 SAC-based instrumentation amplifier to mid-supply to allow differential measurements in the positive and negative directions.
- $R_{11}$  sets the gain of the instrumentation amplifier circuit.
- $R_8$  and  $R_9$  set the common-mode voltage of the instrumentation amplifier and limits the current through the bridge. This current determines the differential signal produced by the bridge. However, there are limitations on the current through the bridge due to self-heating effects of the bridge resistors and strain gauge.
- Ensure that  $R_1 = R_3$  and  $R_2 = R_4$  and that ratios of  $R_2/R_1$  and  $R_4/R_3$  are matched to set the  $V_{ref}$  gain to 1 V/V and maintain high DC CMRR of the instrumentation amplifier.
- Using high-value resistors can degrade the phase margin of the circuit and introduce additional noise in the circuit.
- If the solution is implemented using the MSP430FR2311, the instrumentation amplifier would need to consist of one SAC\_L1 op-amp and one Transimpedance Amplifier (TIA) op-amp. The excitation and reference voltages,  $V_{ex}$  &  $V_{ref}$ , would need to be supplied externally (i.e. voltage divider).
- The [Strain Gauge Bridge Amplifier Circuit Design Files](#) include code examples showing how to properly initialize the SAC peripherals.

## Design Steps

- Select  $R_5$ ,  $R_6$  and  $R_7$  to match the strain gauge nominal resistance

$$R_{\text{gauge}} = R_5 = R_6 = R_7 = 120\Omega$$

- Choose  $R_9$  to set the common mode voltage of the instrumentation amplifier at 1.34 V.

$$V_{cm} = \frac{\frac{R_{\text{bridge}}}{2} + R_9}{R_{\text{bridge}} + R_8 + R_9} \times V_{ex}$$

Where  $R_{\text{bridge}}$  = total resistance of the bridge

Choose  $R_8 = 0\Omega$  to allow maximum current through the bridge

$$V_{cm} = \frac{\frac{120\Omega \times 4}{2} + R_9}{120\Omega \times 4 + 0\Omega + R_9} \times 1.65V = 1.34V$$

$$\frac{240 + R_9}{480 + 0\Omega + R_9} = \frac{1.34V}{1.65V} = 0.812$$

$$0.188 R_9 = 149.82 \rightarrow R_9 = \frac{149.82}{0.188} = 797.42\Omega \rightarrow R_9 = 806\Omega \text{ (Standard value)}$$

- Calculate the gain required to produce the desired output voltage swing

$$G = \frac{V_{o\text{Max}} - V_{o\text{Min}}}{V_{\text{IDiff\_Min}} - V_{\text{IDiff\_Max}}} = \frac{3.2V - 0.1V}{0.00222V - (-0.00227V)} = 690.42 \frac{V}{V}$$

- Select  $R_1$ ,  $R_2$ ,  $R_3$  and  $R_4$ . To set the  $V_{ref}$  gain at 1 V/V and avoid degrading the instrumentation amplifier's CMRR,  $R_1$  must equal  $R_3$  and  $R_2$  equal  $R_4$ .

$$\text{Choose } R_1 = R_3 = 5.1k\Omega \text{ and } R_2 = R_4 = 20k\Omega \text{ (Standard value)}$$

- Calculate  $R_{11}$  to meet the required gain

$$G = 1 + \frac{R_4}{R_3} + \frac{2 \times R_2}{R_{11}} = 690.42 \frac{V}{V}$$

$$G = 1 + \frac{20k\Omega}{5.1k\Omega} + \frac{2 \times R_2}{R_{11}} = 690.42 \frac{V}{V} \rightarrow 4.92 + \frac{40k\Omega}{R_{11}} = 690.42 \frac{V}{V} \rightarrow \frac{40k\Omega}{R_{11}} = 685.5 \rightarrow R_{11} = \frac{40k\Omega}{685.5} = 58.35\Omega \rightarrow R_{11} = 58.3\Omega \text{ (Standard Value)}$$

- Calculate the current through the bridge

$$I_{\text{bridge}} = \frac{V_{ex}}{R_8 + R_9 + R_{\text{bridge}}} = \frac{1.65V}{0\Omega + 806\Omega + 120\Omega \times 4}$$

$$I_{\text{bridge}} = \frac{1.65V}{806\Omega + 480\Omega} \rightarrow I_{\text{bridge}} = 1.28mA$$

## Design Simulations

### DC Simulation Results

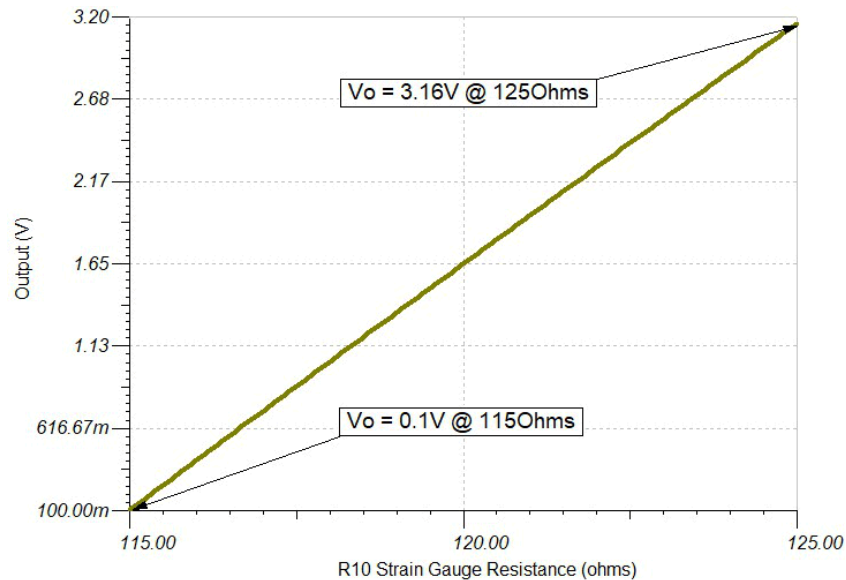

### Target Applications

- [Pressure transmitter](#)
- [Weigh scale](#)

### References

1. [MSP430 Strain Gauge Bridge Amplifier Circuit Code Examples and SPICE Simulation File](#)
2. [Analog Engineer's Circuit Cookbooks](#)
3. [MSP430FR2311 TINA-TI Spice Model](#)
4. [MSP430 MCUs Smart Analog Combo Training](#)





### Design Featured Op Amp

MSP430FRxx Smart Analog Combo		
	MSP430FR2311 SAC_L1	MSP430FR2355 SAC_L3
$V_{CC}$	2.0 V to 3.6 V	
$V_{CM}$	-0.1 V to $V_{CC} + 0.1$ V	
$V_{out}$	Rail-to-rail	
$V_{os}$	$\pm 5$ mV	
$A_{OL}$	100 dB	
$I_q$	350 $\mu$ A (high-speed mode)	
	120 $\mu$ A (low-power mode)	
$I_b$	50 pA	
UGBW	4 MHz (high-speed mode)	2.8 MHz (high-speed mode)
	1.4 MHz (low-power mode)	1 MHz (low-power mode)
SR	3 V/ $\mu$ s (high-speed mode)	
	1 V/ $\mu$ s (low-power mode)	
Number of channels	1	4
<a href="http://www.ti.com/product/MSP430FR2311">http://www.ti.com/product/MSP430FR2311</a>		
<a href="http://www.ti.com/product/MSP430FR2355">http://www.ti.com/product/MSP430FR2355</a>		

**Design Alternate Op Amp**

<b>MSP430FR2311 Transimpedance Amplifier</b>	
<b>V<sub>CC</sub></b>	2.0 V to 3.6 V
<b>V<sub>CM</sub></b>	-0.1 V to V <sub>CC</sub> /2 V
<b>V<sub>out</sub></b>	Rail-to-rail
<b>V<sub>os</sub></b>	±5 mV
<b>A<sub>OL</sub></b>	100 dB
<b>I<sub>q</sub></b>	350 μA (high-speed mode)
	120 μA (low-power mode)
<b>I<sub>b</sub></b>	5 pA (TSSOP-16 with OA-dedicated pin input)
	50 pA (TSSOP-20 and VQFN-16)
<b>UGBW</b>	5 MHz (high-speed mode)
	1.8 MHz (low-power mode)
<b>SR</b>	4 V/μs (high-speed mode)
	1 V/μs (low-power mode)
<b>Number of channels</b>	1
<a href="http://www.ti.com/product/MSP430FR2311">http://www.ti.com/product/MSP430FR2311</a>	

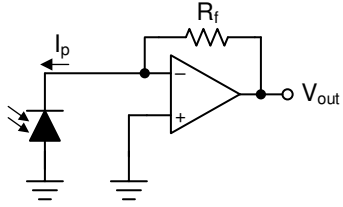
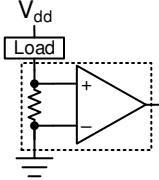
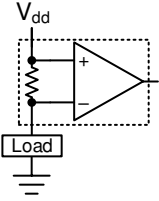
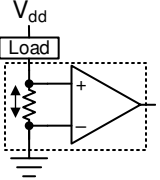
**Related MSP430 Circuits**

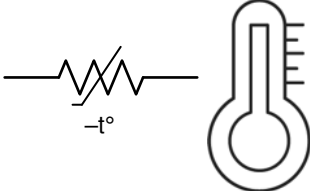
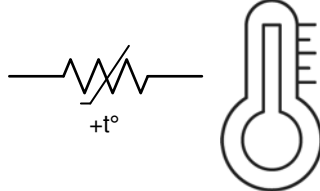
<p>Low-noise and long-range PIR sensor conditioner circuit</p> 	<p>Bridge amplifier circuit</p> 	<p>Transimpedance amplifier circuit</p> 
<p>Single-supply, low-side, unidirectional current-sensing circuit</p> 	<p>High-side current sensing with discrete difference amplifier circuit</p> 	<p>Low-side, bidirectional current-sensing circuit</p> 
<p>Half-wave rectifier circuit</p> 	<p>Temperature sensing with NTC thermistor circuit</p> 	<p>Temperature sensing with PTC thermistor circuit</p> 

---

## Revision History

NOTE: Page numbers for previous revisions may differ from page numbers in the current version.

### Changes from November 27, 2019 to March 6, 2020

**Page**

- 
- Added *Related MSP430 Circuits* section..... 5
-

## IMPORTANT NOTICE AND DISCLAIMER

TI PROVIDES TECHNICAL AND RELIABILITY DATA (INCLUDING DATA SHEETS), DESIGN RESOURCES (INCLUDING REFERENCE DESIGNS), APPLICATION OR OTHER DESIGN ADVICE, WEB TOOLS, SAFETY INFORMATION, AND OTHER RESOURCES "AS IS" AND WITH ALL FAULTS, AND DISCLAIMS ALL WARRANTIES, EXPRESS AND IMPLIED, INCLUDING WITHOUT LIMITATION ANY IMPLIED WARRANTIES OF MERCHANTABILITY, FITNESS FOR A PARTICULAR PURPOSE OR NON-INFRINGEMENT OF THIRD PARTY INTELLECTUAL PROPERTY RIGHTS.

These resources are intended for skilled developers designing with TI products. You are solely responsible for (1) selecting the appropriate TI products for your application, (2) designing, validating and testing your application, and (3) ensuring your application meets applicable standards, and any other safety, security, regulatory or other requirements.

These resources are subject to change without notice. TI grants you permission to use these resources only for development of an application that uses the TI products described in the resource. Other reproduction and display of these resources is prohibited. No license is granted to any other TI intellectual property right or to any third party intellectual property right. TI disclaims responsibility for, and you will fully indemnify TI and its representatives against, any claims, damages, costs, losses, and liabilities arising out of your use of these resources.

TI's products are provided subject to [TI's Terms of Sale](#) or other applicable terms available either on [ti.com](http://ti.com) or provided in conjunction with such TI products. TI's provision of these resources does not expand or otherwise alter TI's applicable warranties or warranty disclaimers for TI products.

TI objects to and rejects any additional or different terms you may have proposed.

Mailing Address: Texas Instruments, Post Office Box 655303, Dallas, Texas 75265  
Copyright © 2022, Texas Instruments Incorporated