

Click and Pop Measurement Technique

Tomas Soerensen

Digital Audio and Video Division

ABSTRACT

During various occasions a digital amplifier can generate a click or a pop. The click is generated at changes of the operational modes of the amplifier, e.g., charging of capacitors or mute/unmute. For Class D amplifier systems, click is typically at PWM start and stop.

The audibility of a click depends on the system, amplifier, and speaker. Also, perception of the click is subjective. This makes it difficult to compare the results from two different systems.

This document specifies a measurement technique which can be used for all systems, makes results comparable, and gives limits to what is acceptable in an end application. The described measurement technique applies to all systems which have a start-up sequence of less than 1 ms. For PurePath Digital™ systems, this applies to the TAS5026, TAS5036, TAS5066, TAS5076, TAS5028, TAS5508, and TAS5518. Measurements on two EVMs, TAS5066-5121K6EVM and TAS5508-5121K6EVM, are shown for reference.

Contents

1	When Does Click Occur?	2
2	Click and Pop Measurement Setup	5
3	What Is a Loud Click?	10
4	Click and Pop Measurements Examples.....	13
5	Reference	14

List of Figures

1	Top—Continuous PWM; Bottom—PWM Start.....	3
2	TI Purepath Digital Start Sequence	3
3	Charging of Bootstrap Capacitor	4
4	DC Offset at PWM Start	4
5	Setup of Test Equipment	5
6	Analog Analyzer Setup.....	6
7	Digital Analyzer Setup	7
8	Sweep Setup	7
9	External Trigger	8
10	DC Step	9
11	DC Step in Frequency Domain	9
12	Asynchronous Stop of PWM.....	10
13	Threshold of Hearing	11
14	Threshold Approximation.....	11
15	Click and Pop Test Limits	12
16	TAS5066-5121K6EVM	13
17	TAS5508-5121K8EVM	13

List of Tables

1	Modulator Programming	8
2	Click and Pop Test Limits, System Two	12
3	Click and Pop Test Limits, System Two Cascade	12

1 When Does Click Occur?

Click and pop can generally be defined as undesired audible transients generated by the amplifier system – i.e., not coming from the system input signal. Such transients can be generated when the amplifier system changes its operating mode.

- System power up/power down
- Mute/unmute
- Input source change
- Sample rate change

During these mode changes, filter capacitors are charged and/or PWM switching starts and stops. Sources for the transients can then be identified as:

- PWM switching start and stop pattern
- DC offsets
- Wrong power sequence of PWM and power stage
- Improper charging of bootstrap capacitor in power stage
- Stopping of the noise shaper
- Power stage timing skews
- Improper use of VALID, $\overline{\text{RESET}}$, $\overline{\text{MUTE}}$
- Transients on PVDD (single-ended only)
- Clock errors

1.1 PWM Start

The PWM starts and stops at system power up and power down, at mute and unmute, and at input source change, depending on the modulator used. Every time the PWM starts this results in a small click. This is explained in Figure 1.

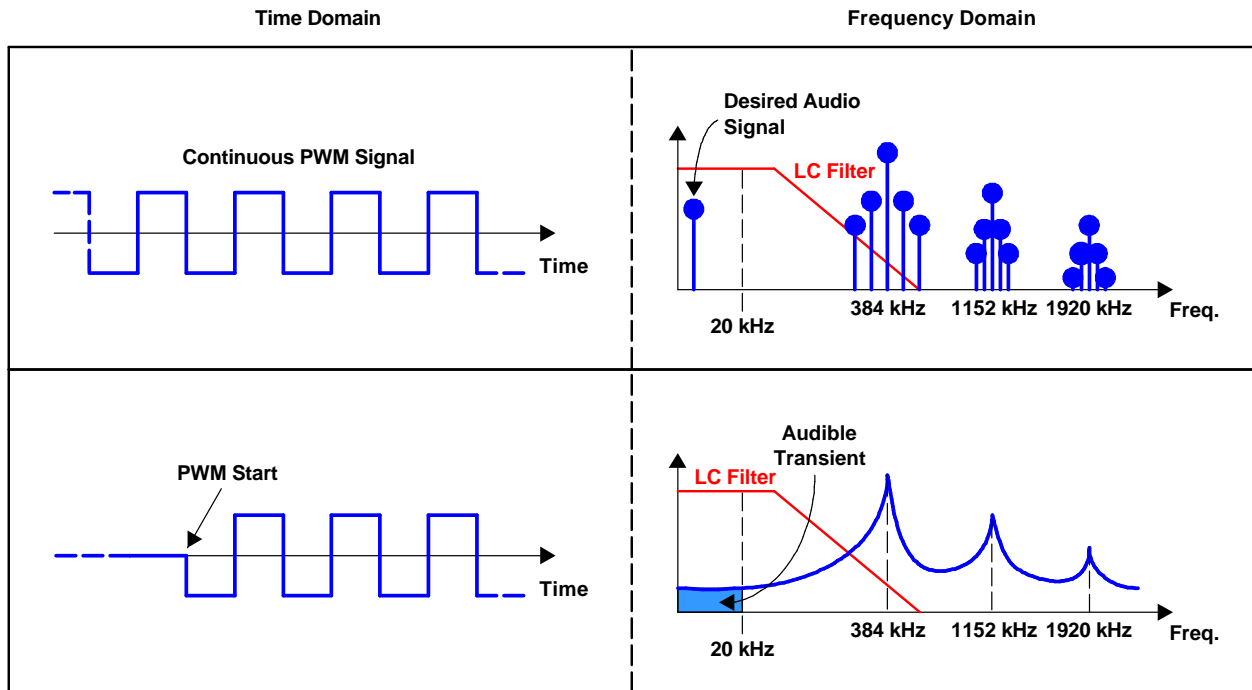

T0045-01

Figure 1. Top—Continuous PWM; Bottom—PWM Start

A continuous PWM signal modulating an audio signal in the frequency domain has the modulated signal, the switching frequency, and some mirrored frequencies around the switching frequency. The switching frequency and the mirrored frequencies are all undesired frequencies, but can easily be removed by a low-pass LC filter, thus leaving the desired audio signal.

During the start of the PWM, the frequency domain looks different. Around the switching frequency and all its odd harmonics, there are skirts which extend into the audio band. To the extent that they are below the filter cutoff frequency, they cannot be removed by the low-pass filter. The result is an audible click noise.

By having a special start sequence in the PWM, the level of the skirts in the audio band can be changed. TI Purepath Digital has a start sequence that is optimized so the skirts are as small as possible in the audio band.

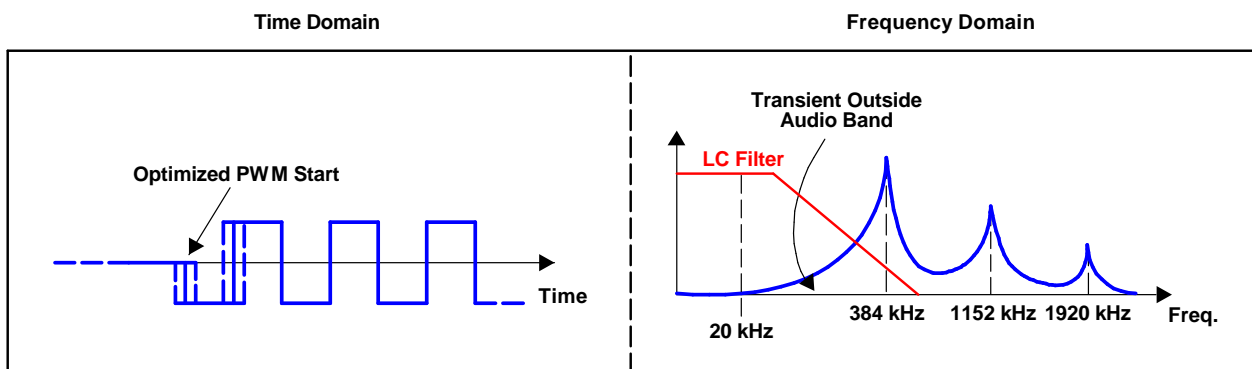

T0045-02

Figure 2. TI Purepath Digital Start Sequence

1.1.1 Bootstrap Charging

For BTL applications, an additional issue must be addressed. When the A-side in BTL AD-mode is low, the B-side is high. At start-up, the bootstrap capacitors for both sides must be charged. Bootstrap capacitors are only charged when the PWM is low.

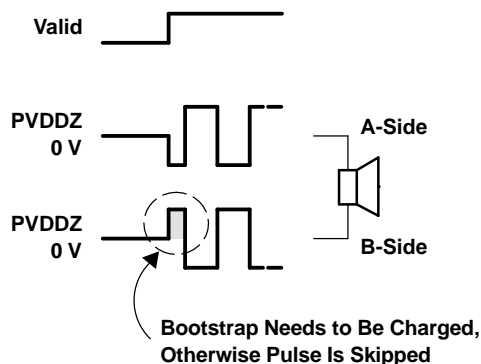

T0046-01

Figure 3. Charging of Bootstrap Capacitor

If the A-side goes low during the first cycle, it is not a problem because the bootstrap capacitor for the A-side can charge during the low period. But the B-side is supposed to be high during the first cycle. This does not happen because the bootstrap capacitor on the B-side is not charged. If the bootstrap capacitor is not charged, the B-side cannot go high and the first pulse is skipped. An *unbalanced* start like this causes a significant click at PWM start.

To solve this problem, ensure that both A- and B-sides are charged at PWM start:

- For TAS5026 and TAS5066, the power-stage output filter must be tied to ground through a resistor to ensure that both the A- and B-sides are low before PWM start.
- TAS5028, TAS5508, and TAS5518 have a built-in start-up sequence that causes the A- and B-sides to be low during the first cycle.
- TAS5036 and TAS5076 use the BD mode, which also ensures that the A- and B-sides are low during the first cycle.

1.1.2 DC Step

Small differences in each side of the power stage for BTL channels and differences in the 50%-duty-cycle and split-capacitor voltages for SE channels cause a dc step at the output when the PWM is turned on.

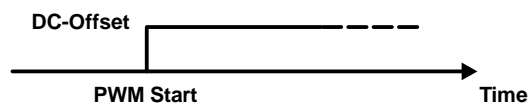

T0047-01

Figure 4. DC Offset at PWM Start

The dc step can, if big enough, be heard as more a pop than a click due to the low-frequency contents. Small timing errors in PWM can generate a dc step. For example, a 5-ns timing error with 30-V PVDD generates a 57-mV dc offset.

For systems using blocking capacitors at the output, the blocking capacitor must be charged at PWM start. If implemented incorrectly, the charging of the capacitor is heard as a click or pop in the speaker.

1.2 PWM Stop

The PWM can be stopped in two ways for BTL channels. It can be stopped either in low-impedance (low-Z) or in high-impedance (hi-Z) mode. Low-Z occurs when both sides of the power stage go low. This provides a current path for the energy stored in the low-pass filter. The click then is similar to the PWM start click.

When hi-Z is used, the energy stored in the low-pass filter, i.e., residual current in the filter inductor or residual voltage in the capacitor, can only be dumped into the speaker.

1.3 Texas Instruments Solution to Click and Pop

Texas Instruments has developed specially optimized PWM start and stop sequences to keep the click and pop under control. This includes sequences that make the audible part of the click cancel out. These sequences work for low-Z stops as well as hi-Z stops. The start sequences ensure proper charging of the bootstrap capacitors. These sequences are patented by Texas Instruments.

To make pop and click control work properly, it is important that the modulator has full control of the power stage. No additional circuits are allowed to interfere with the PWM signals and VALID line. VALID controls the timing of the inactive state and switching. It ensures that the power stage always starts with a bootstrap capacitor charge. For this reason, it is not allowed to have delay or RC circuits on the VALID line and the PWM lines. Delays as small as 5 ns can cause an increase in pop and click.

2 Click and Pop Measurement Setup

To get an objective evaluation of click and pop and to compare results from different setups, a metric standard is needed.

The test setup described in the following section can be used for systems with a start or stop sequence less than 1 ms. Texas Instruments modulators which have a start/stop sequence less than 1 ms are TAS5026, TAS5036, TAS5066, TAS5076, TAS5028, TAS5508, and TAS5518.

2.1 Setup

The following setup must be used for click and pop measurement. The speaker output is connected to a load. An audio measurement system is connected to the speaker output through a microphone transformer with a 1:1 ratio. A recommended transformer is the PB-2XX from Jensen Transformers: <http://www.Jensen-transformers.com>. An important requirement of the transformer is that it must have a high common-mode rejection ratio (CMRR) and flat frequency response from 20 Hz to 20 kHz.

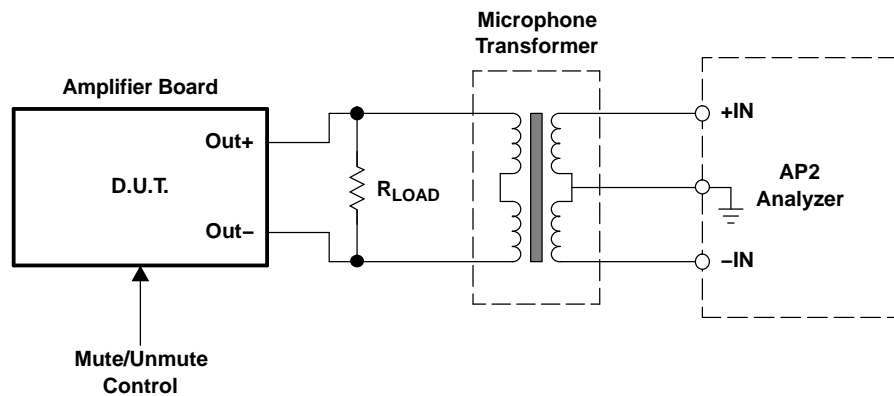

Figure 5. Setup of Test Equipment

The transformer must be used to remove the common-mode contents in the speaker output signal. During start and stop, the speaker terminals have a common-mode voltage step from 0 V to PVDD/2 and PVDD/2 to 0 V (depending on which power stage is used). This common-mode voltage step is not heard in the speakers, but it will overload the input of the analyzer if it is not filtered out by the high-CMRR transformer.

2.2 Audio Measurement System Setup

The measurement technique described in this application report uses the System Two™ or System Two Cascade audio measurement system by Audio Precision™.

The analog and digital generators must be off. Analyzer setup is shown in [Figure 6](#).



C001

Figure 6. Analog Analyzer Setup

Disable Auto Range. A start or a stop sequence is so fast that the autoranger inside the audio measurement system does not have time to select the correct range. The range selected must be high enough that the input signal does not clip in the audio measurement system and low enough that an adequate resolution is maintained. Because the transformer common-mode signals are reduced, the input range can be set to 300 mV. For a poorly performing amplifier, it might be necessary to select a higher range.

Select BW (bandwidth) setting <10 Hz – 20 kHz AES17. The AES17 filter removes all non-audio artifacts caused by the switching frequency.

2.2.1 Digital Analyzer

The digital analyzer channel 1 is set to get input from analog analyzer A, Anlr-A (see [Figure 7](#)). Set the analyzer input to the fastest requisition. For System Two, set to High BW (4x A/D), for System Two Cascade set to HiBW A/D @262144. This gives a sampling frequency F_s of 192 kHz for System Two and 262.144 kHz for System Two Cascade.

Trigger sensitivity is set to 9 mFFS. Note that the trigger point depends on the noise level in the system; so, adjustment of the trigger sensitivity might be needed to trigger correctly.

Trigger delay is set to –8 msec to get enough data before and after the trigger time.

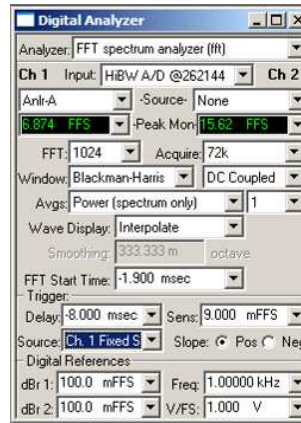

C002

Figure 7. Digital Analyzer Setup

The FFT is a 1024-point FFT ($N_{FFT} = 1024$) using a Blackman-Harris window. The number of points in the FFT defines the resolution of the FFT. When $N_{FFT} = 1024$ is selected, the resolution is $F_s/N_{FFT} = 256$ Hz; in other words, there is 256 Hz between each FFT point. The FFT is set up so the center of the window is at the beginning of the transient—at the trigger time. This is set by the FFT start time, -1.900 msec, which is calculated as $(N_{FFT}/F_s)/2$.

2.2.2 Sweep

To get the actual measurement, a sweep is made. Data 1 is set to FFT channel 1 (Fft.Ch1 Ampl) (see Figure 8). The scale is selected to dBV. Note that dBV is by definition an absolute scale (measurements compared to 1 V), but due to the FFT scaling, the result depends on the sampling frequency (192 kHz for System Two and 262.144 Hz for System Two Cascade) and the window selected, in this case Blackman-Harris. For this reason there is 2.7-dB difference in measurements obtained by a System Two and a System Two Cascade.

Source 1 is set to show the frequency, Fft.FFT Freq.

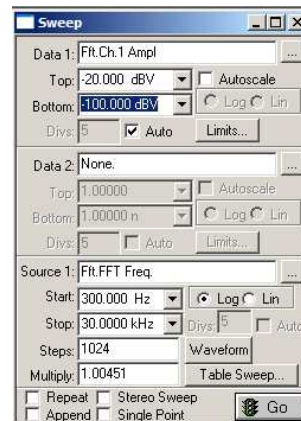

C003

Figure 8. Sweep Setup

The measurement is started by clicking *Go* (or pressing F9) to arm the trigger.

By clicking the *Waveform* button, the measurement can be shown in the time domain instead. This is helpful when interpreting the result.

2.2.3 Modulator Programming

To measure the mute/unmute sequence, the best results are obtained by disabling automute. By the disabling of automute, mute can be controlled directly from GUI software for the given modulator.

For each device, automute is disabled by programming one of its registers as listed in [Table 1](#).

Table 1. Modulator Programming

DEVICE	REGISTER NAME	SUBADDRESS	VALUE (Hex)
TAS5026	System control register 1	0x03	7C
TAS5036B	System control register 1	0x03	7C
TAS5066	System control register 1	0x03	7C
TAS5076	System control register 1	0x03	7C
TAS5028	System control register 2	0x04	60
TAS5508	System control register 2	0x04	60
TAS5518	System control register 2	0x04	60

2.3 Advanced Setup

If the click is small compared to the noise floor, it can be difficult to get the audio measurement system to trigger correctly. Also, if it is required to link the click to a specific event in the system (e.g., power-up sequence), it can be helpful to let an oscilloscope do the triggering. Most digital oscilloscopes have advanced trigger functions to make the trigger able to find a specific event. Furthermore, the audio measurement system can measure the click at the speaker terminals, although the oscilloscope trigger is set to an event elsewhere in the unit.

The requirement for the oscilloscope is that it must have a trigger output. The trigger output of the oscilloscope is then connected to external trigger input of the audio measurement system. The trigger input is located on the rear panel of the audio measurement system. The System Two Cascade has a dedicated BNC connector for its trigger input, whereas the System Two has a general-purpose serial I/O connector; pin 3 on this connector is the external trigger input, and ground is on pin 1.



C004

Figure 9. External Trigger

To use an oscilloscope as trigger for the audio measurement system, the trigger source selected must be External (see [Figure 9](#)).

2.4 How to Interpret the Result

A click test result can be divided into two components, a dc component (dc step) and an ac component.

2.4.1 DC Component

The dc component or dc step is best seen in the time domain. [Figure 10](#) shows a 10-mV dc step. The dc step can come from mismatch in the power stage between each side of the speaker terminals.

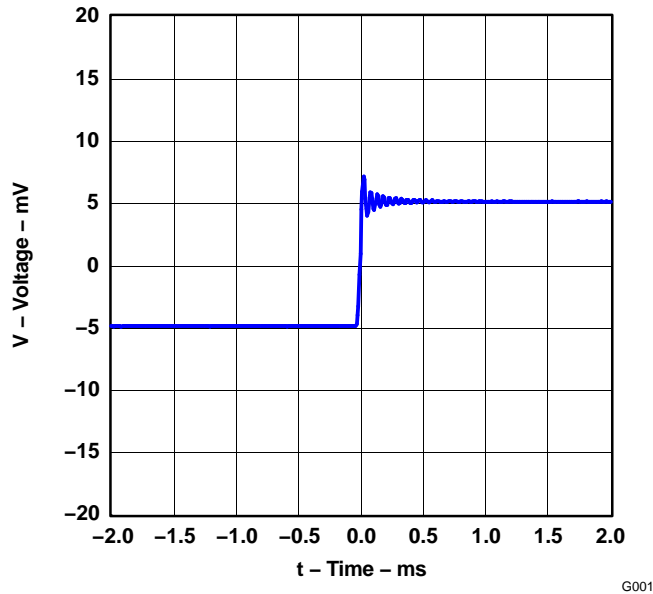

Figure 10. DC Step

In the frequency domain, a dc step is seen as a curve falling with 20 dB/decade. This is seen in [Figure 11](#). The rapid fall at 20 kHz is due to the AES17 filter.

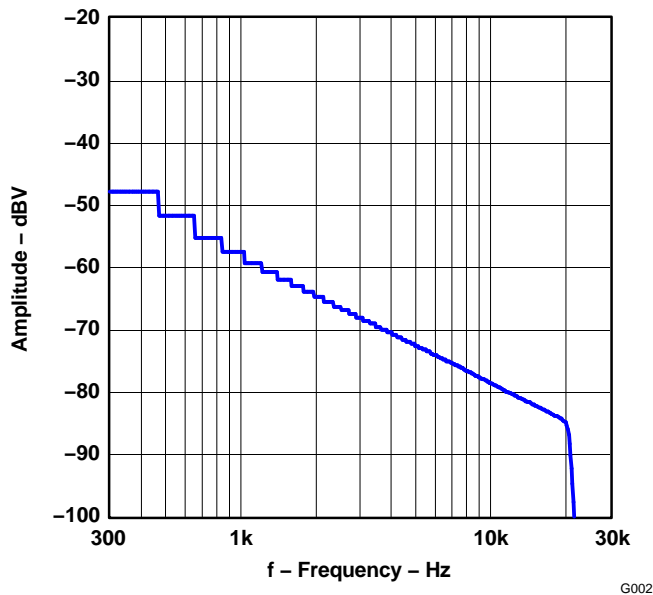

Figure 11. DC Step in Frequency Domain

2.4.2 AC Components

AC components are caused by several factors:

- Start and stop of PWM
- Stop of noise shaper activity
- Transients on PVDD (single-ended only)

These components give a click typically in the frequency range from 1 kHz to 20 kHz. If the PWM is started and stopped randomly, a loud click is generated. TI PWM modulators have implemented a sequence that ensures minimum click during start and stop of the PWM. [Figure 12](#) shows the click generated when the PWM is stopped under both conditions. The blue curve is the click for a random stop and the red curve is the click for a stop controlled by the TAS5508 PWM modulator. It is seen that the difference in a controlled and an uncontrolled stop is more than 20 dB from 1 kHz to 10 kHz.

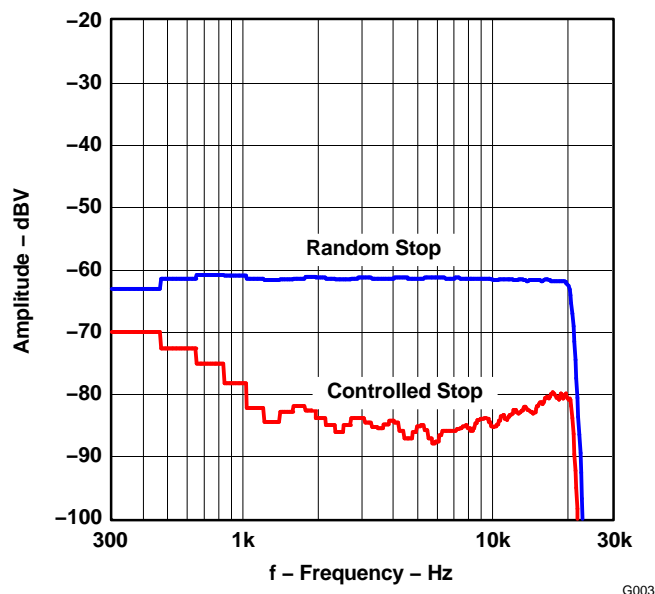

Figure 12. Asynchronous Stop of PWM

The measurement shown is on a TAS5508-5122C6EVM, where PWM is stopped asynchronously by pulling error_recovery low. The controlled stop is done by sending a mute command via the I²C interface.

3 What Is a Loud Click?

The audibility of a click follows the sensitivity of the ear.

The sensitivity of the human ear is described in the Fletcher-Munson curves. These curves represent what sound pressure the ear perceives as equally loud over frequency. It also gives the threshold beyond which the human ear no longer can perceive a sound.

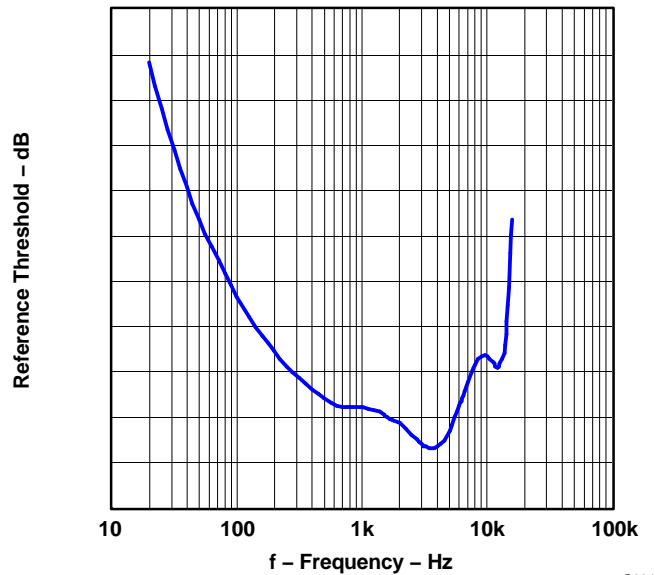

NOTE: Vertical scale given in ISO 389-7:1996 (see Reference 1).

Figure 13. Threshold of Hearing

However, the Fletcher-Munson curves are generated in a listening test using constant sine waves. This means that the absolute levels in this curve cannot directly be used for clicks, because the energy level of a click is much smaller than a constant sine wave, even though it is spread over frequency. The relative sound pressure over frequency can, however, be assumed to be similar.

The hearing threshold can be approximated by three curves as shown in Figure 14. The first curve for low frequencies falls by 20 dB/decade, the second is a horizontal curve for midrange frequencies, and the third for high frequencies rises 20 dB/decade.

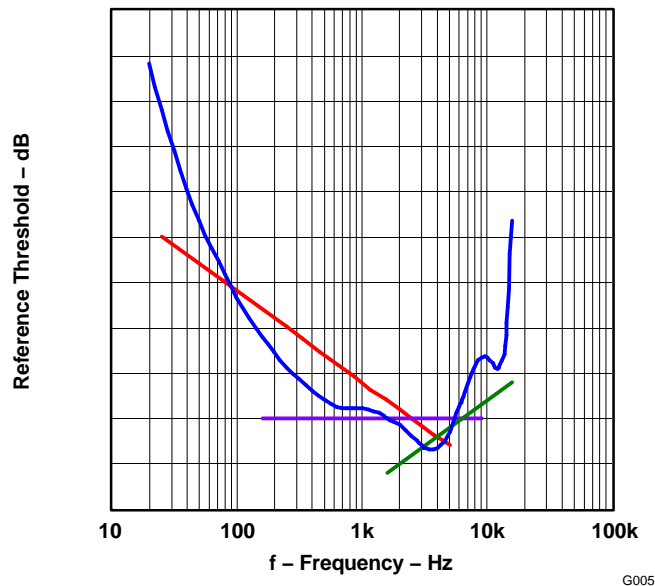

NOTE: Vertical scale given in ISO 389-7:1996 (see Reference 1).

Figure 14. Threshold Approximation

Listening tests with clicks having the frequency contents the same as the three approximation curves then give the hearing threshold for clicks.

What Is a Loud Click?

By assuming a speaker with the sensitivity of 96 dB (relative to 20 μ Pa at 2.83 V_{RMS}) and a listening position of 1 m from the speaker, the corresponding threshold can be found on the speaker terminals in dBV. This is shown in Figure 15 (lower curve).

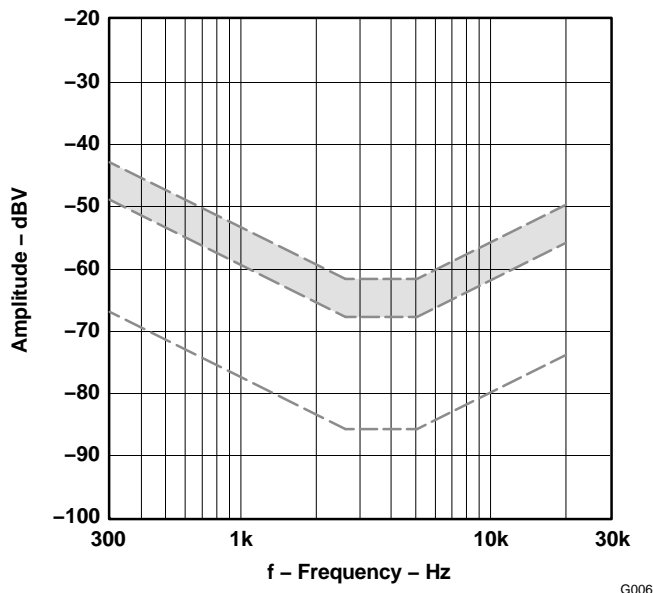

Figure 15. Click and Pop Test Limits

The click listening test is done in an absolutely silent room, and the speaker sensitivity used to calculate voltage on speaker terminals from sound pressure is much higher than actual speakers. Both conditions are unrealistic in a real application. Therefore, an acceptance level of 18 dB to 24 dB above the threshold is added (Figure 15, upper curve). Limit values are shown in the following tables for 192-kHz and 262.144-kHz sample rates: System Two (see Table 2) and System Two Cascade (see Table 3).

Table 2. Click and Pop Test Limits, System Two

FREQUENCY	HEARING THRESHOLD	ACCEPTANCE LIMIT
100 Hz	-57.4 dBV	-39.4 dBV to -33.4 dBV
2.63 kHz	-85.8 dBV	-67.8 dBV to -61.8 dBV
5.08 kHz	-85.8 dBV	-67.8 dBV to -61.8 dBV
20 kHz	-73.9 dBV	-55.9 dBV to -49.9 dBV

Table 3. Click and Pop Test Limits, System Two Cascade

FREQUENCY	HEARING THRESHOLD	ACCEPTANCE LIMIT
100 Hz	-54.7 dBV	-36.7 dBV to -30.7 dBV
2.63 kHz	-83.1 dBV	-65.1 dBV to -59.1 dBV
5.08 kHz	-83.1 dBV	-65.1 dBV to -59.1 dBV
20 kHz	-71.2 dBV	-53.2 dBV to -47.2 dBV

These values can be programmed into a limit file in the audio measurement system. The low-frequency limit is set by the dc offset. Hence, the low-frequency limit can be expressed as a dc limit in the time domain: the dc step must be less than 10.7 mV to 21.4 mV.

4 Click and Pop Measurements Examples

Figure 16 shows the click and pop performance of the TAS5066-5121K6EVM. This EVM uses the TAS5066 PWM modulator, which uses TI's first generation of PurePath Digital click and pop reduction. This EVM is equipped with a 6x TAS5121DKD power stage.

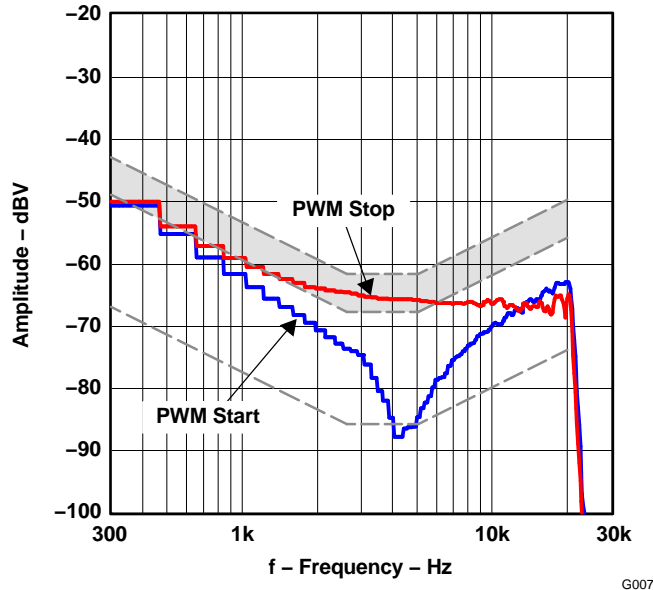

NOTE: Measurements obtained using System Two audio measurement system.

Figure 16. TAS5066-5121K6EVM

The clicks during start and stop are within the acceptance limit. At low frequencies, the FFT falls at 20 dB/decade. This is caused by a dc step of approximately 10 mV. The amplitude of the dc step is the same at PWM start and PWM stop. In the midrange, the start sequence performs better than the stop sequence. This is mainly caused by the first generation click and pop reduction technique.

Figure 17 shows the click and pop measurement for the TAS5508-5121K8EVM. The TAS5508 PWM modulator uses TI's third generation of PurePath Digital click and pop reduction.

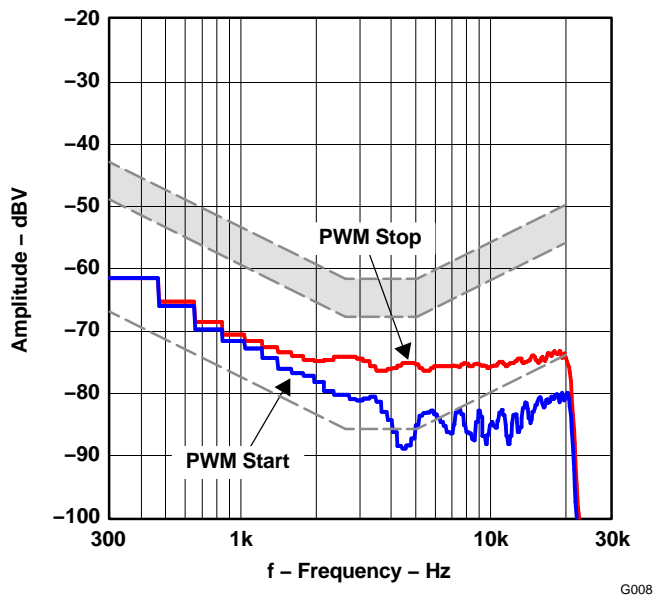

NOTE: Measurements obtained using System Two audio measurement system.

Figure 17. TAS5508-5121K8EVM

Reference

The measurement shows that the third-generation click and pop reduction technique has reduced the click in the midrange. The click is hardly audible.

5 Reference

1. *Acoustics – Reference zero for the calibration of audiometric equipment – Part 7: Reference threshold of hearing under free-field and diffuse-field listening conditions (ISO 389-7:1996)*

IMPORTANT NOTICE

Texas Instruments Incorporated and its subsidiaries (TI) reserve the right to make corrections, modifications, enhancements, improvements, and other changes to its products and services at any time and to discontinue any product or service without notice. Customers should obtain the latest relevant information before placing orders and should verify that such information is current and complete. All products are sold subject to TI's terms and conditions of sale supplied at the time of order acknowledgment.

TI warrants performance of its hardware products to the specifications applicable at the time of sale in accordance with TI's standard warranty. Testing and other quality control techniques are used to the extent TI deems necessary to support this warranty. Except where mandated by government requirements, testing of all parameters of each product is not necessarily performed.

TI assumes no liability for applications assistance or customer product design. Customers are responsible for their products and applications using TI components. To minimize the risks associated with customer products and applications, customers should provide adequate design and operating safeguards.

TI does not warrant or represent that any license, either express or implied, is granted under any TI patent right, copyright, mask work right, or other TI intellectual property right relating to any combination, machine, or process in which TI products or services are used. Information published by TI regarding third-party products or services does not constitute a license from TI to use such products or services or a warranty or endorsement thereof. Use of such information may require a license from a third party under the patents or other intellectual property of the third party, or a license from TI under the patents or other intellectual property of TI.

Reproduction of information in TI data books or data sheets is permissible only if reproduction is without alteration and is accompanied by all associated warranties, conditions, limitations, and notices. Reproduction of this information with alteration is an unfair and deceptive business practice. TI is not responsible or liable for such altered documentation.

Resale of TI products or services with statements different from or beyond the parameters stated by TI for that product or service voids all express and any implied warranties for the associated TI product or service and is an unfair and deceptive business practice. TI is not responsible or liable for any such statements.

Following are URLs where you can obtain information on other Texas Instruments products and application solutions:

Products		Applications	
Amplifiers	amplifier.ti.com	Audio	www.ti.com/audio
Data Converters	dataconverter.ti.com	Automotive	www.ti.com/automotive
DSP	dsp.ti.com	Broadband	www.ti.com/broadband
Interface	interface.ti.com	Digital Control	www.ti.com/digitalcontrol
Logic	logic.ti.com	Military	www.ti.com/military
Power Mgmt	power.ti.com	Optical Networking	www.ti.com/opticalnetwork
Microcontrollers	microcontroller.ti.com	Security	www.ti.com/security
		Telephony	www.ti.com/telephony
		Video & Imaging	www.ti.com/video
		Wireless	www.ti.com/wireless

Mailing Address: Texas Instruments
Post Office Box 655303 Dallas, Texas 75265