



Hermon Laboratories Ltd.
Harakevet Industrial Zone, Binyamina 30500,
Israel
Tel. +972-4-6288001
Fax. +972-4-6288277
E-mail: mail@hermonlabs.com

PARTIAL RADIATED EMISSIONS AND RADIATED IMMUNITY TEST REPORT

ACCORDING TO: EN 300 386 V1.4.1: 2008 with manufacturer's deviations:
Radiated immunity of 10 V/m in 80 – 1000 MHz range

FOR:

**Texas Instruments (Israel) Cable
Broadband Com.**

**TI chip, model TLK106 32p QFN
placed on Evaluation board,
model Pc483**

This report is in conformity with ISO/IEC 17025. The "A2LA Accredited" symbol endorsement applies only to the tests and calibrations that are listed in the scope of Hermon Laboratories accreditation. The test results relate only to the items tested.
This test report shall not be reproduced in any form except in full with the written approval of Hermon Laboratories Ltd.

Table of contents

1	Applicant information.....	3
2	Equipment under test attributes	3
3	Manufacturer information	3
4	Test details.....	3
5	Tests summary.....	4
6	EUT description.....	5
6.1	General information.....	5
6.2	Ports and lines	5
6.3	Support and test equipment	5
6.4	Test configuration.....	6
6.5	Performance criteria	7
6.6	Acceptance criteria.....	7
7	Emissions tests	8
7.1	Radiated disturbance	8
8	Immunity tests	19
8.1	Radiated immunity to radio frequency electromagnetic field	19
9	APPENDIX A Test equipment and ancillaries used for tests.....	25
10	APPENDIX B Measurement uncertainties.....	26
11	APPENDIX C Test laboratory description	27
12	APPENDIX D Specification references	27
13	APPENDIX E Test equipment correction factors.....	28
14	APPENDIX F Abbreviations and acronyms.....	30



1 Applicant information

Client name: Texas Instruments (Israel) Cable Broadband Com.
Address: 26 Zarchin Street, 43662 Raanana, Israel
Telephone: +972 9970 6969
Fax: +972 9970 6500
E-mail: noam.sadan@ti.com
Contact name: Mr. Noam Sadan

2 Equipment under test attributes

Product name: TI chip, model TLK106 32p QFN placed on Evaluation board, model Pc483
Model(s): TLK106 32p QFN
Serial number: 59904
Hardware version: 1
Software release: 1
Receipt date: 12/11/2012

3 Manufacturer information

Manufacturer name: Texas Instruments (Israel) Cable Broadband Com.
Address: 26 Zarchin Street, 43662 Raanana, Israel
Telephone: +972 9970 6969
Fax: +972 9970 6500
E-Mail: noam.sadan@ti.com
Contact name: Mr. Noam Sadan

4 Test details

Project ID: 23556
Location: Hermon Laboratories Ltd. Harakevet Industrial Zone, Binyamina 30500, Israel
Test started: 12/11/2012
Test completed: 12/12/2012
Test specification(s): EN 300 386 V1.4.1: 2008 with manufacturer's deviations:
Radiated immunity of 10 V/m in 80 – 1000 MHz range



5 Tests summary

Test	Status
EN 300 386 with manufacturer's deviations	
Radiated emissions, Class B	Pass preliminary test
Radiated immunity to radio frequency electromagnetic field of 10 V/m in 80 – 1000 MHz range	Pass preliminary test

The test results relate only to the items tested.

	Name and Title	Date	Signature
Tested by:	Mr. V. Dorofeyev, test engineer	December 12, 2012	
Reviewed by:	Mrs. M. Cherniavsky, certification engineer	April 15, 2013	
Approved by:	Mr. M. Nikishin, EMC and radio group manager	May 5, 2013	



6 EUT description

6.1 General information

The EUT is TI chip (Ethernet device) placed on the evaluation board enclosed in a metal enclosure. The EUT is powered from 5 VDC.

6.2 Ports and lines

Port type	Port description	Connected from	Connected to	Qty.	Cable type	Cable length, m
Signal	Ethernet	EUT	External loopback	1	Shielded	2.5
Control	USB	Laptop	USB2MII Board (FPGA Board)	1	Shielded	5

6.3 Support and test equipment

Description	Manufacturer	Model number	Serial number
Laptop	Dell	D630	E0101139-00
USB2MII Board (FPGA Board)	Texas instruments	Pc126	42662

6.4 Test configuration

6.4.1 EUT setup for radiation through cable

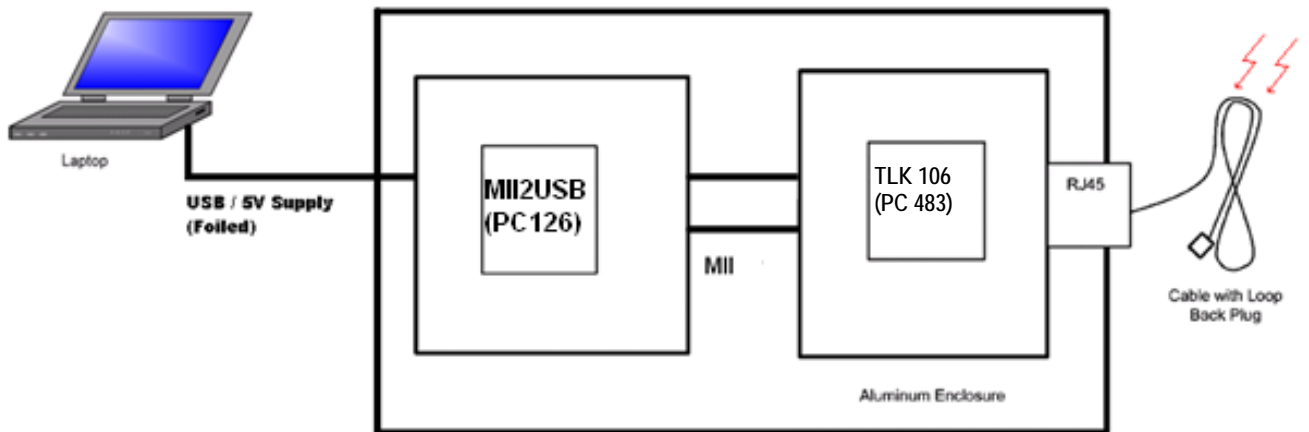

6.4.2 EUT setup for radiation from the EUT pins

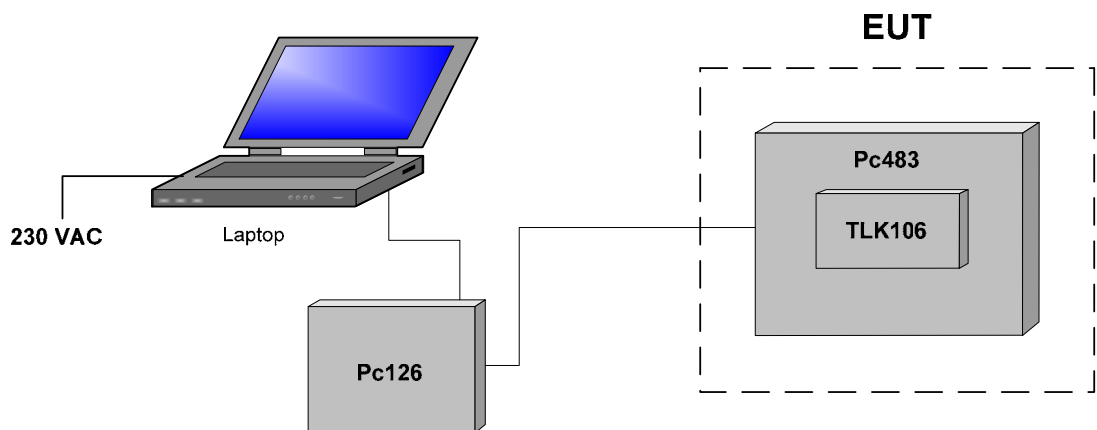

6.5 Performance criteria

6.5.1 General performance criteria of EN 300 386, Section 10

6.5.1.1 Performance criterion A

The equipment shall continue to operate as intended. No degradation of performance or loss of function is allowed below a performance level specified by the manufacturer when the equipment is used as intended. The performance level may be replaced by a permissible loss of performance. If the manufacturer does not specify the minimum performance level or the permissible performance loss, then either of these may be derived from the product description and documentation, and by what the user may reasonably expect from the equipment if used as intended.

6.5.2 Specific performance criteria of EN 300 386, Section 11 (Switching equipment specific requirements)

6.5.2.1 11.3.1 Digital ports

Performance criterion A:

During the sweep:

- the established connections shall be maintained throughout testing and the transfer of information shall be within the limits of the manufacturer's specification;
- loss of frame alignment or loss of synchronization is not allowed during each individual exposure.

For selected frequencies :

- it shall be possible to establish a connection between two ports;
- it shall be possible to clear a connection in a controlled manner.

6.5.3 Specific performance criteria of EN 300 386, Section 12 (Transmission equipment specific requirements)

6.5.3.1 12.3.1 Digital signal ports

Performance criterion A:

The performance of the equipment shall be verified by measuring the additional errors induced due to the application of any electromagnetic phenomena. During the test sweep the established connection shall be maintained throughout the testing and the transfer of information shall be without any reproducible bit errors. If degradation in performance is observed and the system is adaptive i.e. has capability to automatically re-train in the presence of an interfering signal, then for conducted immunity tests only the following procedure shall be followed:

- For each range of interfering frequencies, where degradation in performance is observed, three frequencies (beginning, middle and end) shall be identified.
- At each of the frequencies identified in step 1, the interfering signal shall be turned and the system allowed to re-train. If the system is able to re-train and then function with respect to the performance criteria A then the system performance is considered acceptable.
- The frequencies identified in step 1 shall be recorded in the test report.

6.6 Acceptance criteria

Data packets shall be transmitted from TI chip, using its internal PRBS generator to an external loopback, which returns the packets to TI chip to compare to transmitted packets. No data packets error is allowed during the test.



Test specification:		Section 6 Class B, Radiated disturbance	
Test procedure:		EN 55022, Section 10	
Test mode:		Compliance	
Date(s):		12/12/2012	
Temperature: 23 °C		Air Pressure: 1015 hPa	
Remarks:		Verdict: PASS	
		Relative Humidity: 39 %	
		Power Supply: 5 VDC	

7 Emissions tests

7.1 Radiated disturbance

7.1.1 General

This test was performed to measure radiated disturbance from the EUT enclosure. The specification test limits are given in Table 7.1.1.

Table 7.1.1 Radiated disturbance limits

Frequency, MHz	Class B limit, dB(μV/m)			
	Peak @3 m	Quasi-peak		Average @3 m
		@10 m	@3 m	
30 - 230	—	30.0	40.5*	—
230 - 1000	—	37.0	47.5*	—
1000 – 3000	70	—	—	50
3000 - 6000	74	—	—	54

* The limit for test distance other than specified was calculated using the inverse linear distance extrapolation factor as follows: $Lim_{S_2} = Lim_{S_1} + 20 \log(S_1/S_2)$, where S_1 and S_2 – standard defined and test distance respectively in meters.

7.1.2 Test procedure

7.1.2.1 The EUT was set up as shown in Figure 7.1.1 and the associated photographs, energized and the EUT performance was checked.

7.1.2.2 The preliminary measurements were performed in the anechoic chamber at 3 m test distance. The specified frequency range was investigated with the antenna connected to the EMI receiver. To find maximum radiation the turntable was rotated 360° and the measuring antenna height was swept from 1 to 4 m in both, vertical and horizontal polarizations.

7.1.2.3 The worst test results for radiation through cable with respect to the limits were recorded in Table 7.1.2 and shown in the associated plots.

7.1.2.4 The test was repeated for evaluation of radiation from pins, the test results are shown in the associated plots.

Test specification: Section 6 Class B, Radiated disturbance			
Test procedure: EN 55022, Section 10			
Test mode: Compliance		Verdict: PASS	
Date(s): 12/12/2012			
Temperature: 23 °C	Air Pressure: 1015 hPa	Relative Humidity: 39 %	Power Supply: 5 VDC
Remarks:			

Figure 7.1.1 Setup for radiated emissions measurements in anechoic chamber, table-top EUT

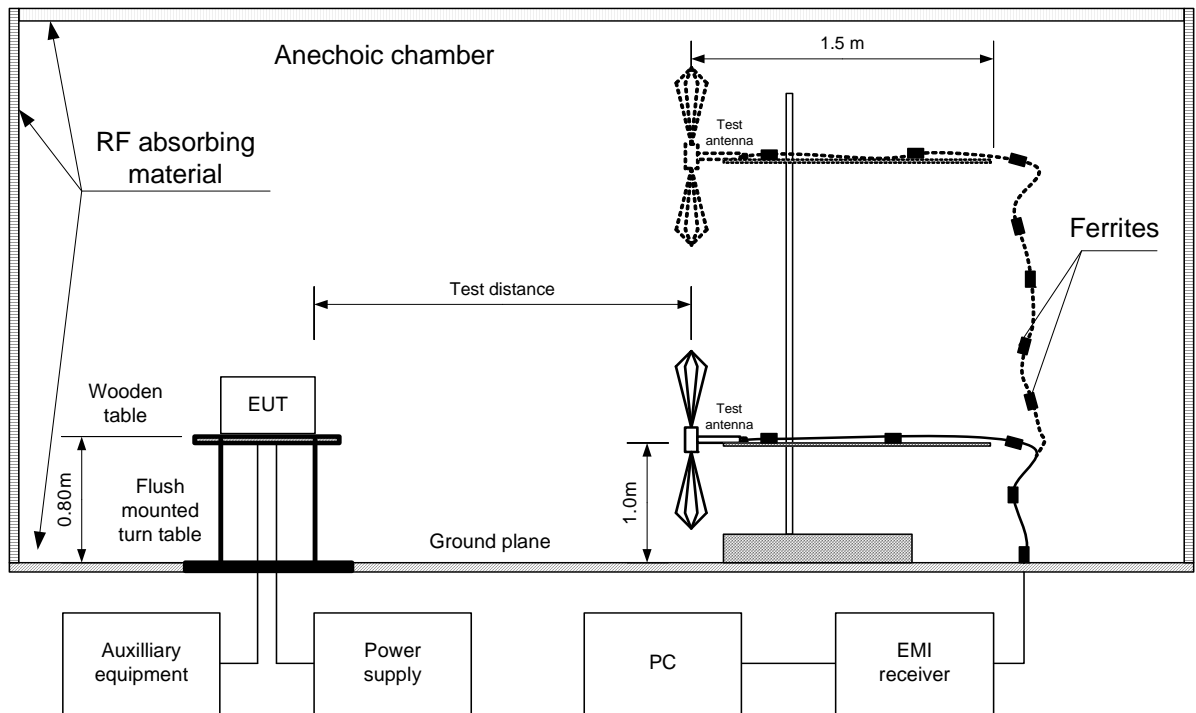

Test specification:	Section 6 Class B, Radiated disturbance		
Test procedure:	EN 55022, Section 10		
Test mode:	Compliance	Verdict:	PASS
Date(s):	12/12/2012		
Temperature: 23 °C	Air Pressure: 1015 hPa	Relative Humidity: 39 %	Power Supply: 5 VDC
Remarks:			

Photograph 7.1.1 Setup for preliminary radiated disturbance measurements, general view, EUT radiation through cable



Photograph 7.1.2 Setup for preliminary radiated disturbance measurements, general view, EUT radiation through cable



Test specification:	Section 6 Class B, Radiated disturbance		
Test procedure:	EN 55022, Section 10		
Test mode:	Compliance	Verdict:	PASS
Date(s):	12/12/2012		
Temperature: 23 °C	Air Pressure: 1015 hPa	Relative Humidity: 39 %	Power Supply: 5 VDC
Remarks:			

Photograph 7.1.3 Setup for radiated disturbance measurements, EUT radiation through cable

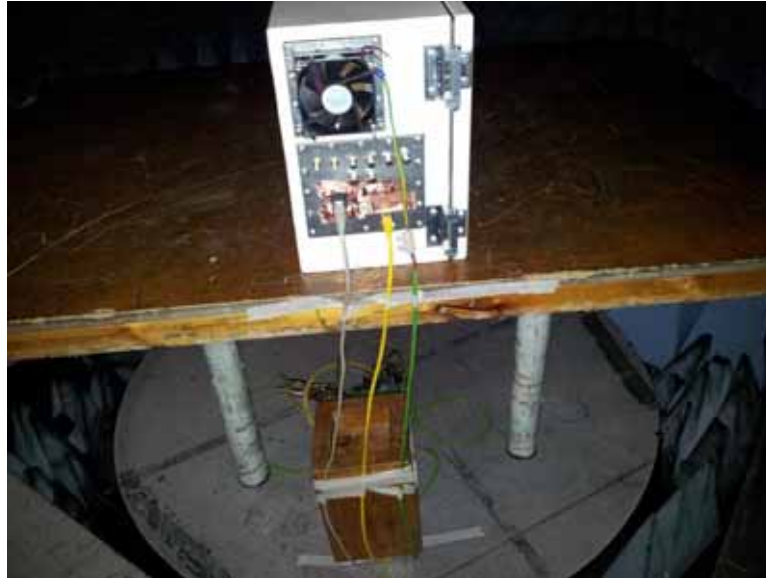

Photograph 7.1.4 Setup for radiated disturbance measurements, EUT close view





Test specification: Section 6 Class B, Radiated disturbance			
Test procedure: EN 55022, Section 10			
Test mode: Compliance		Verdict: PASS	
Date(s): 12/12/2012			
Temperature: 23 °C	Air Pressure: 1015 hPa	Relative Humidity: 39 %	Power Supply: 5 VDC
Remarks:			

Table 7.1.2 Radiated disturbance test results

EUT SET UP: TABLE-TOP
 TEST SITE: Fully anechoic chamber
 TEST DISTANCE: 3 m
 DETECTORS USED: PEAK / QUASI-PEAK
 FREQUENCY RANGE: 30 MHz – 1000 MHz
 RESOLUTION BANDWIDTH: 120 kHz

TLK106 32p QFN radiation through cable

Frequency, MHz	Peak emission, dB(μV/m)	Quasi-peak			Antenna polarization	Antenna height, m	Turn-table position**, degrees	Verdict
		Measured emission, dB(μV/m)	Limit, dB(μV/m)	Margin, to peak dB*				
32.41	37.97	Note*	40.5	-5.56	Vertical	Note*	Note*	Pass*
171.87	29.97	Note*	40.5	-10.53	Horizontal	Note*	Note*	

*Note: Quasi-peak emission was not measured

DETECTORS USED: PEAK / AVERAGE
 FREQUENCY RANGE: 1000 MHz – 2900 MHz
 RESOLUTION BANDWIDTH: 1000 kHz
 TEST SITE: Fully anechoic chamber
 TEST DISTANCE: 3 m

TLK106 32p QFN radiation through cable

Frequency, MHz	Peak			Average			Antenna polarization	Antenna height, m	Turn-table position**, degrees	Verdict
	Measured emission, dB(μV/m)	Limit, dB(μV/m)	Margin, dB*	Measured emission, dB(μV/m)	Limit, dB(μV/m)	Margin, dB*				
No emissions were found										Pass

Reference numbers of test equipment used

HL 2432	HL 2697	HL 4150	HL 4347	HL 4349			
---------	---------	---------	---------	---------	--	--	--

Full description is given in Appendix A.

Test specification:		Section 6 Class B, Radiated disturbance	
Test procedure:		EN 55022, Section 10	
Test mode:		Compliance	
Date(s):		12/12/2012	
Temperature: 23 °C		Air Pressure: 1015 hPa	
		Relative Humidity: 39 %	
		Power Supply: 5 VDC	
Remarks:			

Plot 7.1.1 Radiated disturbance measurements in 30 - 1000 MHz range, vertical antenna polarization

TEST SITE: Fully anechoic chamber
TEST DISTANCE: 3 m

TLK106 32p QFN radiation through cable

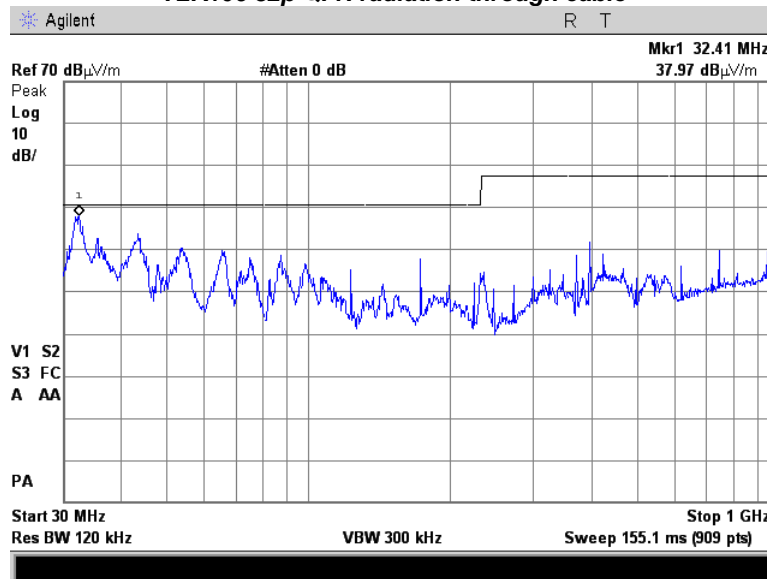

Plot 7.1.2 Radiated disturbance measurements in 30 - 1000 MHz range, horizontal antenna polarization

TEST SITE: Fully anechoic chamber
TEST DISTANCE: 3 m

TLK106 32p QFN radiation through cable

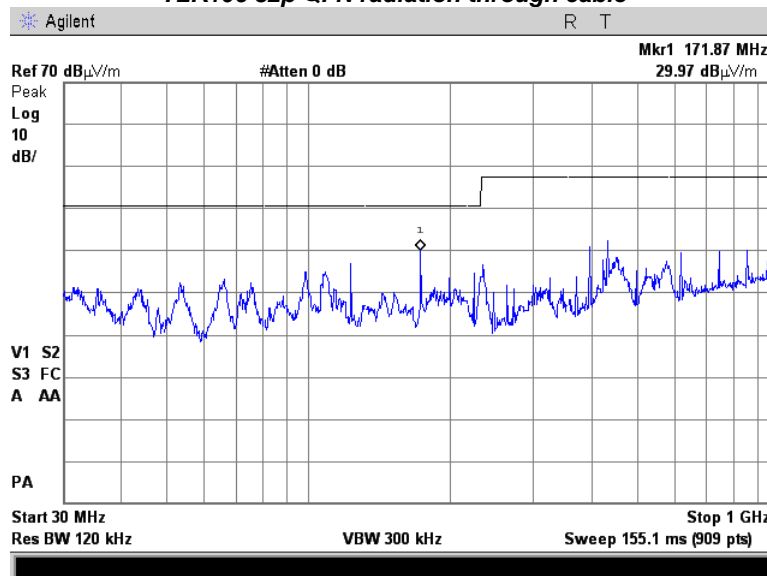

Test specification:		Section 6 Class B, Radiated disturbance	
Test procedure:		EN 55022, Section 10	
Test mode:		Compliance	
Date(s):		12/12/2012	
Temperature: 23 °C		Air Pressure: 1015 hPa	
		Relative Humidity: 39 %	
		Power Supply: 5 VDC	
Remarks:			

Plot 7.1.3 Radiated disturbance measurements in 1000 – 2900 MHz range, vertical antenna polarization

TEST SITE: Fully anechoic chamber
TEST DISTANCE: 3 m

TLK106 32p QFN radiation through cable

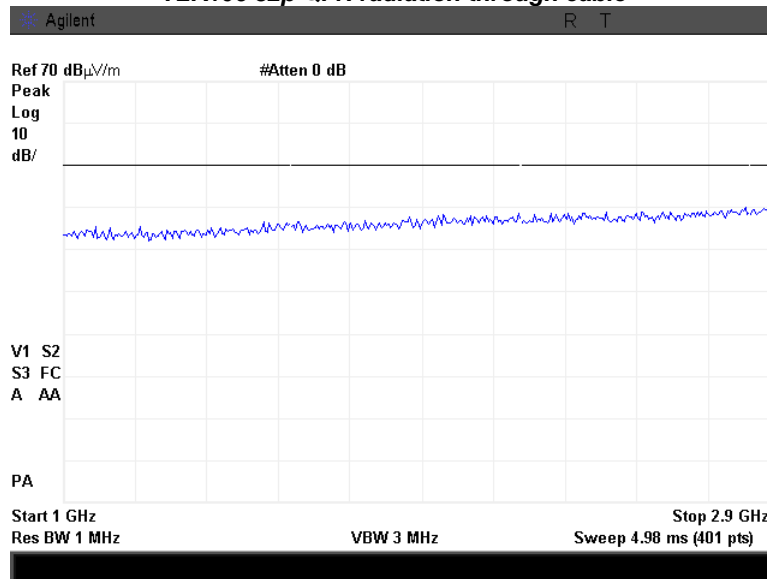

Plot 7.1.4 Radiated disturbance measurements in 1000 – 2900 MHz range, horizontal antenna polarization

TEST SITE: Fully anechoic chamber
TEST DISTANCE: 3 m

TLK106 32p QFN radiation through cable

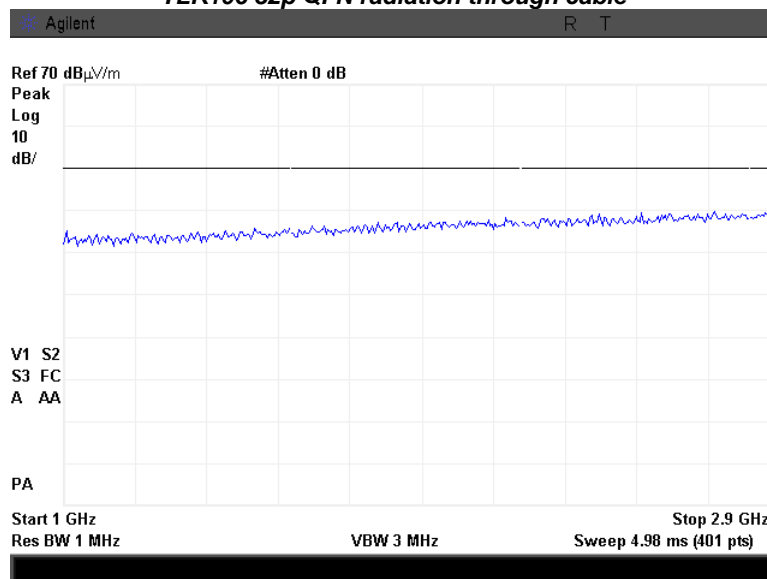

Test specification:	Section 6 Class B, Radiated disturbance		
Test procedure:	EN 55022, Section 10		
Test mode:	Compliance	Verdict:	PASS
Date(s):	12/12/2012		
Temperature: 23 °C	Air Pressure: 1015 hPa	Relative Humidity: 39 %	Power Supply: 5 VDC
Remarks:			

Photograph 7.1.5 Setup for radiated disturbance measurements, radiation from EUT pins



Photograph 7.1.6 Setup for radiated disturbance measurements, radiation from EUT pins



Test specification:	Section 6 Class B, Radiated disturbance		
Test procedure:	EN 55022, Section 10		
Test mode:	Compliance	Verdict:	PASS
Date(s):	12/12/2012		
Temperature: 23 °C	Air Pressure: 1015 hPa	Relative Humidity: 39 %	Power Supply: 5 VDC
Remarks:			

Photograph 7.1.7 Setup for radiated disturbance measurements, radiation from EUT pins



Test specification:		Section 6 Class B, Radiated disturbance	
Test procedure:		EN 55022, Section 10	
Test mode:		Compliance	
Date(s):		12/12/2012	
Temperature: 23 °C		Air Pressure: 1015 hPa	
		Relative Humidity: 39 %	
		Power Supply: 5 VDC	
Remarks:			

Plot 7.1.5 Radiated disturbance measurements in 30 - 1000 MHz range, vertical antenna polarization

TEST SITE: Fully anechoic chamber
TEST DISTANCE: 3 m

TLK106 32p QFN radiation from EUT pins

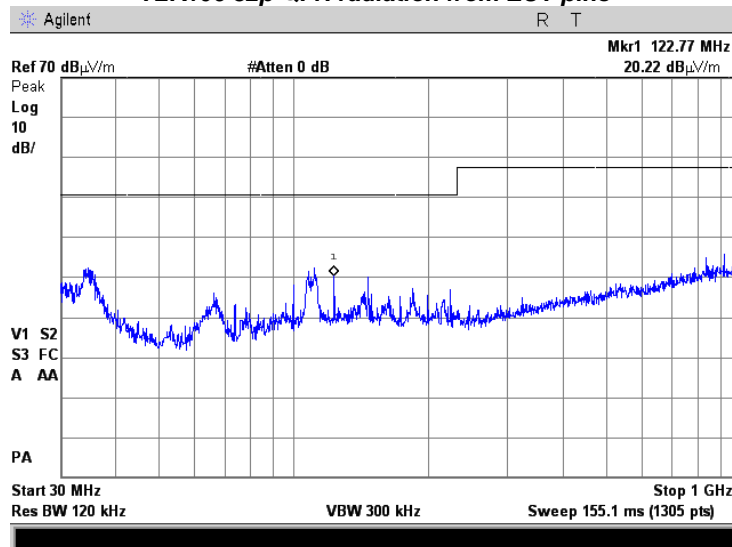

Note: To find the highest emission the measuring antenna height was swept from 1 to 1.8 m (turntable was not rotated)

Plot 7.1.6 Radiated disturbance measurements in 30 - 1000 MHz range, horizontal antenna polarization

TEST SITE: Fully anechoic chamber
TEST DISTANCE: 3 m

TLK106 32p QFN radiation from EUT pins

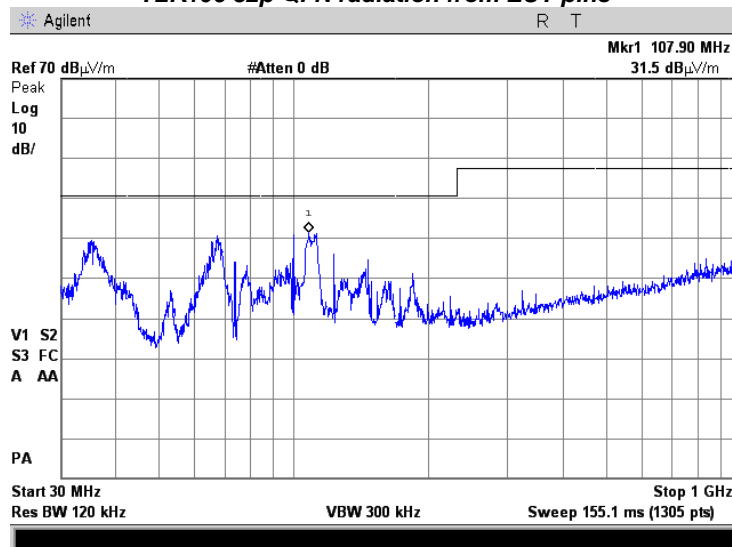

Note: To find the highest emission the measuring antenna height was swept from 1 to 1.8 m (turntable was not rotated)

Test specification:		Section 6 Class B, Radiated disturbance	
Test procedure:		EN 55022, Section 10	
Test mode:		Compliance	
Date(s):		12/12/2012	
Temperature: 23 °C		Air Pressure: 1015 hPa	
		Relative Humidity: 39 %	
		Power Supply: 5 VDC	
Remarks:			

Plot 7.1.7 Radiated disturbance measurements in 1000 – 2900 MHz range, vertical antenna polarization

TEST SITE: Fully anechoic chamber
TEST DISTANCE: 3 m

TLK106 32p QFN radiation from EUT pins

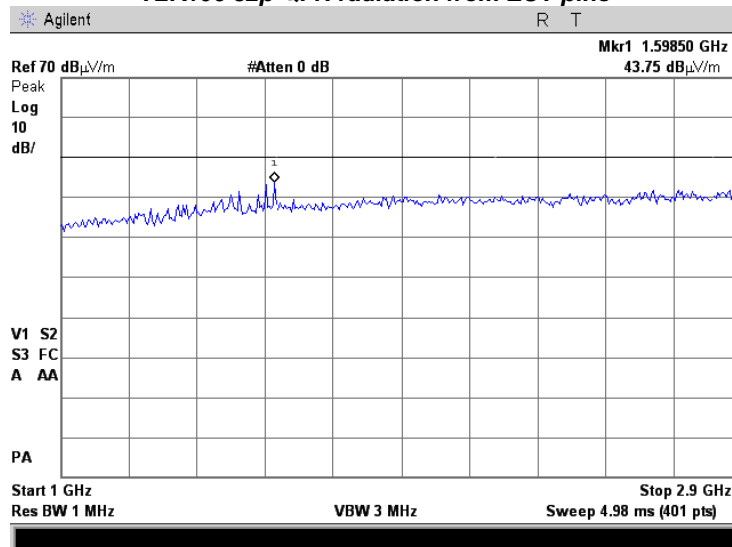

Note: To find the highest emission the measuring antenna height was swept from 1 to 1.8 m (turntable was not rotated)

Plot 7.1.8 Radiated disturbance measurements in 1000 – 2900 MHz range, horizontal antenna polarization

TEST SITE: Fully anechoic chamber
TEST DISTANCE: 3 m

TLK106 32p QFN radiation from EUT pins

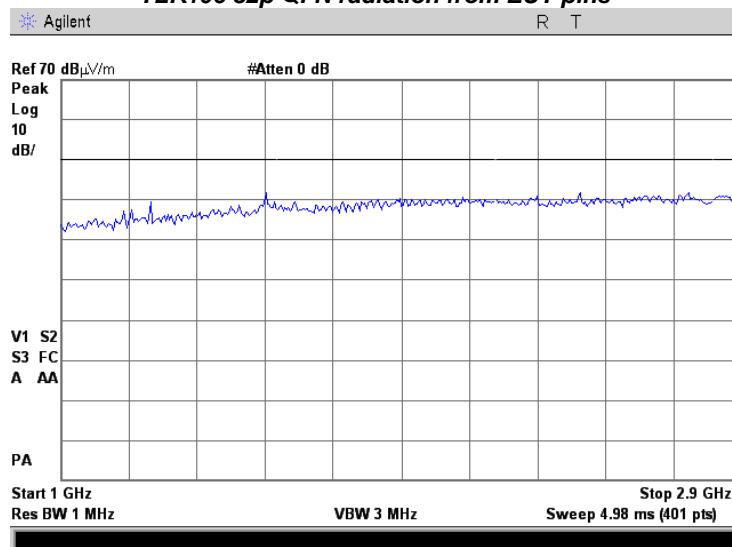

Note: To find the highest emission the measuring antenna height was swept from 1 to 1.8 m (turntable was not rotated)

Test specification:	Radiated immunity to radio frequency electromagnetic field		
Test procedure:	EN 61000-4-3; EN 55024, Section 4.2.3.1		
Test mode:	Evaluation	Verdict:	PASS
Date(s):	12/11/2012 - 12/12/2012		
Temperature: 23 °C	Air Pressure: 1014 hPa	Relative Humidity: 39 %	Power Supply: 5 VDC
Remarks:			

8 Immunity tests

8.1 Radiated immunity to radio frequency electromagnetic field

8.1.1 General

This test was performed to verify the EUT immunity to radiated radio frequency electromagnetic field. The radiated RF electromagnetic field levels, performance criterion and test results are referred to in Table 8.1.1.

8.1.2 Test procedure

- 8.1.2.1 The EUT was set up as shown in Figure 8.1.1 and the associated photographs, energized and the EUT performance was checked.
- 8.1.2.2 The electric field generating antenna was installed facing the EUT front panel at the specified distance.
- 8.1.2.3 The test setup was adjusted to produce the required field strength level. The field strength was monitored by the isotropic field probe, which was placed near the EUT.
- 8.1.2.4 The signal frequency was scanned throughout the frequency range.
- 8.1.2.5 The test was performed with antenna/s in both vertical and horizontal polarizations.
- 8.1.2.6 The test was repeated at selected frequencies.
- 8.1.2.7 The EUT operation was monitored throughout the test for any malfunction or degradation and its performance was recorded.
- 8.1.2.8 Upon this the test was completed.

Test specification:		Radiated immunity to radio frequency electromagnetic field	
Test procedure:		EN 61000-4-3; EN 55024, Section 4.2.3.1	
Test mode:		Evaluation	
Date(s):		12/11/2012 - 12/12/2012	
Temperature: 23 °C		Air Pressure: 1014 hPa	
Relative Humidity: 39 %		Power Supply: 5 VDC	
Remarks:			
Verdict:		PASS	

Figure 8.1.1 Setup for radiated immunity to RF electromagnetic field test, table-top EUT

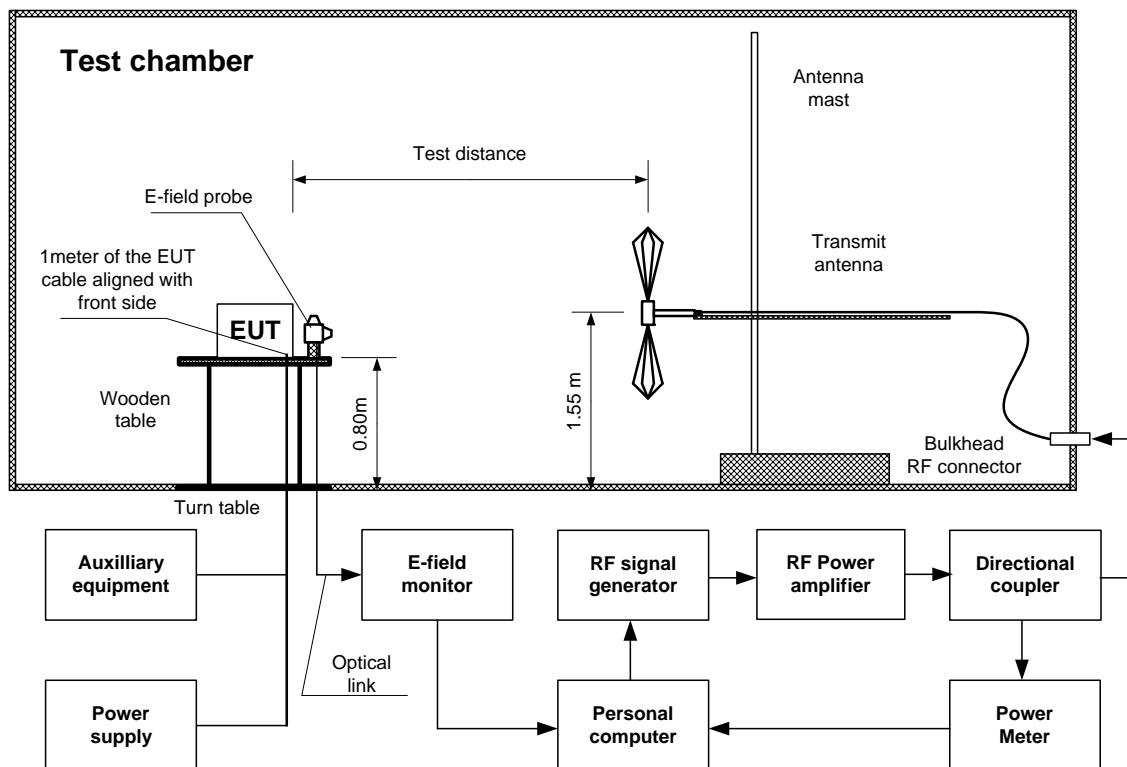

Test specification:	Radiated immunity to radio frequency electromagnetic field		
Test procedure:	EN 61000-4-3; EN 55024, Section 4.2.3.1		
Test mode:	Evaluation	Verdict:	PASS
Date(s):	12/11/2012 - 12/12/2012		
Temperature: 23 °C	Air Pressure: 1014 hPa	Relative Humidity: 39 %	Power Supply: 5 VDC
Remarks:			

Photograph 8.1.1 Setup for radiated immunity to RF electromagnetic field test, general view, EUT radiation through cable



Photograph 8.1.2 Setup for radiated immunity to RF electromagnetic field test, EUT close view, EUT radiation through cable



Test specification:	Radiated immunity to radio frequency electromagnetic field		
Test procedure:	EN 61000-4-3; EN 55024, Section 4.2.3.1		
Test mode:	Evaluation	Verdict:	PASS
Date(s):	12/11/2012 - 12/12/2012		
Temperature: 23 °C	Air Pressure: 1014 hPa	Relative Humidity: 39 %	Power Supply: 5 VDC
Remarks:			

Photograph 8.1.3 Setup for radiated immunity to RF electromagnetic field test, general view, radiation from EUT pins



Photograph 8.1.4 Setup for radiated immunity to RF electromagnetic field test, general view, radiation from EUT pins



Test specification:	Radiated immunity to radio frequency electromagnetic field		
Test procedure:	EN 61000-4-3; EN 55024, Section 4.2.3.1		
Test mode:	Evaluation	Verdict:	PASS
Date(s):	12/11/2012 - 12/12/2012		
Temperature: 23 °C	Air Pressure: 1014 hPa	Relative Humidity: 39 %	Power Supply: 5 VDC
Remarks:			

Photograph 8.1.5 Setup for radiated immunity to RF electromagnetic field test, EUT close view, radiation from EUT pins

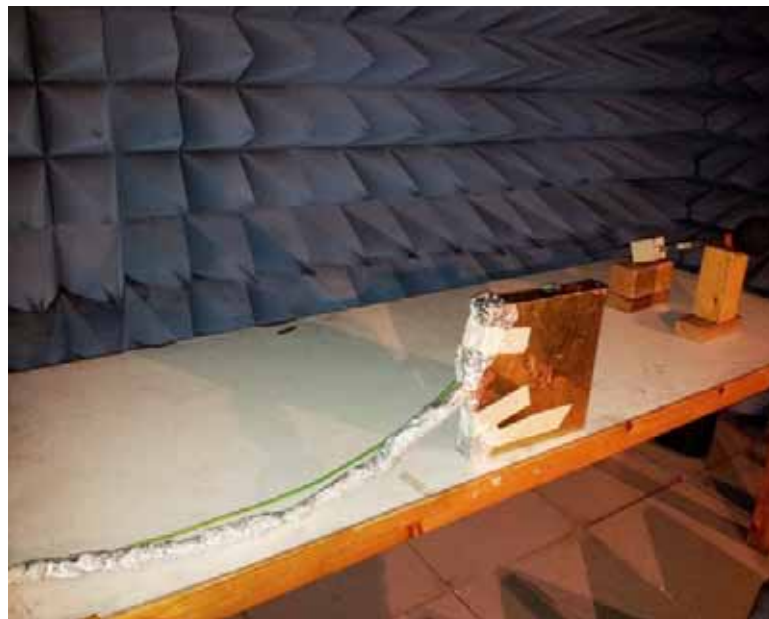

Test specification:		Radiated immunity to radio frequency electromagnetic field	
Test procedure:		EN 61000-4-3; EN 55024, Section 4.2.3.1	
Test mode:		Evaluation	
Date(s):		12/11/2012 - 12/12/2012	
Temperature: 23 °C		Air Pressure: 1014 hPa	
		Relative Humidity: 39 %	
		Power Supply: 5 VDC	
Remarks:			

Table 8.1.1 Radiated immunity to RF electromagnetic field test results

TLK106 32p QFN radiation through cable

EUT SET UP: TABLE-TOP
 PERFORMANCE CRITERIA: A
 TEST SITE: FULLY ANECHOIC CHAMBER
 ANTENNA TO EUT DISTANCE: 2.4 m
 FREQUENCY RANGE: 80 – 1000 MHz
 MODULATION: 80% AM with 1 kHz
 DWELL TIME: 2.8 s
 FREQUENCY STEP: 1 % of current frequency

EUT orientation*	Antenna polarization	Field strength**, V_{rms}/m	EUT performance description during the test	Verdict
0°	Vertical	10***	NP	Pass***
	Horizontal		At 89.49 MHz and 98.59 MHz the errors appeared	

* - 0° = antenna installed facing the EUT front panel.
 ** - Field strength measured prior to modulation.
 *** - The standard requirement is 3 V_{rms}/m .

TLK106 32p QFN radiation from EUT pins

EUT SET UP: TABLE-TOP
 PERFORMANCE CRITERIA: A
 TEST SITE: MILITARY SEMI ANECHOIC CHAMBER
 ANTENNA TO EUT DISTANCE: 2.0 m
 FREQUENCY RANGE: 80 – 1000 MHz
 MODULATION: 80% AM with 1 kHz
 DWELL TIME: 2.8 s
 FREQUENCY STEP: 1 % of current frequency

EUT orientation*	Antenna polarization	Field strength**, V_{rms}/m	EUT performance description during the test	Verdict
0°	Vertical	10***	At 81, 115, 132, 214; 415; 520 MHz the errors appeared; the threshold 8 V defined for 115 and 132 MHz	Tested
	Horizontal		At 81, 129, 226 MHz the errors appeared; the threshold 9.5 V defined for 226 MHz	

* - 0° = antenna installed facing the EUT front panel.
 ** - Field strength measured prior to modulation.
 *** - The standard requirement is 3 V_{rms}/m .
 ***The 8 V_{rms}/m threshold was defined for 115 and 132 MHz, the 9.5 V_{rms}/m threshold defined for 226 MHz only.

Reference numbers of test equipment used

HL 0317	HL 0613	HL 0659	HL 0674	HL 1097	HL 1544	HL 1629	HL 2078
HL 2109	HL 2376	HL 2432	HL 2697	HL 2783	HL 2788	HL 3158	HL 3508

Full description is given in Appendix A.

9 APPENDIX A Test equipment and ancillaries used for tests

HL No	Description	Manufacturer	Model	Ser. No.	Last Cal./ Check	Due Cal./ Check
0317	Power Sensor, 30 MHz - 18 GHz, -70 to 20 dBm	Boonton Electronics Corp.	51072	26163	01-Jan-13	01-Jan-14
0613	Sensor Electric Field 10 kHz-1.0 GHz, 1-300 V/m (probe)	Amplifier Research	FP2000	18677	07-Dec-12	07-Dec-13
0659	Amplifier 1 to 4 GHz, 55 W	Milmega	AS0104-55/55B	971386	03-Jul-12	03-Jul-13
0674	Coupler Directional, high power 80 - 1000 MHz, 1500 W	WERLATONE	C3908	5843	01-Jan-13	01-Jan-14
1097	Attenuator, 50 Ohm, 5 W, DC to 8 GHz, 20 dB	Midwest Microwave	0793-20-NN-07	1097	10-Oct-12	10-Oct-13
1544	Cable RF, N/N-type, 3.2 m	Alpha Wire	RG-213/U	1544	19-Jul-12	19-Jul-13
1629	Isotropic Field Monitor	Amplifier Research	FM2000	23308	07-Dec-12	07-Dec-13
2078	Isotropic Field Probe 80 MHz - 40 GHz	Amplifier Research	FP2080	302541	10-Feb-13	10-Feb-14
2109	Anechoic Chamber 6(L) x 5.5(W) x 2.95(H) m	Hermon Laboratories	AC-2	2109	07-Nov-12	07-Nov-13
2376	Coupler coaxial bi-directional 1 - 4 GHz, 20 dB	Narda	3022	50076	21-Jun-12	21-Jun-13
2432	Antenna, Double-Ridged Waveguide Horn 1-18 GHz	EMC Test Systems	3115	00027177	07-Dec-12	07-Dec-13
2697	Antenna, 30 MHz - 3.0 GHz	Sunol Sciences Corp. Pleasanton, California USA	JB3	A022805	20-May-12	20-May-14
2783	Power Meter, RF, IEEE-488, 100 kHz - 100 GHz, -70 to +37 dBm	Boonton Electronics Corp.	4220	156602BK	02-Jan-13	02-Jan-14
2788	Horn Antenna, 0.5 to 4 GHz	GTE Sylvania	AN-10E	78004	30-Jul-10	30-Jul-13
3158	Amplifier, 80 to 1000 MHz, 500 W	Amplifier Research	500W100 0A	032960	03-Apr-13	03-Apr-14
3508	MIL STD Anechoic Chamber 6.0(L) x 4.8(W) x 2.9(H) m	ETS Lindgren	RFD-F/A-100	4311	30-Oct-12	30-Oct-13
4150	Preamplifier, 0.1 to 18 GHz, Gain 25 dB, N-type(f) in, N-type(m) out.	Agilent Technologies	87405C	MY470105 91	18-Jun-12	18-Jun-13
4347	Low Loss Armored Test Cable, DC - 18 GHz, 2.0 m, N type-M/N type-M	MegaPhase	NC29-N1N1-79	12025103 001	06-Mar-13	06-Mar-14
4349	Low Loss Armored Test Cable, DC - 18 GHz, 4.5 m, N type-M/N type-M	MegaPhase	NC29-N1N1-177	12025102 001	01-Jan-13	01-Jan-14

10 APPENDIX B Measurement uncertainties

Expanded uncertainty at 95% confidence in Hermon Labs EMC measurements

Test description	Expanded uncertainty
Radiated emissions at 3 m measuring distance Horizontal polarization	Biconilog antenna: ± 5.3 dB Biconical antenna: ± 5.0 dB Log periodic antenna: ± 5.3 dB
Vertical polarization	Double ridged horn antenna: ± 5.3 dB Biconilog antenna: ± 6.0 dB Biconical antenna: ± 5.7 dB Log periodic antenna: ± 6.0 dB Double ridged horn antenna: ± 6.0 dB
Radiated immunity AR FP2000 E-field probe AR FP2080 E-field probe	10 kHz to 250 MHz: ± 1.9 dB; 250 MHz to 1 GHz: ± 2.1 dB 80 MHz to 26 GHz: ± 2.7 dB; 26 GHz to 40 GHz: ± 4.0 dB

Hermon Laboratories is accredited by A2LA for calibration according to present requirements of ISO/IEC 17025 and NCSL Z540-1. The accreditation is granted to perform calibration of parameters that are listed in the Scope of Hermon Laboratories Accreditation.

Hermon Laboratories calibrates its reference and transfer standards by calibration laboratories accredited to ISO/IEC 17025 by a mutually recognized Accreditation Body or by a recognized national metrology institute. All reference and transfer standards used in the calibration system are traceable to national or international standards.

In-house calibration of all test and measurement equipment is performed on a regular basis according to Hermon Laboratories calibration procedures, manufacturer calibration/verification procedures or procedures defined in the relevant standards. The Hermon Laboratories test and measurement equipment is calibrated within the tolerances specified by the manufacturers and/or by the relevant standards.

11 APPENDIX C Test laboratory description

Tests were performed at Hermon Laboratories Ltd., which is a fully independent, private, EMC, safety, environmental and telecommunication testing facility.

Hermon Laboratories is listed by the Federal Communications Commission (USA) for all parts of Code of Federal Regulations 47 (CFR 47), Registration Numbers 90624 for OATS and 90623 for the anechoic chamber; by Industry Canada for electromagnetic emissions (file numbers IC 2186A-1 for OATS and IC 2186A-2 for anechoic chamber), certified by VCCI, Japan (the registration numbers are R-808 for OATS, R-1082 for semi anechoic chamber, G-27 for full-anechoic chamber, C-845 for conducted emissions (mains ports) site, T-1606 for conducted emissions (telecommunication ports) site), has a status of a Telefication - Listed Testing Laboratory, Certificate No. L138/00. The laboratory is accredited by American Association for Laboratory Accreditation (USA) according to ISO/IEC 17025 for electromagnetic compatibility, product safety, telecommunications testing and environmental simulation (for exact scope please refer to Certificate No. 839.01).

Address: P.O. Box 23, Binyamina 30500, Israel.
Telephone: +972 4628 8001
Fax: +972 4628 8277
e-mail: mail@hermonlabs.com
website: www.hermonlabs.com

Person for contact: Mr. Alex Usoskin, CEO.

12 APPENDIX D Specification references

EN 300 386 V1.4.1: 2008	Electromagnetic compatibility and Radio spectrum Matters (ERM). Telecommunication network equipment. ElectroMagnetic Compatibility (EMC) requirements
EN 55022: 2010	Limits and methods of measurement of interference characteristics of information technology equipment
CISPR 16-1-1: 2006	Specification for radio disturbance and immunity measuring apparatus and methods. Part 1-1: Radio disturbance and immunity measuring apparatus – Measuring apparatus
EN 61000-4-3: 2006+A1(08)+A2(10)	Electromagnetic compatibility (EMC). Part 4: testing and measurement techniques. Section 3: Radiated, radio frequency, electromagnetic field immunity test

13 APPENDIX E Test equipment correction factors

Antenna factor
Double-ridged guide horn antenna
Model 3115, serial number: 00027177, HL 2432

Frequency, MHz	Antenna factor. dB(1/m)
1000.0	24.7
1500.0	25.7
2000.0	27.8
2500.0	28.9
3000.0	30.7
3500.0	31.8
4000.0	33.0
4500.0	32.8
5000.0	34.2
5500.0	34.9
6000.0	35.2
6500.0	35.4
7000.0	36.3
7500.0	37.3
8000.0	37.5
8500.0	38.0
9000.0	38.3
9500.0	38.3
10000.0	38.7
10500.0	38.7
11000.0	38.9
11500.0	39.5
12000.0	39.5
12500.0	39.4
13000.0	40.5
13500.0	40.8
14000.0	41.5
14500.0	41.3
15000.0	40.2
15500.0	38.7
16000.0	38.5
16500.0	39.8
17000.0	41.9
17500.0	45.8
18000.0	49.1

Antenna factor in dB(1/m) is to be added to receiver meter reading in dB(μ V) to convert it into field strength in dB(μ V/m).

14 APPENDIX F Abbreviations and acronyms

A	ampere
AC	alternating current
AM	amplitude modulation
AVRG	average (detector)
cm	centimeter
dB	decibel
dBm	decibel referred to one milliwatt
dB(μ V)	decibel referred to one microvolt
dB(μ V/m)	decibel referred to one microvolt per meter
dB(μ A)	decibel referred to one microampere
DC	direct current
EUT	equipment under test
F	frequency
GHz	gigahertz
GND	ground
H	height
HL	Hermon laboratories
Hz	hertz
k	kilo
kHz	kilohertz
m	meter
MHz	megahertz
min	minute
mm	millimeter
ms	millisecond
μ s	microsecond
NA	not applicable
OATS	open area test site
Ω	Ohm
QP	quasi-peak
RE	radiated emission
RF	radio frequency
rms	root mean square
Rx	receive
s	second
T	temperature
Tx	transmit
V	volt
WB	wideband

END OF DOCUMENT