

| FABRICATION CHART                         |   |   |   |   |
|---|---|---|---|---|
| FINISHED THICKNESS                        | SILKSCREEN                                      | SOLDERMASK                                  | FINISHED COPPER WEIGHT                      |   |
|   |   |   | EXTERNAL                                    | INTERNAL                                  |
| <input type="checkbox"/> 0.031            | <input checked="" type="checkbox"/> LAYER 1     | <input checked="" type="checkbox"/> LAYER 1 | <input type="checkbox"/> 1 OZ.              | <input type="checkbox"/> 1 OZ.            |
| <input checked="" type="checkbox"/> 0.062 | <input checked="" type="checkbox"/> LAYER 2     | <input checked="" type="checkbox"/> LAYER 2 | <input checked="" type="checkbox"/> 2 OZ.   | <input checked="" type="checkbox"/> 2 OZ. |
| <input type="checkbox"/> 0.093            | <input type="checkbox"/> NONE                   | <input type="checkbox"/> NONE               | <input type="checkbox"/> OTHER _____        | <input type="checkbox"/> OTHER _____      |
| <input type="checkbox"/> 0.125            |   |   |   |   |
| DESIGN                                    | TRACE/GAP SPACING                               |   | LAYER COUNT                                 |   |
| <input type="checkbox"/> SMD              | <input checked="" type="checkbox"/> 0.010/0.010 | <input type="checkbox"/> SINGLE SIDED       | <input checked="" type="checkbox"/> 2 LAYER |   |
| <input type="checkbox"/> THRU-HOLE        | <input type="checkbox"/> 0.008/0.007            | <input type="checkbox"/> 4 LAYER            | <input type="checkbox"/> 6 LAYER            |   |
| <input checked="" type="checkbox"/> MIX   | <input type="checkbox"/> 0.006/0.006            | <input type="checkbox"/> 8 LAYER            | <input type="checkbox"/> 10 LAYER           |   |
|   |   | <input type="checkbox"/> OTHER _____        |   |   |

NOTES: UNLESS OTHERWISE SPECIFIED  
 ALL DIMENSIONS ARE IN INCHES +/- 0.005 UNLESS OTHERWISE SPECIFIED

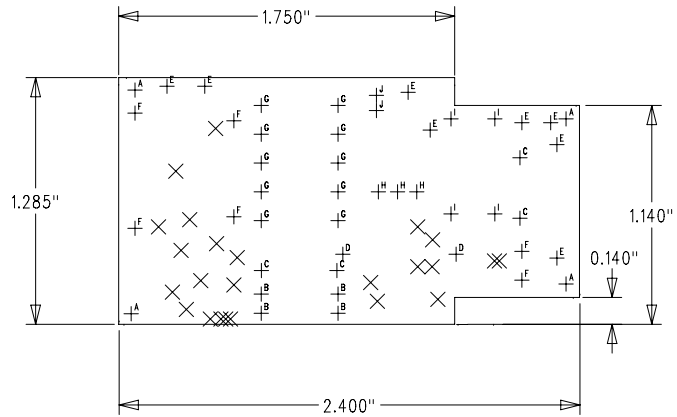

FB

- MATERIAL:** ALL MATERIALS, INCLUDING BUT NOT LIMITED TO BASE LAMINATE, BONDING MATERIALS AND SOLDERMASK COATINGS FORMING THE FINISHED PRINTED CIRCUIT BOARD SHALL MEET UL-796 REQUIREMENTS AND HAVE A FLAMMABILITY OF UL94V-0.
- BASE LAMINATE:** PLASTIC SHEET, LAMINATED METAL CLAD, TWO SIDES, BASE MATERIAL NEMA TYPE FR-406 170<sup>g</sup> Tg OR GREATER, GLASS EPOXY RESIN, COPPER-CLAD IN ACCORDANCE WITH 2 LAYER STACK-UP.
- SOLDERMASK:** SOLDERMASK OVER BARE COPPER (SMOBC) USING GREEN LIQUID PHOTO-IMAGEABLE SOLDERMASK IN ACCORDANCE WITH IPC-SM-840, MATTE FINISH PREFERRED.
- PLATING:** HOLES REQUIRING PLATING, SEE HOLE CHART, TO HAVE 1 OZ. (0.001) MIN. THICK COPPER.
- FINISH:** 100% ELECTRO-TIN or 60/40 TIN LEAD (HASL)
- LEGEND:** IF REQUIRED, SILKSCREEN LEGEND(S) WITH WHITE NON-CONDUCTIVE PHOTO-IMAGEABLE EPOXY INK. SILKSCREEN LEGEND TO BE "CLIPPED" FROM ALL COMPONENT PADS.
- MARKINGS:** BOARD MUST BEAR VENDOR'S IDENTIFICATION CODE (WHITE NON-CONDUCTIVE INK) ON THE BOTTOM SIDE ONLY, LOCATION OPTIONAL.
- WORKMANSHIP:** BOARD IS TO BE MANUFACTURED PER IPC-A-600 CLASS 2 REQUIREMENTS OR BETTER.
- DOCUMENTATION:** PCB VENDOR IS REQUIRED TO RETURN ANY AND ALL DOCUMENTS SUPPLIED OR ULTIMATELY PURCHASED BY TEXAS INSTRUMENTS UPON COMPLETION OF PURCHASE ORDER.
- DRILL SIZES:** HOLE DIAMETERS SHOWN ARE FINISHED SIZES AFTER PLATING UNLESS OTHERWISE NOTED.
- PANEL BORDER:** ANY METAL IN BORDER AREA INCLUDING PART NUMBER, DATECODE AND/OR REVISION LETTERS MUST BE COVERED WITH SOLDERMASK.
- PROCESS CHANGES:** NO DIMENSIONAL, MATERIAL, OR PROCESS CHANGES ARE ALLOWED WITHOUT PRIOR EXPLICIT WRITTEN PERMISSION FROM TEXAS INSTRUMENTS.

FINISHED HOLE SIZES  
 Dimensions are in Inches

| SIZE   | QTY | SYM | PLATED | TOL           |
|--------|-----|-----|--------|---------------|
| 0.0145 | 24  | X   | YES    | +0.003/-0.010 |
| 0.032  | 4   | A   | YES    | +/-0.003      |
| 0.04   | 4   | B   | YES    | +/-0.003      |
| 0.042  | 4   | C   | YES    | +/-0.003      |
| 0.025  | 2   | D   | YES    | +/-0.003      |
| 0.041  | 8   | E   | YES    | +/-0.003      |
| 0.052  | 6   | F   | YES    | +/-0.003      |
| 0.055  | 10  | G   | YES    | +/-0.003      |
| 0.051  | 3   | H   | YES    | +/-0.003      |
| 0.049  | 4   | I   | YES    | +/-0.003      |
| 0.035  | 2   | J   | YES    | +/-0.003      |



|              |   |      |                      |            |
|--------------|---|------|----------------------|------------|
|              | DESCRIPTION                                   |      | DWG NO               |            |
|              | 230VAC to 32V/350mA TRIAC Dimmable LED Driver |      | PMP6003              |            |
|              | DRAWN   | DATE | REV                  | ECO NUMBER |
|              |   |      | B                    |            |
| CHECKED      | DATE  | SIZE | SCALE                |            |
|              |   | A    | NTS                  |            |
| FILENAME     | ISSUED  | DATE | DO NOT SCALE DRAWING |            |
| PMP6003B.pcb |   |      | PAGE 1 OF 7          |            |

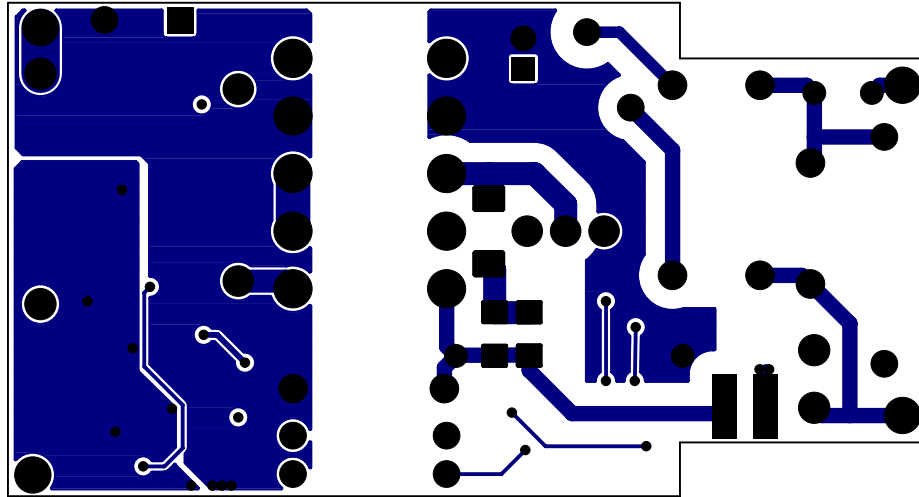

TOP COPPER

|   |         |          |                      |       |
|---|---------|----------|----------------------|-------|
| DESCRIPTION                                   |         |          | SIZE                 | SCALE |
| 230VAC to 32V/350mA TRIAC Dimmable LED Driver |         |          | A                    | NTS   |
| DWG NO  | PMP6003 | REV      | DO NOT SCALE DRAWING |       |
| REFERENCE NO                                  |         | B        | PAGE 2               | OF 7  |
|   |         | FILENAME | PMP6003B.pcb         |       |

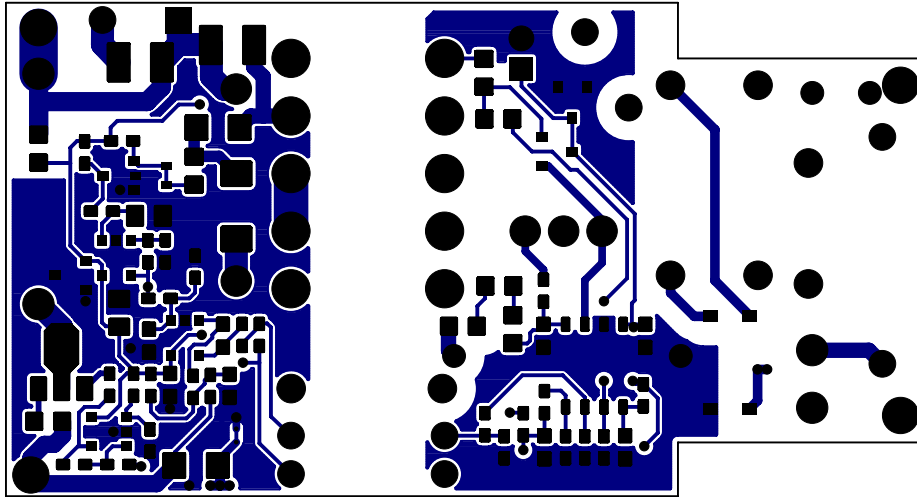

BOTTOM COPPER

|   |         |     |                          |        |
|---|---------|-----|--------------------------|--------|
| DESCRIPTION                                   |         |     | SIZE                     | SCALE  |
| 230VAC to 32V/350mA TRIAC Dimmable LED Driver |         |     | A                        | NTS    |
| DWG NO  | PMP6003 | REV | DO NOT SCALE DRAWING     |        |
| REFERENCE NO                                  |         | B   | PAGE                     | 3 OF 7 |
|   |         |     | FILENAME<br>PMP6003B.pcb |        |

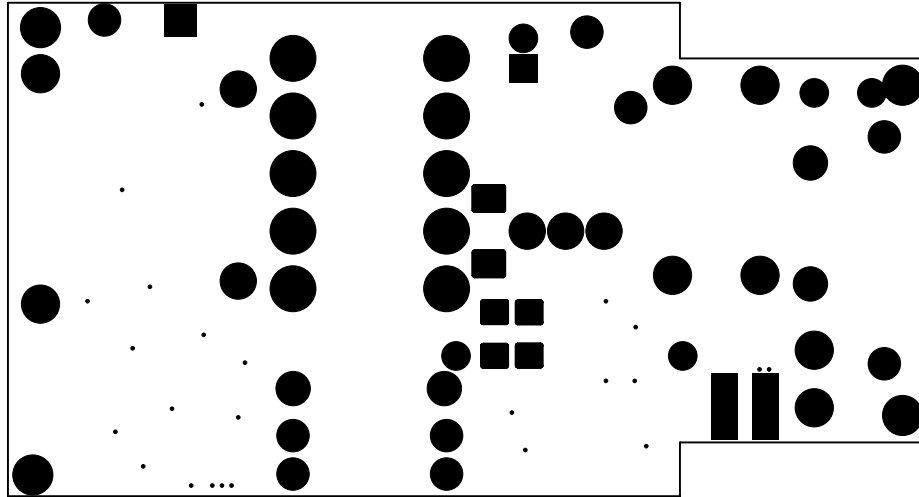

SOLDER MASK TOP

|   |         |                      |              |
|---|---------|----------------------|--------------|
| DESCRIPTION                                   |         | SIZE                 | SCALE        |
| 230VAC to 32V/350mA TRIAC Dimmable LED Driver |         | A                    | NTS          |
| DWG NO  | PMP6003 | REV                  | FILENAME     |
| REFERENCE NO                                  |         | B                    | PMP6003B.pcb |
|   |         | DO NOT SCALE DRAWING |              |
|   |         | PAGE 4 OF 7          |              |

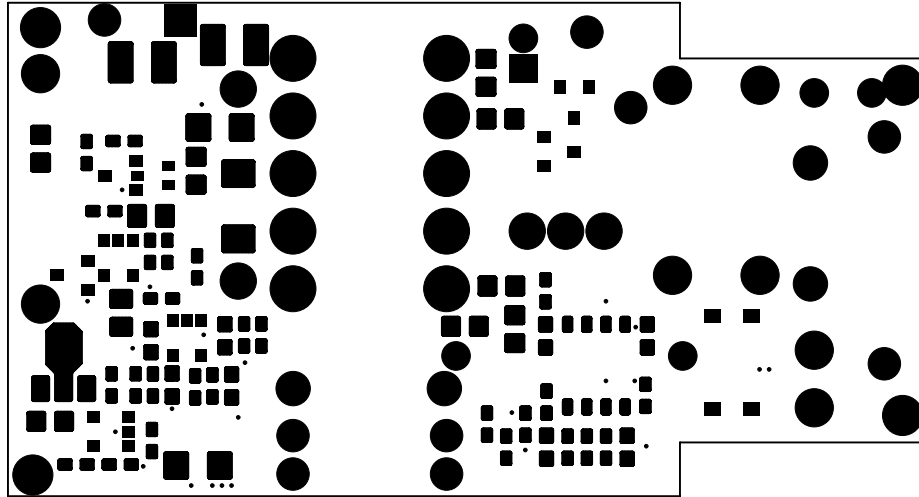

SOLDER MASK BOTTOM

|   |         |             |              |
|---|---------|-------------|--------------|
| DESCRIPTION                                   |         | SIZE        | SCALE        |
| 230VAC to 32V/350mA TRIAC Dimmable LED Driver |         | A           | NTS          |
| DWG NO  | PMP6003 | REV         | FILENAME     |
| REFERENCE NO                                  |         | B           | PMP6003B.pcb |
| DO NOT SCALE DRAWING                          |         | PAGE 5 OF 7 |              |

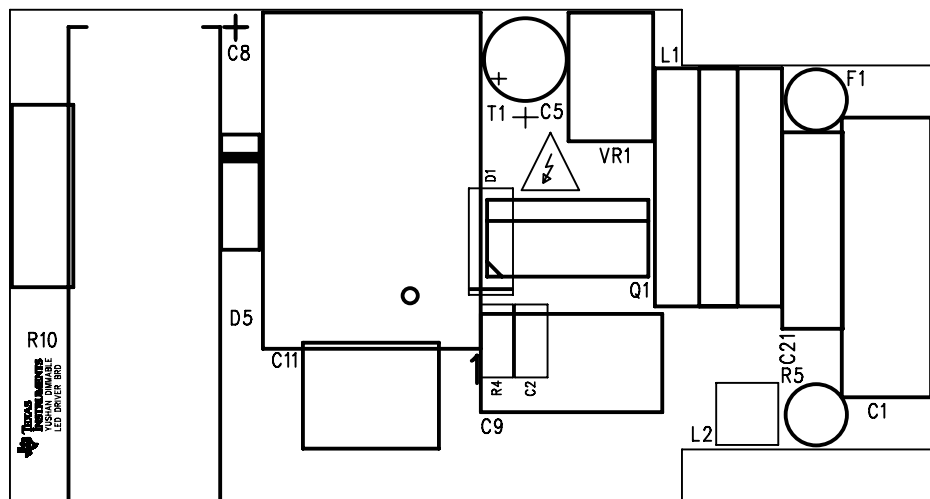

SILKSCREEN TOP



|   |         |     |                      |              |
|---|---------|-----|----------------------|--------------|
| DESCRIPTION                                   |         |     | SIZE                 | SCALE        |
| 230VAC to 32V/350mA TRIAC Dimmable LED Driver |         |     | A                    | NTS          |
| DWG NO  | PMP6003 | REV | DO NOT SCALE DRAWING |              |
| REFERENCE NO                                  |         | B   | PAGE                 | 6 OF 7       |
|   |         |     | FILENAME             | PMP6003B.pcb |

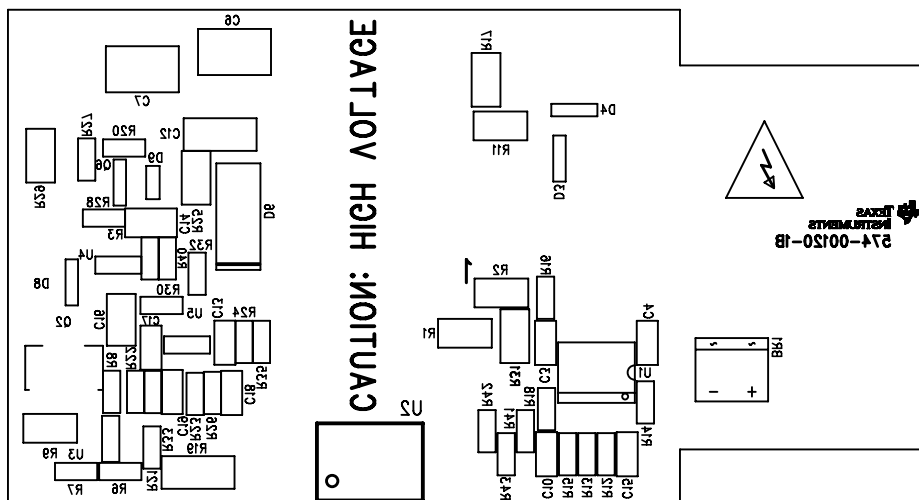

SILK SCREEN BOTTOM



|   |         |             |              |
|---|---------|-------------|--------------|
| DESCRIPTION                                   |         | SIZE        | SCALE        |
| 230VAC to 32V/350mA TRIAC Dimmable LED Driver |         | A           | NTS          |
| DWG NO  | PMP6003 | REV         | FILENAME     |
| REFERENCE NO                                  |         | B           | PMP6003B.pcb |
| DO NOT SCALE DRAWING                          |         | PAGE 7 OF 7 |              |

## IMPORTANT NOTICE

Texas Instruments Incorporated and its subsidiaries (TI) reserve the right to make corrections, modifications, enhancements, improvements, and other changes to its products and services at any time and to discontinue any product or service without notice. Customers should obtain the latest relevant information before placing orders and should verify that such information is current and complete. All products are sold subject to TI's terms and conditions of sale supplied at the time of order acknowledgment.

TI warrants performance of its hardware products to the specifications applicable at the time of sale in accordance with TI's standard warranty. Testing and other quality control techniques are used to the extent TI deems necessary to support this warranty. Except where mandated by government requirements, testing of all parameters of each product is not necessarily performed.

TI assumes no liability for applications assistance or customer product design. Customers are responsible for their products and applications using TI components. To minimize the risks associated with customer products and applications, customers should provide adequate design and operating safeguards.

TI does not warrant or represent that any license, either express or implied, is granted under any TI patent right, copyright, mask work right, or other TI intellectual property right relating to any combination, machine, or process in which TI products or services are used. Information published by TI regarding third-party products or services does not constitute a license from TI to use such products or services or a warranty or endorsement thereof. Use of such information may require a license from a third party under the patents or other intellectual property of the third party, or a license from TI under the patents or other intellectual property of TI.

Reproduction of TI information in TI data books or data sheets is permissible only if reproduction is without alteration and is accompanied by all associated warranties, conditions, limitations, and notices. Reproduction of this information with alteration is an unfair and deceptive business practice. TI is not responsible or liable for such altered documentation. Information of third parties may be subject to additional restrictions.

Resale of TI products or services with statements different from or beyond the parameters stated by TI for that product or service voids all express and any implied warranties for the associated TI product or service and is an unfair and deceptive business practice. TI is not responsible or liable for any such statements.

TI products are not authorized for use in safety-critical applications (such as life support) where a failure of the TI product would reasonably be expected to cause severe personal injury or death, unless officers of the parties have executed an agreement specifically governing such use. Buyers represent that they have all necessary expertise in the safety and regulatory ramifications of their applications, and acknowledge and agree that they are solely responsible for all legal, regulatory and safety-related requirements concerning their products and any use of TI products in such safety-critical applications, notwithstanding any applications-related information or support that may be provided by TI. Further, Buyers must fully indemnify TI and its representatives against any damages arising out of the use of TI products in such safety-critical applications.

TI products are neither designed nor intended for use in military/aerospace applications or environments unless the TI products are specifically designated by TI as military-grade or "enhanced plastic." Only products designated by TI as military-grade meet military specifications. Buyers acknowledge and agree that any such use of TI products which TI has not designated as military-grade is solely at the Buyer's risk, and that they are solely responsible for compliance with all legal and regulatory requirements in connection with such use.

TI products are neither designed nor intended for use in automotive applications or environments unless the specific TI products are designated by TI as compliant with ISO/TS 16949 requirements. Buyers acknowledge and agree that, if they use any non-designated products in automotive applications, TI will not be responsible for any failure to meet such requirements.

Following are URLs where you can obtain information on other Texas Instruments products and application solutions:

### Products

|                             |  |
|-----------------------------|--|
| Audio                       | <a href="http://www.ti.com/audio">www.ti.com/audio</a>             |
| Amplifiers                  | <a href="http://amplifier.ti.com">amplifier.ti.com</a>             |
| Data Converters             | <a href="http://dataconverter.ti.com">dataconverter.ti.com</a>     |
| DLP® Products               | <a href="http://www.dlp.com">www.dlp.com</a>                       |
| DSP                         | <a href="http://dsp.ti.com">dsp.ti.com</a>                         |
| Clocks and Timers           | <a href="http://www.ti.com/clocks">www.ti.com/clocks</a>           |
| Interface                   | <a href="http://interface.ti.com">interface.ti.com</a>             |
| Logic                       | <a href="http://logic.ti.com">logic.ti.com</a>                     |
| Power Mgmt                  | <a href="http://power.ti.com">power.ti.com</a>                     |
| Microcontrollers            | <a href="http://microcontroller.ti.com">microcontroller.ti.com</a> |
| RFID                        | <a href="http://www.ti-rfid.com">www.ti-rfid.com</a>               |
| RF/IF and ZigBee® Solutions | <a href="http://www.ti.com/lprf">www.ti.com/lprf</a>               |

### Applications

|                               |  |
|-------------------------------|--|
| Communications and Telecom    | <a href="http://www.ti.com/communications">www.ti.com/communications</a>                 |
| Computers and Peripherals     | <a href="http://www.ti.com/computers">www.ti.com/computers</a>                           |
| Consumer Electronics          | <a href="http://www.ti.com/consumer-apps">www.ti.com/consumer-apps</a>                   |
| Energy and Lighting           | <a href="http://www.ti.com/energy">www.ti.com/energy</a>                                 |
| Industrial                    | <a href="http://www.ti.com/industrial">www.ti.com/industrial</a>                         |
| Medical                       | <a href="http://www.ti.com/medical">www.ti.com/medical</a>                               |
| Security                      | <a href="http://www.ti.com/security">www.ti.com/security</a>                             |
| Space, Avionics and Defense   | <a href="http://www.ti.com/space-avionics-defense">www.ti.com/space-avionics-defense</a> |
| Transportation and Automotive | <a href="http://www.ti.com/automotive">www.ti.com/automotive</a>                         |
| Video and Imaging             | <a href="http://www.ti.com/video">www.ti.com/video</a>                                   |
| Wireless                      | <a href="http://www.ti.com/wireless-apps">www.ti.com/wireless-apps</a>                   |

TI E2E Community Home Page

[e2e.ti.com](http://e2e.ti.com)

Mailing Address: Texas Instruments, Post Office Box 655303, Dallas, Texas 75265  
Copyright © 2011, Texas Instruments Incorporated