



Quad, Serial Input 14-Bit Multiplying Digital-to-Analog Converter

FEATURES

- **Relative Accuracy: 1 LSB Max**
- **Differential Nonlinearity: 1 LSB Max**
- **2-mA Full-Scale Current with $V_{REF} = \pm 10\text{ V}$**
- **0.5- μs Settling Time**
- **Midscale or Zero-Scale Reset**
- **Four Separate 4Q Multiplying Reference Inputs**
- **Reference Bandwidth: 10 MHz**
- **Reference Dynamics: -105 dB THD**
- **SPI™-Compatible 3-Wire Interface: 50-MHz**
- **Double Buffered Registers Enable**
- **Simultaneous Multichannel Update**
- **Internal Power-On Reset**
- **Compact SSOP-28 Package**
- **Industry-Standard Pin Configuration**

APPLICATIONS

- **Automatic Test Equipment**
- **Instrumentation**
- **Digitally-Controlled Calibration**

DESCRIPTION

The DAC8803 is a quad, 14-bit, current-output digital-to-analog converter (DAC) designed to operate from a single +2.7-V to 5-V supply.

The applied external reference input voltage V_{REF} determines the full-scale output current. An internal feedback resistor (R_{FB}) provides temperature tracking for the full-scale output when combined with an external I-to-V precision amplifier.

A doubled buffered serial data interface offers high-speed, 3-wire, SPI and microcontroller compatible inputs using serial data in (SDI), clock (CLK), and a chip select (\overline{CS}). In addition, a serial data out pin (SDO) allows for daisy chaining when multiple packages are used. A common level-sensitive load DAC strobe (\overline{LDAC}) input allows simultaneous update of all DAC outputs from previously loaded input registers. Additionally, an internal power-on reset forces the output voltage to zero at system turn on. An MSB pin allows system reset assertion (\overline{RS}) to force all registers to zero code when MSB = 0, or to half-scale code when MSB = 1.

The DAC8803 is packaged in an SSOP package.

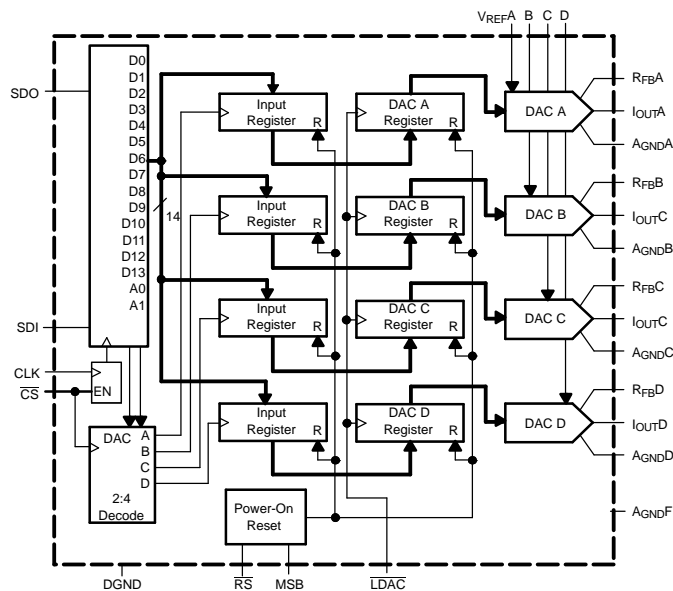

Please be aware that an important notice concerning availability, standard warranty, and use in critical applications of Texas Instruments semiconductor products and disclaimers thereto appears at the end of this data sheet.

SPI is a trademark of Motorola, Inc.
All trademarks are the property of their respective owners.



This integrated circuit can be damaged by ESD. Texas Instruments recommends that all integrated circuits be handled with appropriate precautions. Failure to observe proper handling and installation procedures can cause damage.

ESD damage can range from subtle performance degradation to complete device failure. Precision integrated circuits may be more susceptible to damage because very small parametric changes could cause the device not to meet its published specifications.

PACKAGE/ORDERING INFORMATION⁽¹⁾

| PRODUCT | MINIMUM RELATIVE ACCURACY (LSB) | DIFFERENTIAL NONLINEARITY (LSB) | SPECIFIED TEMPERATURE RANGE | PACKAGE-LEAD | PACKAGE DESIGNATOR | ORDERING NUMBER | TRANSPORT MEDIA QUANTITY |
|---------|---------------------------------|---------------------------------|-----------------------------|--------------|--------------------|-----------------|--------------------------|
| DAC8803 | ±1 | ±1 | -40°C to +85°C | SSOP-28 | DB | DAC8803IDBT | Tape and Reel, 250 |
| | | | | | | DAC8803IDBR | Tape and Reel, 2500 |

(1) For the most current specifications and package information, see the Package Option Addendum at the end of this document, or see the TI website at www.ti.com

ABSOLUTE MAXIMUM RATINGS⁽¹⁾

| | DAC8803 | UNIT |
|---|---|------|
| V _{DD} to GND | -0.3 to +8 | V |
| V _{REF} to GND | -18 to +18 | V |
| Logic inputs and output to GND | -0.3 to +8 | V |
| V(I _{OUT}) to GND | -0.3 to V _{DD} + 0.3 | V |
| A _{GNDX} to DGND | -0.3 to +0.3 | V |
| Input current to any pin except supplies | ±50 | mA |
| Package power dissipation | (T _{Jmax} - T _A)/θ _{JA} | W |
| Thermal resistance, θ _{JA} | 28-Lead shrink surface-mount (RS-28) | 100 |
| | | °C/W |
| Maximum junction temperature (T _{Jmax}) | 150 | °C |
| Operating temperature range, Model A | -40 to +85 | °C |
| Storage temperature range | -65 to +150 | °C |

(1) Stresses above those listed under absolute maximum ratings may cause permanent damage to the device. This is a stress rating only; functional operation of the device at these or any other conditions above those indicated in the operational sections of this specification is not implied. Exposure to absolute maximum conditions for extended periods may affect device reliability.

ELECTRICAL CHARACTERISTICS

$V_{DD} = +2.7\text{ V}$ to $+5.5\text{ V}$; $I_{OUTX} = \text{Virtual GND}$, $A_{GNDX} = 0\text{ V}$, $V_{REFA, B, C, D} = 10\text{ V}$, $T_A = \text{full operating temperature range}$, unless otherwise noted.

| PARAMETER | SYMBOL | CONDITIONS | DAC8803 | | | UNIT |
|--|------------|--|---------|-------|-----|--------|
| | | | MIN | TYP | MAX | |
| STATIC PERFORMANCE⁽¹⁾ | | | | | | |
| Resolution | | | | | 14 | Bits |
| Relative accuracy | | | | | ±1 | LSB |
| Differential nonlinearity | DNL | | | | ±1 | LSB |
| Output leakage current | I_{OUTX} | Data = 0000h, $T_A = 25^\circ\text{C}$ | | | 10 | nA |
| | I_{OUTX} | Data = 0000h, $T_A = T_A \text{ max}$ | | | 20 | nA |
| Full-scale gain error | G_{FSE} | Data = 3FFFh | | ±0.75 | ±3 | mV |
| Full-scale tempco ⁽²⁾ | TCV_{FS} | | | 1 | | ppm/°C |
| Feedback resistor | R_{FBX} | $V_{DD} = 5\text{ V}$ | | | | kΩ |
| REFERENCE INPUT | | | | | | |
| V_{REFX} Range | V_{REFX} | | -15 | | 15 | V |
| Input resistance | R_{REFX} | | 4 | 5 | 6 | kΩ |
| Input resistance match | R_{REFX} | Channel-to-channel | | 1 | | % |
| Input capacitance ⁽²⁾ | C_{REFX} | | | 5 | | pF |
| ANALOG OUTPUT | | | | | | |
| Output current | I_{OUTX} | Data = 3FFFh | 1.6 | | 2.5 | mA |
| Output capacitance ⁽²⁾ | C_{OUTX} | Code-dependent | | 50 | | pF |
| LOGIC INPUTS AND OUTPUT | | | | | | |
| Input low voltage | V_{IL} | $V_{DD} = +2.7\text{ V}$ | | | 0.6 | V |
| | V_{IL} | $V_{DD} = +5\text{ V}$ | | | 0.8 | V |
| Input high voltage | V_{IH} | $V_{DD} = +2.7\text{ V}$ | 2.1 | | | V |
| | V_{IH} | $V_{DD} = +5\text{ V}$ | 2.4 | | | V |
| Input leakage current | I_{IL} | | | | 1 | μA |
| Input capacitance ⁽²⁾ | C_{IL} | | | | 10 | pF |
| Logic output low voltage | V_{OL} | $I_{OL} = 1.6\text{ mA}$ | | | 0.4 | V |
| Logic output high voltage | V_{OH} | $I_{OH} = 100\text{ μA}$ | 4 | | | V |
| INTERFACE TIMING^{(2), (3)} | | | | | | |
| Clock width high | t_{CH} | | 25 | | | ns |
| Clock width low | t_{CL} | | 25 | | | ns |
| \overline{CS} to Clock setup | t_{CSS} | | 0 | | | ns |
| Clock to \overline{CS} hold | t_{CSH} | | 25 | | | ns |
| Clock to SDO prop delay | t_{PD} | | 2 | | 20 | ns |
| Load DAC pulsewidth | t_{LDAC} | | 25 | | | ns |
| Data setup | t_{DS} | | 20 | | | ns |
| Data hold | t_{DH} | | 20 | | | ns |
| Load setup | t_{LDS} | | 5 | | | ns |
| Load hold | t_{LDH} | | 25 | | | ns |

(1) All static performance tests (except I_{OUT}) are performed in a closed-loop system using an external precision OPA277 I-to-V converter amplifier. The DAC8803 R_{FB} terminal is tied to the amplifier output. Typical values represent average readings measured at 25°C .

(2) These parameters are specified by design and not subject to production testing.

(3) All input control signals are specified with $t_R = t_F = 2.5\text{ ns}$ (10% to 90% of 3 V) and timed from a voltage level of 1.5 V.

ELECTRICAL CHARACTERISTICS (continued)

$V_{DD} = +2.7\text{ V to }+5.5\text{ V}$; $I_{OUTX} = \text{Virtual GND}$, $A_{GNDX} = 0\text{ V}$, $V_{REFA, B, C, D} = 10\text{ V}$, $T_A = \text{full operating temperature range}$, unless otherwise noted.

| PARAMETER | SYMBOL | CONDITIONS | DAC8803 | | | UNIT |
|---|-----------------------|--|---------|------|-------|------------------------------|
| | | | MIN | TYP | MAX | |
| SUPPLY CHARACTERISTICS | | | | | | |
| Power supply range | $V_{DD\text{ RANGE}}$ | | 2.7 | | 5.5 | V |
| Positive supply current | I_{DD} | Logic inputs = 0 V, $V_{DD} = +4.5\text{ V to }+5.5\text{ V}$ | | 2 | 5 | μA |
| | I_{DD} | Logic inputs = 0 V, $V_{DD} = +2.7\text{ V to }+3.6\text{ V}$ | | 1 | 2.5 | μA |
| Power dissipation | P_{DISS} | Logic inputs = 0 V | | | 0.025 | mW |
| Power supply sensitivity | P_{SS} | $\Delta V_{DD} = \pm 5\%$ | | | 0.006 | % |
| AC CHARACTERISTICS⁽⁴⁾ | | | | | | |
| Output voltage settling time | t_s | To $\pm 0.1\%$ of full-scale, Data = 0000h to 3FFFh to 0000h | | 0.3 | | μs |
| | t_s | To $\pm 0.006\%$ of full-scale, Data = 0000h to 3FFFh to 0000h | | 0.5 | | μs |
| Reference multiplying BW | BW -3 dB | $V_{REFX} = 100\text{ mV}_{RMS}$, Data = 3FFFh, $C_{FB} = 3\text{ pF}$ | | 10 | | MHz |
| DAC glitch impulse | Q | $V_{REFX} = 10\text{ V}$, Data = 1FFFh to 2000h to 1FFFh | | 1 | | nV/s |
| Feedthrough error | V_{OUTX}/V_{REFX} | Data = 0000h, $V_{REFX} = 100\text{ mV}_{RMS}$, $f = 100\text{ kHz}$ | | -70 | | dB |
| Crosstalk error | V_{OUTA}/V_{REFB} | Data = 0000h, $V_{REFB} = 100\text{ mV}_{RMS}$, Adjacent channel, $f = 100\text{ kHz}$ | | -100 | | dB |
| Digital feedthrough | Q | $\overline{CS} = 1$ and $f_{CLK} = 1\text{ MHz}$ | | 1 | | nV/s |
| Total harmonic distortion | THD | $V_{REF} = 5\text{ V}_{PP}$, Data = 3FFFh, $f = 1\text{ kHz}$ | | -105 | | dB |
| Output spot noise voltage | e_n | $f = 1\text{ kHz}$, BW = 1 Hz | | 12 | | $\text{nV}/\sqrt{\text{Hz}}$ |

(4) All ac characteristic tests are performed in a closed-loop system using a THS4011 I-to-V converter amplifier.

PIN CONFIGURATIONS

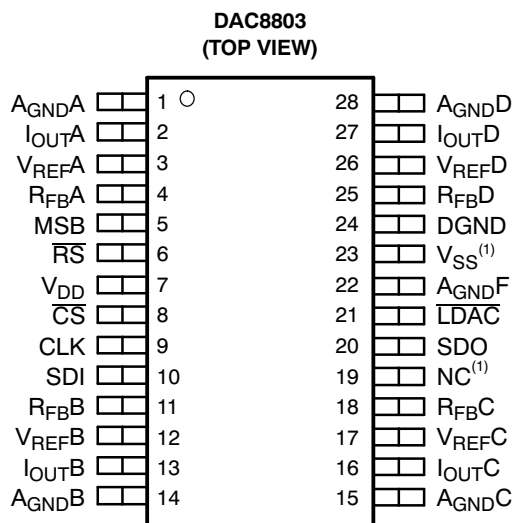

Note (1): No internal connection

PIN DESCRIPTION

| PIN | NAME | DESCRIPTION |
|---------------|-----------------------------|---|
| 1, 14, 15, 28 | AGNDA, AGNDB, AGNDC, AGND D | DAC A, B, C, D Analog ground |
| 2, 13, 16, 27 | IOUTA, IOUTB, IOUTC, IOUTD | DAC A, B, C, D Current output |
| 3, 12, 17, 26 | VREFA, VREFB, VREFC, VREFD | DAC A, B, C, D Reference voltage input terminal. Establishes DAC A, B, C, D full-scale output voltage. Can be tied to V _{DD} . |
| 4, 11, 18, 25 | RFB A, RFB B, RFB C, RFB D, | Establish voltage output for DAC A, B, C, D by connecting to external amplifier output. |
| 5 | MSB | MSB Bit set during a reset pulse (RS) or at system power-on if tied to ground or V _{DD} . |
| 6 | RS | Reset pin, active low. Input register and DAC registers are set to all zeros or half-scale code (2000h) determined by the voltage on the MSB pin. Register data = 2000h when MSB = 1. |
| 7 | V _{DD} | Positive power-supply input. Specified range of operation +2.7 V to +5.5 V. |
| 8 | CS | Chip select; active low input. Disables shift register loading when high. Transfers shift register data to input register when CS/LDAC goes high. Does not affect LDAC operation. |
| 9 | CLK | Clock input; positive edge triggered clocks data into shift register |
| 10 | SDI | Serial data input; data loads directly into the shift register. |
| 19 | NC | Not connected; leave floating |
| 20 | SDO | Serial data output; input data load directly into shift register. Data appears at SDO, 17 clock pulses after input at the SDI pin. |
| 21 | LDAC | Load DAC register strobe; level sensitive active low. Transfers all input register data to the DAC registers. Asynchronous active low input. See Table 1 for operation. |
| 22 | AGNDF | High current analog force ground. |
| 23 | V _{SS} | No internal connection. |
| 24 | DGND | Digital ground. |

TYPICAL CHARACTERISTICS: $V_{DD} = +5\text{ V}$

At $T_A = +25^\circ\text{C}$, $+V_{DD} = +5\text{ V}$, unless otherwise noted.

Channel A

LINEARITY ERROR vs DIGITAL INPUT CODE

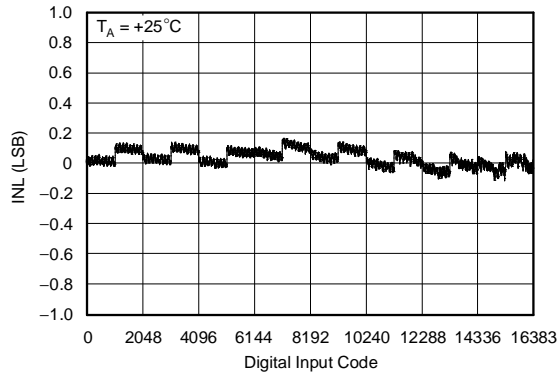

Figure 1.

DIFFERENTIAL LINEARITY ERROR vs DIGITAL INPUT CODE

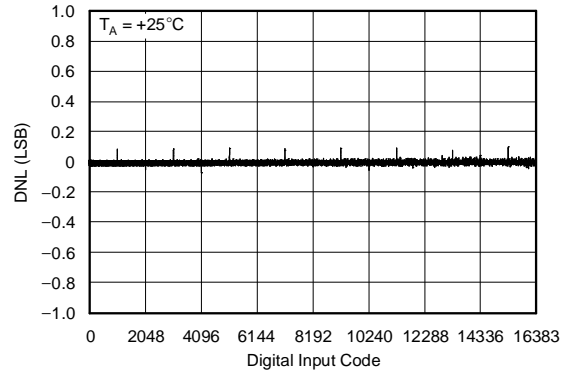

Figure 2.

LINEARITY ERROR vs DIGITAL INPUT CODE

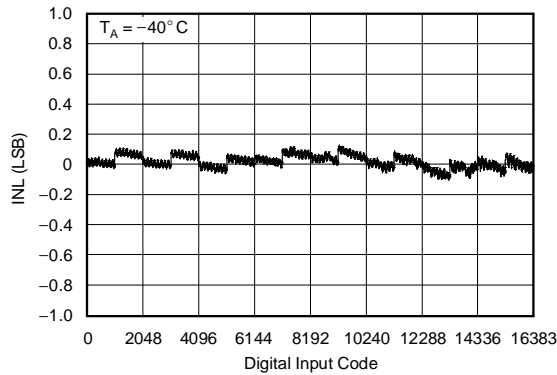

Figure 3.

DIFFERENTIAL LINEARITY ERROR vs DIGITAL INPUT CODE

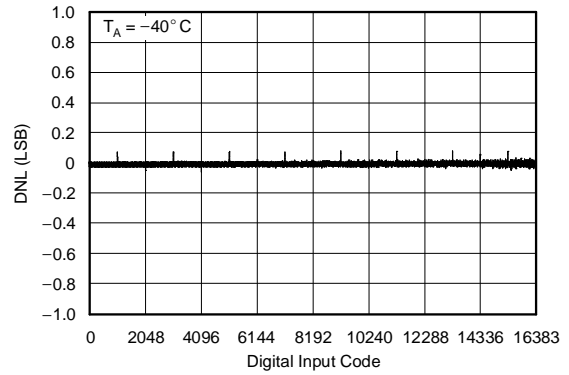

Figure 4.

LINEARITY ERROR vs DIGITAL INPUT CODE

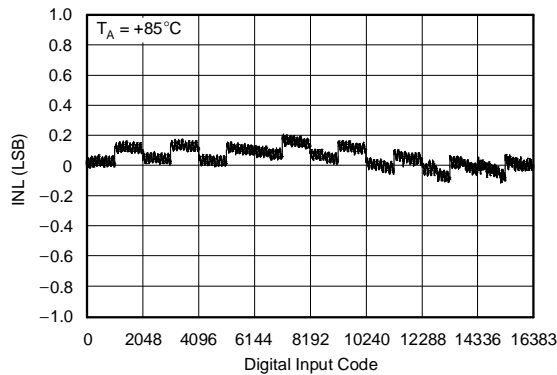

Figure 5.

DIFFERENTIAL LINEARITY ERROR vs DIGITAL INPUT CODE

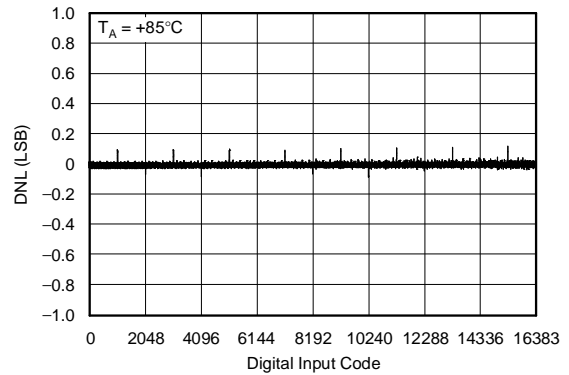

Figure 6.

TYPICAL CHARACTERISTICS: $V_{DD} = +5\text{ V}$ (continued)

At $T_A = +25^\circ\text{C}$, $+V_{DD} = +5\text{ V}$, unless otherwise noted.

Channel B

**LINEARITY ERROR
vs DIGITAL INPUT CODE**

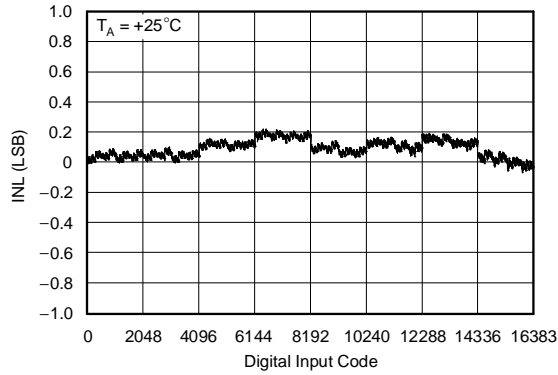

Figure 7.

**DIFFERENTIAL LINEARITY ERROR
vs DIGITAL INPUT CODE**

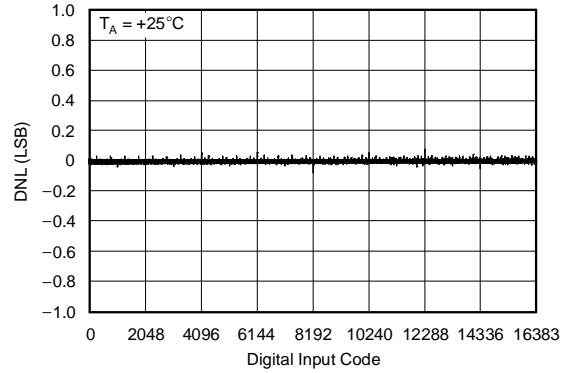

Figure 8.

**LINEARITY ERROR
vs DIGITAL INPUT CODE**

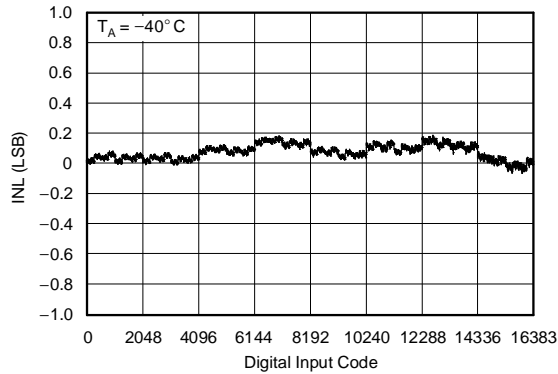

Figure 9.

**DIFFERENTIAL LINEARITY ERROR
vs DIGITAL INPUT CODE**

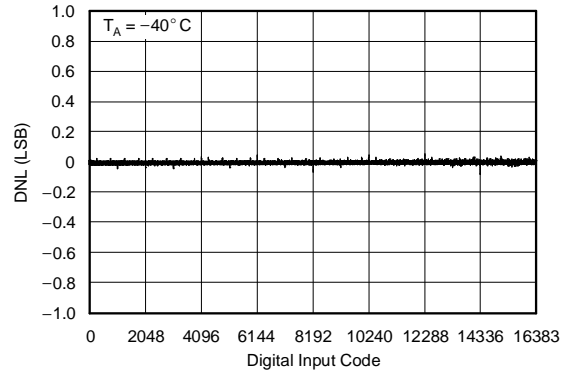

Figure 10.

**LINEARITY ERROR
vs DIGITAL INPUT CODE**

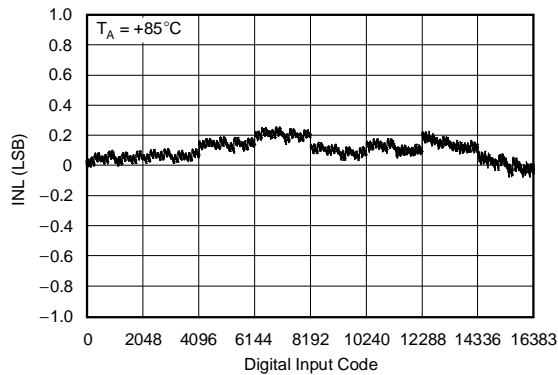

Figure 11.

**DIFFERENTIAL LINEARITY ERROR
vs DIGITAL INPUT CODE**

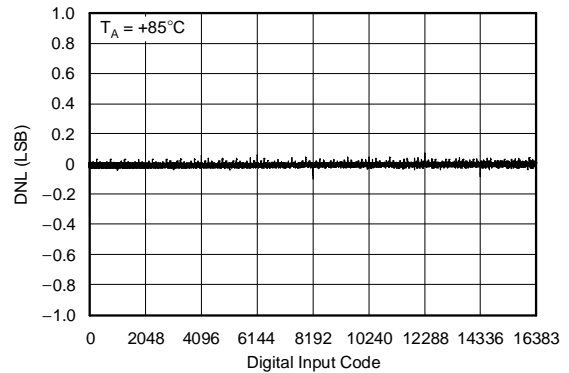

Figure 12.

TYPICAL CHARACTERISTICS: $V_{DD} = +5\text{ V}$ (continued)

At $T_A = +25^\circ\text{C}$, $+V_{DD} = +5\text{ V}$, unless otherwise noted.

Channel C

LINEARITY ERROR vs DIGITAL INPUT CODE

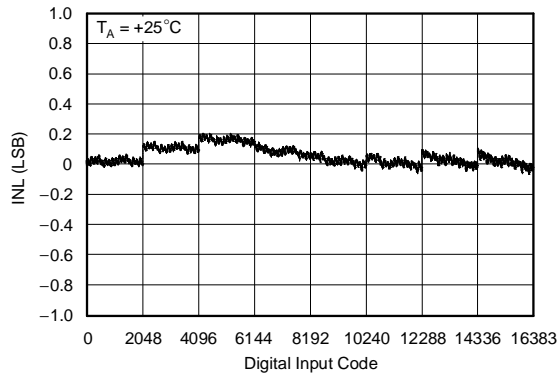

Figure 13.

DIFFERENTIAL LINEARITY ERROR vs DIGITAL INPUT CODE

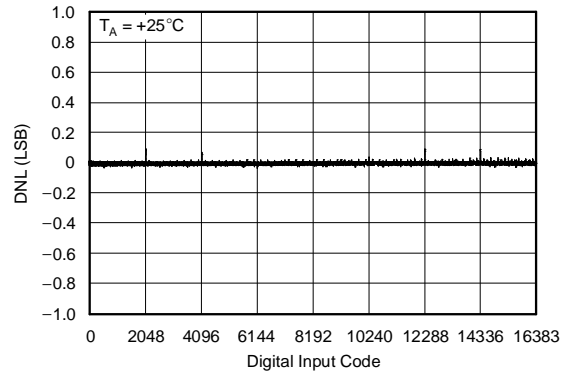

Figure 14.

LINEARITY ERROR vs DIGITAL INPUT CODE

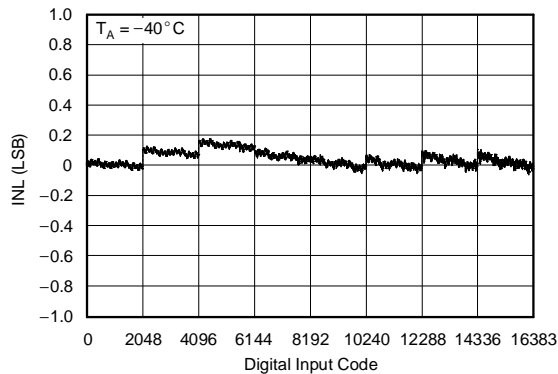

Figure 15.

DIFFERENTIAL LINEARITY ERROR vs DIGITAL INPUT CODE

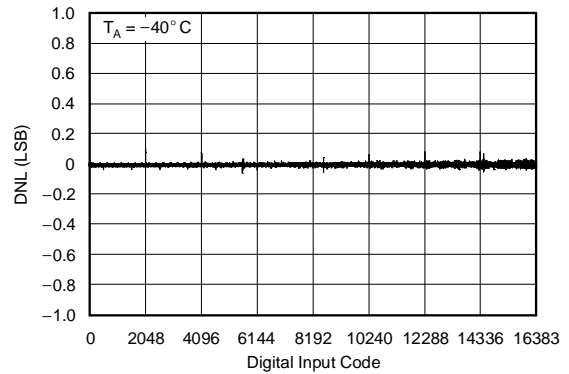

Figure 16.

LINEARITY ERROR vs DIGITAL INPUT CODE

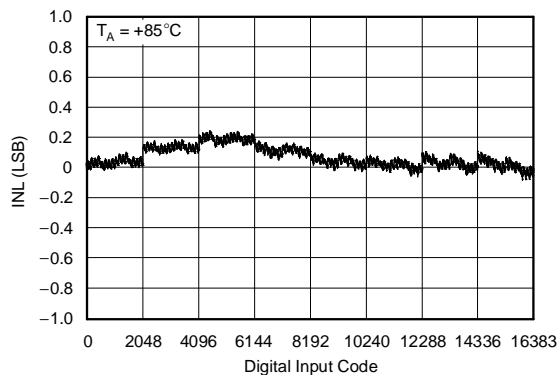

Figure 17.

DIFFERENTIAL LINEARITY ERROR vs DIGITAL INPUT CODE

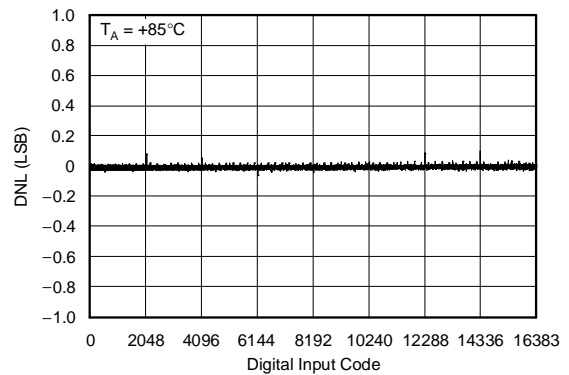
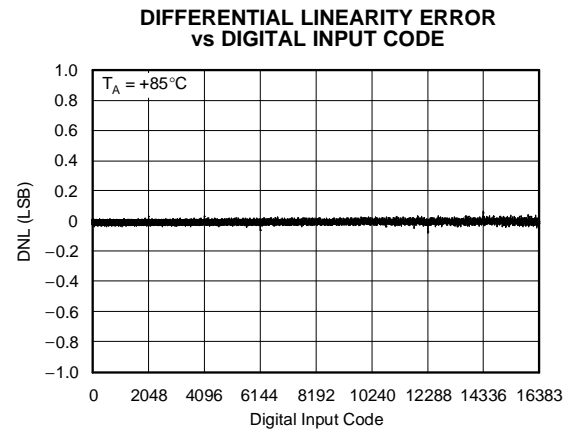
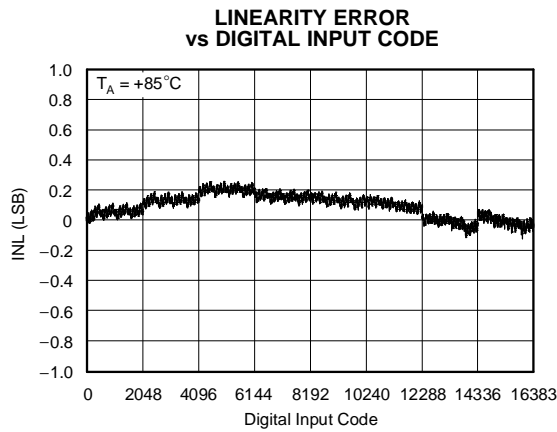
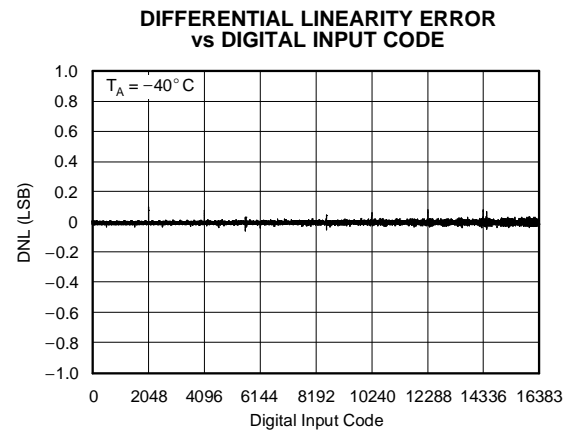
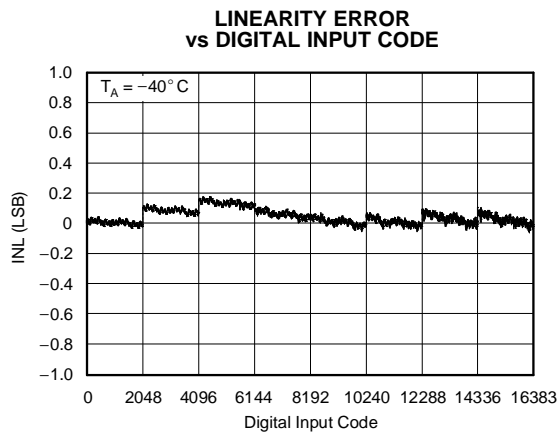
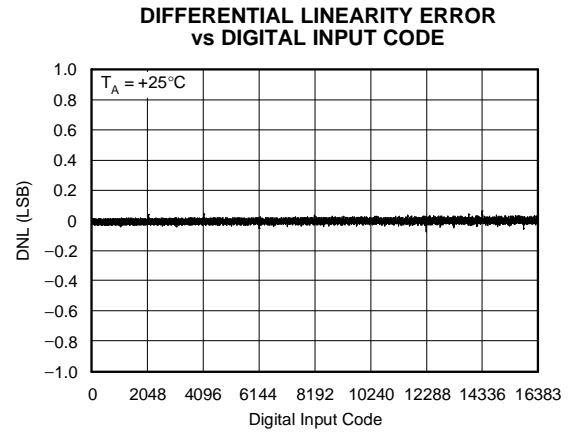
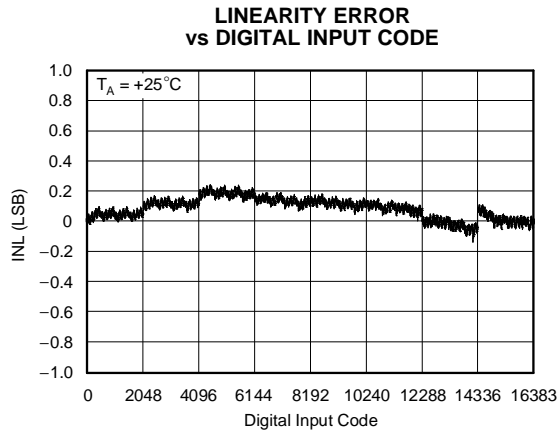

Figure 18.

TYPICAL CHARACTERISTICS: $V_{DD} = +5\text{ V}$ (continued)

At $T_A = +25^\circ\text{C}$, $+V_{DD} = +5\text{ V}$, unless otherwise noted.

Channel D



TYPICAL CHARACTERISTICS: $V_{DD} = +5\text{ V}$ (continued)

At $T_A = +25^\circ\text{C}$, $+V_{DD} = +5\text{ V}$, unless otherwise noted.

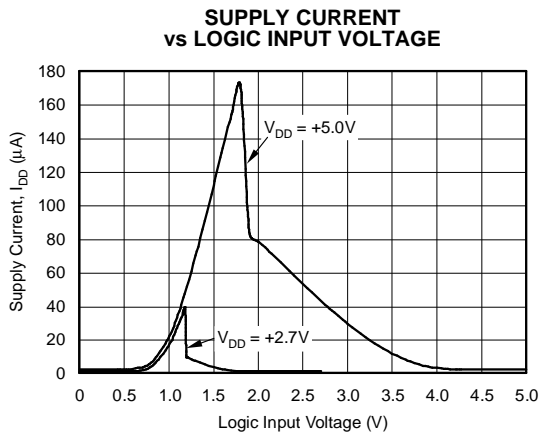

Figure 25.

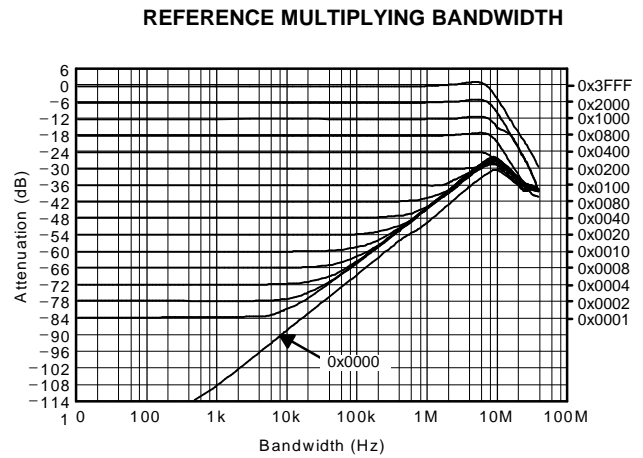

Figure 26.

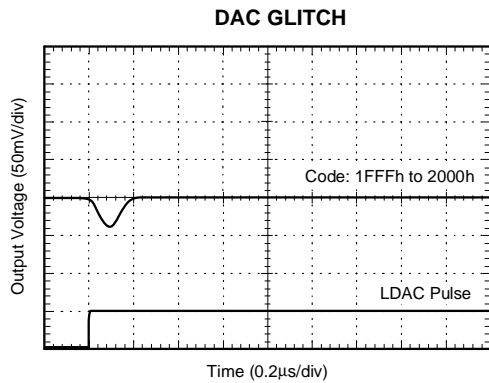

Figure 27.

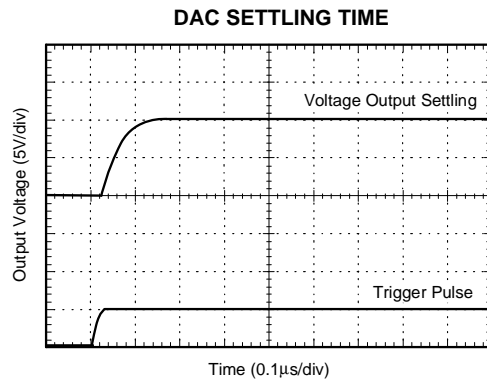

Figure 28.

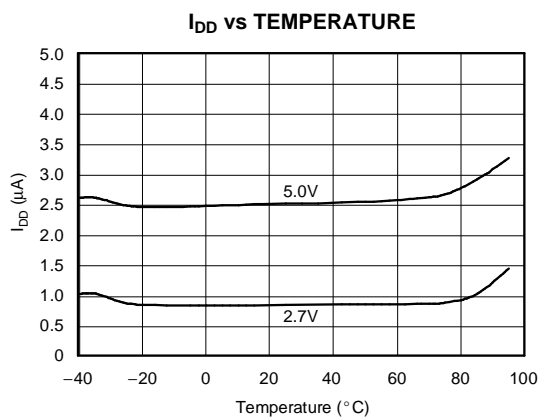

Figure 29.

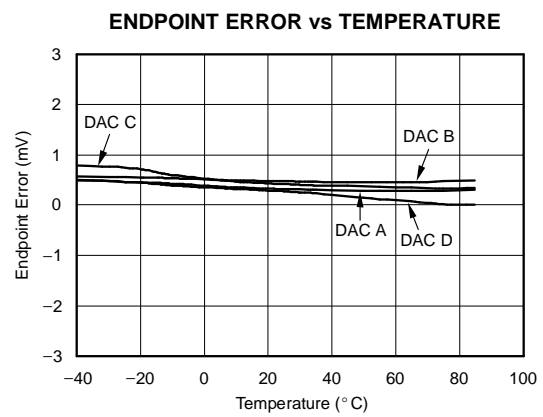

Figure 30.

TYPICAL CHARACTERISTICS: $V_{DD} = +2.7\text{ V}$

At $T_A = +25^\circ\text{C}$, $+V_{DD} = +2.7\text{ V}$, unless otherwise noted.

Channel A

**LINEARITY ERROR
vs DIGITAL INPUT CODE**

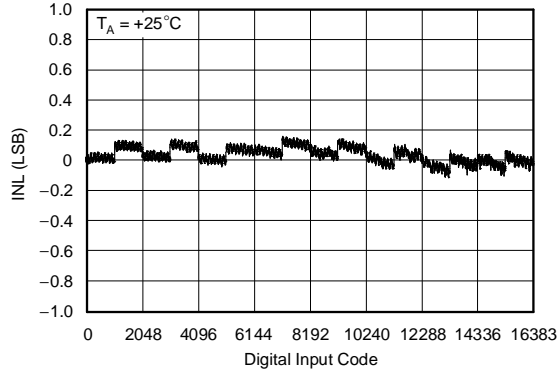

Figure 31.

**DIFFERENTIAL LINEARITY ERROR
vs DIGITAL INPUT CODE**

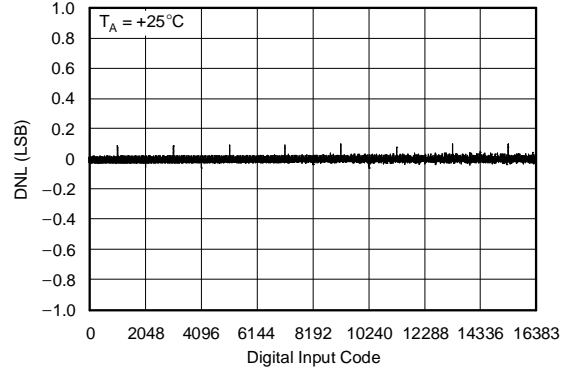

Figure 32.

**LINEARITY ERROR
vs DIGITAL INPUT CODE**

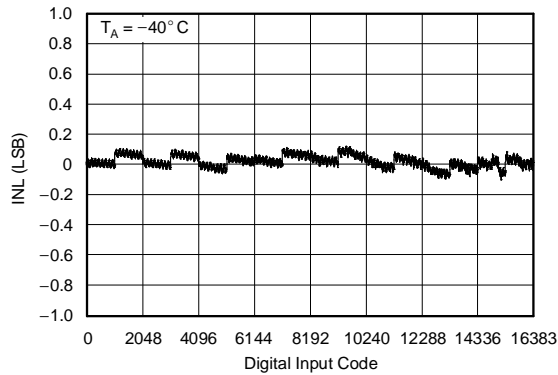

Figure 33.

**DIFFERENTIAL LINEARITY ERROR
vs DIGITAL INPUT CODE**

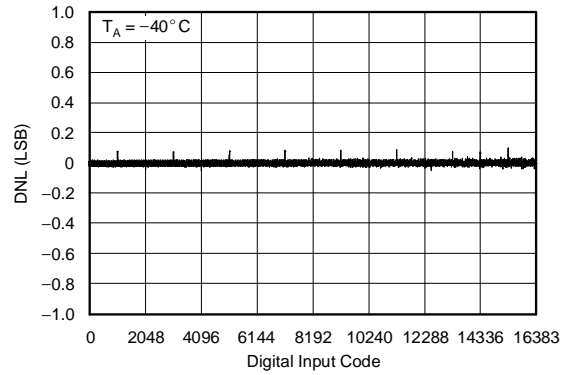

Figure 34.

**LINEARITY ERROR
vs DIGITAL INPUT CODE**

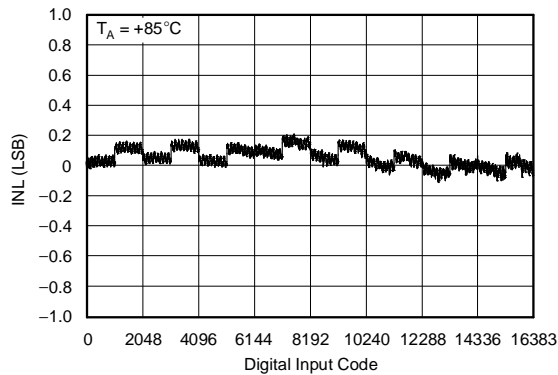

Figure 35.

**DIFFERENTIAL LINEARITY ERROR
vs DIGITAL INPUT CODE**

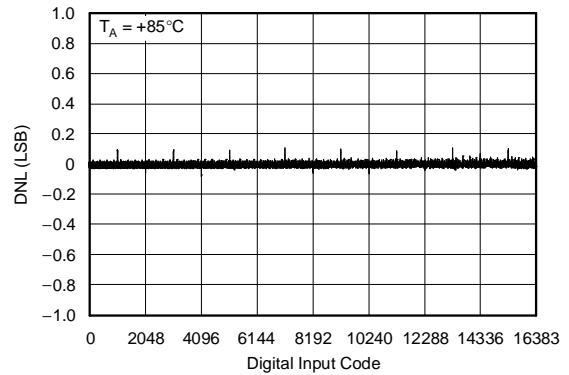

Figure 36.

TYPICAL CHARACTERISTICS: $V_{DD} = +2.7\text{ V}$ (continued)

At $T_A = +25^\circ\text{C}$, $+V_{DD} = +2.7\text{ V}$, unless otherwise noted.

Channel B

LINEARITY ERROR vs DIGITAL INPUT CODE

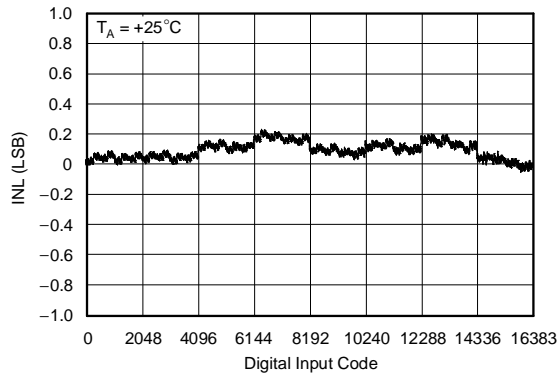

Figure 37.

DIFFERENTIAL LINEARITY ERROR vs DIGITAL INPUT CODE

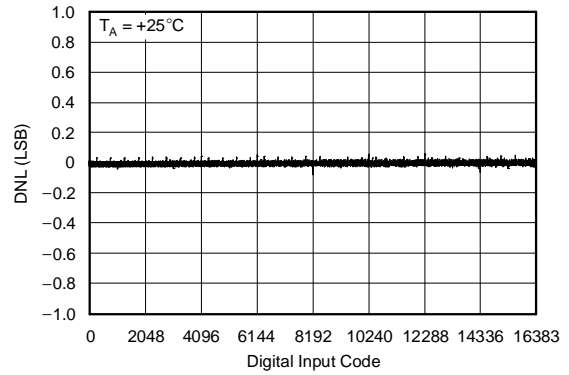

Figure 38.

LINEARITY ERROR vs DIGITAL INPUT CODE

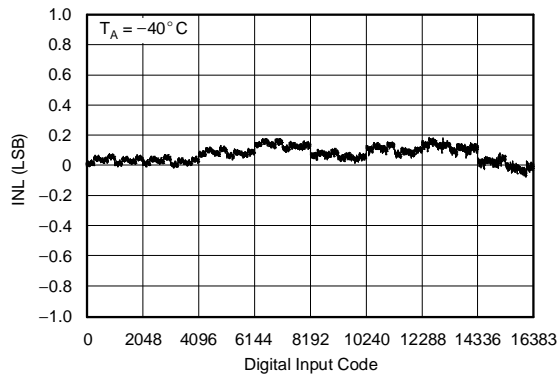

Figure 39.

DIFFERENTIAL LINEARITY ERROR vs DIGITAL INPUT CODE

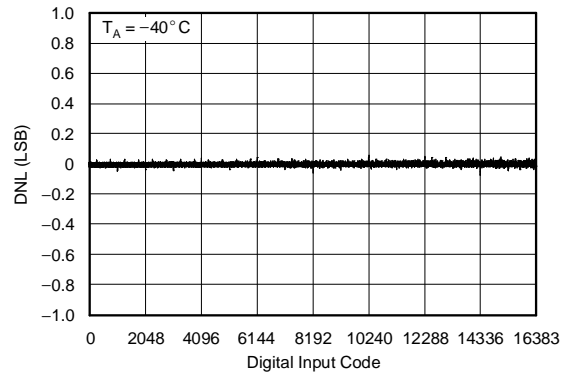

Figure 40.

LINEARITY ERROR vs DIGITAL INPUT CODE

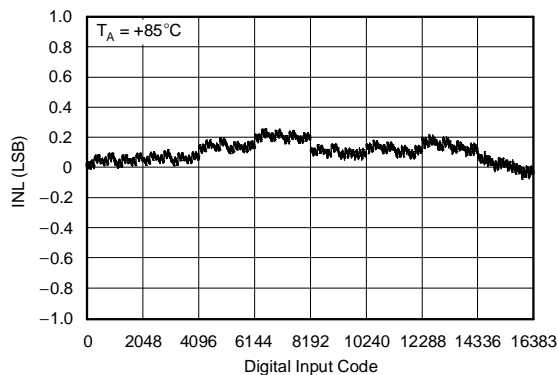

Figure 41.

DIFFERENTIAL LINEARITY ERROR vs DIGITAL INPUT CODE

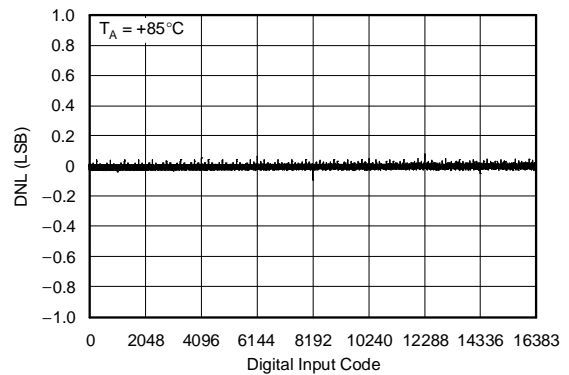

Figure 42.

TYPICAL CHARACTERISTICS: $V_{DD} = +2.7\text{ V}$ (continued)

At $T_A = +25^\circ\text{C}$, $+V_{DD} = +2.7\text{ V}$, unless otherwise noted.

Channel C

**LINEARITY ERROR
vs DIGITAL INPUT CODE**

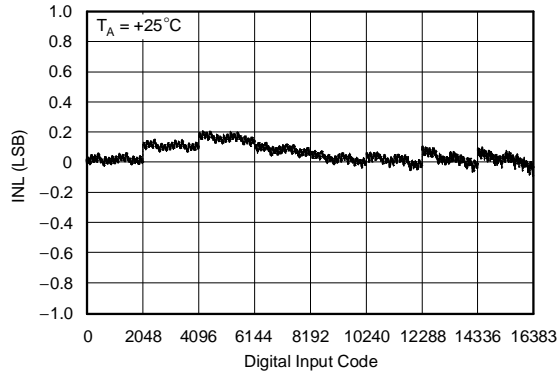

Figure 43.

**DIFFERENTIAL LINEARITY ERROR
vs DIGITAL INPUT CODE**

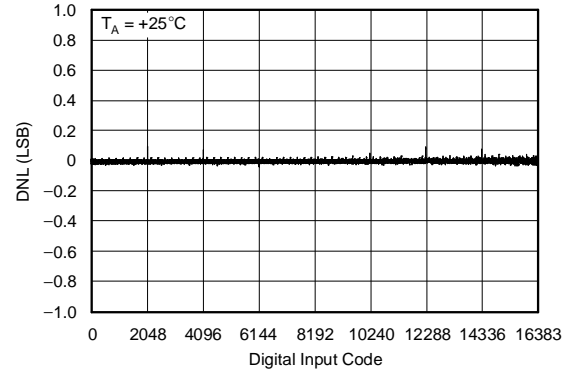

Figure 44.

**LINEARITY ERROR
vs DIGITAL INPUT CODE**

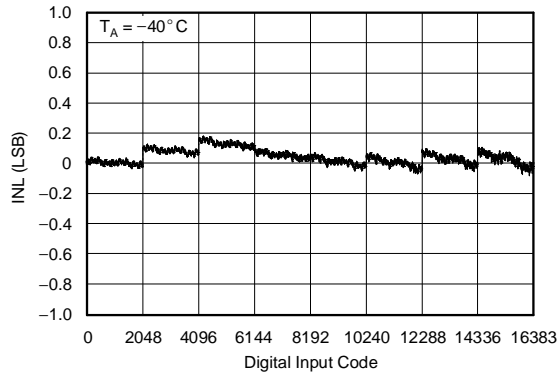

Figure 45.

**DIFFERENTIAL LINEARITY ERROR
vs DIGITAL INPUT CODE**

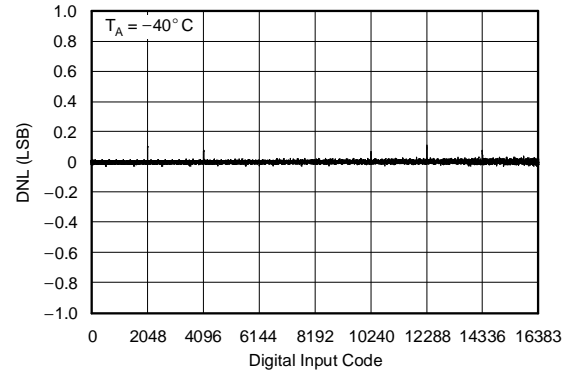

Figure 46.

**LINEARITY ERROR
vs DIGITAL INPUT CODE**

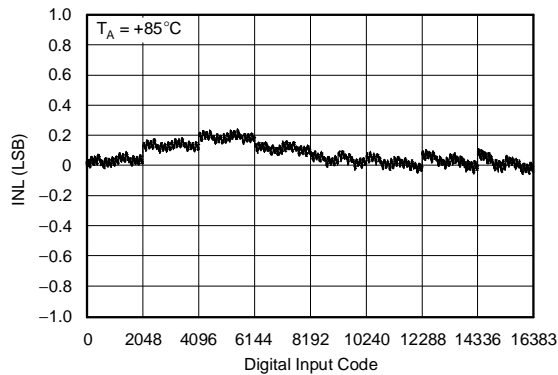

Figure 47.

**DIFFERENTIAL LINEARITY ERROR
vs DIGITAL INPUT CODE**

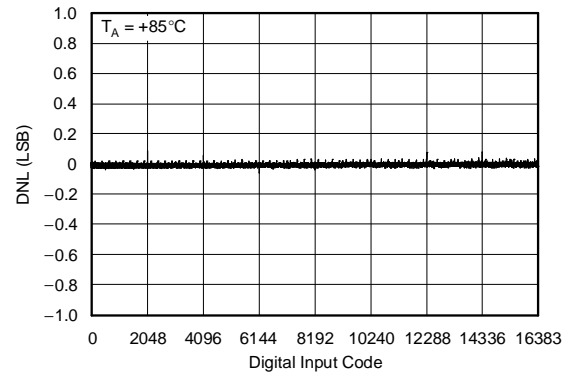

Figure 48.

TYPICAL CHARACTERISTICS: $V_{DD} = +2.7\text{ V}$ (continued)

At $T_A = +25^\circ\text{C}$, $+V_{DD} = +2.7\text{ V}$, unless otherwise noted.

Channel D

LINEARITY ERROR vs DIGITAL INPUT CODE

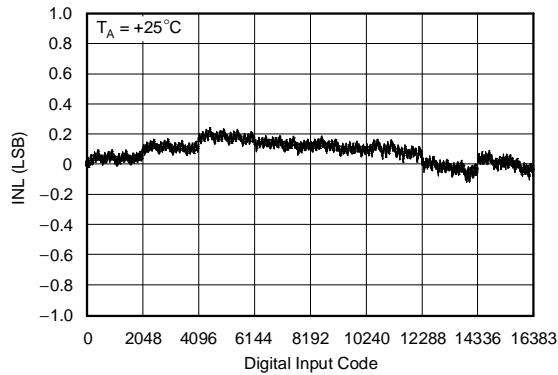

Figure 49.

DIFFERENTIAL LINEARITY ERROR vs DIGITAL INPUT CODE

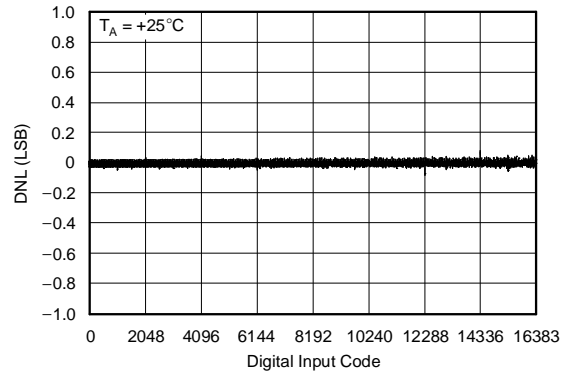

Figure 50.

LINEARITY ERROR vs DIGITAL INPUT CODE

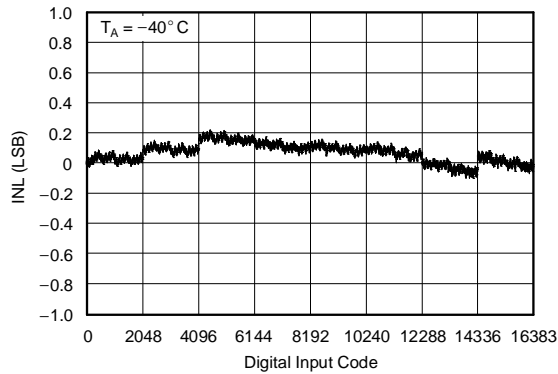

Figure 51.

DIFFERENTIAL LINEARITY ERROR vs DIGITAL INPUT CODE

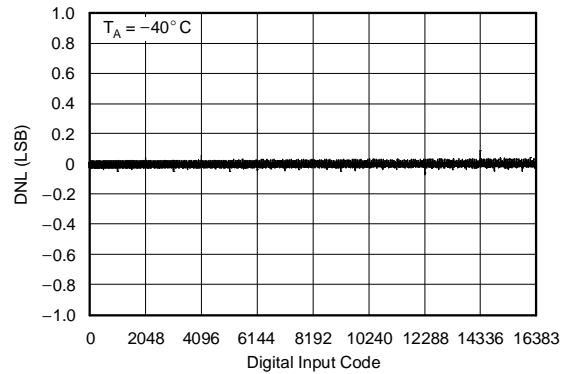

Figure 52.

LINEARITY ERROR vs DIGITAL INPUT CODE

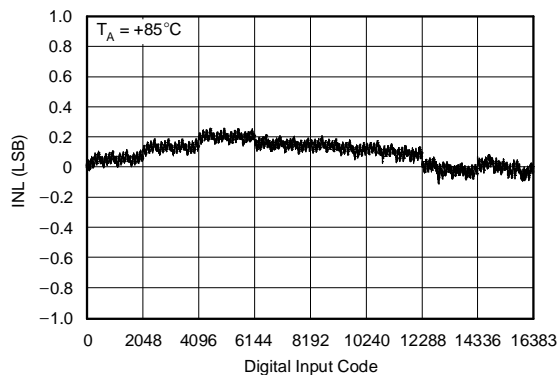

Figure 53.

DIFFERENTIAL LINEARITY ERROR vs DIGITAL INPUT CODE

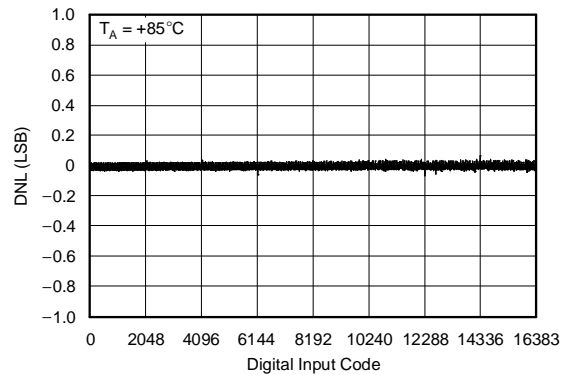

Figure 54.

TYPICAL CHARACTERISTICS: $V_{DD} = +2.7\text{ V}$ (continued)

At $T_A = +25^\circ\text{C}$, $+V_{DD} = +2.7\text{ V}$, unless otherwise noted.

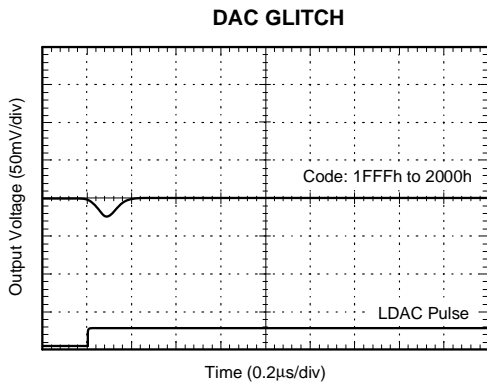

Figure 55.

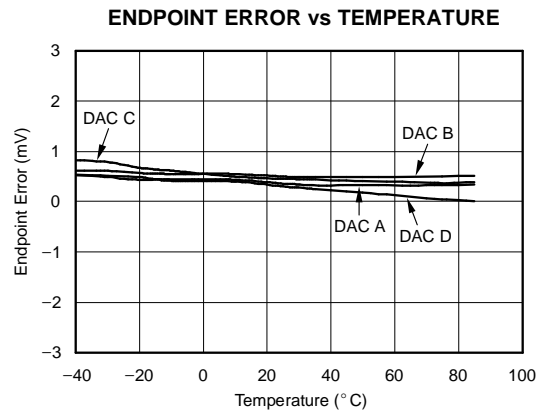

Figure 56.

TIMING INFORMATION

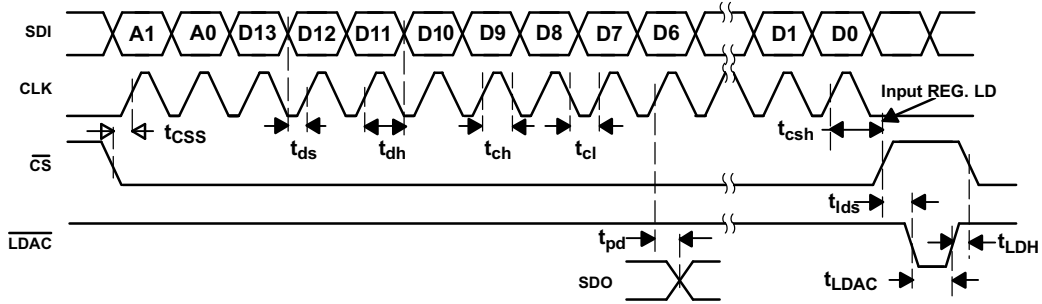

Figure 57. DAC8803 Timing Diagram

THEORY OF OPERATION

CIRCUIT OPERATION

The DAC8803 contains four, 14-bit, current-output, digital-to-analog converters (DACs) respectively. Each DAC has its own independent multiplying reference input. The DAC8803 uses a 3-wire SPI-compatible serial data interface, with a configurable asynchronous \overline{RS} pin for half-scale (MSB = 1) or zero-scale (MSB = 0) preset. In addition, an \overline{LDAC} strobe enables four channel simultaneous updates for hardware synchronized output voltage changes.

D/A Converter

The DAC8803 contains four current-steering R-2R ladder DACs. Figure 58 shows a typical equivalent DAC. Each DAC contains a matching feedback resistor for use with an external I-to-V converter amplifier. The R_{FBX} pin is connected to the output of the external amplifier. The I_{OUTX} terminal is connected to the inverting input of the external amplifier. The A_{GNDX} pin should be Kelvin-connected to the load point in the circuit requiring the full 14-bit accuracy.

The DAC is designed to operate with both negative or positive reference voltages. The V_{DD} power pin is only used by the logic to drive the DAC switches on and off. Note that a matching switch is used in series with the internal 5 k Ω feedback resistor. If users are attempting to measure the value of R_{FB} , power must be applied to V_{DD} in order to achieve continuity. The DAC output voltage is determined by V_{REF} and the digital data (D) according to Equation 1:

$$V_{OUT} = -V_{REF} \times \frac{D}{16384} \quad (1)$$

Note that the output polarity is opposite to the V_{REF} polarity for dc reference voltages.

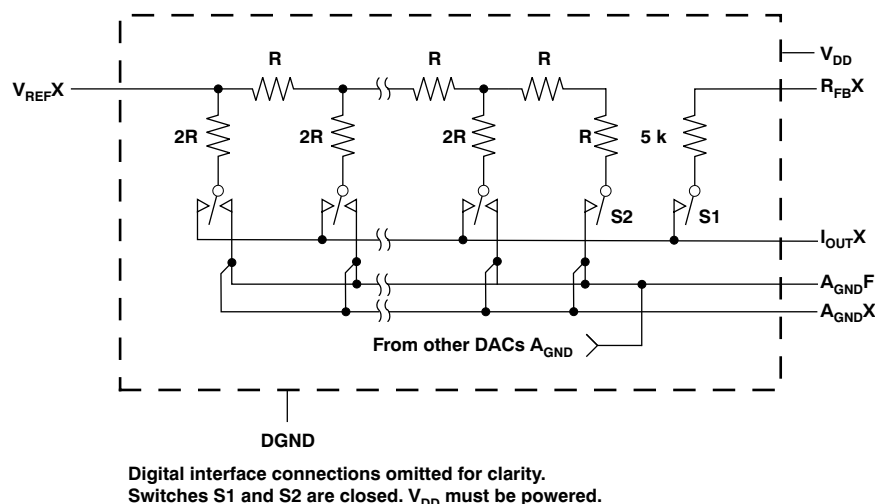

Figure 58. Typical Equivalent DAC Channel

The DAC is also designed to accommodate ac reference input signals. The DAC8803 accommodates input reference voltages in the range of -15 V to +15 V. The reference voltage inputs exhibit a constant nominal input resistance of 5 k Ω , $\pm 20\%$. On the other hand, the DAC outputs I_{OUTA} , B, C, D are code-dependent and produce various output resistances and capacitances.

The choice of external amplifier should take into account the variation in impedance generated by the DAC8803 on the amplifiers' inverting input node. The feedback resistance, in parallel with the DAC ladder resistance, dominates output voltage noise. For multiplying mode applications, an external feedback compensation capacitor (C_{FB}) may be needed to provide a critically damped output response for step changes in reference input voltages.

Figure 26 shows the gain versus frequency performance at various attenuation settings using a 3 pF external feedback capacitor connected across the I_{OUTX} and R_{FBX} terminals. In order to maintain good analog performance, power supply bypassing of 0.01 μ F, in parallel with 1 μ F, is recommended. Under these conditions, clean power supply with low ripple voltage capability should be used. Switching power supplies are usually not suitable for this application because of the higher ripple voltage and P_{SS} frequency-dependent characteristics. It is best to derive the DAC8803 5-V supply from the system analog supply voltages. (Do not use the digital 5-V supply.) See Figure 59.

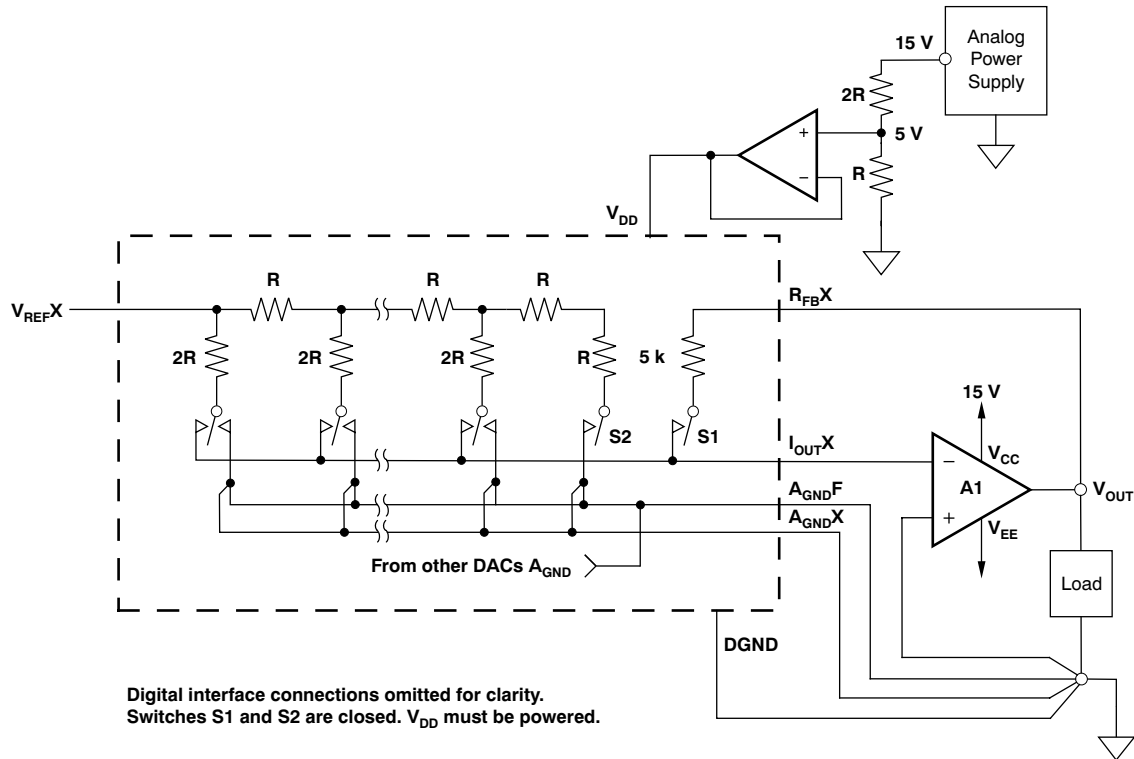

Figure 59. Recommended Kelvin-Sensed Hookup

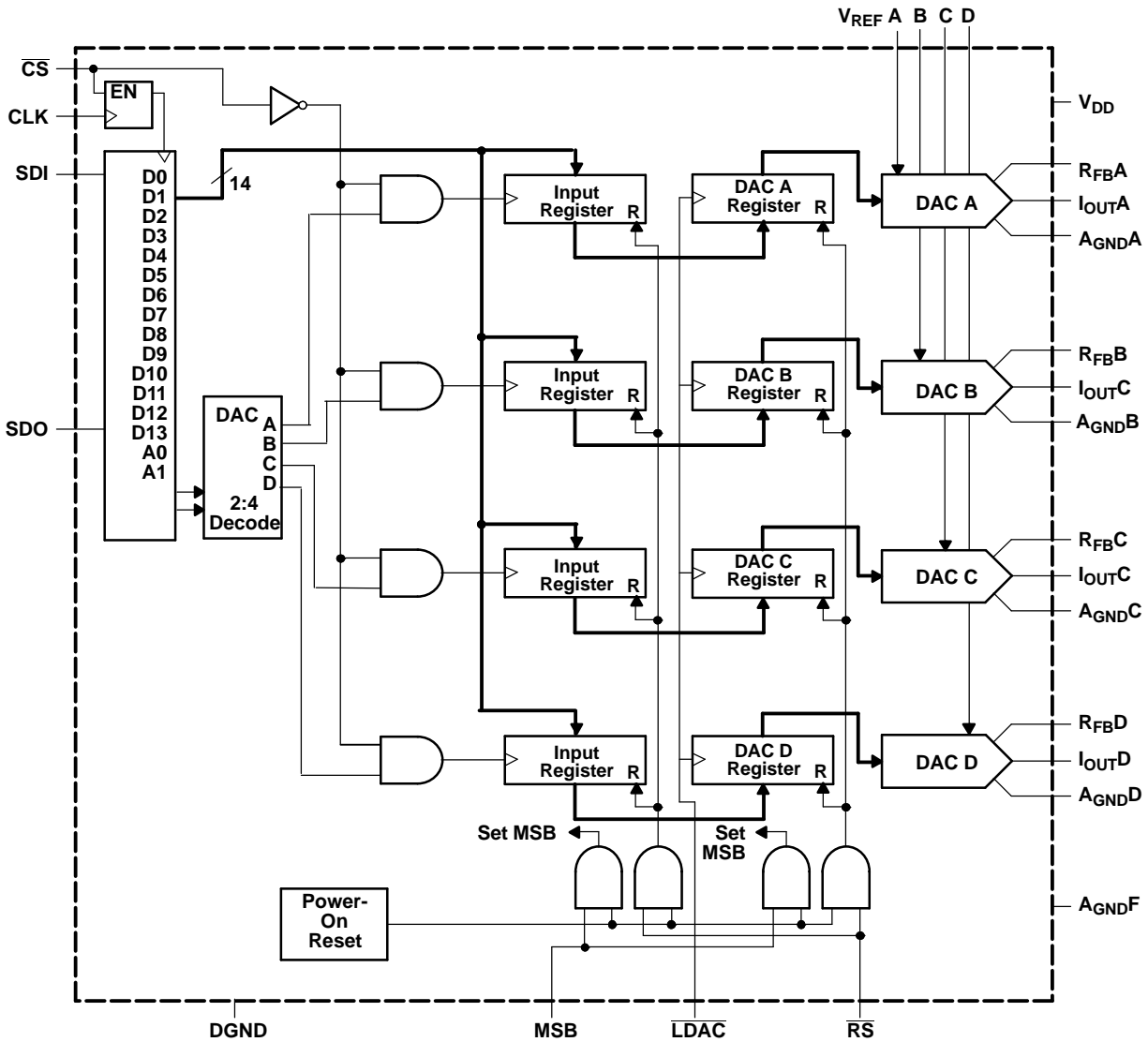

Figure 60. System Level Digital Interfacing

SERIAL DATA INTERFACE

The DAC8803 uses a 3-wire (\overline{CS} , SDI, CLK) SPI-compatible serial data interface. Serial data of the DAC8803 is clocked into the serial input register in a 16-bit data-word format. MSB bits are loaded first. Table 2 defines the 16 data-word bits for the DAC8803.

Data is placed on the SDI pin, and clocked into the register on the positive clock edge of CLK subject to the data setup and data hold time requirements specified in the Interface Timing Specifications. Data can only be clocked in while the \overline{CS} chip select pin is active low. For the DAC8803, only the last 16 bits clocked into the serial register are interrogated when the \overline{CS} pin returns to the logic high state.

Since most microcontrollers output serial data in 8-bit bytes, two right-justified data bytes can be written to the DAC8803. Keeping the \overline{CS} line low between the first and second byte transfers results in a successful serial register update.

Once the data is properly aligned in the shift register, the positive edge of the \overline{CS} initiates the transfer of new data to the target DAC register, determined by the decoding of address bits A1 and A0. For the DAC8803, [Table 2](#) and [Table 3](#) define the characteristics of the software serial interface. [Figure 61](#) shows the equivalent logic interface for the key digital control pins for the DAC8803.

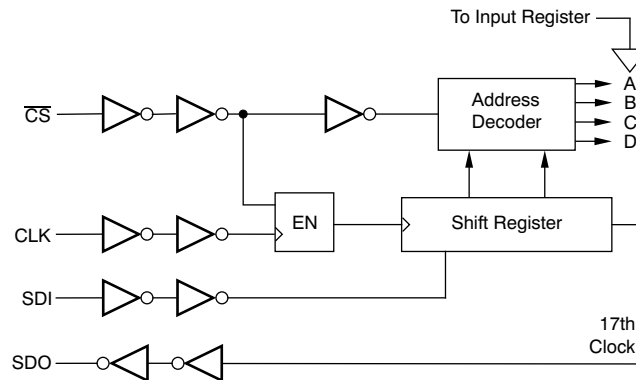

Figure 61. DAC8803 Equivalent Logic Interface

Two additional pins \overline{RS} and MSB provide hardware control over the preset function and DAC register loading. If these functions are not needed, the \overline{RS} pin can be tied to logic high. The asynchronous input \overline{RS} pin forces all input and DAC registers to either the zero-code state (MSB = 0), or the half-scale state (MSB = 1).

POWER ON RESET

When the V_{DD} power supply is turned on, an internal reset strobe forces all the Input and DAC registers to the zero-code state or half-scale, depending on the MSB pin voltage. The V_{DD} power supply should have a smooth positive ramp without drooping in order to have consistent results, especially in the region of $V_{DD} = 1.5$ V to 2.3 V. The DAC register data stays at zero or half-scale setting until a valid serial register data load takes place.

ESD Protection Circuits

All logic-input pins contain back-biased ESD protection zener diodes connected to ground (DGND) and V_{DD} as shown in [Figure 62](#).

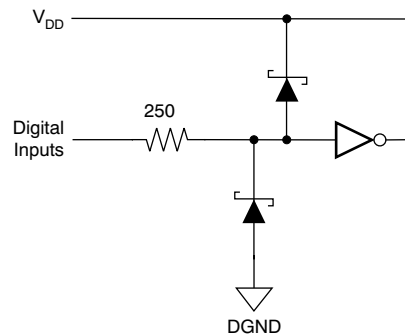

Figure 62. Equivalent ESD Protection Circuits

PCB LAYOUT

The DAC8803 is a high-accuracy DAC that can have its performance compromised by grounding and printed circuit board (PCB) lead trace resistance. The 14-bit DAC8803 with a 10-V full-scale range has an LSB value of 610 μ V. The ladder and associated reference and analog ground currents for a given channel can be as high as 2 mA. With this 2 mA current level, a series wiring and connector resistance of only 305 m Ω will cause 1 LSB of voltage drop. The preferred PCB layout for the DAC8803 is to have all A_{GNDX} pins connected directly to an analog ground plane at the unit. The non-inverting input of each channel I/V converter should also either connect directly to the analog ground plane or have an individual sense trace back to the A_{GNDX} pin connection. The feedback resistor trace to the I/V converter should also be kept short and low resistance to prevent IR drops from contributing to gain error. This attention to wiring ensures the optimal performance of the DAC8803.

Table 1. Control Logic Truth Table⁽¹⁾

| \overline{CS} | CLK | \overline{LDAC} | \overline{RS} | MSB | SERIAL SHIFT REGISTER | INPUT REGISTER | DAC REGISTER |
|-----------------|-------------|-------------------|-----------------|-----|--------------------------------------|---|----------------------|
| H | X | H | H | X | No effect | Latched | Latched |
| L | L | H | H | X | No effect | Latched | Latched |
| L | $\uparrow+$ | H | H | X | Shift register data advanced one bit | Latched | Latched |
| L | H | H | H | X | No effect | Latched | Latched |
| $\uparrow+$ | L | H | H | X | No effect | Selected DAC updated with current SR contents | Latched |
| H | X | L | H | X | No effect | Latched | Transparent |
| H | X | H | H | X | No effect | Latched | Latched |
| H | X | $\uparrow+$ | H | X | No effect | Latched | Latched |
| H | X | H | L | 0 | No effect | Latched data = 0000h | Latched data = 0000h |
| H | X | H | L | H | No effect | Latched data = 2000h | Latched data = 2000h |

(1) $\uparrow+$ Positive logic transition; X = Do not care

Table 2. Serial Input Register Data Format, Data Loaded MSB First⁽¹⁾

| Bit | B15 (MSB) | B14 | B13 | B12 | B11 | B10 | B9 | B8 | B7 | B6 | B5 | B4 | B3 | B2 | B1 | B0 (LSB) |
|------|-----------|-----|-----|-----|-----|-----|----|----|----|----|----|----|----|----|----|----------|
| Data | A1 | A0 | D13 | D12 | D11 | D10 | D9 | D8 | D7 | D6 | D5 | D4 | D3 | D2 | D1 | D0 |

(1) Only the last 16 bits of data clocked into the serial register (address + data) are inspected when the \overline{CS} line positive edge returns to logic high. At this point an internally generated load strobe transfers the serial register data contents (bits D13-D0) to the decoded DAC-input-register address determined by bits A1 and A0. Any extra bits clocked into the DAC8803 shift register are ignored; only the last 16 bits clocked in are used. If double-buffered data is not needed, the \overline{LDAC} pin can be tied logic low to disable the DAC registers.

Table 3. Address Decode

| A1 | A0 | DAC DECODE |
|----|----|------------|
| 0 | 0 | DAC A |
| 0 | 1 | DAC B |
| 1 | 0 | DAC C |
| 1 | 1 | DAC D |

APPLICATION INFORMATION

The DAC8803, a 2-quadrant multiplying DAC, can be used to generate a unipolar output. The polarity of the full-scale output I_{OUT} is the inverse of the input reference voltage at V_{REF} .

Some applications require full 4-quadrant multiplying capabilities or bipolar output swing, as shown in Figure 63. An additional external op amp A2 is added as a summing amp. In this circuit the first and second amps (A1 and A2) provide a gain of 2X that widens the output span to 20 V. A 4-quadrant multiplying circuit is implemented by using a 10-V offset of the reference voltage to bias A2. According to the following circuit transfer equation (Equation 2), input data (D) from code 0 to full scale produces output voltages of $V_{OUT} = -10\text{ V}$ to $V_{OUT} = 10\text{ V}$.

$$V_{OUT} = \left(\frac{D}{8192} - 1 \right) \times V_{REF} \quad (2)$$

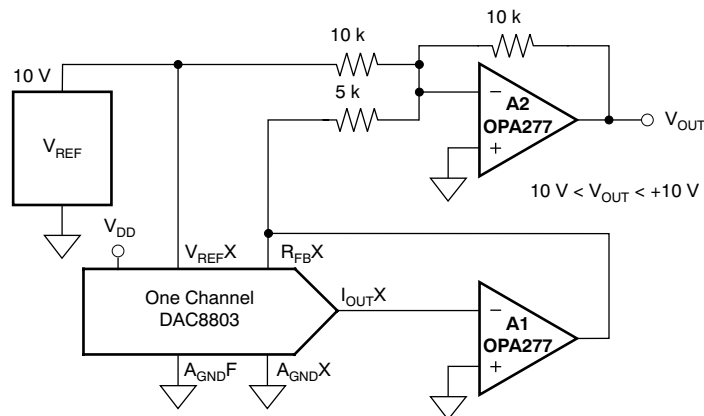

Digital interface connections omitted for clarity.

Figure 63. Four-Quadrant Multiplying Application Circuit

Cross-Reference

The DAC8803 has an industry-standard pinout. Table 4 provides the cross-reference information.

Table 4. Cross-Reference

| PRODUCT | INL (LSB) | DNL (LSB) | SPECIFIED TEMPERATURE RANGE | PACKAGE DESCRIPTION | PACKAGE OPTION | CROSS-REFERENCE PART |
|------------|-----------|-----------|-----------------------------|---------------------|----------------|----------------------|
| DAC8803IDB | ±1 | ±1 | -40°C to +85°C | 28-Lead MicroSOIC | SSOP-28 | AD5554BRS |

PACKAGING INFORMATION

| Orderable part number | Status (1) | Material type (2) | Package Pins | Package qty Carrier | RoHS (3) | Lead finish/ Ball material (4) | MSL rating/ Peak reflow (5) | Op temp (°C) | Part marking (6) |
|-----------------------------|---------------|----------------------|----------------|-----------------------|-------------|--------------------------------------|-----------------------------------|--------------|---------------------|
| DAC8803IDBR | Active | Production | SSOP (DB) 28 | 2000 LARGE T&R | Yes | NIPDAU | Level-2-260C-1 YEAR | -40 to 85 | DAC8803 |
| DAC8803IDBT | Active | Production | SSOP (DB) 28 | 250 SMALL T&R | Yes | NIPDAU | Level-2-260C-1 YEAR | -40 to 85 | DAC8803 |

(1) **Status:** For more details on status, see our [product life cycle](#).

(2) **Material type:** When designated, preproduction parts are prototypes/experimental devices, and are not yet approved or released for full production. Testing and final process, including without limitation quality assurance, reliability performance testing, and/or process qualification, may not yet be complete, and this item is subject to further changes or possible discontinuation. If available for ordering, purchases will be subject to an additional waiver at checkout, and are intended for early internal evaluation purposes only. These items are sold without warranties of any kind.

(3) **RoHS values:** Yes, No, RoHS Exempt. See the [TI RoHS Statement](#) for additional information and value definition.

(4) **Lead finish/Ball material:** Parts may have multiple material finish options. Finish options are separated by a vertical ruled line. Lead finish/Ball material values may wrap to two lines if the finish value exceeds the maximum column width.

(5) **MSL rating/Peak reflow:** The moisture sensitivity level ratings and peak solder (reflow) temperatures. In the event that a part has multiple moisture sensitivity ratings, only the lowest level per JEDEC standards is shown. Refer to the shipping label for the actual reflow temperature that will be used to mount the part to the printed circuit board.

(6) **Part marking:** There may be an additional marking, which relates to the logo, the lot trace code information, or the environmental category of the part.

Multiple part markings will be inside parentheses. Only one part marking contained in parentheses and separated by a "~" will appear on a part. If a line is indented then it is a continuation of the previous line and the two combined represent the entire part marking for that device.

Important Information and Disclaimer:The information provided on this page represents TI's knowledge and belief as of the date that it is provided. TI bases its knowledge and belief on information provided by third parties, and makes no representation or warranty as to the accuracy of such information. Efforts are underway to better integrate information from third parties. TI has taken and continues to take reasonable steps to provide representative and accurate information but may not have conducted destructive testing or chemical analysis on incoming materials and chemicals. TI and TI suppliers consider certain information to be proprietary, and thus CAS numbers and other limited information may not be available for release.

In no event shall TI's liability arising out of such information exceed the total purchase price of the TI part(s) at issue in this document sold by TI to Customer on an annual basis.

TAPE AND REEL INFORMATION

QUADRANT ASSIGNMENTS FOR PIN 1 ORIENTATION IN TAPE

*All dimensions are nominal

| Device | Package Type | Package Drawing | Pins | SPQ | Reel Diameter (mm) | Reel Width W1 (mm) | A0 (mm) | B0 (mm) | K0 (mm) | P1 (mm) | W (mm) | Pin1 Quadrant |
|-------------|--------------|-----------------|------|------|--------------------|--------------------|---------|---------|---------|---------|--------|---------------|
| DAC8803IDBR | SSOP | DB | 28 | 2000 | 330.0 | 16.4 | 8.1 | 10.4 | 2.5 | 12.0 | 16.0 | Q1 |

TAPE AND REEL BOX DIMENSIONS

*All dimensions are nominal

| Device | Package Type | Package Drawing | Pins | SPQ | Length (mm) | Width (mm) | Height (mm) |
|-------------|--------------|-----------------|------|------|-------------|------------|-------------|
| DAC8803IDBR | SSOP | DB | 28 | 2000 | 350.0 | 350.0 | 43.0 |

DB0028A



PACKAGE OUTLINE

SSOP - 2 mm max height

SMALL OUTLINE PACKAGE

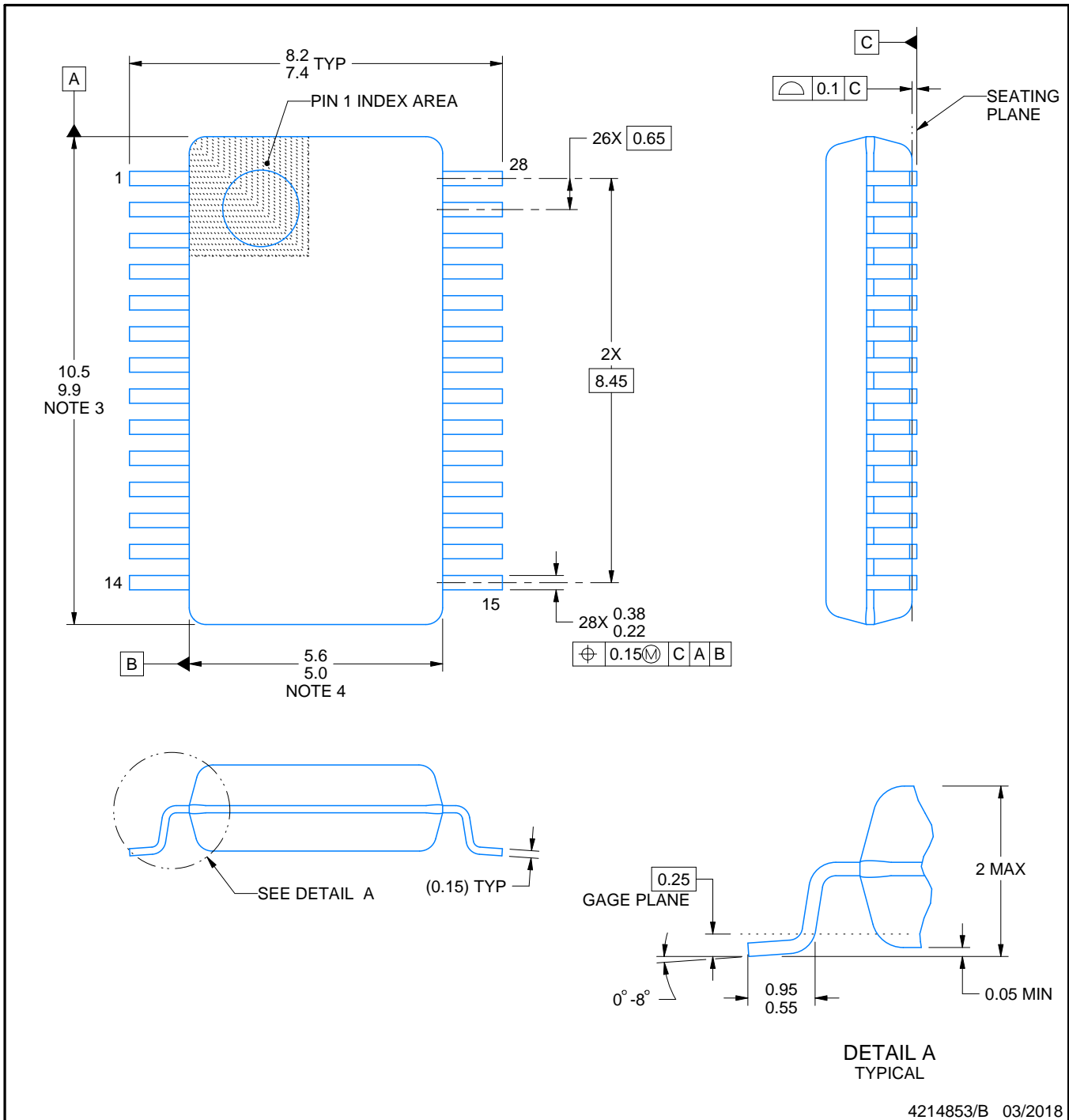

4214853/B 03/2018

NOTES:

1. All linear dimensions are in millimeters. Any dimensions in parenthesis are for reference only. Dimensioning and tolerancing per ASME Y14.5M.
2. This drawing is subject to change without notice.
3. This dimension does not include mold flash, protrusions, or gate burrs. Mold flash, protrusions, or gate burrs shall not exceed 0.15 mm per side.
4. This dimension does not include interlead flash. Interlead flash shall not exceed 0.25 mm per side.
5. Reference JEDEC registration MO-150.

EXAMPLE BOARD LAYOUT

DB0028A

SSOP - 2 mm max height

SMALL OUTLINE PACKAGE

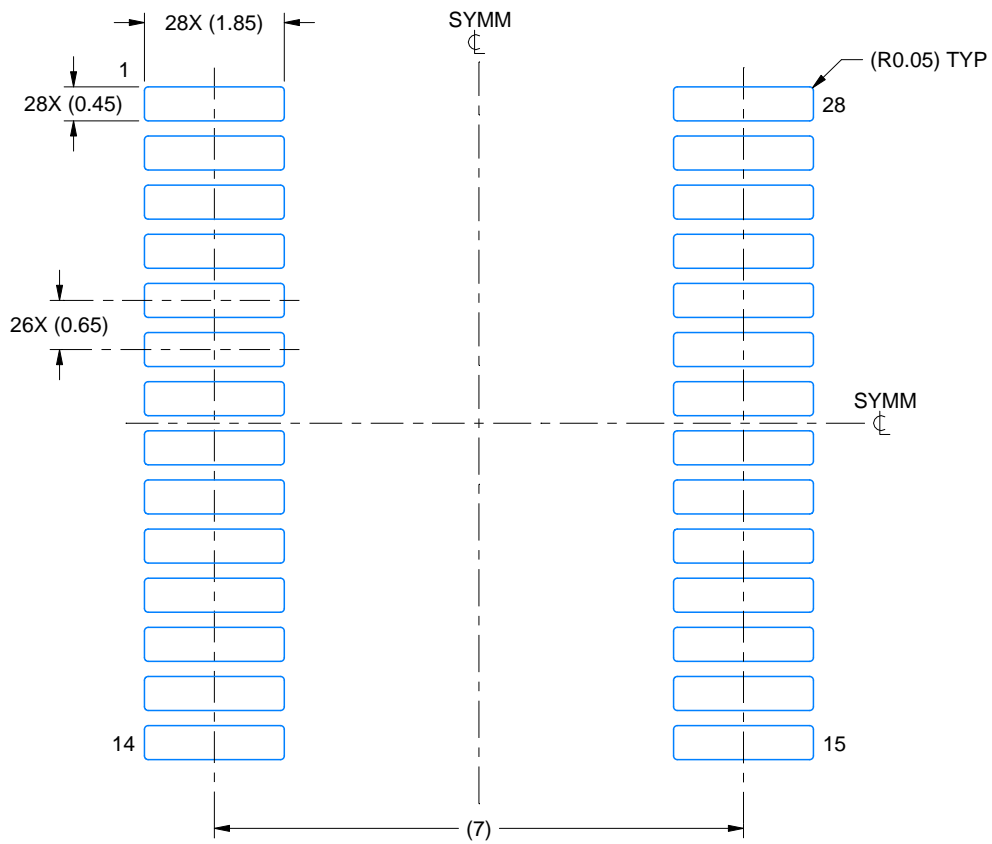

LAND PATTERN EXAMPLE
EXPOSED METAL SHOWN
SCALE: 10X

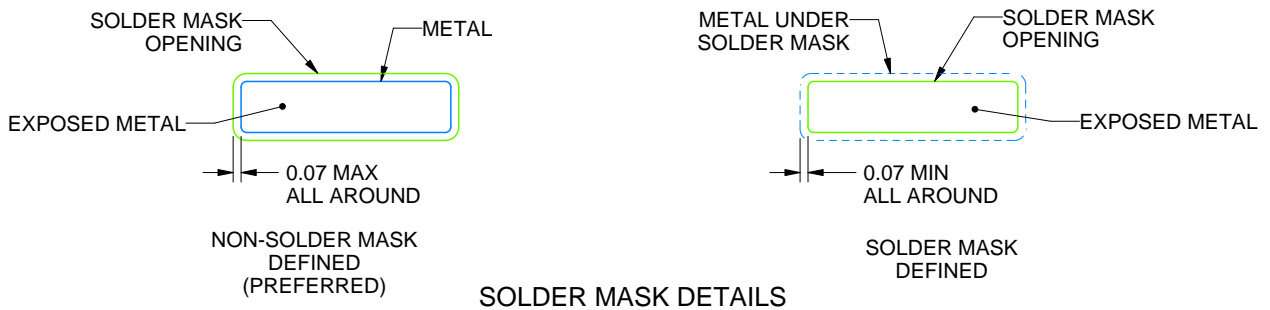

4214853/B 03/2018

NOTES: (continued)

- 6. Publication IPC-7351 may have alternate designs.
- 7. Solder mask tolerances between and around signal pads can vary based on board fabrication site.

EXAMPLE STENCIL DESIGN

DB0028A

SSOP - 2 mm max height

SMALL OUTLINE PACKAGE

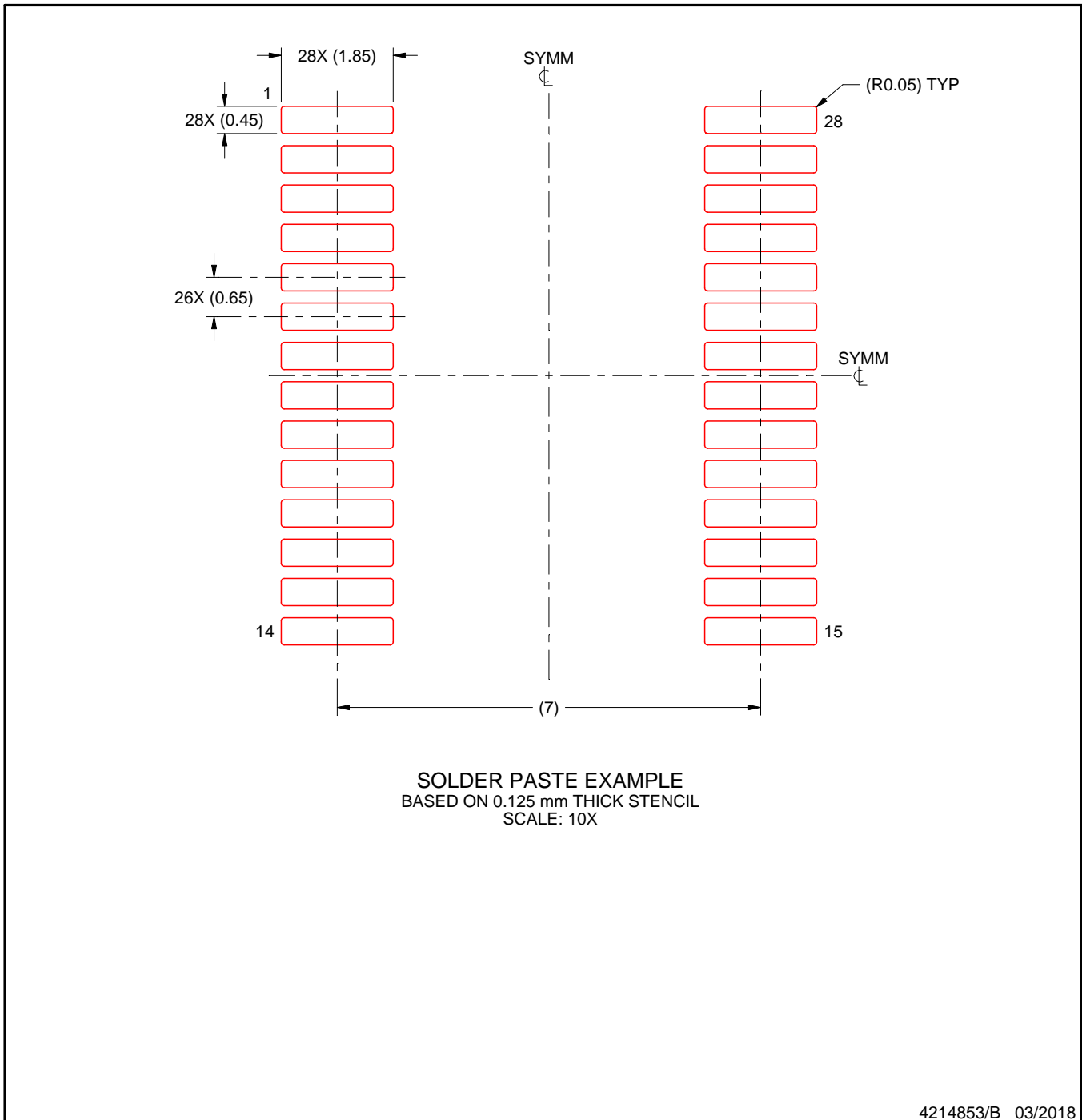

NOTES: (continued)

8. Laser cutting apertures with trapezoidal walls and rounded corners may offer better paste release. IPC-7525 may have alternate design recommendations.
9. Board assembly site may have different recommendations for stencil design.

IMPORTANT NOTICE AND DISCLAIMER

TI PROVIDES TECHNICAL AND RELIABILITY DATA (INCLUDING DATA SHEETS), DESIGN RESOURCES (INCLUDING REFERENCE DESIGNS), APPLICATION OR OTHER DESIGN ADVICE, WEB TOOLS, SAFETY INFORMATION, AND OTHER RESOURCES "AS IS" AND WITH ALL FAULTS, AND DISCLAIMS ALL WARRANTIES, EXPRESS AND IMPLIED, INCLUDING WITHOUT LIMITATION ANY IMPLIED WARRANTIES OF MERCHANTABILITY, FITNESS FOR A PARTICULAR PURPOSE OR NON-INFRINGEMENT OF THIRD PARTY INTELLECTUAL PROPERTY RIGHTS.

These resources are intended for skilled developers designing with TI products. You are solely responsible for (1) selecting the appropriate TI products for your application, (2) designing, validating and testing your application, and (3) ensuring your application meets applicable standards, and any other safety, security, regulatory or other requirements.

These resources are subject to change without notice. TI grants you permission to use these resources only for development of an application that uses the TI products described in the resource. Other reproduction and display of these resources is prohibited. No license is granted to any other TI intellectual property right or to any third party intellectual property right. TI disclaims responsibility for, and you will fully indemnify TI and its representatives against, any claims, damages, costs, losses, and liabilities arising out of your use of these resources.

TI's products are provided subject to [TI's Terms of Sale](#) or other applicable terms available either on [ti.com](https://www.ti.com) or provided in conjunction with such TI products. TI's provision of these resources does not expand or otherwise alter TI's applicable warranties or warranty disclaimers for TI products.

TI objects to and rejects any additional or different terms you may have proposed.

Mailing Address: Texas Instruments, Post Office Box 655303, Dallas, Texas 75265

Copyright © 2025, Texas Instruments Incorporated